

Company: Silver Spring Networks

Test of: NIC 510
To: FCC CFR 47 Part 15 Subpart C 15.247 (DTS) &
IC RSS-247 902-928 MHz operation

Report No.: SSNT108-U8 Rev A

CONDUCTED, RADIATED TEST REPORT



CONDUCTED, RADIATED TEST REPORT



Test of: Silver Spring Networks NIC 511-0303
to

To: FCC CFR 47 Part 15 Subpart C 15.247 (DTS) &
IC RSS-247 902-928 MHz operation

Test Report Serial No.: SSNT108-U8 Rev A
This report supersedes: NONE

Applicant: Silver Spring Networks
555 Broadway Street
Redwood City, California 94063
USA

Product Function: Plug-in radio device, will
communicate over 900 MHz and
2.4 GHz mesh network

Issue Date: 11th December 2015

This Test Report is Issued Under the Authority of:

MiCOM Labs, Inc.
575 Boulder Court
Pleasanton California 94566
USA
Phone: +1 (925) 462-0304
Fax: +1 (925) 462-0306
www.micomlabs.com



MiCOM Labs is an ISO 17025 Accredited Testing Laboratory



Table of Contents

1. ACCREDITATION, LISTINGS & RECOGNITION.....	5
1.1. TESTING ACCREDITATION.....	5
1.2. RECOGNITION	6
1.3. PRODUCT CERTIFICATION	7
2. DOCUMENT HISTORY	8
3. TEST RESULT CERTIFICATE.....	9
4. REFERENCES AND MEASUREMENT UNCERTAINTY	10
4.1. Normative References	10
4.2. Test and Uncertainty Procedure	11
5. PRODUCT DETAILS AND TEST CONFIGURATIONS.....	12
5.1. Technical Details	12
5.2. Scope Of Test Program	14
5.3. Equipment Model(s) and Serial Number(s)	16
5.4. Antenna Details	16
5.5. Cabling and I/O Ports	16
5.6. Test Configurations.....	17
5.7. Equipment Modifications	17
5.8. Deviations from the Test Standard	17
6. TEST SUMMARY	18
7. TEST EQUIPMENT CONFIGURATION(S)	19
7.1. Conducted	19
7.2. Radiated Emissions.....	21
7.3. ac Wireline Emission.....	23
8. MEASUREMENT AND PRESENTATION OF TEST DATA	24
9. TEST RESULTS	25
9.1. 20 dB & 99% Bandwidth	25
9.1.1. Modulation (FHSS).....	26
9.2. 6 dB & 99% Bandwidth	34
9.2.1. Modulation (DTS).....	35
9.3. Number Of Channels	36
9.4. Channel Spacing	38
9.5. Dwell Time & Channel Occupancy	40
9.6. Conducted Output Power	42
9.6.1. Modulation (FHSS).....	44
9.6.2. Modulation (DTS).....	52
9.7. Emissions	53
9.7.1. Conducted Emissions	53
9.7.1.1. Conducted Spurious Emissions	53
9.7.2. Modulation (FHSS).....	54
9.7.3. Modulation (DTS).....	62
9.7.3.2. Conducted Band-Edge Emissions	63
9.7.3.2.1. Conducted Low Band-Edge Emissions.....	63
9.7.3.2.2. Conducted High Band-Edge Emissions.....	72
9.7.4. Radiated Emissions	81
9.7.5. Digital Emissions (0.03 - 1 GHz).....	101
9.8. AC Wireline Conducted Emissions (150 kHz – 30 MHz).....	103
9.9. Power Spectral Density	105

This test report may be reproduced in full only. The document may only be updated by MiCOM Labs personnel. All changes will be noted in the Document History section of the report.



Title: Silver Spring Networks NIC 511-0303
To: FCC CFR 47 Part 15 Subpart C 15.247 & IC RSS 247
Serial #: SSNT108-U8 Rev A
Issue Date: 11th December 2015
Page: 4 of 204

9.9.1. Modulation (DTS).....	106
A. APPENDIX - GRAPHICAL IMAGES	107
A.1. 20 dB & 99% Bandwidth	108
A.2. 6 dB & 99% Bandwidth	132
A.3. Number of Channels	135
A.4. Channel Spacing	144
A.5. Dwell Time & Channel Occupancy.....	147
A.6. Emissions	153
A.6.1. Conducted Emissions	153
A.6.1.1. Conducted Spurious Emissions	153
A.6.1.2. Conducted Band-Edge Emissions	180
A.6.1.2.1. Conducted Low Band-Edge Emissions	180
A.6.1.2.2. Conducted High Band-Edge Emissions	189
A.7. Power Spectral Density	198

This test report may be reproduced in full only. The document may only be updated by MiCOM Labs personnel. All changes will be noted in the Document History section of the report.

1. ACCREDITATION, LISTINGS & RECOGNITION

1.1. TESTING ACCREDITATION

MiCOM Labs, Inc. is an accredited Electrical testing laboratory per the international standard ISO/IEC 17025:2005. The company is accredited by the American Association for Laboratory Accreditation (A2LA) www.a2la.org test laboratory number 2381.01. MiCOM Labs test schedule is available at the following URL; <http://www.a2la.org/scopepdf/2381-01.pdf>



Accredited Laboratory

A2LA has accredited

MICOM LABS

Pleasanton, CA

for technical competence in the field of

Electrical Testing

This laboratory is accredited in accordance with the recognized International Standard ISO/IEC 17025:2005 *General requirements for the competence of testing and calibration laboratories*. This accreditation demonstrates technical competence for a defined scope and the operation of a laboratory quality management system (refer to joint ISO-ILAC-IAF Communiqué dated 8 January 2009).



Presented this 28th day of February 2014.



President & CEO
For the Accreditation Council
Certificate Number 2381.01
Valid to December 31, 2015
Revised November 18, 2015

For the tests or types of tests to which this accreditation applies, please refer to the laboratory's Electrical Scope of Accreditation.



1.2. RECOGNITION

MiCOM Labs, Inc has widely recognized wireless testing capabilities. Our international recognition includes Conformity Assessment Body designation by APEC MRA countries. MiCOM Labs test reports are accepted globally.

Country	Recognition Body	Status	Phase	Identification No.
USA	Federal Communications Commission (FCC)	TCB	-	US0159 Listing #: 102167
Canada	Industry Canada (IC)	FCB	APEC MRA 2	US0159 Listing #: 4143A-2 4143A-3
Japan	MIC (Ministry of Internal Affairs and Communication)	CAB	APEC MRA 2	RCB 210
	VCCI	--	--	A-0012
Europe	European Commission	NB	EU MRA	NB 2280
Australia	Australian Communications and Media Authority (ACMA)	CAB	APEC MRA 1	US0159
Hong Kong	Office of the Telecommunication Authority (OFTA)	CAB	APEC MRA 1	
Korea	Ministry of Information and Communication Radio Research Laboratory (RRL)	CAB	APEC MRA 1	
Singapore	Infocomm Development Authority (IDA)	CAB	APEC MRA 1	
Taiwan	National Communications Commission (NCC) Bureau of Standards, Metrology and Inspection (BSMI)	CAB	APEC MRA 1	
Vietnam	Ministry of Communication (MIC)	CAB	APEC MRA 1	

EU MRA – European Union Mutual Recognition Agreement.

NB – Notified Body

APEC MRA – Asia Pacific Economic Community Mutual Recognition Agreement. Recognition agreement under which test lab is accredited to regulatory standards of the APEC member countries.

Phase I - recognition for product testing

Phase II – recognition for both product testing and certification



Title: Silver Spring Networks NIC 511-0303
To: FCC CFR 47 Part 15 Subpart C 15.247 & IC RSS 247
Serial #: SSNT108-U8 Rev A
Issue Date: 11th December 2015
Page: 7 of 204

1.3. PRODUCT CERTIFICATION

MiCOM Labs, Inc. is an accredited Product Certification Body per the international standard ISO/IEC 17065:2012. The company is accredited by the American Association for Laboratory Accreditation (A2LA) www.a2la.org test laboratory number 2381.02. MiCOM Labs test schedule is available at the following URL; <http://www.a2la.org/scopepdf/2381-02.pdf>



Accredited Product Certification Body

A2LA has accredited

MICOM LABS

Pleasanton, CA

This product certification body is accredited in accordance with the recognized International Standard ISO/IEC 17065:2012 *Requirements for bodies certifying products, processes and services*. This accreditation demonstrates technical competence for a defined scope and the operation of a management system.



Presented this 28th day of February 2014.

President & CEO
For the Accreditation Council
Certificate Number 2381.02
Valid to December 31, 2015
Revised November 18, 2015

For the product certification schemes to which this accreditation applies, please refer to the organization's Product Certification Scope of Accreditation.

United States of America – Telecommunication Certification Body (TCB)
Industry Canada – Certification Body, CAB Identifier – US0159
Europe – Notified Body (NB), NB Identifier - 2280
Japan – Recognized Certification Body (RCB), RCB Identifier - 210

This test report may be reproduced in full only. The document may only be updated by MiCOM Labs personnel. All changes will be noted in the Document History section of the report.



Title: Silver Spring Networks NIC 511-0303
To: FCC CFR 47 Part 15 Subpart C 15.247 & IC RSS 247
Serial #: SSNT108-U8 Rev A
Issue Date: 11th December 2015
Page: 8 of 204

2. DOCUMENT HISTORY

Document History		
Revision	Date	Comments
Draft		
Rev A	11 th December 2015	Initial release.
.		
.		
.		
.		
.		

In the above table the latest report revision will replace all earlier versions.

This test report may be reproduced in full only. The document may only be updated by MiCOM Labs personnel. All changes will be noted in the Document History section of the report.



Title: Silver Spring Networks NIC 511-0303
To: FCC CFR 47 Part 15 Subpart C 15.247 & IC RSS 247
Serial #: SSNT108-U8 Rev A
Issue Date: 11th December 2015
Page: 9 of 204

3. TEST RESULT CERTIFICATE

Manufacturer: Silver Spring Networks 555 Broadway Street Redwood City California 94063 USA	Tested By: MiCOM Labs, Inc. 575 Boulder Court Pleasanton California 94566 USA
Model: NIC 511-0303 902-928 MHz operation.	Telephone: +1 925 462 0304
Type Of Equipment: Plug-in radio device, will communicate over 900 MHz and 2.4 GHz mesh network	Fax: +1 925 462 0306
S/N's: 00:13:50:07:00:00:07:6D	
Test Date(s): 10 - 19 November 2015	Website: www.micomlabs.com

STANDARD(S)	TEST RESULTS
FCC CFR 47 Part 15 Subpart C 15.247 (DTS)	EQUIPMENT COMPLIES

MiCOM Labs, Inc. tested the equipment mentioned in accordance with the requirements set forth in the above standards. Test results indicate that the equipment tested is capable of demonstrating compliance with the requirements as documented within this report.

Notes:

1. This document reports conditions under which testing was conducted and the results of testing performed.
2. Details of test methods used have been recorded and kept on file by the laboratory.
3. Test results apply only to the item(s) tested.

Approved & Released for MiCOM Labs, Inc. by:



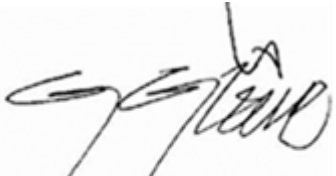

 Graeme Grieve
 Quality Manager MiCOM Labs, Inc.

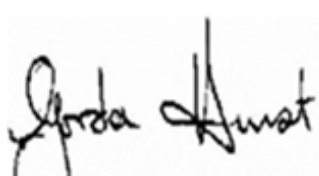

 Gordon Hurst
 President & CEO MiCOM Labs, Inc.

This test report may be reproduced in full only. The document may only be updated by MiCOM Labs personnel. All changes will be noted in the Document History section of the report.

4. REFERENCES AND MEASUREMENT UNCERTAINTY

4.1. Normative References

REF.	PUBLICATION	YEAR	TITLE
I	KDB 662911	Oct 31 2013	Guidance for measurement of output emission of devices that employ single transmitter with multiple outputs or systems with multiple transmitters operating simultaneously in the same frequency band
II	KDB 558074 D01 v03r03	9th June 2015	Guidance for performing compliance measurements on Digital Transmission Systems (DTS) operating under section 15.247.
III	A2LA	June 2015	R105 - Requirement's When Making Reference to A2LA Accreditation Status
IV	ANSI C63.10	2013	American National Standard for Testing Unlicensed Wireless Devices
V	ANSI C63.4	2009	American National Standards for Methods of Measurement of Radio-Noise Emissions from Low-Voltage Electrical and Electronic Equipment in the Range of 9 kHz to 40 GHz
VI	CISPR 22	2008	Information technology equipment - Radio disturbance characteristics - Limits and methods of measurement
VII	ETSI TR 100 028	2001-12	Parts 1 and 2 Electromagnetic compatibility and Radio Spectrum Matters (ERM); Uncertainties in the measurement of mobile radio equipment characteristics
VIII	FCC 47 CFR Part 15.247	2014	Radio Frequency Devices; Subpart C – Intentional Radiators
IX	ICES-003	Issue 5 2012	Spectrum Management and Telecommunications; Interference-Causing Equipment Standard. Information Technology Equipment (ITE) – Limits and methods of measurement.
X	M 3003	Edition 3 Nov. 2012	Expression of Uncertainty and Confidence in Measurements
XI	RSS-247 Issue 1	May 2015	Digital Transmission Systems (DTSs), Frequency Hopping System (FHSs) and Licence-Exempt Local Area Network (LE-LEN) Devices
XII	RSS-Gen Issue 4	November 2014	General Requirements and Information for the Certification of Radiocommunication Equipment
XIII	KDB 644545 D03 v01	August 14th 2014	Guidance for IEEE 802.11ac New Rules
XIV	FCC 47 CFR Part 2.1033	2014	FCC requirements and rules regarding photographs and test setup diagrams.

This test report may be reproduced in full only. The document may only be updated by MiCOM Labs personnel. All changes will be noted in the Document History section of the report.



Title: Silver Spring Networks NIC 511-0303
To: FCC CFR 47 Part 15 Subpart C 15.247 & IC RSS 247
Serial #: SSNT108-U8 Rev A
Issue Date: 11th December 2015
Page: 11 of 204

4.2. Test and Uncertainty Procedure

Conducted and radiated emission measurements were conducted in accordance with American National Standards Institute ANSI C63.4, listed in the Normative References section of this report.

Measurement uncertainty figures are calculated in accordance with ETSI TR 100 028 Parts 1 and 2.

Measurement uncertainties stated are based on a standard uncertainty multiplied by a coverage factor $k = 2$, providing a level of confidence of approximately 95 % in accordance with UKAS document M 3003 listed in the Normative References section of this report.

This test report may be reproduced in full only. The document may only be updated by MiCOM Labs personnel. All changes will be noted in the Document History section of the report.



Title: Silver Spring Networks NIC 511-0303
To: FCC CFR 47 Part 15 Subpart C 15.247 & IC RSS 247
Serial #: SSNT108-U8 Rev A
Issue Date: 11th December 2015
Page: 12 of 204

5. PRODUCT DETAILS AND TEST CONFIGURATIONS

5.1. Technical Details

Details	Description
Purpose:	Test of the Silver Spring Networks NIC 511-0303 to FCC CFR 47 Part 15 Subpart C 15.247 (DTS) and Industry Canada RSS-247. Radio Frequency Devices; Subpart C – Intentional Radiators
Applicant:	Silver Spring Networks 555 Broadway Street Redwood City California 94063 USA
Manufacturer:	As Applicant
Laboratory performing the tests:	MiCOM Labs, Inc. 575 Boulder Court Pleasanton California 94566 USA
Test report reference number:	SSNT108-U8 Rev A
Date EUT received:	9 th November 2015
Standard(s) applied:	FCC CFR 47 Part 15 Subpart C 15.247 (DTS) & IC RSS-247
Dates of test (from - to):	10 - 19 November 2015
No of Units Tested:	1
Type of Equipment:	Network Interface Card (NIC)
Product Family Name:	NIC 510
Model(s):	NIC 511-0303 , NIC 511-0302, NIC 511-0301
Location for use:	Both
Declared Frequency Range(s):	902 - 928 MHz; 2400 - 2483.5 MHz;
Primary function of equipment:	Plug-in radio device, will communicate over 900 MHz and 2.4 GHz mesh network
Secondary function of equipment:	None Provided
Type of Modulation:	FHSS, DTS
EUT Modes of Operation:	900 - 928 MHz: FSK; GFSK ; 2FSK; OQPSK; OFDM
Declared Nominal Output Power (Ave):	900 - 928 MHz: FSK: 30 dBm; GFSK: 30 dBm; FSK: 30 dBm; FSK: 30 dBm; 2FSK: 30 dBm; OFDM: 30dBm; OQPSK: 30 dBm
Transmit/Receive Operation:	Transceiver - Half Duplex
Rated Input Voltage and Current:	DC only (Battery operated / external supply) 4Vdc
Operating Temperature Range:	Declared Range -40°C to 85°C
ITU Emission Designator:	FHSS: FSK 105KF1D FSK 164KF1D 2FSK 87KF1D GFSK 164KF1D GFSK 220KF1D GFSK 332KF1D OQPSK 117KF1D OFDM 300KF1D --

This test report may be reproduced in full only. The document may only be updated by MiCOM Labs personnel. All changes will be noted in the Document History section of the report.



Title: Silver Spring Networks NIC 511-0303
To: FCC CFR 47 Part 15 Subpart C 15.247 & IC RSS 247
Serial #: SSNT108-U8 Rev A
Issue Date: 11th December 2015
Page: 13 of 204

	DTS: 1M22G1D
Equipment Dimensions:	114.5mm x 101.6mm x 19mm
Weight:	140 grams
Hardware Rev:	173-0674-00: NIC 511-0303 173-0728-00: NIC 511-0301 173-0729-00: NIC 511-0302
Software Rev:	3.10

This test report may be reproduced in full only. The document may only be updated by MiCOM Labs personnel. All changes will be noted in the Document History section of the report.



Title: Silver Spring Networks NIC 511-0303
To: FCC CFR 47 Part 15 Subpart C 15.247 & IC RSS 247
Serial #: SSNT108-U8 Rev A
Issue Date: 11th December 2015
Page: 14 of 204

5.2. Scope Of Test Program

Silver Spring Networks NIC 511-0303

The scope of the test program was to test the Silver Spring Networks NIC 511-0303, Network Interface Card (NIC) configurations in the frequency range 902 - 928 MHz for compliance against the following specification:

FCC CFR 47 Part 15 Subpart C 15.247 (DTS) & Industry Canada RSS-247

Radio Frequency Devices; Subpart C – Intentional Radiators and Digital Transmission Systems (DTSs), Frequency Hopping Systems (FHSS) and Licence-Exempt Local Area Network (LE-LAN) Devices

The EUT has 20 modulation modes available for the US. 9 modes were tested. Modes not tested were the multi-rate modes which do not represent a change in RF performance, including OBW and power.

Test plan includes all modes in use.

Testing of; Number of channels; Channel Spacing; Dwell time and Channel Occupancy was limited to testing 3 modes that were declared by the manufacturer as representing all modes of operation for these parameters.

Modes tested; 300 kHz FSK 100 kbps; 400 kHz OFDM 600 kbps; 200 kHz OQPSK 6.25 kbps.

This test report may be reproduced in full only. The document may only be updated by MiCOM Labs personnel. All changes will be noted in the Document History section of the report.

Product Description

The following product description was provided by the manufacturer.

NIC 510

The Silver Spring Networks (SSN) Network Interface Card, or NIC 511, is based on SSN's 5th Generation radio platform. NIC 511 may be configured for energy meters and other devices to be used in SSN Smart Energy Networks (SEN). The NIC 511 family incorporates a 902-928 MHz frequency hopping mesh radio, a 902-928 MHz DSSS radio, a 2.4 GHz ISM band frequency hopping mesh radio, and a 2.4 GHz DSSS radio. The NIC 511 family supports basic meter types including single-phase meters and three-phase meters.

This report is intended to cover the NIC 510 family of products which includes the NIC 511-0303 and represents a worst case configuration of the product family.

NIC 510 products include the following model numbers/configurations:

- NIC 511-0303 – 900+2.4, INT/EXT ANT, HW1
- NIC 511-0302 – 900+2.4, EXT ANT, HW1
- NIC 511-0301 – 900+2.4, INT ANT, HW1

Silver Spring Networks NIC 511-0303

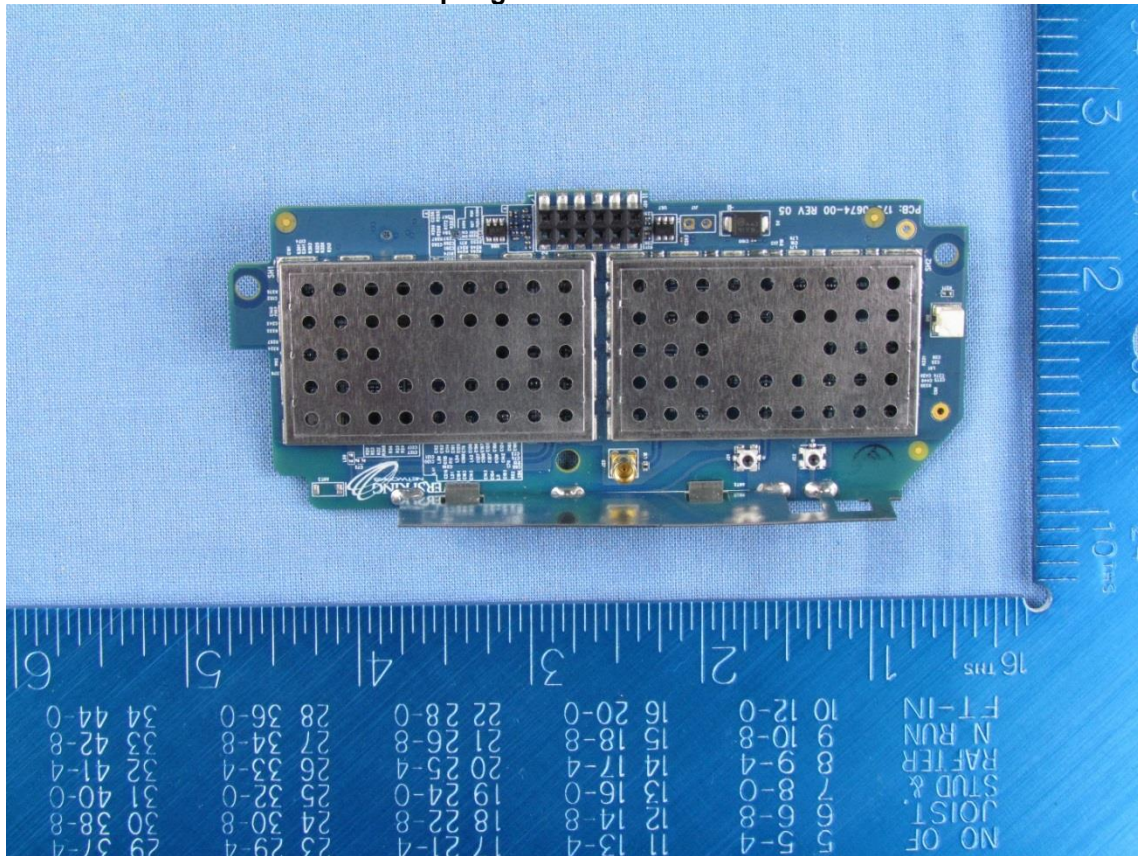

This test report may be reproduced in full only. The document may only be updated by MiCOM Labs personnel. All changes will be noted in the Document History section of the report.



Title: Silver Spring Networks NIC 511-0303
To: FCC CFR 47 Part 15 Subpart C 15.247 & IC RSS 247
Serial #: SSNT108-U8 Rev A
Issue Date: 11th December 2015
Page: 16 of 204

5.3. Equipment Model(s) and Serial Number(s)

Type	Description	Manufacturer	Model	Serial no.	Delivery Date
EUT	Network Interface Card (NIC)	Silver Spring Networks	NIC 511-0303	00:13:50:07:00:00:07:6D	9 th November 2015

5.4. Antenna Details

Type	Manufacturer	Model	Family	Gain (dBi)	Frequency (MHz)	BF Gain	Dir BW	X-Pol
external	WP	WPANT30017-CA	OMNI	3.0	900-928	-	360	-
				4.5	2400-2483.5			
external	WP	WPANT40010-C	Wrap Around	1.0	900-928	-	360	-
				3.5	2400-2483.5			
integral	Tai Sheng Chen	155-0010	F-Type	2.0	900-928	-	360	-
				5	2400-2483.5			
BF Gain - Beamforming Gain Dir BW - Directional BeamWidth X-Pol - Cross Polarization								

5.5. Cabling and I/O Ports

*None

This test report may be reproduced in full only. The document may only be updated by MiCOM Labs personnel. All changes will be noted in the Document History section of the report.



5.6. Test Configurations

Results for the following configurations are provided in this report:

Channel Spacing (kHz)	Operational Mode(s) (FHSS)	Data Rate with Highest Power (Kbps)	Channel Frequency (MHz)		
			Low	Mid	High
900.00 – 928.00 MHz					
300	FSK	100.00	902.30	915.20	926.90
400	FSK	150.00	902.40	915.20	927.60
300	GFSK	150.00	902.30	915.20	926.90
300	GFSK	200.00	902.30	915.20	926.90
400	GFSK	300.00	902.40	915.20	927.60
200	2FSK	50.00	902.20	915.00	927.80
400	OFDM	600.00	902.40	915.20	927.60
200	OQPSK	6.25	902.20	915.00	927.80

Channel Spacing (kHz)	Operational Mode(s)	Data Rate with Highest Power (Kbps)	Channel Frequency (MHz)		
			Low	Mid	High
900.00 – 928.00 MHz					
1200	OFDM	2400.00	903.20	914.00	926.00

5.7. Equipment Modifications

The following modifications were required to bring the equipment into compliance:

1. NONE

5.8. Deviations from the Test Standard

The following deviations from the test standard were required in order to complete the test program:

1. NONE



Title: Silver Spring Networks NIC 511-0303
To: FCC CFR 47 Part 15 Subpart C 15.247 & IC RSS 247
Serial #: SSNT108-U8 Rev A
Issue Date: 11th December 2015
Page: 18 of 204

6. TEST SUMMARY

List of Measurements

Test Header	Result	Data Link
Conducted Test Results		
15.247(a)(2) 20 dB & 99% Bandwidth	Complies	View Data
15.247(a)(2) 6 dB & 99% Bandwidth	Complies	View Data
15.247(a)(2) Number of Channels; Channel Spacing; Dwell Time & Channel Occupancy	Complies Note 1	View Data
15.247(b), 15.31(e) Conducted Output Power	Complies	View Data
15.247(d) Emissions	-	-
(1) Conducted Emissions	-	-
(i) Conducted Spurious Emissions	Complies	View Data
(ii) Conducted Band-Edge Emissions	Complies	View Data
15.247(e) Power Spectral Density	Complies	View Data
Radiated Emissions		
(i) 15.205 Spurious Emissions	Complies	View Data
ac Wireline Emissions		
(3) 15.209 Digital Emissions (0.03 - 1 GHz)	Complies	View Data

Note

Testing of; Number of channels; Channel Spacing; Dwell time and Channel Occupancy was limited to testing 3 modes that were declared by the manufacturer as representing all modes of operation for these parameters.

Modes tested; 300 kHz FSK 100 kbps; 400 kHz OFDM 600 kbps; 200 kHz OQPSK 6.25 kbps.

This test report may be reproduced in full only. The document may only be updated by MiCOM Labs personnel. All changes will be noted in the Document History section of the report.

7. TEST EQUIPMENT CONFIGURATION(S)

7.1. Conducted

Conducted RF Emission Test Set-up(s)

The following tests were performed using the conducted test set-up shown in the diagram below.

1. 20 dB & 99% Bandwidth
2. 6 dB & 99% Bandwidth
3. Number of Channels
4. Channel Spacing
5. Dwell time & Channel Occupancy
6. Conducted Output Power
7. Conducted Spurious Emissions
8. Conducted Spurious Band-Edge Emissions
9. Power Spectral Density

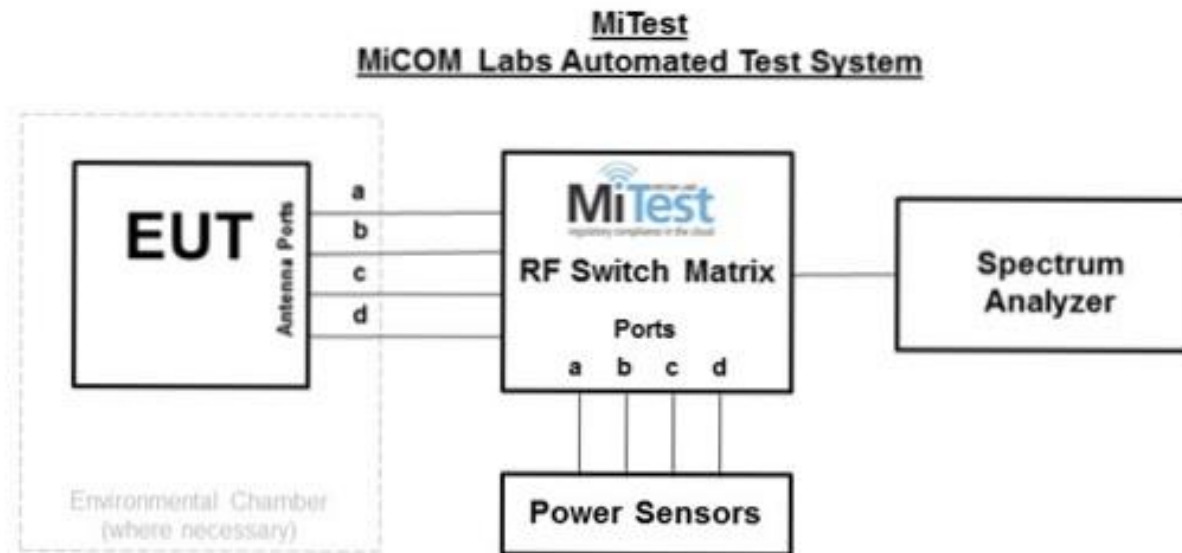

Conducted Test Measurement Setup

A full system calibration was performed on the test station and any resulting system losses (or gains) were taken into account in the production of all final measurement data.



Title: Silver Spring Networks NIC 511-0303
To: FCC CFR 47 Part 15 Subpart C 15.247 & IC RSS 247
Serial #: SSNT108-U8 Rev A
Issue Date: 11th December 2015
Page: 20 of 204

Asset#	Description	Manufacturer	Model#	Serial#	Calibration Due Date
127	Power Supply	HP	6674A	US36370530	Cal when used
158	Barometer/Thermometer	Control Company	4196	E2846	01 Dec 2016
193	Receiver 20 Hz to 7 GHz	Rhode & Schwarz	ESI 7	838496/007	14 Jan 2016
248	Resistance Thermometer	Thermotronics	GR2105-02	9340 #1	21 Oct 2016
287	Rohde & Schwarz 40 GHz Receiver	Rhode & Schwarz	ESIB40	100201	27 Aug 2016
376	USB 10MHz - 18GHz Average Power Sensor	Agilent	U2000A	MY51440005	23 Oct 2016
378	Rohde & Schwarz 40 GHz Receiver with Generator	Rhode & Schwarz	ESIB40	100107/040	04 Aug 2016
381	4x4 RF Switch Box	MiCOM Labs	MiTest RF Switch Box	MIC002	20 Dec 2015
419	Laptop with Labview Software	Lenova	W520	TS02	Not Required
420	USB to GPIB Interface	National Instruments	GPIB-USB HS	1346738	Not Required
435	USB Wideband Power Sensor	Boonton	55006	8730	31 Jul 2016
440	USB Wideband Power Sensor	Boonton	55006	9178	25 Sep 2016
441	USB Wideband Power Sensor	Boonton	55006	9179	25 Sep 2016
442	USB Wideband Power Sensor	Boonton	55006	9181	25 Sep 2016
445	PoE Injector	D-Link	DPE-101GL	QTAH1E2000625	Not Required
460	Dell Computer	Dell	Optiplex330	BC944G1	Not Required
74	Environmental Chamber 3	Tenney	TTC	12808-1	30 Sep 2016
RF#2 GPIB#1	GPIB cable to Power Supply	HP	GPIB	None	Not Required
RF#2 SMA#1	EUT to Mitest box port 1	Flexco	SMA Cable port1	None	20 Dec 2015
RF#2 SMA#2	EUT to Mitest box port 2	Flexco	SMA Cable port2	None	20 Dec 2015
RF#2 SMA#3	EUT to Mitest box port 3	Flexco	SMA Cable port3	None	20 Dec 2015
RF#2 SMA#4	EUT to Mitest box port 4	Flexco	SMA Cable port4	None	20 Dec 2015
RF#2 SMA#SA	Mitest box to SA	Flexco	SMA Cable SA	None	20 Dec 2015
RF#2 USB#1	USB Cable to Mitest Box	Dynex	USB Cable	None	Not Required

This test report may be reproduced in full only. The document may only be updated by MiCOM Labs personnel. All changes will be noted in the Document History section of the report.

7.2. Radiated Emissions

The following tests were performed using the conducted test set-up shown in the diagram below.

1. Section 9.4.1 Spurious Emissions
2. Section 9.4.2 Restricted Band-Edge Emissions
3. Section 9.5 Radiated Digital Emissions

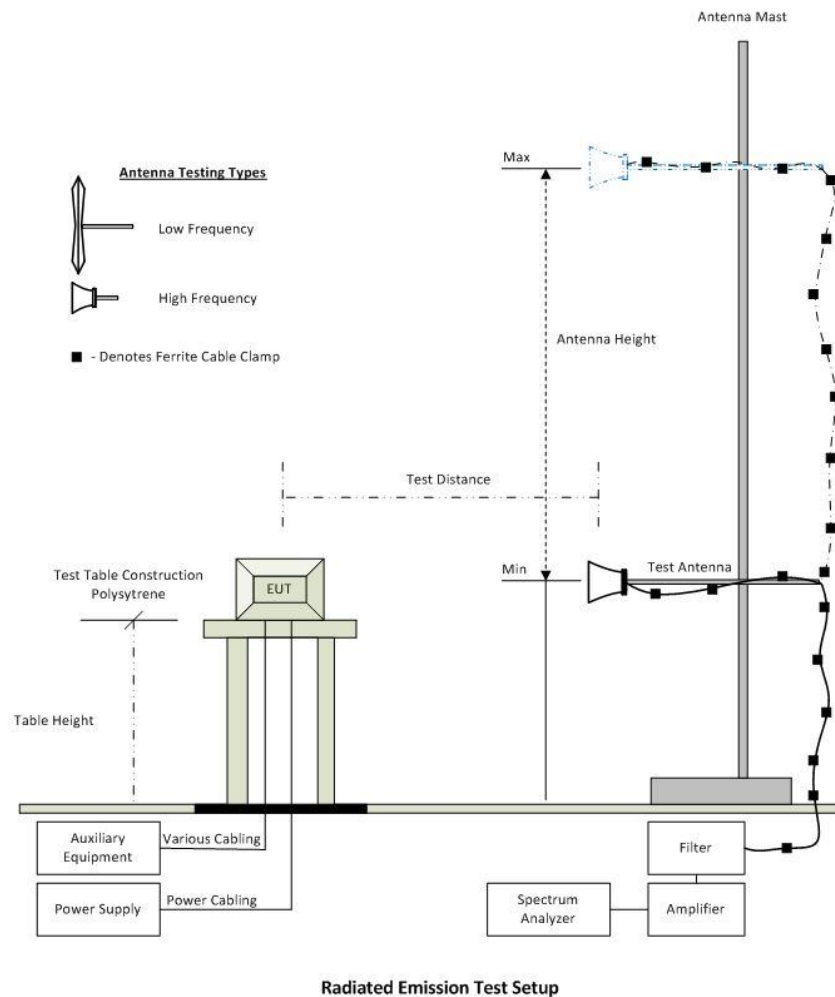

A full system calibration was performed on the test station and any resulting system losses (or gains) were taken into account in the production of all final measurement data.

This test report may be reproduced in full only. The document may only be updated by MiCOM Labs personnel. All changes will be noted in the Document History section of the report.



Title: Silver Spring Networks NIC 511-0303
To: FCC CFR 47 Part 15 Subpart C 15.247 & IC RSS 247
Serial #: SSNT108-U8 Rev A
Issue Date: 11th December 2015
Page: 22 of 204

Asset#	Description	Manufacturer	Model#	Serial#	Calibration Due Date
158	Barometer/Thermometer	Control Company	4196	E2846	01 Dec 2016
170	Video System Controller for Semi Anechoic Chamber	Panasonic	WV-CY101	04R08507	Not Required
287	Rohde & Schwarz 40 GHz Receiver	Rhode & Schwarz	ESIB40	100201	27 Aug 2016
338	Sunol 30 to 3000 MHz Antenna	Sunol	JB3	A052907	15 Aug 2016
341	900MHz Notch Filter	EWT	EWT-14-0199	H1	18 Aug 2016
342	2.4 GHz Notch Filter	EWT	EWT-14-0203	H1	18 Aug 2016
396	2.4 GHz Notch Filter	Microtronics	BRM50701	001	18 Aug 2016
397	Amp 10 - 2500MHz	MiCOM Labs	Amp 10 - 2500 MHz	NA	24 Feb 2016
399	ETS 1-18 GHz Horn Antenna	ETS	3117	00154575	10 Oct 2016
406	Amplifier for Radiated Emissions	MiCOM Labs	40dB 1 to 18GHz Amp	0406	28 May 2016
410	Desktop Computer	Dell	Inspiron 620	WS38	Not Required
411	Mast/Turntable Controller	Sunol Sciences	SC98V	060199-1D	Not Required
412	USB to GPIB Interface	National Instruments	GPIB-USB HS	11B8DC2	Not Required
413	Mast Controller	Sunol Science	TWR95-4	030801-3	Not Required
414	DC Power Supply 0-60V	HP	6274	1029A01285	Cal when used
415	Turntable Controller	Sunol Sciences	Turntable Controller	None	Not Required
447	Rad Emissions Test Software	MiCOM	Rad Emissions Test Software Version 1.0.73	447	Not Required
462	Schwarzbeck cable from Antenna to Amplifier.	Schwarzbeck	AK 9513	462	25 Feb 2016
463	Schwarzbeck cable from Amplifier to Bulkhead.	Schwarzbeck	AK 9513	463	25 Feb 2016
464	Schwarzbeck cable from Bulkhead to Receiver	Schwarzbeck	AK 9513	464	25 Feb 2016
465	Low Pass Filter DC-1000 MHz	Mini-Circuits	NLP-1200+	VUU01901402	18 Aug 2016
480	Cable - Bulkhead to Amp	SRC Haverhill	157-157-3050360	480	11 Aug 2016
481	Cable - Bulkhead to Receiver	SRC Haverhill	151-151-3050787	481	11 Aug 2016
482	Cable - Amp to Antenna	SRC Haverhill	157-157-3051574	482	11 Aug 2016

This test report may be reproduced in full only. The document may only be updated by MiCOM Labs personnel. All changes will be noted in the Document History section of the report.



7.3. ac Wireline Emission

The following tests were performed using the conducted test set-up shown in the diagram below.

- Section 9.6 ac Wireline Conducted Emissions

Test Measurement Set up

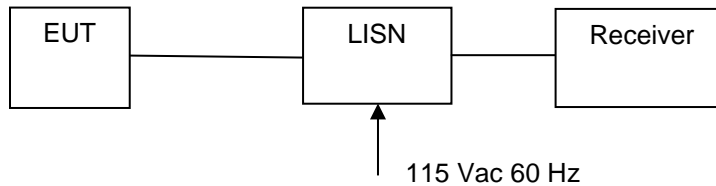

Measurement set up for AC Wireline Conducted Emissions Test

Traceability of Test Equipment Utilized for ac Wireline Emission Testing

Asset#	Description	Manufacturer	Model#	Serial#	Calibration Due Date
158	Barometer/Thermometer	Control Company	4196	E2846	04 Dec 2015
184	Pulse Limiter	Rhode & Schwarz	ESH3Z2	357.8810.52	07 Jan 2016
190	LISN (two-line V-network)	Rhode & Schwarz	ESH3Z5	836679/006	29 Oct 2016
193	Receiver 20 Hz to 7 GHz	Rhode & Schwarz	ESI 7	838496/007	14 Jan 2016
287	Rohde & Schwarz 40 GHz Receiver	Rhode & Schwarz	ESIB40	100201	27 Aug 2016
307	BNC-CABLE	Megaphase	1689 1GVT4	15F50B002	07 Jan 2016
316	Dell desktop computer workstation with Vasona	Dell	Desktop	WS04	Not Required
372	AC Variable PS	California Instruments	1251P	L06951	Cal when used
378	Rohde & Schwarz 40 GHz Receiver with Generator	Rhode & Schwarz	ESIB40	100107/040	04 Aug 2016
388	LISN (3 Phase) 9kHz - 30MHz	Rohde & Schwarz	ESH2-Z5	892107/022	30 Oct 2016
ADAPT SMA#1	SMA Cable	Megaphase	SMA Cable #1	None	Cal when used

This test report may be reproduced in full only. The document may only be updated by MiCOM Labs personnel. All changes will be noted in the Document History section of the report.

8. MEASUREMENT AND PRESENTATION OF TEST DATA

The measurement and graphical data presented in this test report was generated automatically using state-of-the-art technology creating an easy to read report structure. Numerical measurement data is separated from supporting graphical data (plots) through hyperlinks. Numerical measurement data can be reviewed without scrolling through numerous graphical pages to arrive at the next data matrix.

Plots have been relegated into the Appendix 'Graphical Data'.

Test and report automation was performed by [MiTest](#). [MiTest](#) is an automated test system developed by MiCOM Labs. [MiTest](#) is the first cloud based modular test system enabling end-to-end automation of regulatory compliance testing for conducted RF testing.



The MiCOM Labs "[MiTest](#)" Automated Test System" (Patent Pending)

This test report may be reproduced in full only. The document may only be updated by MiCOM Labs personnel. All changes will be noted in the Document History section of the report.



Title: Silver Spring Networks NIC 511-0303
To: FCC CFR 47 Part 15 Subpart C 15.247 & IC RSS 247
Serial #: SSNT108-U8 Rev A
Issue Date: 11th December 2015
Page: 25 of 204

9. TEST RESULTS

9.1. 20 dB & 99% Bandwidth

Conducted Test Conditions for 20 dB and 99% Bandwidth			
Standard:	FCC CFR 47:15.247	Ambient Temp. (°C):	24.0 - 27.5
Test Heading:	20 dB and 99 % Bandwidth	Rel. Humidity (%):	32 - 45
Standard Section(s):	15.247 (a)(2)	Pressure (mBars):	999 - 1001
Reference Document(s):	See Normative References		

Test Procedure for 20 dB and 99% Bandwidth Measurement
The bandwidth at 20 dB and 99 % was measured with a spectrum analyzer connected to the antenna terminal, while EUT is operating in transmission mode at the appropriate center frequency.

Testing was performed under ambient conditions at nominal voltage. Where the device operated with multiple antenna ports i.e. MIMO device, each port was measured and reported.

Test configuration and setup used for the measurement was per the Conducted Test Set-up specified in this document.

Limits for 20 dB and 99% Bandwidth

(a) Operation under the provisions of this Section is limited to frequency hopping and digitally modulated intentional radiators that comply with the following provisions:

(i) For frequency hopping systems operating in the 902-928 MHz band: if the 20 dB bandwidth of the hopping channel is less than 250 kHz, the system shall use at least 50 hopping frequencies and the average time of occupancy on any frequency shall not be greater than 0.4 seconds within a 20 second period; if the 20 dB bandwidth of the hopping channel is 250 kHz or greater, the system shall use at least 25 hopping frequencies and the average time of occupancy on any frequency shall not be greater than 0.4 seconds within a 10 second period. The maximum allowed 20 dB bandwidth of the hopping channel is 500 kHz.

This test report may be reproduced in full only. The document may only be updated by MiCOM Labs personnel. All changes will be noted in the Document History section of the report.



Title: Silver Spring Networks NIC 511-0303
To: FCC CFR 47 Part 15 Subpart C 15.247 & IC RSS 247
Serial #: SSNT108-U8 Rev A
Issue Date: 11th December 2015
Page: 26 of 204

9.1.1. Modulation (FHSS)

Equipment Configuration for 20 dB & 99% Bandwidth

Variant:	300 FSK	Duty Cycle (%):	99.00
Data Rate:	100.00 Kbps	Antenna Gain (dBi):	4.5
Modulation:	FHSS	Beam Forming Gain (Y)(dB):	Not Applicable
TPC:	Not Applicable	Tested By:	CC
Engineering Test Notes:			

Test Measurement Results

Test Frequency	Measured 20 dB Bandwidth (MHz)				20 dB Bandwidth (MHz)		Limit	Lowest Margin
	Port(s)				Highest	Lowest		
MHz	a	b	c	d			KHz	KHz
902.3	0.122	--	--	--	0.122	0.122	≤500.0	-378.0
915.2	0.121	--	--	--	0.121	0.121	≤500.0	-379.0
926.9	0.113	--	--	--	0.113	0.113	≤500.0	-387.0

Test Frequency	Measured 99% Bandwidth (MHz)				Maximum 99% Bandwidth (MHz)		
	Port(s)						
MHz	a	b	c	d			
902.3	0.104	--	--	--	0.104		
915.2	0.106	--	--	--	0.106		
926.9	0.105	--	--	--	0.105		

Traceability to Industry Recognized Test Methodologies

Work Instruction:	WI-03 MEASURING RF SPECTRUM MASK
Measurement Uncertainty:	±2.81 dB

Note: click the links in the above matrix to view the graphical image (plot).

This test report may be reproduced in full only. The document may only be updated by MiCOM Labs personnel. All changes will be noted in the Document History section of the report.



Title: Silver Spring Networks NIC 511-0303
To: FCC CFR 47 Part 15 Subpart C 15.247 & IC RSS 247
Serial #: SSNT108-U8 Rev A
Issue Date: 11th December 2015
Page: 27 of 204

Equipment Configuration for 20 dB & 99% Bandwidth

Variant:	300 GFSK	Duty Cycle (%):	99.00
Data Rate:	150.00 Kbps	Antenna Gain (dBi):	4.5
Modulation:	FHSS	Beam Forming Gain (Y)(dB):	Not Applicable
TPC:	Not Applicable	Tested By:	CC
Engineering Test Notes:			

Test Measurement Results

Test Frequency	Measured 20 dB Bandwidth (MHz)				20 dB Bandwidth (MHz)		Limit	Lowest Margin
	Port(s)				Highest	Lowest		
MHz	a	b	c	d			KHz	KHz
902.3	0.178	--	--	--	0.178	0.178	≤500.0	-322.0
915.2	0.182	--	--	--	0.182	0.182	≤500.0	-318.0
926.9	0.184	--	--	--	0.184	0.184	≤500.0	-316.0

Test Frequency	Measured 99% Bandwidth (MHz)				Maximum 99% Bandwidth (MHz)		
	Port(s)						
MHz	a	b	c	d			
902.3	0.164	--	--	--	0.164		
915.2	0.164	--	--	--	0.162		
926.9	0.164	--	--	--	0.162		

Traceability to Industry Recognized Test Methodologies

Work Instruction:	WI-03 MEASURING RF SPECTRUM MASK
Measurement Uncertainty:	±2.81 dB

Note: click the links in the above matrix to view the graphical image (plot).

This test report may be reproduced in full only. The document may only be updated by MiCOM Labs personnel. All changes will be noted in the Document History section of the report.



Title: Silver Spring Networks NIC 511-0303
To: FCC CFR 47 Part 15 Subpart C 15.247 & IC RSS 247
Serial #: SSNT108-U8 Rev A
Issue Date: 11th December 2015
Page: 28 of 204

Equipment Configuration for 20 dB & 99% Bandwidth

Variant:	300 GFSK	Duty Cycle (%):	99.00
Data Rate:	200.00 Kbps	Antenna Gain (dBi):	4.5
Modulation:	FHSS	Beam Forming Gain (Y)(dB):	Not Applicable
TPC:	Not Applicable	Tested By:	CC
Engineering Test Notes:			

Test Measurement Results

Test Frequency	Measured 20 dB Bandwidth (MHz)				20 dB Bandwidth (MHz)		Limit	Lowest Margin
	Port(s)				Highest	Lowest		
MHz	a	b	c	d			KHz	KHz
902.3	0.237	--	--	--	0.237	0.237	≤500.0	-263.0
915.2	0.244	--	--	--	0.244	0.244	≤500.0	-256.0
926.9	0.240	--	--	--	0.240	0.240	≤500.0	-260.0

Test Frequency	Measured 99% Bandwidth (MHz)				Maximum 99% Bandwidth (MHz)		
	Port(s)						
MHz	a	b	c	d			
902.3	0.217	--	--	--	0.217		
915.2	0.216	--	--	--	0.216		
926.9	0.217	--	--	--	0.217		

Traceability to Industry Recognized Test Methodologies

Work Instruction:	WI-03 MEASURING RF SPECTRUM MASK
Measurement Uncertainty:	±2.81 dB

Note: click the links in the above matrix to view the graphical image (plot).

This test report may be reproduced in full only. The document may only be updated by MiCOM Labs personnel. All changes will be noted in the Document History section of the report.



Title: Silver Spring Networks NIC 511-0303
To: FCC CFR 47 Part 15 Subpart C 15.247 & IC RSS 247
Serial #: SSNT108-U8 Rev A
Issue Date: 11th December 2015
Page: 29 of 204

Equipment Configuration for 20 dB & 99% Bandwidth

Variant:	400 FSK	Duty Cycle (%):	99.00
Data Rate:	150.00 Kbps	Antenna Gain (dBi):	4.5
Modulation:	FHSS	Beam Forming Gain (Y)(dB):	Not Applicable
TPC:	Not Applicable	Tested By:	CC
Engineering Test Notes:			

Test Measurement Results

Test Frequency	Measured 20 dB Bandwidth (MHz)				20 dB Bandwidth (MHz)		Limit	Lowest Margin
	Port(s)				Highest	Lowest		
MHz	a	b	c	d			KHz	KHz
902.4	0.172	--	--	--	0.172	0.172	≤500.0	-327.0
915.2	0.179	--	--	--	0.179	0.179	≤500.0	-321.0
927.6	0.171	--	--	--	0.171	0.171	≤500.0	-329.0

Test Frequency	Measured 99% Bandwidth (MHz)				Maximum 99% Bandwidth (MHz)		
	Port(s)						
MHz	a	b	c	d			
902.4	0.163	--	--	--	0.163		
915.2	0.164	--	--	--	0.164		
927.6	0.161	--	--	--	0.161		

Traceability to Industry Recognized Test Methodologies

Work Instruction:	WI-03 MEASURING RF SPECTRUM MASK
Measurement Uncertainty:	±2.81 dB

Note: click the links in the above matrix to view the graphical image (plot).

This test report may be reproduced in full only. The document may only be updated by MiCOM Labs personnel. All changes will be noted in the Document History section of the report.



Title: Silver Spring Networks NIC 511-0303
To: FCC CFR 47 Part 15 Subpart C 15.247 & IC RSS 247
Serial #: SSNT108-U8 Rev A
Issue Date: 11th December 2015
Page: 30 of 204

Equipment Configuration for 20 dB & 99% Bandwidth

Variant:	400 GFSK	Duty Cycle (%):	99.00
Data Rate:	300.00 Kbps	Antenna Gain (dBi):	4.5
Modulation:	FHSS	Beam Forming Gain (Y)(dB):	Not Applicable
TPC:	Not Applicable	Tested By:	CC
Engineering Test Notes:			

Test Measurement Results

Test Frequency	Measured 20 dB Bandwidth (MHz)				20 dB Bandwidth (MHz)		Limit	Lowest Margin
	Port(s)				Highest	Lowest		
MHz	a	b	c	d			KHz	KHz
902.4	0.350	--	--	--	0.350	0.350	≤500.0	-150.0
915.2	0.359	--	--	--	0.359	0.359	≤500.0	-141.0
927.6	0.363	--	--	--	0.363	0.363	≤500.0	-155.0

Test Frequency	Measured 99% Bandwidth (MHz)				Maximum 99% Bandwidth (MHz)		
	Port(s)						
MHz	a	b	c	d			
902.4	0.330	--	--	--	0.330		
915.2	0.331	--	--	--	0.331		
927.6	0.331	--	--	--	0.331		

Traceability to Industry Recognized Test Methodologies

Work Instruction:	WI-03 MEASURING RF SPECTRUM MASK
Measurement Uncertainty:	±2.81 dB

Note: click the links in the above matrix to view the graphical image (plot).

This test report may be reproduced in full only. The document may only be updated by MiCOM Labs personnel. All changes will be noted in the Document History section of the report.



Title: Silver Spring Networks NIC 511-0303
To: FCC CFR 47 Part 15 Subpart C 15.247 & IC RSS 247
Serial #: SSNT108-U8 Rev A
Issue Date: 11th December 2015
Page: 31 of 204

Equipment Configuration for 20 dB & 99% Bandwidth			
Variant:	200 2FSK	Duty Cycle (%):	99.00
Data Rate:	50.00 Kbps	Antenna Gain (dBi):	4.5
Modulation:	FHSS	Beam Forming Gain (Y)(dB):	Not Applicable
TPC:	Not Applicable	Tested By:	CC
Engineering Test Notes:			

Test Measurement Results

Test Frequency	Measured 20 dB Bandwidth (MHz)				20 dB Bandwidth (MHz)		Limit	Lowest Margin
	Port(s)				Highest	Lowest		
	MHz	a	b	c			d	KHz
902.2	0.091	--	--	--	0.091	0.091	≤500.0	-409.0
915.0	0.087	--	--	--	0.087	0.087	≤500.0	-413.0
927.8	0.081	--	--	--	0.081	0.081	≤500.0	-419.0

Test Frequency	Measured 99% Bandwidth (MHz)				Maximum 99% Bandwidth (MHz)		
	Port(s)						
	MHz	a	b	c	d		
902.2	0.087	--	--	--	0.087		
915.0	0.086	--	--	--	0.086		
927.8	0.085	--	--	--	0.085		

Traceability to Industry Recognized Test Methodologies	
Work Instruction:	WI-03 MEASURING RF SPECTRUM MASK
Measurement Uncertainty:	2.81 dB

Note: click the links in the above matrix to view the graphical image (plot).

This test report may be reproduced in full only. The document may only be updated by MiCOM Labs personnel. All changes will be noted in the Document History section of the report.



Title: Silver Spring Networks NIC 511-0303
To: FCC CFR 47 Part 15 Subpart C 15.247 & IC RSS 247
Serial #: SSNT108-U8 Rev A
Issue Date: 11th December 2015
Page: 32 of 204

Equipment Configuration for 20 dB & 99% Bandwidth

Variant:	200 OQPSK	Duty Cycle (%):	99.00
Data Rate:	6.25 Kbps	Antenna Gain (dBi):	4.5
Modulation:	FHSS	Beam Forming Gain (Y)(dB):	Not Applicable
TPC:	Not Applicable	Tested By:	CC
Engineering Test Notes:			

Test Measurement Results

Test Frequency	Measured 20 dB Bandwidth (MHz)				20 dB Bandwidth (MHz)		Limit	Lowest Margin
	Port(s)				Highest	Lowest		
MHz	a	b	c	d			KHz	KHz
902.2	0.128	--	--	--	0.128	0.128	≤500.0	-372.0
915.0	0.127	--	--	--	0.127	0.127	≤500.0	-373.0
927.8	0.122	--	--	--	0.122	0.122	≤500.0	-378.0

Test Frequency	Measured 99% Bandwidth (MHz)				Maximum 99% Bandwidth (MHz)		
	Port(s)						
MHz	a	b	c	d			
902.2	0.115	--	--	--	0.115		
915.0	0.116	--	--	--	0.116		
927.8	0.114	--	--	--	0.114		

Traceability to Industry Recognized Test Methodologies

Work Instruction:	WI-03 MEASURING RF SPECTRUM MASK
Measurement Uncertainty:	2.81 dB

Note: click the links in the above matrix to view the graphical image (plot).

This test report may be reproduced in full only. The document may only be updated by MiCOM Labs personnel. All changes will be noted in the Document History section of the report.



Title: Silver Spring Networks NIC 511-0303
To: FCC CFR 47 Part 15 Subpart C 15.247 & IC RSS 247
Serial #: SSNT108-U8 Rev A
Issue Date: 11th December 2015
Page: 33 of 204

Equipment Configuration for 20 dB & 99% Bandwidth

Variant:	400 OFDM	Duty Cycle (%):	99.00
Data Rate:	600 Kbps	Antenna Gain (dBi):	4.5
Modulation:	FHSS	Beam Forming Gain (Y)(dB):	Not Applicable
TPC:	Not Applicable	Tested By:	CC
Engineering Test Notes:			

Test Measurement Results

Test Frequency	Measured 20 dB Bandwidth (MHz)				20 dB Bandwidth (MHz)		Limit	Lowest Margin
	Port(s)				Highest	Lowest		
MHz	a	b	c	d			KHz	KHz
902.4	0.384	--	--	--	0.384	0.384	≤500.0	-116.0
915.2	0.377	--	--	--	0.377	0.377	≤500.0	-123.0
927.6	0.383	--	--	--	0.383	0.383	≤500.0	-117.0

Test Frequency	Measured 99% Bandwidth (MHz)				Maximum 99% Bandwidth (MHz)		
	Port(s)						
MHz	a	b	c	d			
902.4	0.341	--	--	--	0.341		
915.2	0.300	--	--	--	0.300		
927.6	0.298	--	--	--	0.298		

Traceability to Industry Recognized Test Methodologies

Work Instruction:	WI-03 MEASURING RF SPECTRUM MASK
Measurement Uncertainty:	2.81 dB

Note: click the links in the above matrix to view the graphical image (plot).

This test report may be reproduced in full only. The document may only be updated by MiCOM Labs personnel. All changes will be noted in the Document History section of the report.



9.2. 6 dB & 99% Bandwidth

Conducted Test Conditions for 6 dB and 99% Bandwidth			
Standard:	FCC CFR 47:15.247	Ambient Temp. (°C):	24.0 - 27.5
Test Heading:	6 dB and 99 % Bandwidth	Rel. Humidity (%):	32 - 45
Standard Section(s):	15.247 (a)(2)	Pressure (mBars):	999 - 1001
Reference Document(s):	See Normative References		

Test Procedure for 6 dB and 99% Bandwidth Measurement
The bandwidth at 6 dB and 99 % was measured with a spectrum analyzer connected to the antenna terminal, while EUT is operating in transmission mode at the appropriate center frequency.

Testing was performed under ambient conditions at nominal voltage. Where the device operated with multiple antenna ports i.e. MIMO device, each port was measured and reported.

Test configuration and setup used for the measurement was per the Conducted Test Set-up specified in this document.

Limits for 6 dB and 99% Bandwidth

(a) Operation under the provisions of this Section is limited to frequency hopping and digitally modulated intentional radiators that comply with the following provisions:

(2) Systems using digital modulation techniques may operate in the 902-928 MHz and 2400-2483.5 MHz bands. The minimum 6 dB bandwidth shall be at least 500 kHz.

This test report may be reproduced in full only. The document may only be updated by MiCOM Labs personnel. All changes will be noted in the Document History section of the report.



Title: Silver Spring Networks NIC 511-0303
To: FCC CFR 47 Part 15 Subpart C 15.247 & IC RSS 247
Serial #: SSNT108-U8 Rev A
Issue Date: 11th December 2015
Page: 35 of 204

9.2.1. Modulation (DTS)

Equipment Configuration for 6 dB & 99% Bandwidth

Variant:	1200 OFDM	Duty Cycle (%):	99.00
Data Rate:	2400.00 Kbps	Antenna Gain (dBi):	4.5
Modulation:	DTS	Beam Forming Gain (Y)(dB):	Not Applicable
TPC:	Not Applicable	Tested By:	CC
Engineering Test Notes:			

Test Measurement Results

Test Frequency	Measured 6 dB Bandwidth (MHz)				6 dB Bandwidth (MHz)		Limit	Lowest Margin
	Port(s)				Highest	Lowest		
MHz	a	b	c	d			KHz	MHz
903.2	1.116	--	--	--	1.116	1.116	≥500.0	-0.61
914.0	1.106	--	--	--	1.106	1.106	≥500.0	-0.60
926.0	1.098	--	--	--	1.073	1.073	≥500.0	-0.59

Test Frequency	Measured 99% Bandwidth (MHz)				Maximum 99% Bandwidth (MHz)		
	Port(s)						
MHz	a	b	c	d			
903.2	1.251	--	--	--	1.251		
914.0	1.242	--	--	--	1.242		
926.0	1.238	--	--	--	1.238		

Traceability to Industry Recognized Test Methodologies

Work Instruction:	WI-03 MEASURING RF SPECTRUM MASK
Measurement Uncertainty:	2.81 dB

Note: click the links in the above matrix to view the graphical image (plot).

This test report may be reproduced in full only. The document may only be updated by MiCOM Labs personnel. All changes will be noted in the Document History section of the report.



9.3. Number Of Channels

Conducted Test Conditions for Number Of Channels			
Standard:	FCC CFR 47:15.247	Ambient Temp. (°C):	24.0 - 27.5
Test Heading:	Number of Channels	Rel. Humidity (%):	32 - 45
Standard Section(s):	15.247 (a)(2)	Pressure (mBars):	999 - 1001
Reference Document(s):	See Normative References		
<p>Test Procedure The number of channels and channel occupancy is measured with a spectrum analyzer connected to the antenna terminal, while the EUT is operating in transmission mode at the appropriate center frequency and modulation.</p> <p>Testing was performed under ambient conditions at nominal voltage. Where the device operated with multiple antenna ports i.e. MIMO device, each port was measured and reported.</p> <p>Test configuration and setup used for the measurement was per the Conducted Test Set-up specified in this document.</p> <p>Limit For frequency hopping systems operating in the 902-928 MHz band: if the 20 dB bandwidth of the hopping channel is less than 250 kHz, the system shall use at least 50 hopping frequencies; if the 20 dB bandwidth of the hopping channel is 250 kHz or greater, the system shall use at least 25 hopping frequencies.</p>			

This test report may be reproduced in full only. The document may only be updated by MiCOM Labs personnel. All changes will be noted in the Document History section of the report.



Title: Silver Spring Networks NIC 511-0303
To: FCC CFR 47 Part 15 Subpart C 15.247 & IC RSS 247
Serial #: SSNT108-U8 Rev A
Issue Date: 11th December 2015
Page: 37 of 204

Equipment Configuration for Hopping Sequence			
Variant:	Not Applicable	Duty Cycle (%):	Not Applicable
Data Rate:	Not Applicable	Antenna Gain (dBi):	Not Applicable
Modulation:	FHSS	Beam Forming Gain (Y)(dB):	Not Applicable
TPC:	Not Applicable	Tested By:	CC
Engineering Test Notes:			

Test Measurement Results					
Variant	Frequency Range (MHz)	Number of Hopping Channels	Limit	Total Number of Hops	Results
			No of Hopping Channels		
200 kHz OQPSK	900.00 – 914.00	60.0	≥ 50	129.0	Pass
200 kHz OQPSK	914.00 – 928.00	69.0	≥ 50	129.0	Pass
200 kHz OQPSK	902.00 – 928.00	Total No. of Hopping Channels:		129.0	Pass
400 kHz FSK	900.00 – 914.00	40.0	≥ 50	83.0	Pass
400 kHz FSK	914.00 – 928.00	43.0	≥ 50	83.0	Pass
400 kHz FSK	902.00 – 928.00	Total No. of Hopping Channels:		83.0	Pass
400 kHz OFDM	900.00 – 914.00	30.0	≥ 25	63.0	Pass
400 kHz OFDM	914.00 – 928.00	33.0	≥ 25	63.0	Pass
400 kHz OFDM	902.00 – 928.00	Total No. of Hopping Channels:		63.0	Pass

Traceability to Industry Recognized Test Methodologies	
Work Instruction:	WI-03 MEASURING RF SPECTRUM MASK
Measurement Uncertainty:	±2.81 dB

Note: click the links in the above matrix to view the graphical image (plot).

This test report may be reproduced in full only. The document may only be updated by MiCOM Labs personnel. All changes will be noted in the Document History section of the report.



9.4. Channel Spacing

Conducted Test Conditions for 6 dB and 99% Bandwidth			
Standard:	FCC CFR 47:15.247	Ambient Temp. (°C):	24.0 - 27.5
Test Heading:	Channel Spacing	Rel. Humidity (%):	32 - 45
Standard Section(s):	15.247 (a)(2)	Pressure (mBars):	999 - 1001
Reference Document(s):	See Normative References		

Test Procedure
The number of channels and channel occupancy is measured with a spectrum analyzer connected to the antenna terminal, while the EUT is operating in transmission mode at the appropriate center frequency and modulation.

Testing was performed under ambient conditions at nominal voltage. Where the device operated with multiple antenna ports i.e. MIMO device, each port was measured and reported.

Test configuration and setup used for the measurement was per the Conducted Test Set-up specified in this document.

Limit

(i) For frequency hopping systems operating in the 902-928 MHz band: if the 20 dB bandwidth of the hopping channel is less than 250 kHz, the system shall use at least 50 hopping frequencies and the average time of occupancy on any frequency shall not be greater than 0.4 seconds within a 20 second period; if the 20 dB bandwidth of the hopping channel is 250 kHz or greater, the system shall use at least 25 hopping frequencies and the average time of occupancy on any frequency shall not be greater than 0.4 seconds within a 10 second period. The maximum allowed 20 dB bandwidth of the hopping channel is 500 kHz.

This test report may be reproduced in full only. The document may only be updated by MiCOM Labs personnel. All changes will be noted in the Document History section of the report.



Title: Silver Spring Networks NIC 511-0303
To: FCC CFR 47 Part 15 Subpart C 15.247 & IC RSS 247
Serial #: SSNT108-U8 Rev A
Issue Date: 11th December 2015
Page: 39 of 204

Equipment Configuration for Channel Separation

Variant:	Not Applicable	Duty Cycle (%):	Not Applicable
Data Rate:	Not Applicable	Antenna Gain (dBi):	Not Applicable
Modulation:	FHSS	Beam Forming Gain (Y)(dB):	Not Applicable
TPC:	Not Applicable	Tested By:	CC
Engineering Test Notes:			

Test Measurement Results

Center Frequency	Variant Type	Chan Separation	Limit (20 dB Occ. BW)	Result
MHz		MHz	MHz	
915.00	200 kHz OQPSK	0.200	≥ 0.130	Pass
915.20	300 kHz FSK	0.302	≥ 0.122	Pass
915.20	400 kHz OFDM	0.400	≥ 0.384	Pass

Traceability to Industry Recognized Test Methodologies

Measurement Uncertainty:	±2.81 dB (Spectrum/Amplitude), ±0.86 ppm (Frequency)
--------------------------	--

Note: click the links in the above matrix to view the graphical image (plot).

This test report may be reproduced in full only. The document may only be updated by MiCOM Labs personnel. All changes will be noted in the Document History section of the report.



Title: Silver Spring Networks NIC 511-0303
To: FCC CFR 47 Part 15 Subpart C 15.247 & IC RSS 247
Serial #: SSNT108-U8 Rev A
Issue Date: 11th December 2015
Page: 40 of 204

9.5. Dwell Time & Channel Occupancy

Conducted Test Conditions for Channel Occupancy			
Standard:	FCC CFR 47:15.247	Ambient Temp. (°C):	24.0 - 27.5
Test Heading:	Dwell Time & Channel Occupancy	Rel. Humidity (%):	32 - 45
Standard Section(s):	15.247 (a)(2)	Pressure (mBars):	999 - 1001
Reference Document(s):	See Normative References		
<p>Test Procedure The number of channels and channel occupancy is measured with a spectrum analyzer connected to the antenna terminal, while the EUT is operating in transmission mode at the appropriate center frequency and modulation.</p> <p>Testing was performed under ambient conditions at nominal voltage. Where the device operated with multiple antenna ports i.e. MIMO device, each port was measured and reported.</p> <p>Test configuration and setup used for the measurement was per the Conducted Test Set-up specified in this document.</p> <p>Limit (i) For frequency hopping systems operating in the 902-928 MHz band: if the 20 dB bandwidth of the hopping channel is less than 250 kHz, the average time of occupancy on any frequency shall not be greater than 0.4 seconds within a 20 second period; if the 20 dB bandwidth of the hopping channel is 250 kHz or greater, the average time of occupancy on any frequency shall not be greater than 0.4 seconds within a 10 second period.</p>			

This test report may be reproduced in full only. The document may only be updated by MiCOM Labs personnel. All changes will be noted in the Document History section of the report.



Title: Silver Spring Networks NIC 511-0303
To: FCC CFR 47 Part 15 Subpart C 15.247 & IC RSS 247
Serial #: SSNT108-U8 Rev A
Issue Date: 11th December 2015
Page: 41 of 204

Equipment Configuration for Dwell Time & Channel Occupancy

Variant:	Not Applicable	Duty Cycle (%):	Not Applicable
Data Rate:	Not Applicable	Antenna Gain (dBi):	Not Applicable
Modulation:	FHSS	Beam Forming Gain (Y)(dB):	Not Applicable
TPC:	Not Applicable	Tested By:	CC
Engineering Test Notes:			

Test Measurement Results

Center Frequency MHz	Variant Type	Dwell Time (Single Channel)	Channel Occupancy	Channel Occupancy Limit	Result
		mS	ms	ms	
915.00	200 kHz QPSK	139.00	298.00	400.00	Pass
915.20	300 kHz FSK	81.00	243.00	400.00	Pass
915.20	400 kHz OFDM	3.00	27.00	400.00	Pass

Traceability to Industry Recognized Test Methodologies

Measurement Uncertainty:	±2.81 dB (Spectrum/Amplitude), ±0.86 ppm (Frequency)
--------------------------	--

Note: click the links in the above matrix

This test report may be reproduced in full only. The document may only be updated by MiCOM Labs personnel. All changes will be noted in the Document History section of the report.



9.6. Conducted Output Power

Conducted Test Conditions for Fundamental Emission Output Power			
Standard:	FCC CFR 47:15.247	Ambient Temp. (°C):	24.0 - 27.5
Test Heading:	Output Power	Rel. Humidity (%):	32 - 45
Standard Section(s):	15.247 (b) & (c)	Pressure (mBars):	999 - 1001
Reference Document(s):	See Normative References		

Test Procedure for Fundamental Emission Output Power Measurement
In the case of average power measurements an average power sensor was utilized.

For peak power measurements the spectrum analyzer built-in power function was used to integrate peak power over the 20 dB bandwidth.

Testing was performed under ambient conditions at nominal voltage only. Where the device operated with multiple antenna ports i.e. MIMO device, each port was measured, summed (Σ) and reported.

Test configuration and setup used for the measurement was per the Conducted Test Set-up specified in this document.

Supporting Information
Calculated Power = $A + G + Y + 10 \log (1/x)$ dBm

A = Total Power [$10 \cdot \text{Log}_{10} (10^{a/10} + 10^{b/10} + 10^{c/10} + 10^{d/10})$]
 G = Antenna Gain
 Y = Beamforming Gain
 x = Duty Cycle (average power measurements only)

Limits for Fundamental Emission Output Power
(b) The maximum peak conducted output power of the intentional radiator shall not exceed the following for non-frequency hopping systems:

(3) For systems using digital modulation in the 902-928 MHz and 2400-2483.5 MHz bands: 1 Watt. As an alternative to a peak power measurement, compliance with the one Watt limit can be based on a measurement of the maximum conducted output power. Maximum Conducted Output Power is defined as the total transmit power delivered to all antennas and antenna elements averaged across all symbols in the signaling alphabet when the transmitter is operating at its maximum power control level. Power must be summed across all antennas and antenna elements. The average must not include any time intervals during which the transmitter is off or is transmitting at a reduced power level. If multiple modes of operation are possible (e.g., alternative modulation methods), the maximum conducted output power is the highest total transmit power occurring in any mode.

(4) The conducted output power limit specified in paragraph (b) of this section is based on the use of antennas with directional gains that do not exceed 6 dBi. Except as shown in paragraph (c) of this section, if transmitting antennas of directional gain greater than 6 dBi are used, the conducted output power from the intentional radiator shall be reduced below the stated values in paragraphs (b)(3) of this section, as appropriate, by the amount in dB that the directional gain of the antenna exceeds 6 dBi.

(c) Operation with directional antenna gains greater than 6 dBi.

(1) Fixed point-to-point operation:

(i) Systems operating in the 2400-2483.5 MHz band that are used exclusively for fixed, point-to-point operations may employ transmitting antennas with directional gain greater than 6 dBi provided the maximum conducted output power of the intentional radiator is reduced by 1 dB for every 3 dB that the directional gain of the antenna exceeds 6 dBi.

(iii) Fixed, point-to-point operation, as used in paragraphs (c)(1)(i) and (c)(1)(ii) of this section, excludes the use of point-to-multipoint systems, omnidirectional applications, and multiple co-located intentional radiators transmitting the same information. The operator of the spread spectrum or digitally modulated intentional radiator or, if the equipment is professionally installed, the installer is responsible for ensuring that the system is used exclusively for fixed, point-to-point operations. The instruction manual furnished with the intentional radiator shall contain language in the installation

This test report may be reproduced in full only. The document may only be updated by MiCOM Labs personnel. All changes will be noted in the Document History section of the report.



Title: Silver Spring Networks NIC 511-0303
To: FCC CFR 47 Part 15 Subpart C 15.247 & IC RSS 247
Serial #: SSNT108-U8 Rev A
Issue Date: 11th December 2015
Page: 43 of 204

instructions informing the operator and the installer of this responsibility.

(2) In addition to the provisions in paragraphs (b)(3), (b)(4) and (c)(1)(i) of this section, transmitters operating in the 2400-2483.5 MHz band that emit multiple directional beams, simultaneously or sequentially, for the purpose of directing signals to individual receivers or to groups of receivers provided the emissions comply with the following:

(i) Different information must be transmitted to each receiver.

(ii) If the transmitter employs an antenna system that emits multiple directional beams but does not do emit multiple directional beams simultaneously, the total output power conducted to the array or arrays that comprise the device, i.e., the sum of the power supplied to all antennas, antenna elements, staves, etc. and summed across all carriers or frequency channels, shall not exceed the limit specified in paragraph (b)(1) or (b)(3) of this section, as applicable. However, the total conducted output power shall be reduced by 1 dB below the specified limits for each 3 dB that the directional gain of the antenna/antenna array exceeds 6 dBi. The directional antenna gain shall be computed as follows:

(A) The directional gain shall be calculated as the sum of 10 log (number of array elements or staves) plus the directional gain of the element or staff having the highest gain.

(B) A lower value for the directional gain than that calculated in paragraph (c)(2)(ii)(A) of this section will be accepted if sufficient evidence is presented, e.g., due to shading of the array or coherence loss in the beamforming.

(iii) If a transmitter employs an antenna that operates simultaneously on multiple directional beams using the same or different frequency channels, the power supplied to each emission beam is subject to the power limit specified in paragraph (c)(2)(ii) of this section. If transmitted beams overlap, the power shall be reduced to ensure that their aggregate power does not exceed the limit specified in paragraph (c)(2)(ii) of this section. In addition, the aggregate power transmitted simultaneously on all beams shall not exceed the limit specified in paragraph (c)(2)(ii) of this section by more than 8 dB.

(iv) Transmitters that emit a single directional beam shall operate under the provisions of paragraph (c)(1) of this section.

This test report may be reproduced in full only. The document may only be updated by MiCOM Labs personnel. All changes will be noted in the Document History section of the report.



Title: Silver Spring Networks NIC 511-0303
To: FCC CFR 47 Part 15 Subpart C 15.247 & IC RSS 247
Serial #: SSNT108-U8 Rev A
Issue Date: 11th December 2015
Page: 44 of 204

9.6.1. Modulation (FHSS)

Equipment Configuration for Peak Output Power

Variant:	300 FSK	Duty Cycle (%):	99.00
Data Rate:	100.00 Kbps	Antenna Gain (dBi):	4.5
Modulation:	FHSS	Beam Forming Gain (Y)(dB):	Not Applicable
TPC:	Not Applicable	Tested By:	CC
Engineering Test Notes:			

Test Measurement Results

Test Frequency	Measured Output Power + DCCF (+0.04 dB) (dBm)				Calculated Total Power Σ Port(s)	Limit	Margin	EUT Power Setting
	Port(s)							
MHz	a	b	c	d	dBm	dBm	dB	
902.3	29.86	--	--	--	29.90	30.00	-0.10	30.00
915.2	29.83	--	--	--	29.87	30.00	-0.13	30.00
926.9	29.78	--	--	--	29.82	30.00	-0.18	30.00

Traceability to Industry Recognized Test Methodologies

Work Instruction:	WI-01 MEASURING RF OUTPUT POWER
Measurement Uncertainty:	± 1.33 dB

DCCF - Duty Cycle Correction Factor

This test report may be reproduced in full only. The document may only be updated by MiCOM Labs personnel. All changes will be noted in the Document History section of the report.



Title: Silver Spring Networks NIC 511-0303
To: FCC CFR 47 Part 15 Subpart C 15.247 & IC RSS 247
Serial #: SSNT108-U8 Rev A
Issue Date: 11th December 2015
Page: 45 of 204

Equipment Configuration for Peak Output Power

Variant:	300 GFSK	Duty Cycle (%):	99.00
Data Rate:	150.00 Kbps	Antenna Gain (dBi):	4.5
Modulation:	FHSS	Beam Forming Gain (Y)(dB):	Not Applicable
TPC:	Not Applicable	Tested By:	CC
Engineering Test Notes:			

Test Measurement Results

Test Frequency	Measured Output Power + DCCF (+0.04 dB) (dBm)				Calculated Total Power Σ Port(s)	Limit	Margin	EUT Power Setting
	Port(s)							
MHz	a	b	c	d	dBm	dBm	dB	
902.3	29.95	--	--	--	29.99	30.00	-0.01	30.00
915.2	29.87	--	--	--	29.91	30.00	-0.09	30.00
926.9	29.84	--	--	--	29.88	30.00	-0.14	30.00

Traceability to Industry Recognized Test Methodologies

Work Instruction:	WI-01 MEASURING RF OUTPUT POWER
Measurement Uncertainty:	± 1.33 dB

DCCF - Duty Cycle Correction Factor

This test report may be reproduced in full only. The document may only be updated by MiCOM Labs personnel. All changes will be noted in the Document History section of the report.



Title: Silver Spring Networks NIC 511-0303
To: FCC CFR 47 Part 15 Subpart C 15.247 & IC RSS 247
Serial #: SSNT108-U8 Rev A
Issue Date: 11th December 2015
Page: 46 of 204

Equipment Configuration for Peak Output Power

Variants:	300 GFSK	Duty Cycle (%):	99.00
Data Rate:	200 Kbps	Antenna Gain (dBi):	4.5
Modulation:	FHSS	Beam Forming Gain (Y)(dB):	Not Applicable
TPC:	Not Applicable	Tested By:	CC
Engineering Test Notes:			

Test Measurement Results

Test Frequency	Measured Output Power + DCCF (+0.04 dB) (dBm)				Calculated Total Power Σ Port(s)	Limit	Margin	EUT Power Setting
	Port(s)							
MHz	a	b	c	d	dBm	dBm	dB	
902.3	29.95	--	--	--	29.99	30.00	-0.01	30.00
915.2	29.91	--	--	--	29.95	30.00	-0.04	30.00
926.9	29.82	--	--	--	29.86	30.00	-0.14	30.00

Traceability to Industry Recognized Test Methodologies

Work Instruction:	WI-01 MEASURING RF OUTPUT POWER
Measurement Uncertainty:	± 1.33 dB

DCCF - Duty Cycle Correction Factor

This test report may be reproduced in full only. The document may only be updated by MiCOM Labs personnel. All changes will be noted in the Document History section of the report.



Title: Silver Spring Networks NIC 511-0303
To: FCC CFR 47 Part 15 Subpart C 15.247 & IC RSS 247
Serial #: SSNT108-U8 Rev A
Issue Date: 11th December 2015
Page: 47 of 204

Equipment Configuration for Peak Output Power

Variant:	400 FSK	Duty Cycle (%):	99.00
Data Rate:	150.00 Kbps	Antenna Gain (dBi):	4.5
Modulation:	FHSS	Beam Forming Gain (Y)(dB):	Not Applicable
TPC:	Not Applicable	Tested By:	CC
Engineering Test Notes:			

Test Measurement Results

Test Frequency	Measured Output Power + DCCF (+0.04 dB) (dBm)				Calculated Total Power Σ Port(s)	Limit	Margin	EUT Power Setting
	Port(s)							
MHz	a	b	c	d	dBm	dBm	dB	
902.4	29.93	--	--	--	29.97	30.00	-0.03	30.00
915.2	29.88	--	--	--	29.92	30.00	-0.08	30.00
927.6	29.86	--	--	--	29.90	30.00	-0.10	30.00

Traceability to Industry Recognized Test Methodologies

Work Instruction:	WI-01 MEASURING RF OUTPUT POWER
Measurement Uncertainty:	± 1.33 dB

DCCF - Duty Cycle Correction Factor

This test report may be reproduced in full only. The document may only be updated by MiCOM Labs personnel. All changes will be noted in the Document History section of the report.



Title: Silver Spring Networks NIC 511-0303
To: FCC CFR 47 Part 15 Subpart C 15.247 & IC RSS 247
Serial #: SSNT108-U8 Rev A
Issue Date: 11th December 2015
Page: 48 of 204

Equipment Configuration for Peak Output Power

Variants:	400 GFSK	Duty Cycle (%):	99.00
Data Rate:	300.00 Kbps	Antenna Gain (dBi):	4.5
Modulation:	FHSS	Beam Forming Gain (Y)(dB):	Not Applicable
TPC:	Not Applicable	Tested By:	CC
Engineering Test Notes:			

Test Measurement Results

Test Frequency	Measured Output Power + DCCF (+0.04 dB) (dBm)				Calculated Total Power Σ Port(s)	Limit	Margin	EUT Power Setting
	Port(s)							
MHz	a	b	c	d	dBm	dBm	dB	
902.4	29.95	--	--	--	29.99	30.00	-0.01	30.00
915.2	29.87	--	--	--	29.91	30.00	-0.09	30.00
927.6	29.84	--	--	--	29.88	30.00	-0.12	30.00

Traceability to Industry Recognized Test Methodologies

Work Instruction:	WI-01 MEASURING RF OUTPUT POWER
Measurement Uncertainty:	± 1.33 dB

DCCF - Duty Cycle Correction Factor

This test report may be reproduced in full only. The document may only be updated by MiCOM Labs personnel. All changes will be noted in the Document History section of the report.



Title: Silver Spring Networks NIC 511-0303
To: FCC CFR 47 Part 15 Subpart C 15.247 & IC RSS 247
Serial #: SSNT108-U8 Rev A
Issue Date: 11th December 2015
Page: 49 of 204

Equipment Configuration for Peak Output Power

Variant:	200 2FSK	Duty Cycle (%):	99.00
Data Rate:	50.00 Kbps	Antenna Gain (dBi):	4.5
Modulation:	FHSS	Beam Forming Gain (Y)(dB):	Not Applicable
TPC:	Not Applicable	Tested By:	CC
Engineering Test Notes:			

Test Measurement Results

Test Frequency	Measured Output Power + DCCF (+0.04 dB) (dBm)				Calculated Total Power Σ Port(s)	Limit	Margin	EUT Power Setting
	Port(s)							
MHz	a	b	c	d	dBm	dBm	dB	
902.2	29.96	--	--	--	30.00	30.00	-0.00	30.00
915.0	29.89	--	--	--	29.93	30.00	-0.07	30.00
927.8	29.95	--	--	--	29.99	30.00	-0.01	30.00

Traceability to Industry Recognized Test Methodologies

Work Instruction:	WI-01 MEASURING RF OUTPUT POWER
Measurement Uncertainty:	1.33 dB

DCCF - Duty Cycle Correction Factor

This test report may be reproduced in full only. The document may only be updated by MiCOM Labs personnel. All changes will be noted in the Document History section of the report.



Title: Silver Spring Networks NIC 511-0303
To: FCC CFR 47 Part 15 Subpart C 15.247 & IC RSS 247
Serial #: SSNT108-U8 Rev A
Issue Date: 11th December 2015
Page: 50 of 204

Equipment Configuration for Peak Output Power

Variant:	200 OQPSK	Duty Cycle (%):	99.00
Data Rate:	6.25 Kbps	Antenna Gain (dBi):	4.5
Modulation:	FHSS	Beam Forming Gain (Y)(dB):	Not Applicable
TPC:	Not Applicable	Tested By:	CC
Engineering Test Notes:			

Test Measurement Results

Test Frequency	Measured Output Power + DCCF (+0.04 dB) (dBm)				Calculated Total Power Σ Port(s)	Limit	Margin	EUT Power Setting
	Port(s)							
MHz	a	b	c	d	dBm	dBm	dB	
902.2	29.53	--	--	--	29.57	30.00	-0.43	30.00
915.0	29.90	--	--	--	29.94	30.00	-0.06	30.00
927.8	29.35	--	--	--	29.39	30.00	-0.61	30.00

Traceability to Industry Recognized Test Methodologies

Work Instruction:	WI-01 MEASURING RF OUTPUT POWER
Measurement Uncertainty:	1.33 dB

DCCF - Duty Cycle Correction Factor

This test report may be reproduced in full only. The document may only be updated by MiCOM Labs personnel. All changes will be noted in the Document History section of the report.



Title: Silver Spring Networks NIC 511-0303
To: FCC CFR 47 Part 15 Subpart C 15.247 & IC RSS 247
Serial #: SSNT108-U8 Rev A
Issue Date: 11th December 2015
Page: 51 of 204

Equipment Configuration for Peak Output Power

Variants:	400 OFDM	Duty Cycle (%):	99.00
Data Rate:	600.00 Kbps	Antenna Gain (dBi):	4.5
Modulation:	FHSS	Beam Forming Gain (Y)(dB):	Not Applicable
TPC:	Not Applicable	Tested By:	CC
Engineering Test Notes:			

Test Measurement Results

Test Frequency	Measured Output Power + DCCF (+0.04 dB) (dBm)				Calculated Total Power Σ Port(s)	Limit	Margin	EUT Power Setting
	Port(s)							
MHz	a	b	c	d	dBm	dBm	dB	
902.4	29.15	--	--	--	29.19	30.00	-0.81	30.00
915.2	28.97	--	--	--	29.01	30.00	-0.99	30.00
927.6	29.02	--	--	--	29.06	30.00	-0.94	30.00

Traceability to Industry Recognized Test Methodologies

Work Instruction:	WI-01 MEASURING RF OUTPUT POWER
Measurement Uncertainty:	1.33 dB

DCCF - Duty Cycle Correction Factor

This test report may be reproduced in full only. The document may only be updated by MiCOM Labs personnel. All changes will be noted in the Document History section of the report.



Title: Silver Spring Networks NIC 511-0303
To: FCC CFR 47 Part 15 Subpart C 15.247 & IC RSS 247
Serial #: SSNT108-U8 Rev A
Issue Date: 11th December 2015
Page: 52 of 204

9.6.2. Modulation (DTS)

Equipment Configuration for Peak Output Power

Variant:	1200 OFDM	Duty Cycle (%):	99.00
Data Rate:	2400.00 Kbps	Antenna Gain (dBi):	4.5
Modulation:	DTS	Beam Forming Gain (Y)(dB):	Not Applicable
TPC:	Not Applicable	Tested By:	CC
Engineering Test Notes:			

Test Measurement Results

Test Frequency	Measured Output Power + DCCF (+0.04 dB) (dBm)				Calculated Total Power Σ Port(s)	Limit	Margin	EUT Power Setting
	Port(s)							
MHz	a	b	c	d	dBm	dBm	dB	
903.2	28.95	--	--	--	28.99	30.00	-1.01	30.00
914.0	28.78	--	--	--	28.82	30.00	-1.18	30.00
926.0	28.55	--	--	--	28.59	30.00	-1.41	30.00

Traceability to Industry Recognized Test Methodologies

Work Instruction:	WI-01 MEASURING RF OUTPUT POWER
Measurement Uncertainty:	1.33 dB

DCCF - Duty Cycle Correction Factor

This test report may be reproduced in full only. The document may only be updated by MiCOM Labs personnel. All changes will be noted in the Document History section of the report.



Title: Silver Spring Networks NIC 511-0303
To: FCC CFR 47 Part 15 Subpart C 15.247 & IC RSS 247
Serial #: SSNT108-U8 Rev A
Issue Date: 11th December 2015
Page: 53 of 204

9.7. Emissions

9.7.1. Conducted Emissions

9.7.1.1. Conducted Spurious Emissions

Conducted Test Conditions for Transmitter Conducted Spurious and Band-Edge Emissions			
Standard:	FCC CFR 47:15.247	Ambient Temp. (°C):	24.0 - 27.5
Test Heading:	Max Unwanted Emission Levels	Rel. Humidity (%):	32 - 45
Standard Section(s):	15.247 (d)	Pressure (mBars):	999 - 1001
Reference Document(s):	See Normative References		

Test Procedure for Transmitter Conducted Spurious and Band-Edge Emissions Measurement

Transmitter Conducted Spurious and Band-Edge emissions were measured at a limit of 30 dBc (average detector) or 20 dBc (peak detector) below the highest in-band spectral density measured with a spectrum analyzer connected to the antenna terminal. Measurements were made while EUT was operating in transmit mode of operation at the appropriate centre frequency closest to the band-edge. Emissions were maximized during the measurement and limits derived from the peak spectral power and drawn on each plot.

Where the device operated with multiple antenna ports i.e. MIMO device, each port was measured separately. Testing was performed under ambient conditions at nominal voltage only.

Test configuration and setup used for the measurement was per the Conducted Test Set-up specified in this document.

Limits Transmitter Conducted Spurious and Band-Edge Emissions

(d) In any 100 kHz bandwidth outside the frequency band in which the spread spectrum or digitally modulated intentional radiator is operating, the radio frequency power that is produced by the intentional radiator shall be at least 20 dB below that in the 100 kHz bandwidth within the band that contains the highest level of the desired power, based on either an RF conducted or a radiated measurement, provided the transmitter demonstrates compliance with the peak conducted power limits. If the transmitter complies with the conducted power limits based on the use of RMS averaging over a time interval, as permitted under paragraph (b)(3) of this section, the attenuation required under this paragraph shall be 30 dB instead of 20 dB. Attenuation below the general limits specified in §15.209(a) is not required. In addition, radiated emissions which fall in the restricted bands, as defined in §15.205(a), must also comply with the radiated emission limits specified in §15.209(a) (see §15.205(c)).

This test report may be reproduced in full only. The document may only be updated by MiCOM Labs personnel. All changes will be noted in the Document History section of the report.



Title: Silver Spring Networks NIC 511-0303
To: FCC CFR 47 Part 15 Subpart C 15.247 & IC RSS 247
Serial #: SSNT108-U8 Rev A
Issue Date: 11th December 2015
Page: 54 of 204

9.7.2. Modulation (FHSS)

Equipment Configuration for Transmitter Conducted Spurious Emissions

Variant:	300 FSK	Duty Cycle (%):	99.00
Data Rate:	100.00 Kbps	Antenna Gain (dBi):	Not Applicable
Modulation:	FHSS	Beam Forming Gain (Y):	Not Applicable
TPC:	Not Applicable	Tested By:	CC
Engineering Test Notes:			

Test Measurement Results

Test Frequency	Frequency Range	Transmitter Conducted Spurious Emissions (dBm)							
		Port a		Port b		Port c		Port d	
MHz	MHz	SE	Limit	SE	Limit	SE	Limit	SE	Limit
902.3	30.0 - 26000.0	-35.879	9.29	--	--	--	--	--	--
915.2	30.0 - 26000.0	-36.024	9.72	--	--	--	--	--	--
926.9	30.0 - 26000.0	-36.140	9.82	--	--	--	--	--	--

Traceability to Industry Recognized Test Methodologies

Work Instruction:	WI-05 MEASUREMENT OF SPURIOUS EMISSIONS
Measurement Uncertainty:	"<=40 GHz ±2.37 dB, > 40 GHz ±4.6 dB"

Note: click the links in the above matrix to view the graphical image (plot).

This test report may be reproduced in full only. The document may only be updated by MiCOM Labs personnel. All changes will be noted in the Document History section of the report.



Title: Silver Spring Networks NIC 511-0303
To: FCC CFR 47 Part 15 Subpart C 15.247 & IC RSS 247
Serial #: SSNT108-U8 Rev A
Issue Date: 11th December 2015
Page: 55 of 204

Equipment Configuration for Transmitter Conducted Spurious Emissions

Variant:	300 GFSK	Duty Cycle (%):	99.00
Data Rate:	150.00 Kbps	Antenna Gain (dBi):	Not Applicable
Modulation:	FHSS	Beam Forming Gain (Y):	Not Applicable
TPC:	Not Applicable	Tested By:	CC
Engineering Test Notes:			

Test Measurement Results

Test Frequency	Frequency Range	Transmitter Conducted Spurious Emissions (dBm)							
		Port a		Port b		Port c		Port d	
MHz	MHz	SE	Limit	SE	Limit	SE	Limit	SE	Limit
902.3	30.0 - 26000.0	-35.538	9.53	--	--	--	--	--	--
915.2	30.0 - 26000.0	-36.469	8.75	--	--	--	--	--	--
926.9	30.0 - 26000.0	-36.142	9.04	--	--	--	--	--	--

Traceability to Industry Recognized Test Methodologies

Work Instruction:	WI-05 MEASUREMENT OF SPURIOUS EMISSIONS
Measurement Uncertainty:	"<=40 GHz ±2.37 dB, > 40 GHz ±4.6 dB"

Note: click the links in the above matrix to view the graphical image (plot).

This test report may be reproduced in full only. The document may only be updated by MiCOM Labs personnel. All changes will be noted in the Document History section of the report.



Title: Silver Spring Networks NIC 511-0303
To: FCC CFR 47 Part 15 Subpart C 15.247 & IC RSS 247
Serial #: SSNT108-U8 Rev A
Issue Date: 11th December 2015
Page: 56 of 204

Equipment Configuration for Transmitter Conducted Spurious Emissions

Variant:	300 GFSK	Duty Cycle (%):	99.00
Data Rate:	200.00 Kbps	Antenna Gain (dBi):	Not Applicable
Modulation:	FHSS	Beam Forming Gain (Y):	Not Applicable
TPC:	Not Applicable	Tested By:	CC
Engineering Test Notes:			

Test Measurement Results

Test Frequency	Frequency Range	Transmitter Conducted Spurious Emissions (dBm)							
		Port a		Port b		Port c		Port d	
MHz	MHz	SE	Limit	SE	Limit	SE	Limit	SE	Limit
902.3	30.0 - 26000.0	-36.142	9.47	--	--	--	--	--	--
915.2	30.0 - 26000.0	-34.942	9.11	--	--	--	--	--	--
926.9	30.0 - 26000.0	-35.747	8.97	--	--	--	--	--	--

Traceability to Industry Recognized Test Methodologies

Work Instruction:	WI-05 MEASUREMENT OF SPURIOUS EMISSIONS
Measurement Uncertainty:	"<=40 GHz ±2.37 dB, > 40 GHz ±4.6 dB"

Note: click the links in the above matrix to view the graphical image (plot).

This test report may be reproduced in full only. The document may only be updated by MiCOM Labs personnel. All changes will be noted in the Document History section of the report.



Title: Silver Spring Networks NIC 511-0303
To: FCC CFR 47 Part 15 Subpart C 15.247 & IC RSS 247
Serial #: SSNT108-U8 Rev A
Issue Date: 11th December 2015
Page: 57 of 204

Equipment Configuration for Transmitter Conducted Spurious Emissions

Variant:	400 FSK	Duty Cycle (%):	99.00
Data Rate:	150.00 Kbps	Antenna Gain (dBi):	Not Applicable
Modulation:	FHSS	Beam Forming Gain (Y):	Not Applicable
TPC:	Not Applicable	Tested By:	CC
Engineering Test Notes:			

Test Measurement Results

Test Frequency	Frequency Range	Transmitter Conducted Spurious Emissions (dBm)							
		Port a		Port b		Port c		Port d	
MHz	MHz	SE	Limit	SE	Limit	SE	Limit	SE	Limit
902.4	30.0 - 26000.0	-37.195	9.40	--	--	--	--	--	--
915.2	30.0 - 26000.0	-35.393	9.46	--	--	--	--	--	--
927.6	30.0 - 26000.0	-36.439	8.82	--	--	--	--	--	--

Traceability to Industry Recognized Test Methodologies

Work Instruction:	WI-05 MEASUREMENT OF SPURIOUS EMISSIONS
Measurement Uncertainty:	"<=40 GHz ±2.37 dB, > 40 GHz ±4.6 dB"

Note: click the links in the above matrix to view the graphical image (plot).

This test report may be reproduced in full only. The document may only be updated by MiCOM Labs personnel. All changes will be noted in the Document History section of the report.



Title: Silver Spring Networks NIC 511-0303
To: FCC CFR 47 Part 15 Subpart C 15.247 & IC RSS 247
Serial #: SSNT108-U8 Rev A
Issue Date: 11th December 2015
Page: 58 of 204

Equipment Configuration for Transmitter Conducted Spurious Emissions

Variant:	400 GFSK	Duty Cycle (%):	99.00
Data Rate:	300.00 Kbps	Antenna Gain (dBi):	Not Applicable
Modulation:	FHSS	Beam Forming Gain (Y):	Not Applicable
TPC:	Not Applicable	Tested By:	CC
Engineering Test Notes:			

Test Measurement Results

Test Frequency	Frequency Range	Transmitter Conducted Spurious Emissions (dBm)							
		Port a		Port b		Port c		Port d	
MHz	MHz	SE	Limit	SE	Limit	SE	Limit	SE	Limit
902.4	30.0 - 26000.0	-36.219	9.05	--	--	--	--	--	--
915.2	30.0 - 26000.0	-36.034	8.86	--	--	--	--	--	--
927.6	30.0 - 26000.0	-36.528	8.83	--	--	--	--	--	--

Traceability to Industry Recognized Test Methodologies

Work Instruction:	WI-05 MEASUREMENT OF SPURIOUS EMISSIONS
Measurement Uncertainty:	"<=40 GHz ±2.37 dB, > 40 GHz ±4.6 dB"

Note: click the links in the above matrix to view the graphical image (plot).

This test report may be reproduced in full only. The document may only be updated by MiCOM Labs personnel. All changes will be noted in the Document History section of the report.



Title: Silver Spring Networks NIC 511-0303
To: FCC CFR 47 Part 15 Subpart C 15.247 & IC RSS 247
Serial #: SSNT108-U8 Rev A
Issue Date: 11th December 2015
Page: 59 of 204

Equipment Configuration for Transmitter Conducted Spurious Emissions

Variant:	200 2FSK	Duty Cycle (%):	99.00
Data Rate:	50.00 Kbps	Antenna Gain (dBi):	Not Applicable
Modulation:	FHSS	Beam Forming Gain (Y):	Not Applicable
TPC:	Not Applicable	Tested By:	CC
Engineering Test Notes:			

Test Measurement Results

Test Frequency	Frequency Range	Transmitter Conducted Spurious Emissions (dBm)							
		Port a		Port b		Port c		Port d	
MHz	MHz	SE	Limit	SE	Limit	SE	Limit	SE	Limit
902.2	30.0 - 26000.0	-36.282	9.50	--	--	--	--	--	--
915.0	30.0 - 26000.0	-36.294	9.51	--	--	--	--	--	--
927.8	30.0 - 26000.0	-38.590	9.33	--	--	--	--	--	--

Traceability to Industry Recognized Test Methodologies

Work Instruction:	WI-05 MEASUREMENT OF SPURIOUS EMISSIONS
Measurement Uncertainty:	"<=40 GHz 2.37 dB, > 40 GHz 4.6 dB"

Note: click the links in the above matrix to view the graphical image (plot).

This test report may be reproduced in full only. The document may only be updated by MiCOM Labs personnel. All changes will be noted in the Document History section of the report.



Title: Silver Spring Networks NIC 511-0303
To: FCC CFR 47 Part 15 Subpart C 15.247 & IC RSS 247
Serial #: SSNT108-U8 Rev A
Issue Date: 11th December 2015
Page: 60 of 204

Equipment Configuration for Transmitter Conducted Spurious Emissions

Variant:	200 OQPSK	Duty Cycle (%):	99.00
Data Rate:	6.25 Kbps	Antenna Gain (dBi):	Not Applicable
Modulation:	FHSS	Beam Forming Gain (Y):	Not Applicable
TPC:	Not Applicable	Tested By:	CC
Engineering Test Notes:			

Test Measurement Results

Test Frequency	Frequency Range	Transmitter Conducted Spurious Emissions (dBm)							
		Port a		Port b		Port c		Port d	
MHz	MHz	SE	Limit	SE	Limit	SE	Limit	SE	Limit
902.2	30.0 - 26000.0	-38.490	9.82	--	--	--	--	--	--
915.0	30.0 - 26000.0	-35.566	9.46	--	--	--	--	--	--
927.8	30.0 - 26000.0	-38.480	9.41	--	--	--	--	--	--

Traceability to Industry Recognized Test Methodologies

Work Instruction:	WI-05 MEASUREMENT OF SPURIOUS EMISSIONS
Measurement Uncertainty:	"<=40 GHz 2.37 dB, > 40 GHz 4.6 dB"

Note: click the links in the above matrix to view the graphical image (plot).

This test report may be reproduced in full only. The document may only be updated by MiCOM Labs personnel. All changes will be noted in the Document History section of the report.



Title: Silver Spring Networks NIC 511-0303
To: FCC CFR 47 Part 15 Subpart C 15.247 & IC RSS 247
Serial #: SSNT108-U8 Rev A
Issue Date: 11th December 2015
Page: 61 of 204

Equipment Configuration for Transmitter Conducted Spurious Emissions

Variant:	400 OFDM	Duty Cycle (%):	99.00
Data Rate:	600 Kbps	Antenna Gain (dBi):	Not Applicable
Modulation:	FHSS	Beam Forming Gain (Y):	Not Applicable
TPC:	Not Applicable	Tested By:	CC
Engineering Test Notes:			

Test Measurement Results

Test Frequency	Frequency Range	Transmitter Conducted Spurious Emissions (dBm)							
		Port a		Port b		Port c		Port d	
MHz	MHz	SE	Limit	SE	Limit	SE	Limit	SE	Limit
902.4	30.0 - 26000.0	-36.229	4.72	--	--	--	--	--	--
915.2	30.0 - 26000.0	-36.674	3.59	--	--	--	--	--	--
927.6	30.0 - 26000.0	-35.609	5.32	--	--	--	--	--	--

Traceability to Industry Recognized Test Methodologies

Work Instruction:	WI-05 MEASUREMENT OF SPURIOUS EMISSIONS
Measurement Uncertainty:	"<=40 GHz 2.37 dB, > 40 GHz 4.6 dB"

Note: click the links in the above matrix to view the graphical image (plot).

This test report may be reproduced in full only. The document may only be updated by MiCOM Labs personnel. All changes will be noted in the Document History section of the report.



Title: Silver Spring Networks NIC 511-0303
To: FCC CFR 47 Part 15 Subpart C 15.247 & IC RSS 247
Serial #: SSNT108-U8 Rev A
Issue Date: 11th December 2015
Page: 62 of 204

9.7.3. Modulation (DTS)

Equipment Configuration for Transmitter Conducted Spurious Emissions

Variant:	1200 OFDM	Duty Cycle (%):	99.00
Data Rate:	2400.00 Kbps	Antenna Gain (dBi):	Not Applicable
Modulation:	DTS	Beam Forming Gain (Y):	Not Applicable
TPC:	Not Applicable	Tested By:	CC
Engineering Test Notes:			

Test Measurement Results

Test Frequency	Frequency Range	Transmitter Conducted Spurious Emissions (dBm)							
		Port a		Port b		Port c		Port d	
MHz	MHz	SE	Limit	SE	Limit	SE	Limit	SE	Limit
903.2	30.0 - 26000.0	-35.556	0.90	--	--	--	--	--	--
914.0	30.0 - 26000.0	-36.457	0.84	--	--	--	--	--	--
926.0	30.0 - 26000.0	-35.393	0.63	--	--	--	--	--	--

Traceability to Industry Recognized Test Methodologies	
Work Instruction:	WI-05 MEASUREMENT OF SPURIOUS EMISSIONS
Measurement Uncertainty:	"<=40 GHz 2.37 dB, > 40 GHz 4.6 dB"

Note: click the links in the above matrix to view the graphical image (plot).

This test report may be reproduced in full only. The document may only be updated by MiCOM Labs personnel. All changes will be noted in the Document History section of the report.



Title: Silver Spring Networks NIC 511-0303
To: FCC CFR 47 Part 15 Subpart C 15.247 & IC RSS 247
Serial #: SSNT108-U8 Rev A
Issue Date: 11th December 2015
Page: 63 of 204

9.7.3.2. Conducted Band-Edge Emissions

9.7.3.2.1. Conducted Low Band-Edge Emissions

9.7.3.2.1.1. Modulation (FHSS)

Equipment Configuration for Conducted Low Band-Edge Emissions - Peak

Variant:	300 FSK	Duty Cycle (%):	99.00
Data Rate:	100.00 Kbps	Antenna Gain (dBi):	4.5
Modulation:	FHSS	Beam Forming Gain (Y)(dB):	Not Applicable
TPC:	Not Applicable	Tested By:	CC
Engineering Test Notes:			

Test Measurement Results

Channel Frequency:	902.3 MHz					
Band-Edge Frequency:	902.0 MHz					
Test Frequency Range:	880.0 - 904.0 MHz					
Port(s)	Band-Edge Markers and Limit			Revised Limit		Margin
	M1 Amplitude (dBm)	Plot Limit (dBm)	M2 Frequency (MHz)	Amplitude (dBm)	M2A Frequency (MHz)	(MHz)
a	<u>-4.669</u>	9.90	902.12	--	--	-0.120

Traceability to Industry Recognized Test Methodologies

Work Instruction:	WI-05 MEASUREMENT OF SPURIOUS EMISSIONS
Measurement Uncertainty:	"<=40 GHz ±2.37 dB, > 40 GHz ±4.6 dB"

Note: click the links in the above matrix to view the graphical image (plot).

This test report may be reproduced in full only. The document may only be updated by MiCOM Labs personnel. All changes will be noted in the Document History section of the report.



Title: Silver Spring Networks NIC 511-0303
To: FCC CFR 47 Part 15 Subpart C 15.247 & IC RSS 247
Serial #: SSNT108-U8 Rev A
Issue Date: 11th December 2015
Page: 64 of 204

Equipment Configuration for Conducted Low Band-Edge Emissions - Peak

Variant:	300 GFSK	Duty Cycle (%):	99.00
Data Rate:	150.00 Kbps	Antenna Gain (dBi):	4.5
Modulation:	FHSS	Beam Forming Gain (Y)(dB):	Not Applicable
TPC:	Not Applicable	Tested By:	CC
Engineering Test Notes:			

Test Measurement Results

Channel Frequency:	902.3 MHz					
Band-Edge Frequency:	902.0 MHz					
Test Frequency Range:	880.0 - 904.0 MHz					
Port(s)	Band-Edge Markers and Limit			Revised Limit		Margin
	M1 Amplitude (dBm)	Plot Limit (dBm)	M2 Frequency (MHz)	Amplitude (dBm)	M2A Frequency (MHz)	(MHz)
a	-1.92	8.90	902.09	--	--	-0.090

Traceability to Industry Recognized Test Methodologies

Work Instruction:	WI-05 MEASUREMENT OF SPURIOUS EMISSIONS
Measurement Uncertainty:	"<=40 GHz ±2.37 dB, > 40 GHz ±4.6 dB"

Note: click the links in the above matrix to view the graphical image (plot).

This test report may be reproduced in full only. The document may only be updated by MiCOM Labs personnel. All changes will be noted in the Document History section of the report.



Title: Silver Spring Networks NIC 511-0303
To: FCC CFR 47 Part 15 Subpart C 15.247 & IC RSS 247
Serial #: SSNT108-U8 Rev A
Issue Date: 11th December 2015
Page: 65 of 204

Equipment Configuration for Conducted Low Band-Edge Emissions - Peak

Variant:	300 GFSK	Duty Cycle (%):	99.00
Data Rate:	200.00 Kbps	Antenna Gain (dBi):	4.5
Modulation:	FHSS	Beam Forming Gain (Y)(dB):	Not Applicable
TPC:	Not Applicable	Tested By:	CC
Engineering Test Notes:			

Test Measurement Results

Channel Frequency:	902.3 MHz					
Band-Edge Frequency:	902.0 MHz					
Test Frequency Range:	880.0 - 904.0 MHz					
Port(s)	Band-Edge Markers and Limit			Revised Limit		Margin
	M1 Amplitude (dBm)	Plot Limit (dBm)	M2 Frequency (MHz)	Amplitude (dBm)	M2A Frequency (MHz)	(MHz)
a	1.56	9.73	902.06	--	--	-0.060

Traceability to Industry Recognized Test Methodologies

Work Instruction:	WI-05 MEASUREMENT OF SPURIOUS EMISSIONS
Measurement Uncertainty:	"<=40 GHz ±2.37 dB, > 40 GHz ±4.6 dB"

Note: click the links in the above matrix to view the graphical image (plot).

This test report may be reproduced in full only. The document may only be updated by MiCOM Labs personnel. All changes will be noted in the Document History section of the report.



Title: Silver Spring Networks NIC 511-0303
To: FCC CFR 47 Part 15 Subpart C 15.247 & IC RSS 247
Serial #: SSNT108-U8 Rev A
Issue Date: 11th December 2015
Page: 66 of 204

Equipment Configuration for Conducted Low Band-Edge Emissions - Peak

Variant:	400 FSK	Duty Cycle (%):	99.00
Data Rate:	150.00 Kbps	Antenna Gain (dBi):	4.5
Modulation:	FHSS	Beam Forming Gain (Y)(dB):	Not Applicable
TPC:	Not Applicable	Tested By:	CC
Engineering Test Notes:			

Test Measurement Results

Channel Frequency:	902.4 MHz					
Band-Edge Frequency:	902.0 MHz					
Test Frequency Range:	880.0 - 904.0 MHz					
Port(s)	Band-Edge Markers and Limit			Revised Limit		Margin
	M1 Amplitude (dBm)	Plot Limit (dBm)	M2 Frequency (MHz)	Amplitude (dBm)	M2A Frequency (MHz)	(MHz)
a	-12.87	9.96	902.19	--	--	-0.190

Traceability to Industry Recognized Test Methodologies

Work Instruction:	WI-05 MEASUREMENT OF SPURIOUS EMISSIONS
Measurement Uncertainty:	"<=40 GHz ±2.37 dB, > 40 GHz ±4.6 dB"

Note: click the links in the above matrix to view the graphical image (plot).

This test report may be reproduced in full only. The document may only be updated by MiCOM Labs personnel. All changes will be noted in the Document History section of the report.



Title: Silver Spring Networks NIC 511-0303
To: FCC CFR 47 Part 15 Subpart C 15.247 & IC RSS 247
Serial #: SSNT108-U8 Rev A
Issue Date: 11th December 2015
Page: 67 of 204

Equipment Configuration for Conducted Low Band-Edge Emissions - Peak

Variant:	400 GFSK	Duty Cycle (%):	99.00
Data Rate:	300.00 Kbps	Antenna Gain (dBi):	4.5
Modulation:	FHSS	Beam Forming Gain (Y)(dB):	Not Applicable
TPC:	Not Applicable	Tested By:	CC
Engineering Test Notes:			

Test Measurement Results

Channel Frequency:	902.4 MHz					
Band-Edge Frequency:	902.0 MHz					
Test Frequency Range:	880.0 - 904.0 MHz					
Port(s)	Band-Edge Markers and Limit			Revised Limit		Margin
	M1 Amplitude (dBm)	Plot Limit (dBm)	M2 Frequency (MHz)	Amplitude (dBm)	M2A Frequency (MHz)	(MHz)
a	-4.45	9.76	902.12	--	--	-0.120

Traceability to Industry Recognized Test Methodologies

Work Instruction:	WI-05 MEASUREMENT OF SPURIOUS EMISSIONS
Measurement Uncertainty:	"<=40 GHz ±2.37 dB, > 40 GHz ±4.6 dB"

Note: click the links in the above matrix to view the graphical image (plot).

This test report may be reproduced in full only. The document may only be updated by MiCOM Labs personnel. All changes will be noted in the Document History section of the report.



Title: Silver Spring Networks NIC 511-0303
To: FCC CFR 47 Part 15 Subpart C 15.247 & IC RSS 247
Serial #: SSNT108-U8 Rev A
Issue Date: 11th December 2015
Page: 68 of 204

Equipment Configuration for Conducted Low Band-Edge Emissions - Peak

Variant:	200 2FSK	Duty Cycle (%):	99.00
Data Rate:	50.00 Kbps	Antenna Gain (dBi):	4.5
Modulation:	FHSS	Beam Forming Gain (Y)(dB):	Not Applicable
TPC:	Not Applicable	Tested By:	CC
Engineering Test Notes:			

Test Measurement Results

Channel Frequency:	902.2 MHz					
Band-Edge Frequency:	902.0 MHz					
Test Frequency Range:	880.0 - 905.0 MHz					
Port(s)	Band-Edge Markers and Limit			Revised Limit		Margin
	M1 Amplitude (dBm)	Plot Limit (dBm)	M2 Frequency (MHz)	Amplitude (dBm)	M2A Frequency (MHz)	(MHz)
a	8.52	9.88	902.01	--	--	-0.010

Traceability to Industry Recognized Test Methodologies

Work Instruction:	WI-05 MEASUREMENT OF SPURIOUS EMISSIONS
Measurement Uncertainty:	"<=40 GHz 2.37 dB, > 40 GHz 4.6 dB"

Note: click the links in the above matrix to view the graphical image (plot).

This test report may be reproduced in full only. The document may only be updated by MiCOM Labs personnel. All changes will be noted in the Document History section of the report.



Title: Silver Spring Networks NIC 511-0303
To: FCC CFR 47 Part 15 Subpart C 15.247 & IC RSS 247
Serial #: SSNT108-U8 Rev A
Issue Date: 11th December 2015
Page: 69 of 204

Equipment Configuration for Conducted Low Band-Edge Emissions - Peak

Variant:	200 OQPSK	Duty Cycle (%):	99.00
Data Rate:	6.25 Kbps	Antenna Gain (dBi):	4.5
Modulation:	FHSS	Beam Forming Gain (Y)(dB):	Not Applicable
TPC:	Not Applicable	Tested By:	CC
Engineering Test Notes:			

Test Measurement Results

Channel Frequency:	902.2 MHz					
Band-Edge Frequency:	902.0 MHz					
Test Frequency Range:	880.0 - 905.0 MHz					
Port(s)	Band-Edge Markers and Limit			Revised Limit		Margin
	M1 Amplitude (dBm)	Plot Limit (dBm)	M2 Frequency (MHz)	Amplitude (dBm)	M2A Frequency (MHz)	(MHz)
a	0.80	9.90	902.035	--	--	-0.035

Traceability to Industry Recognized Test Methodologies

Work Instruction:	WI-05 MEASUREMENT OF SPURIOUS EMISSIONS
Measurement Uncertainty:	"<=40 GHz 2.37 dB, > 40 GHz 4.6 dB"

Note: click the links in the above matrix to view the graphical image (plot).

This test report may be reproduced in full only. The document may only be updated by MiCOM Labs personnel. All changes will be noted in the Document History section of the report.



Title: Silver Spring Networks NIC 511-0303
To: FCC CFR 47 Part 15 Subpart C 15.247 & IC RSS 247
Serial #: SSNT108-U8 Rev A
Issue Date: 11th December 2015
Page: 70 of 204

Equipment Configuration for Conducted Low Band-Edge Emissions - Peak

Variant:	400 OFDM	Duty Cycle (%):	99.00
Data Rate:	600 Kbps	Antenna Gain (dBi):	4.5
Modulation:	FHSS	Beam Forming Gain (Y)(dB):	Not Applicable
TPC:	Not Applicable	Tested By:	CC
Engineering Test Notes:			

Test Measurement Results

Channel Frequency:	902.4 MHz					
Band-Edge Frequency:	902.0 MHz					
Test Frequency Range:	880.0 - 905.0 MHz					
Port(s)	Band-Edge Markers and Limit			Revised Limit		Margin
	M1 Amplitude (dBm)	Plot Limit (dBm)	M2 Frequency (MHz)	Amplitude (dBm)	M2A Frequency (MHz)	(MHz)
a	-1.32	7.52	902.12	--	--	-0.120

Traceability to Industry Recognized Test Methodologies

Work Instruction:	WI-05 MEASUREMENT OF SPURIOUS EMISSIONS
Measurement Uncertainty:	"<=40 GHz 2.37 dB, > 40 GHz 4.6 dB"

Note: click the links in the above matrix to view the graphical image (plot).

This test report may be reproduced in full only. The document may only be updated by MiCOM Labs personnel. All changes will be noted in the Document History section of the report.



Title: Silver Spring Networks NIC 511-0303
To: FCC CFR 47 Part 15 Subpart C 15.247 & IC RSS 247
Serial #: SSNT108-U8 Rev A
Issue Date: 11th December 2015
Page: 71 of 204

9.7.3.2.1.2. Modulation (DTS)

Equipment Configuration for Conducted Low Band-Edge Emissions - Peak

Variant:	1200 OFDM	Duty Cycle (%):	99.00
Data Rate:	2400.00 Kbps	Antenna Gain (dBi):	4.5
Modulation:	DTS	Beam Forming Gain (Y)(dB):	Not Applicable
TPC:	Not Applicable	Tested By:	CC
Engineering Test Notes:			

Test Measurement Results

Channel Frequency:	903.2 MHz					
Band-Edge Frequency:	902.0 MHz					
Test Frequency Range:	880.0 - 905.0 MHz					
Port(s)	Band-Edge Markers and Limit			Revised Limit		Margin
	M1 Amplitude (dBm)	Plot Limit (dBm)	M2 Frequency (MHz)	Amplitude (dBm)	M2A Frequency (MHz)	Margin (MHz)
a	-4.68	4.29	902.43	--	--	-0.430

Traceability to Industry Recognized Test Methodologies	
Work Instruction:	WI-05 MEASUREMENT OF SPURIOUS EMISSIONS
Measurement Uncertainty:	"<=40 GHz 2.37 dB, > 40 GHz 4.6 dB"

Note: click the links in the above matrix to view the graphical image (plot).

This test report may be reproduced in full only. The document may only be updated by MiCOM Labs personnel. All changes will be noted in the Document History section of the report.



Title: Silver Spring Networks NIC 511-0303
To: FCC CFR 47 Part 15 Subpart C 15.247 & IC RSS 247
Serial #: SSNT108-U8 Rev A
Issue Date: 11th December 2015
Page: 72 of 204

9.7.3.2.2. Conducted High Band-Edge Emissions

9.7.3.2.2.1. Modulation (FHSS)

Equipment Configuration for Conducted High Band-Edge Emissions - Peak

Variant:	300 FSK	Duty Cycle (%):	99.00
Data Rate:	100.00 Kbps	Antenna Gain (dBi):	4.5
Modulation:	FHSS	Beam Forming Gain (Y)(dB):	Not Applicable
TPC:	Not Applicable	Tested By:	CC
Engineering Test Notes:			

Test Measurement Results

Channel Frequency:	926.9 MHz					
Band-Edge Frequency:	928.0 MHz					
Test Frequency Range:	925.0 - 935.0 MHz					
Port(s)	Band-Edge Markers and Limit			Revised Limit		Margin
	M3 Amplitude (dBm)	Plot Limit (dBm)	M2 Frequency (MHz)	Amplitude (dBm)	M2A Frequency (MHz)	(MHz)
a	-30.46	9.43	927.12	--	--	-0.880

Traceability to Industry Recognized Test Methodologies

Work Instruction:	WI-05 MEASUREMENT OF SPURIOUS EMISSIONS
Measurement Uncertainty:	"<=40 GHz ±2.37 dB, > 40 GHz ±4.6 dB"

Note: click the links in the above matrix to view the graphical image (plot).

This test report may be reproduced in full only. The document may only be updated by MiCOM Labs personnel. All changes will be noted in the Document History section of the report.



Title: Silver Spring Networks NIC 511-0303
To: FCC CFR 47 Part 15 Subpart C 15.247 & IC RSS 247
Serial #: SSNT108-U8 Rev A
Issue Date: 11th December 2015
Page: 73 of 204

Equipment Configuration for Conducted High Band-Edge Emissions - Peak

Variant:	300 GFSK	Duty Cycle (%):	99.00
Data Rate:	150.00 Kbps	Antenna Gain (dBi):	4.5
Modulation:	FHSS	Beam Forming Gain (Y)(dB):	Not Applicable
TPC:	Not Applicable	Tested By:	CC
Engineering Test Notes:			

Test Measurement Results

Channel Frequency:	926.9 MHz					
Band-Edge Frequency:	928.0 MHz					
Test Frequency Range:	925.0 - 935.0 MHz					
Port(s)	Band-Edge Markers and Limit			Revised Limit		Margin
	M3 Amplitude (dBm)	Plot Limit (dBm)	M2 Frequency (MHz)	Amplitude (dBm)	M2A Frequency (MHz)	(MHz)
a	-30.39	9.46	927.14	--	--	-0.860

Traceability to Industry Recognized Test Methodologies

Work Instruction:	WI-05 MEASUREMENT OF SPURIOUS EMISSIONS
Measurement Uncertainty:	"<=40 GHz ±2.37 dB, > 40 GHz ±4.6 dB"

Note: click the links in the above matrix to view the graphical image (plot).

This test report may be reproduced in full only. The document may only be updated by MiCOM Labs personnel. All changes will be noted in the Document History section of the report.



Title: Silver Spring Networks NIC 511-0303
To: FCC CFR 47 Part 15 Subpart C 15.247 & IC RSS 247
Serial #: SSNT108-U8 Rev A
Issue Date: 11th December 2015
Page: 74 of 204

Equipment Configuration for Conducted High Band-Edge Emissions - Peak

Variant:	300 GFSK	Duty Cycle (%):	99.00
Data Rate:	200.00 Kbps	Antenna Gain (dBi):	4.5
Modulation:	FHSS	Beam Forming Gain (Y)(dB):	Not Applicable
TPC:	Not Applicable	Tested By:	CC
Engineering Test Notes:			

Test Measurement Results

Channel Frequency:	926.9 MHz					
Band-Edge Frequency:	928.0 MHz					
Test Frequency Range:	925.0 - 935.0 MHz					
Port(s)	Band-Edge Markers and Limit			Revised Limit		Margin
	M3 Amplitude (dBm)	Plot Limit (dBm)	M2 Frequency (MHz)	Amplitude (dBm)	M2A Frequency (MHz)	(MHz)
a	-29.86	9.46	927.16	--	--	-0.840

Traceability to Industry Recognized Test Methodologies

Work Instruction:	WI-05 MEASUREMENT OF SPURIOUS EMISSIONS
Measurement Uncertainty:	"<=40 GHz ±2.37 dB, > 40 GHz ±4.6 dB"

Note: click the links in the above matrix to view the graphical image (plot).

This test report may be reproduced in full only. The document may only be updated by MiCOM Labs personnel. All changes will be noted in the Document History section of the report.



Title: Silver Spring Networks NIC 511-0303
To: FCC CFR 47 Part 15 Subpart C 15.247 & IC RSS 247
Serial #: SSNT108-U8 Rev A
Issue Date: 11th December 2015
Page: 75 of 204

Equipment Configuration for Conducted High Band-Edge Emissions - Peak

Variant:	400 FSK	Duty Cycle (%):	99.00
Data Rate:	150.00 Kbps	Antenna Gain (dBi):	4.5
Modulation:	FHSS	Beam Forming Gain (Y)(dB):	Not Applicable
TPC:	Not Applicable	Tested By:	CC
Engineering Test Notes:			

Test Measurement Results

Channel Frequency:	927.6 MHz					
Band-Edge Frequency:	928.0 MHz					
Test Frequency Range:	925.0 - 935.0 MHz					
Port(s)	Band-Edge Markers and Limit			Revised Limit		Margin
	M3 Amplitude (dBm)	Plot Limit (dBm)	M2 Frequency (MHz)	Amplitude (dBm)	M2A Frequency (MHz)	(MHz)
a	-11.29	9.48	927.83	--	--	-0.170

Traceability to Industry Recognized Test Methodologies

Work Instruction:	WI-05 MEASUREMENT OF SPURIOUS EMISSIONS
Measurement Uncertainty:	"<=40 GHz ±2.37 dB, > 40 GHz ±4.6 dB"

Note: click the links in the above matrix to view the graphical image (plot).

This test report may be reproduced in full only. The document may only be updated by MiCOM Labs personnel. All changes will be noted in the Document History section of the report.



Title: Silver Spring Networks NIC 511-0303
To: FCC CFR 47 Part 15 Subpart C 15.247 & IC RSS 247
Serial #: SSNT108-U8 Rev A
Issue Date: 11th December 2015
Page: 76 of 204

Equipment Configuration for Conducted High Band-Edge Emissions - Peak

Variant:	400 GFSK	Duty Cycle (%):	99.00
Data Rate:	300.00 Kbps	Antenna Gain (dBi):	4.5
Modulation:	FHSS	Beam Forming Gain (Y)(dB):	Not Applicable
TPC:	Not Applicable	Tested By:	CC
Engineering Test Notes:			

Test Measurement Results

Channel Frequency:	927.6 MHz					
Band-Edge Frequency:	928.0 MHz					
Test Frequency Range:	925.0 - 935.0 MHz					
Port(s)	Band-Edge Markers and Limit			Revised Limit		Margin
	M3 Amplitude (dBm)	Plot Limit (dBm)	M2 Frequency (MHz)	Amplitude (dBm)	M2A Frequency (MHz)	(MHz)
a	-2.45	9.43	927.91	--	--	-0.180

Traceability to Industry Recognized Test Methodologies

Work Instruction:	WI-05 MEASUREMENT OF SPURIOUS EMISSIONS
Measurement Uncertainty:	"<=40 GHz ±2.37 dB, > 40 GHz ±4.6 dB"

Note: click the links in the above matrix to view the graphical image (plot).

This test report may be reproduced in full only. The document may only be updated by MiCOM Labs personnel. All changes will be noted in the Document History section of the report.



Title: Silver Spring Networks NIC 511-0303
To: FCC CFR 47 Part 15 Subpart C 15.247 & IC RSS 247
Serial #: SSNT108-U8 Rev A
Issue Date: 11th December 2015
Page: 77 of 204

Equipment Configuration for Conducted High Band-Edge Emissions - Peak

Variant:	200 2FSK	Duty Cycle (%):	99.00
Data Rate:	50.00 Kbps	Antenna Gain (dBi):	4.5
Modulation:	FHSS	Beam Forming Gain (Y)(dB):	Not Applicable
TPC:	Not Applicable	Tested By:	CC
Engineering Test Notes:			

Test Measurement Results

Channel Frequency:	927.8 MHz					
Band-Edge Frequency:	928.0 MHz					
Test Frequency Range:	925.0 - 935.0 MHz					
Port(s)	Band-Edge Markers and Limit			Revised Limit		Margin
	M3 Amplitude (dBm)	Plot Limit (dBm)	M2 Frequency (MHz)	Amplitude (dBm)	M2A Frequency (MHz)	(MHz)
a	-9.50	9.54	927.949	--	--	-0.051

Traceability to Industry Recognized Test Methodologies

Work Instruction:	WI-05 MEASUREMENT OF SPURIOUS EMISSIONS
Measurement Uncertainty:	"<=40 GHz 2.37 dB, > 40 GHz 4.6 dB"

Note: click the links in the above matrix to view the graphical image (plot).

This test report may be reproduced in full only. The document may only be updated by MiCOM Labs personnel. All changes will be noted in the Document History section of the report.



Title: Silver Spring Networks NIC 511-0303
To: FCC CFR 47 Part 15 Subpart C 15.247 & IC RSS 247
Serial #: SSNT108-U8 Rev A
Issue Date: 11th December 2015
Page: 78 of 204

Equipment Configuration for Conducted High Band-Edge Emissions - Peak

Variant:	200 OQPSK	Duty Cycle (%):	99.00
Data Rate:	6.25 Kbps	Antenna Gain (dBi):	4.5
Modulation:	FHSS	Beam Forming Gain (Y)(dB):	Not Applicable
TPC:	Not Applicable	Tested By:	CC
Engineering Test Notes:			

Test Measurement Results

Channel Frequency:	927.6 MHz					
Band-Edge Frequency:	928.0 MHz					
Test Frequency Range:	925.0 - 935.0 MHz					
Port(s)	Band-Edge Markers and Limit			Revised Limit		Margin
	M3 Amplitude (dBm)	Plot Limit (dBm)	M2 Frequency (MHz)	Amplitude (dBm)	M2A Frequency (MHz)	(MHz)
a	-1.06	9.55	927.962	--	--	-0.038

Traceability to Industry Recognized Test Methodologies

Work Instruction:	WI-05 MEASUREMENT OF SPURIOUS EMISSIONS
Measurement Uncertainty:	"<=40 GHz 2.37 dB, > 40 GHz 4.6 dB"

Note: click the links in the above matrix to view the graphical image (plot).

This test report may be reproduced in full only. The document may only be updated by MiCOM Labs personnel. All changes will be noted in the Document History section of the report.



Title: Silver Spring Networks NIC 511-0303
To: FCC CFR 47 Part 15 Subpart C 15.247 & IC RSS 247
Serial #: SSNT108-U8 Rev A
Issue Date: 11th December 2015
Page: 79 of 204

Equipment Configuration for Conducted High Band-Edge Emissions - Peak

Variant:	400 OFDM	Duty Cycle (%):	99.00
Data Rate:	600 Kbps	Antenna Gain (dBi):	4.5
Modulation:	FHSS	Beam Forming Gain (Y)(dB):	Not Applicable
TPC:	Not Applicable	Tested By:	CC
Engineering Test Notes:			

Test Measurement Results

Channel Frequency:	927.6 MHz					
Band-Edge Frequency:	928.0 MHz					
Test Frequency Range:	925.0 - 935.0 MHz					
Port(s)	Band-Edge Markers and Limit			Revised Limit		Margin
	M3 Amplitude (dBm)	Plot Limit (dBm)	M2 Frequency (MHz)	Amplitude (dBm)	M2A Frequency (MHz)	(MHz)
a	-0.18	6.83	927.93	--	--	-0.170

Traceability to Industry Recognized Test Methodologies

Work Instruction:	WI-05 MEASUREMENT OF SPURIOUS EMISSIONS
Measurement Uncertainty:	"<=40 GHz 2.37 dB, > 40 GHz 4.6 dB"

Note: click the links in the above matrix to view the graphical image (plot).

This test report may be reproduced in full only. The document may only be updated by MiCOM Labs personnel. All changes will be noted in the Document History section of the report.



Title: Silver Spring Networks NIC 511-0303
To: FCC CFR 47 Part 15 Subpart C 15.247 & IC RSS 247
Serial #: SSNT108-U8 Rev A
Issue Date: 11th December 2015
Page: 80 of 204

9.7.3.2.2. Modulation (DTS)

Equipment Configuration for Conducted High Band-Edge Emissions - Peak

Variant:	1200 OFDM	Duty Cycle (%):	99.00
Data Rate:	2400.00 Kbps	Antenna Gain (dBi):	4.5
Modulation:	DTS	Beam Forming Gain (Y)(dB):	Not Applicable
TPC:	Not Applicable	Tested By:	CC
Engineering Test Notes:			

Test Measurement Results

Channel Frequency:	926.0 MHz					
Band-Edge Frequency:	928.0 MHz					
Test Frequency Range:	925.0 - 935.0 MHz					
Port(s)	Band-Edge Markers and Limit			Revised Limit		Margin
	M3 Amplitude (dBm)	Plot Limit (dBm)	M2 Frequency (MHz)	Amplitude (dBm)	M2A Frequency (MHz)	(MHz)
a	-20.10	3.57	926.72	--	--	-1.280

Traceability to Industry Recognized Test Methodologies	
Work Instruction:	WI-05 MEASUREMENT OF SPURIOUS EMISSIONS
Measurement Uncertainty:	"<=40 GHz 2.37 dB, > 40 GHz 4.6 dB"

Note: click the links in the above matrix to view the graphical image (plot).

This test report may be reproduced in full only. The document may only be updated by MiCOM Labs personnel. All changes will be noted in the Document History section of the report.



Title: Silver Spring Networks NIC 511-0303
To: FCC CFR 47 Part 15 Subpart C 15.247 & IC RSS 247
Serial #: SSNT108-U8 Rev A
Issue Date: 11th December 2015
Page: 81 of 204

9.7.4. Radiated Emissions

Transmitter Radiated Spurious Emissions (above 1 GHz); Peak Field Strength Measurements; and Radiated Band Edge Measurements – Restricted Bands

FCC, Part 15 Subpart C §15.247(d) 15.205; 15.209
Industry Canada RSS-247 §A5.5

Test Procedure

Radiated emissions above 1 GHz are measured in the anechoic chamber at a 3-meter distance on every azimuth in both horizontal and vertical polarities. The emissions are recorded and maximized as a function of azimuth by rotation through 360° with a spectrum analyzer in peak hold mode. Depending on the frequency band spanned a notch filter and waveguide filter was used to remove the fundamental frequency. The highest emissions relative to the limit are listed for each frequency spanned.

All measurements on any frequency or frequencies over 1 MHz are based on the use of measurement instrumentation employing an average detector function. All measurements above 1 GHz were performed using a minimum resolution bandwidth of 1 MHz.

This test report may be reproduced in full only. The document may only be updated by MiCOM Labs personnel. All changes will be noted in the Document History section of the report.



Title: Silver Spring Networks NIC 511-0303
To: FCC CFR 47 Part 15 Subpart C 15.247 & IC RSS 247
Serial #: SSNT108-U8 Rev A
Issue Date: 11th December 2015
Page: 82 of 204

Field Strength Calculation

The field strength is calculated by adding the Antenna Factor and Cable Loss, and subtracting Amplifier Gain from the measured reading. All factors are included in the reported data.

$$FS = R + AF + CORR - FO$$

where: FS = Field Strength

R = Measured Spectrum analyzer Input Amplitude

AF = Antenna Factor

CORR = Correction Factor = CL – AG + NFL

CL = Cable Loss

AG = Amplifier Gain

FO = Distance Falloff Factor

NFL = Notch Filter Loss or Waveguide Loss

For example:

Given receiver input reading of 51.5 dB μ V; Antenna Factor of 8.5 dB; Cable Loss of 1.3 dB; Falloff Factor of 0 dB, an Amplifier Gain of 26 dB and Notch Filter Loss of 1 dB. The Field Strength of the measured emission is:

$$FS = 51.5 + 8.5 + 1.3 - 26.0 + 1 = 36.3 \text{ dB}\mu\text{V/m}$$

Conversion between dB μ V/m (or dB μ V) and μ V/m (or μ V) are done as:

$$\text{Level (dB}\mu\text{V/m)} = 20 * \text{Log (level (\mu\text{V/m}))}$$

$$40 \text{ dB}\mu\text{V/m} = 100 \mu\text{V/m}$$

$$48 \text{ dB}\mu\text{V/m} = 250 \mu\text{V/m}$$

NOTE: KDB 662911 was implemented for Out-of-Band measurements. Where necessary Option (2) Measure and add 10 log (N) dB was implemented

This test report may be reproduced in full only. The document may only be updated by MiCOM Labs personnel. All changes will be noted in the Document History section of the report.



Title: Silver Spring Networks NIC 511-0303
To: FCC CFR 47 Part 15 Subpart C 15.247 & IC RSS 247
Serial #: SSNT108-U8 Rev A
Issue Date: 11th December 2015
Page: 83 of 204

Radiated emissions testing was limited to testing the mode with worst case emissions; FSK mode with the narrowest bandwidth i.e. 300 kHz FSK (Refer to the table in Section 5.6 of this report).

Integral Antenna:



Variant: FSK, Test Freq: 902.30 MHz, Antenna: Integral, Power Setting: 30 dBm, Duty Cycle (%): 100

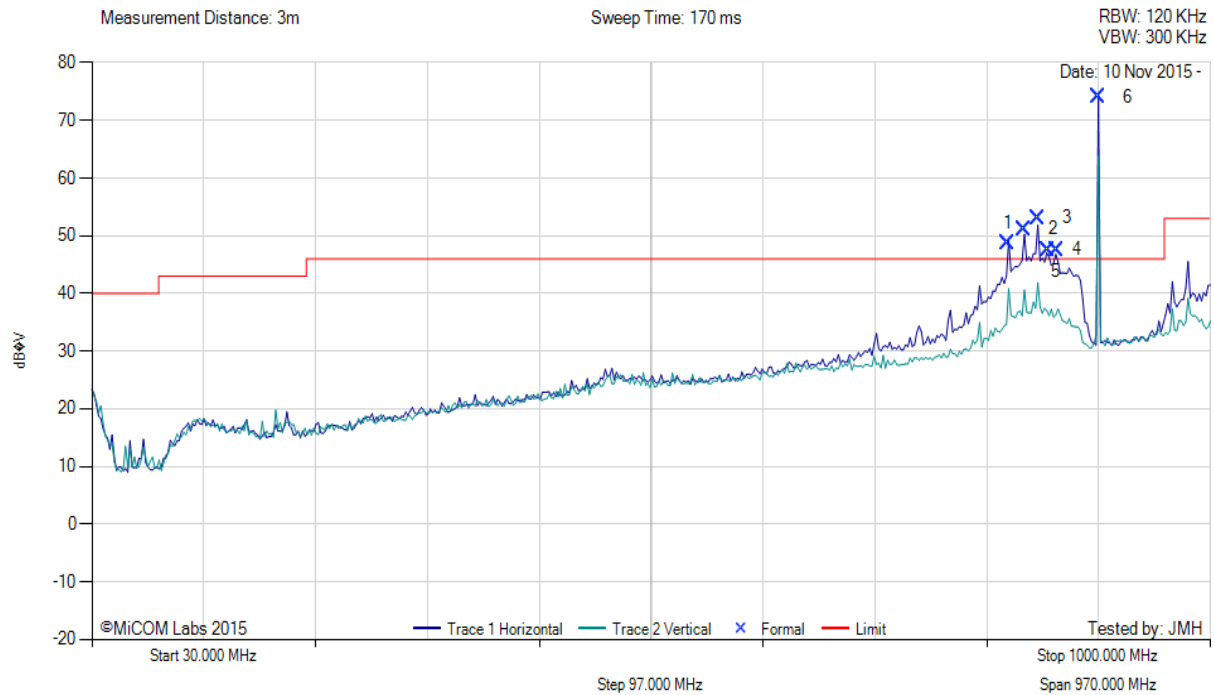

Num	Frequency MHz	Raw dBµV	Cable Loss	AF dB	Level dBµV/m	Measurement Type	Pol	Hgt cm	Azt Deg	Limit dBµV/m	Margin dB	Pass /Fail
1	824.33	50.78	6.17	-8.35	48.60	Peak (NRB)	Horizontal	100	0	--	--	Pass
2	838.31	53.47	6.20	-8.49	51.18	Peak (NRB)	Horizontal	100	0	--	--	Pass
3	850.33	55.17	6.26	-8.29	53.14	Peak (NRB)	Horizontal	100	0	--	--	Pass
4	859.31	49.54	6.24	-8.21	47.57	Peak (NRB)	Horizontal	100	0	--	--	Pass
5	866.21	49.42	6.26	-8.18	47.50	Peak (NRB)	Horizontal	100	0	--	--	Pass
6	902.28	75.51	6.34	-7.79	74.06	Fundamental	Horizontal	100	0	--	--	

Test Notes: EUT on table at 80cm, Powered by DC PS 4V

This test report may be reproduced in full only. The document may only be updated by MiCOM Labs personnel. All changes will be noted in the Document History section of the report.



Title: Silver Spring Networks NIC 511-0303
To: FCC CFR 47 Part 15 Subpart C 15.247 & IC RSS 247
Serial #: SSNT108-U8 Rev A
Issue Date: 11th December 2015
Page: 84 of 204



Variant: FSK, Test Freq: 915.20 MHz, Antenna: Integral, Power Setting: 30 dBm, Duty Cycle (%): 100

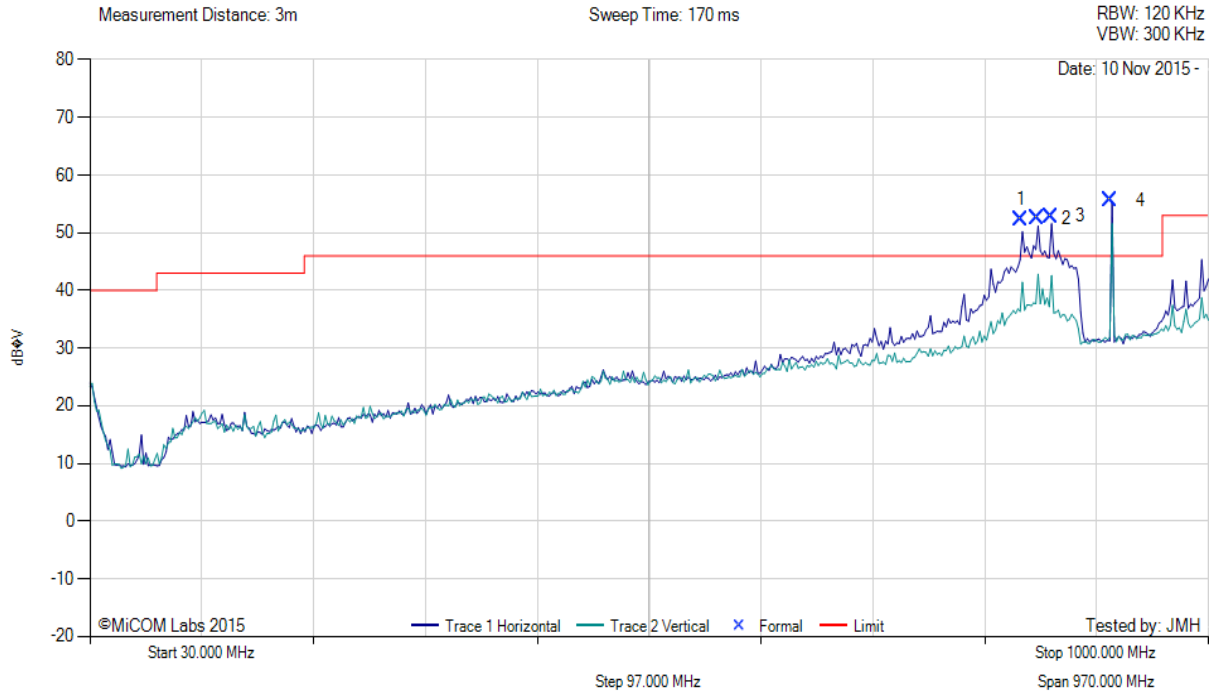

Num	Frequency MHz	Raw dBμV	Cable Loss	AF dB	Level dBμV/m	Measurement Type	Pol	Hgt cm	Azt Deg	Limit dBμV/m	Margin dB	Pass /Fail
1	837.22	54.54	6.20	-8.48	52.26	Peak (NRB)	Horizontal	100	0	--	--	Pass
2	851.33	54.55	6.26	-8.29	52.52	Peak (NRB)	Horizontal	100	0	--	--	Pass
3	863.26	54.77	6.25	-8.19	52.83	Peak (NRB)	Horizontal	100	0	--	--	Pass
4	915.17	56.97	6.39	-7.75	55.61	Fundamental	Horizontal	100	0	--	--	

Test Notes: EUT on table at 80cm powered by DC PS 4V

This test report may be reproduced in full only. The document may only be updated by MiCOM Labs personnel. All changes will be noted in the Document History section of the report.



Title: Silver Spring Networks NIC 511-0303
To: FCC CFR 47 Part 15 Subpart C 15.247 & IC RSS 247
Serial #: SSNT108-U8 Rev A
Issue Date: 11th December 2015
Page: 85 of 204



Variant: FSK, Test Freq: 926.90 MHz, Antenna: Integral, Power Setting: 30 dBm, Duty Cycle (%): 100

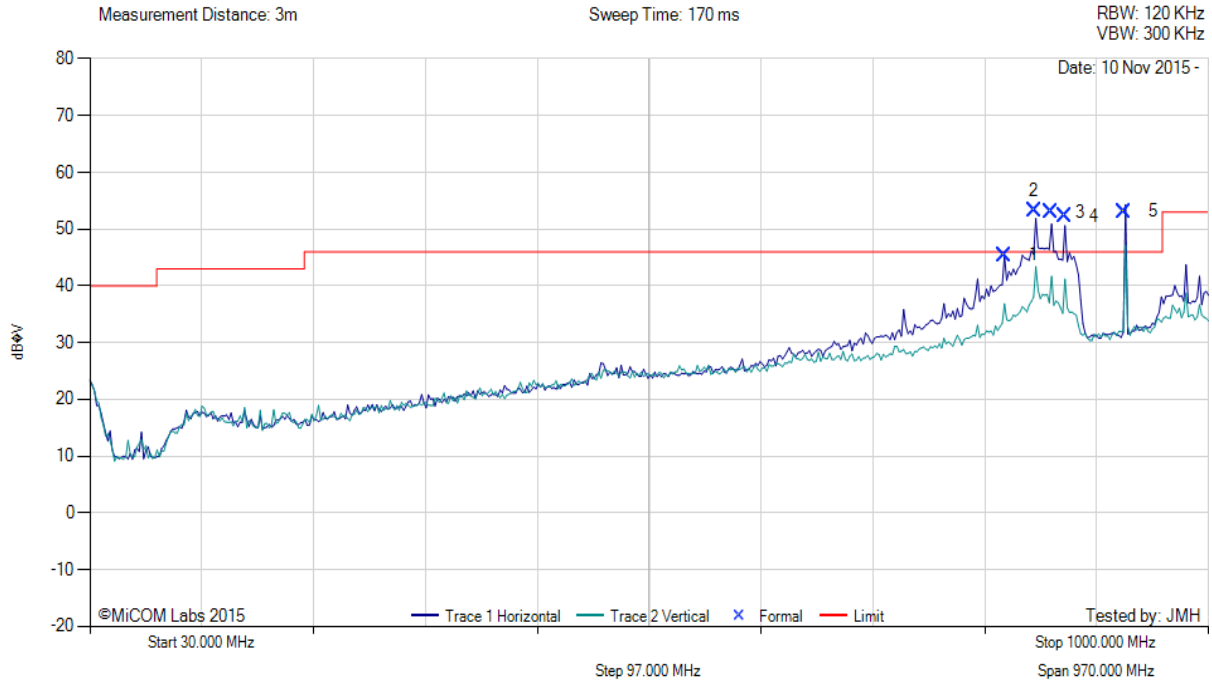

Num	Frequency MHz	Raw dBµV	Cable Loss	AF dB	Level dBµV/m	Measurement Type	Pol	Hgt cm	Azt Deg	Limit dBµV/m	Margin dB	Pass /Fail
1	822.91	47.70	6.16	-8.39	45.47	Peak (NRB)	Horizontal	100	1	--	--	Pass
2	848.86	55.27	6.26	-8.31	53.22	Peak (NRB)	Horizontal	100	1	--	--	Pass
3	862.89	54.97	6.25	-8.19	53.03	Peak (NRB)	Horizontal	100	1	--	--	Pass
4	874.91	54.12	6.27	-8.09	52.30	Peak (NRB)	Horizontal	100	1	--	--	Pass
5	926.91	54.15	6.43	-7.51	53.07	Fundamental	Horizontal	100	1	--	--	

Test Notes: EUT on table at 80cm powered by DC PS 4V

This test report may be reproduced in full only. The document may only be updated by MiCOM Labs personnel. All changes will be noted in the Document History section of the report.



Title: Silver Spring Networks NIC 511-0303
To: FCC CFR 47 Part 15 Subpart C 15.247 & IC RSS 247
Serial #: SSNT108-U8 Rev A
Issue Date: 11th December 2015
Page: 86 of 204



Variant: FSK, Test Freq: 902.30 MHz, Antenna: Integral, Power Setting: 30 dBm, Duty Cycle (%): 100

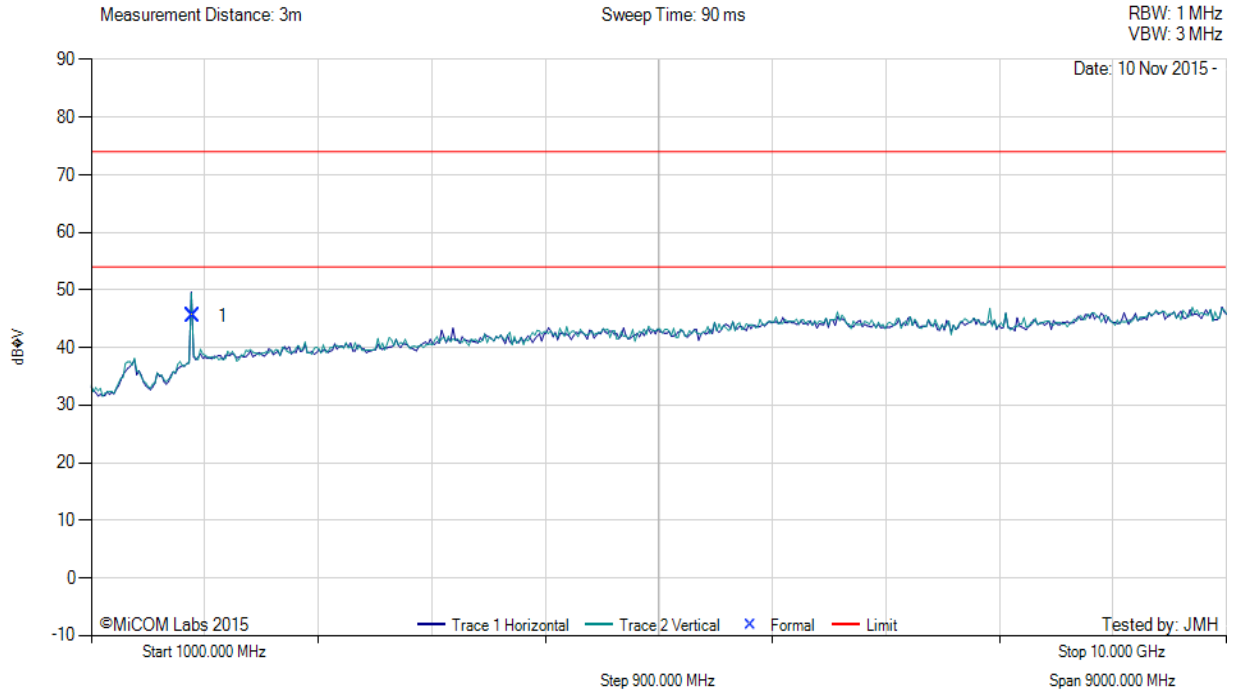

Num	Frequency MHz	Raw dBµV	Cable Loss	AF dB	Level dBµV/m	Measurement Type	Pol	Hgt cm	Azt Deg	Limit dBµV/m	Margin dB	Pass /Fail
1	1804.64	56.71	2.45	-13.63	45.53	Peak (NRB)	Horizontal	151	0	--	--	Pass

Test Notes: EUT on table at 150cm powered by DC PS 4V

This test report may be reproduced in full only. The document may only be updated by MiCOM Labs personnel. All changes will be noted in the Document History section of the report.



Title: Silver Spring Networks NIC 511-0303
To: FCC CFR 47 Part 15 Subpart C 15.247 & IC RSS 247
Serial #: SSNT108-U8 Rev A
Issue Date: 11th December 2015
Page: 87 of 204



Variant: FSK, Test Freq: 915.20 MHz, Antenna: Integral, Power Setting: 30 dBm, Duty Cycle (%): 100

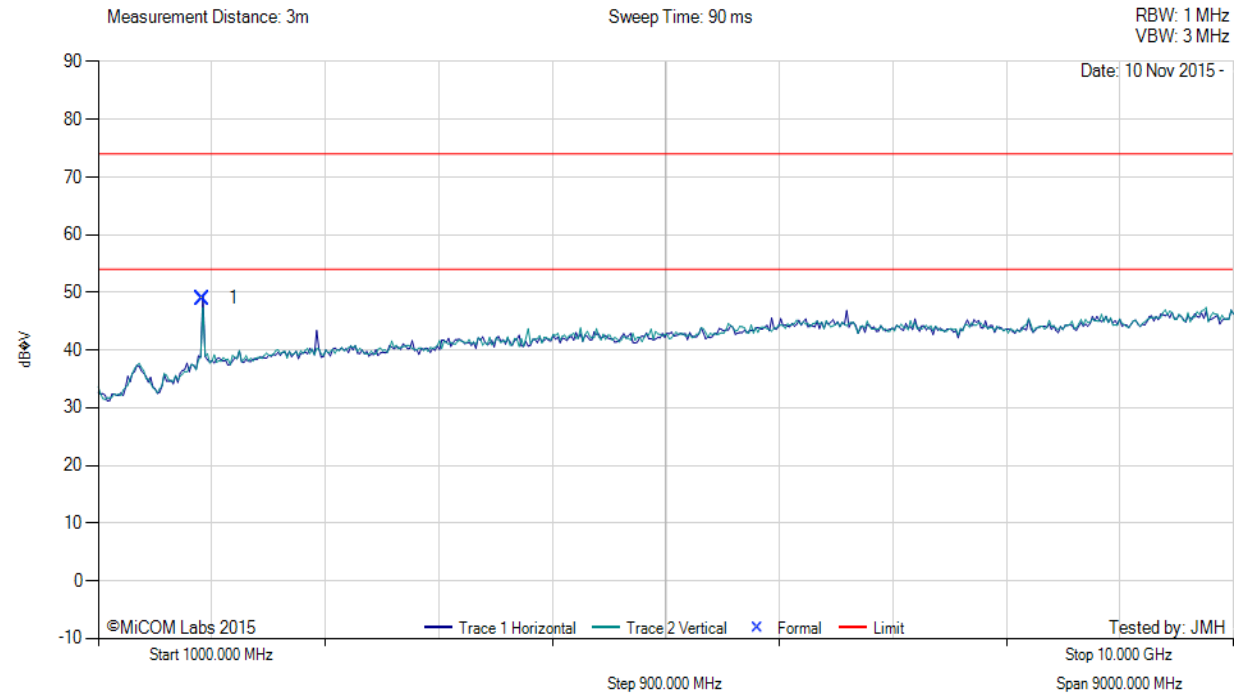

Num	Frequency MHz	Raw dBµV	Cable Loss	AF dB	Level dBµV/m	Measurement Type	Pol	Hgt cm	Azt Deg	Limit dBµV/m	Margin dB	Pass /Fail
1	1830.47	60.02	2.45	-13.54	48.93	Peak (NRB)	Horizontal	151	1	--	--	Pass

Test Notes: EUT on table at 150cm powered by DC PS 4V

This test report may be reproduced in full only. The document may only be updated by MiCOM Labs personnel. All changes will be noted in the Document History section of the report.



Title: Silver Spring Networks NIC 511-0303
To: FCC CFR 47 Part 15 Subpart C 15.247 & IC RSS 247
Serial #: SSNT108-U8 Rev A
Issue Date: 11th December 2015
Page: 88 of 204



Variant: FSK, Test Freq: 926.90 MHz, Antenna: Integral, Power Setting: 30 dBm, Duty Cycle (%): 100

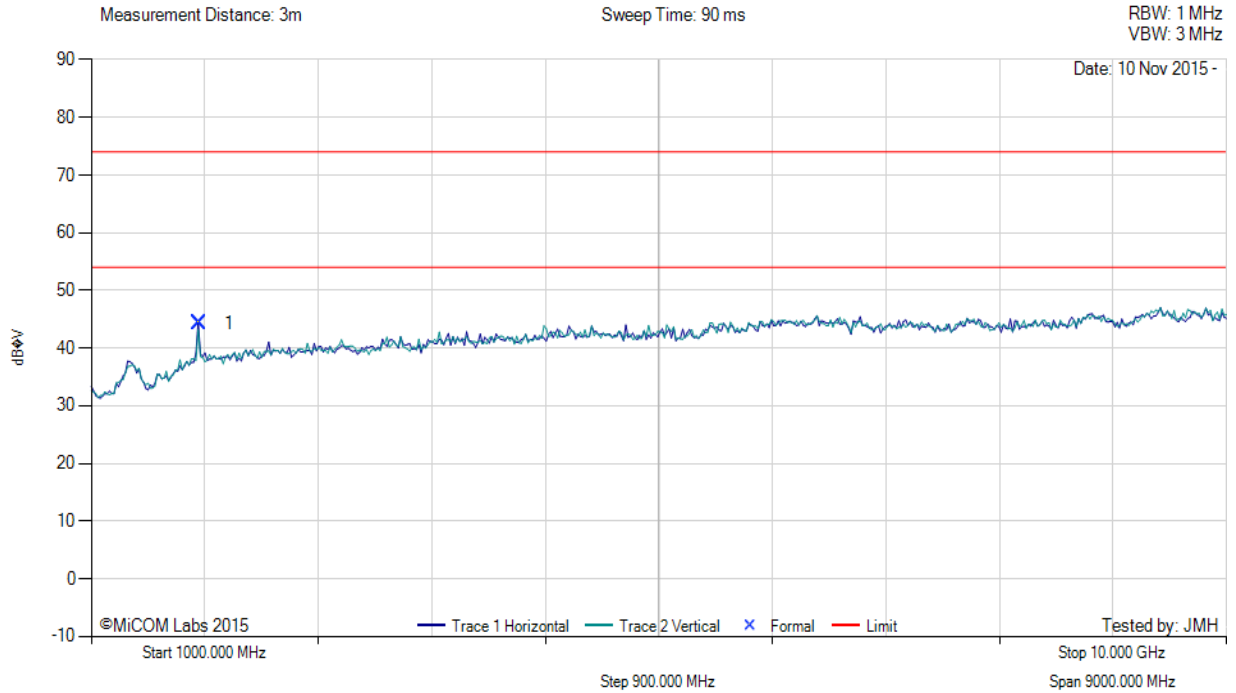

Num	Frequency MHz	Raw dBµV	Cable Loss	AF dB	Level dBµV/m	Measurement Type	Pol	Hgt cm	Azt Deg	Limit dBµV/m	Margin dB	Pass /Fail
1	1853.78	55.23	2.48	-13.43	44.28	Peak (NRB)	Horizontal	101	283	--	--	Pass

Test Notes: Test Notes: EUT on table at 150cm powered by DC PS 4V

This test report may be reproduced in full only. The document may only be updated by MiCOM Labs personnel. All changes will be noted in the Document History section of the report.



Title: Silver Spring Networks NIC 511-0303
To: FCC CFR 47 Part 15 Subpart C 15.247 & IC RSS 247
Serial #: SSNT108-U8 Rev A
Issue Date: 11th December 2015
Page: 89 of 204

External Wrap Around Antenna – WPANT40010-C



Variant: FSK, Test Freq: 902.30 MHz, Antenna: WP-WPANT40010-C, Power Setting: 30 dBm, Duty Cycle (%): 100

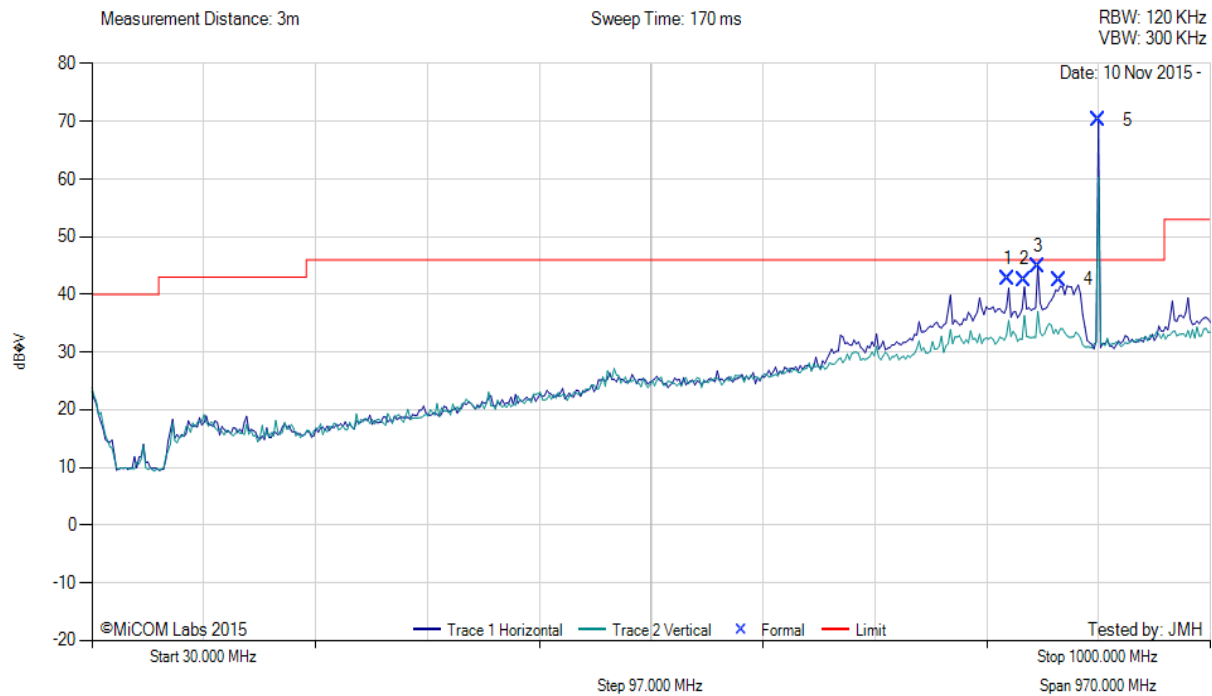

Num	Frequency MHz	Raw dBμV	Cable Loss	AF dB	Level dBμV/m	Measurement Type	Pol	Hgt cm	Azt Deg	Limit dBμV/m	Margin dB	Pass /Fail
1	824.29	44.80	6.17	-8.35	42.62	Peak (NRB)	Horizontal	201	0	--	--	Pass
2	838.32	44.88	6.20	-8.49	42.59	Peak (NRB)	Horizontal	201	0	--	--	Pass
3	850.28	46.92	6.26	-8.29	44.89	Peak (NRB)	Horizontal	201	0	--	--	Pass
4	868.48	44.47	6.26	-8.18	42.55	Peak (NRB)	Horizontal	201	0	--	--	Pass
5	902.27	71.74	6.34	-7.79	70.29	Fundamental	Horizontal	201	0	--	--	

Test Notes: EUT on table at 80cm powered by DC PS 4V

This test report may be reproduced in full only. The document may only be updated by MiCOM Labs personnel. All changes will be noted in the Document History section of the report.



Title: Silver Spring Networks NIC 511-0303
To: FCC CFR 47 Part 15 Subpart C 15.247 & IC RSS 247
Serial #: SSNT108-U8 Rev A
Issue Date: 11th December 2015
Page: 90 of 204



Variant: FSK, Test Freq: 915.20 MHz, Antenna: WP-WPANT40010-C, Power Setting: 30 dBm, Duty Cycle (%): 100

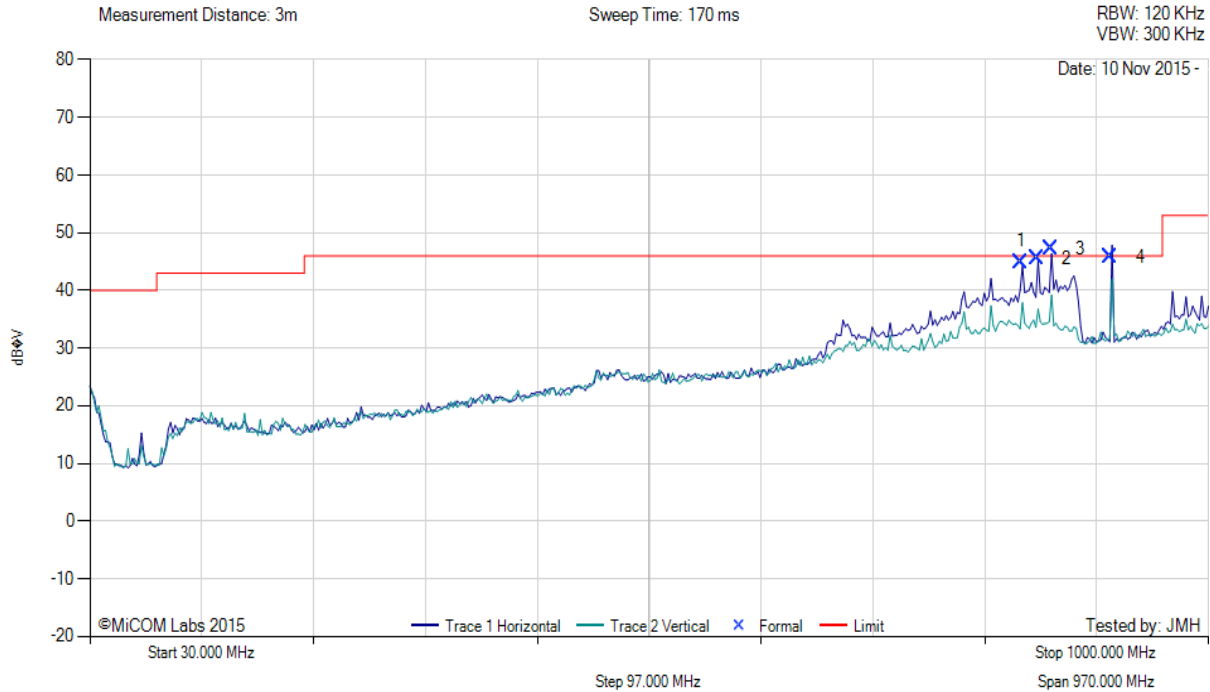

Num	Frequency MHz	Raw dBµV	Cable Loss	AF dB	Level dBµV/m	Measurement Type	Pol	Hgt cm	Azt Deg	Limit dBµV/m	Margin dB	Pass /Fail
1	837.18	47.22	6.20	-8.48	44.94	Peak (NRB)	Horizontal	201	1	--	--	Pass
2	851.21	47.63	6.26	-8.29	45.60	Peak (NRB)	Horizontal	201	1	--	--	Pass
3	863.17	49.11	6.25	-8.19	47.17	Peak (NRB)	Horizontal	201	1	--	--	Pass
4	915.17	47.23	6.39	-7.75	45.87	Fundamental	Horizontal	100	1	--	--	

Test Notes: EUT on table at 80cm powered by DC PS 4V

This test report may be reproduced in full only. The document may only be updated by MiCOM Labs personnel. All changes will be noted in the Document History section of the report.



Title: Silver Spring Networks NIC 511-0303
To: FCC CFR 47 Part 15 Subpart C 15.247 & IC RSS 247
Serial #: SSNT108-U8 Rev A
Issue Date: 11th December 2015
Page: 91 of 204



Variant: FSK, Test Freq: 926.90 MHz, Antenna: WP-WPANT40010-C, Power Setting: 30 dBm, Duty Cycle (%): 100

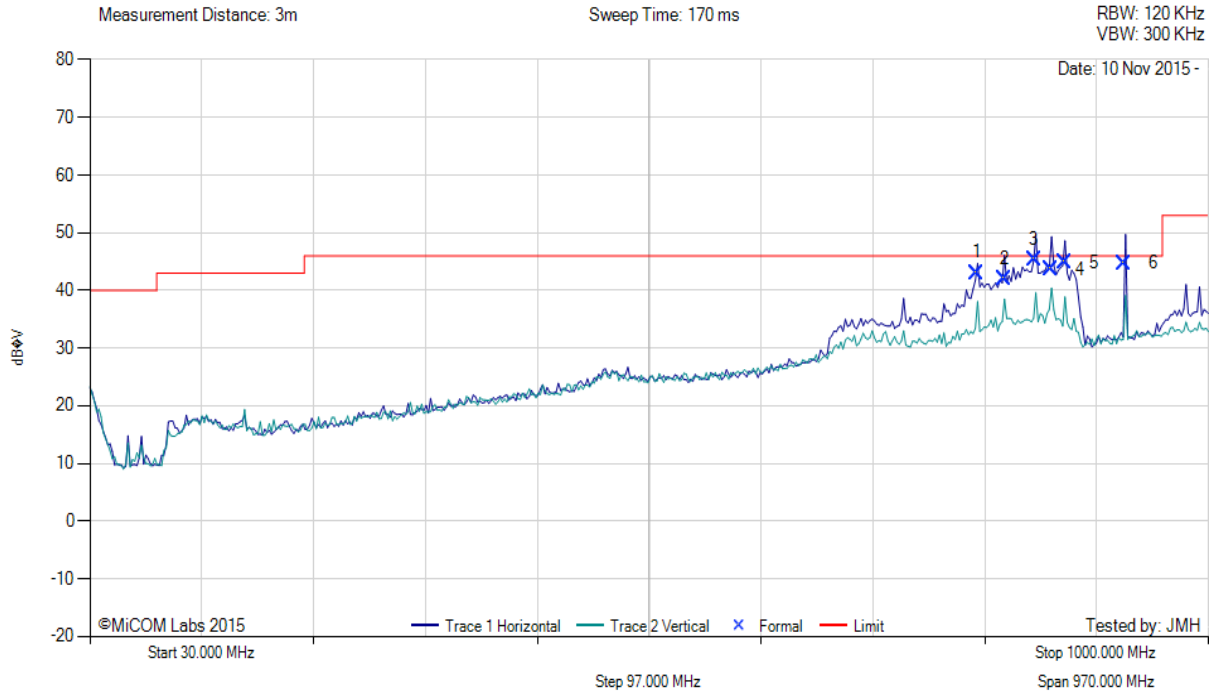

Num	Frequency MHz	Raw dBµV	Cable Loss	AF dB	Level dBµV/m	Measurement Type	Pol	Hgt cm	Azt Deg	Limit dBµV/m	Margin dB	Pass /Fail
1	798.86	45.90	6.08	-8.91	43.07	Peak (NRB)	Horizontal	100	1	--	--	Pass
2	822.83	44.23	6.16	-8.39	42.00	Peak (NRB)	Horizontal	100	1	--	--	Pass
3	848.90	47.36	6.26	-8.31	45.31	Peak (NRB)	Horizontal	100	1	--	--	Pass
4	862.93	45.64	6.25	-8.19	43.70	Peak (NRB)	Horizontal	100	1	--	--	Pass
5	874.87	46.68	6.27	-8.09	44.86	Peak (NRB)	Horizontal	100	1	--	--	Pass
6	926.91	45.84	6.43	-7.51	44.76	Fundamental	Horizontal	100	1	--	--	

Test Notes: EUT on table at 80cm powered by DC PS 4V

This test report may be reproduced in full only. The document may only be updated by MiCOM Labs personnel. All changes will be noted in the Document History section of the report.



Title: Silver Spring Networks NIC 511-0303
To: FCC CFR 47 Part 15 Subpart C 15.247 & IC RSS 247
Serial #: SSNT108-U8 Rev A
Issue Date: 11th December 2015
Page: 92 of 204



Variant: FSK, Test Freq: 902.30 MHz, Antenna: WP-WPANT40010-C, Power Setting: 30 dBm, Duty Cycle (%): 100

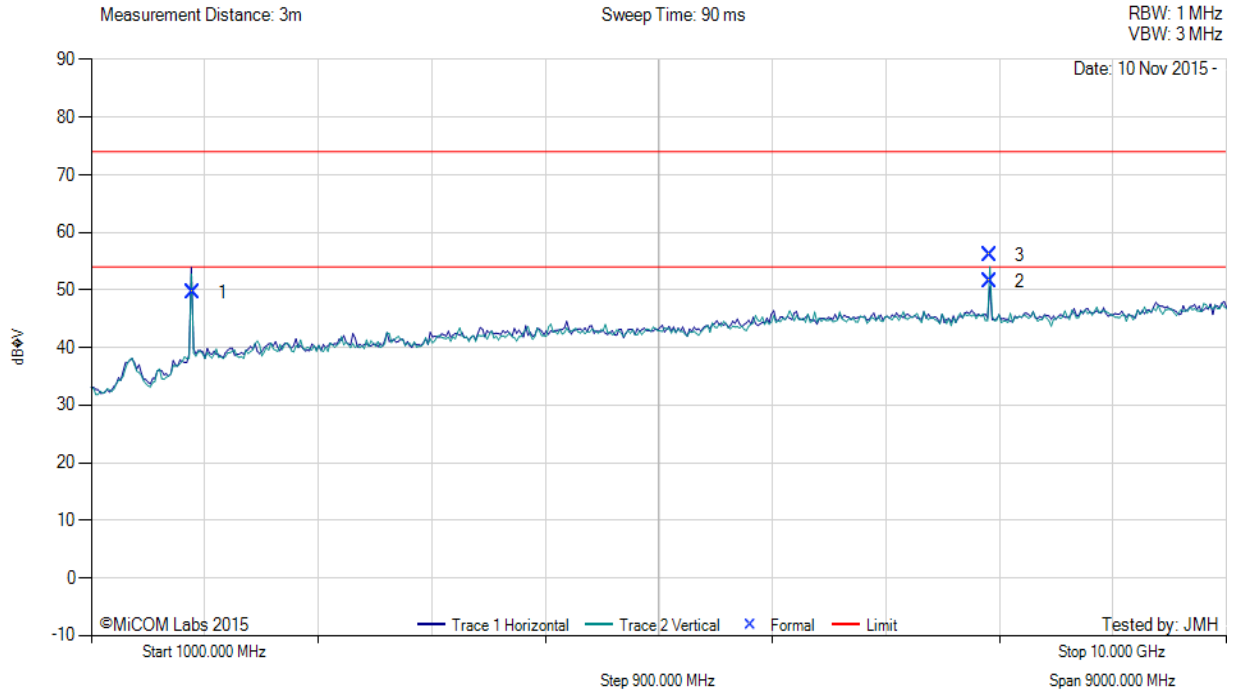

Num	Frequency MHz	Raw dBµV	Cable Loss	AF dB	Level dBµV/m	Measurement Type	Pol	Hgt cm	Azt Deg	Limit dBµV/m	Margin dB	Pass /Fail
1	1804.61	60.72	2.45	-13.63	49.54	Peak (NRB)	Horizontal	151	89	--	--	Pass
2	8120.79	54.16	4.67	-7.31	51.52	Max Avg	Vertical	196	81	54.0	-2.5	Pass
3	8120.79	58.65	4.67	-7.31	56.01	Max Peak	Vertical	196	81	74.0	-18.0	Pass

Test Notes: EUT on table at 150cm powered by DC PS 4V

This test report may be reproduced in full only. The document may only be updated by MiCOM Labs personnel. All changes will be noted in the Document History section of the report.



Title: Silver Spring Networks NIC 511-0303
To: FCC CFR 47 Part 15 Subpart C 15.247 & IC RSS 247
Serial #: SSNT108-U8 Rev A
Issue Date: 11th December 2015
Page: 93 of 204



Variant: FSK, Test Freq: 915.20 MHz, Antenna: WP-WPANT40010-C, Power Setting: 30 dBm, Duty Cycle (%): 100

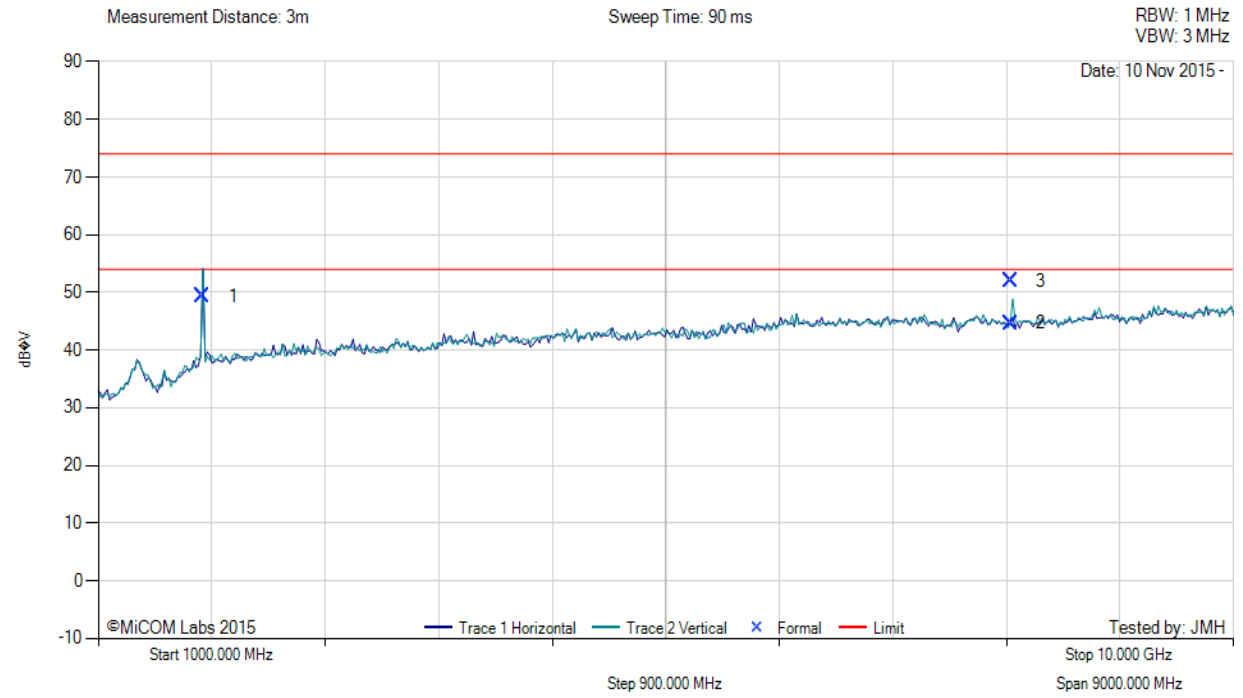

Num	Frequency MHz	Raw dBµV	Cable Loss	AF dB	Level dBµV/m	Measurement Type	Pol	Hgt cm	Azt Deg	Limit dBµV/m	Margin dB	Pass /Fail
1	1830.41	60.36	2.45	-13.54	49.27	Peak (NRB)	Vertical	200	1	--	--	Pass
2	8236.84	47.35	4.55	-7.23	44.67	Max Avg	Vertical	158	90	54.0	-9.3	Pass
3	8236.84	54.68	4.55	-7.23	52.00	Max Peak	Vertical	158	90	74.0	-22.0	Pass

Test Notes: EUT on table at 150cm powered by DC PS 4V

This test report may be reproduced in full only. The document may only be updated by MiCOM Labs personnel. All changes will be noted in the Document History section of the report.



Title: Silver Spring Networks NIC 511-0303
To: FCC CFR 47 Part 15 Subpart C 15.247 & IC RSS 247
Serial #: SSNT108-U8 Rev A
Issue Date: 11th December 2015
Page: 94 of 204



Variant: FSK, Test Freq: 926.90 MHz, Antenna: WP-WPANT40010-C, Power Setting: 30 dBm, Duty Cycle (%): 100

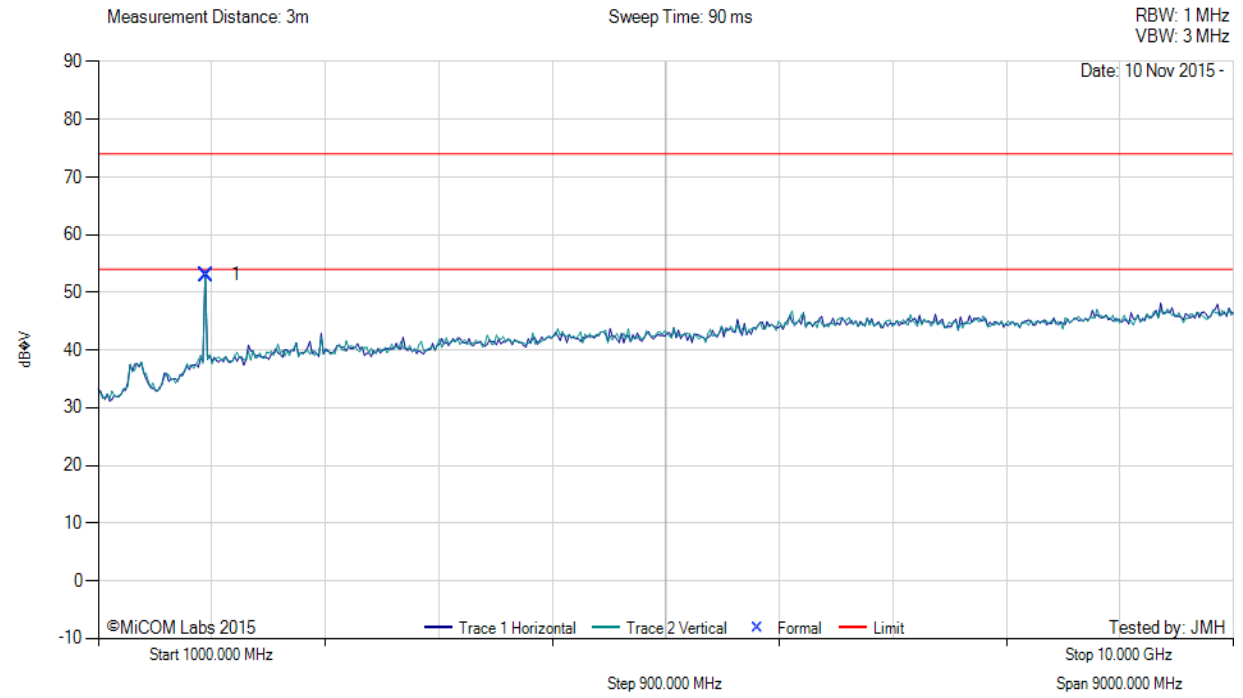

Num	Frequency MHz	Raw dBµV	Cable Loss	AF dB	Level dBµV/m	Measurement Type	Pol	Hgt cm	Azt Deg	Limit dBµV/m	Margin dB	Pass /Fail
1	1853.88	63.96	2.48	-13.43	53.01	Peak (NRB)	Horizontal	101	0	--	--	Pass

Test Notes: EUT on table at 150cm powered by DC PS 4V

This test report may be reproduced in full only. The document may only be updated by MiCOM Labs personnel. All changes will be noted in the Document History section of the report.



Title: Silver Spring Networks NIC 511-0303
To: FCC CFR 47 Part 15 Subpart C 15.247 & IC RSS 247
Serial #: SSNT108-U8 Rev A
Issue Date: 11th December 2015
Page: 95 of 204

External Monopole WPANT30017-CA



Variant: FSK, Test Freq: 902.3 MHz, Antenna: WP-WPANT30017-CA, Power Setting: 30 dBm, Duty Cycle (%): 100

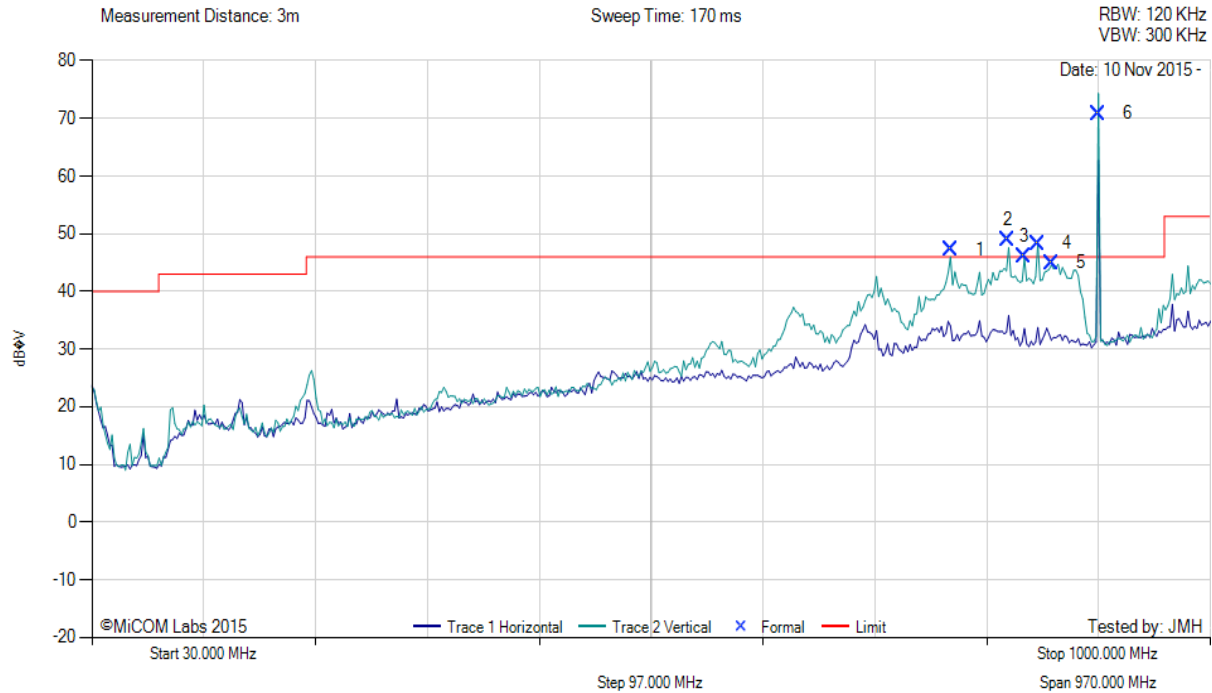

Num	Frequency MHz	Raw dBµV	Cable Loss	AF dB	Level dBµV/m	Measurement Type	Pol	Hgt cm	Azt Deg	Limit dBµV/m	Margin dB	Pass /Fail
1	774.31	50.33	6.05	-9.20	47.18	Peak (NRB)	Vertical	201	1	--	--	Pass
2	824.27	51.10	6.17	-8.35	48.92	Peak (NRB)	Vertical	201	1	--	--	Pass
3	838.30	48.39	6.20	-8.49	46.10	Peak (NRB)	Vertical	201	1	--	--	Pass
4	850.28	50.30	6.26	-8.29	48.27	Peak (NRB)	Vertical	201	1	--	--	Pass
5	861.99	46.87	6.25	-8.19	44.93	Peak (NRB)	Vertical	201	1	--	--	Pass
6	902.28	72.25	6.34	-7.79	70.80	Fundamental	Vertical	201	1	--	--	

Test Notes: EUT on table at 80cm powered by DC PS 4V

This test report may be reproduced in full only. The document may only be updated by MiCOM Labs personnel. All changes will be noted in the Document History section of the report.



Title: Silver Spring Networks NIC 511-0303
To: FCC CFR 47 Part 15 Subpart C 15.247 & IC RSS 247
Serial #: SSNT108-U8 Rev A
Issue Date: 11th December 2015
Page: 96 of 204



Variant: FSK, Test Freq: 915.20 MHz, Antenna: WP-WPANT30017-CA, Power Setting: 30 dBm, Duty Cycle (%): 100

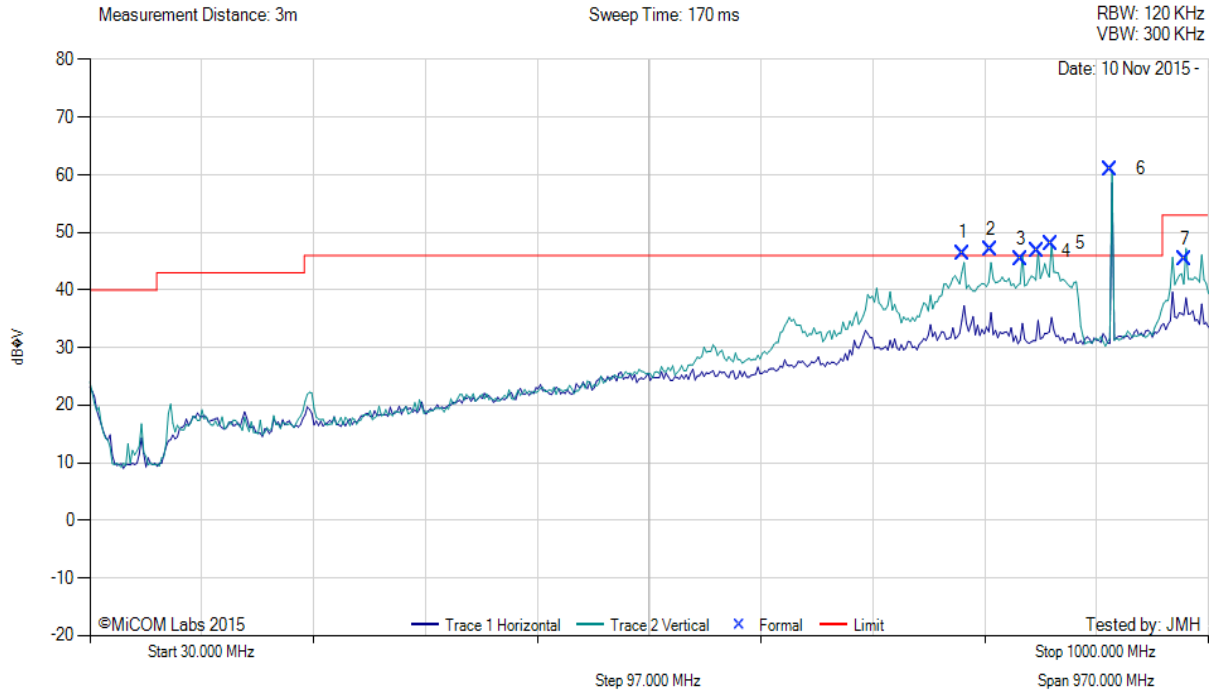

Num	Frequency MHz	Raw dBμV	Cable Loss	AF dB	Level dBμV/m	Measurement Type	Pol	Hgt cm	Azt Deg	Limit dBμV/m	Margin dB	Pass /Fail
1	787.20	49.37	6.06	-9.06	46.37	Peak (NRB)	Vertical	100	1	--	--	Pass
2	811.21	49.63	6.12	-8.70	47.05	Peak (NRB)	Vertical	201	1	--	--	Pass
3	837.23	47.59	6.20	-8.48	45.31	Peak (NRB)	Vertical	201	1	--	--	Pass
4	851.15	48.80	6.26	-8.29	46.77	Peak (NRB)	Vertical	201	1	--	--	Pass
5	863.20	49.99	6.25	-8.19	48.05	Peak (NRB)	Vertical	201	1	--	--	Pass
6	915.16	62.37	6.39	-7.75	61.01	Fundamental	Vertical	100	1	--	--	
7	979.20	45.74	6.54	-6.93	45.35	MaxQP	Vertical	100	2	53.0	-7.7	Pass

Test Notes: EUT on table at 80cm powered by DC PS 4V

This test report may be reproduced in full only. The document may only be updated by MiCOM Labs personnel. All changes will be noted in the Document History section of the report.



Title: Silver Spring Networks NIC 511-0303
To: FCC CFR 47 Part 15 Subpart C 15.247 & IC RSS 247
Serial #: SSNT108-U8 Rev A
Issue Date: 11th December 2015
Page: 97 of 204



Variant: FSK, Test Freq: 926.90 MHz, Antenna: WP-WPANT30017-CA, Power Setting: 30 dBm, Duty Cycle (%): 100

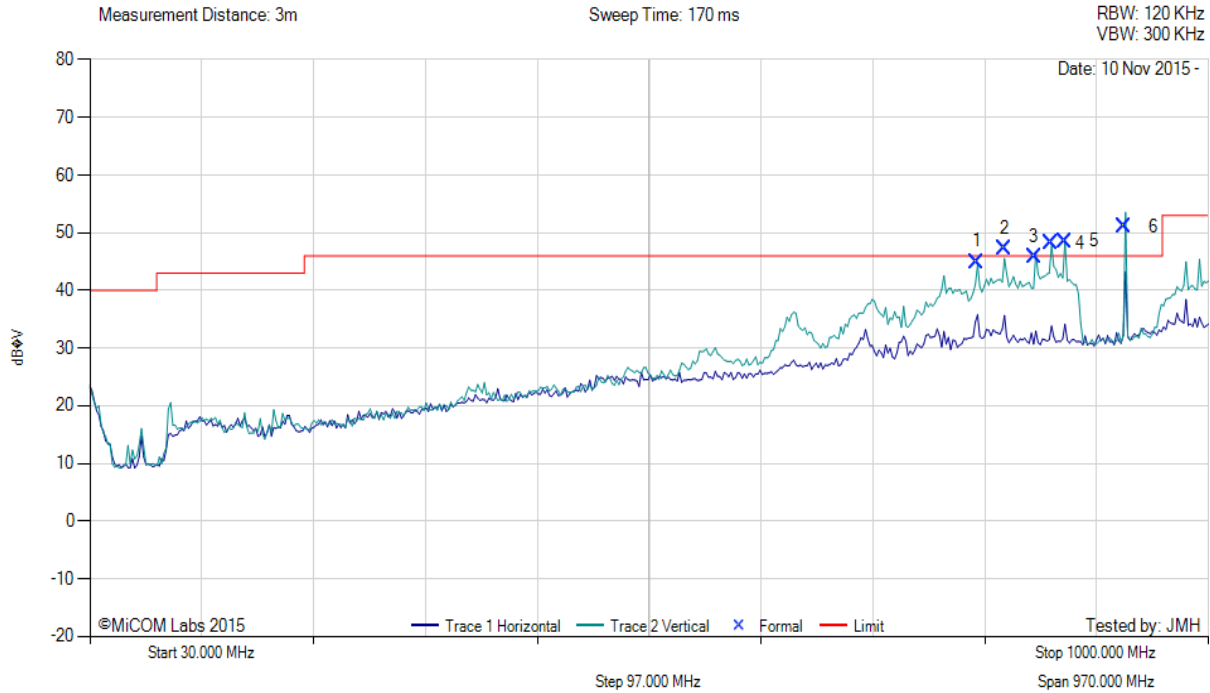

Num	Frequency MHz	Raw dBµV	Cable Loss	AF dB	Level dBµV/m	Measurement Type	Pol	Hgt cm	Azt Deg	Limit dBµV/m	Margin dB	Pass /Fail
1	798.92	47.81	6.08	-8.91	44.98	Peak (NRB)	Vertical	201	0	--	--	Pass
2	822.90	49.51	6.16	-8.39	47.28	Peak (NRB)	Vertical	201	0	--	--	Pass
3	848.90	47.81	6.26	-8.31	45.76	Peak (NRB)	Vertical	201	0	--	--	Pass
4	862.85	50.14	6.25	-8.19	48.20	Peak (NRB)	Vertical	100	0	--	--	Pass
5	874.95	50.35	6.27	-8.09	48.53	Peak (NRB)	Vertical	100	0	--	--	Pass
6	926.91	52.12	6.43	-7.51	51.04	Fundamental	Vertical	201	0	--	--	

Test Notes: EUT on table at 80cm powered by DC PS 4V

This test report may be reproduced in full only. The document may only be updated by MiCOM Labs personnel. All changes will be noted in the Document History section of the report.



Title: Silver Spring Networks NIC 511-0303
To: FCC CFR 47 Part 15 Subpart C 15.247 & IC RSS 247
Serial #: SSNT108-U8 Rev A
Issue Date: 11th December 2015
Page: 98 of 204



Variant: FSK, Test Freq: 902.30 MHz, Antenna: WP-WPANT30017-CA, Power Setting: 30 dBm, Duty Cycle (%): 100

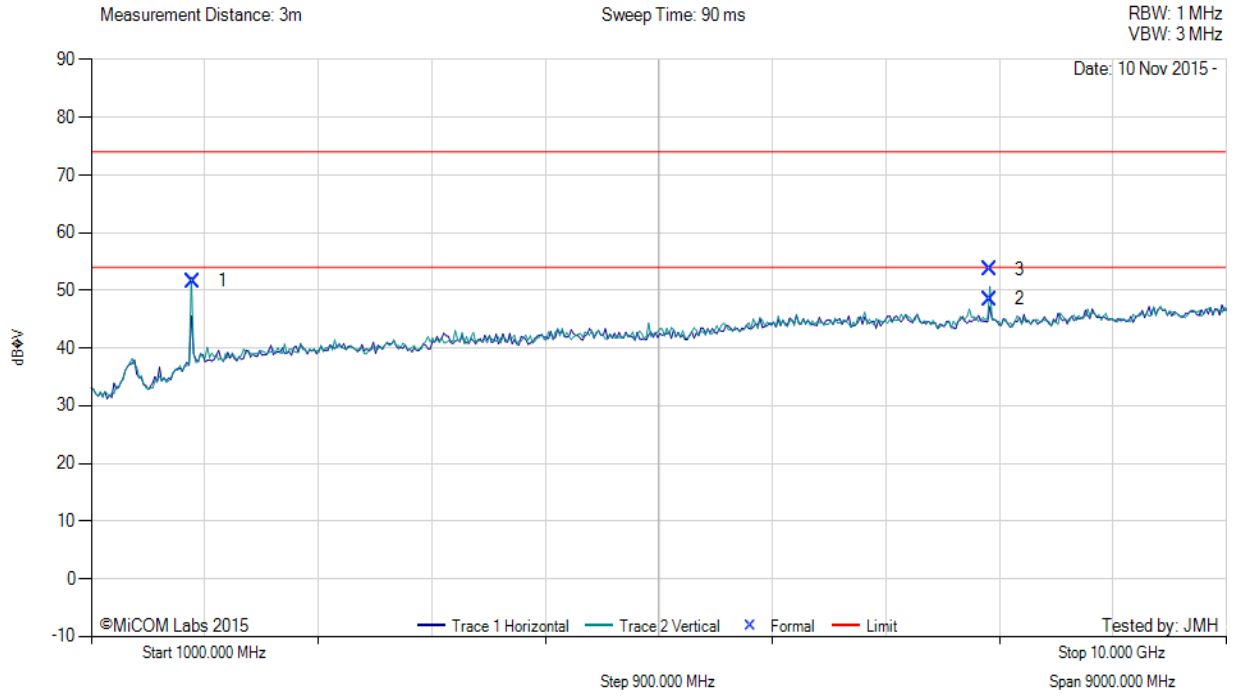

Num	Frequency MHz	Raw dBµV	Cable Loss	AF dB	Level dBµV/m	Measurement Type	Pol	Hgt cm	Azt Deg	Limit dBµV/m	Margin dB	Pass /Fail
1	1804.62	62.81	2.45	-13.63	51.63	Peak (NRB)	Vertical	151	1	--	--	Pass
2	8120.70	51.15	4.67	-7.31	48.51	Max Avg	Vertical	185	111	54.0	-5.5	Pass
3	8120.70	56.32	4.67	-7.31	53.68	Max Peak	Vertical	185	111	74.0	-20.3	Pass

Test Notes: EUT on table at 150cm powered by DC PS 4V

This test report may be reproduced in full only. The document may only be updated by MiCOM Labs personnel. All changes will be noted in the Document History section of the report.



Title: Silver Spring Networks NIC 511-0303
To: FCC CFR 47 Part 15 Subpart C 15.247 & IC RSS 247
Serial #: SSNT108-U8 Rev A
Issue Date: 11th December 2015
Page: 99 of 204



Variant: FSK, Test Freq: 915.20 MHz, Antenna: WP-WPANT30017-CA, Power Setting: 30 dBm, Duty Cycle (%): 100

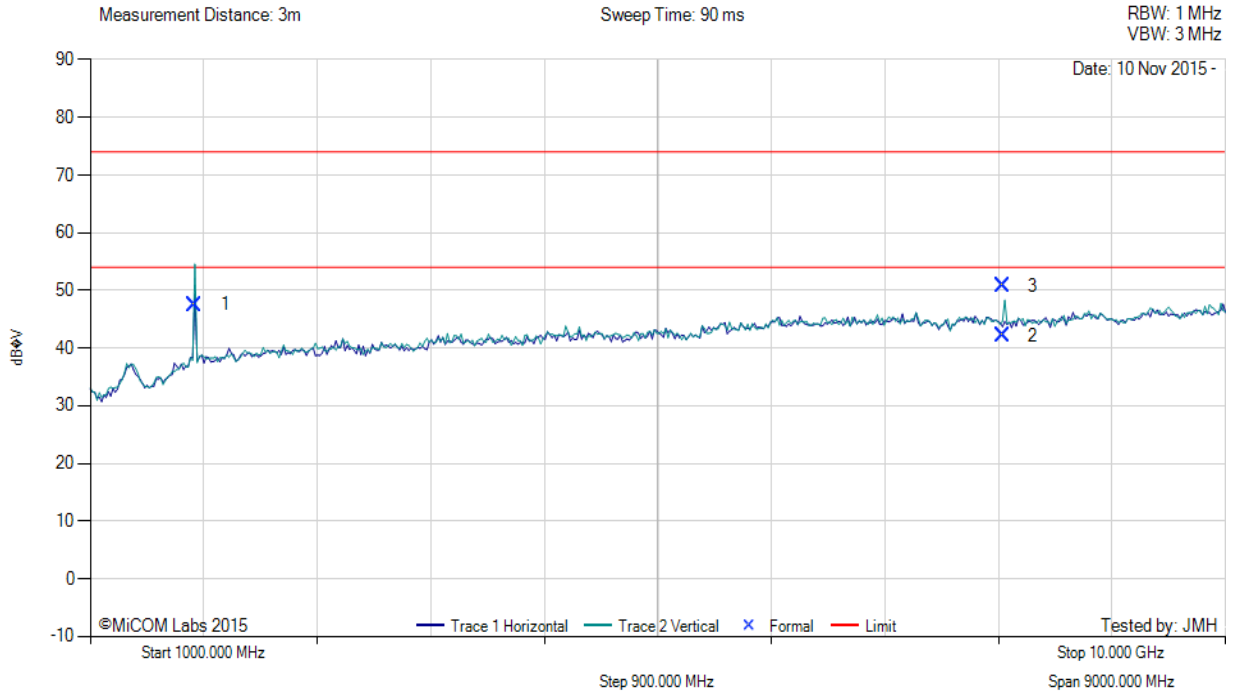

Num	Frequency MHz	Raw dBµV	Cable Loss	AF dB	Level dBµV/m	Measurement Type	Pol	Hgt cm	Azt Deg	Limit dBµV/m	Margin dB	Pass /Fail
1	1830.41	58.58	2.45	-13.54	47.49	Peak (NRB)	Vertical	200	1	--	--	Pass
2	8236.93	44.76	4.55	-7.23	42.08	Max Avg	Vertical	169	122	54.0	-11.9	Pass
3	8236.93	53.48	4.55	-7.23	50.80	Max Peak	Vertical	169	122	74.0	-23.2	Pass

Test Notes: Test Notes: EUT on table at 150cm powered by DC PS 4V

This test report may be reproduced in full only. The document may only be updated by MiCOM Labs personnel. All changes will be noted in the Document History section of the report.



Title: Silver Spring Networks NIC 511-0303
To: FCC CFR 47 Part 15 Subpart C 15.247 & IC RSS 247
Serial #: SSNT108-U8 Rev A
Issue Date: 11th December 2015
Page: 100 of 204



Variant: FSK, Test Freq: 926.90 MHz, Antenna: WP-WPANT30017-CA, Power Setting: 30 dBm, Duty Cycle (%): 100

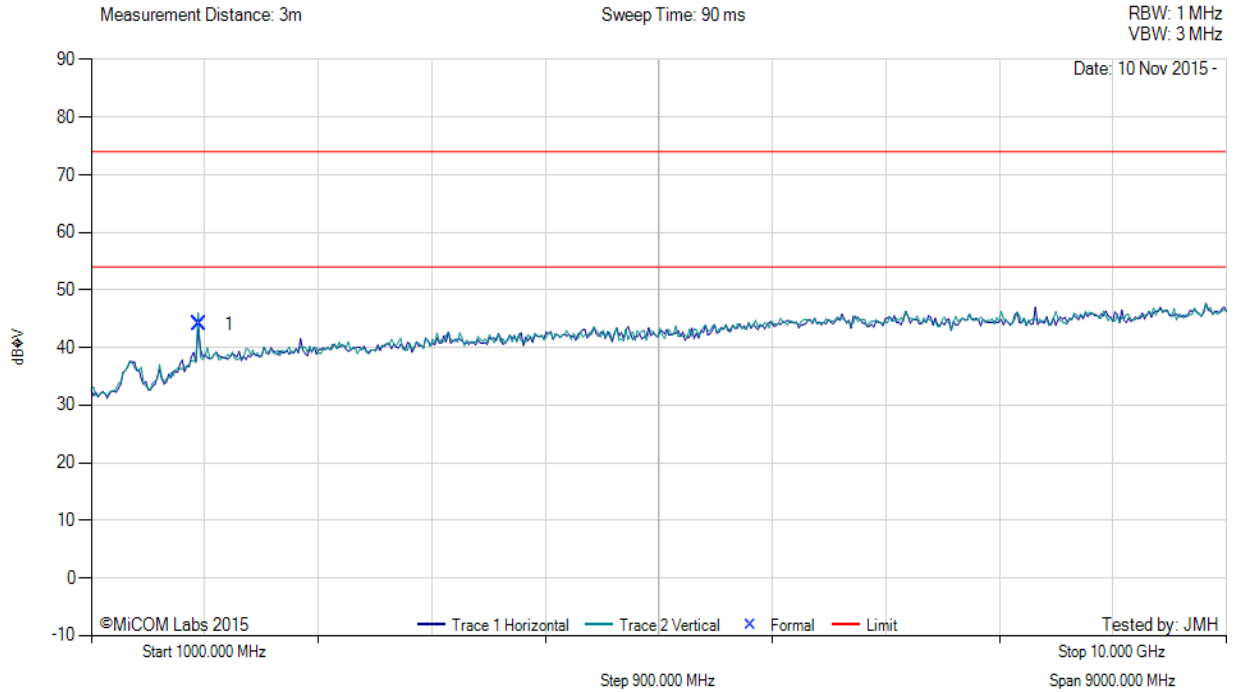

Num	Frequency MHz	Raw dBµV	Cable Loss	AF dB	Level dBµV/m	Measurement Type	Pol	Hgt cm	Azt Deg	Limit dBµV/m	Margin dB	Pass /Fail
1	1853.85	54.95	2.48	-13.43	44.00	Peak (NRB)	Vertical	100	0	--	--	Pass

Test Notes: Test Notes: Test Notes: EUT on table at 150cm powered by DC PS 4V

This test report may be reproduced in full only. The document may only be updated by MiCOM Labs personnel. All changes will be noted in the Document History section of the report.



9.7.5. Digital Emissions (0.03 - 1 GHz)

FCC, Part 15 Subpart C §15.205/ §15.209
Industry Canada RSS-Gen §8.9

Test Procedure

Testing 30M-1 GHz was performed in a 3-meter anechoic chamber using a CISPR compliant receiver. Preliminary radiated emissions were measured on every azimuth and with the receiving antenna in both horizontal and vertical polarizations. To further maximize emissions the receive antenna was varied between 1 and 4 meters. The emissions are recorded with receiver in peak hold mode. Emissions closest to the limits are measured in the quasi-peak mode with the tuned receiver using a bandwidth of 120 kHz. Only the highest emissions relative to the limit are listed. The anechoic chamber test set-up is identified in Section 6 Test Set-Up Photographs.

The EUT had two methods of powering on ac/dc converter and Power over Ethernet (POE). Both modes were tested for emissions below 1GHz.

Field Strength Calculation

The field strength is calculated by adding the Antenna Factor and Cable Loss, and subtracting Amplifier Gain from the measured reading. In this test facility, the Antenna Factor, Cable Loss, and Amplifier Gains are loaded into the Rohde & Schwarz Receiver and the corrected field strength can be read directly on the receiver.

$$FS = R + AF + CORR$$

where:

FS = Field Strength
R = Measured Receiver Input Amplitude
AF = Antenna Factor
CORR = Correction Factor = CL – AG + NFL
CL = Cable Loss
AG = Amplifier Gain

For example:

Given a Receiver input reading of 51.5dB μ V; Antenna Factor of 8.5dB; Cable Loss of 1.3dB; Falloff Factor of 0dB, an Amplifier Gain of 26dB and Notch Filter Loss of 1dB. The Field Strength of the measured emission is:

$$FS = 51.5 + 8.5 + 1.3 - 26.0 + 1 = 36.3\text{dB}\mu\text{V/m}$$

Conversion between dB μ V/m (or dB μ V) and μ V/m (or μ V) are done as:

$$\text{Level (dB}\mu\text{V/m)} = 20 * \text{Log (level (\mu\text{V/m}))}$$

$$40 \text{ dB}\mu\text{V/m} = 100\mu\text{V/m}$$

$$48 \text{ dB}\mu\text{V/m} = 250\mu\text{V/m}$$



Title: Silver Spring Networks NIC 511-0303
To: FCC CFR 47 Part 15 Subpart C 15.247 & IC RSS 247
Serial #: SSNT108-U8 Rev A
Issue Date: 11th December 2015
Page: 102 of 204



Variant: NA, Test Freq: 0.00 MHz, Antenna: Integral, Power Setting: NA, Duty Cycle (%): NA

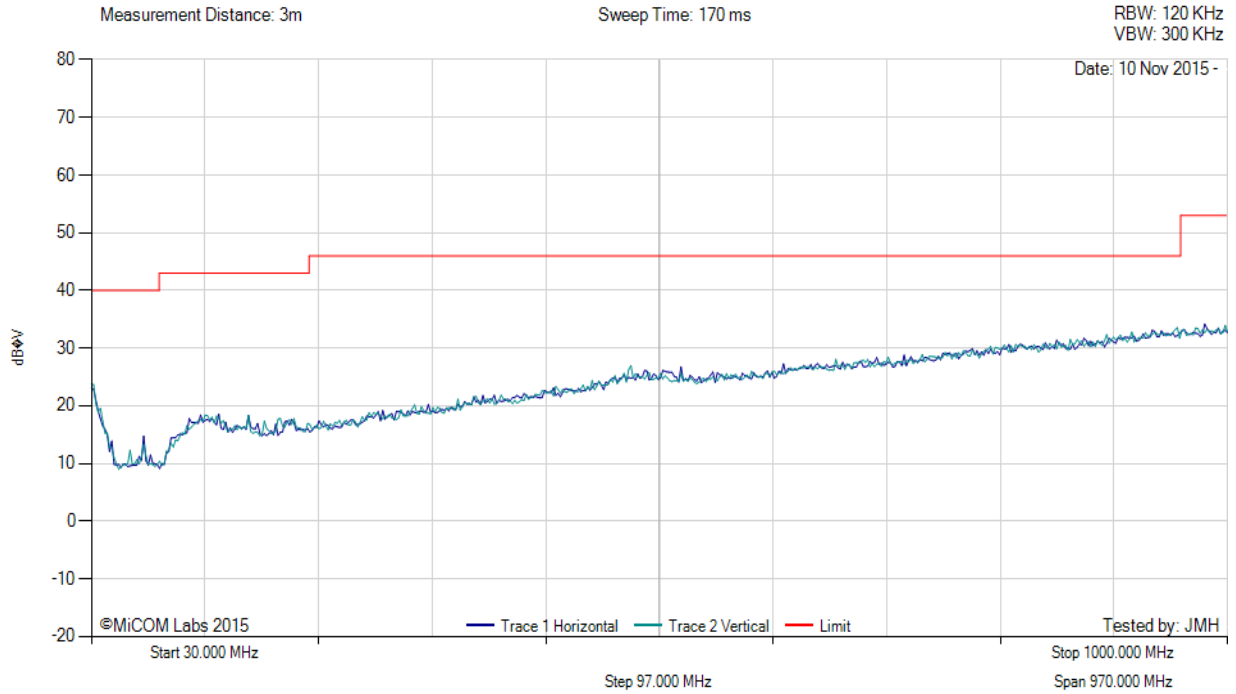

There are no emissions found within 6dB of the limit line.

Test Notes: EUT on Table at 80cm, powered by DC PS 4V, RCV Mode Integral antenna

This test report may be reproduced in full only. The document may only be updated by MiCOM Labs personnel. All changes will be noted in the Document History section of the report.

9.8. AC Wireline Conducted Emissions (150 kHz – 30 MHz)

NOTE: Test not applicable EUT is dc powered

FCC, Part 15 Subpart C §15.207
Industry Canada RSS-Gen §8.8

Test Procedure

The EUT is configured in accordance with ANSI C63.4. The conducted emissions are measured in a shielded room with a spectrum analyzer in peak hold in the first instance. Emissions closest to the limit are measured in the quasi-peak mode (QP) with the tuned receiver using a bandwidth of 9 kHz. The emissions are maximized further by cable manipulation. The highest emissions relative to the limit are listed.

Test Measurement Set up

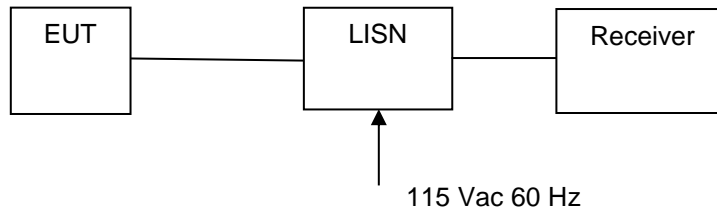

Measurement Results for AC Wireline Conducted Emissions (150 kHz – 30 MHz)



Specification

Limit

§15.207 (a) Except as shown in paragraphs (b) and (c) of this section, for an intentional radiator that is designed to be connected to the public utility (AC) power line, the radio frequency voltage that is conducted back onto the AC power line on any frequency or frequencies within the band 150 kHz to 30 MHz shall not exceed the limits in the following table, as measured using a 50 $\mu\Omega$ line impedance stabilization network (LISN), see §15.207 (a) matrix below. Compliance with the provisions of this paragraph shall be based on the measurement of the radio frequency voltage between each power line and ground at the power terminal. The lower limit applies at the boundary between the frequency ranges.

RSS-Gen §8.8

A radio apparatus that is designed to be connected to the public utility (AC) power line shall ensure that the radio frequency voltage, which is conducted back onto the AC power line on any frequency or frequencies within the band 150 kHz-30 MHz, shall not exceed the limits in Table 3.

§15.207 (a) and RSS-Gen §8.8 Limit Matrix

The lower limit applies at the boundary between frequency ranges

Frequency of Emission (MHz)	Conducted Limit (dB μ V)	
	Quasi-peak	Average
0.15-0.5	66 to 56*	56 to 46*
0.5-5	56	46
5-30	60	50

* Decreases with the logarithm of the frequency

Laboratory Measurement Uncertainty for Conducted Emissions

Measurement uncertainty	± 2.64 dB
-------------------------	---------------

This test report may be reproduced in full only. The document may only be updated by MiCOM Labs personnel. All changes will be noted in the Document History section of the report.



9.9. Power Spectral Density

Conducted Test Conditions for Power Spectral Density			
Standard:	FCC CFR 47:15.247	Ambient Temp. (°C):	24.0 - 27.5
Test Heading:	Power Spectral Density	Rel. Humidity (%):	32 - 45
Standard Section(s):	15.247 (e)	Pressure (mBars):	999 - 1001
Reference Document(s):	See Normative References		

Test Procedure for Power Spectral Density

The transmitter output was connected to a spectrum analyzer and the measured made in a 3 kHz resolution bandwidth using the analyzer auto-coupled sweep-time. A peak value was found over the full emission bandwidth and the spectrum downloaded for post processing purposes.

Where the device operated with multiple antenna ports i.e. MIMO device, each port was measured separately. The Peak Power Spectral Density is the highest level found across the emission bandwidth. With multiple antenna port measurements the numerical analyzer data from each port is summed (\hat{a}) and a link to this additional graphic is provided.

Testing was performed under ambient conditions at nominal voltage only.

Test configuration and setup used for the measurement was per the Conducted Test Set-up specified in this document.

Measure and sum the spectra across the outputs. With this technique, spectra are measured at each output of the device at the required resolution bandwidth. The individual spectra are then summed mathematically in linear power units. Unlike in-band power measurements, in which the sum involves a single measured value (output power) from each output, measurements for compliance with PSD limits involve summing entire spectra across corresponding frequency bins on the various outputs. Consistency is maintained for any device with multiple transmitter outputs to be certain the individual outputs are all aligned with the same span and same number of points. In this instance, the linear power spectrum value within the first spectral bin of output 0 is summed with that in the first spectral bin of output 1, and the first spectral bin of output 2, and so on up to the Nth output to obtain the true value for the first frequency bin of the summed spectrum. The summed spectrum value for each frequency bin is computed in this fashion. These summed spectral values were post processed and the resulting numerical and graphical data presented.

NOTE:

It may be observed that the spectrum in some antenna port plots break the limit line however this in itself does NOT constitute a failure. In all cases a spectrum summation plot is provided in order to prove compliance. A failure occurs only after the summation of all spectrum plots have been summed and are found to be greater than the limit line.

Supporting Information

Calculated Power = $A + 10 \log (1/x)$ dBm

$A = \text{Total Power Spectral Density } [10 \text{ Log}_{10} (10^{a/10} + 10^{b/10} + 10^{c/10} + 10^{d/10})]$

$x = \text{Duty Cycle}$

Limits Power Spectral Density

For digitally modulated systems, the power spectral density conducted from the intentional radiator to the antenna shall not be greater than +8 dBm in any 3 kHz band during any time interval of continuous transmission. This power spectral density shall be determined in accordance with the provisions of paragraph (b) of this section. The same method of determining the conducted output power shall be used to determine the power spectral density.



Title: Silver Spring Networks NIC 511-0303
To: FCC CFR 47 Part 15 Subpart C 15.247 & IC RSS 247
Serial #: SSNT108-U8 Rev A
Issue Date: 11th December 2015
Page: 106 of 204

9.9.1. Modulation (DTS)

Equipment Configuration for Power Spectral Density - Peak
--

Variant:	1200 OFDM	Duty Cycle (%):	99.00
Data Rate:	2400.00 Kbps	Antenna Gain (dBi):	4.50
Modulation:	DTS	Beam Forming Gain (Y)(dB):	Not Applicable
TPC:	Not Applicable	Tested By:	CC
Engineering Test Notes:			

Test Measurement Results

Test Frequency	Measured Power Spectral Density				Amplitude Summation	Limit	Margin
	Port(s) (dBm/3KHz)						
MHz	a	b	c	d	dBm/3KHz	dBm/3KHz	dB
903.2	<u>7.448</u>	--	--	--	<u>7.448</u>	8.0	-0.6
914.0	<u>7.637</u>	--	--	--	<u>7.637</u>	8.0	-0.4
926.0	<u>7.633</u>	--	--	--	<u>7.633</u>	8.0	-2.9

Traceability to Industry Recognized Test Methodologies

Work Instruction:	WI-03 MEASURING RF SPECTRUM MASK
Measurement Uncertainty:	2.81 dB

Note: click the links in the above matrix to view the graphical image (plot).

This test report may be reproduced in full only. The document may only be updated by MiCOM Labs personnel. All changes will be noted in the Document History section of the report.



Title: Silver Spring Networks NIC 511-0303
To: FCC CFR 47 Part 15 Subpart C 15.247 & IC RSS 247
Serial #: SSNT108-U8 Rev A
Issue Date: 11th December 2015
Page: 107 of 204

A. APPENDIX - GRAPHICAL IMAGES

This test report may be reproduced in full only. The document may only be updated by MiCOM Labs personnel. All changes will be noted in the Document History section of the report.



A.1. 20 dB & 99% Bandwidth

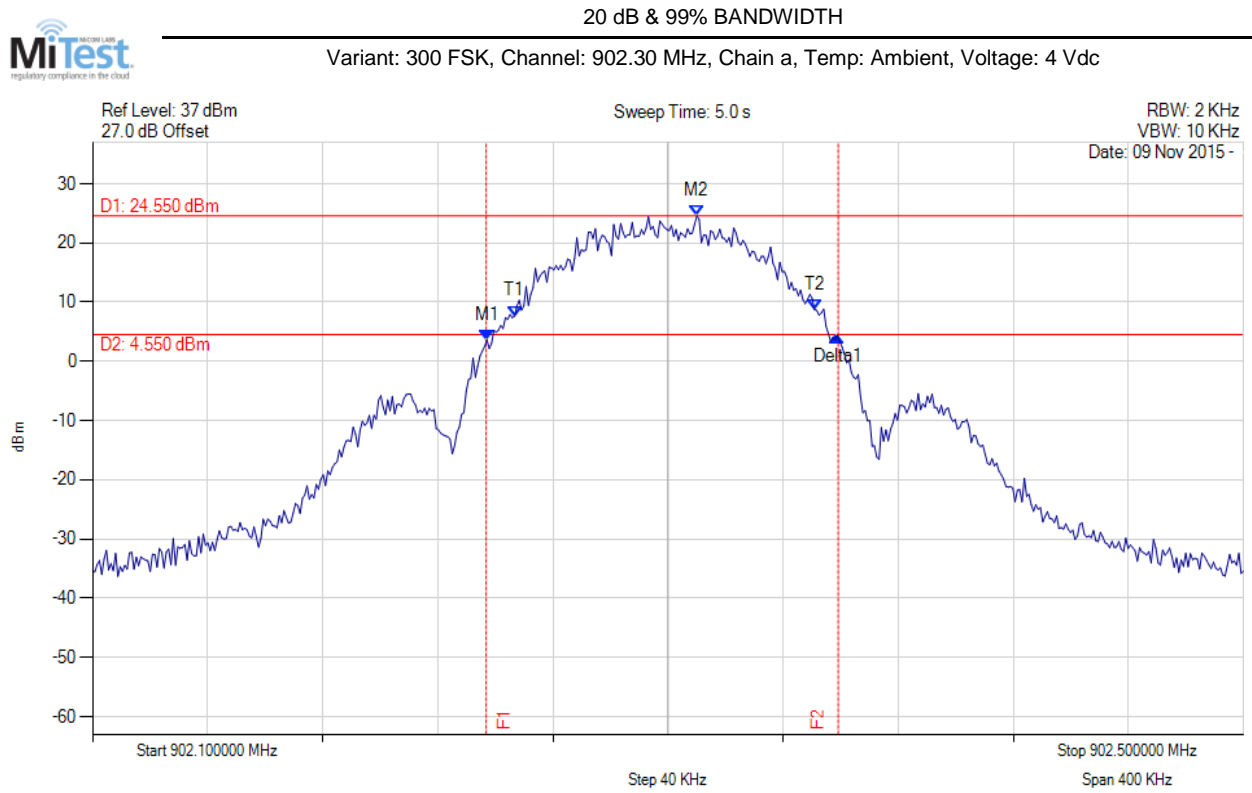

Analyser Setup	Marker:Frequency:Amplitude	Test Results
Detector = MAX PEAK Sweep Count = 0 RF Atten (dB) = 20 Trace Mode = VIEW	M1 : 902.237 MHz : 3.596 dBm M2 : 902.310 MHz : 24.547 dBm Delta1 : 122 KHz : 0.734 dB T1 : 902.247 MHz : 7.653 dBm T2 : 902.351 MHz : 8.741 dBm OBW : 104 KHz	

[back to matrix](#)

This test report may be reproduced in full only. The document may only be updated by MiCOM Labs personnel. All changes will be noted in the Document History section of the report.



20 dB & 99% BANDWIDTH



Variant: 300 FSK, Channel: 915.20 MHz, Chain a, Temp: Ambient, Voltage: 4 Vdc

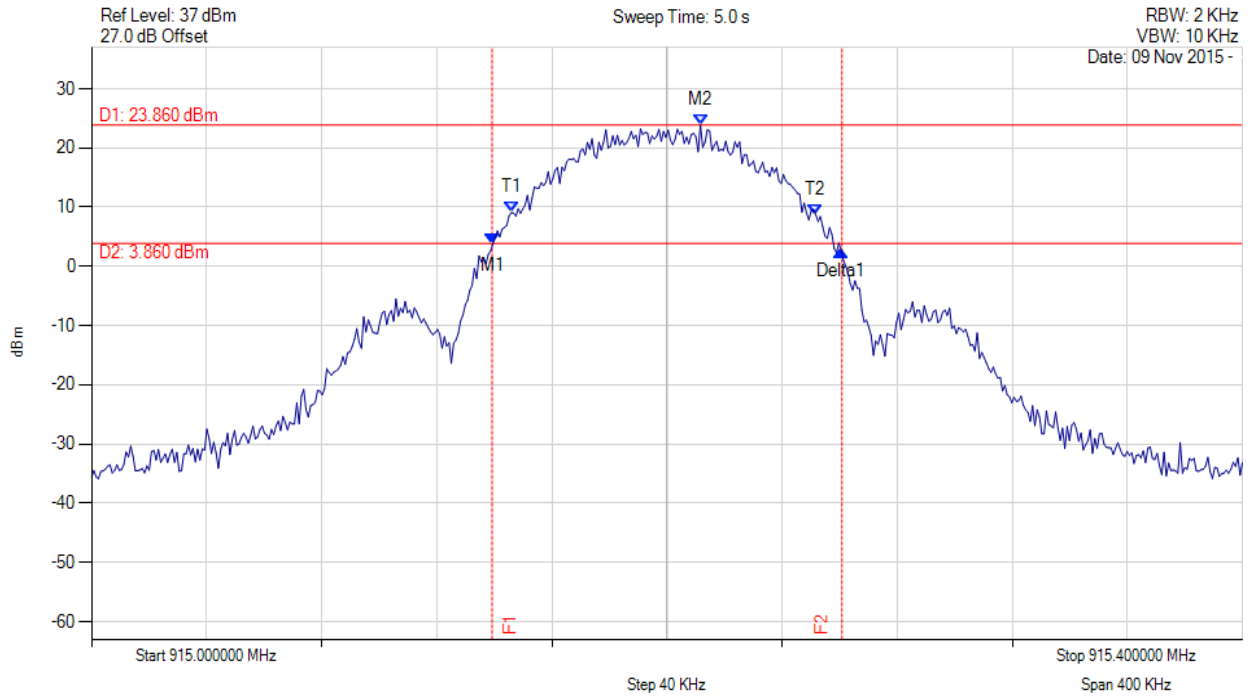

Analyser Setup	Marker:Frequency:Amplitude	Test Results
Detector = MAX PEAK Sweep Count = 0 RF Atten (dB) = 20 Trace Mode = VIEW	M1 : 915.139 MHz : 3.762 dBm M2 : 915.212 MHz : 23.858 dBm Delta1 : 121 KHz : -1.078 dB T1 : 915.146 MHz : 9.077 dBm T2 : 915.252 MHz : 8.733 dBm OBW : 106 KHz	

[back to matrix](#)

This test report may be reproduced in full only. The document may only be updated by MiCOM Labs personnel. All changes will be noted in the Document History section of the report.



Title: Silver Spring Networks NIC 511-0303
To: FCC CFR 47 Part 15 Subpart C 15.247 & IC RSS 247
Serial #: SSNT108-U8 Rev A
Issue Date: 11th December 2015
Page: 110 of 204

20 dB & 99% BANDWIDTH



Variant: 300 FSK, Channel: 926.90 MHz, Chain a, Temp: Ambient, Voltage: 4 Vdc

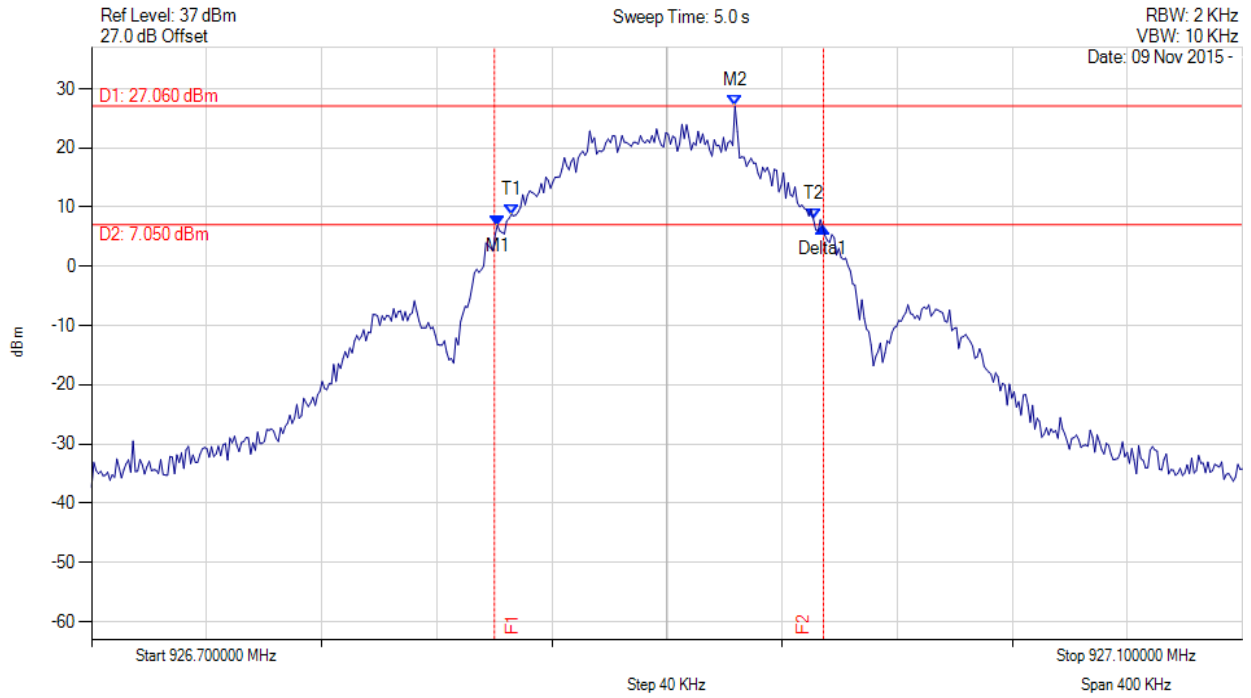

Analyser Setup	Marker:Frequency:Amplitude	Test Results
Detector = MAX PEAK Sweep Count = 0 RF Atten (dB) = 20 Trace Mode = VIEW	M1 : 926.841 MHz : 6.935 dBm M2 : 926.924 MHz : 27.053 dBm Delta1 : 113 KHz : -0.315 dB T1 : 926.846 MHz : 8.735 dBm T2 : 926.951 MHz : 7.954 dBm OBW : 105 KHz	

[back to matrix](#)

This test report may be reproduced in full only. The document may only be updated by MiCOM Labs personnel. All changes will be noted in the Document History section of the report.



Title: Silver Spring Networks NIC 511-0303
To: FCC CFR 47 Part 15 Subpart C 15.247 & IC RSS 247
Serial #: SSNT108-U8 Rev A
Issue Date: 11th December 2015
Page: 111 of 204

20 dB & 99% BANDWIDTH



Variant: 300 GFSK, Channel: 902.30 MHz, Chain a, Temp: Ambient, Voltage: 4 Vdc

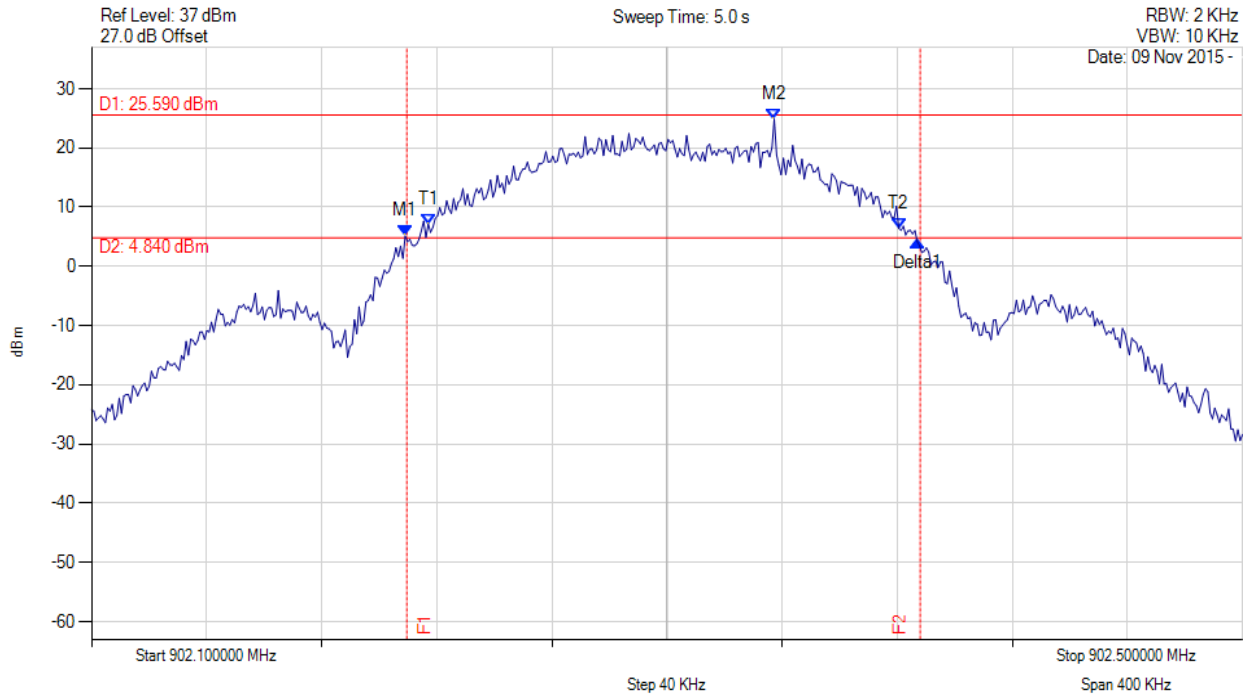

Analyser Setup	Marker:Frequency:Amplitude	Test Results
Detector = MAX PEAK Sweep Count = 0 RF Atten (dB) = 20 Trace Mode = VIEW	M1 : 902.209 MHz : 5.129 dBm M2 : 902.337 MHz : 24.842 dBm Delta1 : 178 KHz : -0.893 dB T1 : 902.217 MHz : 7.139 dBm T2 : 902.381 MHz : 6.419 dBm OBW : 164 KHz	

[back to matrix](#)

This test report may be reproduced in full only. The document may only be updated by MiCOM Labs personnel. All changes will be noted in the Document History section of the report.



Title: Silver Spring Networks NIC 511-0303
To: FCC CFR 47 Part 15 Subpart C 15.247 & IC RSS 247
Serial #: SSNT108-U8 Rev A
Issue Date: 11th December 2015
Page: 112 of 204

20 dB & 99% BANDWIDTH



Variant: 300 GFSK, Channel: 915.20 MHz, Chain a, Temp: Ambient, Voltage: 4 Vdc

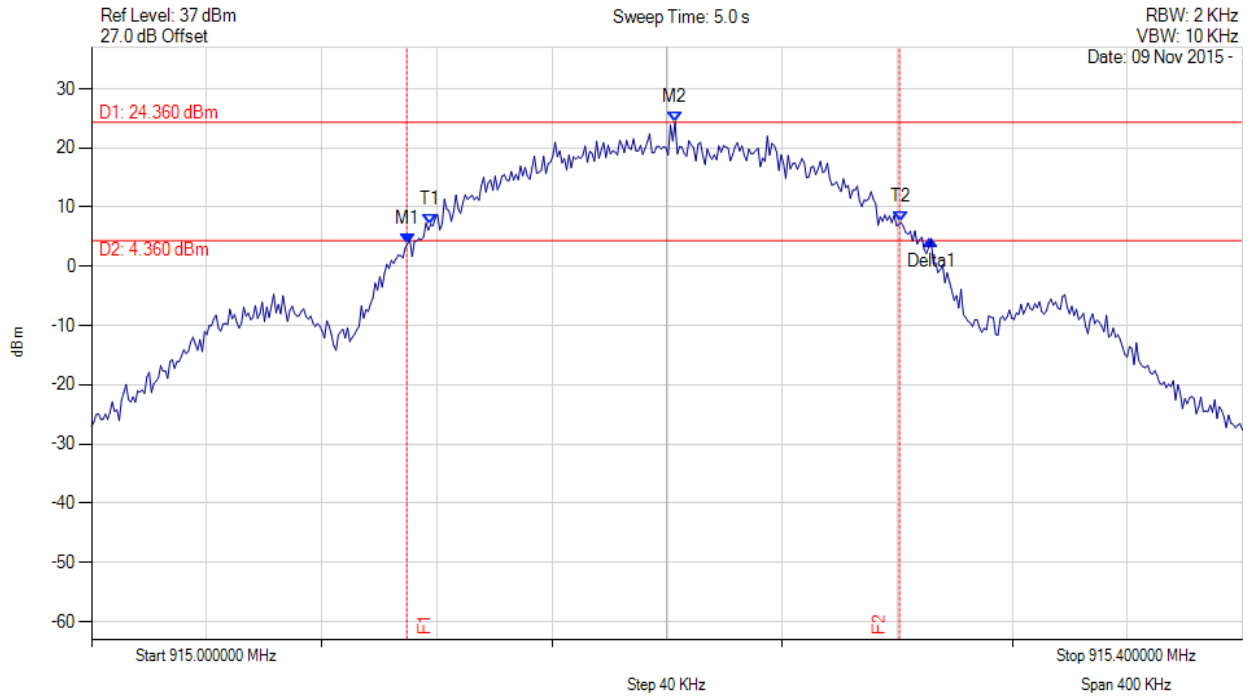

Analyser Setup	Marker:Frequency:Amplitude	Test Results
Detector = MAX PEAK Sweep Count = 0 RF Atten (dB) = 20 Trace Mode = VIEW	M1 : 915.110 MHz : 3.858 dBm M2 : 915.203 MHz : 24.362 dBm Delta1 : 182 KHz : 0.600 dB T1 : 915.118 MHz : 7.086 dBm T2 : 915.281 MHz : 7.427 dBm OBW : 164 KHz	

[back to matrix](#)

This test report may be reproduced in full only. The document may only be updated by MiCOM Labs personnel. All changes will be noted in the Document History section of the report.



Title: Silver Spring Networks NIC 511-0303
To: FCC CFR 47 Part 15 Subpart C 15.247 & IC RSS 247
Serial #: SSNT108-U8 Rev A
Issue Date: 11th December 2015
Page: 113 of 204

20 dB & 99% BANDWIDTH



Variant: 300 GFSK, Channel: 926.90 MHz, Chain a, Temp: Ambient, Voltage: 4 Vdc

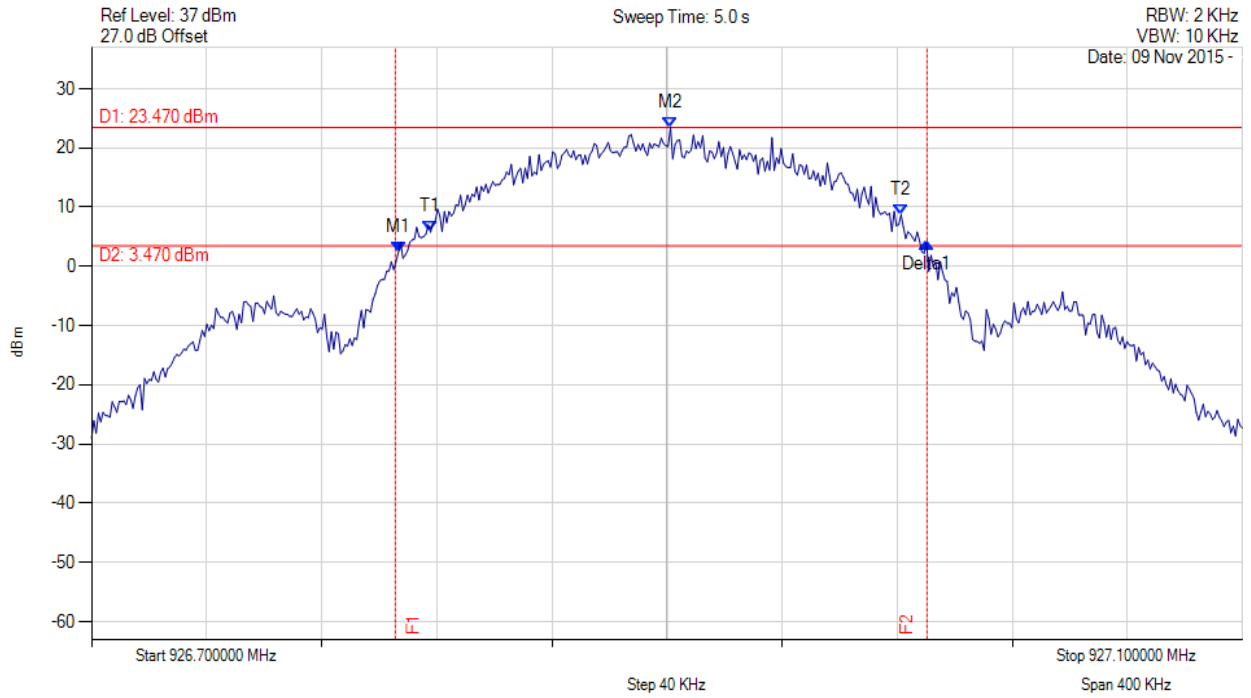

Analyser Setup	Marker:Frequency:Amplitude	Test Results
Detector = MAX PEAK Sweep Count = 0 RF Atten (dB) = 20 Trace Mode = VIEW	M1 : 926.807 MHz : 2.282 dBm M2 : 926.901 MHz : 23.469 dBm Delta1 : 184 KHz : 1.655 dB T1 : 926.818 MHz : 5.804 dBm T2 : 926.981 MHz : 8.733 dBm OBW : 164 KHz	

[back to matrix](#)

This test report may be reproduced in full only. The document may only be updated by MiCOM Labs personnel. All changes will be noted in the Document History section of the report.



Title: Silver Spring Networks NIC 511-0303
To: FCC CFR 47 Part 15 Subpart C 15.247 & IC RSS 247
Serial #: SSNT108-U8 Rev A
Issue Date: 11th December 2015
Page: 114 of 204

20 dB & 99% BANDWIDTH



Variant: 300 GFSK, Channel: 902.30 MHz, Chain a, Temp: Ambient, Voltage: 4 Vdc

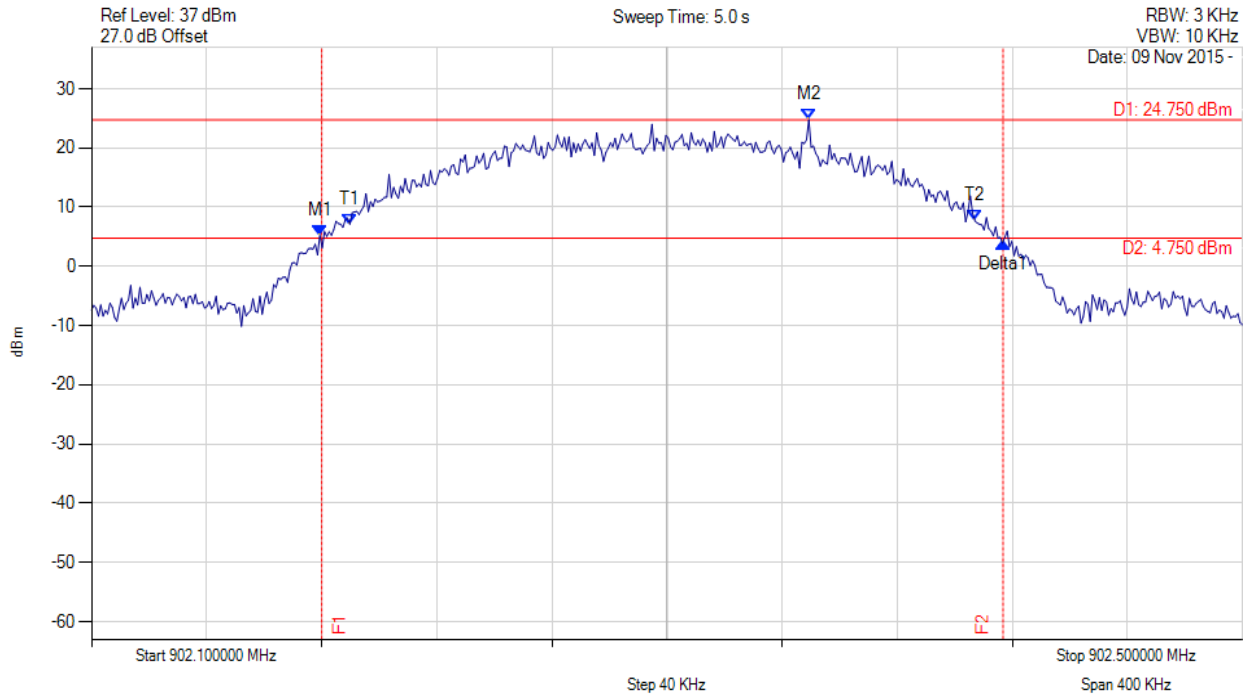

Analyser Setup	Marker:Frequency:Amplitude	Test Results
Detector = MAX PEAK Sweep Count = 0 RF Atten (dB) = 20 Trace Mode = VIEW	M1 : 902.179 MHz : 5.221 dBm M2 : 902.349 MHz : 24.753 dBm Delta1 : 237 KHz : -1.261 dB T1 : 902.190 MHz : 7.141 dBm T2 : 902.407 MHz : 7.688 dBm OBW : 217 KHz	

[back to matrix](#)

This test report may be reproduced in full only. The document may only be updated by MiCOM Labs personnel. All changes will be noted in the Document History section of the report.



Title: Silver Spring Networks NIC 511-0303
To: FCC CFR 47 Part 15 Subpart C 15.247 & IC RSS 247
Serial #: SSNT108-U8 Rev A
Issue Date: 11th December 2015
Page: 115 of 204

20 dB & 99% BANDWIDTH



Variant: 300 GFSK, Channel: 915.20 MHz, Chain a, Temp: Ambient, Voltage: 4 Vdc

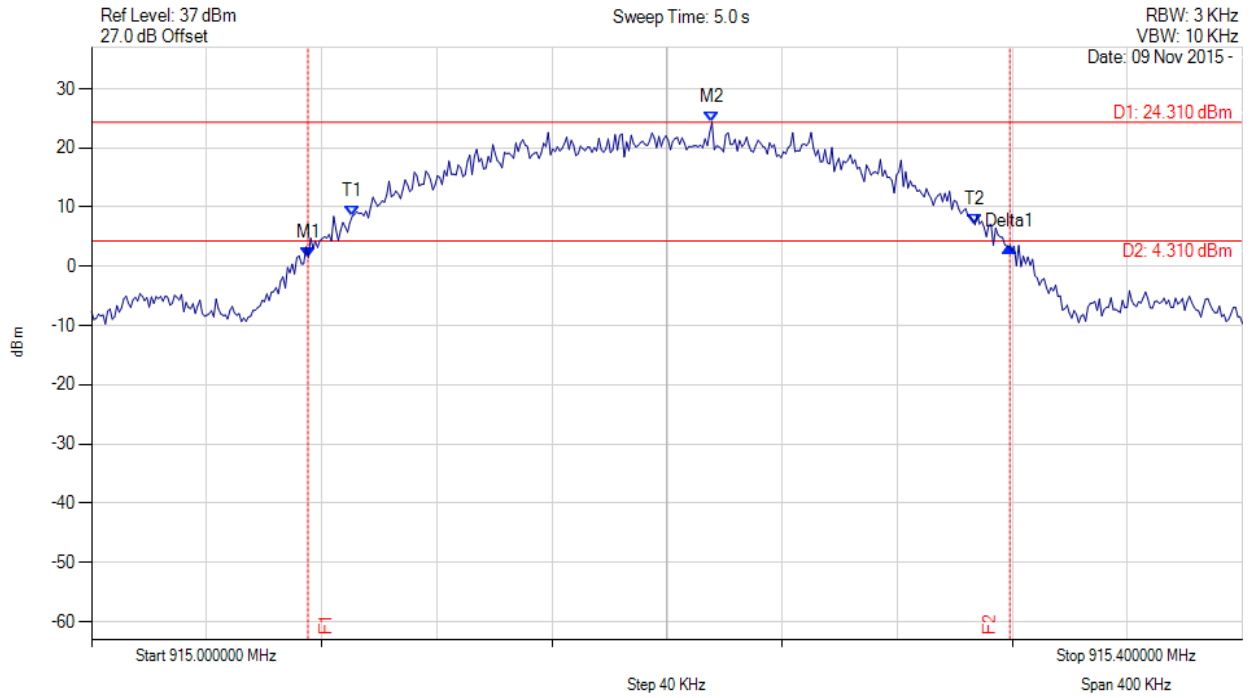

Analyser Setup	Marker:Frequency:Amplitude	Test Results
Detector = MAX PEAK Sweep Count = 0 RF Atten (dB) = 20 Trace Mode = VIEW	M1 : 915.075 MHz : 1.538 dBm M2 : 915.216 MHz : 24.309 dBm Delta1 : 244 KHz : 1.771 dB T1 : 915.091 MHz : 8.446 dBm T2 : 915.307 MHz : 7.033 dBm OBW : 216 KHz	

[back to matrix](#)

This test report may be reproduced in full only. The document may only be updated by MiCOM Labs personnel. All changes will be noted in the Document History section of the report.



Title: Silver Spring Networks NIC 511-0303
To: FCC CFR 47 Part 15 Subpart C 15.247 & IC RSS 247
Serial #: SSNT108-U8 Rev A
Issue Date: 11th December 2015
Page: 116 of 204



20 dB & 99% BANDWIDTH

Variant: 300 GFSK, Channel: 926.90 MHz, Chain a, Temp: Ambient, Voltage: 4 Vdc

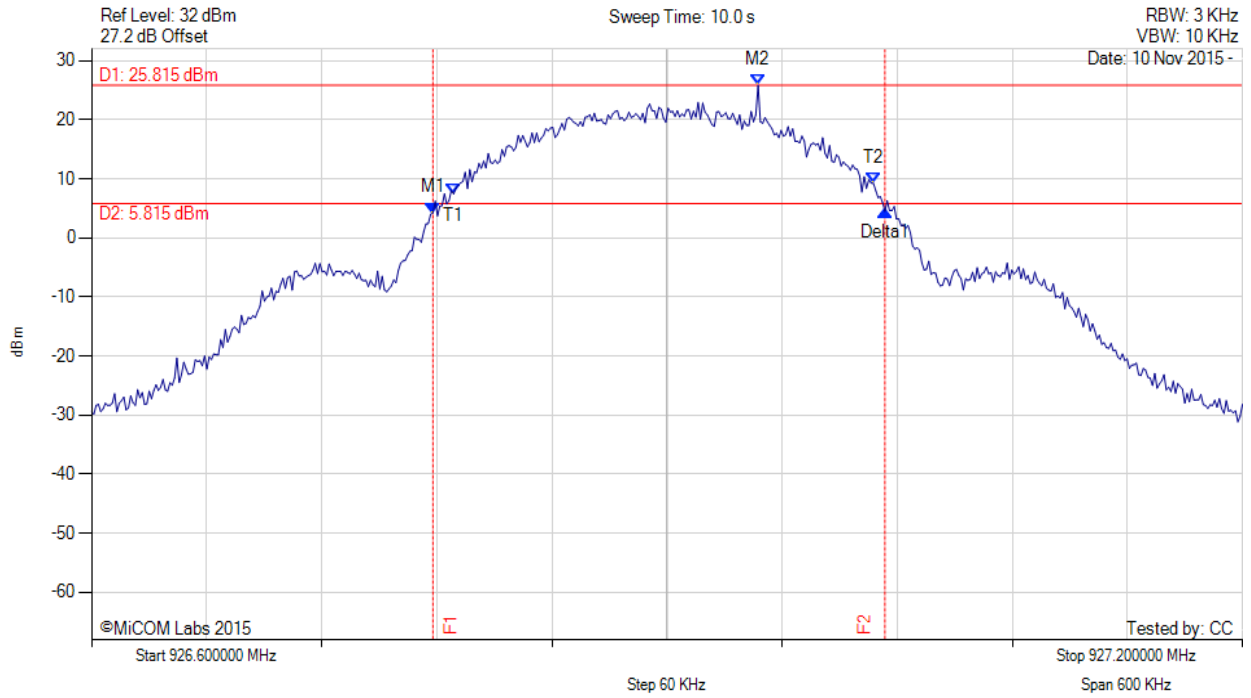

Analyser Setup	Marker:Frequency:Amplitude	Test Results
Detector = MAX PEAK Sweep Count = 0 RF Atten (dB) = 30 Trace Mode = MAX HOLD	M1 : 926.778 MHz : 4.235 dBm M2 : 926.947 MHz : 25.815 dBm Delta1 : 236 KHz : 0.277 dB T1 : 926.789 MHz : 7.428 dBm T2 : 927.008 MHz : 9.208 dBm OBW : 219 KHz	

[back to matrix](#)

This test report may be reproduced in full only. The document may only be updated by MiCOM Labs personnel. All changes will be noted in the Document History section of the report.



Title: Silver Spring Networks NIC 511-0303
To: FCC CFR 47 Part 15 Subpart C 15.247 & IC RSS 247
Serial #: SSNT108-U8 Rev A
Issue Date: 11th December 2015
Page: 117 of 204

20 dB & 99% BANDWIDTH



Variant: 400 FSK, Channel: 902.40 MHz, Chain a, Temp: Ambient, Voltage: 4 Vdc

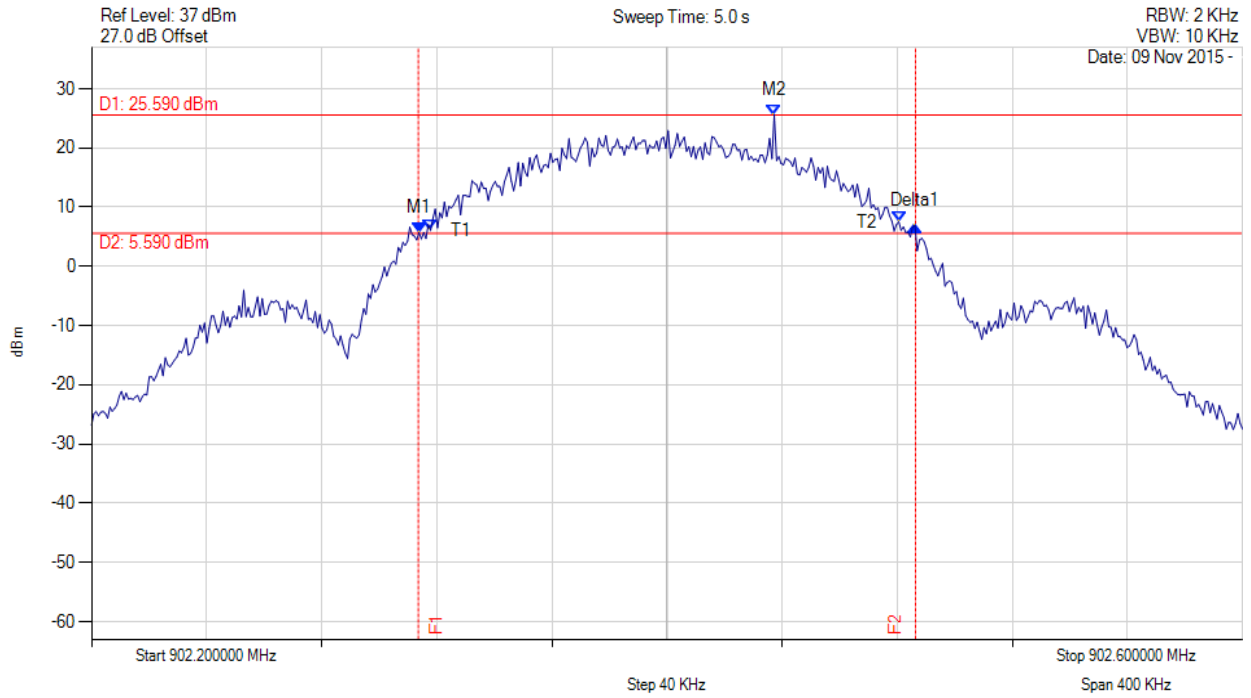

Analyser Setup	Marker:Frequency:Amplitude	Test Results
Detector = MAX PEAK Sweep Count = 0 RF Atten (dB) = 20 Trace Mode = VIEW	M1 : 902.314 MHz : 5.690 dBm M2 : 902.437 MHz : 25.595 dBm Delta1 : 172 KHz : 1.196 dB T1 : 902.318 MHz : 6.075 dBm T2 : 902.481 MHz : 7.531 dBm OBW : 163 KHz	

[back to matrix](#)

This test report may be reproduced in full only. The document may only be updated by MiCOM Labs personnel. All changes will be noted in the Document History section of the report.



Title: Silver Spring Networks NIC 511-0303
To: FCC CFR 47 Part 15 Subpart C 15.247 & IC RSS 247
Serial #: SSNT108-U8 Rev A
Issue Date: 11th December 2015
Page: 118 of 204

20 dB & 99% BANDWIDTH



Variant: 400 FSK, Channel: 915.20 MHz, Chain a, Temp: Ambient, Voltage: 4 Vdc

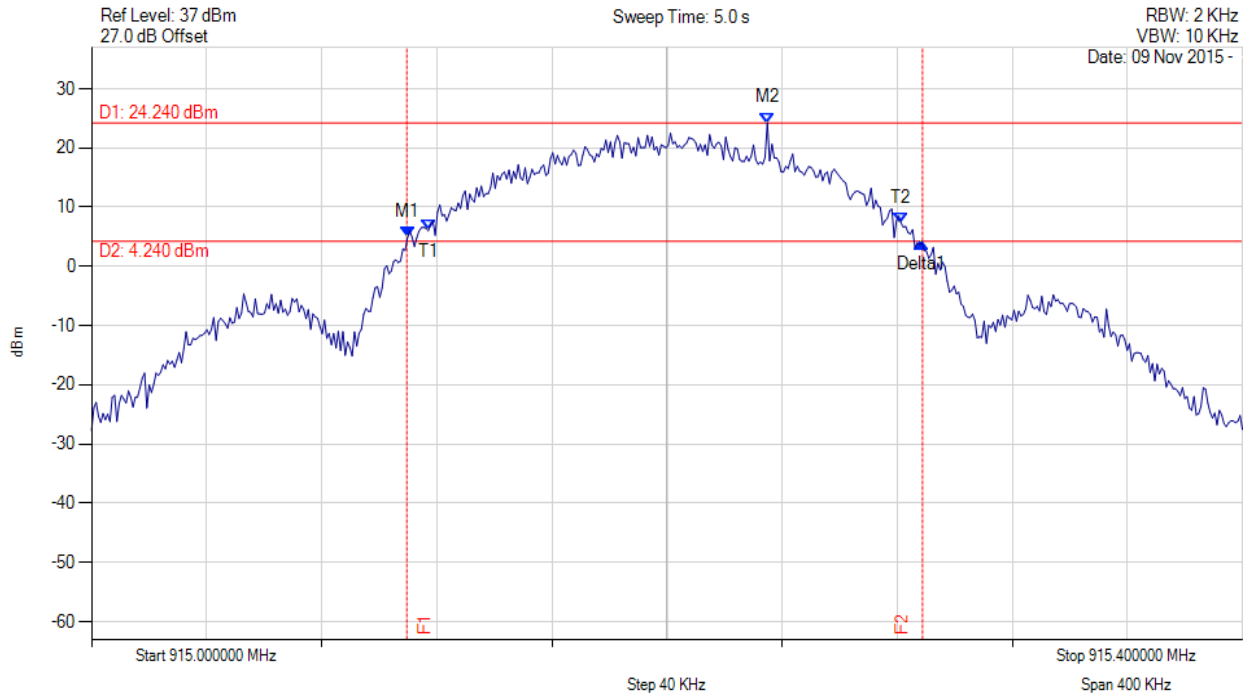

Analyser Setup	Marker:Frequency:Amplitude	Test Results
Detector = MAX PEAK Sweep Count = 0 RF Atten (dB) = 20 Trace Mode = VIEW	M1 : 915.110 MHz : 4.859 dBm M2 : 915.235 MHz : 24.244 dBm Delta1 : 179 KHz : -0.872 dB T1 : 915.117 MHz : 6.046 dBm T2 : 915.281 MHz : 7.320 dBm OBW : 164 KHz	

[back to matrix](#)

This test report may be reproduced in full only. The document may only be updated by MiCOM Labs personnel. All changes will be noted in the Document History section of the report.



Title: Silver Spring Networks NIC 511-0303
To: FCC CFR 47 Part 15 Subpart C 15.247 & IC RSS 247
Serial #: SSNT108-U8 Rev A
Issue Date: 11th December 2015
Page: 119 of 204

20 dB & 99% BANDWIDTH



Variant: 400 FSK, Channel: 927.60 MHz, Chain a, Temp: Ambient, Voltage: 4 Vdc

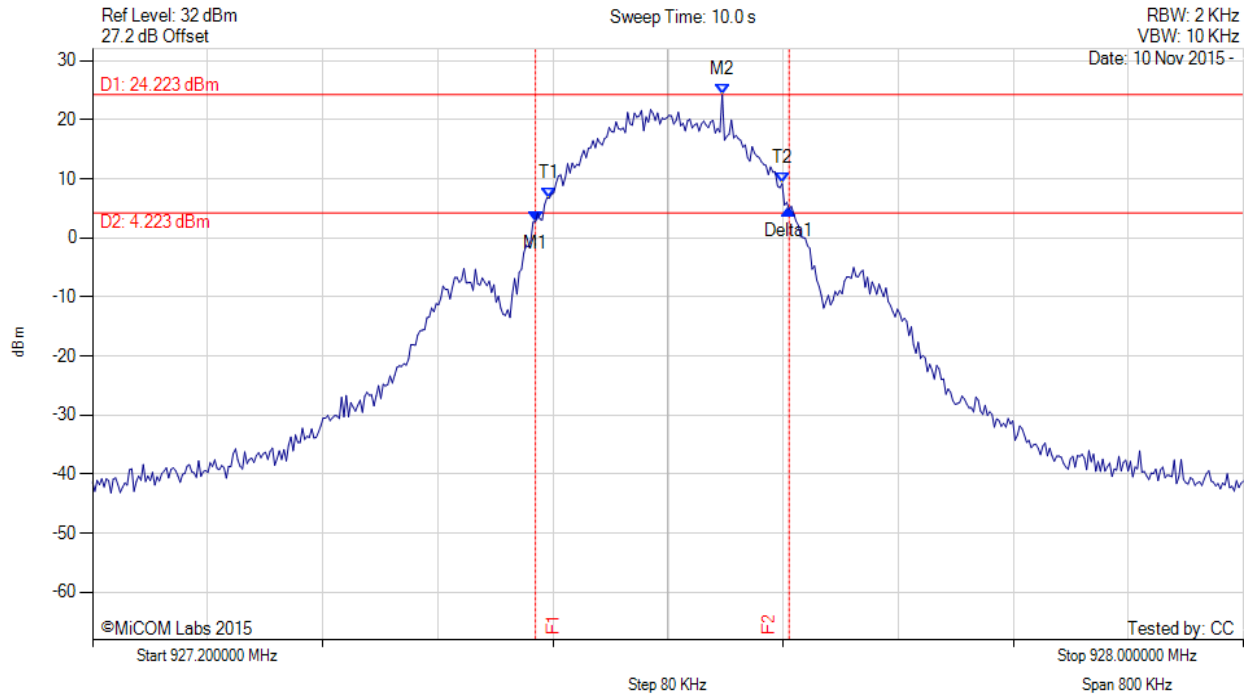

Analyser Setup	Marker:Frequency:Amplitude	Test Results
Detector = MAX PEAK Sweep Count = 0 RF Atten (dB) = 30 Trace Mode = MAX HOLD	M1 : 927.508 MHz : 2.732 dBm M2 : 927.638 MHz : 24.223 dBm Delta1 : 176 KHz : 2.115 dB T1 : 927.517 MHz : 6.698 dBm T2 : 927.679 MHz : 9.196 dBm OBW : 162 KHz	

[back to matrix](#)

This test report may be reproduced in full only. The document may only be updated by MiCOM Labs personnel. All changes will be noted in the Document History section of the report.



Title: Silver Spring Networks NIC 511-0303
To: FCC CFR 47 Part 15 Subpart C 15.247 & IC RSS 247
Serial #: SSNT108-U8 Rev A
Issue Date: 11th December 2015
Page: 120 of 204



20 dB & 99% BANDWIDTH

Variant: 400 GFSK, Channel: 902.40 MHz, Chain a, Temp: Ambient, Voltage: 4 Vdc

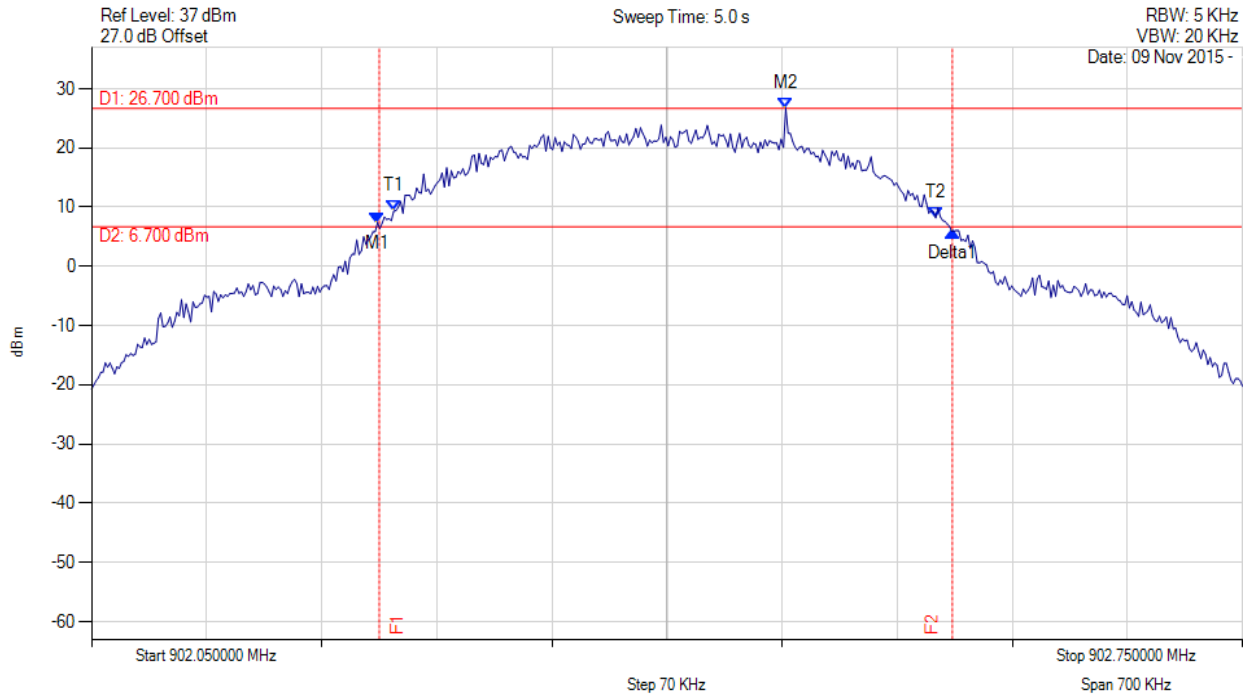

Analyser Setup	Marker:Frequency:Amplitude	Test Results
Detector = MAX PEAK Sweep Count = 0 RF Atten (dB) = 20 Trace Mode = VIEW	M1 : 902.224 MHz : 7.407 dBm M2 : 902.472 MHz : 26.699 dBm Delta1 : 350 KHz : -1.491 dB T1 : 902.234 MHz : 9.327 dBm T2 : 902.563 MHz : 8.200 dBm OBW : 330 KHz	

[back to matrix](#)

This test report may be reproduced in full only. The document may only be updated by MiCOM Labs personnel. All changes will be noted in the Document History section of the report.



Title: Silver Spring Networks NIC 511-0303
To: FCC CFR 47 Part 15 Subpart C 15.247 & IC RSS 247
Serial #: SSNT108-U8 Rev A
Issue Date: 11th December 2015
Page: 121 of 204



20 dB & 99% BANDWIDTH

Variant: 400 GFSK, Channel: 915.20 MHz, Chain a, Temp: Ambient, Voltage: 4 Vdc

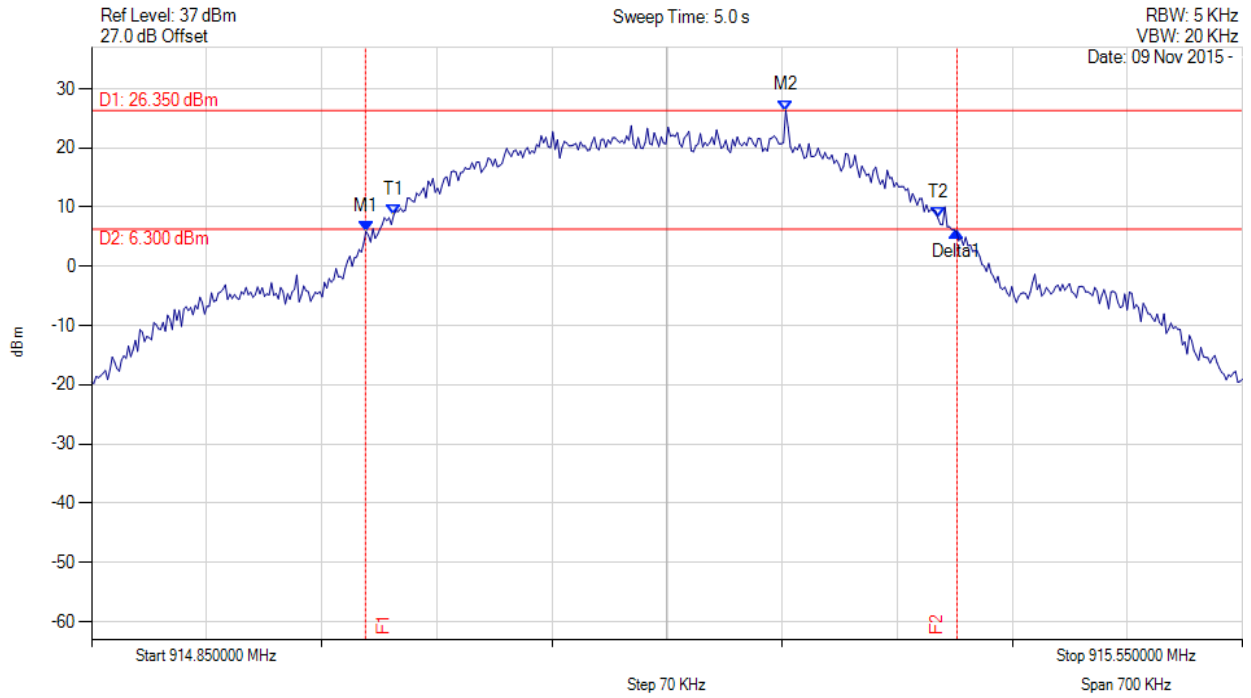

Analyser Setup	Marker:Frequency:Amplitude	Test Results
Detector = MAX PEAK Sweep Count = 0 RF Atten (dB) = 20 Trace Mode = VIEW	M1 : 915.017 MHz : 5.908 dBm M2 : 915.272 MHz : 26.349 dBm Delta1 : 359 KHz : 0.031 dB T1 : 915.034 MHz : 8.676 dBm T2 : 915.365 MHz : 8.145 dBm OBW : 331 KHz	

[back to matrix](#)

This test report may be reproduced in full only. The document may only be updated by MiCOM Labs personnel. All changes will be noted in the Document History section of the report.



Title: Silver Spring Networks NIC 511-0303
To: FCC CFR 47 Part 15 Subpart C 15.247 & IC RSS 247
Serial #: SSNT108-U8 Rev A
Issue Date: 11th December 2015
Page: 122 of 204

20 dB & 99% BANDWIDTH



Variant: 400 GFSK, Channel: 927.60 MHz, Chain a, Temp: Ambient, Voltage: 4 Vdc

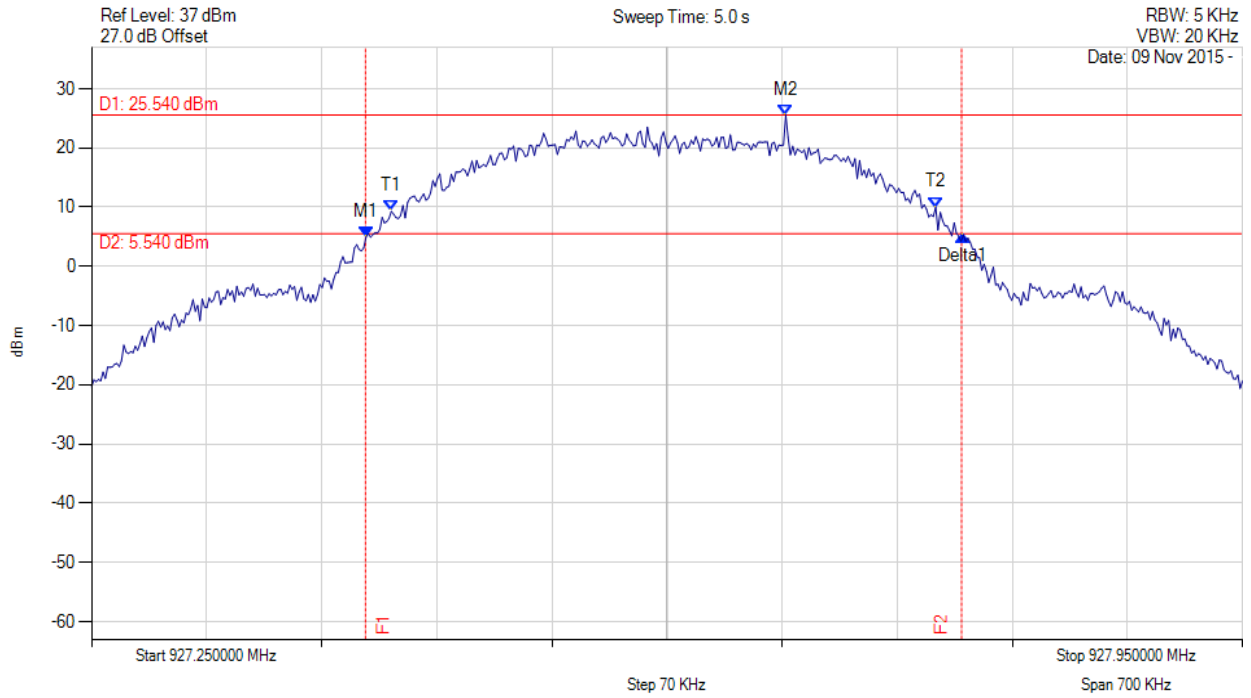

Analyser Setup	Marker:Frequency:Amplitude	Test Results
Detector = MAX PEAK Sweep Count = 0 RF Atten (dB) = 20 Trace Mode = VIEW	M1 : 927.417 MHz : 4.922 dBm M2 : 927.672 MHz : 25.542 dBm Delta1 : 363 KHz : 0.368 dB T1 : 927.432 MHz : 9.319 dBm T2 : 927.763 MHz : 9.972 dBm OBW : 331 KHz	

[back to matrix](#)

This test report may be reproduced in full only. The document may only be updated by MiCOM Labs personnel. All changes will be noted in the Document History section of the report.



Title: Silver Spring Networks NIC 511-0303
To: FCC CFR 47 Part 15 Subpart C 15.247 & IC RSS 247
Serial #: SSNT108-U8 Rev A
Issue Date: 11th December 2015
Page: 123 of 204



20 dB & 99% BANDWIDTH

Variant: 200 2FSK, Channel: 902.20 MHz, Chain a, Temp: Ambient, Voltage: 4 Vdc

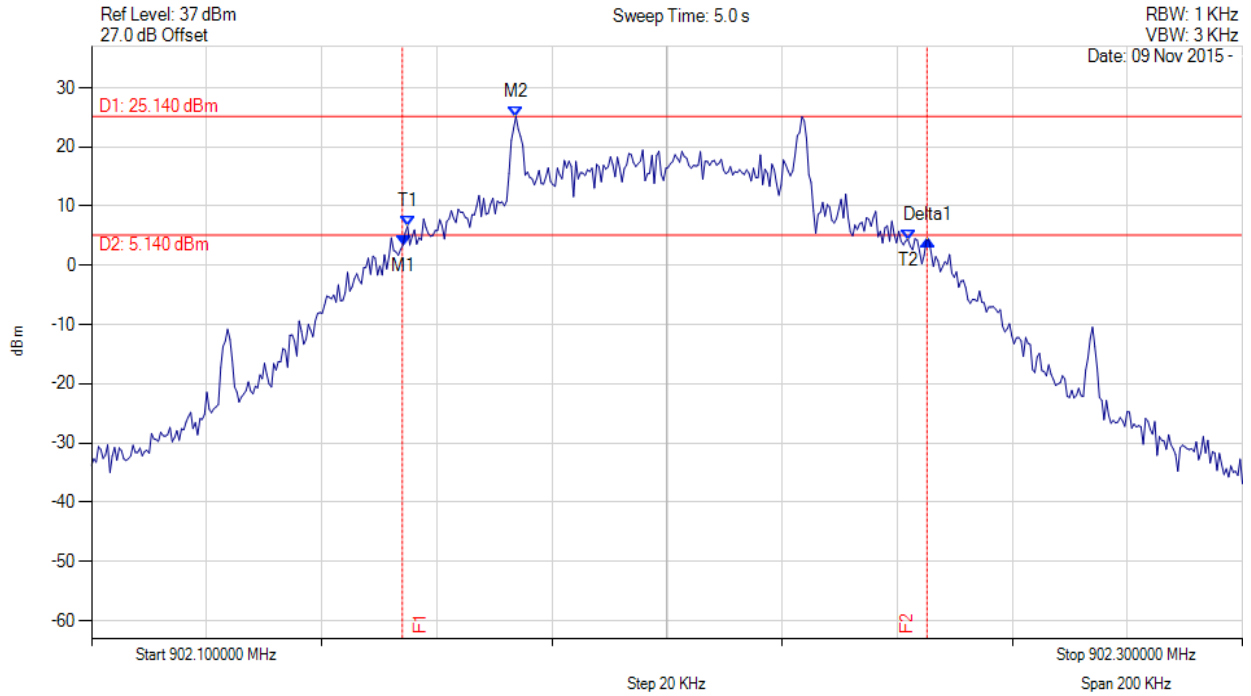

Analyser Setup	Marker:Frequency:Amplitude	Test Results
Detector = MAX PEAK Sweep Count = 0 RF Atten (dB) = 20 Trace Mode = VIEW	M1 : 902.154 MHz : 3.415 dBm M2 : 902.174 MHz : 25.141 dBm Delta1 : 91 KHz : 0.877 dB T1 : 902.155 MHz : 6.604 dBm T2 : 902.242 MHz : 4.379 dBm OBW : 87 KHz	

[back to matrix](#)

This test report may be reproduced in full only. The document may only be updated by MiCOM Labs personnel. All changes will be noted in the Document History section of the report.



Title: Silver Spring Networks NIC 511-0303
To: FCC CFR 47 Part 15 Subpart C 15.247 & IC RSS 247
Serial #: SSNT108-U8 Rev A
Issue Date: 11th December 2015
Page: 124 of 204

20 dB & 99% BANDWIDTH



Variant: 200 2FSK, Channel: 915.00 MHz, Chain a, Temp: Ambient, Voltage: 4 Vdc

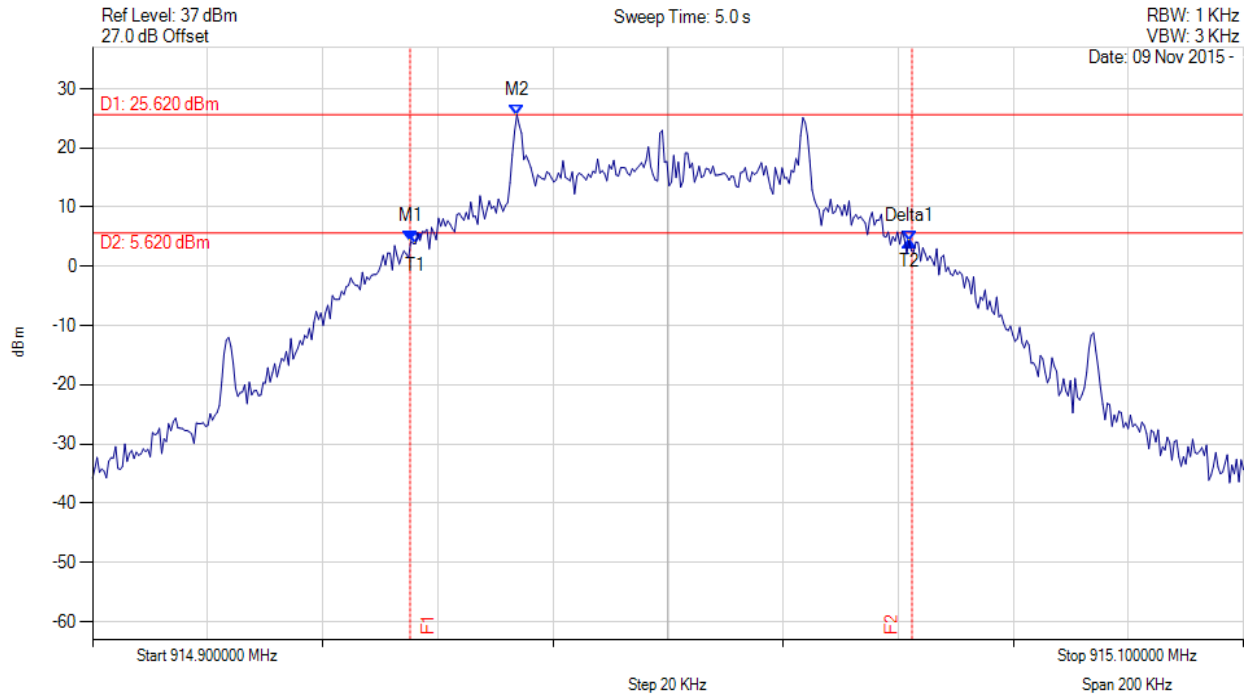

Analyser Setup	Marker:Frequency:Amplitude	Test Results
Detector = MAX PEAK Sweep Count = 0 RF Atten (dB) = 20 Trace Mode = VIEW	M1 : 914.955 MHz : 4.232 dBm M2 : 914.974 MHz : 25.619 dBm Delta1 : 87 KHz : 0.104 dB T1 : 914.956 MHz : 3.805 dBm T2 : 915.042 MHz : 4.336 dBm OBW : 86 KHz	

[back to matrix](#)

This test report may be reproduced in full only. The document may only be updated by MiCOM Labs personnel. All changes will be noted in the Document History section of the report.



Title: Silver Spring Networks NIC 511-0303
To: FCC CFR 47 Part 15 Subpart C 15.247 & IC RSS 247
Serial #: SSNT108-U8 Rev A
Issue Date: 11th December 2015
Page: 125 of 204

20 dB & 99% BANDWIDTH



Variant: 200 2FSK, Channel: 927.80 MHz, Chain a, Temp: Ambient, Voltage: 4 Vdc

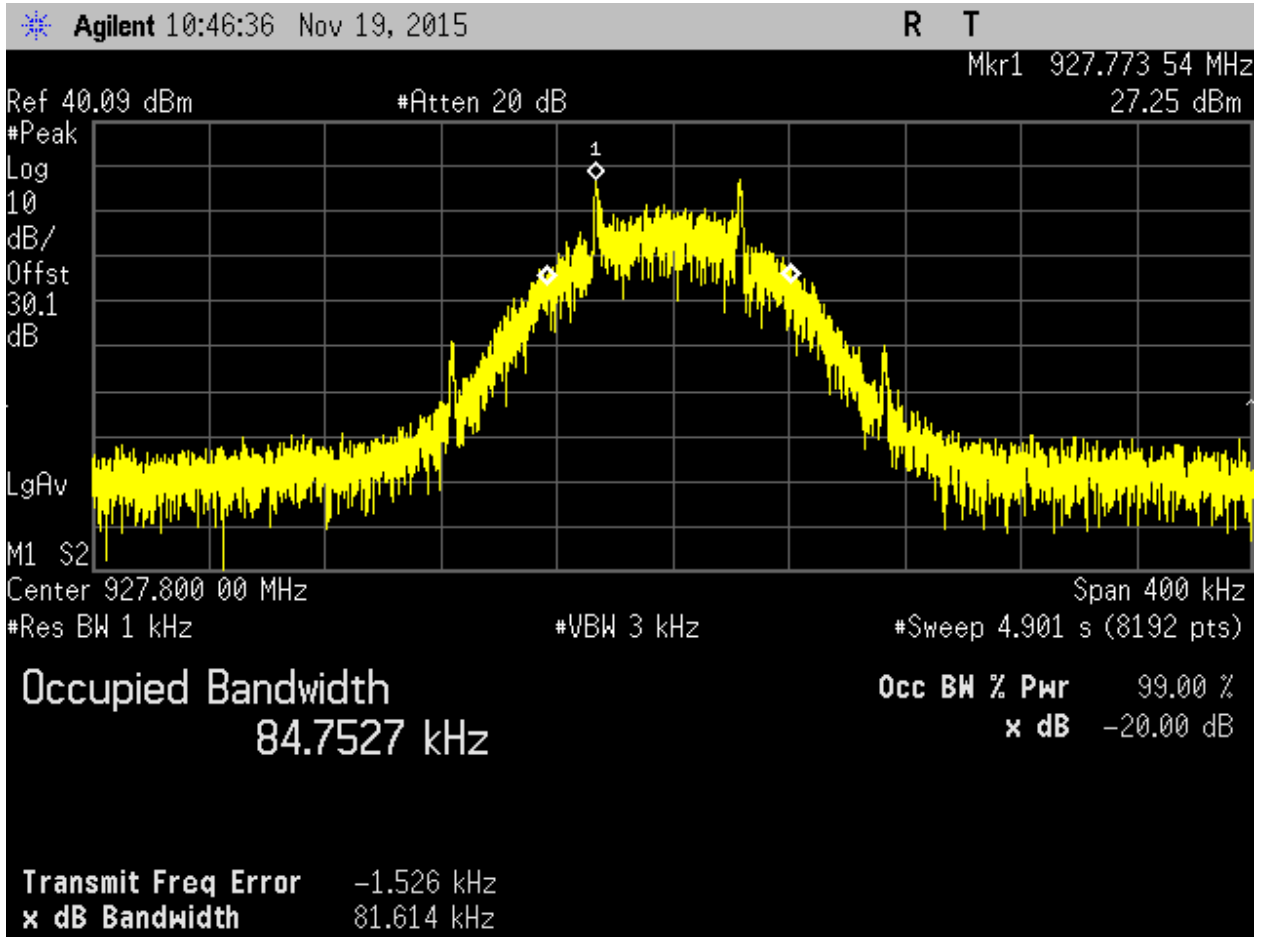

Analyser Setup	Marker:Frequency:Amplitude	Test Results
Detector = MAX PEAK Sweep Count = 0 RF Atten (dB) = 20 Trace Mode = VIEW		

[back to matrix](#)

This test report may be reproduced in full only. The document may only be updated by MiCOM Labs personnel. All changes will be noted in the Document History section of the report.



Title: Silver Spring Networks NIC 511-0303
To: FCC CFR 47 Part 15 Subpart C 15.247 & IC RSS 247
Serial #: SSNT108-U8 Rev A
Issue Date: 11th December 2015
Page: 126 of 204

20 dB & 99% BANDWIDTH



Variant: 200 OQPSK, Channel: 902.20 MHz, Chain a, Temp: Ambient, Voltage: 4 Vdc

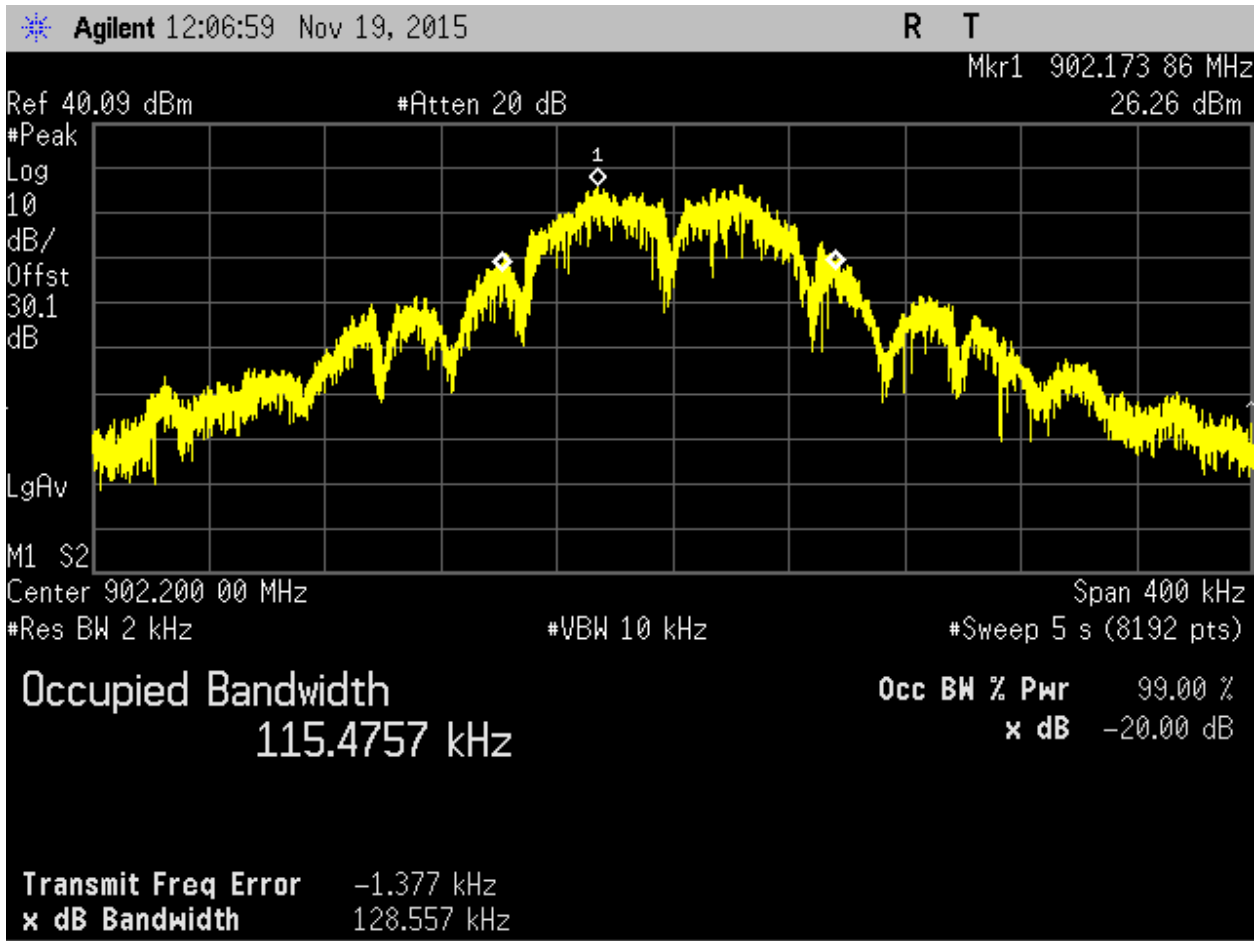

Analyser Setup	Marker:Frequency:Amplitude	Test Results
Detector = MAX PEAK Sweep Count = 0 RF Atten (dB) = 20 Trace Mode = VIEW		

[back to matrix](#)

This test report may be reproduced in full only. The document may only be updated by MiCOM Labs personnel. All changes will be noted in the Document History section of the report.



Title: Silver Spring Networks NIC 511-0303
To: FCC CFR 47 Part 15 Subpart C 15.247 & IC RSS 247
Serial #: SSNT108-U8 Rev A
Issue Date: 11th December 2015
Page: 127 of 204



20 dB & 99% BANDWIDTH

Variat: 200 OQPSK, Channel: 915.00 MHz, Chain a, Temp: Ambient, Voltage: 4 Vdc

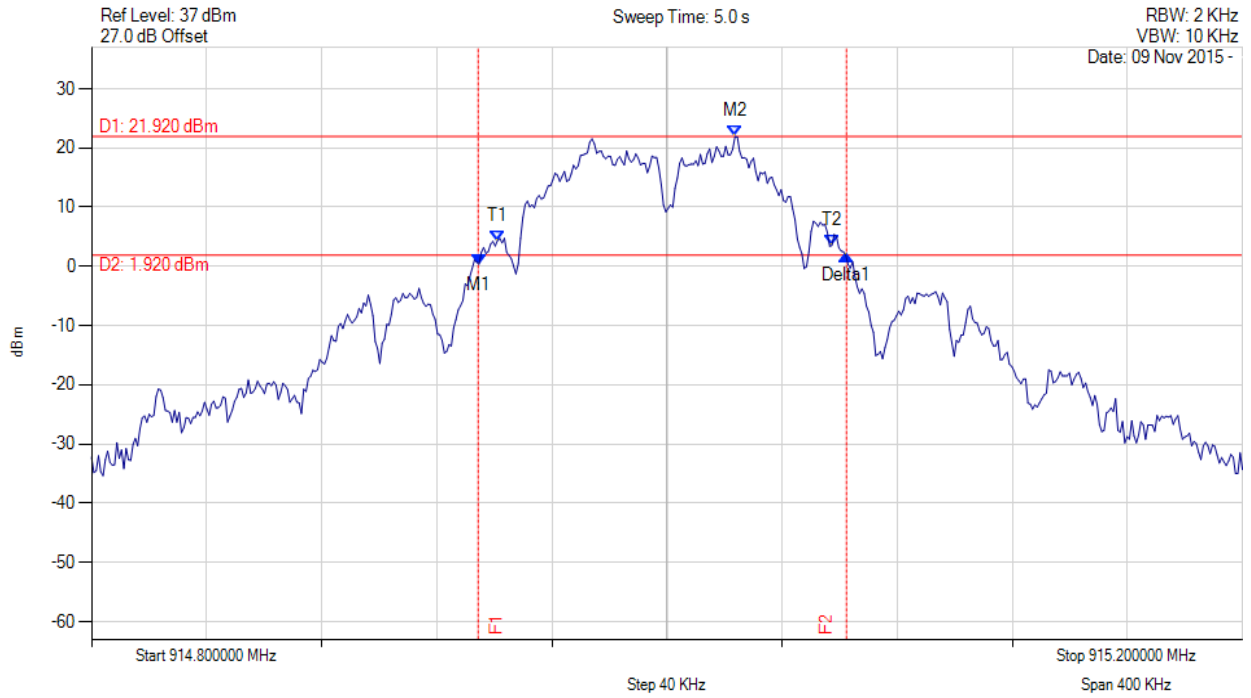

Analyser Setup	Marker:Frequency:Amplitude	Test Results
Detector = MAX PEAK Sweep Count = 0 RF Atten (dB) = 20 Trace Mode = VIEW	M1 : 914.935 MHz : 0.386 dBm M2 : 915.024 MHz : 21.924 dBm Delta1 : 127 KHz : 1.570 dB T1 : 914.941 MHz : 4.332 dBm T2 : 915.057 MHz : 3.529 dBm OBW : 116 KHz	M

[back to matrix](#)

This test report may be reproduced in full only. The document may only be updated by MiCOM Labs personnel. All changes will be noted in the Document History section of the report.



Title: Silver Spring Networks NIC 511-0303
To: FCC CFR 47 Part 15 Subpart C 15.247 & IC RSS 247
Serial #: SSNT108-U8 Rev A
Issue Date: 11th December 2015
Page: 128 of 204

20 dB & 99% BANDWIDTH



Variant: 200 OQPSK, Channel: 927.80 MHz, Chain a, Temp: Ambient, Voltage: 4 Vdc



Analyser Setup	Marker:Frequency:Amplitude	Test Results
Detector = MAX PEAK Sweep Count = 0 RF Atten (dB) = 20 Trace Mode = VIEW	M1 : 927.533 MHz : 2.559 dBm M2 : 927.573 MHz : 22.752 dBm Delta1 : 129 KHz : -1.234 dB T1 : 927.541 MHz : 5.562 dBm T2 : 927.657 MHz : 4.189 dBm OBW : 115 KHz	

[back to matrix](#)

This test report may be reproduced in full only. The document may only be updated by MiCOM Labs personnel. All changes will be noted in the Document History section of the report.



Title: Silver Spring Networks NIC 511-0303
To: FCC CFR 47 Part 15 Subpart C 15.247 & IC RSS 247
Serial #: SSNT108-U8 Rev A
Issue Date: 11th December 2015
Page: 129 of 204

20 dB & 99% BANDWIDTH



Variant: 400 OFDM, Channel: 902.40 MHz, Chain a, Temp: Ambient, Voltage: 4 Vdc

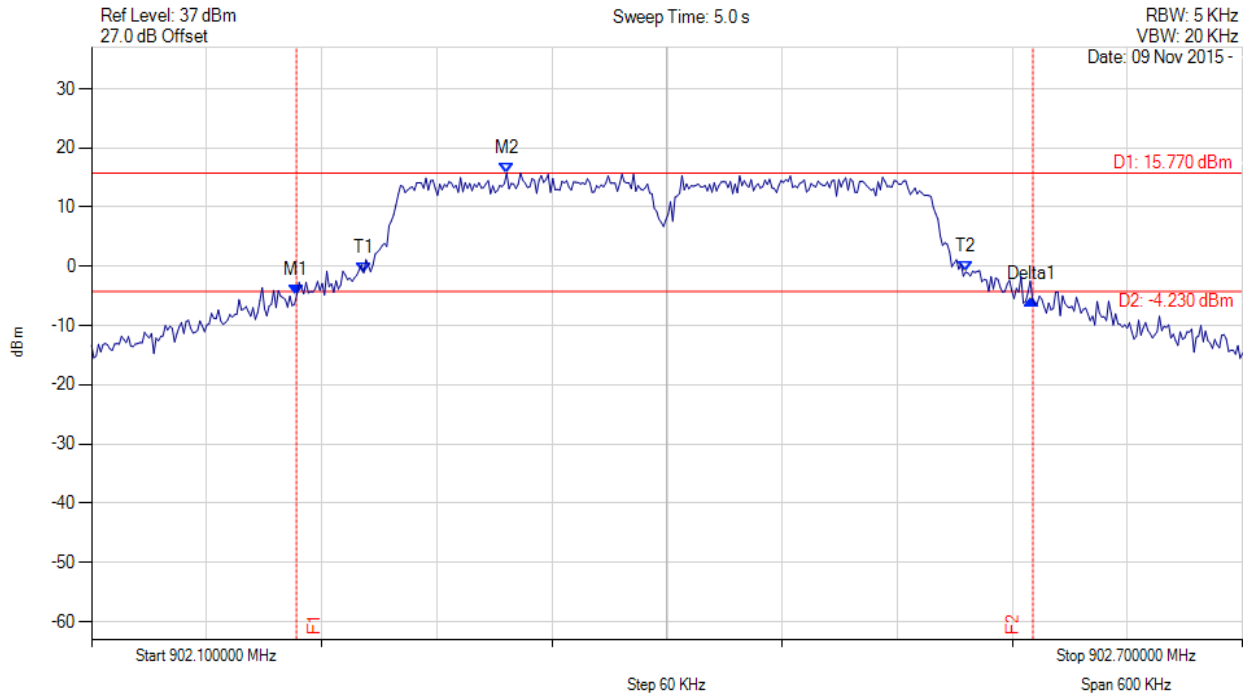

Analyser Setup	Marker:Frequency:Amplitude	Test Results
Detector = MAX PEAK Sweep Count = 0 RF Atten (dB) = 20 Trace Mode = VIEW	M1 : 902.207 MHz : -4.836 dBm M2 : 902.316 MHz : 15.774 dBm Delta1 : 384 KHz : -0.787 dB T1 : 902.242 MHz : -1.086 dBm T2 : 902.556 MHz : -0.937 dBm OBW : 314 KHz	

[back to matrix](#)

This test report may be reproduced in full only. The document may only be updated by MiCOM Labs personnel. All changes will be noted in the Document History section of the report.



20 dB & 99% BANDWIDTH



Variant: 400 OFDM, Channel: 915.20 MHz, Chain a, Temp: Ambient, Voltage: 4 Vdc

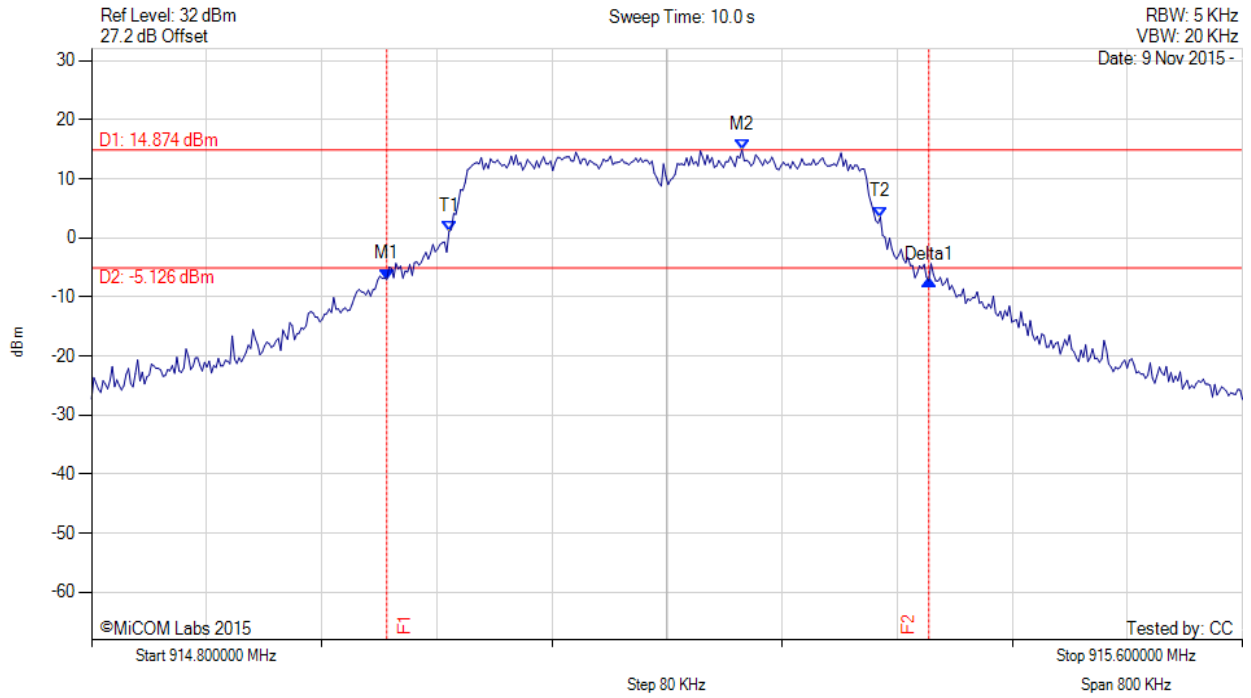

Analyser Setup	Marker:Frequency:Amplitude	Test Results
Detector = MAX PEAK Sweep Count = 0 RF Atten (dB) = 30 Trace Mode = MAX HOLD	M1 : 915.005 MHz : -7.030 dBm M2 : 915.252 MHz : 14.874 dBm Delta1 : 377 KHz : -0.207 dB T1 : 915.048 MHz : 1.101 dBm T2 : 915.348 MHz : 3.521 dBm OBW : 300 KHz	Measured 6 dB Bandwidth: 0.377 MHz Limit: ≥500.0 kHz Margin: 0.12 MHz

[back to matrix](#)

This test report may be reproduced in full only. The document may only be updated by MiCOM Labs personnel. All changes will be noted in the Document History section of the report.



20 dB & 99% BANDWIDTH



Variant: 400 OFDM, Channel: 927.60 MHz, Chain a, Temp: Ambient, Voltage: 4 Vdc

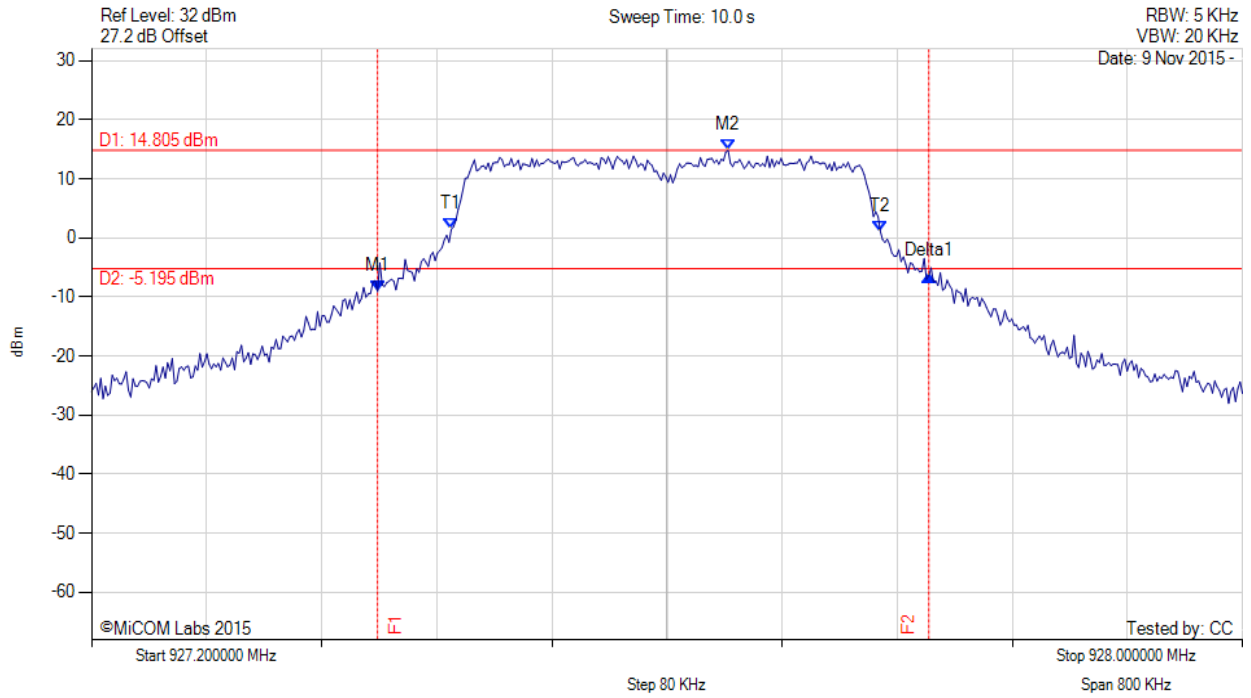

Analyser Setup	Marker:Frequency:Amplitude	Test Results
Detector = MAX PEAK Sweep Count = 0 RF Atten (dB) = 30 Trace Mode = MAX HOLD	M1 : 927.399 MHz : -9.090 dBm M2 : 927.642 MHz : 14.805 dBm Delta1 : 383 KHz : 2.676 dB T1 : 927.450 MHz : 1.441 dBm T2 : 927.748 MHz : 1.101 dBm OBW : 298 KHz	Measured 6 dB Bandwidth: 0.383 MHz Limit: ≥500.0 kHz Margin: 0.12 MHz

[back to matrix](#)

This test report may be reproduced in full only. The document may only be updated by MiCOM Labs personnel. All changes will be noted in the Document History section of the report.



A.2. 6 dB & 99% Bandwidth



6 dB & 99% BANDWIDTH

Variant: 1200 OFDM, Channel: 903.20 MHz, Chain a, Temp: Ambient, Voltage: 4 Vdc

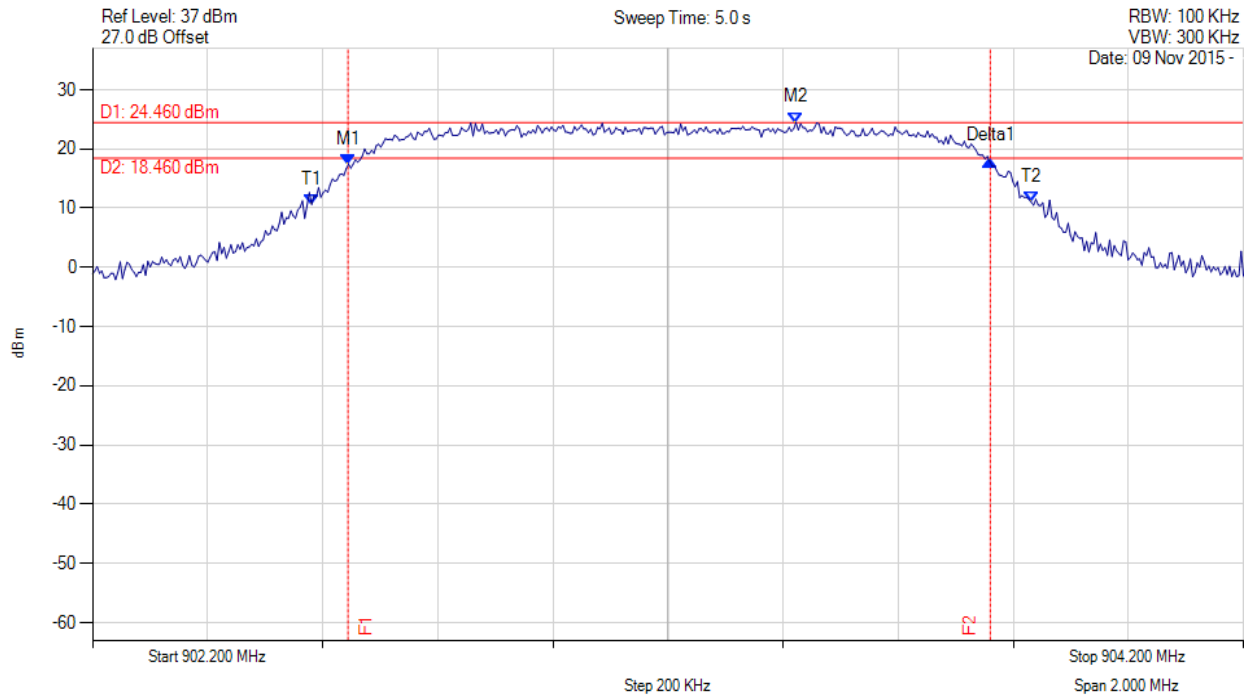

Analyser Setup	Marker:Frequency:Amplitude	Test Results
Detector = MAX PEAK Sweep Count = 0 RF Atten (dB) = 20 Trace Mode = VIEW	M1 : 902.645 MHz : 17.439 dBm M2 : 903.422 MHz : 24.462 dBm Delta1 : 1.116 MHz : 0.506 dB T1 : 902.581 MHz : 10.639 dBm T2 : 903.831 MHz : 11.001 dBm OBW : 1.251 MHz	

[back to matrix](#)

This test report may be reproduced in full only. The document may only be updated by MiCOM Labs personnel. All changes will be noted in the Document History section of the report.



6 dB & 99% BANDWIDTH

Variant: 1200 OFDM, Channel: 914.00 MHz, Chain a, Temp: Ambient, Voltage: 4 Vdc

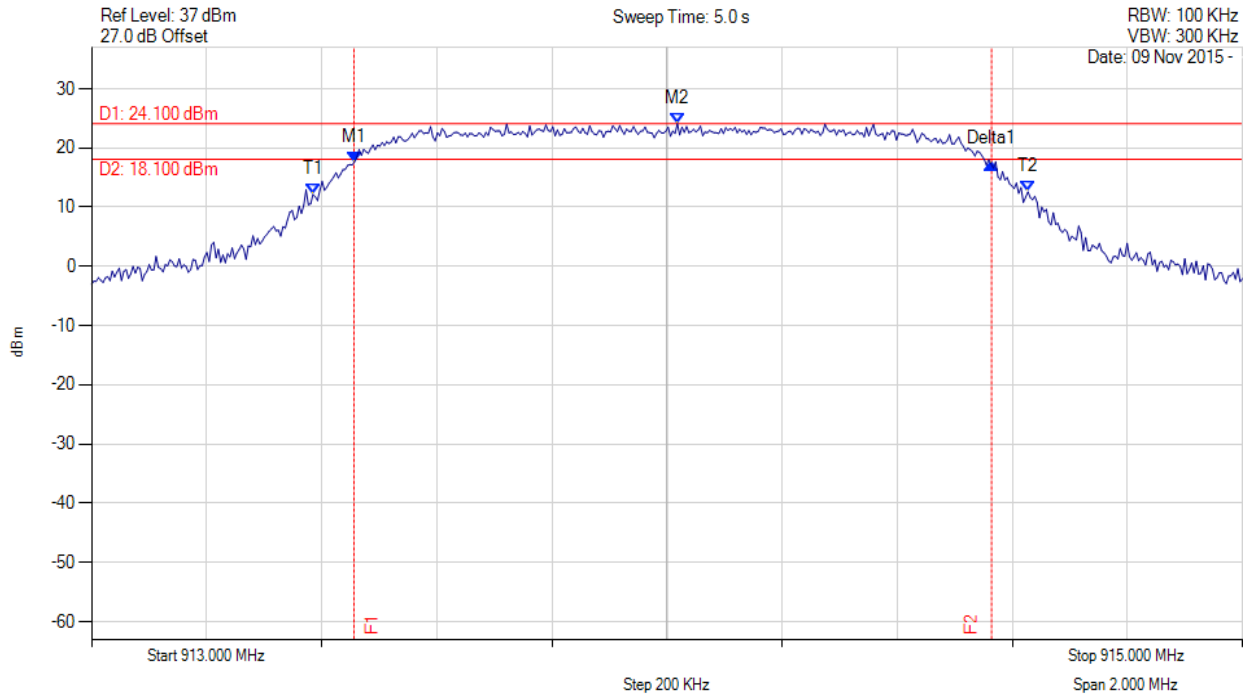

Analyser Setup	Marker:Frequency:Amplitude	Test Results
Detector = MAX PEAK Sweep Count = 0 RF Atten (dB) = 20 Trace Mode = VIEW	M1 : 913.457 MHz : 17.649 dBm M2 : 914.018 MHz : 24.096 dBm Delta1 : 1.106 MHz : -0.325 dB T1 : 913.385 MHz : 12.150 dBm T2 : 914.627 MHz : 12.589 dBm OBW : 1.242 MHz	

[back to matrix](#)

This test report may be reproduced in full only. The document may only be updated by MiCOM Labs personnel. All changes will be noted in the Document History section of the report.



Title: Silver Spring Networks NIC 511-0303
To: FCC CFR 47 Part 15 Subpart C 15.247 & IC RSS 247
Serial #: SSNT108-U8 Rev A
Issue Date: 11th December 2015
Page: 134 of 204



6 dB & 99% BANDWIDTH

Variants: 1200 OFDM, Channel: 926.00 MHz, Chain a, Temp: Ambient, Voltage: 4 Vdc

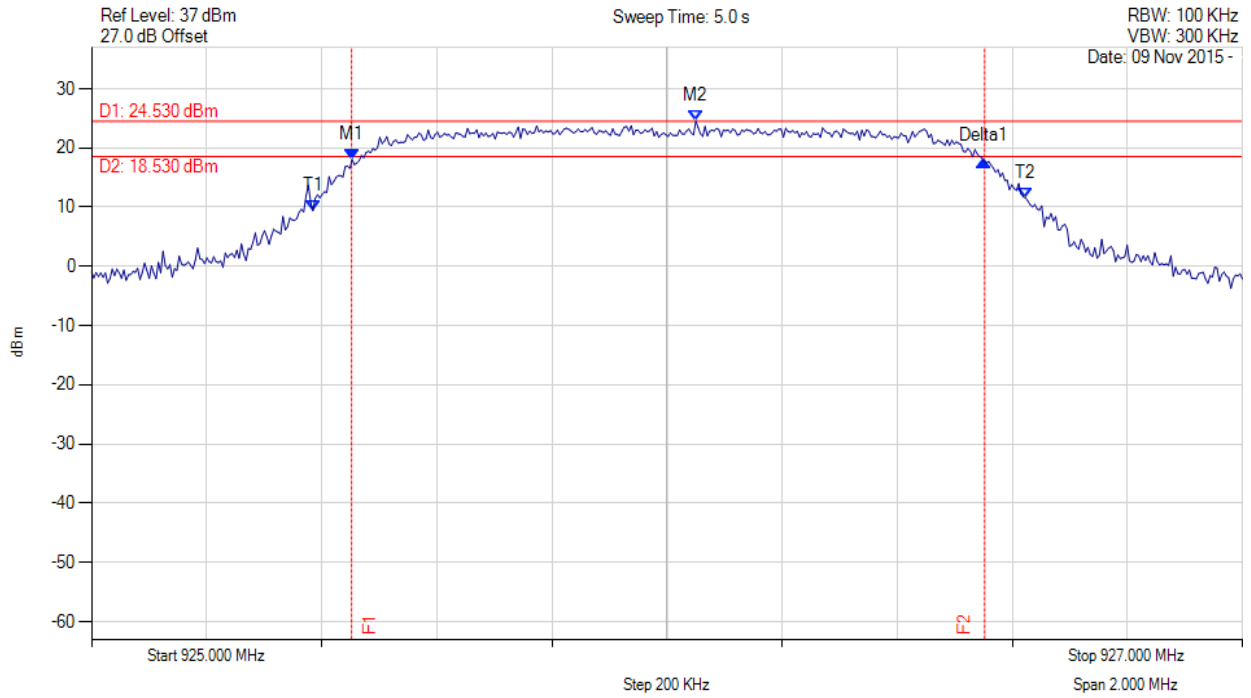

Analyser Setup	Marker:Frequency:Amplitude	Test Results
Detector = MAX PEAK Sweep Count = 0 RF Atten (dB) = 20 Trace Mode = VIEW	M1 : 925.453 MHz : 18.015 dBm M2 : 926.050 MHz : 24.531 dBm Delta1 : 1.098 MHz : -0.260 dB T1 : 925.385 MHz : 9.414 dBm T2 : 926.623 MHz : 11.535 dBm OBW : 1.238 MHz	

[back to matrix](#)

This test report may be reproduced in full only. The document may only be updated by MiCOM Labs personnel. All changes will be noted in the Document History section of the report.



A.3. Number of Channels



Hopping 902-914MHz

Variant: OQPSK, Channel: Hopping, Chain a, Temp: Ambient, Voltage: 4 Vdc

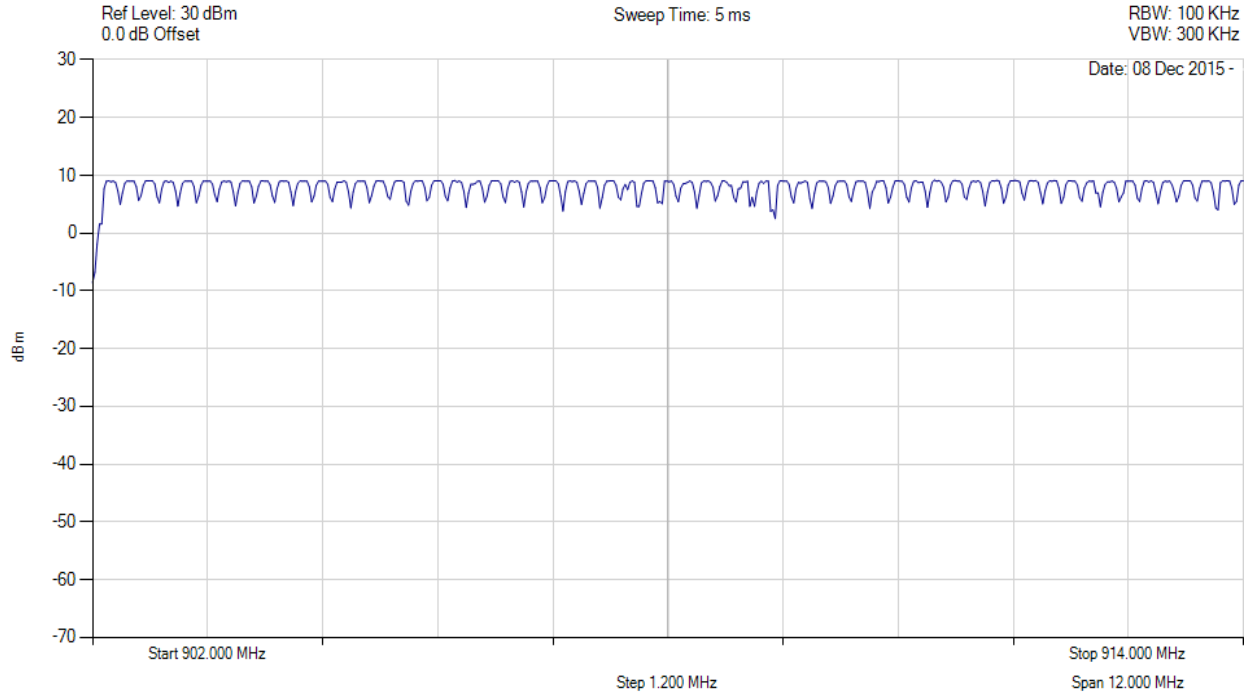

Analyser Setup	Marker:Frequency:Amplitude	Test Results
Detector = MAX PEAK Sweep Count = 0 RF Atten (dB) = 40 Trace Mode = VIEW		Channel Frequency: Hopping Number of Hops: 60

[back to matrix](#)

This test report may be reproduced in full only. The document may only be updated by MiCOM Labs personnel. All changes will be noted in the Document History section of the report.



Title: Silver Spring Networks NIC 511-0303
To: FCC CFR 47 Part 15 Subpart C 15.247 & IC RSS 247
Serial #: SSNT108-U8 Rev A
Issue Date: 11th December 2015
Page: 136 of 204



Hopping 914.00 – 928.00 MHz

Variant: OQPSK, Channel: Hopping, Chain a, Temp: Ambient, Voltage: 4 Vdc

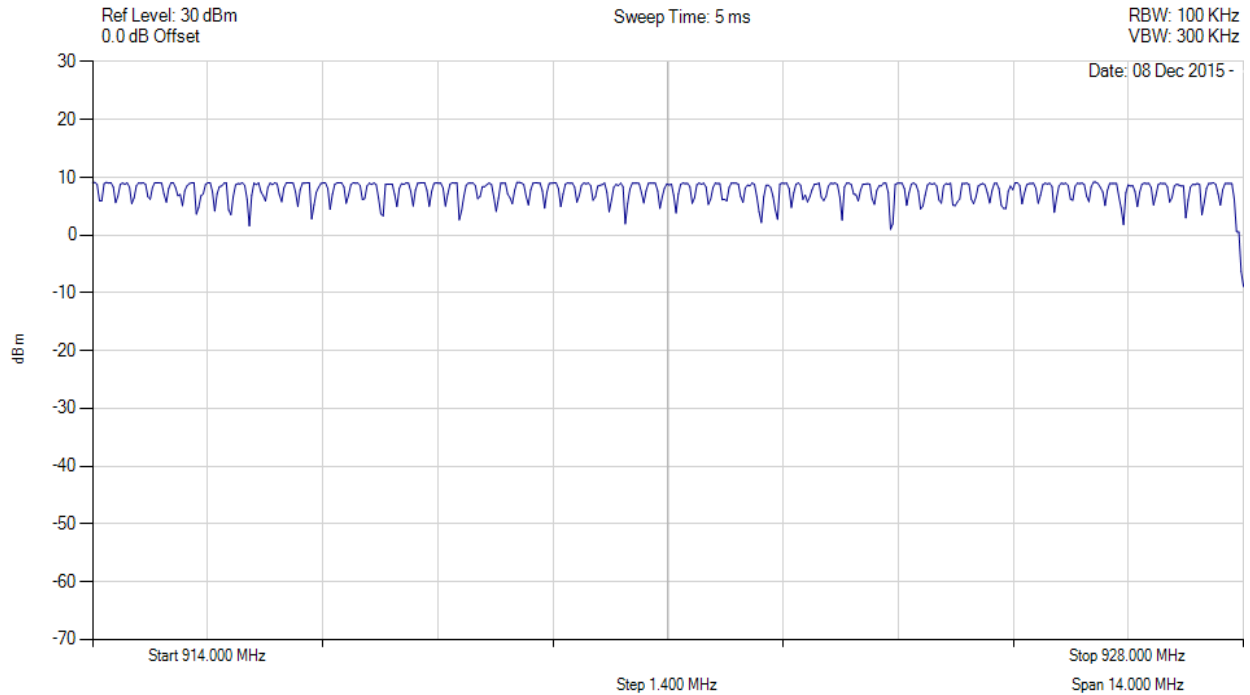

Analyser Setup	Marker:Frequency:Amplitude	Test Results
Detector = MAX PEAK Sweep Count = 0 RF Atten (dB) = 40 Trace Mode = VIEW		Channel Frequency: Hopping Number of Hops: 69

[back to matrix](#)

This test report may be reproduced in full only. The document may only be updated by MiCOM Labs personnel. All changes will be noted in the Document History section of the report.



Title: Silver Spring Networks NIC 511-0303
To: FCC CFR 47 Part 15 Subpart C 15.247 & IC RSS 247
Serial #: SSNT108-U8 Rev A
Issue Date: 11th December 2015
Page: 137 of 204



Number of Hopping Channels

Variant: OQPSK, Channel: Hopping, Chain a, Temp: Ambient, Voltage: 4 Vdc

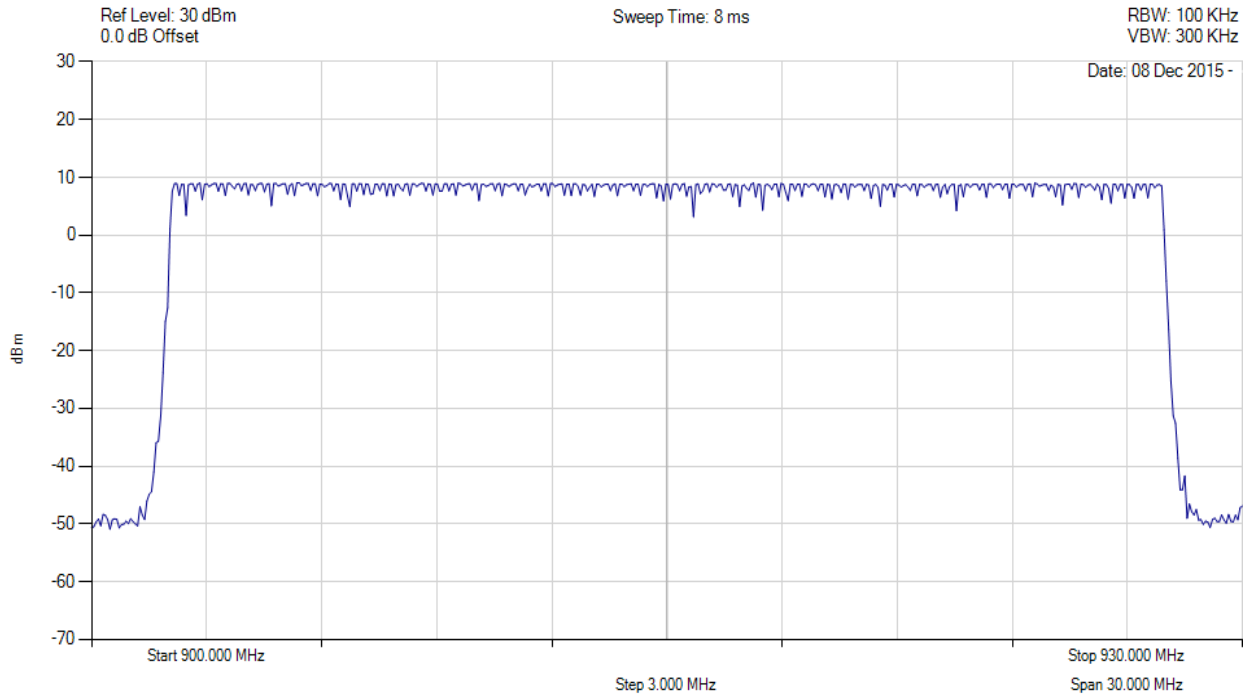

Analyser Setup	Marker:Frequency:Amplitude	Test Results
Detector = MAX PEAK Sweep Count = 0 RF Atten (dB) = 40 Trace Mode = VIEW		Channel Frequency: Hopping Number of Hops: 129

[back to matrix](#)

This test report may be reproduced in full only. The document may only be updated by MiCOM Labs personnel. All changes will be noted in the Document History section of the report.



Title: Silver Spring Networks NIC 511-0303
To: FCC CFR 47 Part 15 Subpart C 15.247 & IC RSS 247
Serial #: SSNT108-U8 Rev A
Issue Date: 11th December 2015
Page: 138 of 204



Hopping 902-914MHz

Variant: FSK, Channel: Hopping, Chain a, Temp: Ambient, Voltage: 4 Vdc

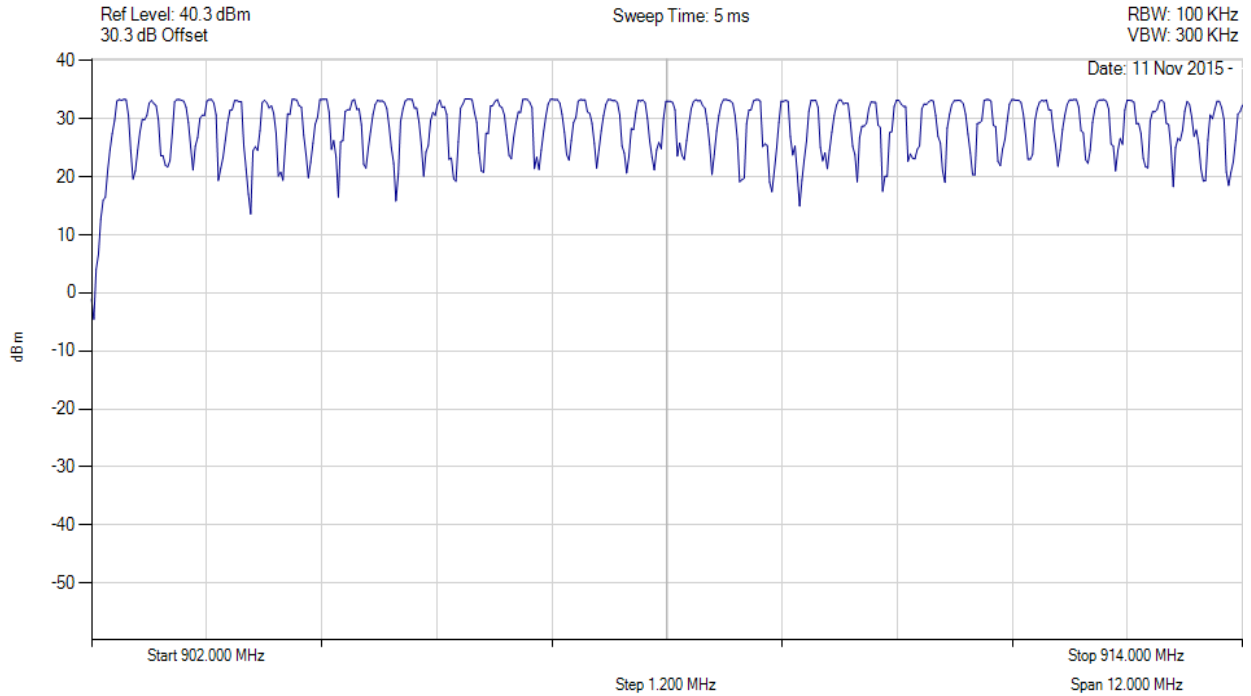

Analyser Setup	Marker:Frequency:Amplitude	Test Results
Detector = MAX PEAK Sweep Count = 0 RF Atten (dB) = 40 Trace Mode = VIEW		Channel Frequency: Hopping Number of Hops: 40

[back to matrix](#)

This test report may be reproduced in full only. The document may only be updated by MiCOM Labs personnel. All changes will be noted in the Document History section of the report.



Title: Silver Spring Networks NIC 511-0303
To: FCC CFR 47 Part 15 Subpart C 15.247 & IC RSS 247
Serial #: SSNT108-U8 Rev A
Issue Date: 11th December 2015
Page: 139 of 204



Hopping 914.00 – 928.00 MHz

Variant: FSK, Channel: Hopping, Chain a, Temp: Ambient, Voltage: 4 Vdc

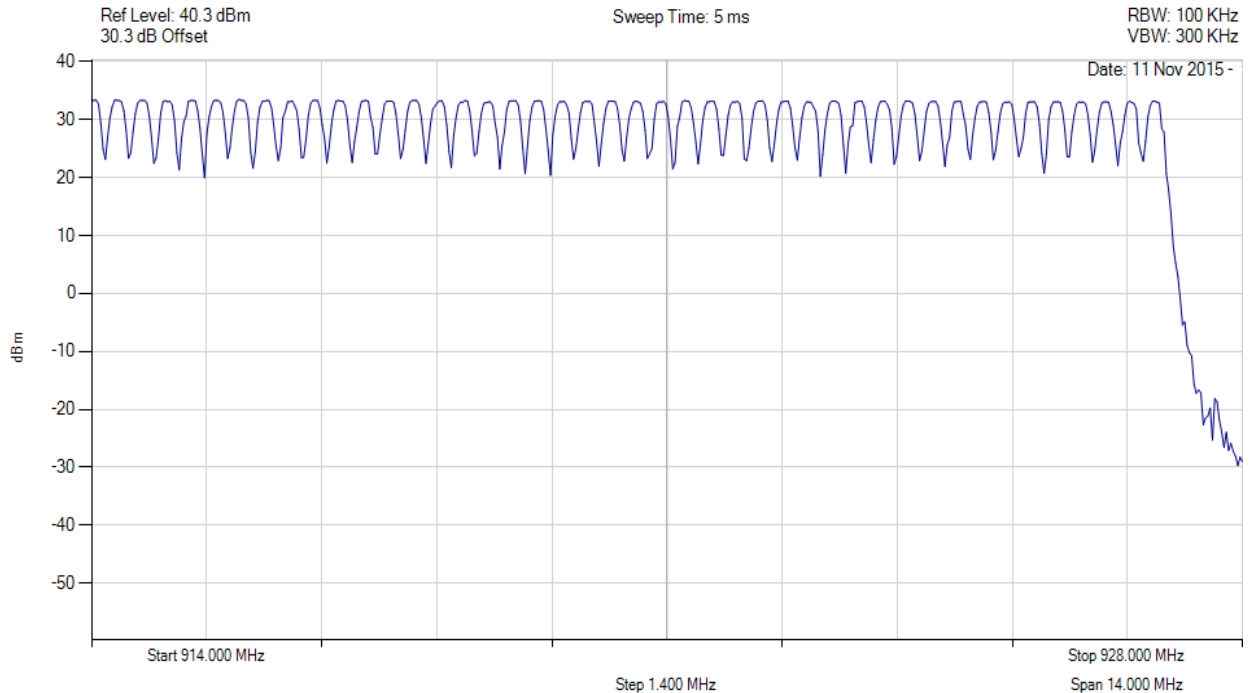

Analyser Setup	Marker: Frequency: Amplitude	Test Results
Detector = MAX PEAK Sweep Count = 0 RF Atten (dB) = 40 Trace Mode = VIEW		Channel Frequency: Hopping Number of Hops: 43

[back to matrix](#)

This test report may be reproduced in full only. The document may only be updated by MiCOM Labs personnel. All changes will be noted in the Document History section of the report.



Title: Silver Spring Networks NIC 511-0303
To: FCC CFR 47 Part 15 Subpart C 15.247 & IC RSS 247
Serial #: SSNT108-U8 Rev A
Issue Date: 11th December 2015
Page: 140 of 204



Number of Hopping Channels

Variant: FSK, Channel: Hopping, Chain a, Temp: Ambient, Voltage: 4 Vdc

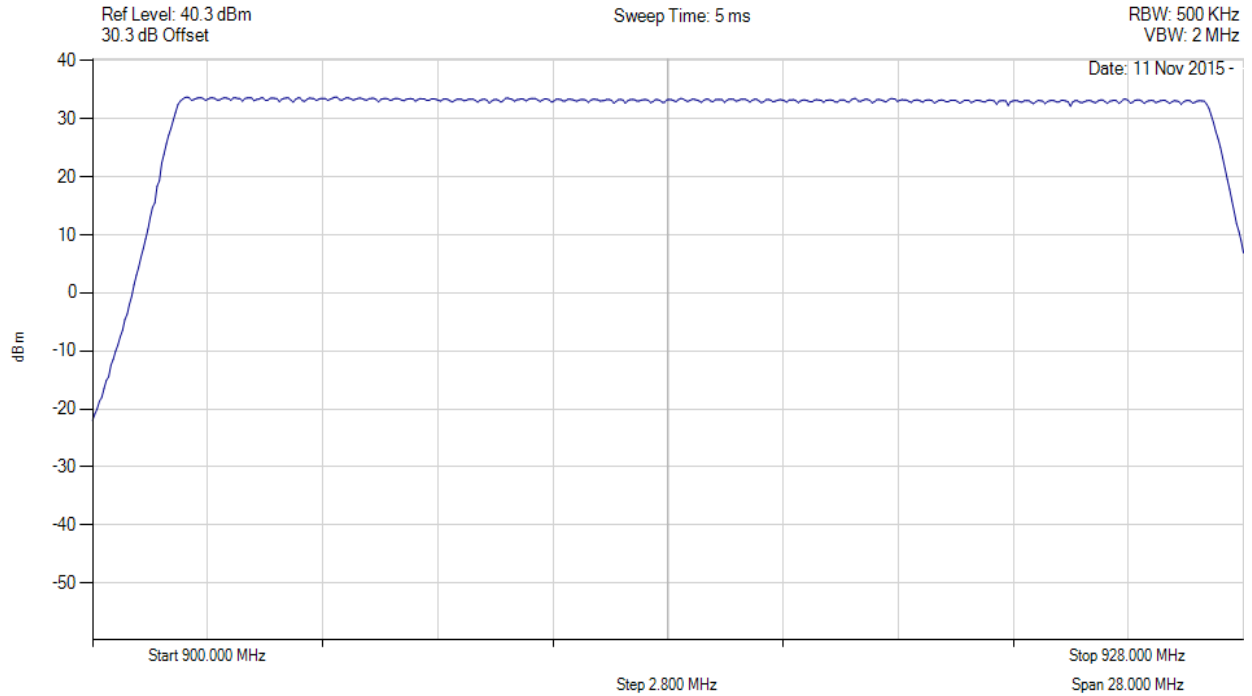

Analyser Setup	Marker:Frequency:Amplitude	Test Results
Detector = MAX PEAK Sweep Count = 0 RF Atten (dB) = 40 Trace Mode = VIEW		Channel Frequency: Hopping Number of Hops: 83

[back to matrix](#)

This test report may be reproduced in full only. The document may only be updated by MiCOM Labs personnel. All changes will be noted in the Document History section of the report.



Title: Silver Spring Networks NIC 511-0303
To: FCC CFR 47 Part 15 Subpart C 15.247 & IC RSS 247
Serial #: SSNT108-U8 Rev A
Issue Date: 11th December 2015
Page: 141 of 204

Hopping 902-914MHz



Variant: OFDM, Channel: Hopping, Chain a, Temp: Ambient, Voltage: 4 Vdc

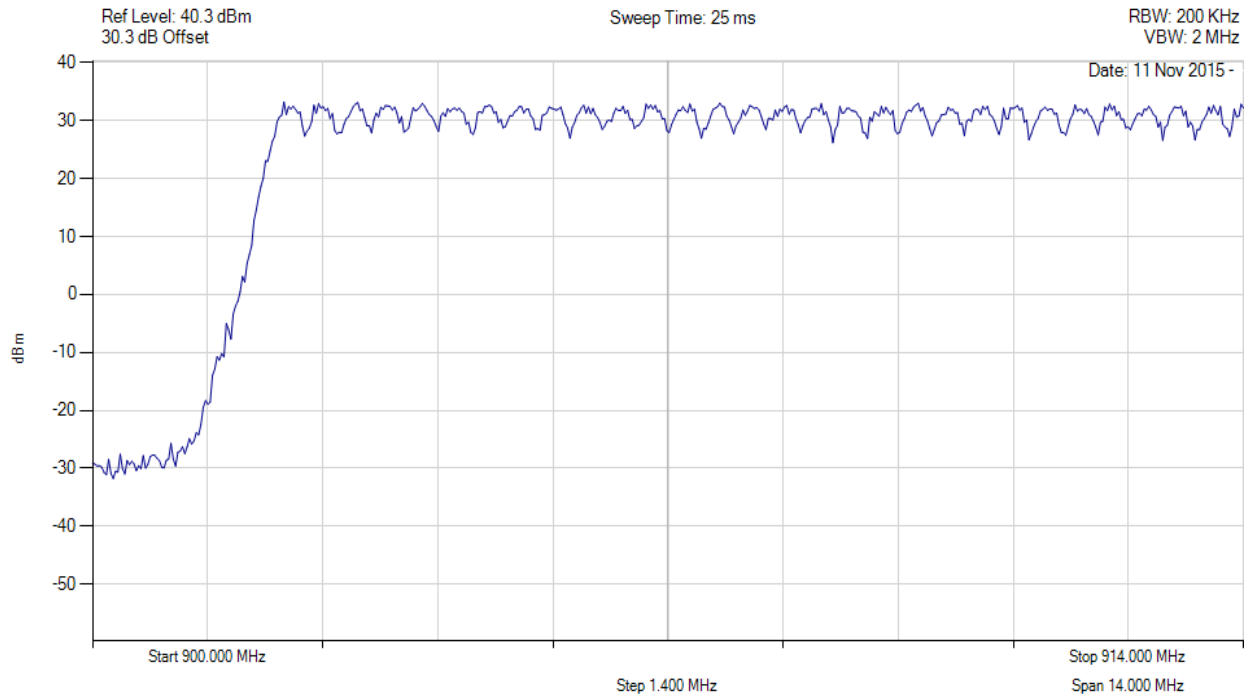

Analyser Setup	Marker:Frequency:Amplitude	Test Results
Detector = MAX PEAK Sweep Count = 0 RF Atten (dB) = 40 Trace Mode = VIEW		Channel Frequency: Hopping Number of Hops: 30

[back to matrix](#)

This test report may be reproduced in full only. The document may only be updated by MiCOM Labs personnel. All changes will be noted in the Document History section of the report.



Title: Silver Spring Networks NIC 511-0303
To: FCC CFR 47 Part 15 Subpart C 15.247 & IC RSS 247
Serial #: SSNT108-U8 Rev A
Issue Date: 11th December 2015
Page: 142 of 204



Hopping 914.00 – 928.00 MHz

Variant: OFDM, Channel: Hopping, Chain a, Temp: Ambient, Voltage: 4 Vdc

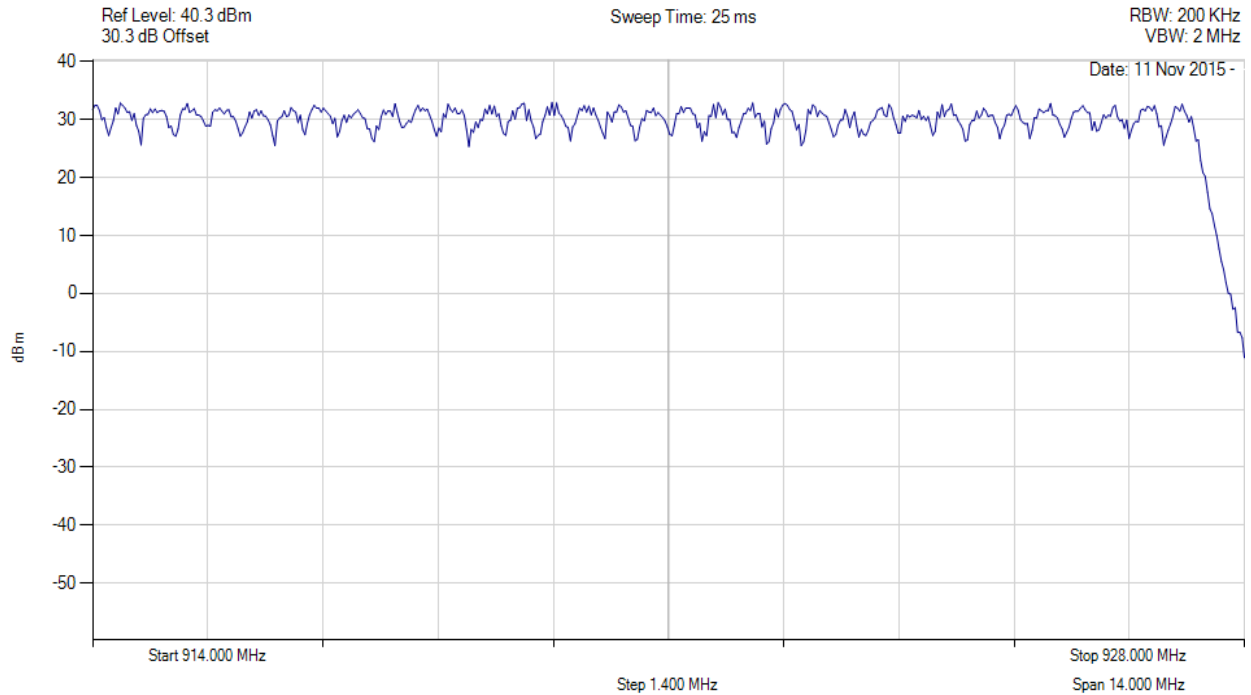

Analyser Setup	Marker: Frequency: Amplitude	Test Results
Detector = MAX PEAK Sweep Count = 0 RF Atten (dB) = 40 Trace Mode = VIEW		Channel Frequency: Hopping Number of Hops: 33

[back to matrix](#)

This test report may be reproduced in full only. The document may only be updated by MiCOM Labs personnel. All changes will be noted in the Document History section of the report.



Title: Silver Spring Networks NIC 511-0303
To: FCC CFR 47 Part 15 Subpart C 15.247 & IC RSS 247
Serial #: SSNT108-U8 Rev A
Issue Date: 11th December 2015
Page: 143 of 204



Number of Hopping Channels

Variant: OFDM, Channel: Hopping, Chain a, Temp: Ambient, Voltage: 4 Vdc

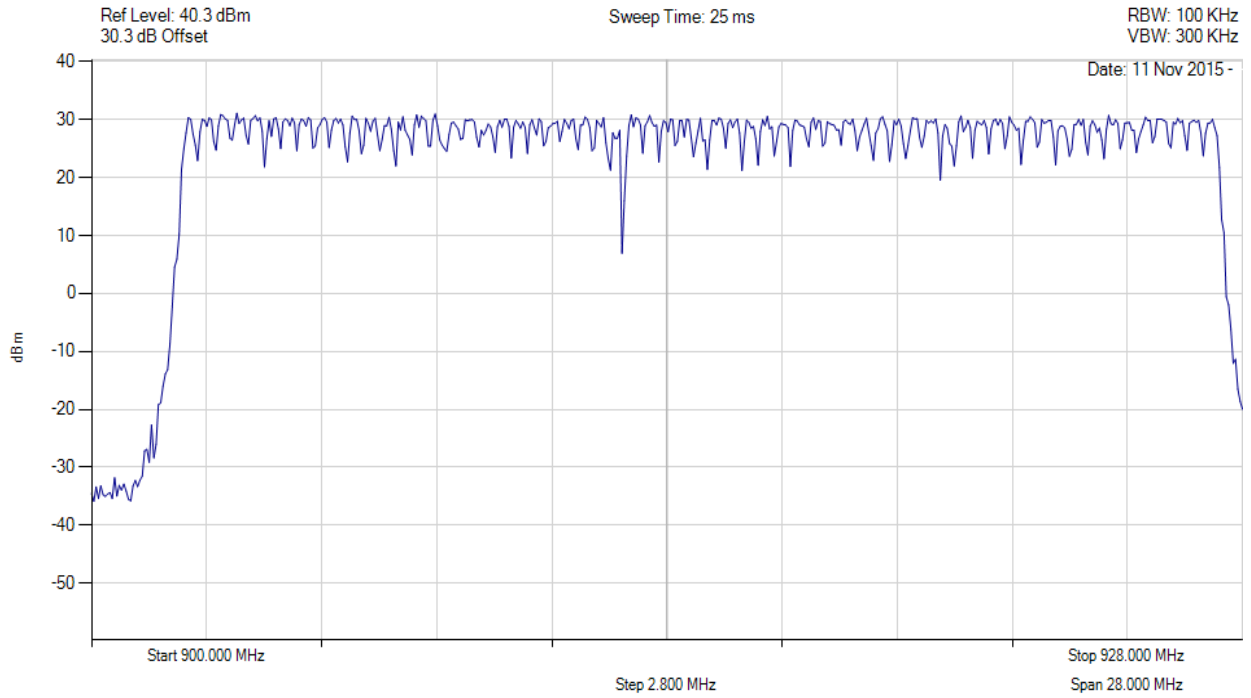

Analyser Setup	Marker:Frequency:Amplitude	Test Results
Detector = MAX PEAK Sweep Count = 0 RF Atten (dB) = 40 Trace Mode = VIEW		Channel Frequency: Hopping Number of Hops: 63

[back to matrix](#)

This test report may be reproduced in full only. The document may only be updated by MiCOM Labs personnel. All changes will be noted in the Document History section of the report.



A.4. Channel Spacing

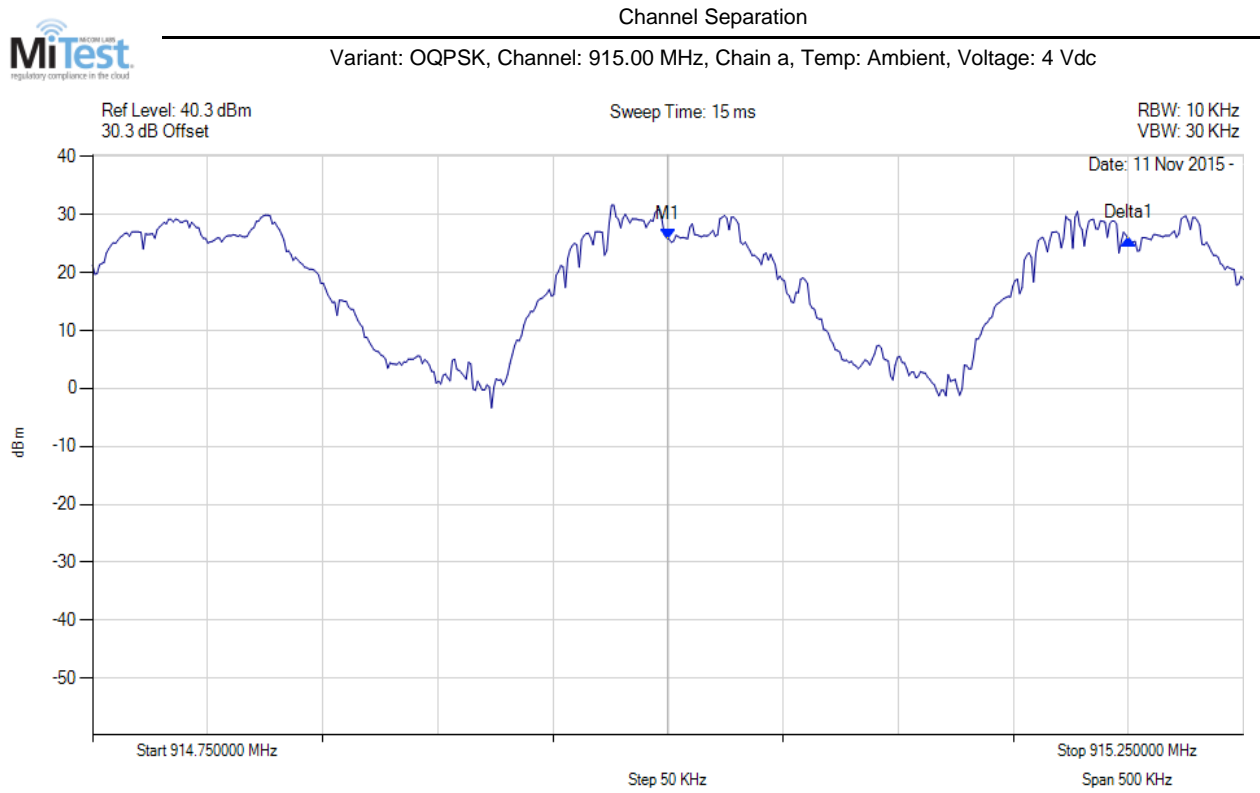

Analyser Setup	Marker:Frequency:Amplitude	Test Results
Detector = MAX PEAK Sweep Count = 0 RF Atten (dB) = 20 Trace Mode = VIEW	M1 : 915.000 MHz : 25.726 dBm Delta1 : 200 KHz : 0.114 dB	Channel Frequency: 915.00 MHz Channel Separation: 0.200 MHz

[back to matrix](#)

This test report may be reproduced in full only. The document may only be updated by MiCOM Labs personnel. All changes will be noted in the Document History section of the report.



Title: Silver Spring Networks NIC 511-0303
To: FCC CFR 47 Part 15 Subpart C 15.247 & IC RSS 247
Serial #: SSNT108-U8 Rev A
Issue Date: 11th December 2015
Page: 145 of 204

Channel Separation



Variant: FSK, Channel: 915.20 MHz, Chain a, Temp: Ambient, Voltage: 4 Vdc

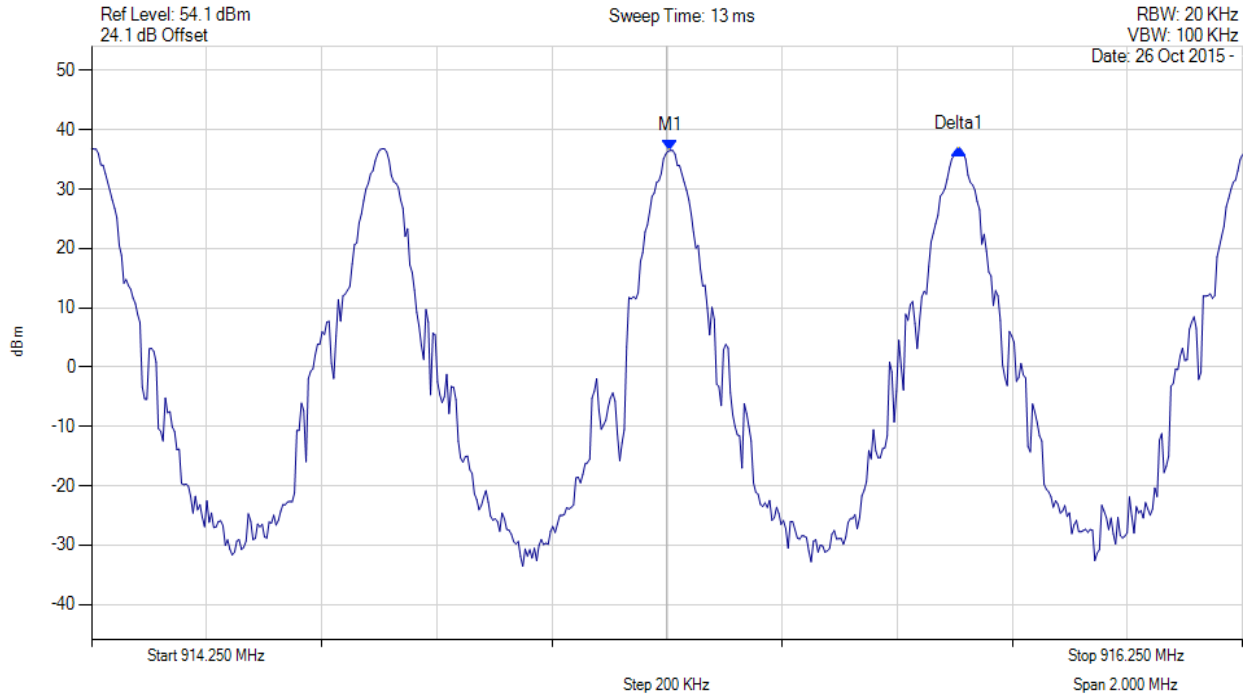

Analyser Setup	Marker:Frequency:Amplitude	Test Results
Detector = MAX PEAK Sweep Count = 0 RF Atten (dB) = 20 Trace Mode = VIEW	M1 : 915.200 MHz : 31.455 dBm Delta1 : 302 KHz : 0.275 dB	Channel Frequency: 915.20 MHz Channel Separation: 0.300 MHz

[back to matrix](#)

This test report may be reproduced in full only. The document may only be updated by MiCOM Labs personnel. All changes will be noted in the Document History section of the report.



Title: Silver Spring Networks NIC 511-0303
To: FCC CFR 47 Part 15 Subpart C 15.247 & IC RSS 247
Serial #: SSNT108-U8 Rev A
Issue Date: 11th December 2015
Page: 146 of 204

Channel Separation



Variants: OFDM, Channel: 915.20 MHz, Chain a, Temp: Ambient, Voltage: 4 Vdc

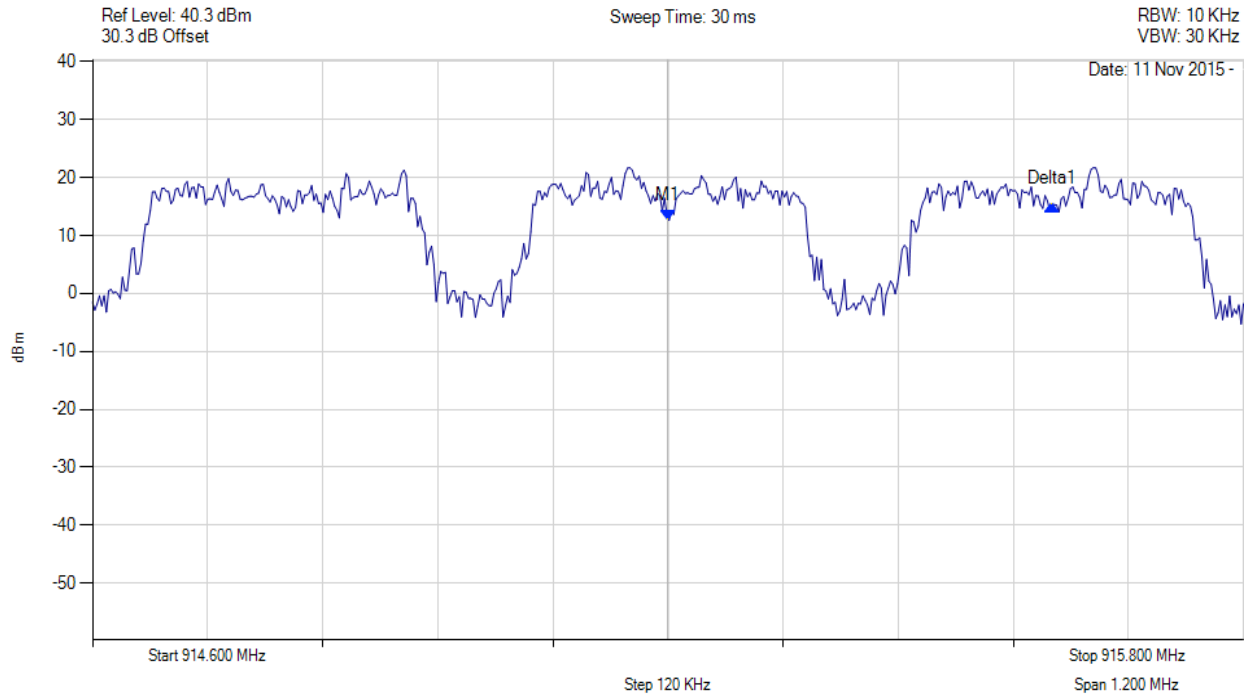

Analyser Setup	Marker:Frequency:Amplitude	Test Results
Detector = MAX PEAK Sweep Count = 0 RF Atten (dB) = 20 Trace Mode = VIEW	M1 : 915.200 MHz : 12.617 dBm Delta1 : 400 KHz : 2.731 dB	Channel Frequency: 915.20 MHz Channel Separation: 0.400 MHz

[back to matrix](#)

This test report may be reproduced in full only. The document may only be updated by MiCOM Labs personnel. All changes will be noted in the Document History section of the report.



A.5. Dwell Time & Channel Occupancy



Dwell Time

Variant: OQPSK, , Channel: 915.00 MHz, Chain a, Temp: ambient, Voltage: 4 Vdc

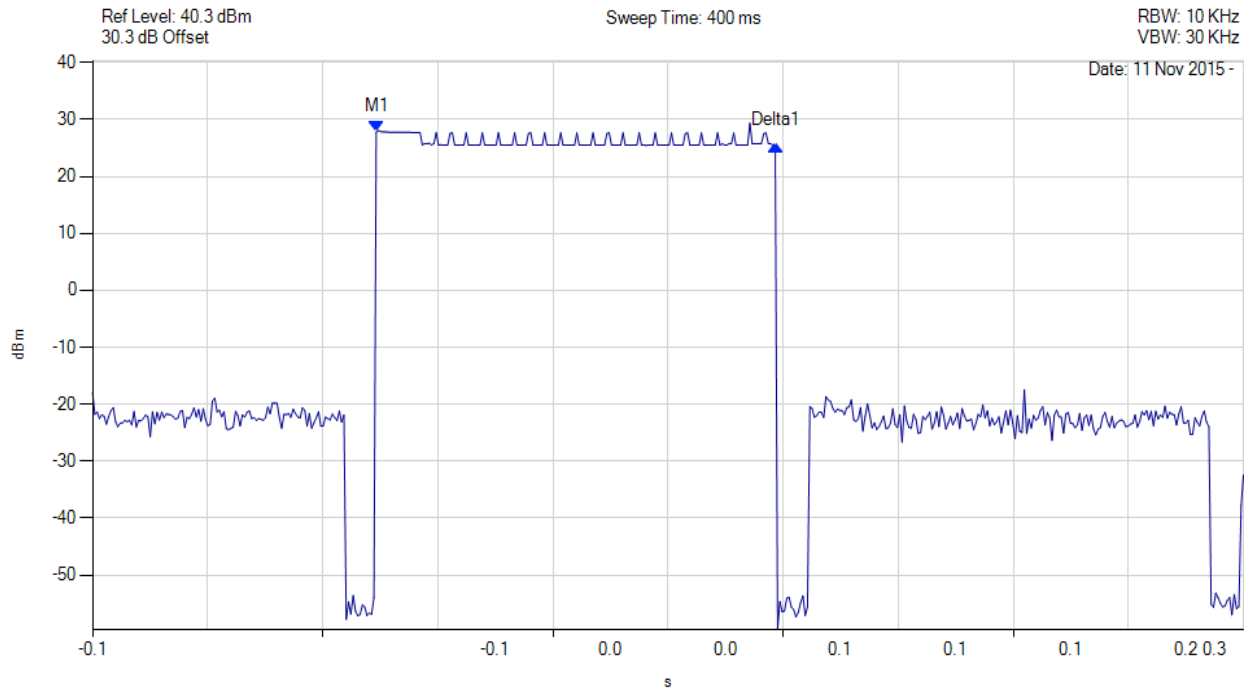

Analyser Setup	Marker:Time:Amplitude	Test Results
Detector = MAX PEAK Sweep Count = 0 RF Atten (dB) = 20 Trace Mode = VIEWS	M1(915.00 MHz) : -0.001 s : 27.790 dBm Delta1(915.00 MHz) : 0.139 s : -2.306 dB	Channel Frequency: 915.00 MHz Dwell Time: 0.139 s

[back to matrix](#)

This test report may be reproduced in full only. The document may only be updated by MiCOM Labs personnel. All changes will be noted in the Document History section of the report.



Title: Silver Spring Networks NIC 511-0303
To: FCC CFR 47 Part 15 Subpart C 15.247 & IC RSS 247
Serial #: SSNT108-U8 Rev A
Issue Date: 11th December 2015
Page: 148 of 204



Dwell Time

Variant: FSK, Channel: 915.20 MHz, Chain a, Temp: Ambient, Voltage: 4 Vdc

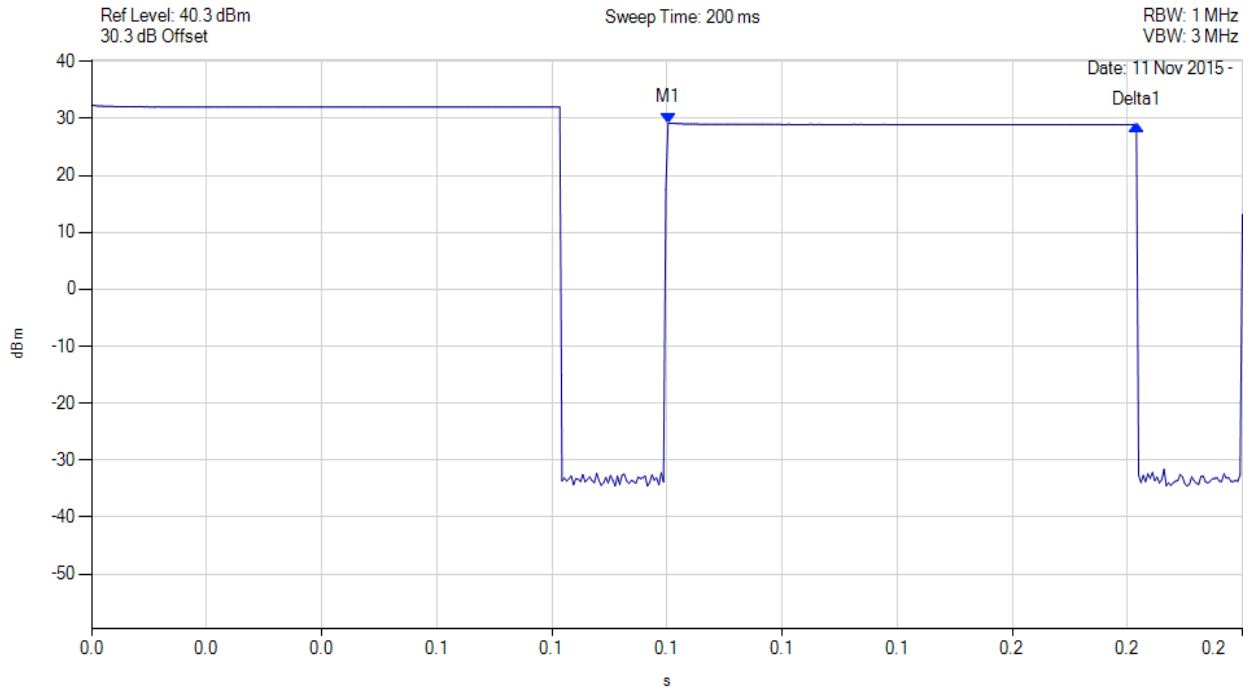

Analyser Setup	Marker:Time:Amplitude	Test Results
Detector = MAX PEAK Sweep Count = 0 RF Atten (dB) = 20 Trace Mode = VIEW	M1(915.20 MHz) : 0.100 s : 29.236 dBm Delta1(915.20 MHz) : 0.081 s : -0.348 dB	Channel Frequency: 915.20 MHz Dwell Time: 0.081 s

[back to matrix](#)

This test report may be reproduced in full only. The document may only be updated by MiCOM Labs personnel. All changes will be noted in the Document History section of the report.



Title: Silver Spring Networks NIC 511-0303
To: FCC CFR 47 Part 15 Subpart C 15.247 & IC RSS 247
Serial #: SSNT108-U8 Rev A
Issue Date: 11th December 2015
Page: 149 of 204



Dwell Time

Variant: OFDM, Channel: 915.20 MHz, Chain a, Temp: Ambient, Voltage: 4 Vdc

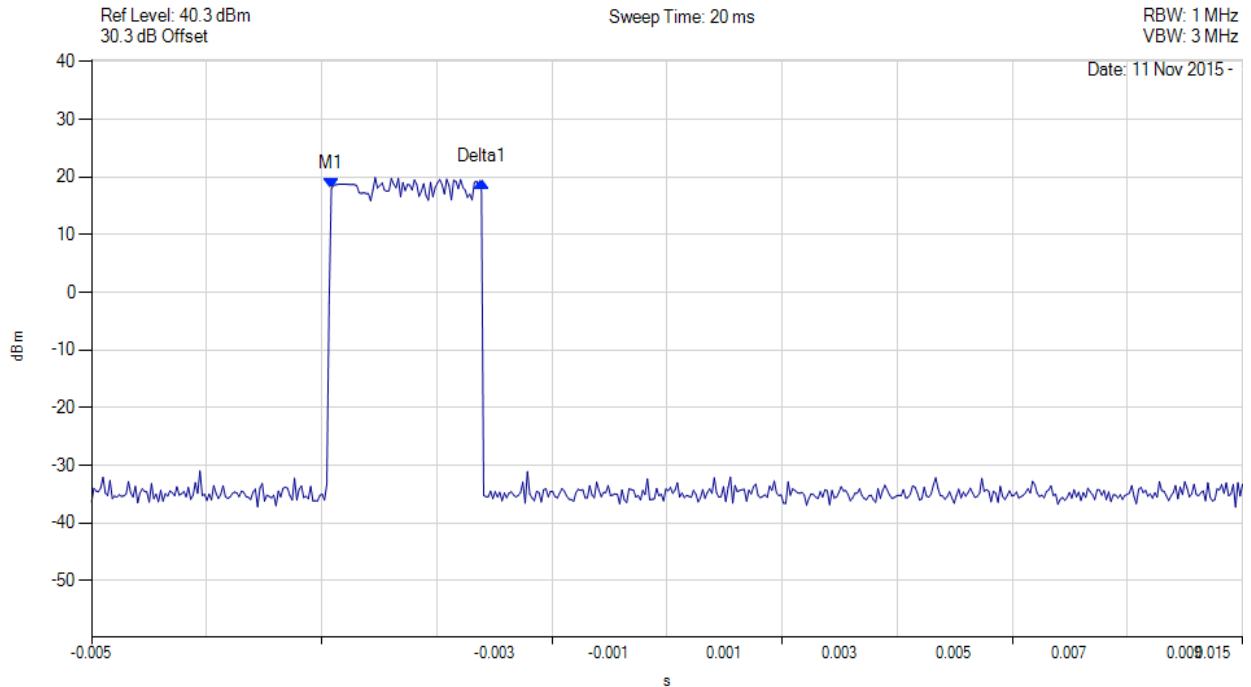

Analyser Setup	Marker:Time:Amplitude	Test Results
Detector = MAX PEAK Sweep Count = 0 RF Atten (dB) = 20 Trace Mode = VIEW	M1(915.20 MHz) : -0.001 s : 17.919 dBm Delta1(915.20 MHz) : 0.003 s : 1.310 dB	Channel Frequency: 915.20 MHz Dwell Time: 0.003 s

[back to matrix](#)

This test report may be reproduced in full only. The document may only be updated by MiCOM Labs personnel. All changes will be noted in the Document History section of the report.



Channel Occupancy



Variant: OQPSK, , Channel: 915.00 MHz, Chain a, Temp: ambient, Voltage: 4 Vdc

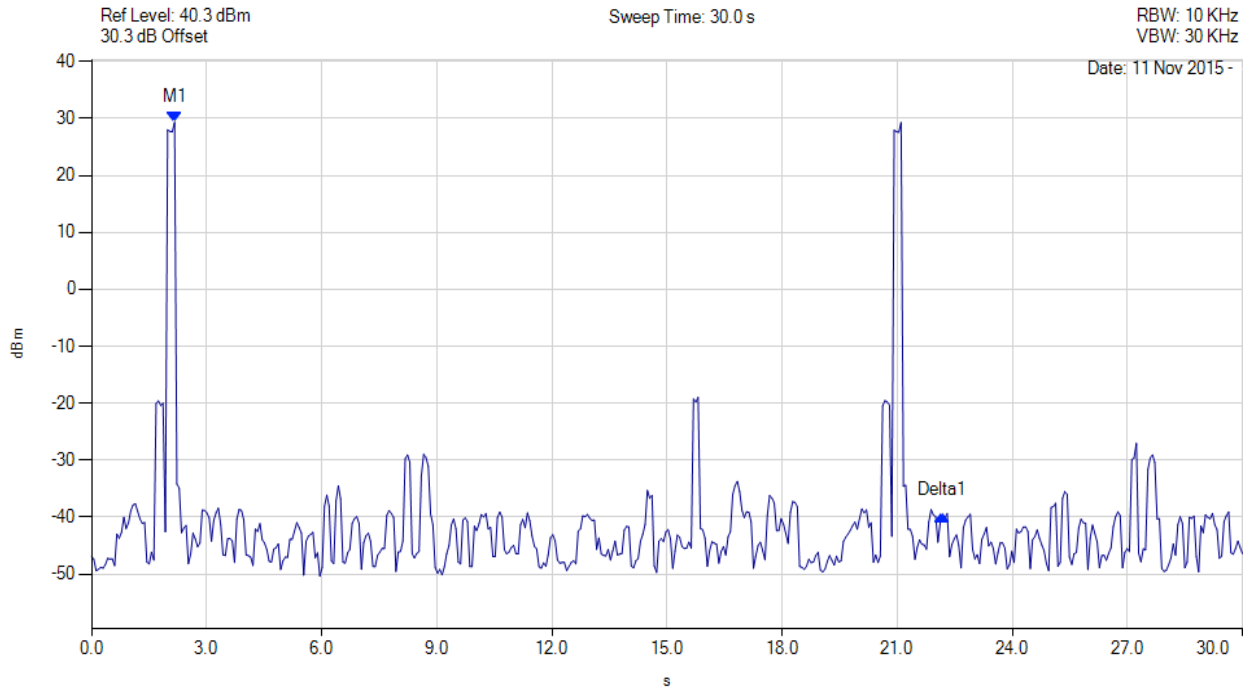

Analyser Setup	Marker:Time:Amplitude	Test Results
Detector = MAX PEAK Sweep Count = 0 RF Atten (dB) = 20 Trace Mode = VIEW	M1(915.00 MHz) : 2.164 s : 29.324 dBm Delta1(915.00 MHz) : 20.000 s : -68.944 dB	Channel Frequency: 902.75 MHz Dwell Time: 139ms Occupancy: 278 ms Limit: 400ms/20s

[back to matrix](#)

This test report may be reproduced in full only. The document may only be updated by MiCOM Labs personnel. All changes will be noted in the Document History section of the report.



Title: Silver Spring Networks NIC 511-0303
To: FCC CFR 47 Part 15 Subpart C 15.247 & IC RSS 247
Serial #: SSNT108-U8 Rev A
Issue Date: 11th December 2015
Page: 151 of 204

Channel Occupancy



Variant: FSK, Channel: 915.20 MHz, Chain a, Temp: Ambient, Voltage: 4 Vdc

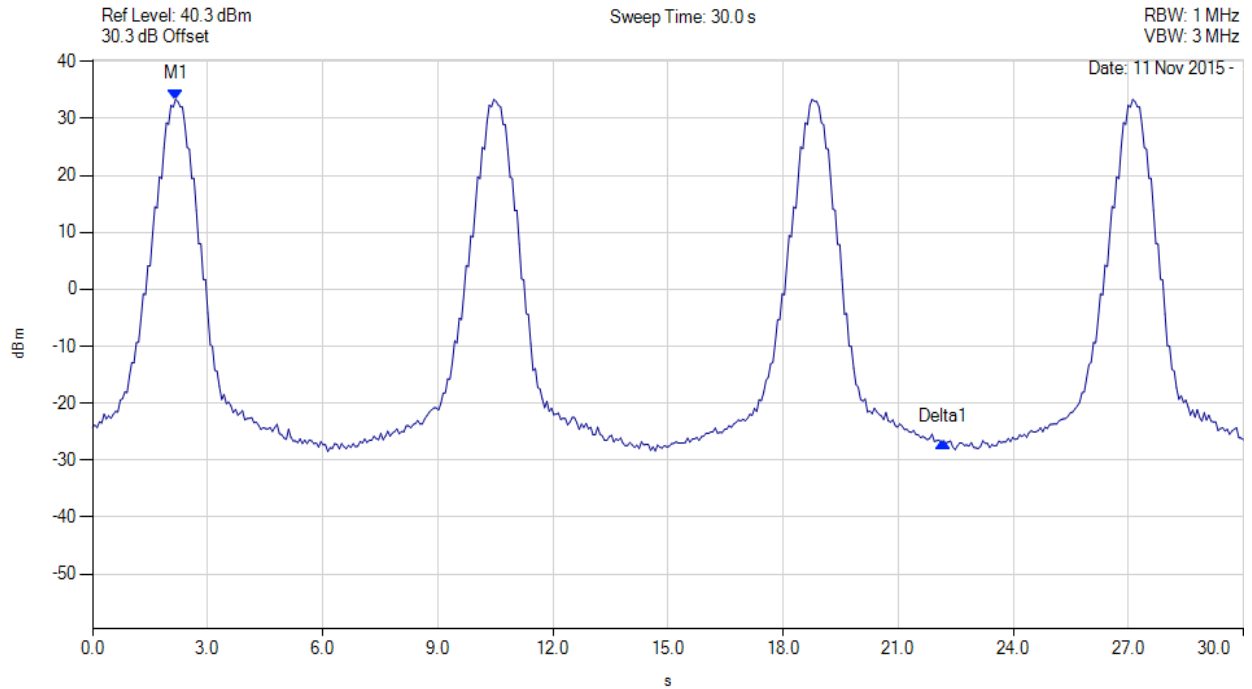

Analyser Setup	Marker:Time:Amplitude	Test Results
Detector = MAX PEAK Sweep Count = 0 RF Atten (dB) = 20 Trace Mode = MAX HOLD	M1(915.20 MHz) : 2.164 s : 33.371 dBm Delta1(915.20 MHz) : 20.000 s : -60.248 dB	Channel Frequency: 915.20 MHz Dwell Time: 81.00 ms Occupancy: 243.00 ms Limit: 400ms/20s

[back to matrix](#)

This test report may be reproduced in full only. The document may only be updated by MiCOM Labs personnel. All changes will be noted in the Document History section of the report.



Title: Silver Spring Networks NIC 511-0303
To: FCC CFR 47 Part 15 Subpart C 15.247 & IC RSS 247
Serial #: SSNT108-U8 Rev A
Issue Date: 11th December 2015
Page: 152 of 204

Channel Occupancy



Variant: OFDM, Channel: 915.20 MHz, Chain a, Temp: Ambient, Voltage: 4 Vdc

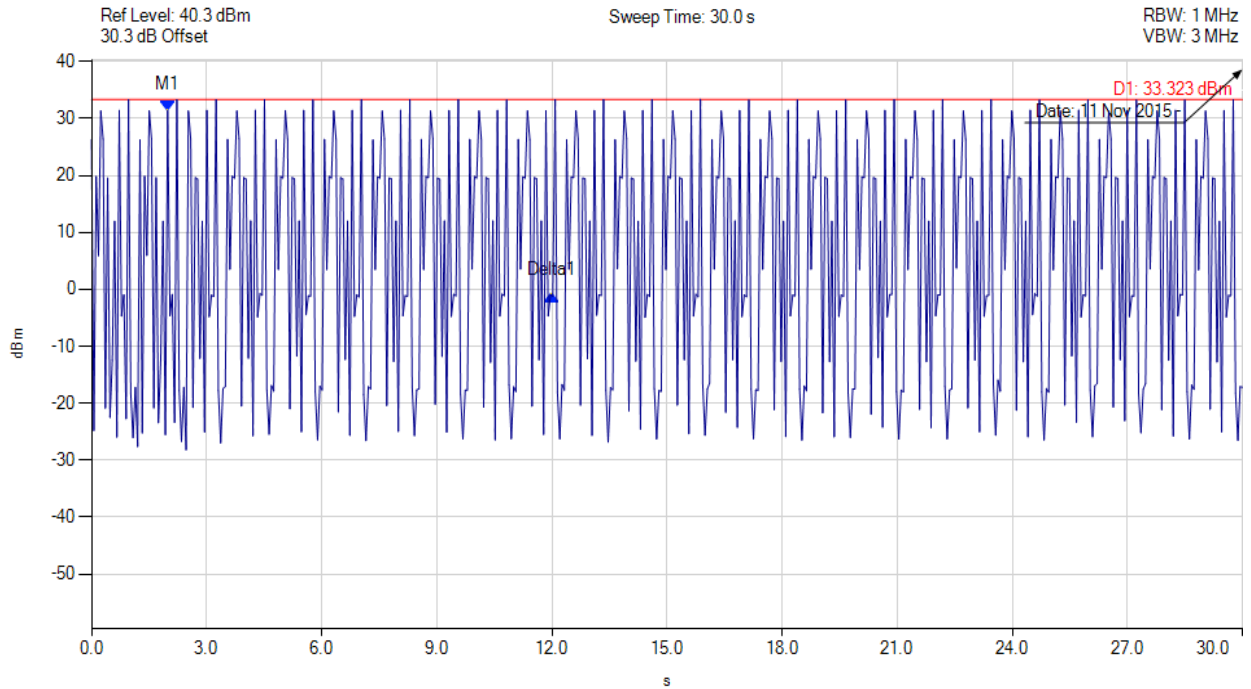

Analyser Setup	Marker:Time:Amplitude	Test Results
Detector = MAX PEAK Sweep Count = 0 RF Atten (dB) = 20 Trace Mode = VIEW	M1(915.20 MHz) : 1.984 s : 31.404 dBm Delta1(915.20 MHz) : 10.000 s : -32.347 dB	Channel Frequency: 927.25 MHz Dwell Time: 3.00 ms Occupancy: 27.00 ms Limit:400ms/10s

[back to matrix](#)

This test report may be reproduced in full only. The document may only be updated by MiCOM Labs personnel. All changes will be noted in the Document History section of the report.



A.6. Emissions

A.6.1. Conducted Emissions

A.6.1.1. Conducted Spurious Emissions

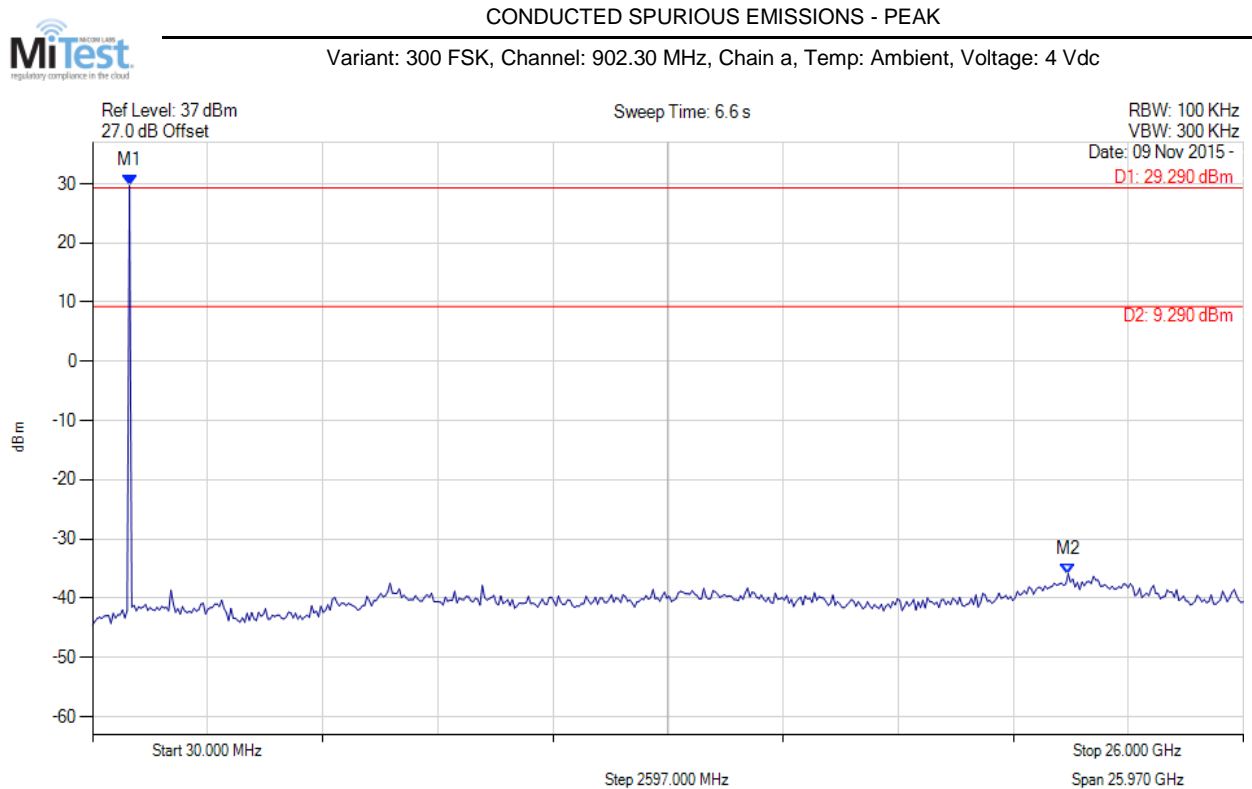

Analyser Setup	Marker:Frequency:Amplitude	Test Results
Detector = MAX PEAK Sweep Count = 0 RF Atten (dB) = 20 Trace Mode = VIEW	M1 : 862.705 MHz : 29.693 dBm M2 : 22.045 GHz : -35.879 dBm	Channel Frequency: 902.30 MHz

[back to matrix](#)

This test report may be reproduced in full only. The document may only be updated by MiCOM Labs personnel. All changes will be noted in the Document History section of the report.



Title: Silver Spring Networks NIC 511-0303
To: FCC CFR 47 Part 15 Subpart C 15.247 & IC RSS 247
Serial #: SSNT108-U8 Rev A
Issue Date: 11th December 2015
Page: 154 of 204

CONDUCTED SPURIOUS EMISSIONS - PEAK



Variant: 300 FSK, Channel: 915.20 MHz, Chain a, Temp: Ambient, Voltage: 4 Vdc

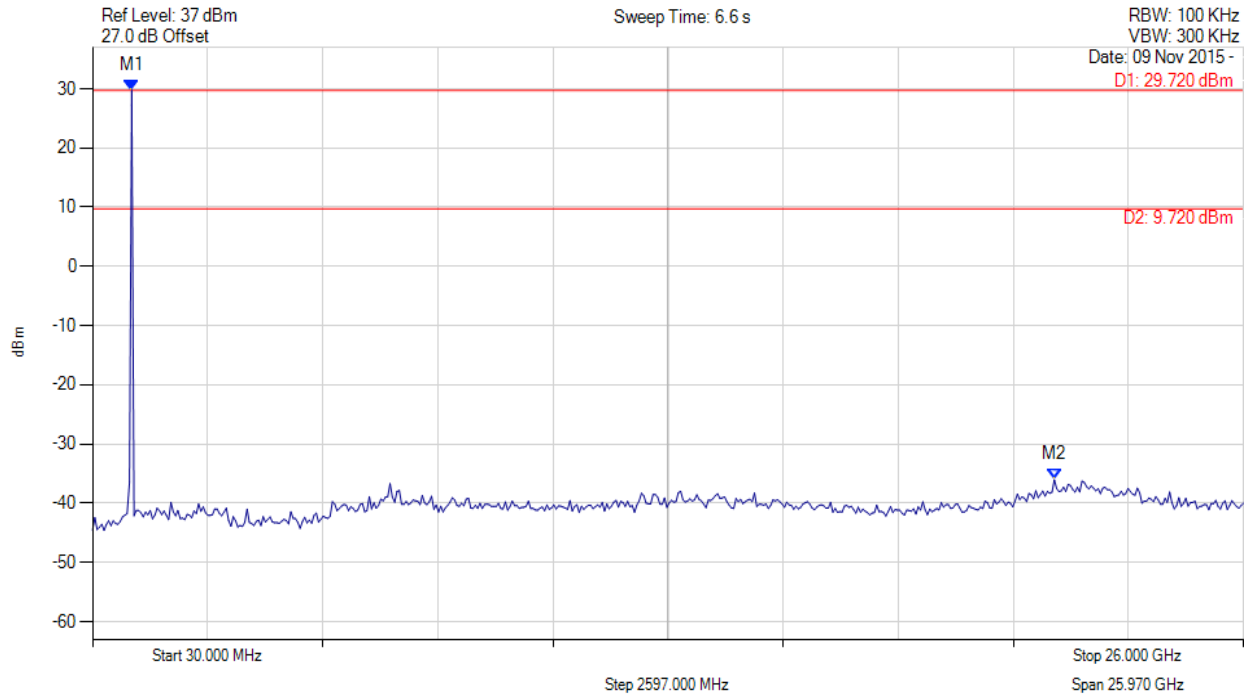

Analyser Setup	Marker:Frequency:Amplitude	Test Results
Detector = MAX PEAK Sweep Count = 0 RF Atten (dB) = 20 Trace Mode = VIEW	M1 : 914.749 MHz : 29.719 dBm M2 : 21.732 GHz : -36.024 dBm	Channel Frequency: 915.20 MHz

[back to matrix](#)

This test report may be reproduced in full only. The document may only be updated by MiCOM Labs personnel. All changes will be noted in the Document History section of the report.



Title: Silver Spring Networks NIC 511-0303
To: FCC CFR 47 Part 15 Subpart C 15.247 & IC RSS 247
Serial #: SSNT108-U8 Rev A
Issue Date: 11th December 2015
Page: 155 of 204

CONDUCTED SPURIOUS EMISSIONS - PEAK



Variant: 300 FSK, Channel: 926.90 MHz, Chain a, Temp: Ambient, Voltage: 4 Vdc

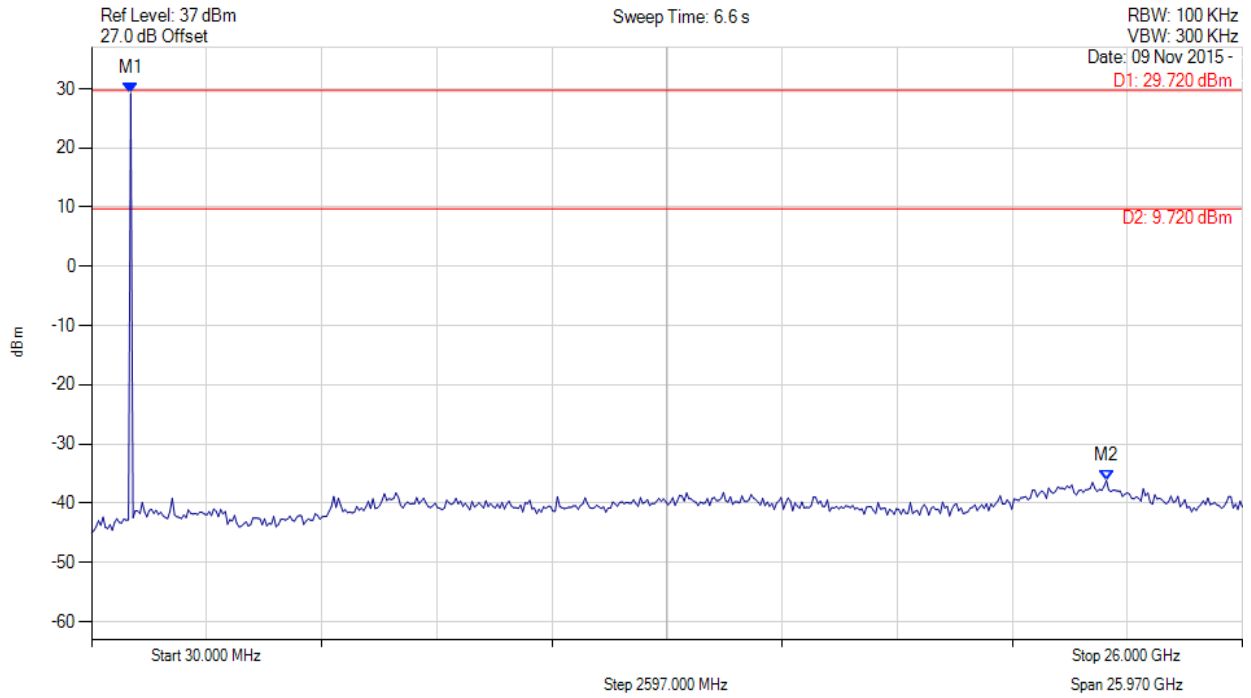

Analyser Setup	Marker:Frequency:Amplitude	Test Results
Detector = MAX PEAK Sweep Count = 0 RF Atten (dB) = 20 Trace Mode = VIEW	M1 : 914.749 MHz : 29.229 dBm M2 : 22.929 GHz : -36.140 dBm	Channel Frequency: 926.90 MHz

[back to matrix](#)

This test report may be reproduced in full only. The document may only be updated by MiCOM Labs personnel. All changes will be noted in the Document History section of the report.



Title: Silver Spring Networks NIC 511-0303
To: FCC CFR 47 Part 15 Subpart C 15.247 & IC RSS 247
Serial #: SSNT108-U8 Rev A
Issue Date: 11th December 2015
Page: 156 of 204

CONDUCTED SPURIOUS EMISSIONS - PEAK



Variant: 300 GFSK, Channel: 902.30 MHz, Chain a, Temp: Ambient, Voltage: 4 Vdc

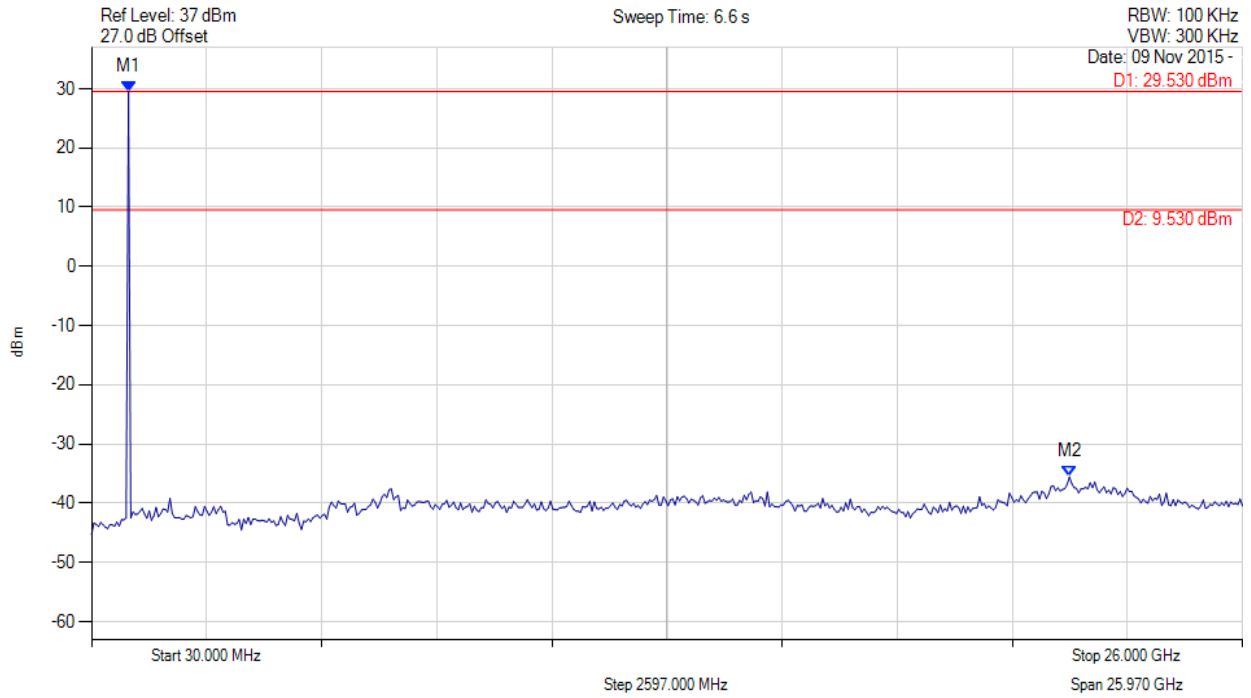

Analyser Setup	Marker:Frequency:Amplitude	Test Results
Detector = MAX PEAK Sweep Count = 0 RF Atten (dB) = 20 Trace Mode = VIEW	M1 : 862.705 MHz : 29.526 dBm M2 : 22.097 GHz : -35.538 dBm	Channel Frequency: 902.30 MHz

[back to matrix](#)

This test report may be reproduced in full only. The document may only be updated by MiCOM Labs personnel. All changes will be noted in the Document History section of the report.



Title: Silver Spring Networks NIC 511-0303
To: FCC CFR 47 Part 15 Subpart C 15.247 & IC RSS 247
Serial #: SSNT108-U8 Rev A
Issue Date: 11th December 2015
Page: 157 of 204

CONDUCTED SPURIOUS EMISSIONS - PEAK



Variant: 300 GFSK, Channel: 915.20 MHz, Chain a, Temp: Ambient, Voltage: 4 Vdc

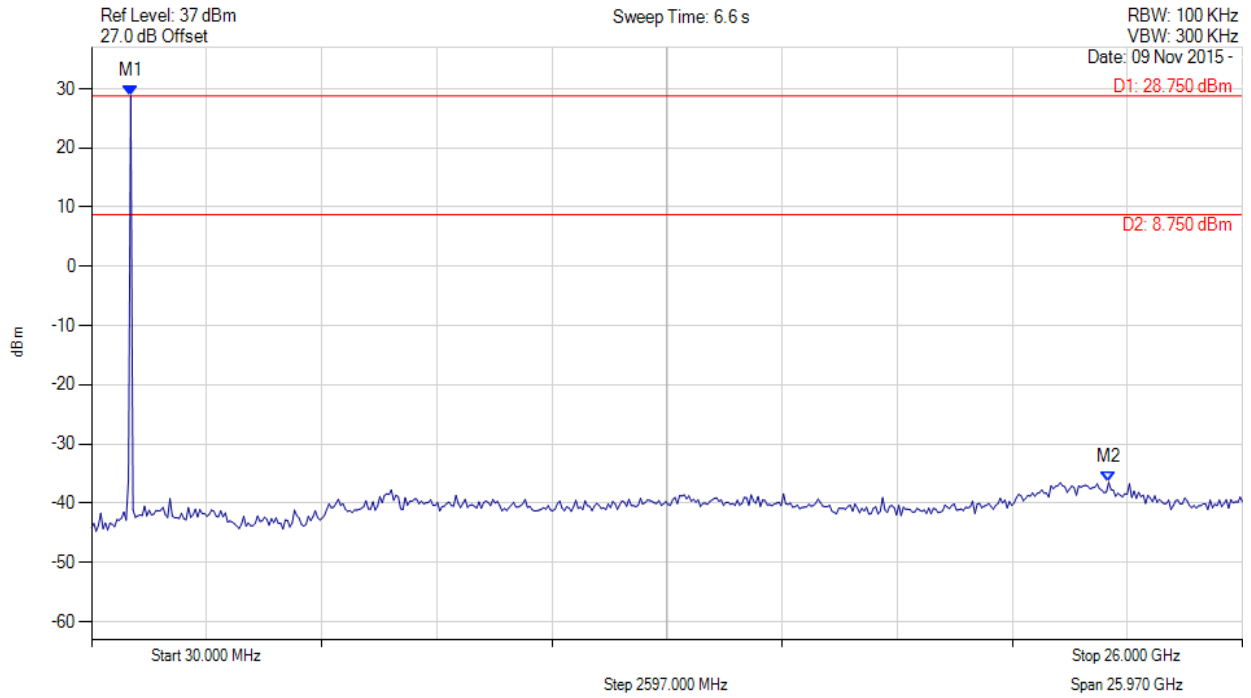

Analyser Setup	Marker:Frequency:Amplitude	Test Results
Detector = MAX PEAK Sweep Count = 0 RF Atten (dB) = 20 Trace Mode = VIEW	M1 : 914.749 MHz : 28.753 dBm M2 : 22.981 GHz : -36.469 dBm	Channel Frequency: 915.20 MHz

[back to matrix](#)

This test report may be reproduced in full only. The document may only be updated by MiCOM Labs personnel. All changes will be noted in the Document History section of the report.



CONDUCTED SPURIOUS EMISSIONS - PEAK



Variant: 300 GFSK, Channel: 926.90 MHz, Chain a, Temp: Ambient, Voltage: 4 Vdc

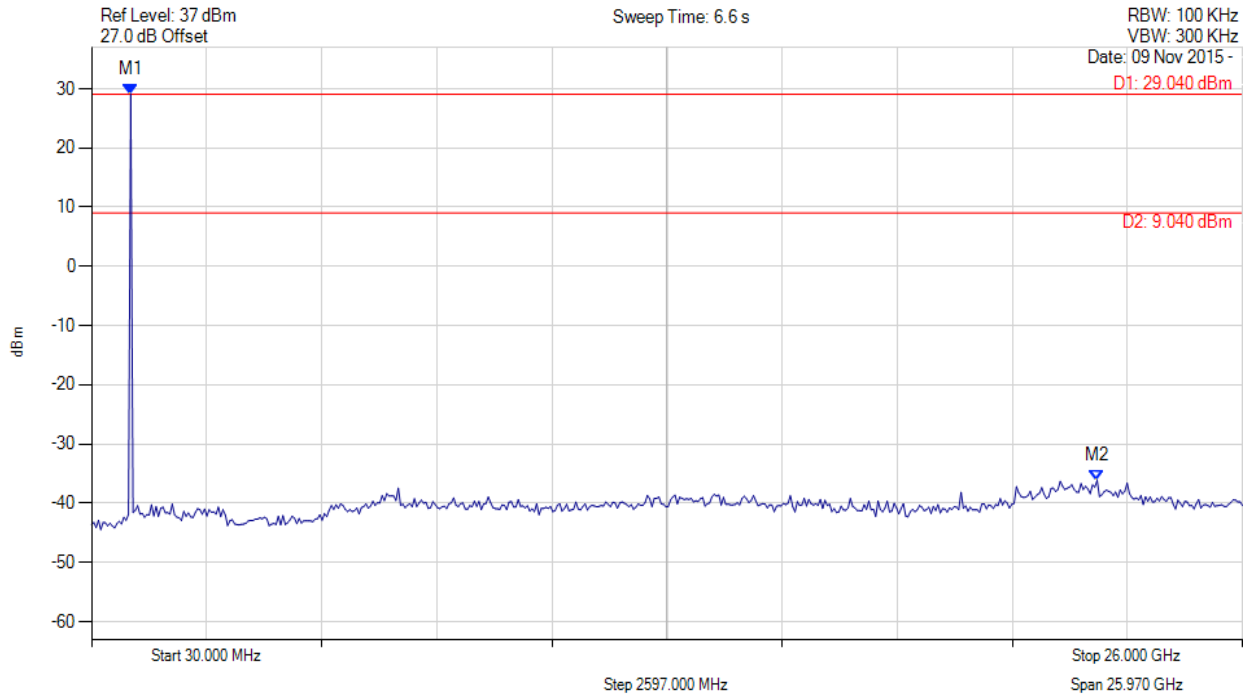

Analyser Setup	Marker:Frequency:Amplitude	Test Results
Detector = MAX PEAK Sweep Count = 0 RF Atten (dB) = 20 Trace Mode = VIEW	M1 : 914.749 MHz : 29.040 dBm M2 : 22.721 GHz : -36.142 dBm	Channel Frequency: 926.90 MHz

[back to matrix](#)

This test report may be reproduced in full only. The document may only be updated by MiCOM Labs personnel. All changes will be noted in the Document History section of the report.



Title: Silver Spring Networks NIC 511-0303
To: FCC CFR 47 Part 15 Subpart C 15.247 & IC RSS 247
Serial #: SSNT108-U8 Rev A
Issue Date: 11th December 2015
Page: 159 of 204

CONDUCTED SPURIOUS EMISSIONS - PEAK



Variant: 300 GFSK, Channel: 902.30 MHz, Chain a, Temp: Ambient, Voltage: 4 Vdc

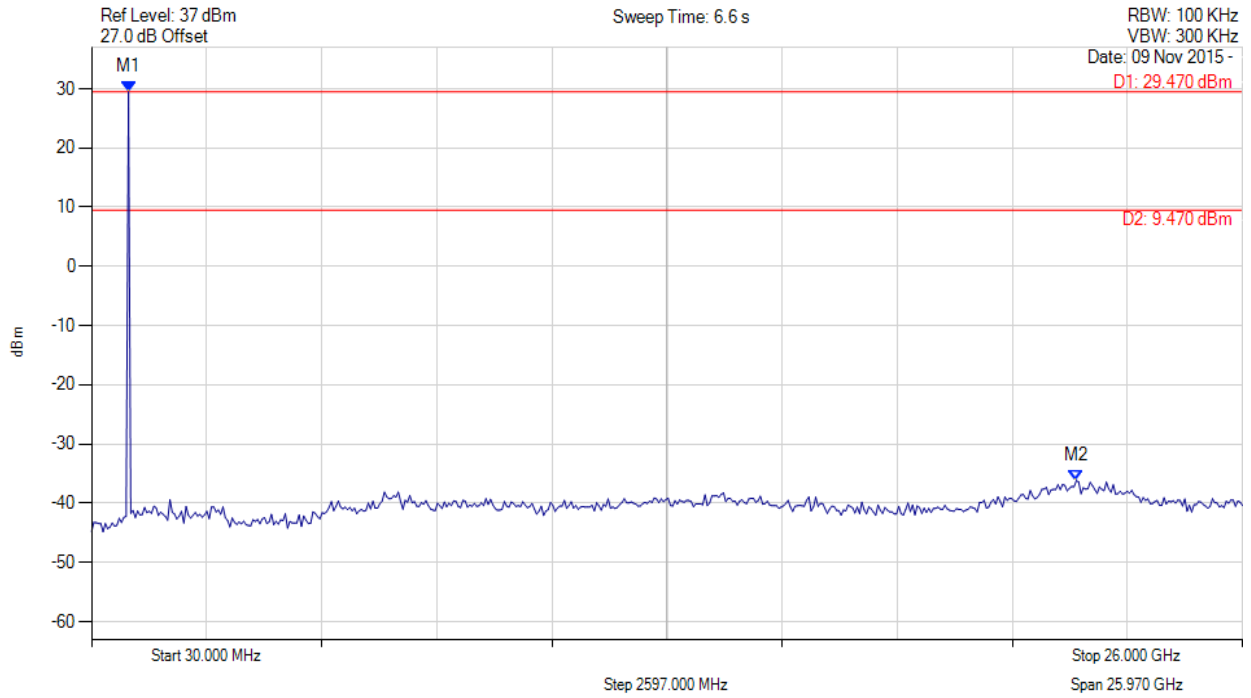

Analyser Setup	Marker:Frequency:Amplitude	Test Results
Detector = MAX PEAK Sweep Count = 0 RF Atten (dB) = 20 Trace Mode = VIEW	M1 : 862.705 MHz : 29.469 dBm M2 : 22.253 GHz : -36.142 dBm	Channel Frequency: 902.20 MHz

[back to matrix](#)

This test report may be reproduced in full only. The document may only be updated by MiCOM Labs personnel. All changes will be noted in the Document History section of the report.



Title: Silver Spring Networks NIC 511-0303
To: FCC CFR 47 Part 15 Subpart C 15.247 & IC RSS 247
Serial #: SSNT108-U8 Rev A
Issue Date: 11th December 2015
Page: 160 of 204

CONDUCTED SPURIOUS EMISSIONS - PEAK



Variant: 300 GFSK, Channel: 915.20 MHz, Chain a, Temp: Ambient, Voltage: 4 Vdc

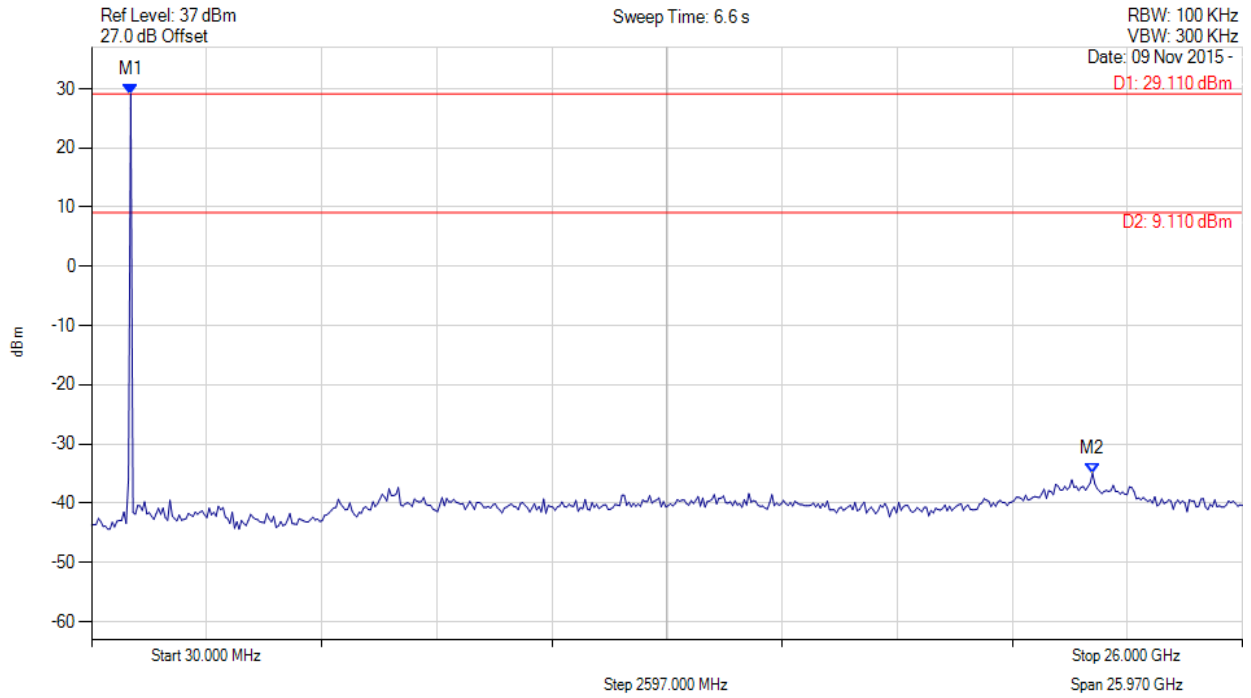

Analyser Setup	Marker:Frequency:Amplitude	Test Results
Detector = MAX PEAK Sweep Count = 0 RF Atten (dB) = 20 Trace Mode = VIEW	M1 : 914.749 MHz : 29.109 dBm M2 : 22.617 GHz : -34.942 dBm	Channel Frequency: 915.20 MHz

[back to matrix](#)

This test report may be reproduced in full only. The document may only be updated by MiCOM Labs personnel. All changes will be noted in the Document History section of the report.



Title: Silver Spring Networks NIC 511-0303
To: FCC CFR 47 Part 15 Subpart C 15.247 & IC RSS 247
Serial #: SSNT108-U8 Rev A
Issue Date: 11th December 2015
Page: 161 of 204

CONDUCTED SPURIOUS EMISSIONS - PEAK



Variant: 300 GFSK, Channel: 926.90 MHz, Chain a, Temp: Ambient, Voltage: 4 Vdc

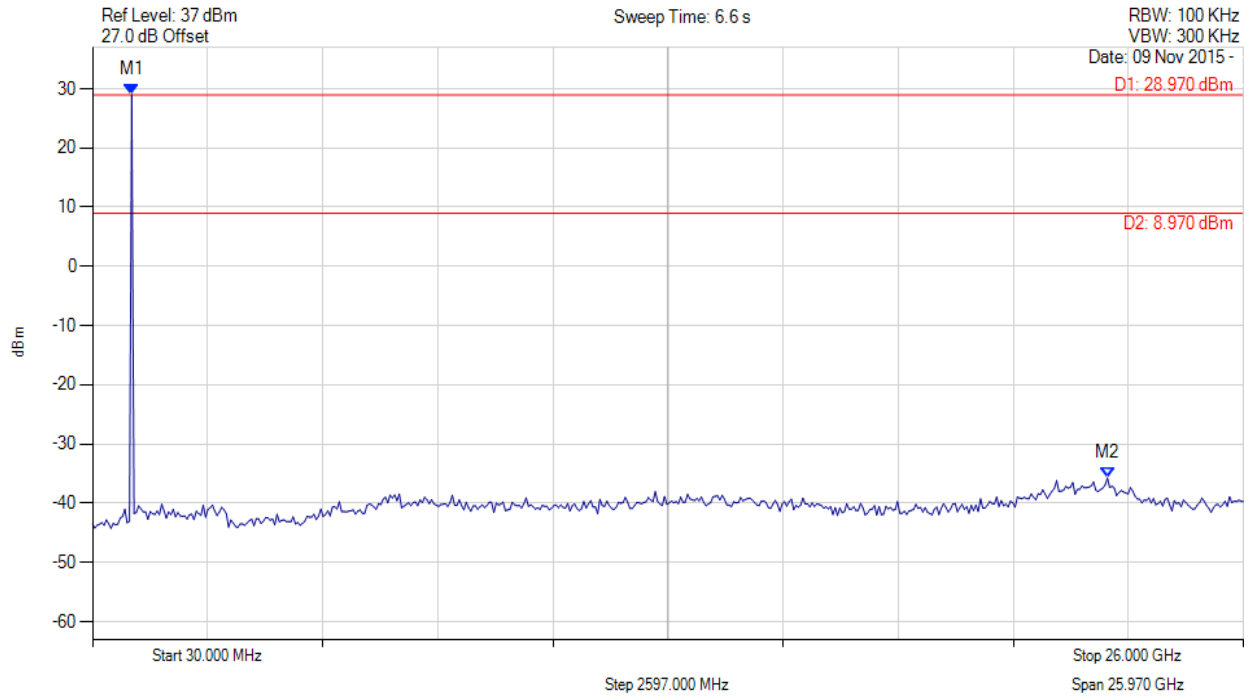

Analyser Setup	Marker:Frequency:Amplitude	Test Results
Detector = MAX PEAK Sweep Count = 0 RF Atten (dB) = 20 Trace Mode = VIEW	M1 : 914.749 MHz : 28.969 dBm M2 : 22.929 GHz : -35.747 dBm	Channel Frequency: 926.90 MHz

[back to matrix](#)

This test report may be reproduced in full only. The document may only be updated by MiCOM Labs personnel. All changes will be noted in the Document History section of the report.



CONDUCTED SPURIOUS EMISSIONS - PEAK



Variant: 400 FSK, Channel: 902.40 MHz, Chain a, Temp: Ambient, Voltage: 4 Vdc

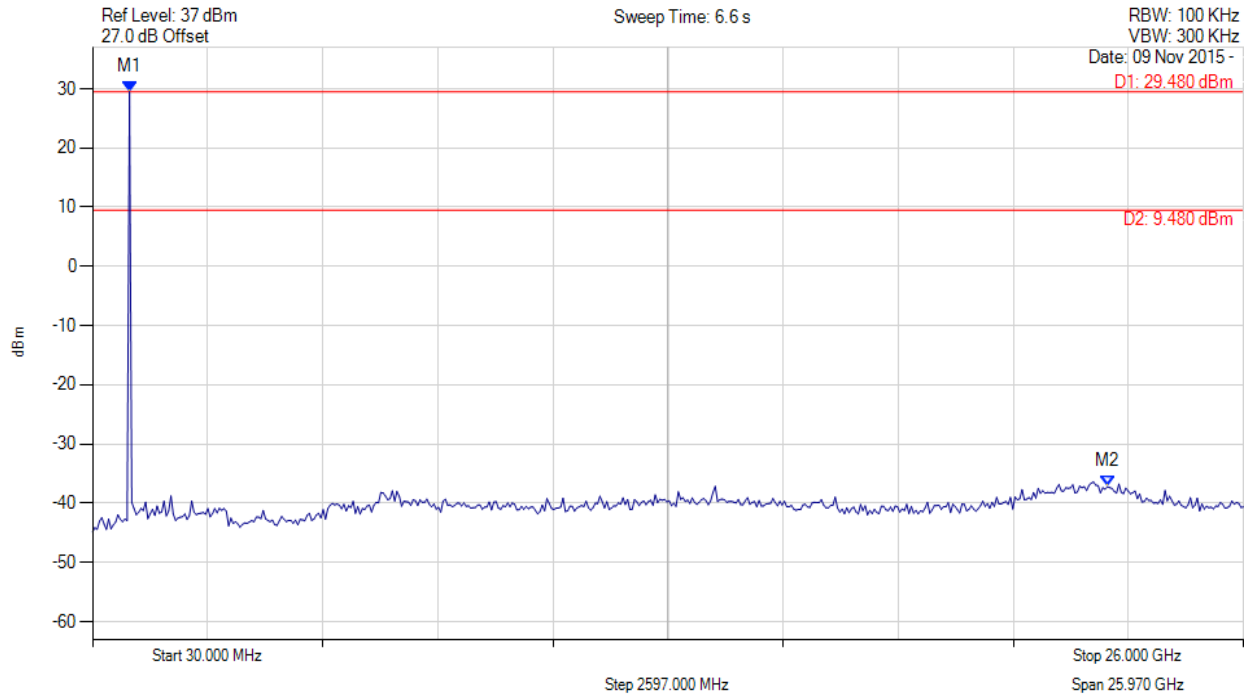

Analyser Setup	Marker:Frequency:Amplitude	Test Results
Detector = MAX PEAK Sweep Count = 0 RF Atten (dB) = 20 Trace Mode = VIEW	M1 : 862.705 MHz : 29.483 dBm M2 : 22.929 GHz : -37.195 dBm	Channel Frequency: 902.40 MHz

[back to matrix](#)

This test report may be reproduced in full only. The document may only be updated by MiCOM Labs personnel. All changes will be noted in the Document History section of the report.



Title: Silver Spring Networks NIC 511-0303
To: FCC CFR 47 Part 15 Subpart C 15.247 & IC RSS 247
Serial #: SSNT108-U8 Rev A
Issue Date: 11th December 2015
Page: 163 of 204

CONDUCTED SPURIOUS EMISSIONS - PEAK



Variant: 400 FSK, Channel: 915.20 MHz, Chain a, Temp: Ambient, Voltage: 4 Vdc

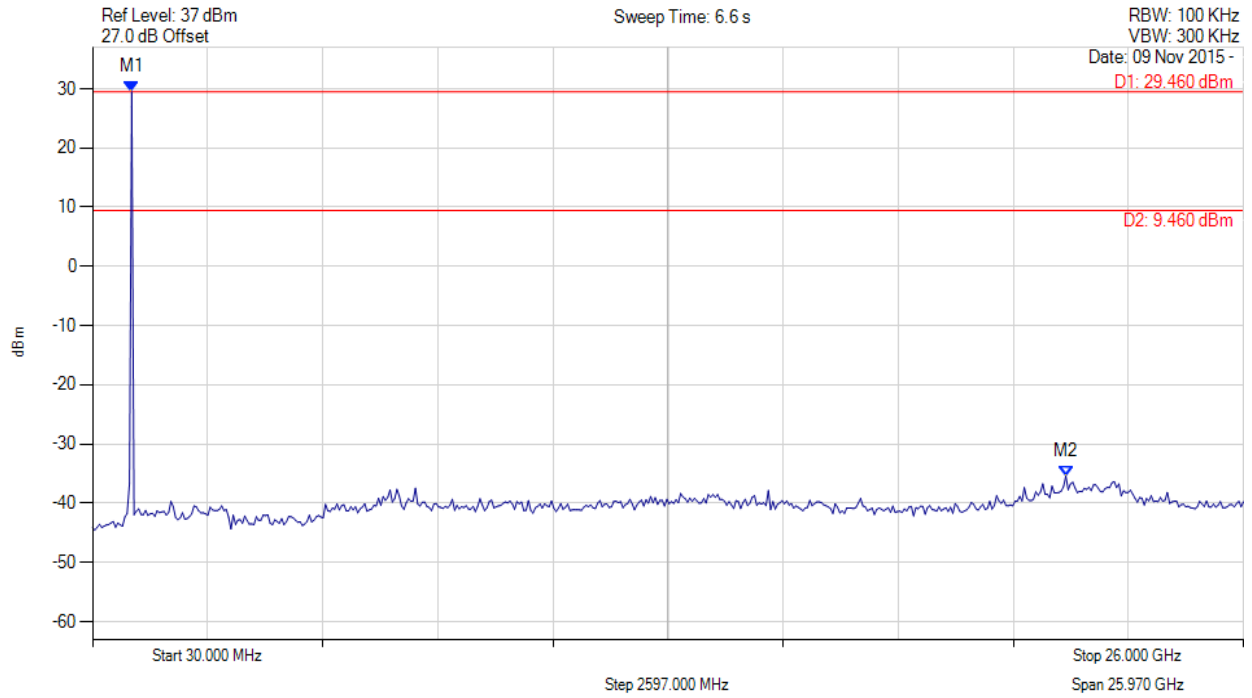

Analyser Setup	Marker:Frequency:Amplitude	Test Results
Detector = MAX PEAK Sweep Count = 0 RF Atten (dB) = 20 Trace Mode = VIEW	M1 : 914.749 MHz : 29.457 dBm M2 : 21.993 GHz : -35.393 dBm	Channel Frequency: 915.20 MHz

[back to matrix](#)

This test report may be reproduced in full only. The document may only be updated by MiCOM Labs personnel. All changes will be noted in the Document History section of the report.



Title: Silver Spring Networks NIC 511-0303
To: FCC CFR 47 Part 15 Subpart C 15.247 & IC RSS 247
Serial #: SSNT108-U8 Rev A
Issue Date: 11th December 2015
Page: 164 of 204

CONDUCTED SPURIOUS EMISSIONS - PEAK



Variant: 400 FSK, Channel: 927.60 MHz, Chain a, Temp: Ambient, Voltage: 4 Vdc

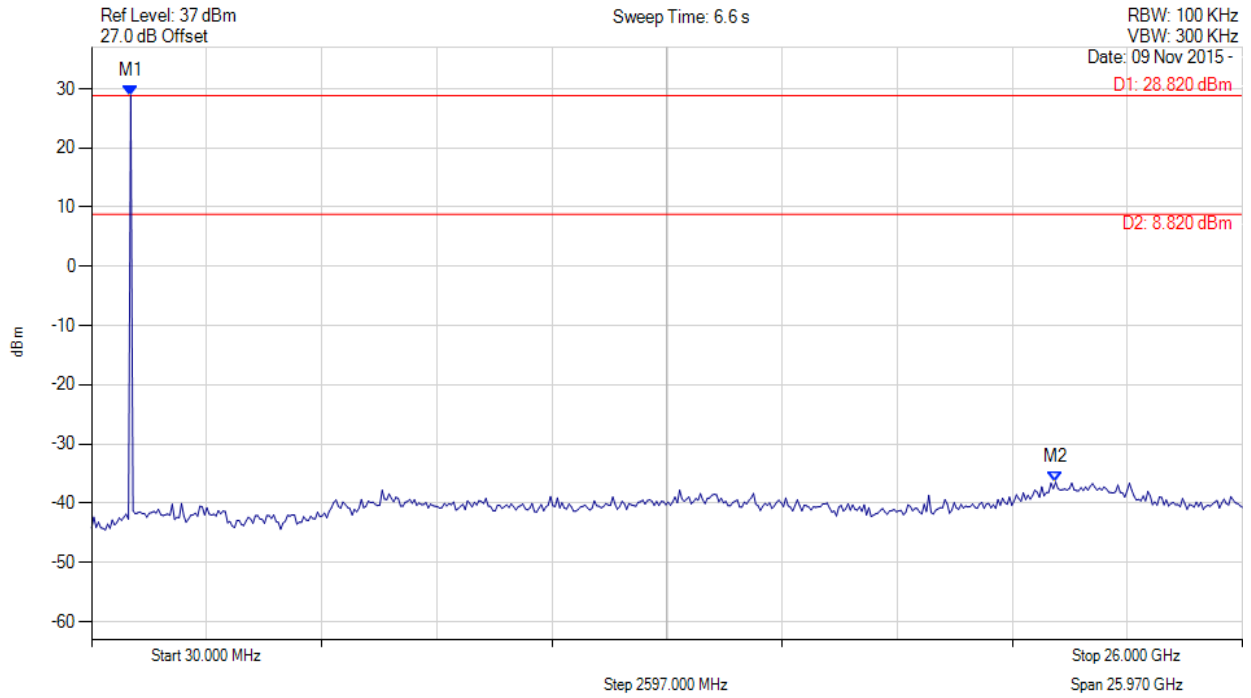

Analyser Setup	Marker:Frequency:Amplitude	Test Results
Detector = MAX PEAK Sweep Count = 0 RF Atten (dB) = 20 Trace Mode = VIEW	M1 : 914.749 MHz : 28.822 dBm M2 : 21.784 GHz : -36.439 dBm	Channel Frequency: 927.60 MHz

[back to matrix](#)

This test report may be reproduced in full only. The document may only be updated by MiCOM Labs personnel. All changes will be noted in the Document History section of the report.



Title: Silver Spring Networks NIC 511-0303
To: FCC CFR 47 Part 15 Subpart C 15.247 & IC RSS 247
Serial #: SSNT108-U8 Rev A
Issue Date: 11th December 2015
Page: 165 of 204

CONDUCTED SPURIOUS EMISSIONS - PEAK



Variant: 400 GFSK, Channel: 902.40 MHz, Chain a, Temp: Ambient, Voltage: 4 Vdc

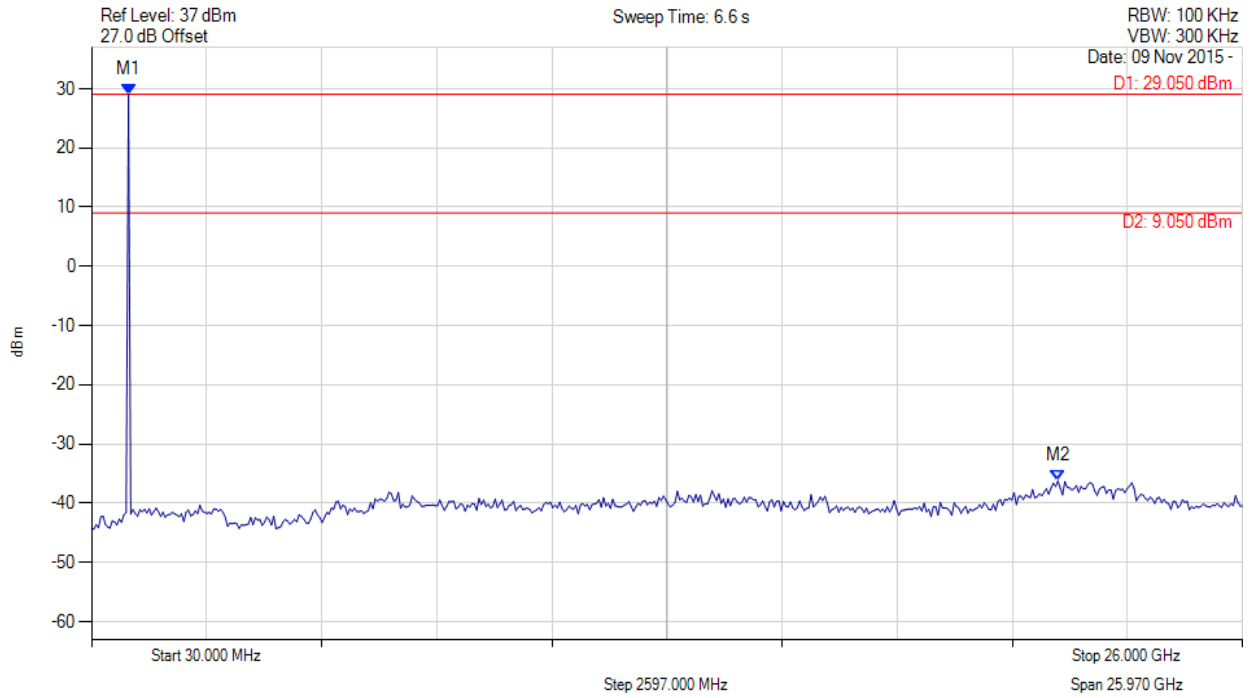

Analyser Setup	Marker:Frequency:Amplitude	Test Results
Detector = MAX PEAK Sweep Count = 0 RF Atten (dB) = 20 Trace Mode = VIEW	M1 : 862.705 MHz : 29.052 dBm M2 : 21.836 GHz : -36.219 dBm	Channel Frequency: 902.40 MHz

[back to matrix](#)

This test report may be reproduced in full only. The document may only be updated by MiCOM Labs personnel. All changes will be noted in the Document History section of the report.



Title: Silver Spring Networks NIC 511-0303
To: FCC CFR 47 Part 15 Subpart C 15.247 & IC RSS 247
Serial #: SSNT108-U8 Rev A
Issue Date: 11th December 2015
Page: 166 of 204

CONDUCTED SPURIOUS EMISSIONS - PEAK



Variant: 400 GFSK, Channel: 915.20 MHz, Chain a, Temp: Ambient, Voltage: 4 Vdc

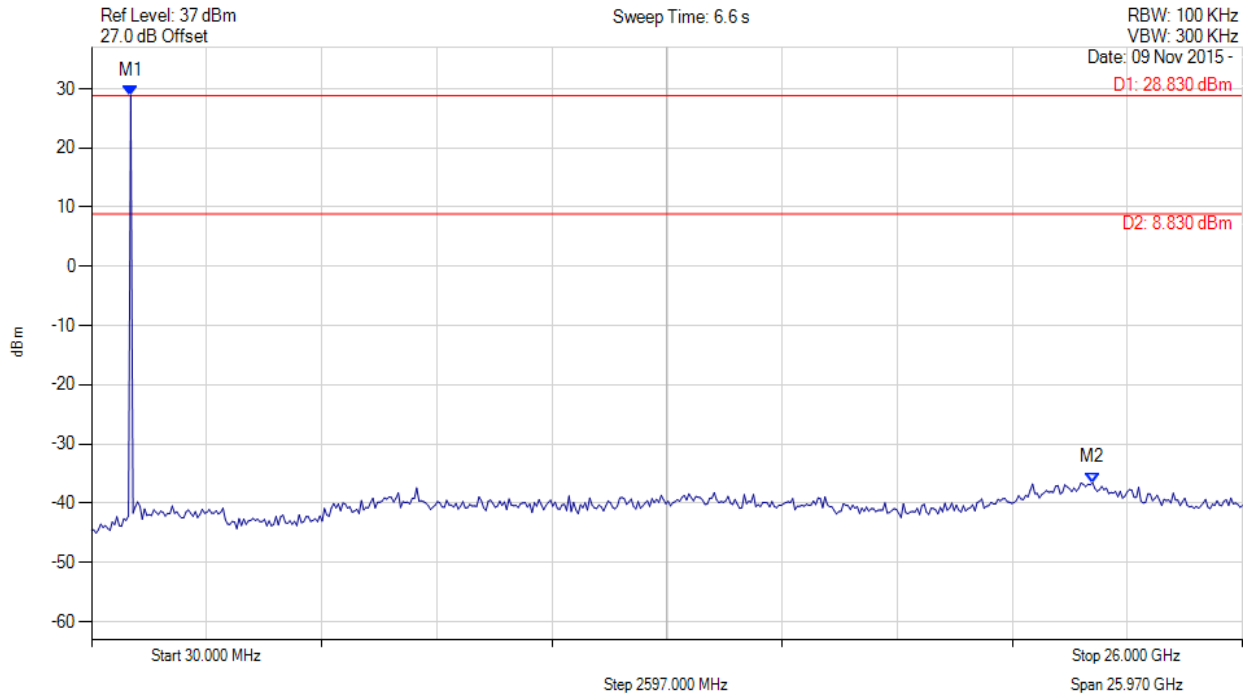

Analyser Setup	Marker:Frequency:Amplitude	Test Results
Detector = MAX PEAK Sweep Count = 0 RF Atten (dB) = 20 Trace Mode = VIEW	M1 : 914.749 MHz : 28.835 dBm M2 : 22.617 GHz : -36.528 dBm	Channel Frequency: 927.60 MHz

[back to matrix](#)

This test report may be reproduced in full only. The document may only be updated by MiCOM Labs personnel. All changes will be noted in the Document History section of the report.



Title: Silver Spring Networks NIC 511-0303
To: FCC CFR 47 Part 15 Subpart C 15.247 & IC RSS 247
Serial #: SSNT108-U8 Rev A
Issue Date: 11th December 2015
Page: 167 of 204

CONDUCTED SPURIOUS EMISSIONS - PEAK



Variant: 400 GFSK, Channel: 927.60 MHz, Chain a, Temp: Ambient, Voltage: 4 Vdc

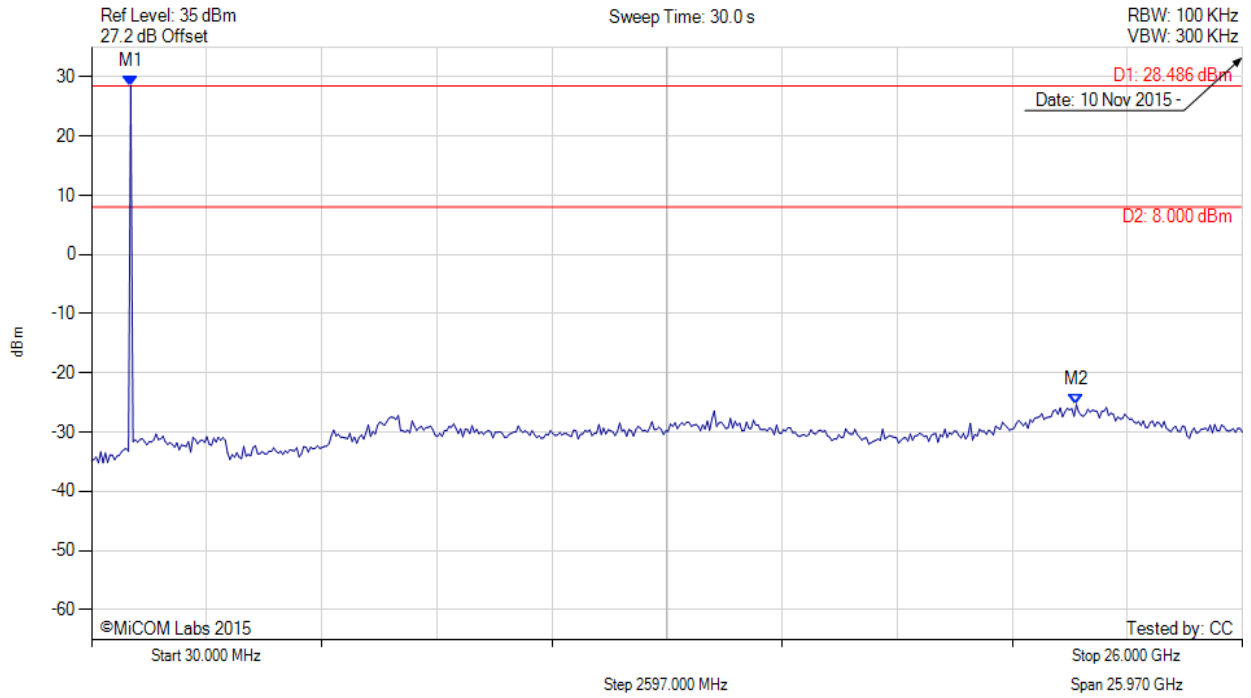

Analyser Setup	Marker:Frequency:Amplitude	Test Results
Detector = MAX PEAK Sweep Count = 0 RF Atten (dB) = 30 Trace Mode = VIEW	M1 : 914.749 MHz : 28.486 dBm M2 : 22.253 GHz : -25.351 dBm	Limit: 8.00 dBm Margin: -33.35 dB

[back to matrix](#)

This test report may be reproduced in full only. The document may only be updated by MiCOM Labs personnel. All changes will be noted in the Document History section of the report.



Title: Silver Spring Networks NIC 511-0303
To: FCC CFR 47 Part 15 Subpart C 15.247 & IC RSS 247
Serial #: SSNT108-U8 Rev A
Issue Date: 11th December 2015
Page: 168 of 204

CONDUCTED SPURIOUS EMISSIONS - PEAK



Variant: 200 2FSK, Channel: 902.20 MHz, Chain a, Temp: Ambient, Voltage: 4 Vdc

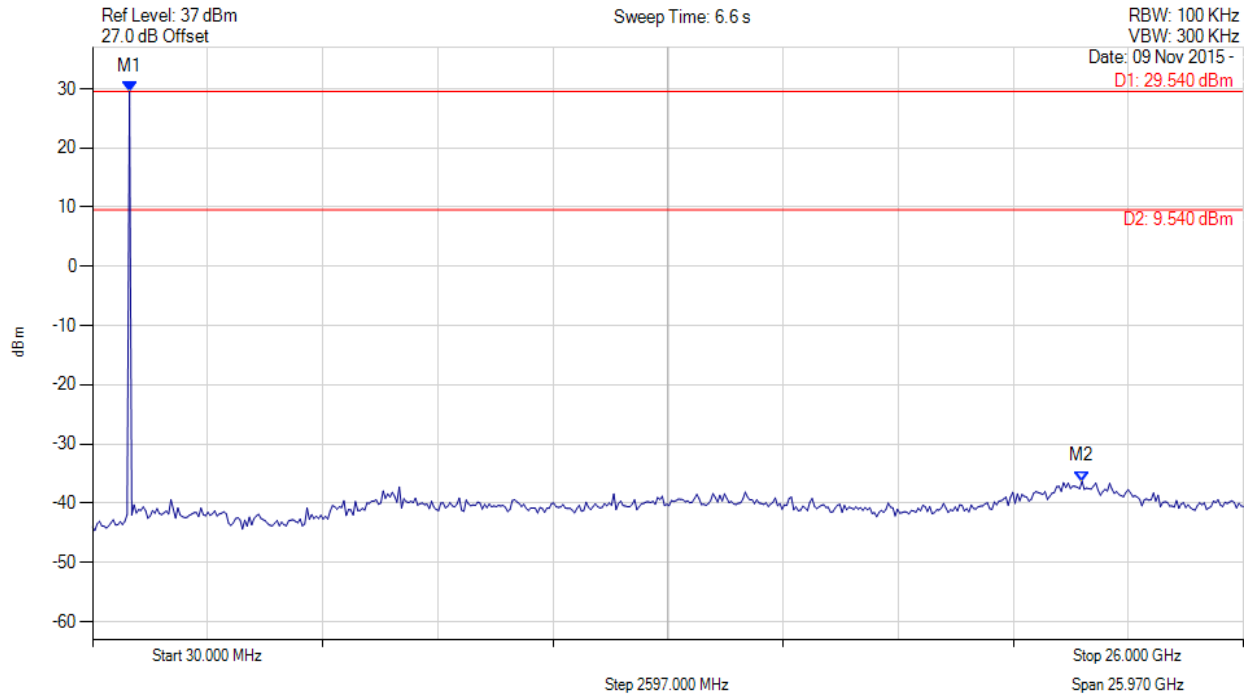

Analyser Setup	Marker:Frequency:Amplitude	Test Results
Detector = MAX PEAK Sweep Count = 0 RF Atten (dB) = 20 Trace Mode = VIEW	M1 : 862.705 MHz : 29.544 dBm M2 : 22.357 GHz : -36.282 dBm	Channel Frequency: 902.20 MHz

[back to matrix](#)

This test report may be reproduced in full only. The document may only be updated by MiCOM Labs personnel. All changes will be noted in the Document History section of the report.



CONDUCTED SPURIOUS EMISSIONS - PEAK



Variant: 200 2FSK, Channel: 915.00 MHz, Chain a, Temp: Ambient, Voltage: 4 Vdc

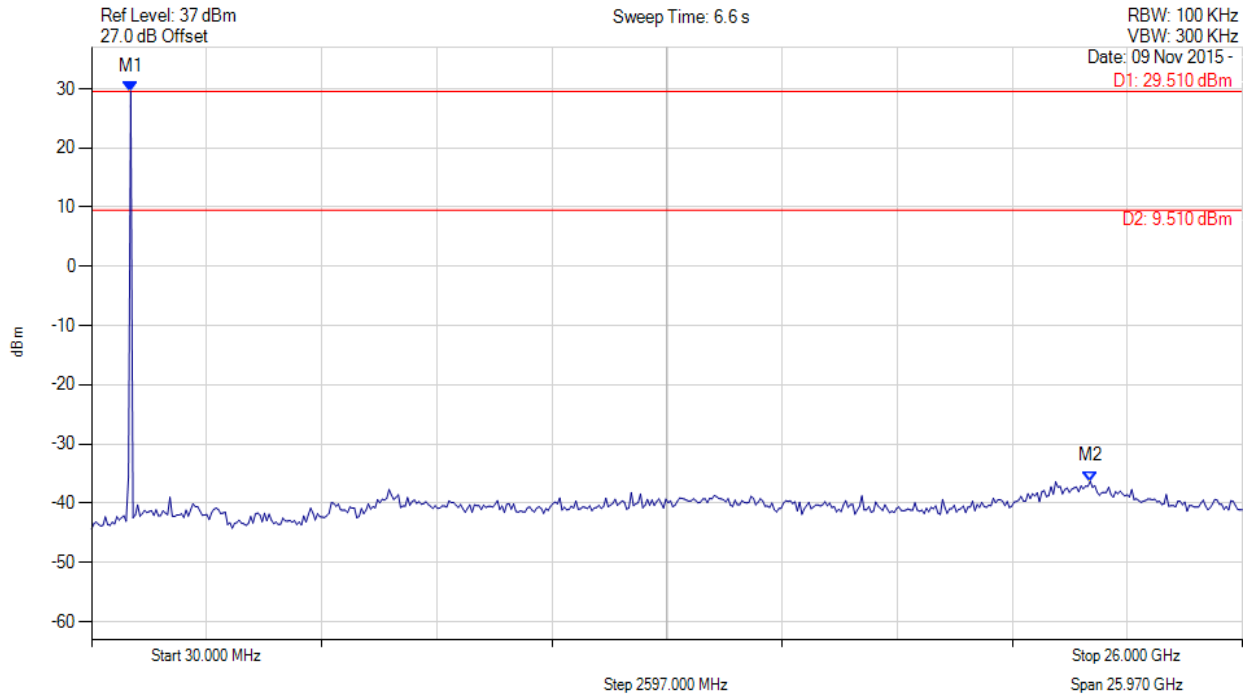

Analyser Setup	Marker:Frequency:Amplitude	Test Results
Detector = MAX PEAK Sweep Count = 0 RF Atten (dB) = 20 Trace Mode = VIEW	M1 : 914.749 MHz : 29.506 dBm M2 : 22.565 GHz : -36.294 dBm	Channel Frequency: 915.00 MHz

[back to matrix](#)

This test report may be reproduced in full only. The document may only be updated by MiCOM Labs personnel. All changes will be noted in the Document History section of the report.



Title: Silver Spring Networks NIC 511-0303
To: FCC CFR 47 Part 15 Subpart C 15.247 & IC RSS 247
Serial #: SSNT108-U8 Rev A
Issue Date: 11th December 2015
Page: 170 of 204

CONDUCTED SPURIOUS EMISSIONS - PEAK



Variant: 200 2FSK, Channel: 927.80 MHz, Chain a, Temp: Ambient, Voltage: 4 Vdc

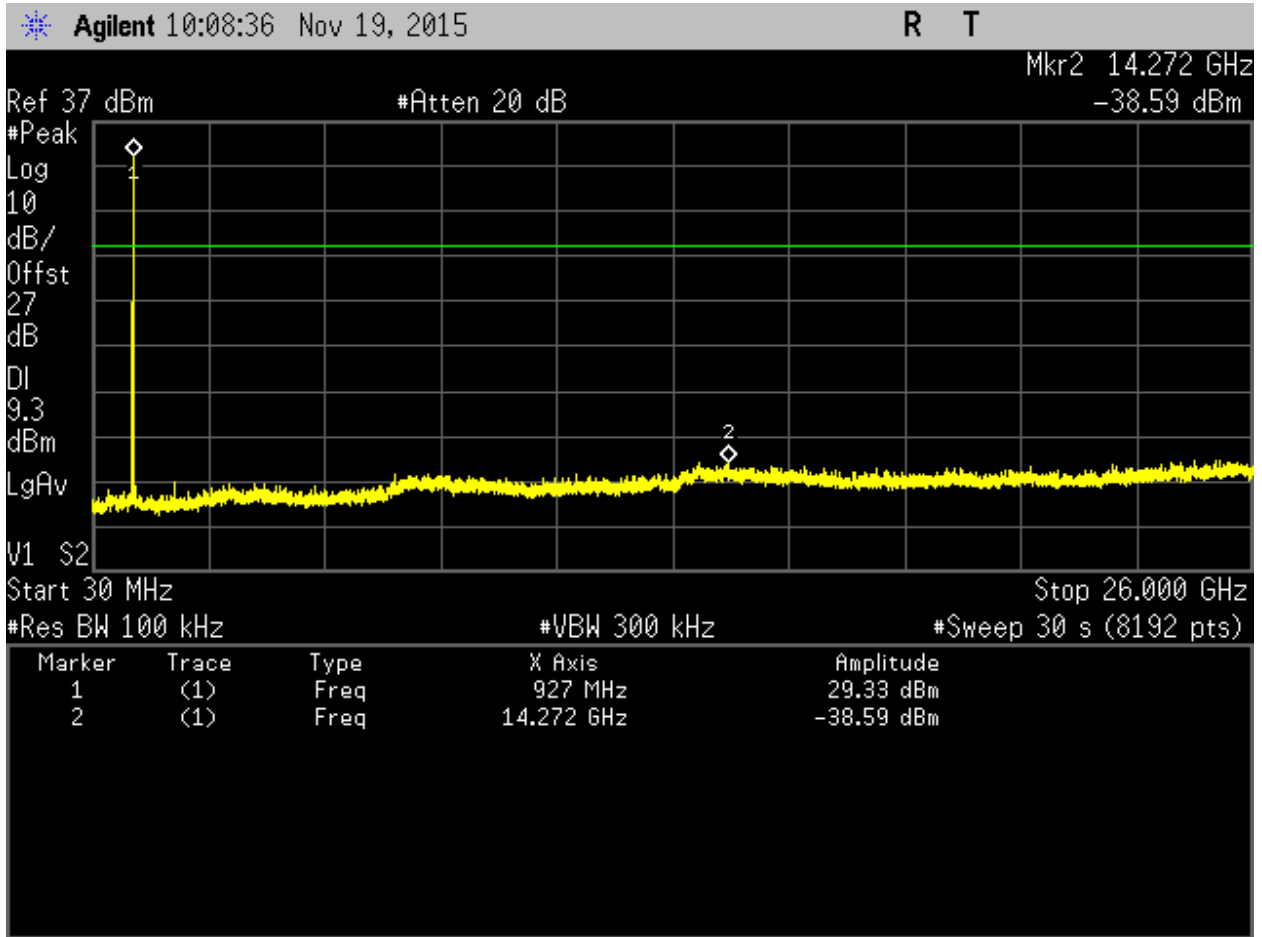

Analyser Setup	Marker:Frequency:Amplitude	Test Results
Detector = MAX PEAK Sweep Count = 0 RF Atten (dB) = 20 Trace Mode = VIEW	M1 : 914.749 MHz : 29.330 dBm M2 : 22.149 GHz : -38.590 dBm	Channel Frequency: 927.80 MHz

[back to matrix](#)

This test report may be reproduced in full only. The document may only be updated by MiCOM Labs personnel. All changes will be noted in the Document History section of the report.



Title: Silver Spring Networks NIC 511-0303
To: FCC CFR 47 Part 15 Subpart C 15.247 & IC RSS 247
Serial #: SSNT108-U8 Rev A
Issue Date: 11th December 2015
Page: 171 of 204

CONDUCTED SPURIOUS EMISSIONS - PEAK



Variant: 200 OQPSK, Channel: 902.20 MHz, Chain a, Temp: Ambient, Voltage: 4 Vdc

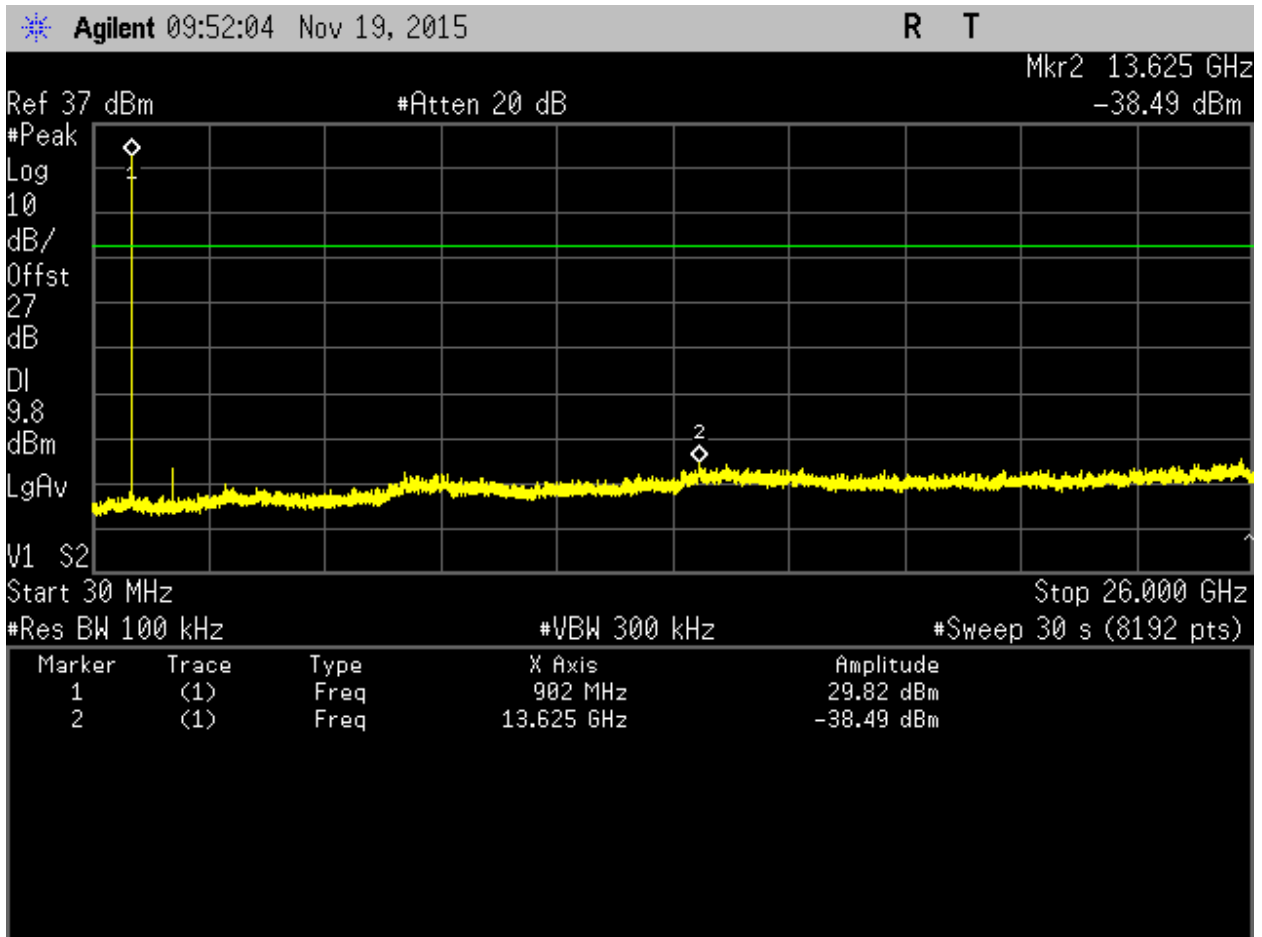

Analyser Setup	Marker:Frequency:Amplitude	Test Results
Detector = MAX PEAK Sweep Count = 0 RF Atten (dB) = 20 Trace Mode = VIEW	M1 : 902.000 MHz : 29.820 dBm M2 : 13.625 GHz : -38.490 dBm	Channel Frequency: 902.20 MHz

[back to matrix](#)

This test report may be reproduced in full only. The document may only be updated by MiCOM Labs personnel. All changes will be noted in the Document History section of the report.



Title: Silver Spring Networks NIC 511-0303
To: FCC CFR 47 Part 15 Subpart C 15.247 & IC RSS 247
Serial #: SSNT108-U8 Rev A
Issue Date: 11th December 2015
Page: 172 of 204

CONDUCTED SPURIOUS EMISSIONS - PEAK



Variant: 200 OQPSK, Channel: 915.00 MHz, Chain a, Temp: Ambient, Voltage: 4 Vdc

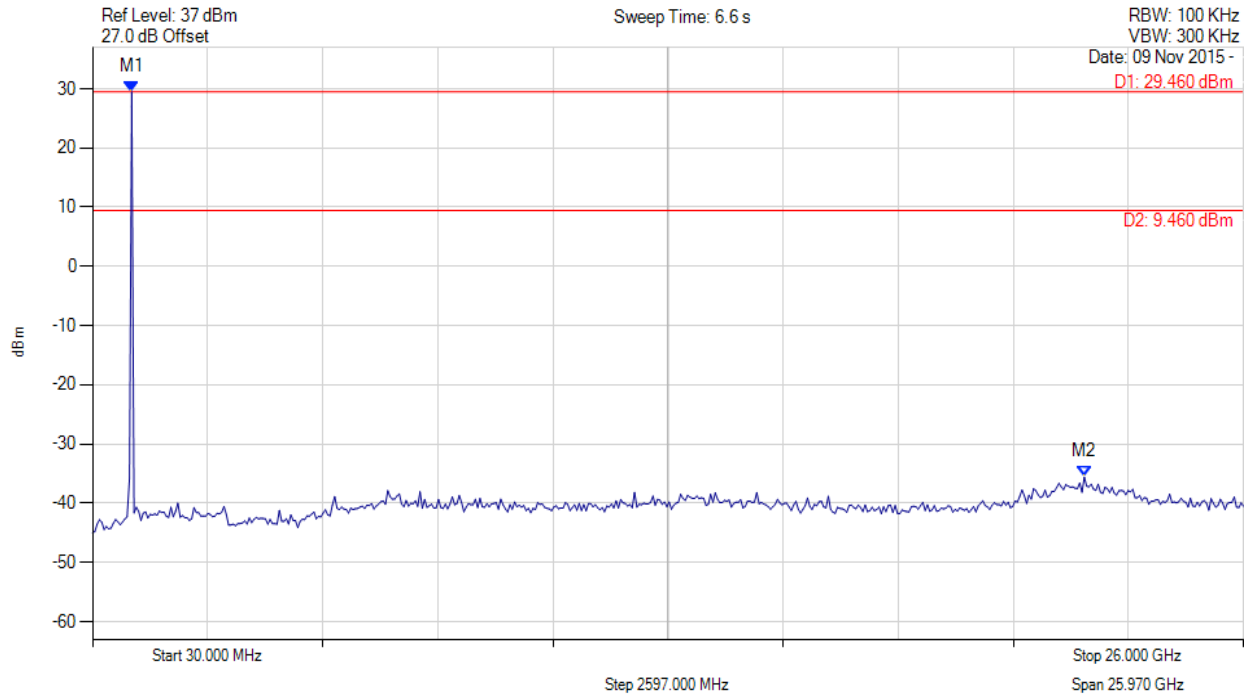

Analyser Setup	Marker:Frequency:Amplitude	Test Results
Detector = MAX PEAK Sweep Count = 0 RF Atten (dB) = 20 Trace Mode = VIEW	M1 : 914.749 MHz : 29.459 dBm M2 : 22.409 GHz : -35.566 dBm	Channel Frequency: 915.00 MHz

[back to matrix](#)

This test report may be reproduced in full only. The document may only be updated by MiCOM Labs personnel. All changes will be noted in the Document History section of the report.



Title: Silver Spring Networks NIC 511-0303
To: FCC CFR 47 Part 15 Subpart C 15.247 & IC RSS 247
Serial #: SSNT108-U8 Rev A
Issue Date: 11th December 2015
Page: 173 of 204

CONDUCTED SPURIOUS EMISSIONS - PEAK



Variant: 200 OQPSK, Channel: 927.80 MHz, Chain a, Temp: Ambient, Voltage: 4 Vdc

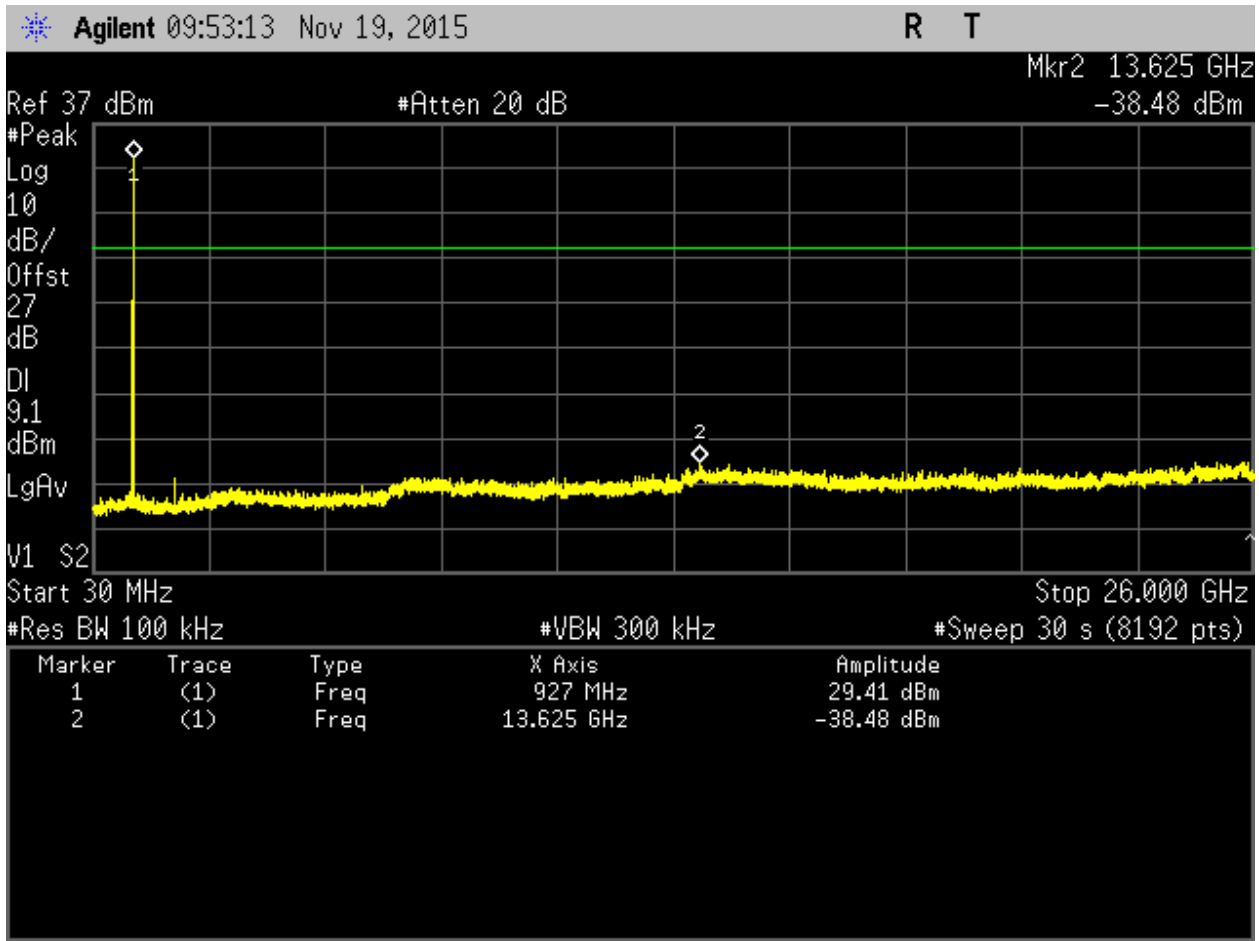

Analyser Setup	Marker:Frequency:Amplitude	Test Results
Detector = MAX PEAK Sweep Count = 0 RF Atten (dB) = 20 Trace Mode = VIEW	M1 : 927.000 MHz : 29.410 dBm M2 : 13.625 GHz : -38.480 dBm	Channel Frequency: 927.80 MHz

[back to matrix](#)

This test report may be reproduced in full only. The document may only be updated by MiCOM Labs personnel. All changes will be noted in the Document History section of the report.



Title: Silver Spring Networks NIC 511-0303
To: FCC CFR 47 Part 15 Subpart C 15.247 & IC RSS 247
Serial #: SSNT108-U8 Rev A
Issue Date: 11th December 2015
Page: 174 of 204

CONDUCTED SPURIOUS EMISSIONS - PEAK



Variant: 400 OFDM, Channel: 902.40 MHz, Chain a, Temp: Ambient, Voltage: 4 Vdc

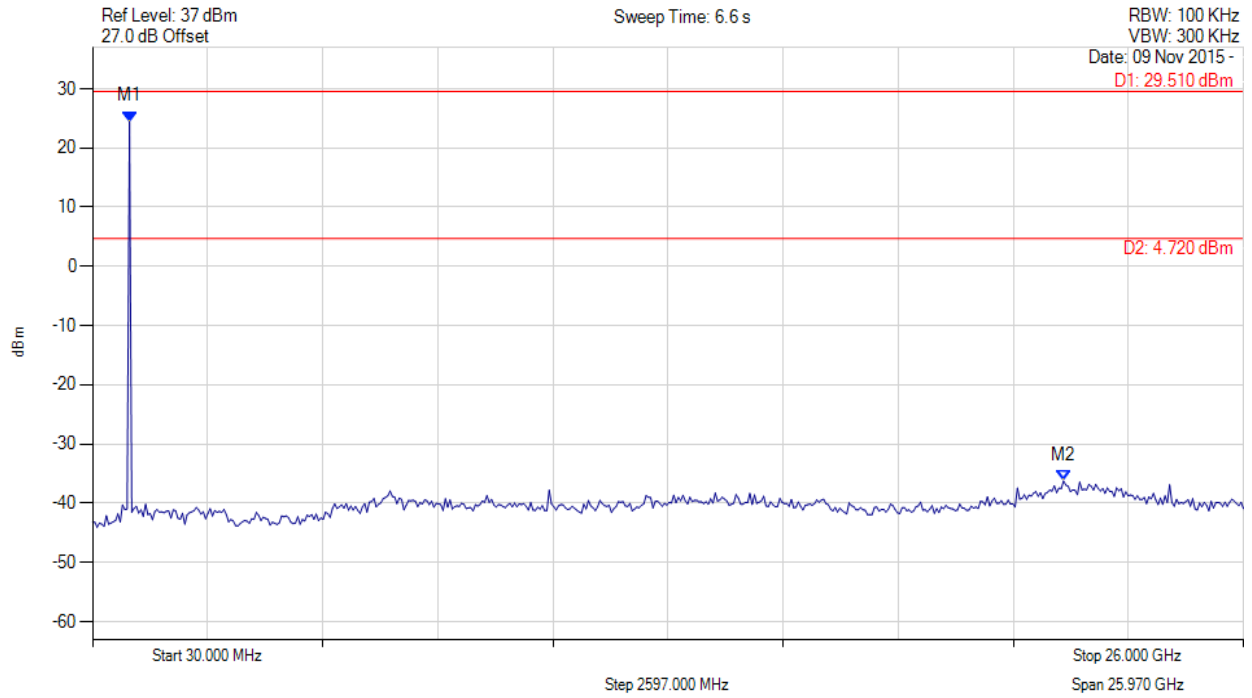

Analyser Setup	Marker:Frequency:Amplitude	Test Results
Detector = MAX PEAK Sweep Count = 0 RF Atten (dB) = 20 Trace Mode = VIEW	M1 : 862.705 MHz : 24.470 dBm M2 : 21.941 GHz : -36.229 dBm	Channel Frequency: 902.40 MHz

[back to matrix](#)

This test report may be reproduced in full only. The document may only be updated by MiCOM Labs personnel. All changes will be noted in the Document History section of the report.



Title: Silver Spring Networks NIC 511-0303
To: FCC CFR 47 Part 15 Subpart C 15.247 & IC RSS 247
Serial #: SSNT108-U8 Rev A
Issue Date: 11th December 2015
Page: 175 of 204

CONDUCTED SPURIOUS EMISSIONS - PEAK



Variant: 400 OFDM, Channel: 915.20 MHz, Chain a, Temp: Ambient, Voltage: 4 Vdc

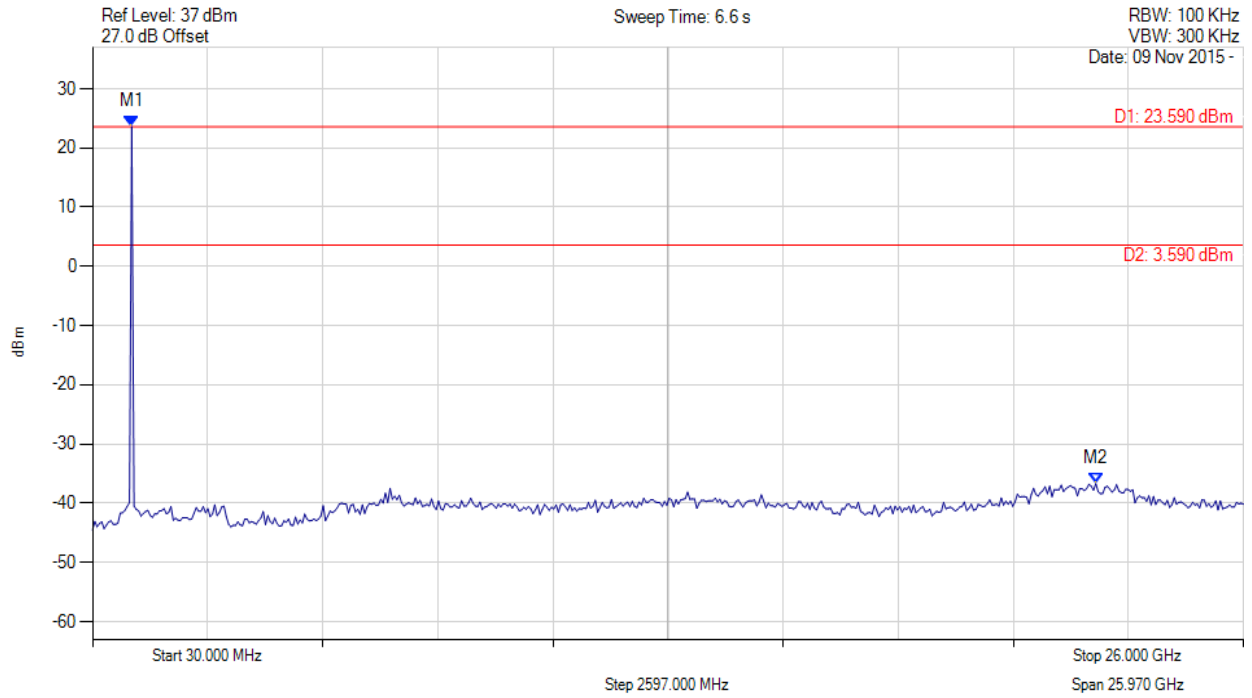

Analyser Setup	Marker:Frequency:Amplitude	Test Results
Detector = MAX PEAK Sweep Count = 0 RF Atten (dB) = 20 Trace Mode = VIEW	M1 : 914.749 MHz : 23.589 dBm M2 : 22.669 GHz : -36.674 dBm	Channel Frequency: 915.20 MHz

[back to matrix](#)

This test report may be reproduced in full only. The document may only be updated by MiCOM Labs personnel. All changes will be noted in the Document History section of the report.



Title: Silver Spring Networks NIC 511-0303
To: FCC CFR 47 Part 15 Subpart C 15.247 & IC RSS 247
Serial #: SSNT108-U8 Rev A
Issue Date: 11th December 2015
Page: 176 of 204

CONDUCTED SPURIOUS EMISSIONS - PEAK



Variant: 400 OFDM, Channel: 927.60 MHz, Chain a, Temp: Ambient, Voltage: 4 Vdc

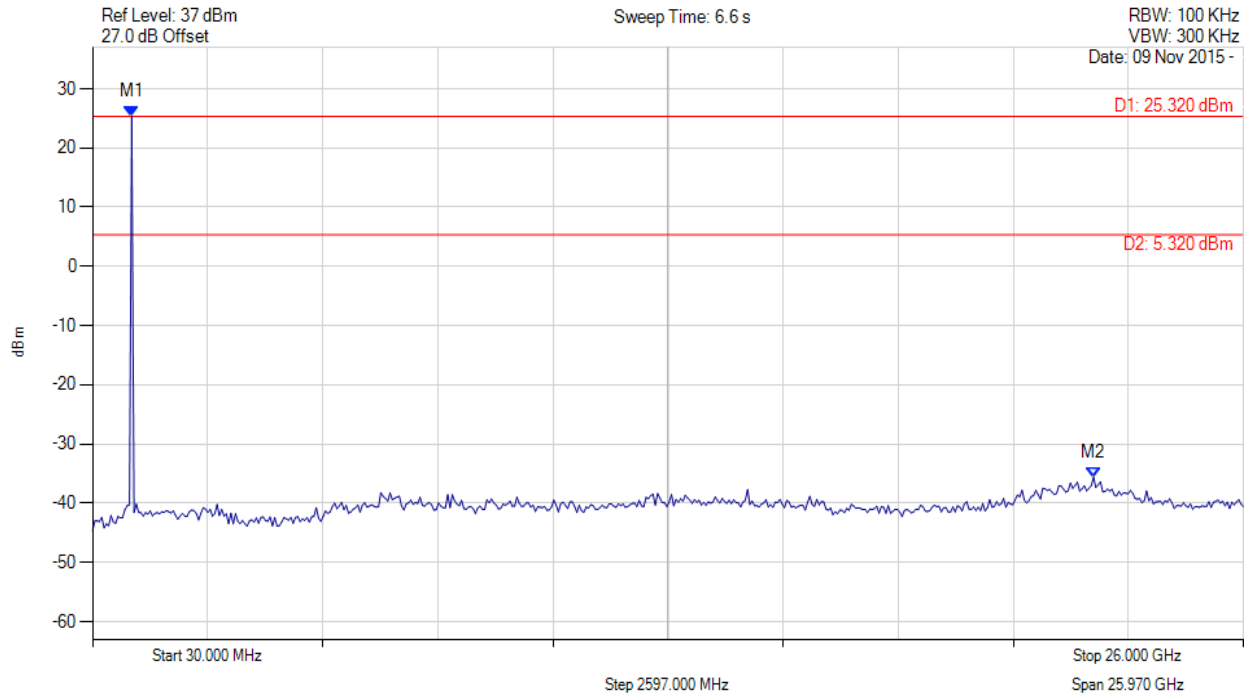

Analyser Setup	Marker:Frequency:Amplitude	Test Results
Detector = MAX PEAK Sweep Count = 0 RF Atten (dB) = 20 Trace Mode = VIEW	M1 : 914.749 MHz : 25.316 dBm M2 : 22.617 GHz : -35.609 dBm	Channel Frequency: 927.60 MHz

[back to matrix](#)

This test report may be reproduced in full only. The document may only be updated by MiCOM Labs personnel. All changes will be noted in the Document History section of the report.



Title: Silver Spring Networks NIC 511-0303
To: FCC CFR 47 Part 15 Subpart C 15.247 & IC RSS 247
Serial #: SSNT108-U8 Rev A
Issue Date: 11th December 2015
Page: 177 of 204

CONDUCTED SPURIOUS EMISSIONS - PEAK



Variant: 1200 OFDM, Channel: 903.20 MHz, Chain a, Temp: Ambient, Voltage: 4 Vdc

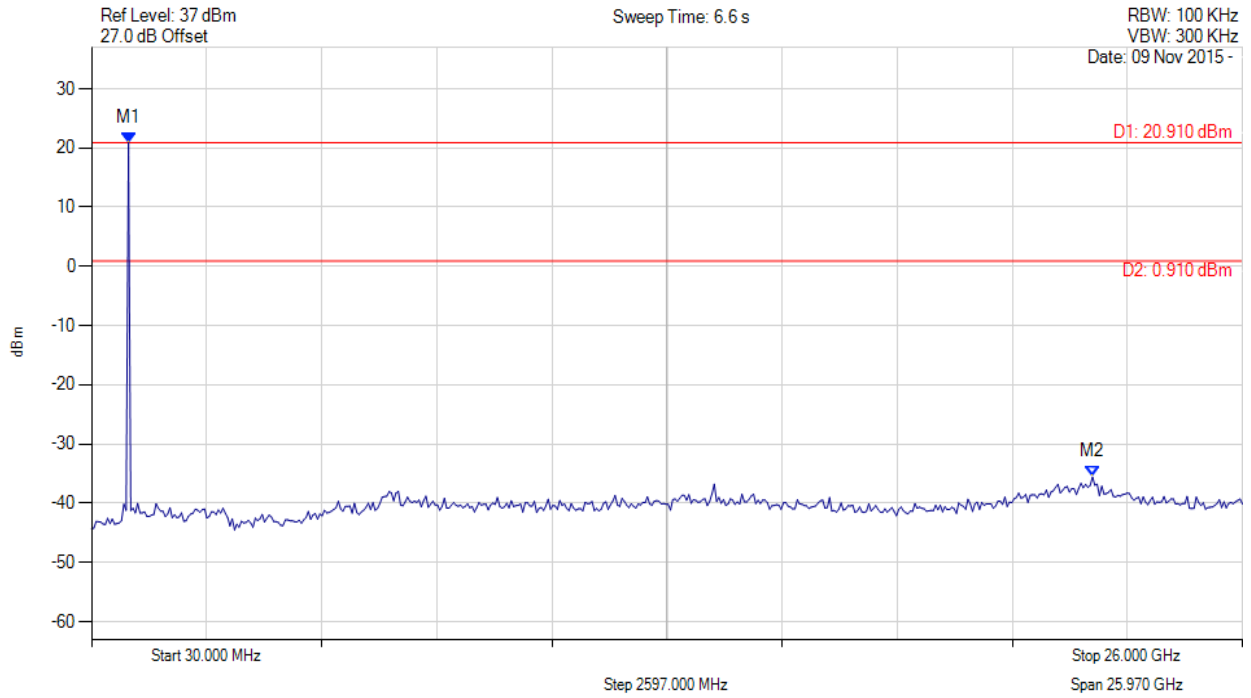

Analyser Setup	Marker:Frequency:Amplitude	Test Results
Detector = MAX PEAK Sweep Count = 0 RF Atten (dB) = 20 Trace Mode = VIEW	M1 : 862.705 MHz : 20.911 dBm M2 : 22.617 GHz : -35.556 dBm	Channel Frequency: 903.20 MHz

[back to matrix](#)

This test report may be reproduced in full only. The document may only be updated by MiCOM Labs personnel. All changes will be noted in the Document History section of the report.



Title: Silver Spring Networks NIC 511-0303
To: FCC CFR 47 Part 15 Subpart C 15.247 & IC RSS 247
Serial #: SSNT108-U8 Rev A
Issue Date: 11th December 2015
Page: 178 of 204

CONDUCTED SPURIOUS EMISSIONS - PEAK



Variant: 1200 OFDM, Channel: 914.00 MHz, Chain a, Temp: Ambient, Voltage: 4 Vdc

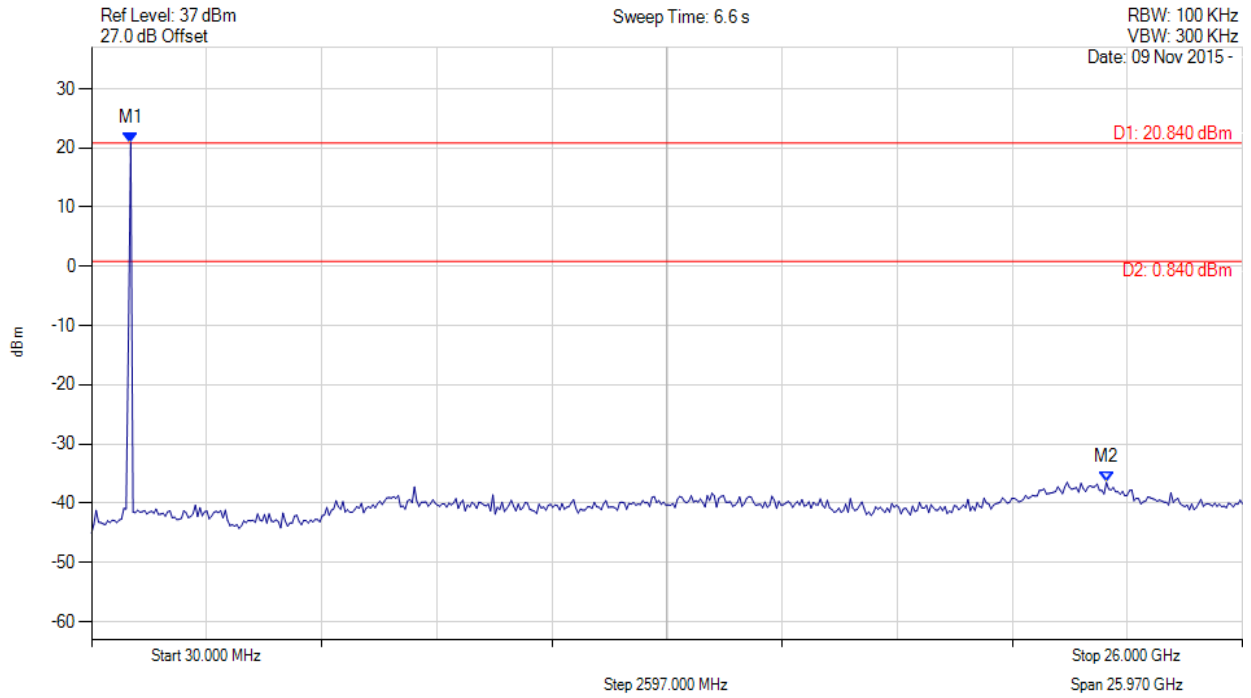

Analyser Setup	Marker:Frequency:Amplitude	Test Results
Detector = MAX PEAK Sweep Count = 0 RF Atten (dB) = 20 Trace Mode = VIEW	M1 : 914.749 MHz : 20.840 dBm M2 : 22.929 GHz : -36.457 dBm	Channel Frequency: 914.00 MHz

[back to matrix](#)

This test report may be reproduced in full only. The document may only be updated by MiCOM Labs personnel. All changes will be noted in the Document History section of the report.



Title: Silver Spring Networks NIC 511-0303
To: FCC CFR 47 Part 15 Subpart C 15.247 & IC RSS 247
Serial #: SSNT108-U8 Rev A
Issue Date: 11th December 2015
Page: 179 of 204

CONDUCTED SPURIOUS EMISSIONS - PEAK



Variant: 1200 OFDM, Channel: 926.00 MHz, Chain a, Temp: Ambient, Voltage: 4 Vdc

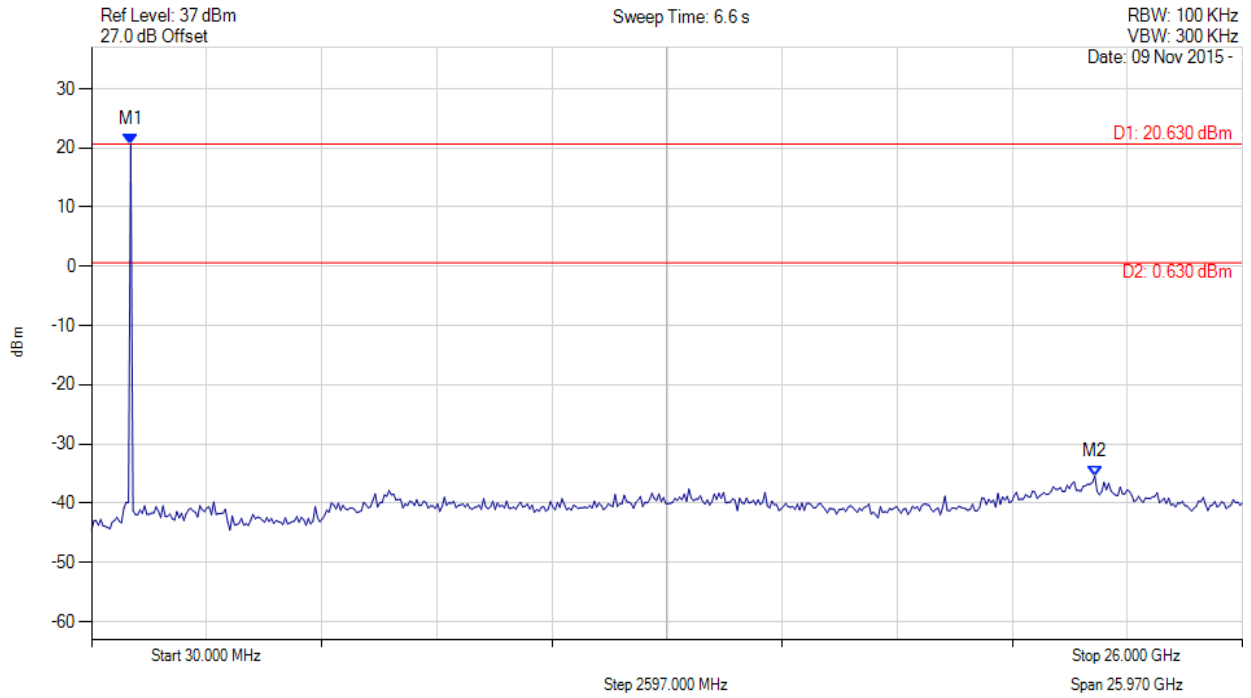

Analyser Setup	Marker:Frequency:Amplitude	Test Results
Detector = MAX PEAK Sweep Count = 0 RF Atten (dB) = 20 Trace Mode = VIEW	M1 : 914.749 MHz : 20.634 dBm M2 : 22.669 GHz : -35.393 dBm	Channel Frequency: 926.00 MHz

[back to matrix](#)

This test report may be reproduced in full only. The document may only be updated by MiCOM Labs personnel. All changes will be noted in the Document History section of the report.



Title: Silver Spring Networks NIC 511-0303
To: FCC CFR 47 Part 15 Subpart C 15.247 & IC RSS 247
Serial #: SSNT108-U8 Rev A
Issue Date: 11th December 2015
Page: 180 of 204

A.6.1.2. Conducted Band-Edge Emissions

A.6.1.2.1. Conducted Low Band-Edge Emissions

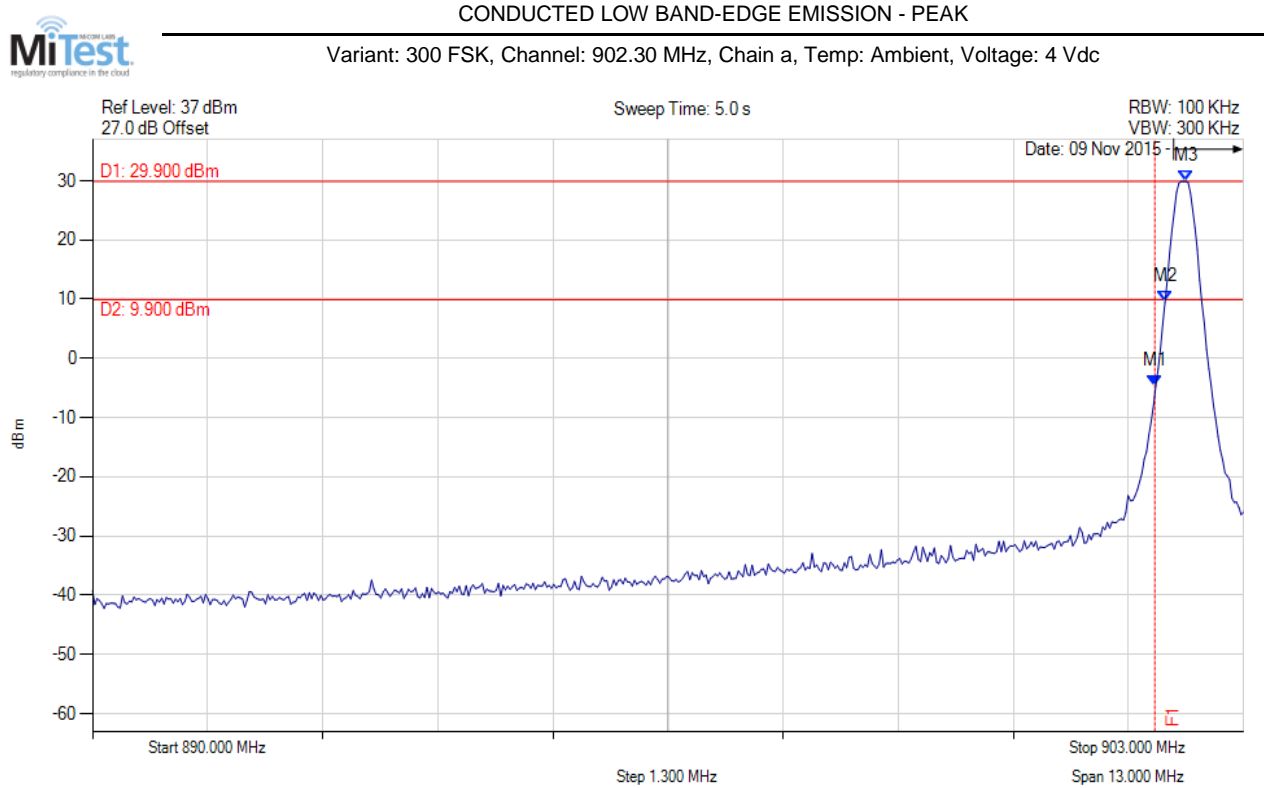

Analyser Setup	Marker:Frequency:Amplitude	Test Results
Detector = MAX PEAK Sweep Count = 0 RF Atten (dB) = 20 Trace Mode = VIEW	M1 : 902.000 MHz : -4.669 dBm M2 : 902.116 MHz : 9.549 dBm M3 : 902.349 MHz : 29.902 dBm	Channel Frequency: 902.30 MHz

[back to matrix](#)

This test report may be reproduced in full only. The document may only be updated by MiCOM Labs personnel. All changes will be noted in the Document History section of the report.



Title: Silver Spring Networks NIC 511-0303
To: FCC CFR 47 Part 15 Subpart C 15.247 & IC RSS 247
Serial #: SSNT108-U8 Rev A
Issue Date: 11th December 2015
Page: 181 of 204

CONDUCTED LOW BAND-EDGE EMISSION - PEAK

Variants: 300 GFSK, Channel: 902.30 MHz, Chain a, Temp: Ambient, Voltage: 4 Vdc

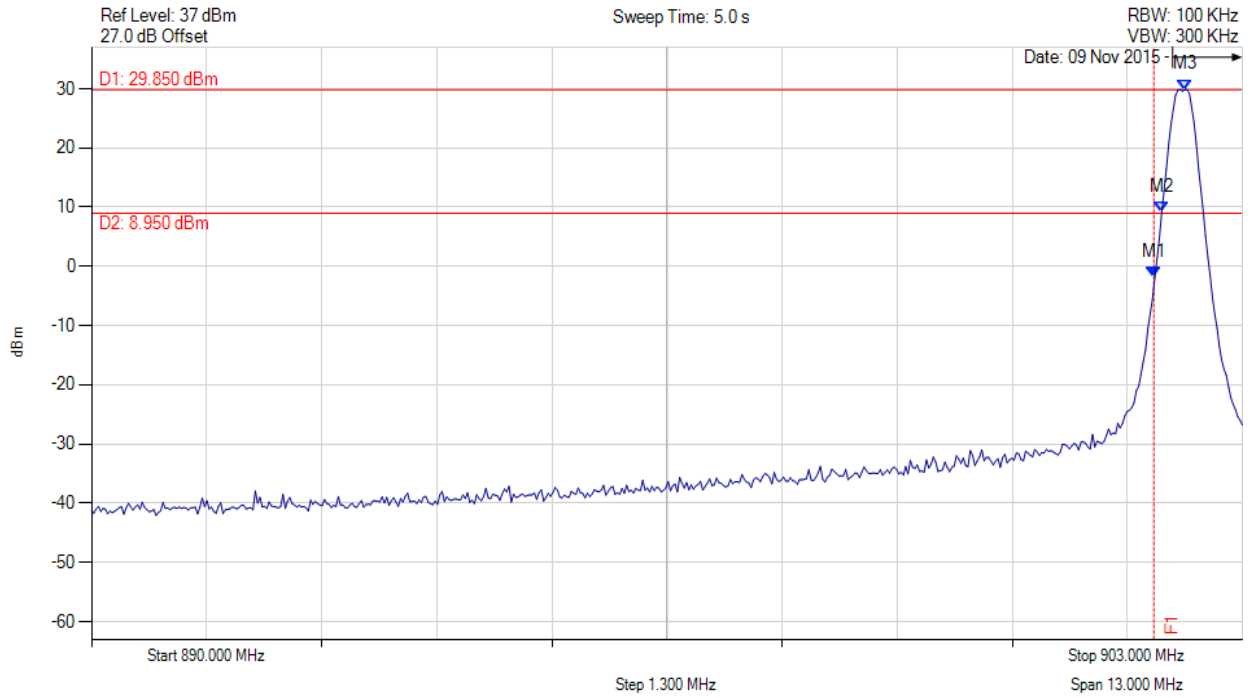

Analyser Setup	Marker:Frequency:Amplitude	Test Results
Detector = MAX PEAK Sweep Count = 0 RF Atten (dB) = 20 Trace Mode = MAX HOLD	M1 : 902.000 MHz : -1.920 dBm M2 : 902.090 MHz : 9.176 dBm M3 : 902.349 MHz : 29.853 dBm	Channel Frequency: 902.30 MHz

[back to matrix](#)

This test report may be reproduced in full only. The document may only be updated by MiCOM Labs personnel. All changes will be noted in the Document History section of the report.



Title: Silver Spring Networks NIC 511-0303
To: FCC CFR 47 Part 15 Subpart C 15.247 & IC RSS 247
Serial #: SSNT108-U8 Rev A
Issue Date: 11th December 2015
Page: 182 of 204

CONDUCTED LOW BAND-EDGE EMISSION - PEAK



Variant: 300 GFSK, Channel: 902.30 MHz, Chain a, Temp: Ambient, Voltage: 4 Vdc

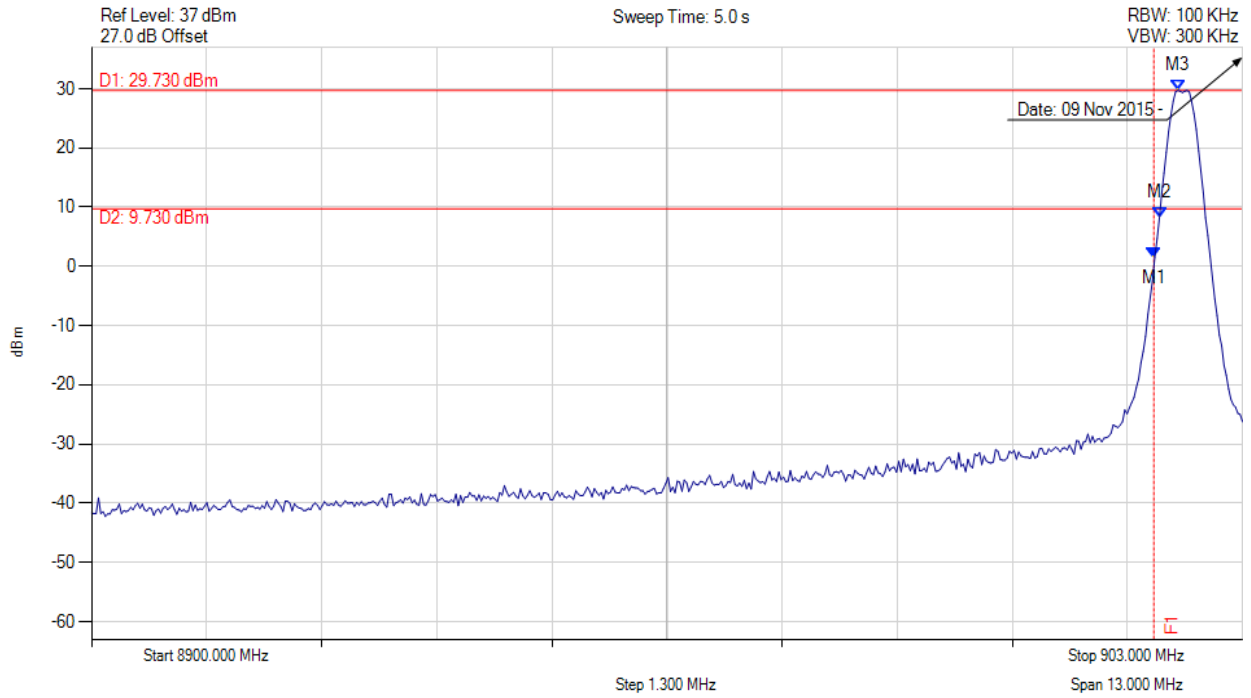

Analyser Setup	Marker:Frequency:Amplitude	Test Results
Detector = MAX PEAK Sweep Count = 0 RF Atten (dB) = 20 Trace Mode = VIEW	M1 : 902.000 MHz : 1.562 dBm M2 : 902.064 MHz : 8.227 dBm M3 : 902.271 MHz : 29.727 dBm	Channel Frequency: 902.30 MHz

[back to matrix](#)

This test report may be reproduced in full only. The document may only be updated by MiCOM Labs personnel. All changes will be noted in the Document History section of the report.



Title: Silver Spring Networks NIC 511-0303
To: FCC CFR 47 Part 15 Subpart C 15.247 & IC RSS 247
Serial #: SSNT108-U8 Rev A
Issue Date: 11th December 2015
Page: 183 of 204

CONDUCTED LOW BAND-EDGE EMISSION - PEAK



Variant: 400 FSK, Channel: 902.40 MHz, Chain a, Temp: Ambient, Voltage: 4 Vdc

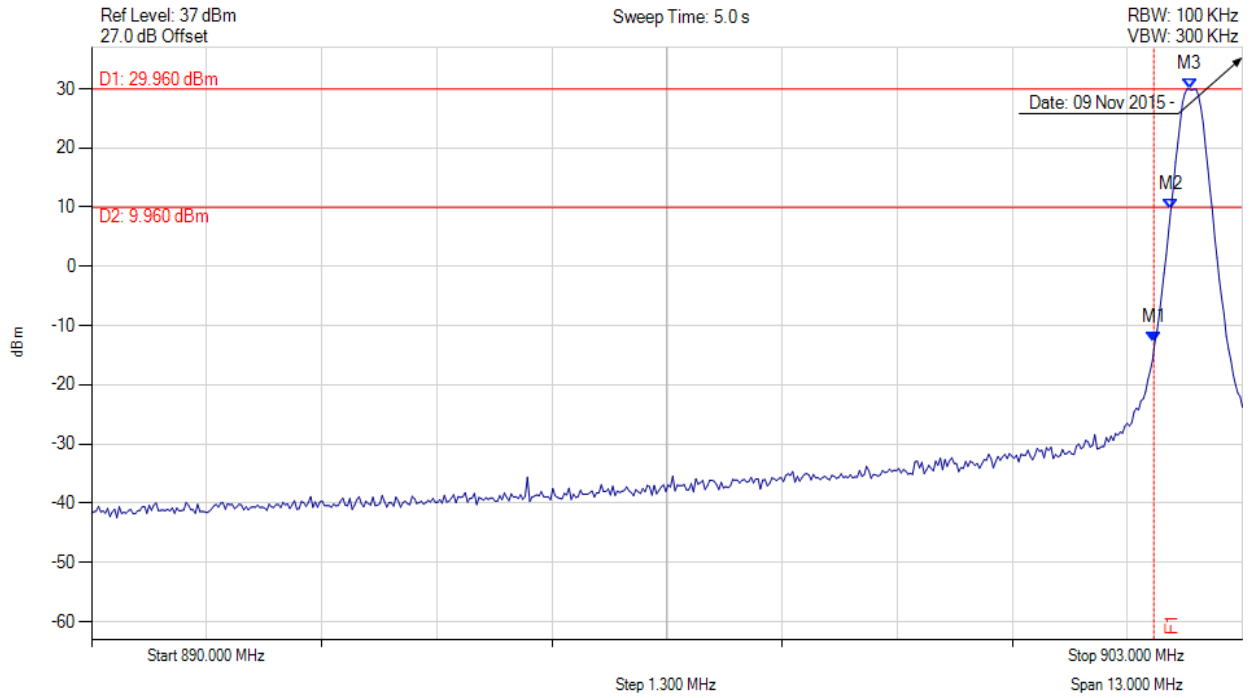

Analyser Setup	Marker:Frequency:Amplitude	Test Results
Detector = MAX PEAK Sweep Count = 0 RF Atten (dB) = 20 Trace Mode = VIEW	M1 : 902.000 MHz : -12.865 dBm M2 : 902.194 MHz : 9.656 dBm M3 : 902.401 MHz : 29.955 dBm	Channel Frequency: 902.40 MHz

[back to matrix](#)

This test report may be reproduced in full only. The document may only be updated by MiCOM Labs personnel. All changes will be noted in the Document History section of the report.



Title: Silver Spring Networks NIC 511-0303
To: FCC CFR 47 Part 15 Subpart C 15.247 & IC RSS 247
Serial #: SSNT108-U8 Rev A
Issue Date: 11th December 2015
Page: 184 of 204

CONDUCTED LOW BAND-EDGE EMISSION - PEAK



Variant: 400 GFSK, Channel: 902.40 MHz, Chain a, Temp: Ambient, Voltage: 4 Vdc

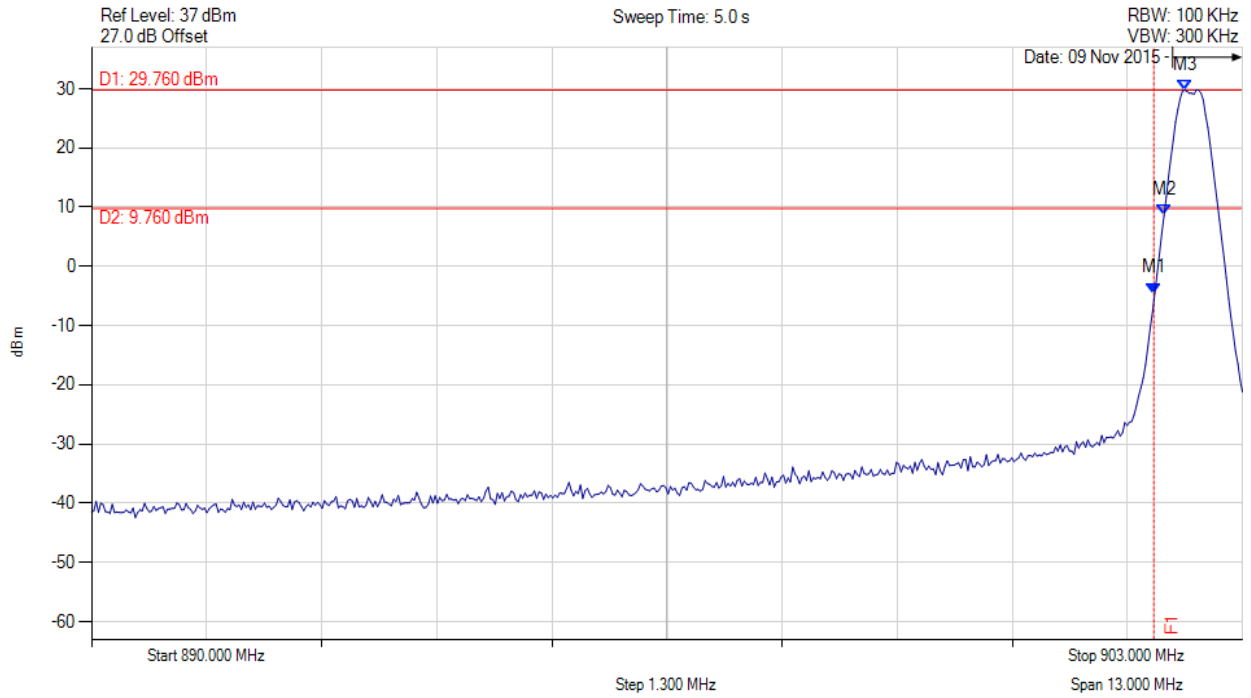

Analyser Setup	Marker:Frequency:Amplitude	Test Results
Detector = MAX PEAK Sweep Count = 0 RF Atten (dB) = 20 Trace Mode = VIEW	M1 : 902.000 MHz : -4.499 dBm M2 : 902.116 MHz : 8.591 dBm M3 : 902.349 MHz : 29.758 dBm	Channel Frequency: 902.40 MHz

[back to matrix](#)

This test report may be reproduced in full only. The document may only be updated by MiCOM Labs personnel. All changes will be noted in the Document History section of the report.



Title: Silver Spring Networks NIC 511-0303
To: FCC CFR 47 Part 15 Subpart C 15.247 & IC RSS 247
Serial #: SSNT108-U8 Rev A
Issue Date: 11th December 2015
Page: 185 of 204

CONDUCTED LOW BAND-EDGE EMISSION - PEAK



Variant: 200 2FSK, Channel: 902.20 MHz, Chain a, Temp: Ambient, Voltage: 4 Vdc

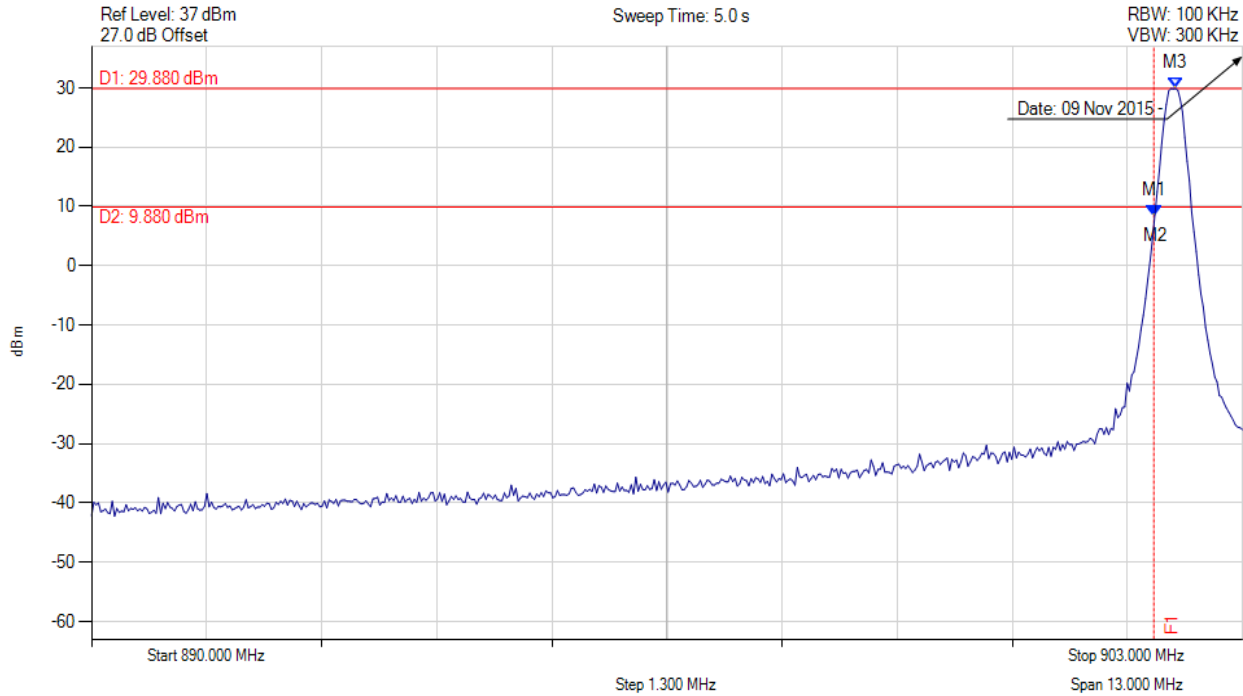

Analyser Setup	Marker:Frequency:Amplitude	Test Results
Detector = MAX PEAK Sweep Count = 0 RF Atten (dB) = 20 Trace Mode = VIEW	M1 : 902.000 MHz : 8.523 dBm M2 : 902.012 MHz : 8.523 dBm M3 : 902.244 MHz : 29.876 dBm	Channel Frequency: 902.20 MHz

[back to matrix](#)

This test report may be reproduced in full only. The document may only be updated by MiCOM Labs personnel. All changes will be noted in the Document History section of the report.



Title: Silver Spring Networks NIC 511-0303
To: FCC CFR 47 Part 15 Subpart C 15.247 & IC RSS 247
Serial #: SSNT108-U8 Rev A
Issue Date: 11th December 2015
Page: 186 of 204

CONDUCTED LOW BAND-EDGE EMISSION - PEAK



Variant: 200 OQPSK, Channel: 902.20 MHz, Chain a, Temp: Ambient, Voltage: 4 Vdc

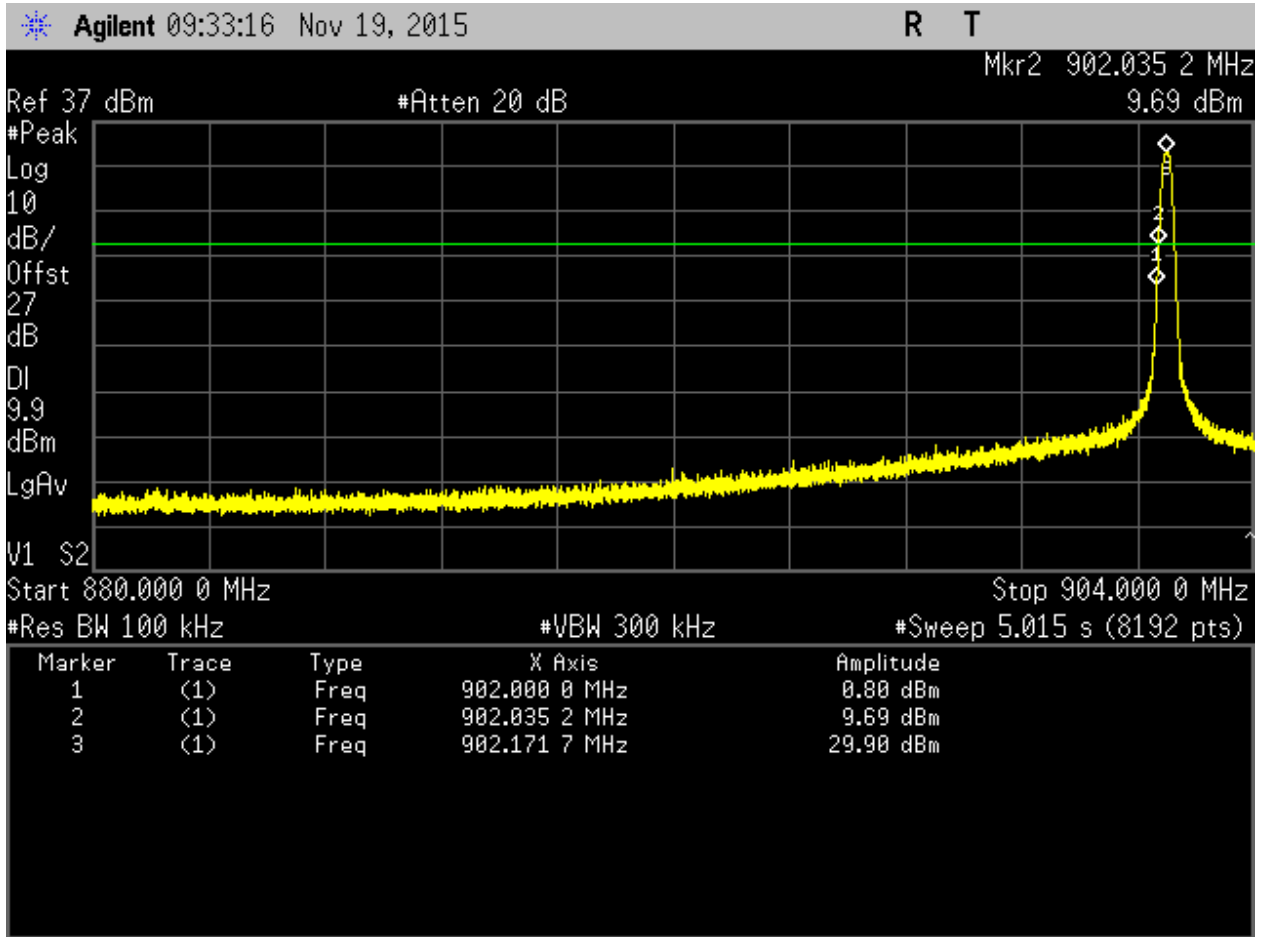

Analyser Setup	Marker:Frequency:Amplitude	Test Results
Detector = MAX PEAK Sweep Count = 0 RF Atten (dB) = 20 Trace Mode = MAX HOLD	M1 : 902.000 MHz : 0.800 dBm M2 : 902.035 MHz : 9.690 dBm M3 : 902.171 MHz : 29.900 dBm	Channel Frequency: 902.20 MHz

[back to matrix](#)

This test report may be reproduced in full only. The document may only be updated by MiCOM Labs personnel. All changes will be noted in the Document History section of the report.



Title: Silver Spring Networks NIC 511-0303
To: FCC CFR 47 Part 15 Subpart C 15.247 & IC RSS 247
Serial #: SSNT108-U8 Rev A
Issue Date: 11th December 2015
Page: 187 of 204

CONDUCTED LOW BAND-EDGE EMISSION - PEAK



Variant: 400 OFDM, Channel: 902.40 MHz, Chain a, Temp: Ambient, Voltage: 4 Vdc

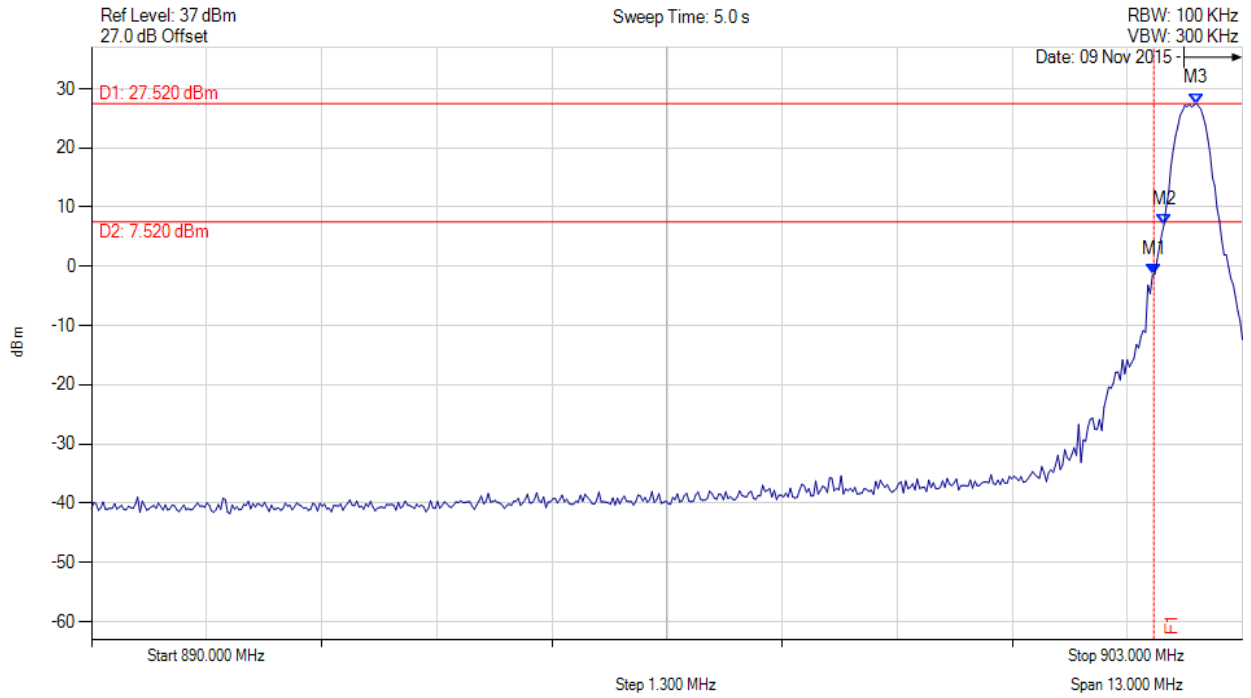

Analyser Setup	Marker:Frequency:Amplitude	Test Results
Detector = MAX PEAK Sweep Count = 0 RF Atten (dB) = 20 Trace Mode = VIEW	M1 : 902.000 MHz : -1.322 dBm M2 : 902.116 MHz : 7.108 dBm M3 : 902.479 MHz : 27.519 dBm	Channel Frequency: 902.40 MHz

[back to matrix](#)

This test report may be reproduced in full only. The document may only be updated by MiCOM Labs personnel. All changes will be noted in the Document History section of the report.



Title: Silver Spring Networks NIC 511-0303
To: FCC CFR 47 Part 15 Subpart C 15.247 & IC RSS 247
Serial #: SSNT108-U8 Rev A
Issue Date: 11th December 2015
Page: 188 of 204

CONDUCTED LOW BAND-EDGE EMISSION - PEAK



Variante: 1200 OFDM, Channel: 903.20 MHz, Chain a, Temp: Ambient, Voltage: 4 Vdc

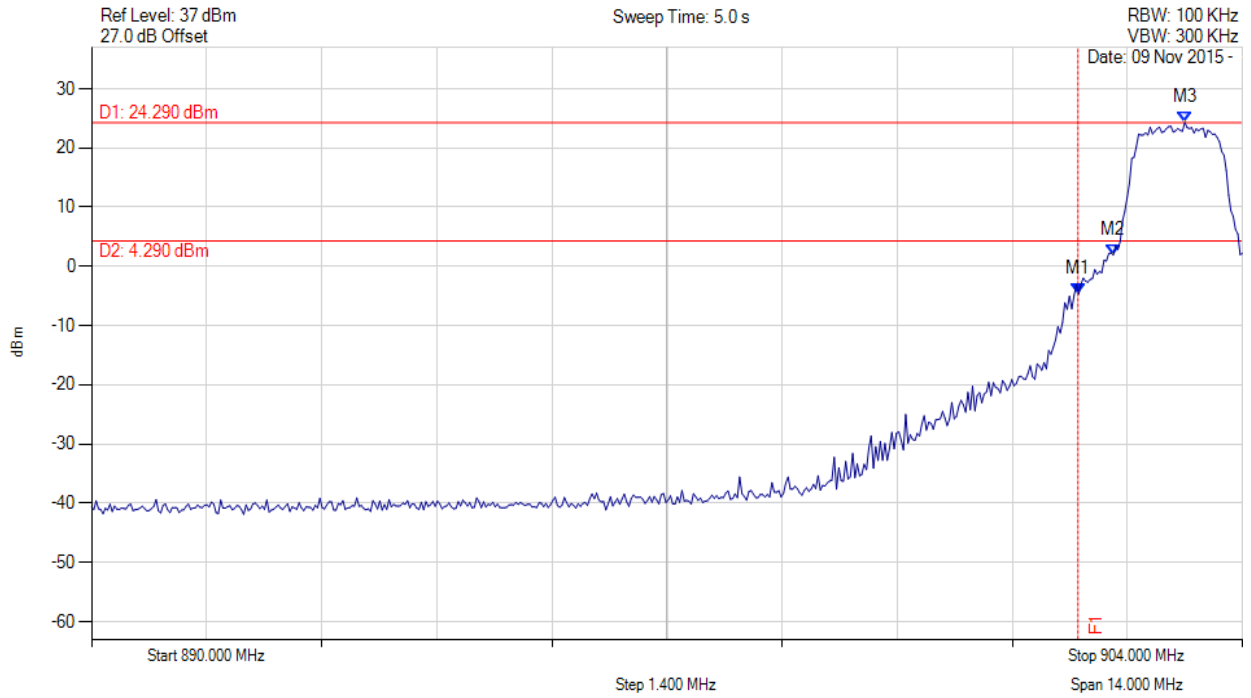

Analyser Setup	Marker:Frequency:Amplitude	Test Results
Detector = MAX PEAK Sweep Count = 0 RF Atten (dB) = 20 Trace Mode = VIEW	M1 : 902.000 MHz : -4.678 dBm M2 : 902.429 MHz : 1.924 dBm M3 : 903.299 MHz : 24.293 dBm	Channel Frequency: 903.20 MHz

[back to matrix](#)

This test report may be reproduced in full only. The document may only be updated by MiCOM Labs personnel. All changes will be noted in the Document History section of the report.



A.6.1.2.2. Conducted High Band-Edge Emissions



CONDUCTED HIGH BAND-EDGE EMISSION - PEAK

Variant: 300 FSK, Channel: 926.90 MHz, Chain a, Temp: Ambient, Voltage: 4 Vdc

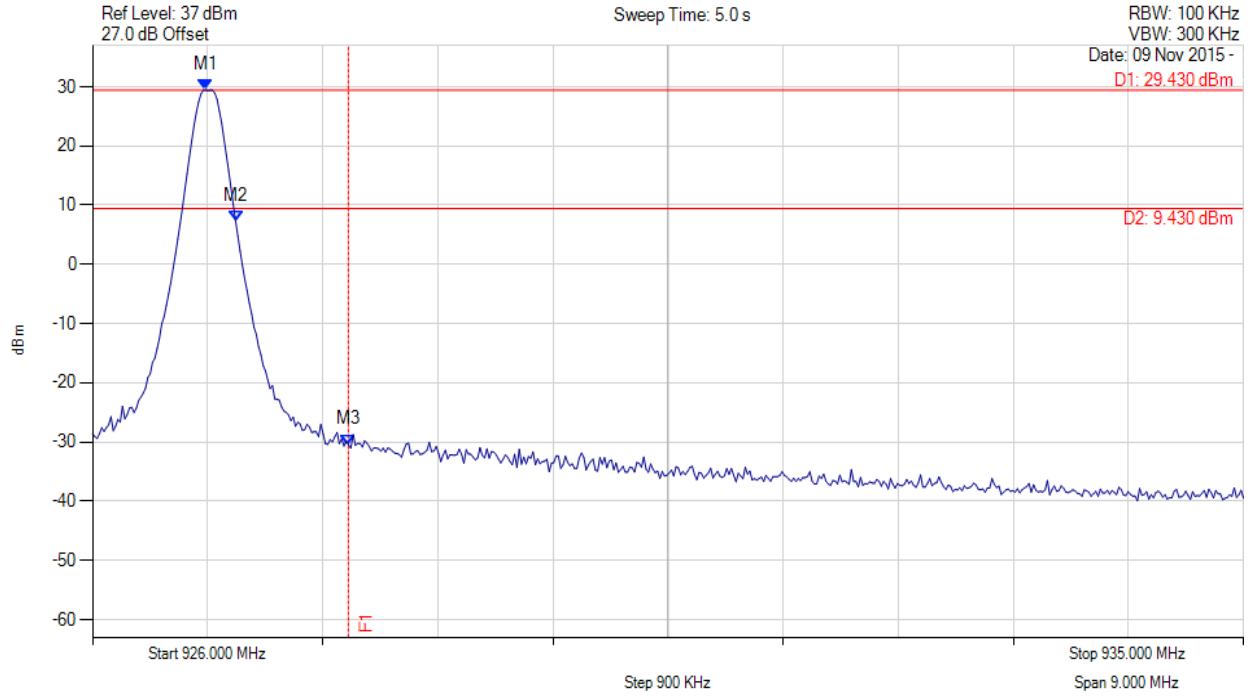

Analyser Setup	Marker:Frequency:Amplitude	Test Results
Detector = MAX PEAK Sweep Count = 0 RF Atten (dB) = 20 Trace Mode = VIEW	M1 : 926.884 MHz : 29.434 dBm M2 : 927.122 MHz : 7.364 dBm M3 : 928.000 MHz : -30.457 dBm	Channel Frequency: 926.90 MHz

[back to matrix](#)

This test report may be reproduced in full only. The document may only be updated by MiCOM Labs personnel. All changes will be noted in the Document History section of the report.



Title: Silver Spring Networks NIC 511-0303
To: FCC CFR 47 Part 15 Subpart C 15.247 & IC RSS 247
Serial #: SSNT108-U8 Rev A
Issue Date: 11th December 2015
Page: 190 of 204

CONDUCTED HIGH BAND-EDGE EMISSION - PEAK



Variant: 300 GFSK, Channel: 926.90 MHz, Chain a, Temp: Ambient, Voltage: 4 Vdc

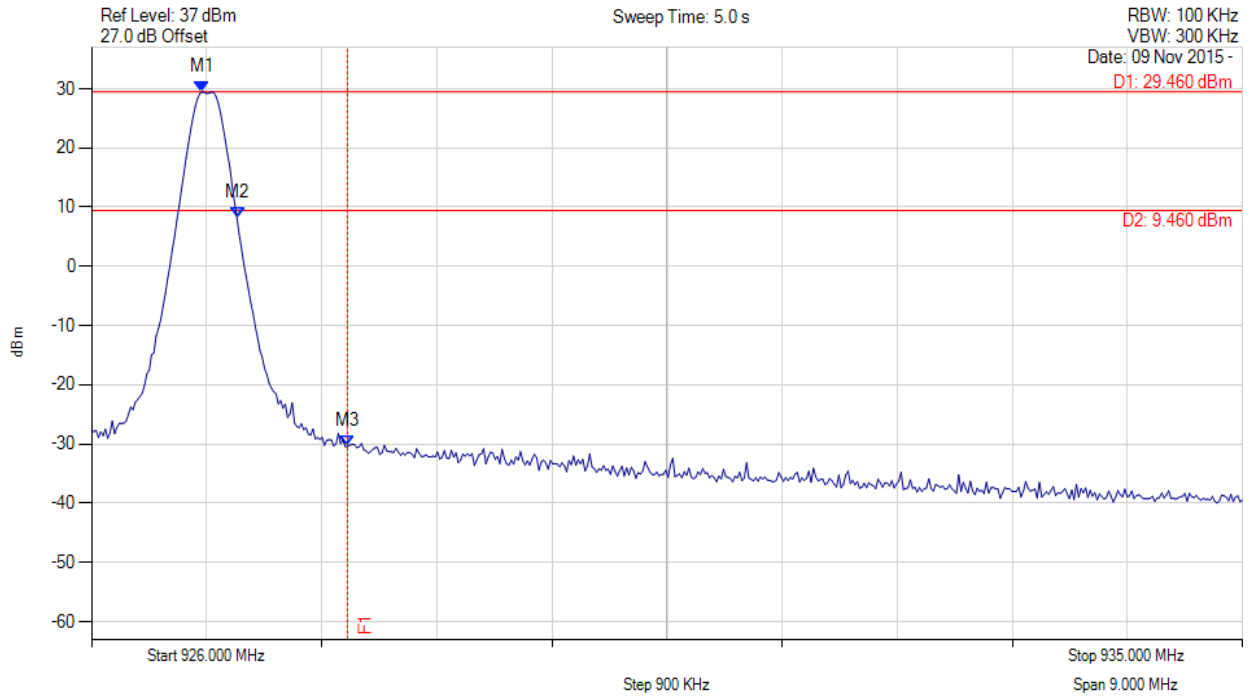

Analyser Setup	Marker:Frequency:Amplitude	Test Results
Detector = MAX PEAK Sweep Count = 0 RF Atten (dB) = 20 Trace Mode = VIEW	M1 : 926.866 MHz : 29.461 dBm M2 : 927.142 MHz : 8.281 dBm M3 : 928.000 MHz : -30.386 dBm	Channel Frequency: 926.90 MHz

[back to matrix](#)

This test report may be reproduced in full only. The document may only be updated by MiCOM Labs personnel. All changes will be noted in the Document History section of the report.



Title: Silver Spring Networks NIC 511-0303
To: FCC CFR 47 Part 15 Subpart C 15.247 & IC RSS 247
Serial #: SSNT108-U8 Rev A
Issue Date: 11th December 2015
Page: 191 of 204

CONDUCTED HIGH BAND-EDGE EMISSION - PEAK



Variant: 300 GFSK, Channel: 926.90 MHz, Chain a, Temp: Ambient, Voltage: 4 Vdc

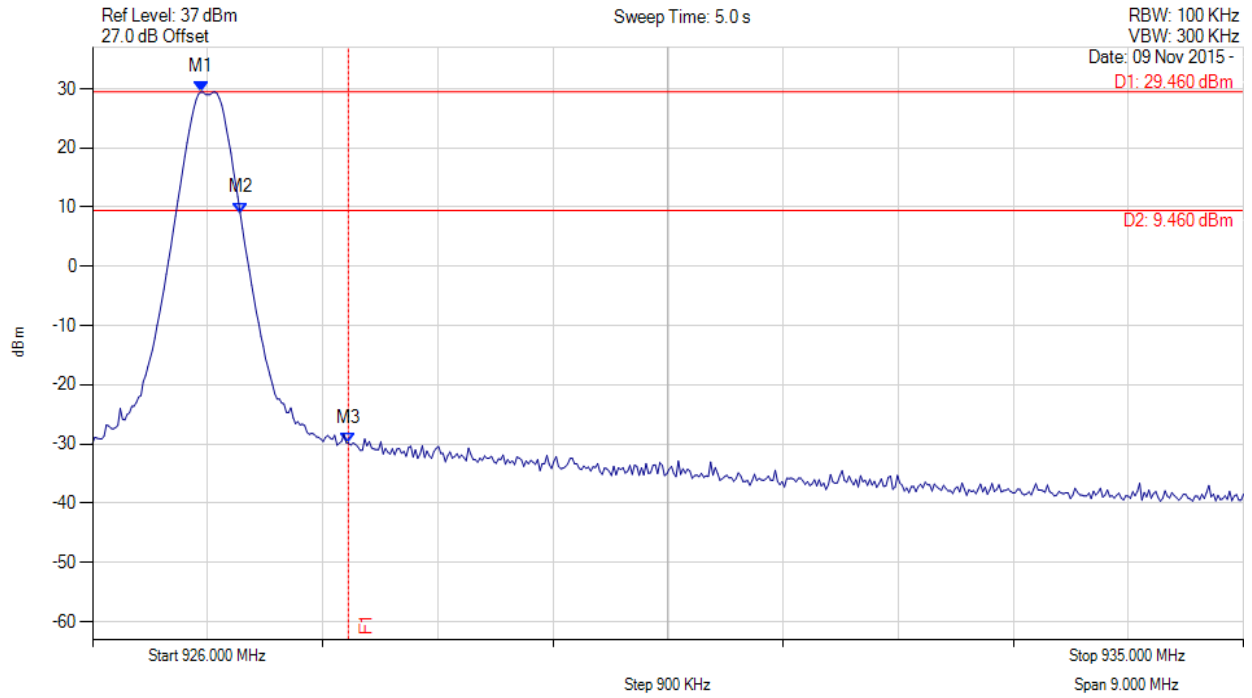

Analyser Setup	Marker:Frequency:Amplitude	Test Results
Detector = MAX PEAK Sweep Count = 0 RF Atten (dB) = 20 Trace Mode = VIEW	M1 : 926.848 MHz : 29.459 dBm M2 : 927.160 MHz : 9.036 dBm M3 : 928.000 MHz : -29.859 dBm	Channel Frequency: 926.90 MHz

[back to matrix](#)

This test report may be reproduced in full only. The document may only be updated by MiCOM Labs personnel. All changes will be noted in the Document History section of the report.



Title: Silver Spring Networks NIC 511-0303
To: FCC CFR 47 Part 15 Subpart C 15.247 & IC RSS 247
Serial #: SSNT108-U8 Rev A
Issue Date: 11th December 2015
Page: 192 of 204

CONDUCTED HIGH BAND-EDGE EMISSION - PEAK



Variant: 400 FSK, Channel: 927.60 MHz, Chain a, Temp: Ambient, Voltage: 4 Vdc

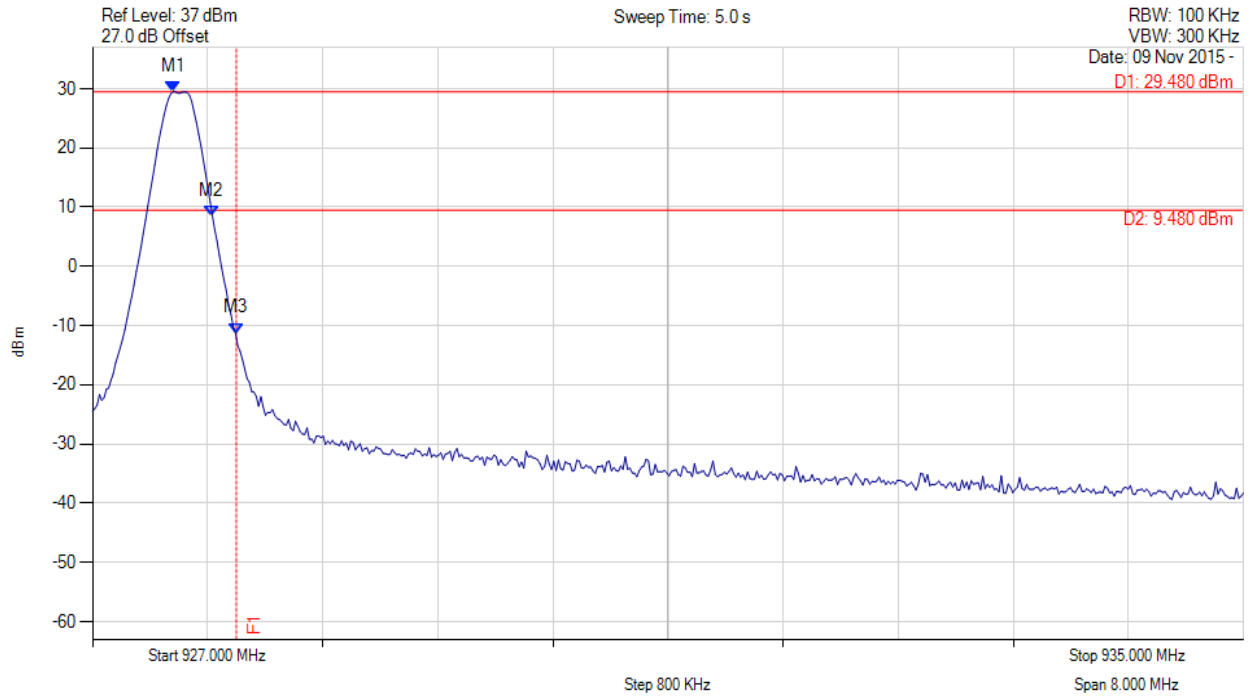

Analyser Setup	Marker:Frequency:Amplitude	Test Results
Detector = MAX PEAK Sweep Count = 0 RF Atten (dB) = 20 Trace Mode = VIEW	M1 : 927.561 MHz : 29.479 dBm M2 : 927.828 MHz : 8.473 dBm M3 : 928.000 MHz : -11.287 dBm	Channel Frequency: 927.60 MHz

[back to matrix](#)

This test report may be reproduced in full only. The document may only be updated by MiCOM Labs personnel. All changes will be noted in the Document History section of the report.



Title: Silver Spring Networks NIC 511-0303
To: FCC CFR 47 Part 15 Subpart C 15.247 & IC RSS 247
Serial #: SSNT108-U8 Rev A
Issue Date: 11th December 2015
Page: 193 of 204



CONDUCTED HIGH BAND-EDGE EMISSION - PEAK

Variant: 400 GFSK, Channel: 927.60 MHz, Chain a, Temp: Ambient, Voltage: 4 Vdc

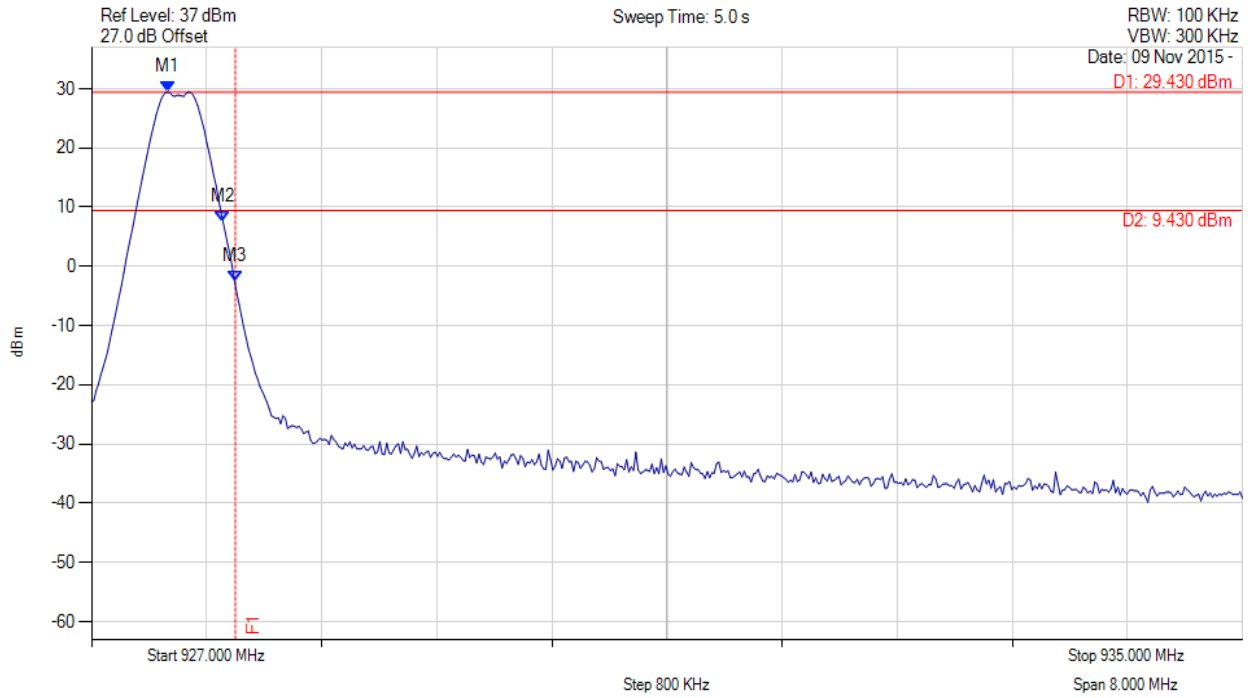

Analyser Setup	Marker:Frequency:Amplitude	Test Results
Detector = MAX PEAK Sweep Count = 0 RF Atten (dB) = 20 Trace Mode = VIEW	M1 : 927.529 MHz : 29.432 dBm M2 : 927.914 MHz : 7.562 dBm M3 : 928.000 MHz : -2.447 dBm	Channel Frequency: 927.60 MHz

[back to matrix](#)

This test report may be reproduced in full only. The document may only be updated by MiCOM Labs personnel. All changes will be noted in the Document History section of the report.



Title: Silver Spring Networks NIC 511-0303
To: FCC CFR 47 Part 15 Subpart C 15.247 & IC RSS 247
Serial #: SSNT108-U8 Rev A
Issue Date: 11th December 2015
Page: 194 of 204

CONDUCTED HIGH BAND-EDGE EMISSION - PEAK



Variant: 200 2FSK, Channel: 927.80 MHz, Chain a, Temp: Ambient, Voltage: 4 Vdc

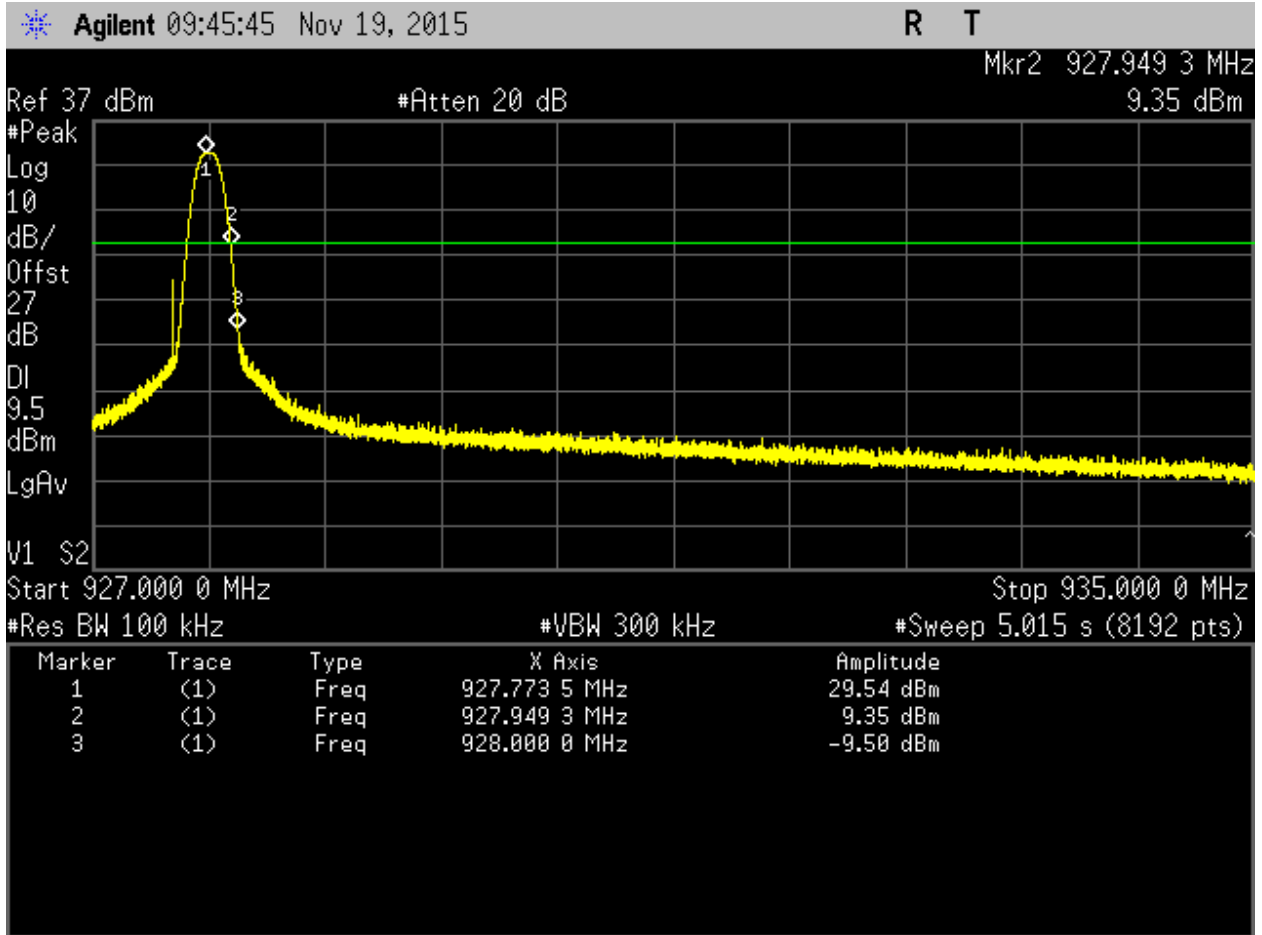

Analyser Setup	Marker:Frequency:Amplitude	Test Results
Detector = MAX PEAK Sweep Count = 0 RF Atten (dB) = 20 Trace Mode = VIEW	M1 : 927.577 MHz : 29.540 dBm M2 : 927.802 MHz : 9.350 dBm M3 : 928.000 MHz : -9.500 dBm	Channel Frequency: 927.80 MHz

[back to matrix](#)

This test report may be reproduced in full only. The document may only be updated by MiCOM Labs personnel. All changes will be noted in the Document History section of the report.



Title: Silver Spring Networks NIC 511-0303
To: FCC CFR 47 Part 15 Subpart C 15.247 & IC RSS 247
Serial #: SSNT108-U8 Rev A
Issue Date: 11th December 2015
Page: 195 of 204

CONDUCTED HIGH BAND-EDGE EMISSION - PEAK



Variant: 200 OQPSK, Channel: 927.80 MHz, Chain a, Temp: Ambient, Voltage: 4 Vdc

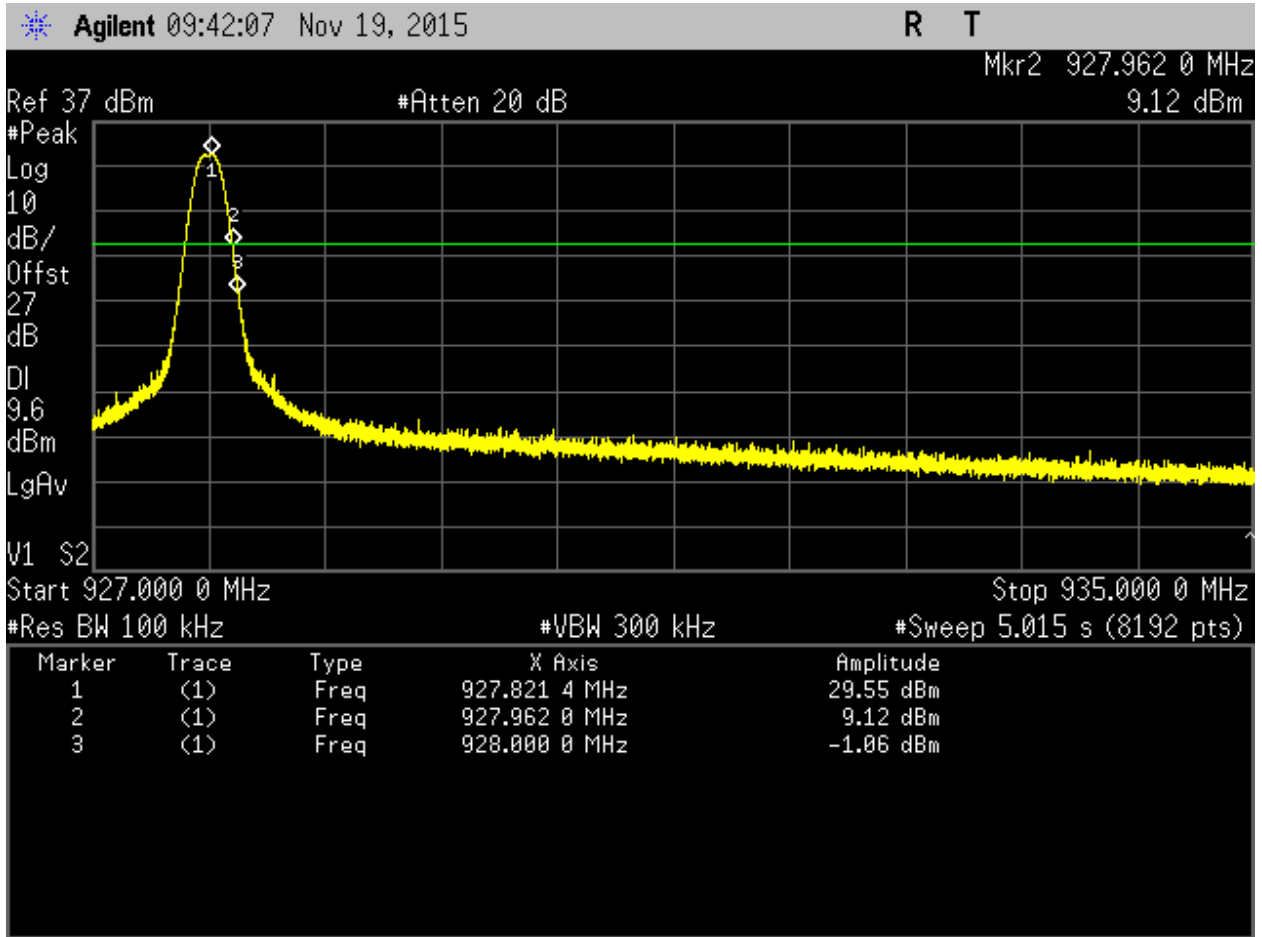

Analyser Setup	Marker:Frequency:Amplitude	Test Results
Detector = MAX PEAK Sweep Count = 0 RF Atten (dB) = 20 Trace Mode = VIEW	M1 : 927.821 MHz : 29.550 dBm M2 : 927.962 MHz : 9.120 dBm M3 : 928.000 MHz : -1.060 dBm	Channel Frequency: 927.80 MHz

[back to matrix](#)

This test report may be reproduced in full only. The document may only be updated by MiCOM Labs personnel. All changes will be noted in the Document History section of the report.



Title: Silver Spring Networks NIC 511-0303
To: FCC CFR 47 Part 15 Subpart C 15.247 & IC RSS 247
Serial #: SSNT108-U8 Rev A
Issue Date: 11th December 2015
Page: 196 of 204

CONDUCTED HIGH BAND-EDGE EMISSION - PEAK



Variant: 400 OFDM, Channel: 927.60 MHz, Chain a, Temp: Ambient, Voltage: 4 Vdc

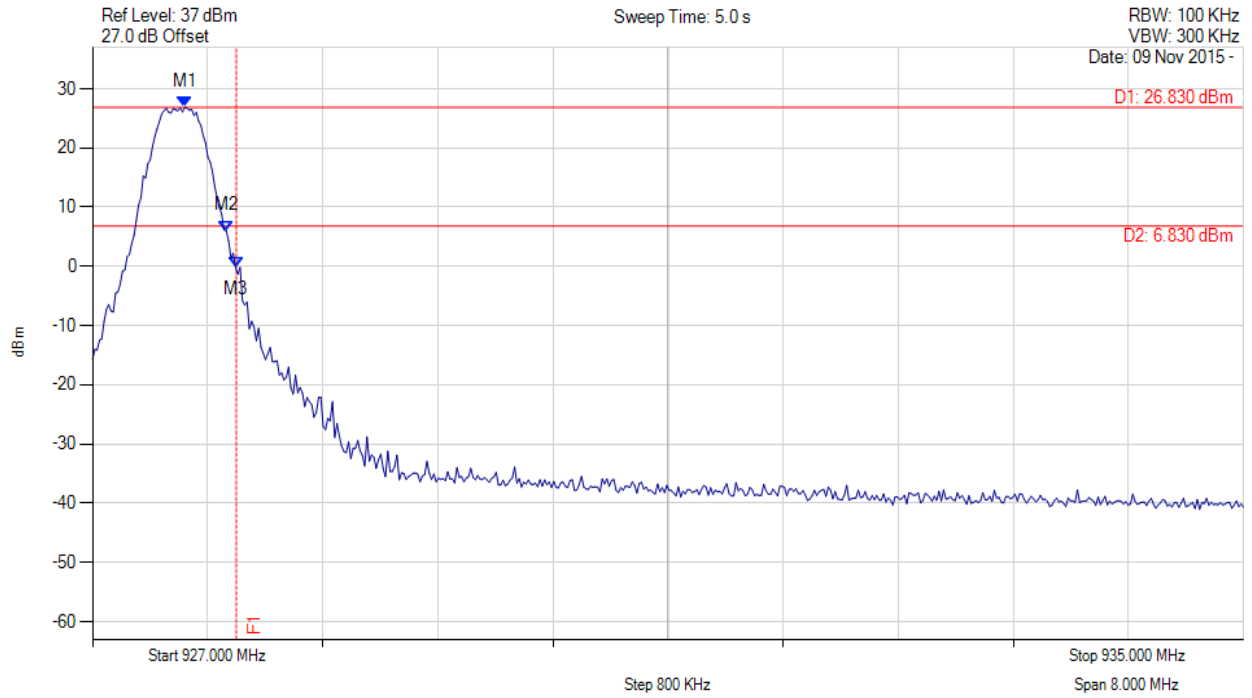

Analyser Setup	Marker:Frequency:Amplitude	Test Results
Detector = MAX PEAK Sweep Count = 0 RF Atten (dB) = 20 Trace Mode = VIEW	M1 : 927.641 MHz : 26.825 dBm M2 : 927.930 MHz : 6.012 dBm M3 : 928.000 MHz : -0.175 dBm	Channel Frequency: 927.60 MHz

[back to matrix](#)

This test report may be reproduced in full only. The document may only be updated by MiCOM Labs personnel. All changes will be noted in the Document History section of the report.



Title: Silver Spring Networks NIC 511-0303
To: FCC CFR 47 Part 15 Subpart C 15.247 & IC RSS 247
Serial #: SSNT108-U8 Rev A
Issue Date: 11th December 2015
Page: 197 of 204

CONDUCTED HIGH BAND-EDGE EMISSION - PEAK



Variants: 1200 OFDM, Channel: 926.00 MHz, Chain a, Temp: Ambient, Voltage: 4 Vdc

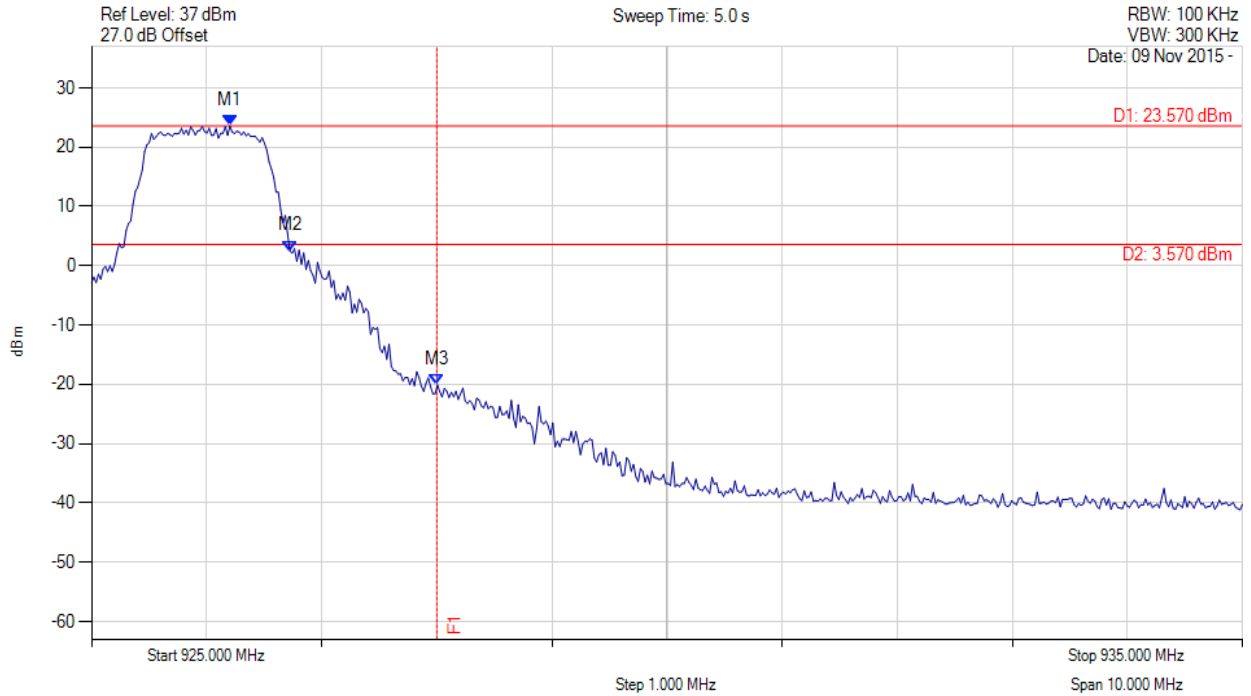

Analyser Setup	Marker:Frequency:Amplitude	Test Results
Detector = MAX PEAK Sweep Count = 0 RF Atten (dB) = 20 Trace Mode = VIEW	M1 : 926.202 MHz : 23.573 dBm M2 : 926.727 MHz : 2.504 dBm M3 : 928.000 MHz : -20.097 dBm	Channel Frequency: 926.00 MHz

[back to matrix](#)

This test report may be reproduced in full only. The document may only be updated by MiCOM Labs personnel. All changes will be noted in the Document History section of the report.



A.7. Power Spectral Density

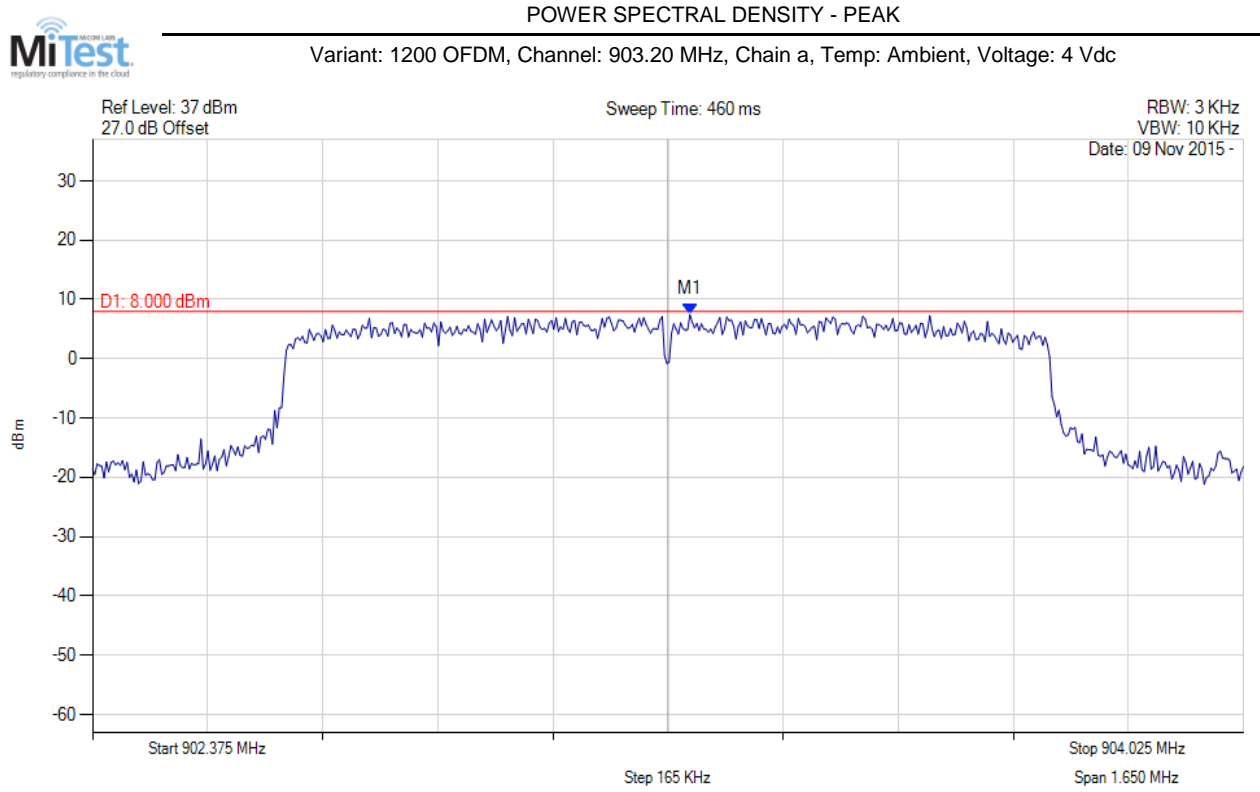

Analyser Setup	Marker:Frequency:Amplitude	Test Results
Detector = MAX PEAK Sweep Count = 0 RF Atten (dB) = 20 Trace Mode = VIEW	M1 : 903.231 MHz : 7.448 dBm	Channel Frequency: 903.20 MHz

[back to matrix](#)

This test report may be reproduced in full only. The document may only be updated by MiCOM Labs personnel. All changes will be noted in the Document History section of the report.



Title: Silver Spring Networks NIC 511-0303
To: FCC CFR 47 Part 15 Subpart C 15.247 & IC RSS 247
Serial #: SSNT108-U8 Rev A
Issue Date: 11th December 2015
Page: 199 of 204



POWER SPECTRAL DENSITY - PEAK

Variant: 1200 OFDM, Channel: 903.20 MHz, SUM, Temp: Ambient, Voltage: 4 Vdc

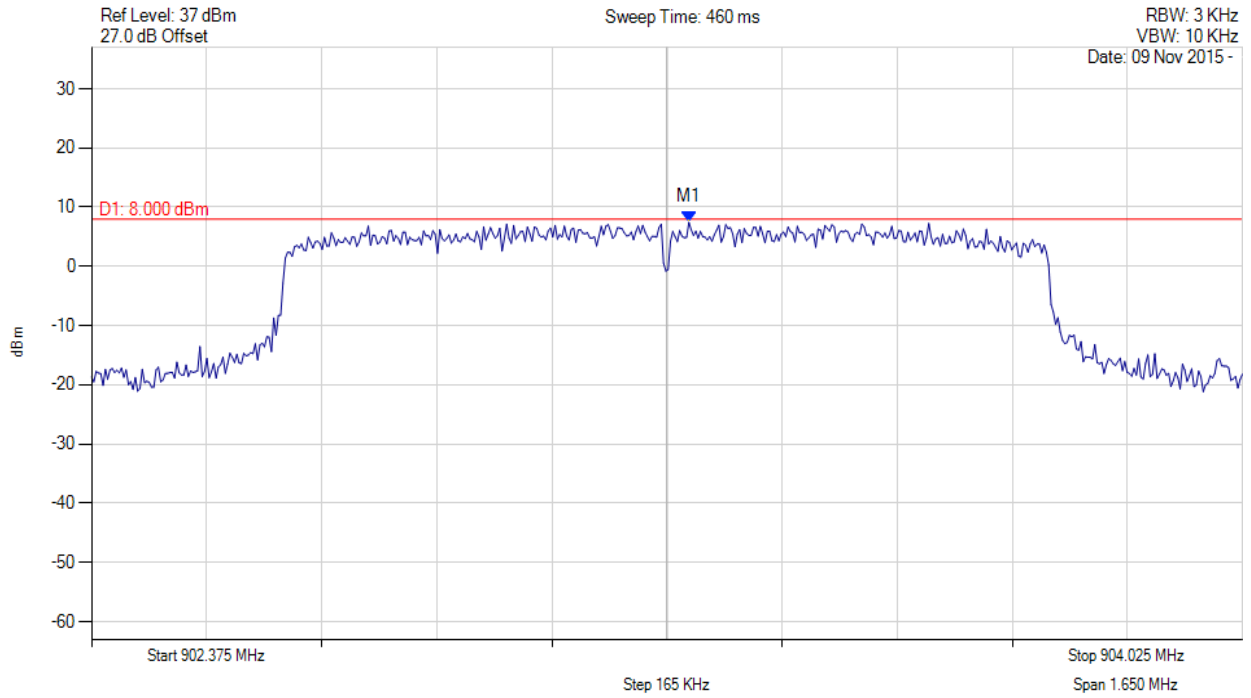

Analyser Setup	Marker:Frequency:Amplitude	Test Results
Detector = MAX PEAK Sweep Count = 0 RF Atten (dB) = 20 Trace Mode = VIEW	M1 : 903.231 MHz : 7.448 dBm	Channel Frequency: 903.20 MHz

[back to matrix](#)

This test report may be reproduced in full only. The document may only be updated by MiCOM Labs personnel. All changes will be noted in the Document History section of the report.



Title: Silver Spring Networks NIC 511-0303
To: FCC CFR 47 Part 15 Subpart C 15.247 & IC RSS 247
Serial #: SSNT108-U8 Rev A
Issue Date: 11th December 2015
Page: 200 of 204

POWER SPECTRAL DENSITY - PEAK



Variant: 1200 OFDM, Channel: 914.00 MHz, Chain a, Temp: Ambient, Voltage: 4 Vdc

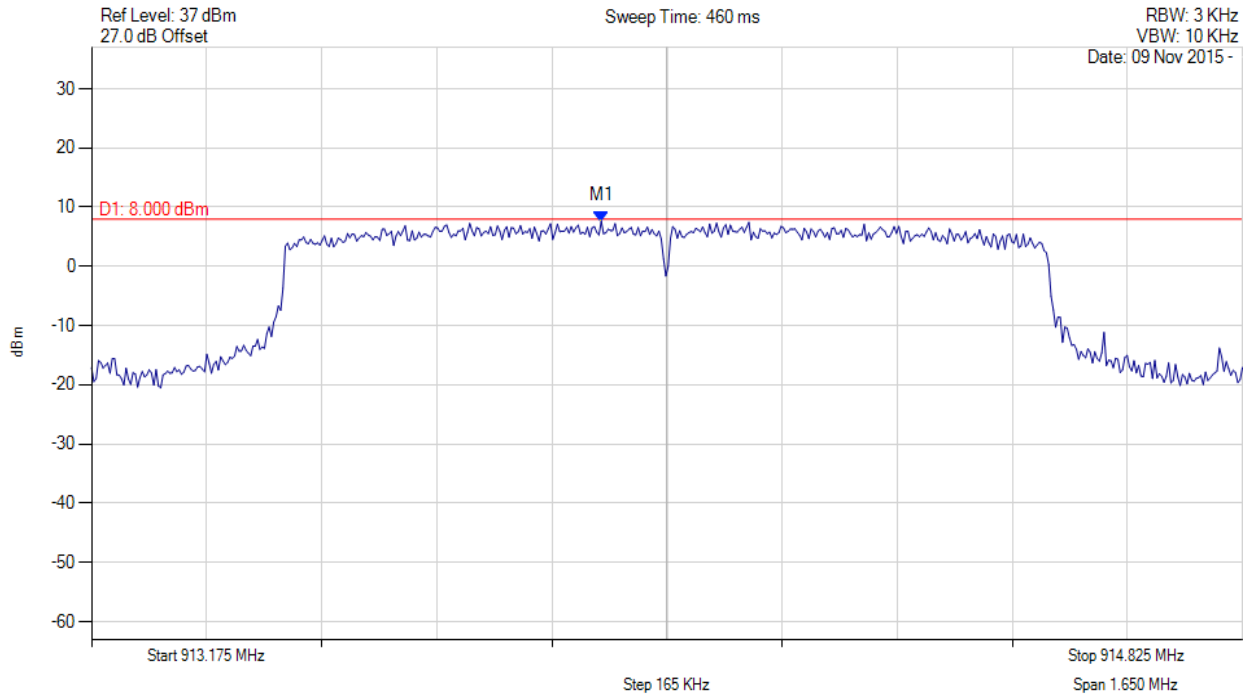

Analyser Setup	Marker:Frequency:Amplitude	Test Results
Detector = MAX PEAK Sweep Count = 0 RF Atten (dB) = 20 Trace Mode = VIEW	M1 : 913.906 MHz : 7.637 dBm	Channel Frequency: 914.00 MHz

[back to matrix](#)

This test report may be reproduced in full only. The document may only be updated by MiCOM Labs personnel. All changes will be noted in the Document History section of the report.



Title: Silver Spring Networks NIC 511-0303
To: FCC CFR 47 Part 15 Subpart C 15.247 & IC RSS 247
Serial #: SSNT108-U8 Rev A
Issue Date: 11th December 2015
Page: 201 of 204

POWER SPECTRAL DENSITY - PEAK



Variant: 1200 OFDM, Channel: 914.00 MHz, SUM, Temp: Ambient, Voltage: 4 Vdc

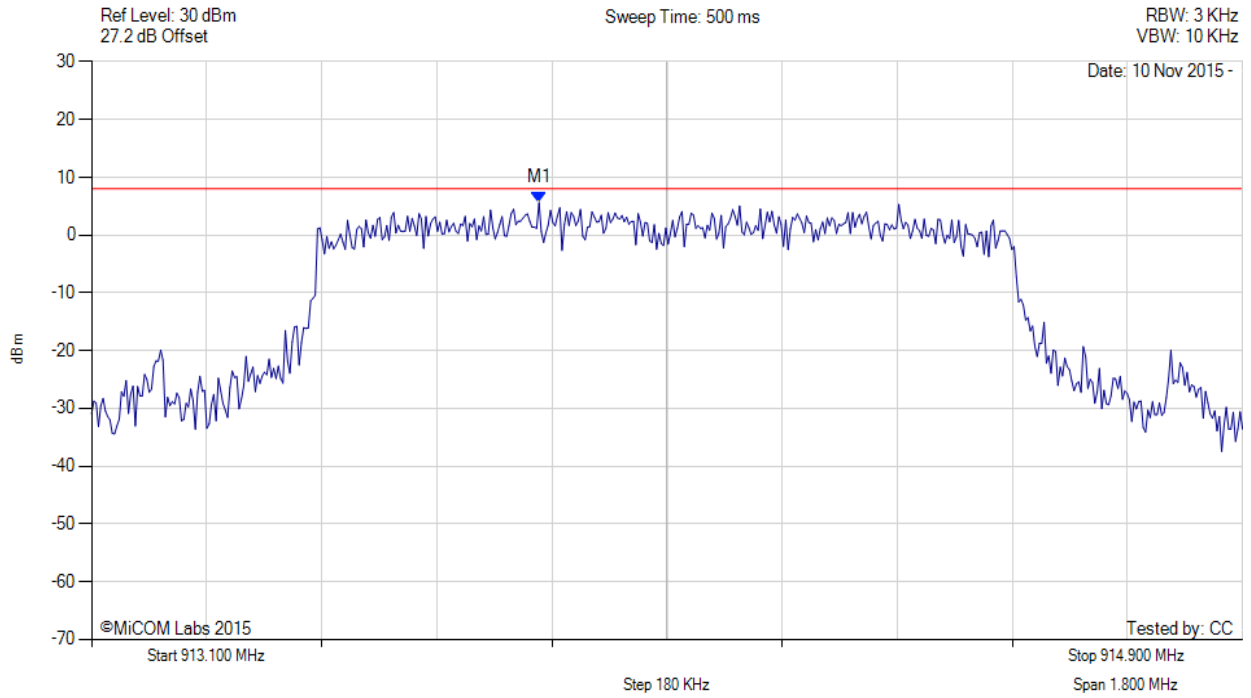

Analyser Setup	Marker:Frequency:Amplitude	Test Results
Detector = MAX PEAK Sweep Count = 0 RF Atten (dB) = 30 Trace Mode = VIEW	M1 : 913.800 MHz : 5.621 dBm	Limit: ≤ 8.0 dBm Margin: -2.4 dB

[back to matrix](#)

This test report may be reproduced in full only. The document may only be updated by MiCOM Labs personnel. All changes will be noted in the Document History section of the report.



Title: Silver Spring Networks NIC 511-0303
To: FCC CFR 47 Part 15 Subpart C 15.247 & IC RSS 247
Serial #: SSNT108-U8 Rev A
Issue Date: 11th December 2015
Page: 202 of 204

POWER SPECTRAL DENSITY - PEAK



Variant: 1200 OFDM, Channel: 926.00 MHz, Chain a, Temp: Ambient, Voltage: 4 Vdc

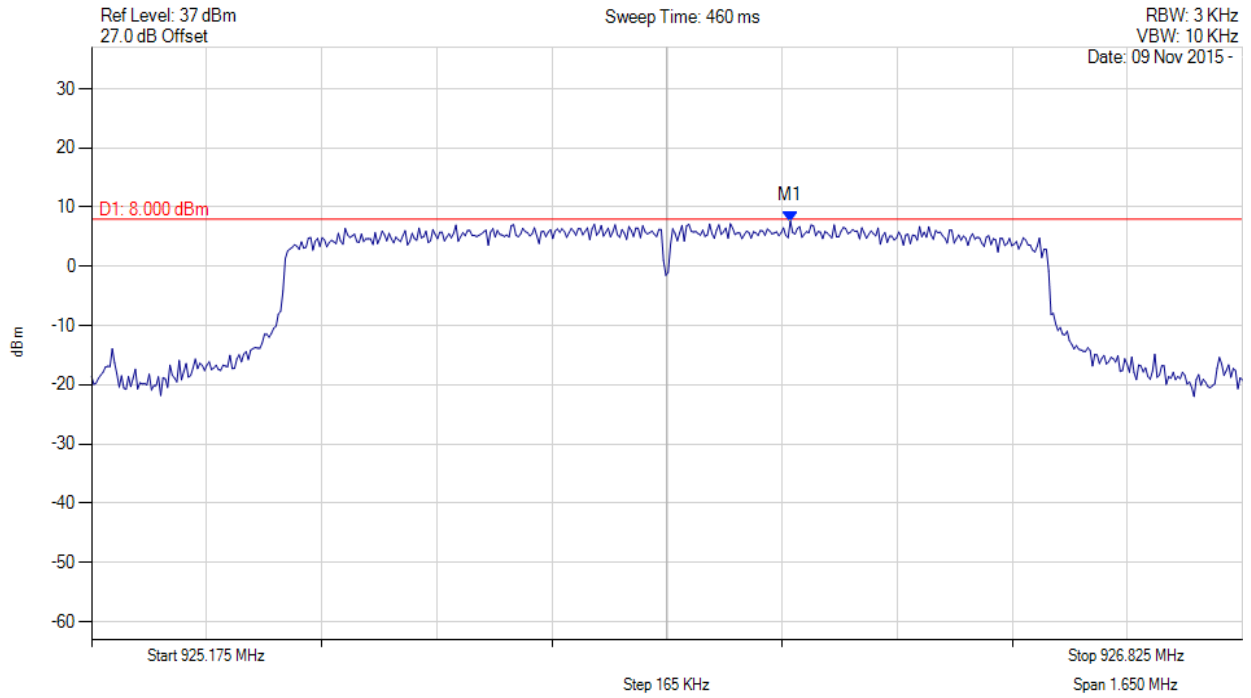

Analyser Setup	Marker:Frequency:Amplitude	Test Results
Detector = MAX PEAK Sweep Count = 0 RF Atten (dB) = 20 Trace Mode = VIEW	M1 : 926.177 MHz : 7.633 dBm	Channel Frequency: 926.00 MHz

[back to matrix](#)

This test report may be reproduced in full only. The document may only be updated by MiCOM Labs personnel. All changes will be noted in the Document History section of the report.



Title: Silver Spring Networks NIC 511-0303
To: FCC CFR 47 Part 15 Subpart C 15.247 & IC RSS 247
Serial #: SSNT108-U8 Rev A
Issue Date: 11th December 2015
Page: 203 of 204



POWER SPECTRAL DENSITY - PEAK

Variant: 1200 OFDM, Channel: 926.00 MHz, SUM, Temp: Ambient, Voltage: 4 Vdc

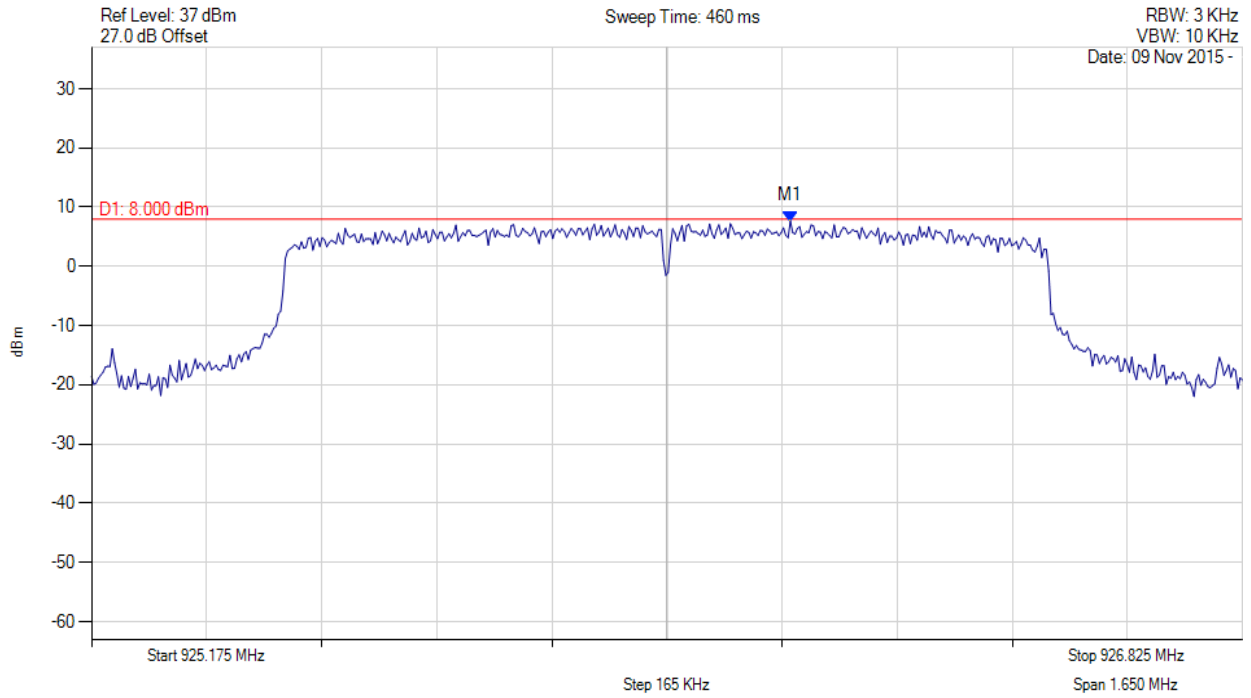

Analyser Setup	Marker:Frequency:Amplitude	Test Results
Detector = MAX PEAK Sweep Count = 0 RF Atten (dB) = 20 Trace Mode = VIEW	M1 : 926.177 MHz : 7.633 dBm	Channel Frequency: 926.00 MHz

[back to matrix](#)

This test report may be reproduced in full only. The document may only be updated by MiCOM Labs personnel. All changes will be noted in the Document History section of the report.



575 Boulder Court
Pleasanton, California 94566, USA
Tel: +1 (925) 462 0304
Fax: +1 (925) 462 0306
www.micomlabs.com