

Test of Silver Spring Networks NIC 451

To: FCC 47 CFR Part15.247 & IC RSS-210

Test Report Serial No.: SSNT92-U2B Rev A



TEST REPORT
FROM
MiCOM Labs

Test of Silver Spring Networks NIC 451

To FCC 47 CFR Part15.247 & IC RSS-210

Test Report Serial No.: SSNT92-U2B Rev A

This report supersedes: None

Manufacturer: Silver Spring Networks
555 Broadway Street
Redwood City
California 94063, USA

Product Function: Machine to machine communication

Copy No: pdf **Issue Date:** 27th April 2015

This Test Report is Issued Under the Authority of;

MiCOM Labs, Inc.

575 Boulder Court,
Pleasanton, CA 94566 USA
Phone: +1 (925) 462-0304
Fax: +1 (925) 462-0306
www.micomlabs.com



TESTING CERT #2381.01

MiCOM Labs is an ISO 17025 Accredited Testing Laboratory



Title: Silver Spring Networks NIC 451
To: FCC 47 CFR Part15.247 & IC RSS-210
Serial #: SSNT92-U2B Rev A
Issue Date: 27th April 2015
Page: 3 of 70

This page has been left intentionally blank

This test report may be reproduced in full only. The document may only be updated by MiCOM Labs personnel. Any changes will be noted in the Document History section of the report.



TABLE OF CONTENTS

ACCREDITATION, LISTINGS & RECOGNITION	5
TESTING ACCREDITATION	5
RECOGNITION.....	6
PRODUCT CERTIFICATION	7
1. TEST RESULT CERTIFICATE.....	9
2. REFERENCES AND MEASUREMENT UNCERTAINTY	10
2.1. Normative References	10
2.2. Test and Uncertainty Procedures.....	11
3. PRODUCT DETAILS AND TEST CONFIGURATIONS.....	12
3.1. Technical Details.....	12
3.2. Scope of Test Program	13
3.3. Product Description.....	14
3.4. Equipment Model(s) and Serial Number(s).....	15
3.5. Antenna Details.....	15
3.6. Cabling and I/O Ports.....	15
3.7. Test Configurations.....	15
3.8. Equipment Modifications	16
3.9. Deviations from the Test Standard	16
4. TEST EQUIPMENT CONFIGURATION(S).....	17
4.1. Conducted RF Emission Test Set-up	17
5. SUMMARY.....	21
6. TEST RESULTS.....	23
Device Characteristics	23
6.1. 20 dB & 99% Bandwidth.....	23
6.2. Number of Channels	25
6.3. Channel Spacing.....	28
6.4. Dwell Time & Channel Occupancy	30
6.5. Output Power	33
6.6. Conducted Spurious Emissions Transmitter.....	35
6.7. Radiated Spurious Emissions > 1 GHz.....	38
6.8. Radiated Emissions – Digital Emissions (0.03-1 GHz)	53
6.9. AC Wireline Conducted Emissions (150 kHz – 30 MHz).....	59
APPENDIX.....	61
A. SUPPORTING INFORMATION.....	61
A.1. CONDUCTED TEST PLOTS.....	61
A.1.1. 20 dB & 99% Bandwidth.....	62
A.1.2. Conducted Spurious and Band-Edge Emissions.....	65

This test report may be reproduced in full only. The document may only be updated by MiCOM Labs personnel. Any changes will be noted in the Document History section of the report.

ACCREDITATION, LISTINGS & RECOGNITION

TESTING ACCREDITATION

MiCOM Labs, Inc. is an accredited Electrical testing laboratory per the international standard ISO/IEC 17025. The company is accredited by the American Association for Laboratory Accreditation (A2LA) www.a2la.org test laboratory number 2381.01. MiCOM Labs test schedule is available at the following URL; <http://www.a2la.org/scopepdf/2381-01.pdf>



American Association for Laboratory Accreditation

Accredited Laboratory

A2LA has accredited

MICOM LABS

Pleasanton, CA

for technical competence in the field of

Electrical Testing

This laboratory is accredited in accordance with the recognized International Standard ISO/IEC 17025:2005 *General Requirements for the Competence of Testing and Calibration Laboratories*. This accreditation demonstrates technical competence for a defined scope and the operation of a laboratory quality management system (refer to joint ISO-ILAC-LAF Communiqué dated 8 January 2009).

Presented this 28th day of February 2014.



President & CEO
For the Accreditation Council
Certificate Number 2381.01
Valid to November 30, 2015



For the tests or types of tests to which this accreditation applies, please refer to the laboratory's Electrical Scope of Accreditation.

This test report may be reproduced in full only. The document may only be updated by MiCOM Labs personnel. Any changes will be noted in the Document History section of the report.



RECOGNITION

MiCOM Labs, Inc has widely recognized Electrical testing capabilities. Our international recognition includes Conformity Assessment Body designation by APEC MRA** countries. Our test reports are widely accepted for global type approvals.

Country	Recognition Body	Status	Phase	Identification No.
USA	Federal Communications Commission (FCC)	TCB	-	US0159 Listing #: 102167
Canada	Industry Canada (IC)	FCB	APEC MRA 2	US0159 Listing #: 4143A-2 4143A-3
Japan	MIC (Ministry of Internal Affairs and Communication)	CAB	APEC MRA 2	RCB 210
	VCCI	--	--	A-0012
Europe	European Commission	NB	EU MRA	NB 2280
Australia	Australian Communications and Media Authority (ACMA)	CAB	APEC MRA 1	US0159
Hong Kong	Office of the Telecommunication Authority (OFTA)	CAB	APEC MRA 1	
Korea	Ministry of Information and Communication Radio Research Laboratory (RRL)	CAB	APEC MRA 1	
Singapore	Infocomm Development Authority (IDA)	CAB	APEC MRA 1	
Taiwan	National Communications Commission (NCC) Bureau of Standards, Metrology and Inspection (BSMI)	CAB	APEC MRA 1	
Vietnam	Ministry of Communication (MIC)	CAB	APEC MRA 1	

**APEC MRA – Asia Pacific Economic Community Mutual Recognition Agreement.

Is a recognition agreement under which test lab is accredited to regulatory standards of the APEC member countries.

Phase I - recognition for product testing

Phase II – recognition for both product testing and certification

N/A – Not Applicable

**EU MRA – European Union Mutual Recognition Agreement.

Is a recognition agreement under which test lab is accredited to regulatory standards of the EU member countries.

**NB – Notified Body

This test report may be reproduced in full only. The document may only be updated by MiCOM Labs personnel. Any changes will be noted in the Document History section of the report.

PRODUCT CERTIFICATION

MiCOM Labs, Inc. is an accredited Product Certification Body per the international standard ISO/IEC 17065. The company is accredited by the American Association for Laboratory Accreditation (A2LA) www.a2la.org test laboratory number 2381.02. MiCOM Labs test schedule is available at the following URL; <http://www.a2la.org/scopepdf/2381-02.pdf>



American Association for Laboratory Accreditation

Accredited Product Certification Body

A2LA has accredited

MICOM LABS

Pleasanton, CA

for technical competence as a

Product Certification Body

This product certification body is accredited in accordance with the recognized International Standard ISO/IEC 17065:2012 - *Requirements for bodies certifying products, processes and services*. This accreditation demonstrates technical competence for a defined scope and the operation of a quality management system.

Presented this 28th day of February 2014.



President & CEO
For the Accreditation Council
Certificate Number 2381.02
Valid to November 30, 2015



For the product certification schemes to which this accreditation applies, please refer to the organization's Product Certification Scope of Accreditation

United States of America – Telecommunication Certification Body (TCB)

TCB Identifier – US0159

Industry Canada – Certification Body

CAB Identifier – US0159

Europe – Notified Body

Notified Body Identifier - 2280

Japan – Recognized Certification Body (RCB)

RCB Identifier - 210

This test report may be reproduced in full only. The document may only be updated by MiCOM Labs personnel. Any changes will be noted in the Document History section of the report.



Title: Silver Spring Networks NIC 451
To: FCC 47 CFR Part15.247 & IC RSS-210
Serial #: SSNT92-U2B Rev A
Issue Date: 27th April 2015
Page: 8 of 70

DOCUMENT HISTORY

Document History		
Revision	Date	Comments
Draft		
Rev A	27 th April 2015	Initial release.

This test report may be reproduced in full only. The document may only be updated by MiCOM Labs personnel. Any changes will be noted in the Document History section of the report.



Title: Silver Spring Networks NIC 451
To: FCC 47 CFR Part15.247 & IC RSS-210
Serial #: SSNT92-U2B Rev A
Issue Date: 27th April 2015
Page: 9 of 70

1. TEST RESULT CERTIFICATE

Manufacturer:	Silver Spring Networks 555 Broadway Street Redwood City California 94063, USA	Tested By:	MiCOM Labs, Inc. 575 Boulder Court Pleasanton California, 94566, USA
EUT:	Network Interface Card (NIC)	Telephone:	+1 925 462 0304
Model:	NIC 451-0523-10	Fax:	+1 925 462 0306
S/N:	00:13:50:07:00:00:03:CD		
Test Date(s):	25th to 26th March 2015	Website:	www.micomlabs.com

STANDARD(S)	TEST RESULTS
FCC 47 CFR Part15.247 & IC RSS-210	EQUIPMENT COMPLIES

MiCOM Labs, Inc. tested the equipment mentioned in accordance with the requirements set forth in the above standards. Test results indicate that the equipment tested is capable of demonstrating compliance with the requirements as documented within this report.

Notes:

1. This document reports conditions under which testing was conducted and the results of testing performed.
2. Details of test methods used have been recorded and kept on file by the laboratory.
3. Test results apply only to the item(s) tested.

Approved & Released for MiCOM Labs, Inc. by:





Graeme Grieve
Quality Manager MiCOM Labs, Inc.

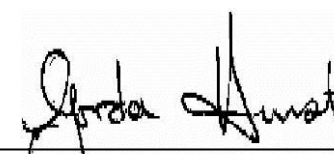

Gordon Hurst
President & CEO MiCOM Labs, Inc.

This test report may be reproduced in full only. The document may only be updated by MiCOM Labs personnel. Any changes will be noted in the Document History section of the report.

2. REFERENCES AND MEASUREMENT UNCERTAINTY

2.1. Normative References

Ref.	Publication	Year	Title
(i)	FCC 47 CFR Part 15.247	2014	CFR Title 47 Part 15.247 – Radio Frequency Devices; Subpart C – Intentional Radiators
(ii)	KDB 558074 D01	June 6,2014	DTS Meas Guidance v03r02 Guidance for performing compliance measurements on Digital Transmission Systems (DTS) operating under section 15.247.
(iii)	KDB 558074 D02	June 5,2014	DTS Part 15.247 Old Rule. Guidance for performing compliance measurements on Digital Transmission Systems (DTS) operating under section 15.247.
(iv)	ANSI C63.10	2013	American National Standard for Testing Unlicensed Wireless Devices
(v)	ANSI C63.4	2014	American National Standards for Methods of Measurement of Radio-Noise Emissions from Low-Voltage Electrical and Electronic Equipment in the Range of 9 kHz to 40 GHz
(vi)	CISPR 22	2008	Information technology equipment - Radio disturbance characteristics - Limits and methods of measurement
(vii)	ICES-003	Issue 5 2012	Spectrum Management and Telecommunications; Interference-Causing Equipment Standard. Information Technology Equipment (ITE) – Limits and methods of measurement.
(viii)	RSS-210 Annex 8	2010	Radio Standards Specification 210; License-exempt Radio Apparatus (All Frequency Bands): Category I Equipment
(ix)	RSS-Gen	2014	General Requirements and Information for the Certification of Radiocommunication Equipment
(x)	FCC 47 CFR Part 2.1033	2014	FCC requirements and rules regarding photographs and
(xi)	ETSI TR 100 028	2001-12	Parts 1 and 2 Electromagnetic compatibility and Radio Spectrum Matters (ERM); Uncertainties in the measurement of mobile radio equipment characteristics
(xii)	M 3003	Edition 3 Nov. 2012	Expression of Uncertainty and Confidence in Measurements
(xiii)	A2LA	April 2014	Reference to A2LA Accreditation Status – A2LA Advertising Policy



Title: Silver Spring Networks NIC 451
To: FCC 47 CFR Part15.247 & IC RSS-210
Serial #: SSNT92-U2B Rev A
Issue Date: 27th April 2015
Page: 11 of 70

2.2. Test and Uncertainty Procedures

Conducted and radiated emission measurements were conducted in accordance with American National Standards Institute ANSI C63.4, listed in the Normative References section of this report.

Measurement uncertainty figures are calculated in accordance with ETSI TR 100 028 Parts 1 and 2.

Measurement uncertainties stated are based on a standard uncertainty multiplied by a coverage factor $k = 2$, providing a level of confidence of approximately 95 % in accordance with UKAS document M 3003 listed in the Normative References section of this report.

This test report may be reproduced in full only. The document may only be updated by MiCOM Labs personnel. Any changes will be noted in the Document History section of the report.



Title: Silver Spring Networks NIC 451
To: FCC 47 CFR Part15.247 & IC RSS-210
Serial #: SSNT92-U2B Rev A
Issue Date: 27th April 2015
Page: 12 of 70

3. PRODUCT DETAILS AND TEST CONFIGURATIONS

3.1. Technical Details

Details	Description
Purpose:	Test of the Silver Spring Networks NIC 451 to FCC Part 15.247 and Industry Canada RSS-210 regulations
Applicant:	As Manufacturer
Manufacturer:	Silver Spring Networks 555 Broadway Street Redwood City California 94063, USA
Laboratory performing the tests:	MiCOM Labs, Inc. 575 Boulder Court Pleasanton, California 94566 USA
Test report reference number:	SSNT92-U2B Rev A
Standard(s) applied:	FCC 47 CFR Part15.247 & IC RSS-210
Date EUT received:	25 th March 2015
Dates of test (from - to):	25th to 26th March 2015
No of Units Tested:	One
Type of Equipment:	Network Interface Card (NIC)
Manufacturers Trade Name:	Silver Spring Networks
Model:	NIC 451-0523-10
Location for use:	Indoor/Outdoor
Declared Frequency Range(s):	2400 - 2483.5 MHz
Type of Modulation:	2400 MHz: GFSK
Declared Nominal Output Power:	2400 - 2483.5 MHz :+30 dBm
EUT Modes of Operation:	FHSS
Transmit/Receive Operation:	Transceiver, Simplex
Rated Input Voltage:	Nominal Voltage 4 Vdc
Operating Temperature Range:	-40°C to +85°C (client declared range)
ITU Emission Designator(s):	2.4 GHz 500kbps 800 kHz BW 275KF1D
EUT Dimensions:	2.75" diameter by 0.75" high
EUT Weight :	50 grams
Primary function of equipment:	Machine to machine communication over 900 MHz and 2.4GHz FHSS.

This test report may be reproduced in full only. The document may only be updated by MiCOM Labs personnel. Any changes will be noted in the Document History section of the report.



Title: Silver Spring Networks NIC 451
To: FCC 47 CFR Part15.247 & IC RSS-210
Serial #: SSNT92-U2B Rev A
Issue Date: 27th April 2015
Page: 13 of 70

3.2. Scope of Test Program

The scope of the test program was to test the Silver Spring Networks NIC 451 (NIC 451-0523-10) in the frequency ranges 2400 – 2483.5 MHz against FCC 47 CFR Part 15.247 and Industry Canada RSS-210 specifications.

Product Description

The following product description was provided by the manufacturer.

The Silver Spring Networks NIC 451 is a network interface card (NIC) designed to fit inside existing photocell products as a retrofit to provide communication and control for street lights. The NIC 451 is designed to be integrated into LED fixtures and control nodes, and provides advanced functionality for controlling external devices such as dimmable electronic ballasts and LED fixtures. The NIC uses industry standard interfaces (such as 1-10V or DALI) to control these devices. An optional GPS chip can be added to provide accurate location and time and/or real-time clock (RTC) can be provided with backup battery/super caps to keep time, even when the NIC has lost power

This test report may be reproduced in full only. The document may only be updated by MiCOM Labs personnel. Any changes will be noted in the Document History section of the report.



3.3. Product Description

The following product model information was declared by the manufacturer.

The manufacturer declared that the variant tested in the 2400 – 2483.5 MHz range represents the worst case covering all of the available options.

Models	FCC ID	IC ID	900MHz Mesh	2.4GHz Mesh	Int Ant	Ext Ant	GPS	RTC	1-10V Dimmer
NIC 451-0101	OWS-NIC451	5975A-NIC451	X		X				
NIC 451-0102	OWS-NIC451	5975A-NIC451	X			X			
NIC 451-0103	OWS-NIC451	5975A-NIC451	X		X	X			
NIC 451-0501	OWS-NIC452	5975A-NIC452	X	X	X				
NIC 451-0502	OWS-NIC452	5975A-NIC452	X	X		X			
NIC 451-0503	OWS-NIC452	5975A-NIC452	X	X	X	X			
NIC 451-0103-03	OWS-NIC451	5975A-NIC451	X		X	X		X	
NIC 451-0103-04	OWS-NIC451	5975A-NIC451	X		X	X		X	X
NIC 451-0101-03	OWS-NIC451	5975A-NIC451	X		X			X	
NIC 451-0102-03	OWS-NIC451	5975A-NIC451	X			X		X	
NIC 451-0503-03	OWS-NIC452	5975A-NIC452	X	X	X	X		X	
NIC 451-0121-05	OWS-NIC451	5975A-NIC451	X		X		X		
NIC 451-0123-05	OWS-NIC451	5975A-NIC451	X		X	X	X		
NIC 451-0523-05	OWS-NIC452	5975A-NIC452	X	X	X	X	X		
NIC 451-0523-10	OWS-NIC452	5975A-NIC452	X	X	X	X	X	X	X



Title: Silver Spring Networks NIC 451
To: FCC 47 CFR Part15.247 & IC RSS-210
Serial #: SSNT92-U2B Rev A
Issue Date: 27th April 2015
Page: 15 of 70

3.4. Equipment Model(s) and Serial Number(s)

Type (EUT/Support)	Equipment Description (Including Brand Name)	Mfr	Model No.	Serial No.
EUT	Network Interface Card	Silver Spring Network	NIC 451-0523-10	00:13:50:07:00:00:03:CD
Support	Laptop	IBM	ThinkPad	None

3.5. Antenna Details

Antenna type (dipole, chip, etc)	Frequency Band (MHz)	Antenna Gain (dBi)	Manufacturer	Internal/External	Model No.
Omni-directional	870 - 930	1	World Products	Internal	WPANT10061-S1C
	2400 - 2500	1			
Omni-directional	860 - 960	2.5	World Products	External	WPANT30088-S1A
	2400 - 2500	4.5			

3.6. Cabling and I/O Ports

Number and type of I/O ports

1. NONE

3.7. Test Configurations

Test configurations

Frequency Band	Modulation	Data Rate / Bandwidth
2400 – 2483.5 MHz	GFSK	500 kBit/s / 800 kHz

This test report may be reproduced in full only. The document may only be updated by MiCOM Labs personnel. Any changes will be noted in the Document History section of the report.



Title: Silver Spring Networks NIC 451
To: FCC 47 CFR Part15.247 & IC RSS-210
Serial #: SSNT92-U2B Rev A
Issue Date: 27th April 2015
Page: 16 of 70

3.8. Equipment Modifications

The following modifications were required to bring the equipment into compliance:

1. NONE

3.9. Deviations from the Test Standard

The following deviations from the test standard were required in order to complete the test program:

1. NONE

This test report may be reproduced in full only. The document may only be updated by MiCOM Labs personnel. Any changes will be noted in the Document History section of the report.

4. TEST EQUIPMENT CONFIGURATION(S)

4.1. Conducted RF Emission Test Set-up

The following tests were performed using the conducted test set-up shown in the diagram below.

1. Section 6.1 20 dB and 99% Bandwidth
2. Section 6.2. Number of channels
3. Section 6.3. Channel Spacing
4. Section 6.4 Dwell Time and Channel Occupancy
5. Section 6.5 Output Power
6. Section 6.6 Conducted Emissions

Conducted Test Set-Up Pictorial Representation

Test Measurement set up

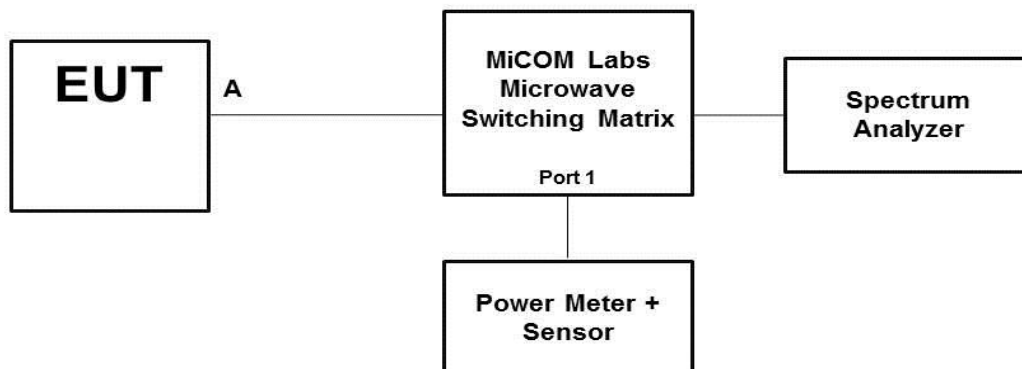

Conducted Test Measurement Setup



Title: Silver Spring Networks NIC 451
To: FCC 47 CFR Part15.247 & IC RSS-210
Serial #: SSNT92-U2B Rev A
Issue Date: 27th April 2015
Page: 18 of 70

Assets Utilized for Conducted Testing

Asset#	Description	Manufacturer	Model#	Serial#	Calibration Due Date
127	Power Supply	HP	6674A	US36370530	Cal when used
158	Barometer/Thermometer	Control Company	4196	E2846	04 Dec 2015
193	Receiver 20 Hz to 7 GHz	Rhode & Schwarz	ESI 7	838496/007	14 Jan 2016
248	Resistance Thermometer	Thermotronics	GR2105-02	9340 #1	30 Oct 2015
287	Rohde & Schwarz 40 GHz Receiver	Rhode & Schwarz	ESIB40	100201	31 Jul 2015
376	USB 10MHz - 18GHz Average Power Sensor	Agilent	U2000A	MY51440005	28 Oct 2015
378	Rohde & Schwarz 40 GHz Receiver with Generator	Rhode & Schwarz	ESIB40	100107/040	17 Jul 2015
381	4x4 RF Switch Box	MiCOM Labs	MiTest RF Switch Box	MIC002	30 Jun 2015
419	Laptop with Labview Software	Lenova	W520	TS02	Not Required
420	USB to GPIB Interface	National Instruments	GPIB-USB HS	1346738	Not Required
435	USB Wideband Power Sensor	Boonton	55006	8730	31 Jul 2015
436	USB Wideband Power Sensor	Boonton	55006	8731	31 Jul 2015
437	USB Wideband Power Sensor	Boonton	55006	8759	31 Jul 2015
445	PoE Injector	D-Link	DPE-101GL	QTAH1E2000625	Not Required
460	Dell Computer with installation of MiTest executable.	Dell	Optiplex330	BC944G1	Not Required
74	Environmental Chamber Chamber 3	Tenney	TTC	12808-1	30 Sep 2015
RF#2 GPIB#1	GPIB cable to Power Supply	HP	GPIB	None	Not Required
RF#2 SMA#1	EUT to Mitest box port 1	Flexco	SMA Cable port1	None	30 Jun 2015
RF#2 SMA#2	EUT to Mitest box port 2	Flexco	SMA Cable port2	None	30 Jun 2015
RF#2 SMA#3	EUT to Mitest box port 3	Flexco	SMA Cable port3	None	30 Jun 2015
RF#2 SMA#4	EUT to Mitest box port 3	Flexco	SMA Cable port4	None	30 Jun 2015
RF#2 SMA#SA	Mitest box to SA	Flexco	SMA Cable SA	None	30 Jun 2015
RF#2 USB#1	USB Cable to Mitest Box	Dynex	USB Cable	None	Not Required

This test report may be reproduced in full only. The document may only be updated by MiCOM Labs personnel. Any changes will be noted in the Document History section of the report.

Radiated Testing

The following tests were performed using the radiated test set-up shown in the diagram below.

- 6.7 Radiated Spurious Emissions (1 – 10 GHz)
- 6.8 Radiated Digital Emissions (0.03 – 1 GHz)

Radiated Emission Measurement Setup

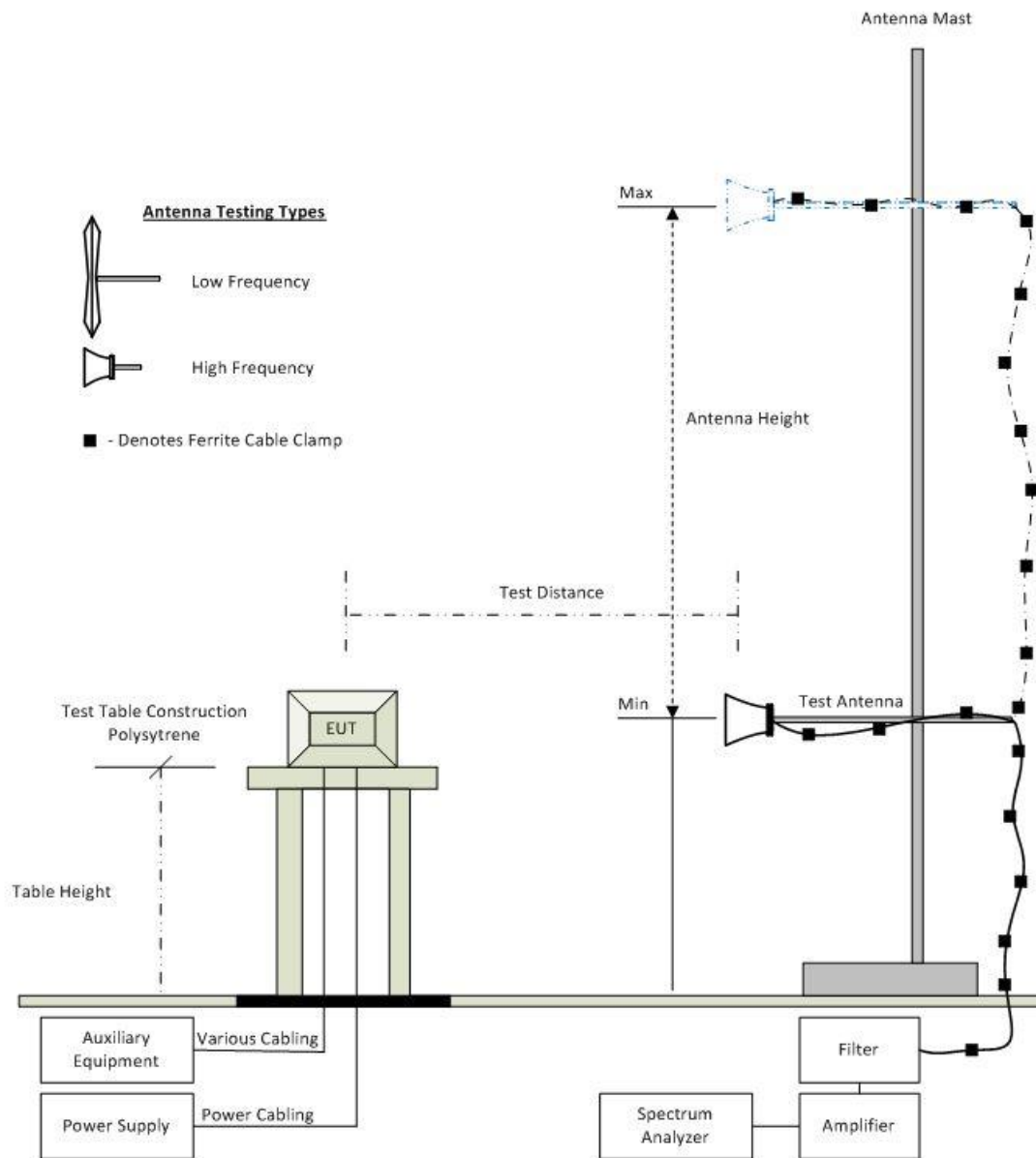

Radiated Emission Test Setup

This test report may be reproduced in full only. The document may only be updated by MiCOM Labs personnel. Any changes will be noted in the Document History section of the report.



Title: Silver Spring Networks NIC 451
To: FCC 47 CFR Part15.247 & IC RSS-210
Serial #: SSNT92-U2B Rev A
Issue Date: 27th April 2015
Page: 20 of 70

Assets Utilized for Radiated Emission Testing

Asset#	Description	Manufacturer	Model#	Serial#	Calibration Due Date
158	Barometer/Thermometer	Control Company	4196	E2846	04 Dec 2015
170	Video System Controller for Semi Anechoic Chamber	Panasonic	WV-CY101	04R08507	Not Required
287	Rohde & Schwarz 40 GHz Receiver	Rhode & Schwarz	ESIB40	100201	31 Jul 2015
301	5470 to 5725 MHz Notch Filter	Microtronics	RBC50704	001	08 Oct 2015
302	5150 to 5350 MHz Notch Filter	Microtronics	BRC50703	002	08 Oct 2015
303	5725 to 5875 MHz Notch filter	Microtronics	BRC50705	003	08 Oct 2015
310	SMA Cable	Micro-Coax	UFA210A-0-0787-3G03G0	209089-001	30 Oct 2015
338	Sunol 30 to 3000 MHz Antenna	Sunol	JB3	A052907	14 Aug 2015
342	2.4 GHz Notch Filter	EWT	EWT-14-0203	H1	08 Oct 2015
343	5.15 GHz Notch Filter	EWT	EWT-14-0200	H1	08 Oct 2015
344	5.35 GHz Notch Filter	EWT	EWT-14-0201	H1	08 Oct 2015
345	5.46 GHz Notch Filter	EWT	EWT-14-0202	H1	08 Oct 2015
377	Band Rejection Filter 5150 to 5880MHz	Microtronics	BRM50716	034	08 Oct 2015
396	2.4 GHz Notch Filter	Microtronics	BRM50701	001	07 Oct 2015
397	Amp 10 - 2500MHz	MiCOM Labs	Amp 10 - 2500 MHz	NA	23 Oct 2015
399	ETS 1-18 GHz Horn Antenna	ETS	3117	00154575	10 Oct 2015
406	Amplifier for Radiated Emissions	MiCOM Labs	40dB 1 to 18GHz Amp	0406	30 May 2015
410	Desktop Computer	Dell	Inspiron 620	WS38	Not Required
411	Mast/Turntable Controller	Sunol Sciences	SC98V	060199-1D	Not Required
412	USB to GPIB Interface	National Instruments	GPIB-USB HS	11B8DC2	Not Required
413	Mast Controller	Sunol Science	TWR95-4	030801-3	Not Required
414	DC Power Supply 0-60V	HP	6274	1029A01285	Cal when used
415	Turntable Controller	Sunol Sciences	Turntable Controller	None	Not Required
416	Gigabit ethernet filter	ETS-Lingren	Gigafoil 260366	None	Not Required
502	Test Software for Radiated Emissions	EMISoft	Vasona	Version 5 Build 59	Not Required
87	Uninterruptible Power Supply	Falcon Electric	ED2000-1/2LC	F3471 02/01	Cal when used

This test report may be reproduced in full only. The document may only be updated by MiCOM Labs personnel. Any changes will be noted in the Document History section of the report.



5. SUMMARY

List of Measurements

The following table represents the list of measurements required under the **FCC CFR47 Part 15.247**, **Industry Canada RSS-210** and **Industry Canada RSS-Gen**.

Section(s)	Test Items	Description	Condition	Result	Test Report Section
15.247(a)(1) A8.1	20 dB & 99% BW	Bandwidths	Conducted	Complies	6.1
15.247(a)(1) A8.1	Transmitter Channels	Channel Spacing	Conducted	Complies	6.3
15.247(a)(1) A8.1	Transmitter Channels	Number of Channels	Conducted	Complies	6.2
		Channel Occupancy	Conducted	Complies	6.4
15.247(b)(2) A8.4	Output Power	Transmit Power	Conducted	Complies	6.5
15.247(d) A8.5	Conducted Spurious Emissions	Band Edge	Conducted	Complies	6.6
		Spurious Emissions Transmitter (1 to 10 GHz)	Conducted	Complies	

This test report may be reproduced in full only. The document may only be updated by MiCOM Labs personnel. Any changes will be noted in the Document History section of the report.



List of Measurements

The following table represents the list of measurements required under the **FCC CFR47 Part 15.247**, **Industry Canada RSS-210** and **Industry Canada RSS-Gen**.

Section(s)	Test Items	Description	Condition	Result	Test Report Section
15.247(d) 15.205 15.209 A8.5	Radiated Emissions above 1 GHz	Transmitter	Radiated	Complies	6.7
15.247(d) 15.205 15.209 A8.5 8.9	Radiated Emissions below 1 GHz		Radiated	Complies	6.8
15.207 8.8	Conducted	AC Wireline Conducted Emissions	Conducted	Test not applicable EUT was dc powered	6.9

Note 1: Test results reported in this document relate only to the items tested

Note 2: The required tests demonstrated compliance as per client declaration of test configuration, monitoring methodology and associated pass/fail criteria

Note 3: Section 3.7 - Equipment Modifications highlights the equipment modifications that were required to bring the product into compliance with the above test matrix



6. TEST RESULTS

Device Characteristics

6.1. 20 dB & 99% Bandwidth

Conducted Test Conditions for 20 dB and 99% Bandwidth			
Standard:	FCC CFR 47:15.247	Ambient Temp. (°C):	24.0 - 27.5
Test Heading:	20 dB and 99 % Bandwidth	Rel. Humidity (%):	32 - 45
Standard Section(s):	15.247 (a)(2)	Pressure (mBars):	999 - 1001
Reference Document(s):	See Normative References		

Test Procedure for 20 dB and 99% Bandwidth Measurement
The bandwidth at 20 dB and 99 % was measured with a spectrum analyzer connected to the antenna terminal, while EUT is operating in transmission mode at the appropriate center frequency.

Testing was performed under ambient conditions at nominal voltage. Where the device operated with multiple antenna ports i.e. MIMO device, each port was measured and reported.

Test configuration and setup used for the measurement was per the Conducted Test Set-up specified in this document.

Limits for 20 dB and 99% Bandwidth

(a) Operation under the provisions of this Section is limited to frequency hopping and digitally modulated intentional radiators that comply with the following provisions:

(2) Systems using digital modulation techniques may operate in the 902-928 MHz, 2400-2483.5 MHz bands. The minimum 20 dB bandwidth shall not exceed 500 kHz.

Laboratory Measurement Uncertainty for Spectrum Measurement

Measurement uncertainty	±2.81 dB
-------------------------	----------

This test report may be reproduced in full only. The document may only be updated by MiCOM Labs personnel. Any changes will be noted in the Document History section of the report.



Title: Silver Spring Networks NIC 451
To: FCC 47 CFR Part15.247 & IC RSS-210
Serial #: SSNT92-U2B Rev A
Issue Date: 27th April 2015
Page: 24 of 70

Equipment Configuration for 20 dB & 99% Bandwidth

Variant:		Duty Cycle (%):	100
Data Rate:	500 Kbit/s	Antenna Gain (dBi):	1
Modulation:	GFSK	Beam Forming Gain (Y):	Not Applicable
TPC:	Not Applicable	Tested By:	SB
Engineering Test Notes:	Internal Antenna		

Test Measurement Results

Test Frequency	Measured 20 dB Bandwidth (MHz)				20 dB Bandwidth (MHz)		Limit	Lowest Margin
	Port(s)				Highest	Lowest		
	MHz	a	b	c			d	KHz
2400.8	0.273	--	--	--	0.273	0.273	≤500.00	-0.227
2440	0.273	--	--	--	0.273	0.273	≤500.00	-0.227
2472.8	0.275	--	--	--	0.275	0.275	≤500.00	-0.225

Test Frequency	Measured 99% Bandwidth (MHz)				Maximum 99% Bandwidth (MHz)		
	Port(s)						
	MHz	a	b	c	d		
2400.8	0.273	--	--	--	0.273		
2440	0.273	--	--	--	0.273		
2472.8	0.275	--	--	--	0.275		

Traceability to Industry Recognized Test Methodologies	
Work Instruction:	WI-03 MEASURING RF SPECTRUM MASK
Measurement Uncertainty:	±2.81 dB

Note: [click the link in the above results matrix to view the plot](#)

This test report may be reproduced in full only. The document may only be updated by MiCOM Labs personnel. Any changes will be noted in the Document History section of the report.



6.2. Number of Channels

Conducted Test Conditions for Number Of Channels			
Standard:	FCC CFR 47:15.247	Ambient Temp. (°C):	24.0 - 27.5
Test Heading:	Number of Channels	Rel. Humidity (%):	32 - 45
Standard Section(s):	15.247 (a)(2)	Pressure (mBars):	999 - 1001
Reference Document(s):	See Normative References		

Test Procedure

The number of channels and channel occupancy is measured with a spectrum analyzer connected to the antenna terminal, while the EUT is operating in transmission mode at the appropriate center frequency and modulation.

Testing was performed under ambient conditions at nominal voltage. Where the device operated with multiple antenna ports i.e. MIMO device, each port was measured and reported.

Test configuration and setup used for the measurement was per the Conducted Test Set-up specified in this document.

Limit

1) Frequency hopping systems shall have hopping channel carrier frequencies separated by a minimum of 25 kHz or the 20 dB bandwidth of the hopping channel, whichever is greater. Alternatively, frequency hopping systems operating in the 2400-2483.5 MHz band may have hopping channel carrier frequencies that are separated by 25 kHz or two-thirds of the 20 dB bandwidth of the hopping channel, whichever is greater, provided the systems operate with an output power no greater than 125 mW. The system shall hop to channel frequencies that are selected at the system hopping rate from a pseudo randomly ordered list of hopping frequencies. Each frequency must be used equally on the average by each transmitter. The system receivers shall have input bandwidths that match the hopping channel bandwidths of their corresponding transmitters and shall shift frequencies in synchronization with the transmitted signals.

(i) For frequency hopping systems operating in the 902-928 MHz band: if the 20 dB bandwidth of the hopping channel is less than 250 kHz, the system shall use at least 50 hopping frequencies and the average time of occupancy on any frequency shall not be greater than 0.4 seconds within a 20 second period; if the 20 dB bandwidth of the hopping channel is 250 kHz or greater, the system shall use at least 25 hopping frequencies and the average time of occupancy on any frequency shall not be greater than 0.4 seconds within a 10 second period. The maximum allowed 20 dB bandwidth of the hopping channel is 500 kHz.

(ii) Frequency hopping systems operating in the 5725-5850 MHz band shall use at least 75 hopping frequencies. The maximum 20 dB bandwidth of the hopping channel is 1 MHz. The average time of occupancy on any frequency shall not be greater than 0.4 seconds within a 30 second period.

(iii) Frequency hopping systems in the 2400-2483.5 MHz band shall use at least 15 channels. The average time of occupancy on any channel shall not be greater than 0.4 seconds within a period of 0.4 seconds multiplied by the number of hopping channels employed. Frequency hopping systems may avoid or suppress transmissions on a particular hopping frequency provided that a minimum of 15 channels are used.

Laboratory Uncertainty for Frequency Measurements

Measurement uncertainty	$\pm 0.86\text{ppm}$
-------------------------	----------------------

This test report may be reproduced in full only. The document may only be updated by MiCOM Labs personnel. Any changes will be noted in the Document History section of the report.



Number of Hopping Channels

Modulation	Frequency Range MHz	No. of Hopping Channels	Total Hopping Channels
GFSK 500 kBit/s	2400.8 - 2440	50	91
	2440– 2472.8	41	



Frequency Hopping Channels

Variant: 500 GFSK, Chain a, Temp: 25 C, Voltage: 4 Vdc

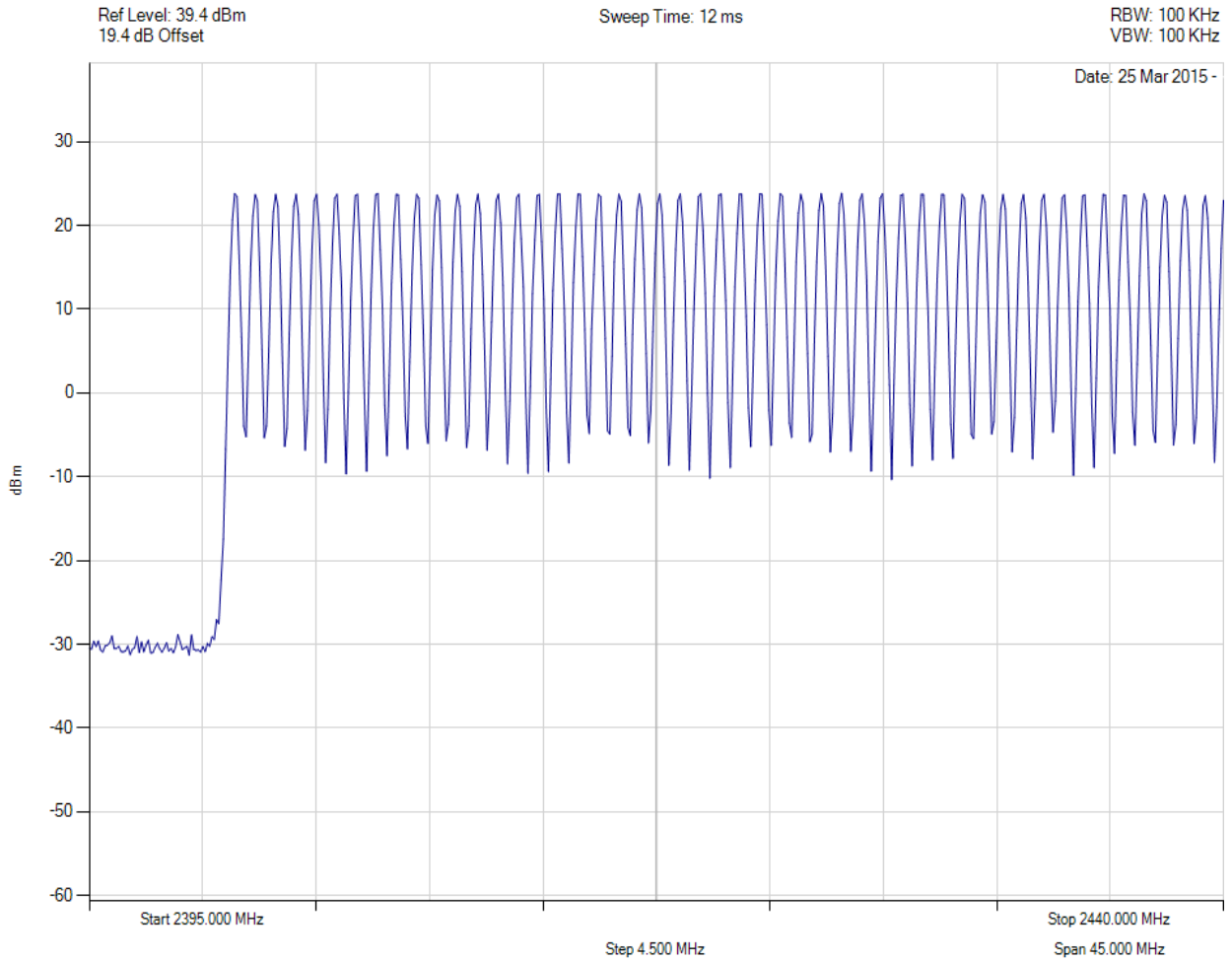

Analyser Setup	Marker:Frequency:Amplitude	Test Results
Detector = MAX PEAK Sweep Count = 0 RF Atten (dB) = 40 Trace Mode = VIEW		Channel Frequency: 0 Hz

[Back to Matrix](#)

This test report may be reproduced in full only. The document may only be updated by MiCOM Labs personnel. Any changes will be noted in the Document History section of the report.



Title: Silver Spring Networks NIC 451
To: FCC 47 CFR Part15.247 & IC RSS-210
Serial #: SSNT92-U2B Rev A
Issue Date: 27th April 2015
Page: 27 of 70



channels #2

Variant: 500 GFSK, Channel: 0 Hz, Chain a, Temp: 25 C, Voltage: 4 Vdc

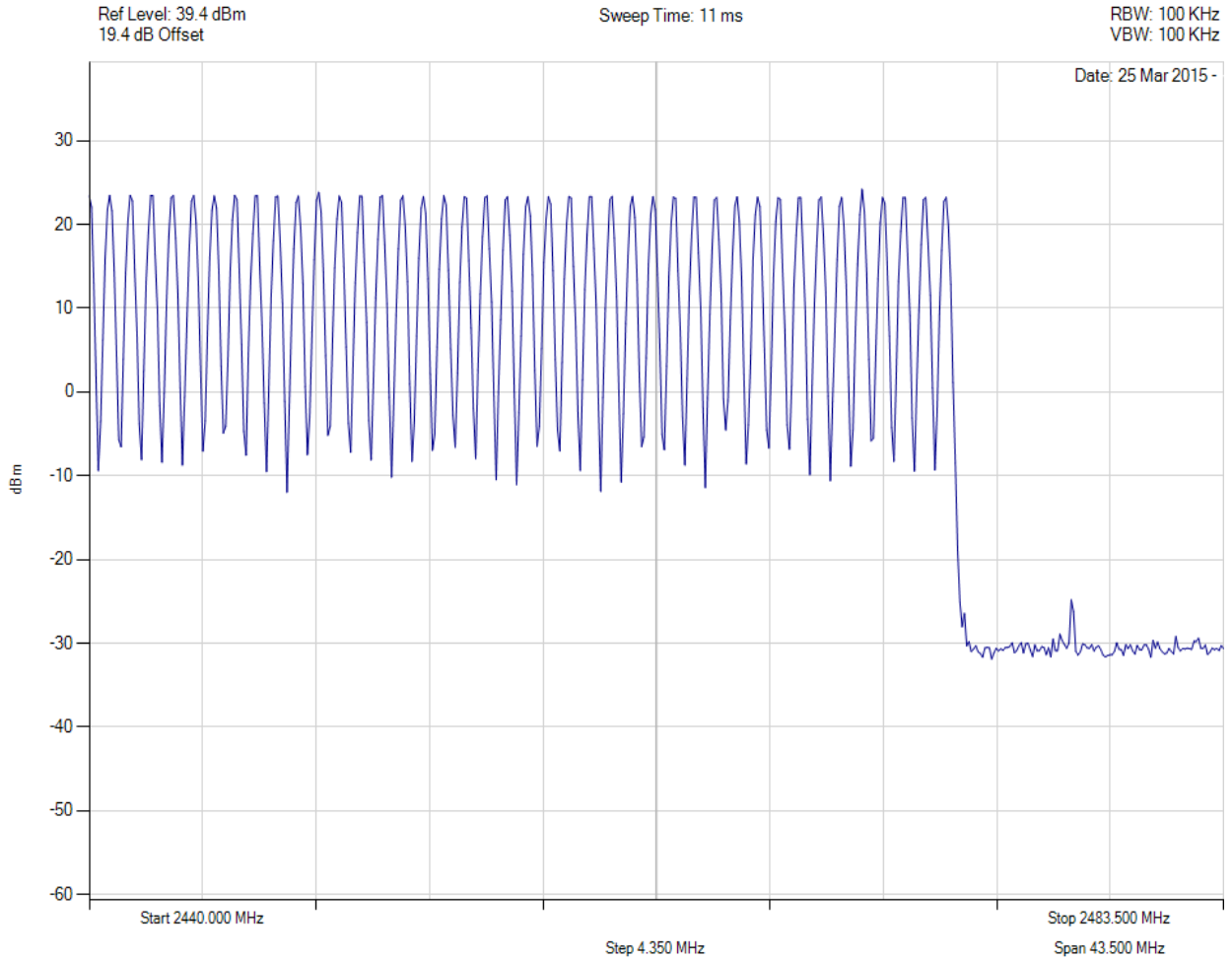

Analyser Setup	Marker:Frequency:Amplitude	Test Results
Detector = MAX PEAK Sweep Count = 0 RF Atten (dB) = 40 Trace Mode = VIEW		Channel Frequency: 0 Hz

[Back to Matrix](#)

This test report may be reproduced in full only. The document may only be updated by MiCOM Labs personnel. Any changes will be noted in the Document History section of the report.



6.3. Channel Spacing

Conducted Test Conditions for 6 dB and 99% Bandwidth			
Standard:	FCC CFR 47:15.247	Ambient Temp. (°C):	24.0 - 27.5
Test Heading:	Channel Spacing	Rel. Humidity (%):	32 - 45
Standard Section(s):	15.247 (a)(2)	Pressure (mBars):	999 - 1001
Reference Document(s):	See Normative References		
Test Procedure The number of channels and channel occupancy is measured with a spectrum analyzer connected to the antenna terminal, while the EUT is operating in transmission mode at the appropriate center frequency and modulation.			
Testing was performed under ambient conditions at nominal voltage. Where the device operated with multiple antenna ports i.e. MIMO device, each port was measured and reported.			
Test configuration and setup used for the measurement was per the Conducted Test Set-up specified in this document.			
Limit (1) Frequency hopping systems shall have hopping channel carrier frequencies separated by a minimum of 25 kHz or the 20 dB bandwidth of the hopping channel, whichever is greater. Alternatively, frequency hopping systems operating in the 2400-2483.5 MHz band may have hopping channel carrier frequencies that are separated by 25 kHz or two-thirds of the 20 dB bandwidth of the hopping channel, whichever is greater, provided the systems operate with an output power no greater than 125 mW. The system shall hop to channel frequencies that are selected at the system hopping rate from a pseudo randomly ordered list of hopping frequencies. Each frequency must be used equally on the average by each transmitter. The system receivers shall have input bandwidths that match the hopping channel bandwidths of their corresponding transmitters and shall shift frequencies in synchronization with the transmitted signals.			

Laboratory Uncertainty for Frequency Measurements

Measurement uncertainty	±0.86ppm
-------------------------	----------

This test report may be reproduced in full only. The document may only be updated by MiCOM Labs personnel. Any changes will be noted in the Document History section of the report.



Title: Silver Spring Networks NIC 451
To: FCC 47 CFR Part15.247 & IC RSS-210
Serial #: SSNT92-U2B Rev A
Issue Date: 27th April 2015
Page: 29 of 70

Modulation	Channel Spacing (kHz)	Maximum 20 dB Bandwidth (kHz)	Specification	Compliant
GFSK 500 Kbit/s	803	275	Greater than maximum 20 dB Bandwidth	√



Channel Spacing

Variant: 500 GFSK, Channel: 2472.80 MHz, Chain a, Temp: 25 C, Voltage: 4 Vdc

Ref Level: 39.4 dBm
19.4 dB Offset

Sweep Time: 76 ms

RBW: 10 KHz
VBW: 10 KHz

Date: 25 Mar 2015 -

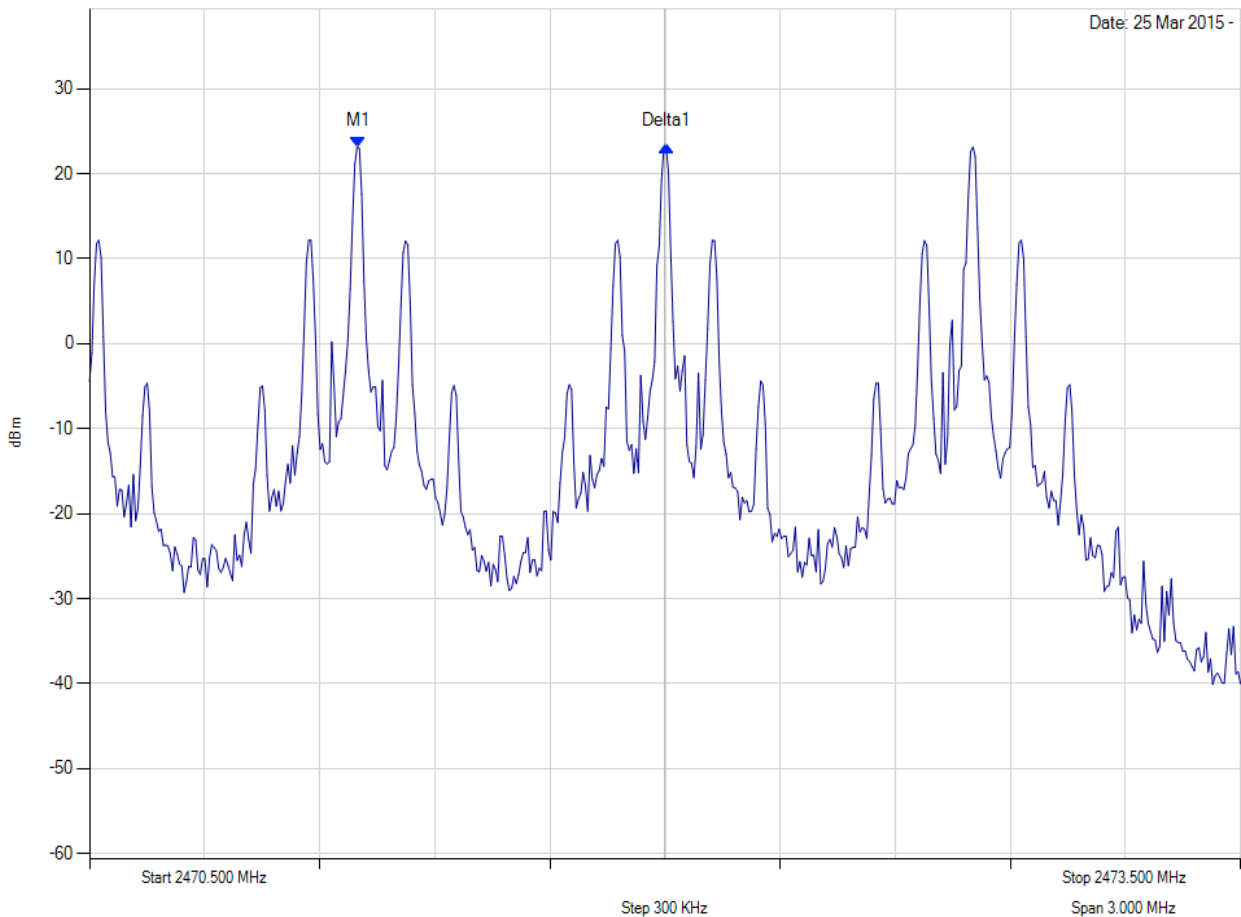

Analyser Setup	Marker:Frequency:Amplitude	Test Results
Detector = MAX PEAK Sweep Count = 0 RF Atten (dB) = 40 Trace Mode = MAX HOLD	M1 : 2471.200 MHz : 23.171 dBm Delta1 : 803 KHz : 0.014 dB	Channel Frequency: 2472.80 MHz

This test report may be reproduced in full only. The document may only be updated by MiCOM Labs personnel. Any changes will be noted in the Document History section of the report.



6.4. Dwell Time & Channel Occupancy

Conducted Test Conditions for 6 dB and 99% Bandwidth			
Standard:	FCC CFR 47:15.247	Ambient Temp. (°C):	24.0 - 27.5
Test Heading:	Dwell Time & Channel Occupancy	Rel. Humidity (%):	32 - 45
Standard Section(s):	15.247 (a)(1)	Pressure (mBars):	999 - 1001
Reference Document(s):	See Normative References		
<p>Test Procedure The number of channels and channel occupancy is measured with a spectrum analyzer connected to the antenna terminal, while the EUT is operating in transmission mode at the appropriate center frequency and modulation.</p> <p>Testing was performed under ambient conditions at nominal voltage. Where the device operated with multiple antenna ports i.e. MIMO device, each port was measured and reported.</p> <p>Test configuration and setup used for the measurement was per the Conducted Test Set-up specified in this document.</p> <p>Limits (i) For frequency hopping systems operating in the 902-928 MHz band: if the 20 dB bandwidth of the hopping channel is less than 250 kHz, the system shall use at least 50 hopping frequencies and the average time of occupancy on any frequency shall not be greater than 0.4 seconds within a 20 second period; if the 20 dB bandwidth of the hopping channel is 250 kHz or greater, the system shall use at least 25 hopping frequencies and the average time of occupancy on any frequency shall not be greater than 0.4 seconds within a 10 second period. The maximum allowed 20 dB bandwidth of the hopping channel is 500 kHz</p> <p>(ii) Frequency hopping systems operating in the 5725-5850 MHz band shall use at least 75 hopping frequencies. The maximum 20 dB bandwidth of the hopping channel is 1 MHz. The average time of occupancy on any frequency shall not be greater than 0.4 seconds within a 30 second period.</p> <p>(iii) Frequency hopping systems in the 2400-2483.5 MHz band shall use at least 15 channels. The average time of occupancy on any channel shall not be greater than 0.4 seconds within a period of 0.4 seconds multiplied by the number of hopping channels employed. Frequency hopping systems may avoid or suppress transmissions on a particular hopping frequency provided that a minimum of 15 channels are used.</p>			

Laboratory Uncertainty for Frequency Measurements

Measurement uncertainty	±0.86ppm
-------------------------	----------

This test report may be reproduced in full only. The document may only be updated by MiCOM Labs personnel. Any changes will be noted in the Document History section of the report.



Title: Silver Spring Networks NIC 451
To: FCC 47 CFR Part15.247 & IC RSS-210
Serial #: SSNT92-U2B Rev A
Issue Date: 27th April 2015
Page: 31 of 70

Modulation	Dwell Time (mS)
GFSK 500 Kbit/s	3.22



Dwell Time

Variant: 500 GFSK, Channel: 2472.80 MHz, Chain a, Temp: 25 C, Voltage: 4 Vdc

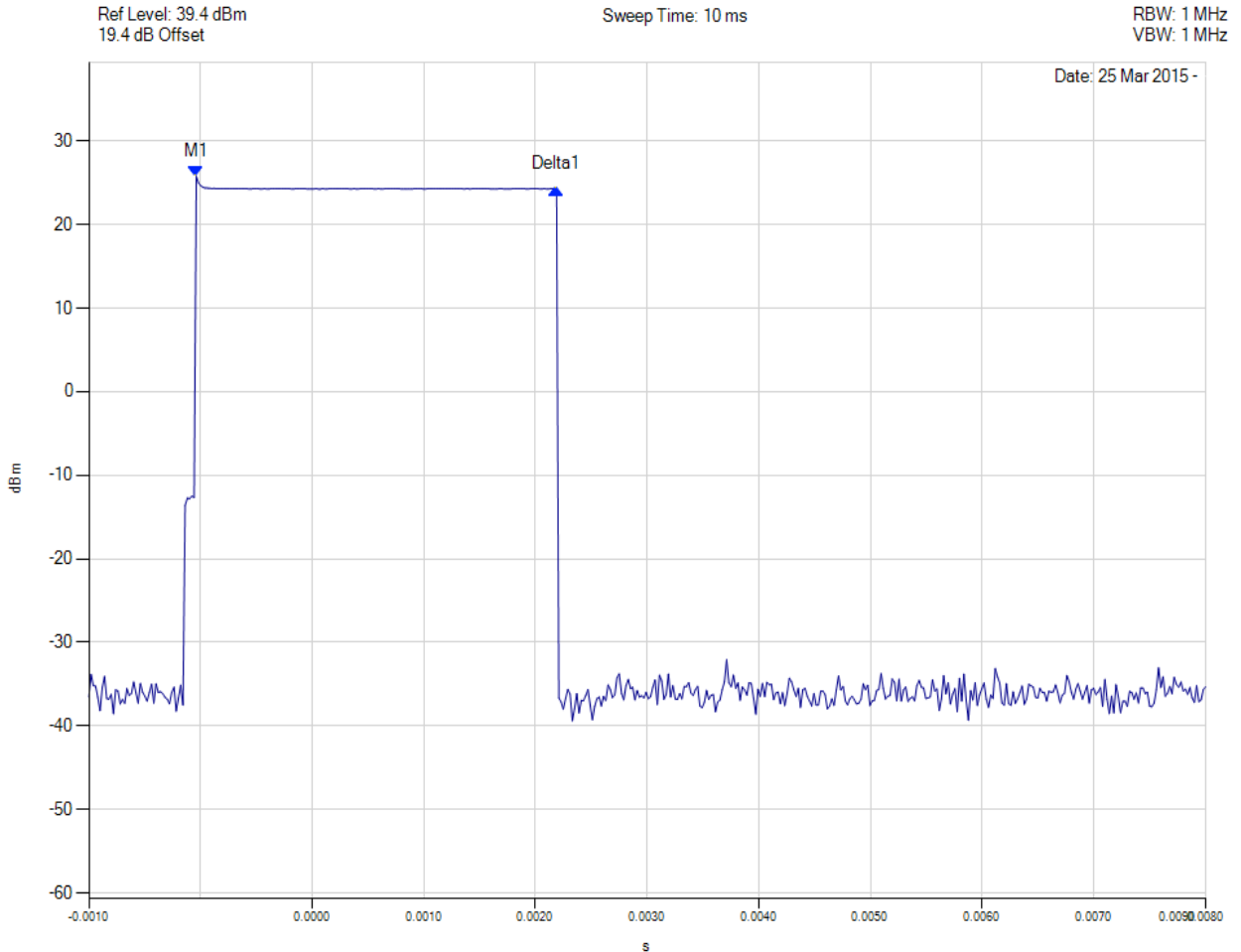

Analyser Setup	Marker:Time:Amplitude	Test Results
Detector = MAX PEAK Sweep Count = 0 RF Atten (dB) = 30 Trace Mode = CLR/WRITE	M1 : 38.076 us : 25.760 dBm Delta1 : 3.22 ms : -1.481 dB	Channel Frequency: 2472.80 MHz

[back to matrix](#)

This test report may be reproduced in full only. The document may only be updated by MiCOM Labs personnel. Any changes will be noted in the Document History section of the report.



6.4.1. Channel Occupancy

Modulation	# of Hops in 10 Secs	Dwell Time (mS)	Channel Occupancy (mS)	Limit (mS)	Compliant
GFSK 500kBit/s	40	3.22	128.8	400.0	√



Channel Occupancy

Variant: 500 GFSK, Channel: 2472.80 MHz, Chain a, Temp: 25 C, Voltage: 4 Vdc

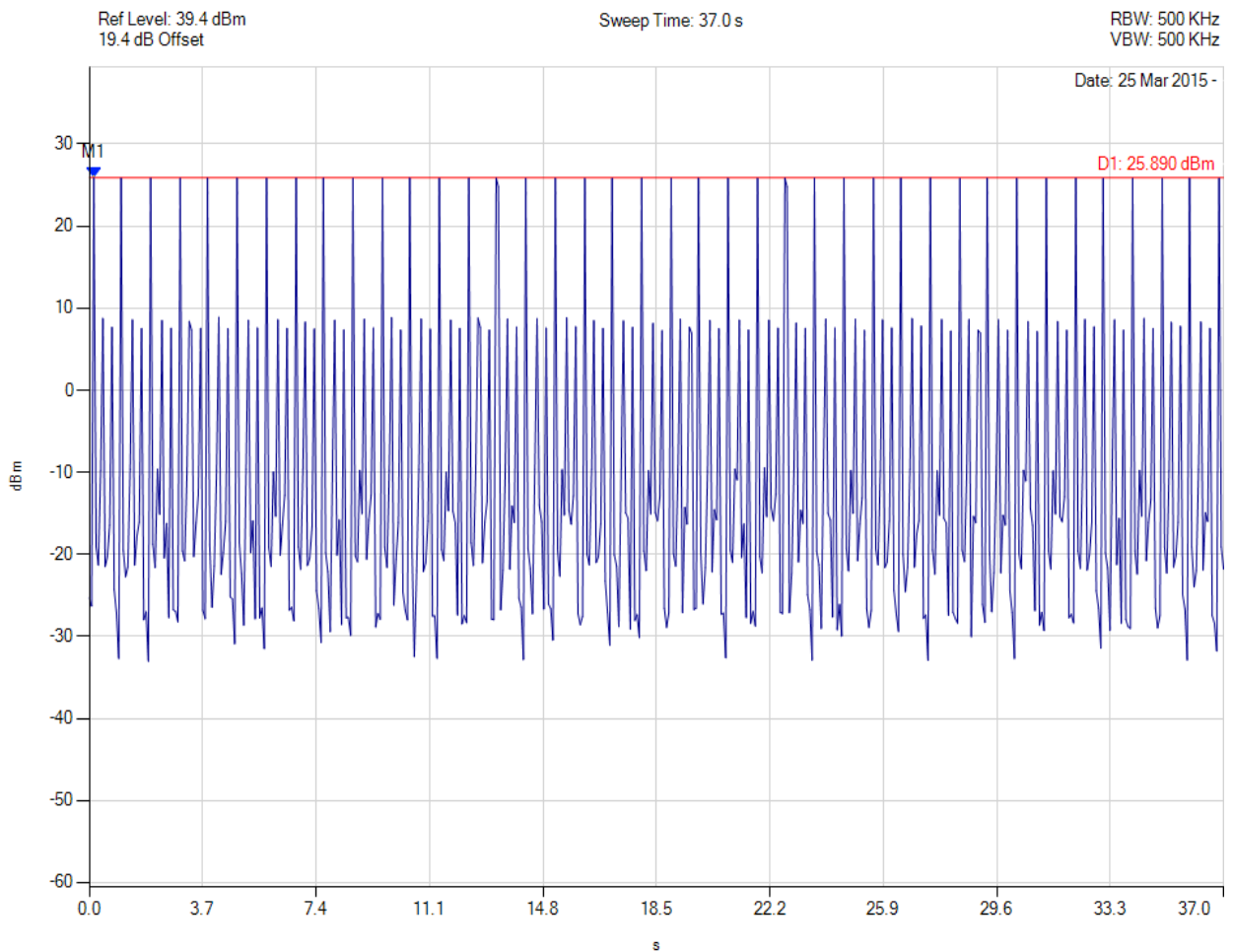

Analyser Setup	Marker:Time:Amplitude	Test Results
Detector = MAX PEAK Sweep Count = 0 RF Atten (dB) = 30 Trace Mode = CLR/WRITE	M1 : 0.148 s : 25.890 dBm	Channel Frequency: 2472.80 MHz

This test report may be reproduced in full only. The document may only be updated by MiCOM Labs personnel. Any changes will be noted in the Document History section of the report.



6.5. Output Power

Conducted Test Conditions for Fundamental Emission Output Power			
Standard:	FCC CFR 47:15.247	Ambient Temp. (°C):	24.0 - 27.5
Test Heading:	Output Power	Rel. Humidity (%):	32 - 45
Standard Section(s):	15.247 (b) & (c)	Pressure (mBars):	999 - 1001
Reference Document(s):	See Normative References		

Test Procedure for Fundamental Emission Output Power Measurement. In the case of average power measurements an average power sensor was utilized.

For peak power measurements the spectrum analyzer built-in power function was used to integrate peak power over the 20 dB bandwidth.

Testing was performed under ambient conditions at nominal voltage only.

Limits for Fundamental Emission Output Power

(b) The maximum peak conducted output power of the intentional radiator shall not exceed the following for non-frequency hopping systems:

(3) For systems using digital modulation in the 902-928 MHz, 2400-2483.5 MHz, and 5725-5850 MHz bands: 1 Watt. As an alternative to a peak power measurement, compliance with the one Watt limit can be based on a measurement of the maximum conducted output power. Maximum Conducted Output Power is defined as the total transmit power delivered to all antennas and antenna elements averaged across all symbols in the signaling alphabet when the transmitter is operating at its maximum power control level. Power must be summed across all antennas and antenna elements. The average must not include any time intervals during which the transmitter is off or is transmitting at a reduced power level. If multiple modes of operation are possible (e.g., alternative modulation methods), the maximum conducted output power is the highest total transmit power occurring in any mode.

(4) The conducted output power limit specified in paragraph (b) of this section is based on the use of antennas with directional gains that do not exceed 6 dBi. Except as shown in paragraph (c) of this section, if transmitting antennas of directional gain greater than 6 dBi are used, the conducted output power from the intentional radiator shall be reduced below the stated values in paragraphs (b)(3) of this section, as appropriate, by the amount in dB that the directional gain of the antenna exceeds 6 dBi.

(c) Operation with directional antenna gains greater than 6 dBi.

(1) Fixed point-to-point operation:

(i) Systems operating in the 2400-2483.5 MHz band that are used exclusively for fixed, point-to-point operations may employ transmitting antennas with directional gain greater than 6 dBi provided the maximum conducted output power of the intentional radiator is reduced by 1 dB for every 3 dB that the directional gain of the antenna exceeds 6 dBi.

(ii) Systems operating in the 5725-5850 MHz band that are used exclusively for fixed, point-to-point operations may employ transmitting antennas with directional gain greater than 6 dBi without any corresponding reduction in transmitter conducted output power.

(iii) Fixed, point-to-point operation, as used in paragraphs (c)(1)(i) and (c)(1)(ii) of this section, excludes the use of point-to-multipoint systems, omnidirectional applications, and multiple co-located intentional radiators transmitting the same information. The operator of the spread spectrum or digitally modulated intentional radiator or, if the equipment is professionally installed, the installer is responsible for ensuring that the system is used exclusively for fixed, point-to-point operations. The instruction manual furnished with the intentional radiator shall contain language in the installation instructions informing the operator and the installer of this responsibility.

Laboratory Measurement Uncertainty for Power Measurements

Measurement uncertainty	±1.33 dB
-------------------------	----------

This test report may be reproduced in full only. The document may only be updated by MiCOM Labs personnel. Any changes will be noted in the Document History section of the report.



Title: Silver Spring Networks NIC 451
To: FCC 47 CFR Part15.247 & IC RSS-210
Serial #: SSNT92-U2B Rev A
Issue Date: 27th April 2015
Page: 34 of 70

Antenna Model	Frequency Band	Gain (dBi)	Max. Allowable Conducted Peak Power (dBm)	Maximum EIRP (dBm)
Integral	2400-2500	1	+30.0	+29.47
External	2400-2500	4		+31.44

Equipment Configuration for Peak Output Power

Variant:	--	Duty Cycle (%):	100
Data Rate:	100kbits/s	Antenna Gain (dBi):	1
Modulation:	GFSK	Beam Forming Gain (Y):	Not Applicable
TPC:	Not Applicable	Tested By:	SB
Engineering Test Notes:	Internal Antenna		

Test Measurement Results

Test Frequency MHz	Measured Output Power (dBm)				Calculated Total Power Σ Port(s) dBm	Limit dBm	Margin dBm	EUT Power Setting
	Port(s)							
	a	b	c	d				
2400.8	26.33	--	--	--	26.33	30.00	-3.67	15.00
2440	26.01	--	--	--	26.01	30.00	-3.99	15.00
2472.8	26.15	--	--	--	26.15	30.00	-3.85	15.00

Traceability to Industry Recognized Test Methodologies

Work Instruction:	WI-01 MEASURING RF OUTPUT POWER
Measurement Uncertainty:	±.33 dB

This test report may be reproduced in full only. The document may only be updated by MiCOM Labs personnel. Any changes will be noted in the Document History section of the report.



6.6. Conducted Spurious Emissions Transmitter

Conducted Test Conditions for Transmitter Conducted Spurious and Band-Edge Emissions			
Standard:	FCC CFR 47:15.247	Ambient Temp. (°C):	24.0 - 27.5
Test Heading:	Max Unwanted Emission Levels	Rel. Humidity (%):	32 - 45
Standard Section(s):	15.247 (d)	Pressure (mBars):	999 - 1001
Reference Document(s):	See Normative References		

Test Procedure for Transmitter Conducted Spurious and Band-Edge Emissions Measurement

Transmitter Conducted Spurious and Band-Edge emissions were measured at a limit of 30 dBc (average detector) or 20 dBc (peak detector) below the highest in-band spectral density measured with a spectrum analyzer connected to the antenna terminal. Measurements were made while EUT was operating in transmit mode of operation at the appropriate centre frequency closest to the band-edge. Emissions were maximized during the measurement and limits derived from the peak spectral power and drawn on each plot.

Where the device operated with multiple antenna ports i.e. MIMO device, each port was measured separately. Testing was performed under ambient conditions at nominal voltage only.

Test configuration and setup used for the measurement was per the Conducted Test Set-up specified in this document.

Limits Transmitter Conducted Spurious and Band-Edge Emissions

(d) In any 100 kHz bandwidth outside the frequency band in which the spread spectrum or digitally modulated intentional radiator is operating, the radio frequency power that is produced by the intentional radiator shall be at least 20 dB below that in the 100 kHz bandwidth within the band that contains the highest level of the desired power, based on either an RF conducted or a radiated measurement, provided the transmitter demonstrates compliance with the peak conducted power limits. If the transmitter complies with the conducted power limits based on the use of RMS averaging over a time interval, as permitted under paragraph (b)(3) of this section, the attenuation required under this paragraph shall be 30 dB instead of 20 dB. Attenuation below the general limits specified in §15.209(a) is not required. In addition, radiated emissions which fall in the restricted bands, as defined in §15.205(a), must also comply with the radiated emission limits specified in §15.209(a) (see §15.205(c)).

Laboratory Measurement Uncertainty for Conducted Spurious Emissions

Measurement uncertainty	±2.37 dB
-------------------------	----------



Title: Silver Spring Networks NIC 451
To: FCC 47 CFR Part15.247 & IC RSS-210
Serial #: SSNT92-U2B Rev A
Issue Date: 27th April 2015
Page: 36 of 70

Equipment Configuration for Transmitter Conducted Spurious Emissions

Variant:	--	Duty Cycle (%):	100
Data Rate:	GFSK	Antenna Gain (dBi):	1
Modulation:	Not Applicable	Beam Forming Gain (Y):	Not Applicable
TPC:	500 Kbit/s	Tested By:	SB
Engineering Test Notes:	Internal Antenna		

Test Measurement Results

Test Frequency	Frequency Range	Transmitter Conducted Spurious Emissions (dBm)							
		Port a		Port b		Port c		Port d	
MHz	MHz	SE	Limit	SE	Limit	SE	Limit	SE	Limit
2400.8	30 - 26000	-30.435	8.92	--	--	--	--	--	--
2440	30 - 26000	-29.890	9.14	--	--	--	--	--	--
2472.8	30 - 26000	-30.640	9.44	--	--	--	--	--	--

Traceability to Industry Recognized Test Methodologies	
Work Instruction:	WI-05 MEASUREMENT OF SPURIOUS EMISSIONS
Measurement Uncertainty:	≤ 40 GHz ±2.37 dB, > 40 GHz ±4.6 dB

Note: [click the link in the above results matrix to view the plot](#)

This test report may be reproduced in full only. The document may only be updated by MiCOM Labs personnel. Any changes will be noted in the Document History section of the report.



Title: Silver Spring Networks NIC 451
To: FCC 47 CFR Part15.247 & IC RSS-210
Serial #: SSNT92-U2B Rev A
Issue Date: 27th April 2015
Page: 37 of 70

Equipment Configuration for Transmitter Band-Edge Emissions

Variant:	--	Duty Cycle (%):	100
Data Rate:	GFSK	Antenna Gain (dBi):	1
Modulation:	Not Applicable	Beam Forming Gain (Y):	Not Applicable
TPC:	500 Kbit/s	Tested By:	SB
Engineering Test Notes:	Internal Antenna		

Test Measurement Results

Test Frequency	Band-Edge Frequency	Transmitter Conducted Band-Edge Emissions (dBm)							
		Port a		Port b		Port c		Port d	
MHz	MHz	BE	Limit	BE	Limit	BE	Limit	BE	Limit
2400.8	2400.0	-29.78	3.34	--	--	--	--	--	--
2472.8	2483.5	-27.37	23.82	--	--	--	--	--	--

Traceability to Industry Recognized Test Methodologies	
Work Instruction:	WI-05 MEASUREMENT OF SPURIOUS EMISSIONS
Measurement Uncertainty:	≤ 40 GHz ±2.37 dB, > 40 GHz ±4.6 dB

Note: [click the link in the above results matrix to view the plot](#)

This test report may be reproduced in full only. The document may only be updated by MiCOM Labs personnel. Any changes will be noted in the Document History section of the report.



Title: Silver Spring Networks NIC 451
To: FCC 47 CFR Part15.247 & IC RSS-210
Serial #: SSNT92-U2B Rev A
Issue Date: 27th April 2015
Page: 38 of 70

6.7. Radiated Spurious Emissions > 1 GHz

Transmitter Radiated Spurious Emissions (above 1 GHz); Peak Field Strength Measurements; and Radiated Band Edge Measurements – Restricted Bands

FCC, Part 15 Subpart C §15.247(d) 15.205; 15.209

Industry Canada RSS-210 §A8.5, §2.2

Industry Canada RSS-Gen §8.10

Test Procedure

Radiated emissions above 1 GHz are measured in the anechoic chamber at a 3-meter distance on every azimuth in both horizontal and vertical polarities. The emissions are recorded and maximized as a function of azimuth by rotation through 360° with a spectrum analyzer in peak hold mode. Depending on the frequency band spanned a notch filter and waveguide filter was used to remove the fundamental frequency. The highest emissions relative to the limit are listed for each frequency spanned.

All measurements on any frequency or frequencies over 1 MHz are based on the use of measurement instrumentation employing an average detector function. All measurements above 1 GHz were performed using a minimum resolution bandwidth of 1 MHz.

This test report may be reproduced in full only. The document may only be updated by MiCOM Labs personnel. Any changes will be noted in the Document History section of the report.



Field Strength Calculation

The field strength is calculated by adding the Antenna Factor and Cable Loss, and subtracting Amplifier Gain from the measured reading. All factors are included in the reported data.

$FS = R + AF + CORR - FO$
where: FS = Field Strength
R = Measured Spectrum analyzer Input Amplitude
AF = Antenna Factor
CORR = Correction Factor = CL – AG + NFL
CL = Cable Loss
AG = Amplifier Gain
FO = Distance Falloff Factor
NFL = Notch Filter Loss or Waveguide Loss

For example:

Given receiver input reading of 51.5 dB μ V; Antenna Factor of 8.5 dB; Cable Loss of 1.3 dB; Falloff Factor of 0 dB, an Amplifier Gain of 26 dB and Notch Filter Loss of 1 dB. The Field Strength of the measured emission is:

$$FS = 51.5 + 8.5 + 1.3 - 26.0 + 1 = 36.3 \text{ dB}\mu\text{V/m}$$

Conversion between dB μ V/m (or dB μ V) and μ V/m (or μ V) are done as:

$$\text{Level (dB}\mu\text{V/m)} = 20 * \text{Log (level (\mu\text{V/m}))}$$

NOTE: KDB 662911 was implemented for Out-of-Band measurements. Where necessary Option (2) Measure and add 10 log (N) dB was implemented



Title: Silver Spring Networks NIC 451
To: FCC 47 CFR Part15.247 & IC RSS-210
Serial #: SSNT92-U2B Rev A
Issue Date: 27th April 2015
Page: 40 of 70

6.7.1. Integral Antenna - Radiated Spurious Emissions > 1GHz

Test Freq.	2400.8 MHz	Engineer	JMH
Variant	TX Spur	Temp (°C)	18
Freq. Range	1-18G	Rel. Hum.(%)	48
Power Setting	15	Press. (mBars)	1011
Ant	Internal		
Test Notes	NIC 451-0523-05, MAC: 00:13:50:07:00:00:03:CD, INT Antenna WPANT10061-S1C, GPS ON		

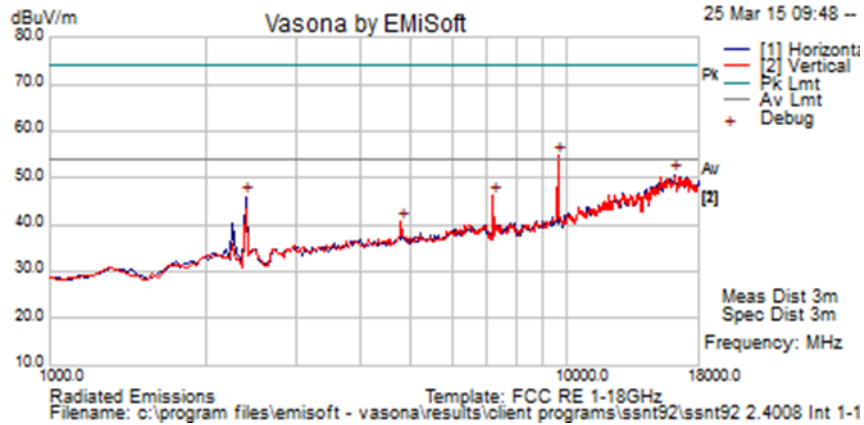

Formally measured emission peaks

Frequency MHz	Raw dBuV	Cable Loss	AF dB	Level dBuV/m	Measurement Type	Pol	Hgt cm	Azt Deg	Limit dBuV/m	Margin dB	Pass /Fail	Comments
2396.998	53.9	3.9	-11.9	46.0	Peak [Scan]	H						FUND
7201.074	46.3	7.1	-7.4	46.050	Peak [Scan]	V						NRB
4779.229	45.9	5.6	-11.1	40.4	Peak [Scan]	V	99	-1	54.0	-13.6	Pass	RB
9619.238	52.2	8.5	-6.0	54.7	Peak [Scan]	V						NRB
16160.321	37.7	12.0	1.1	50.7	Peak [Scan]	H	100	0	54	-3.3	Pass	Noise

Legend: DIG = Digital Device Emission; TX = Transmitter Emission; FUND = Fundamental Frequency
 TRNS= Transient Emission, Brbnd= Broadband emission

This test report may be reproduced in full only. The document may only be updated by MiCOM Labs personnel. Any changes will be noted in the Document History section of the report.



Title: Silver Spring Networks NIC 451
To: FCC 47 CFR Part15.247 & IC RSS-210
Serial #: SSNT92-U2B Rev A
Issue Date: 27th April 2015
Page: 41 of 70

Test Freq.	2440 MHz	Engineer	JMH
Variant	TX Spur	Temp (°C)	18
Freq. Range	1-18G	Rel. Hum.(%)	48
Power Setting	15	Press. (mBars)	1011
Ant	Internal		
Test Notes	NIC 451-0523-05, MAC: 00:13:50:07:00:00:03:CD, INT Antenna WPANT10061-S1C, GPS ON		

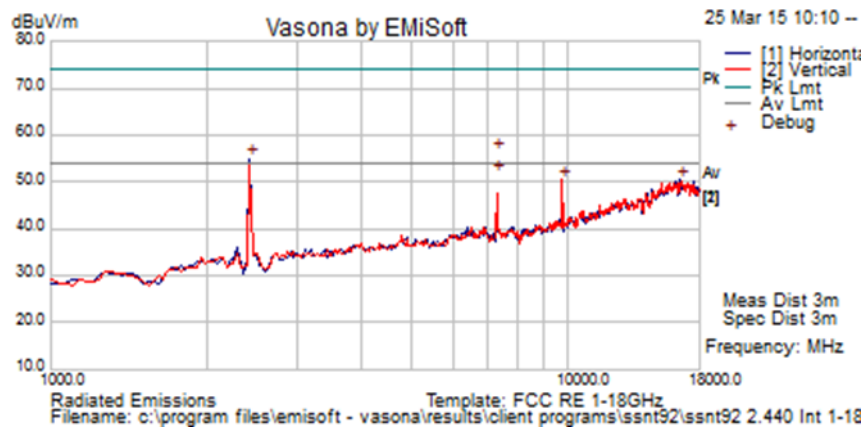

Formally measured emission peaks

Frequency MHz	Raw dBuV	Cable Loss	AF dB	Level dBuV/m	Measurement Type	Pol	Hgt cm	Azt Deg	Limit dBuV/m	Margin dB	Pass /Fail	Comments
2430.862	62.7	3.9	-11.8	54.890	Peak [Scan]	H						FUND
7320.083	56.7	7.2	-7.3	56.6	Peak Max	V	134	311	74.0	-17.4	Pass	RB
7320.083	51.9	7.2	-7.3	51.790	Average Max	V	134	311	54.0	-2.2	Pass	RB
9755.511	48.2	8.6	-6.2	50.5	Peak [Scan]	V						NRB
16535.070	36.9	11.9	1.6	50.460	Peak [Scan]	H	200	0	54.0	-3.5	Pass	Noise

Legend: DIG = Digital Device Emission; TX = Transmitter Emission; FUND = Fundamental Frequency
 TRNS= Transient Emission, Brbnd= Broadband emission

This test report may be reproduced in full only. The document may only be updated by MiCOM Labs personnel. Any changes will be noted in the Document History section of the report.



Title: Silver Spring Networks NIC 451
To: FCC 47 CFR Part15.247 & IC RSS-210
Serial #: SSNT92-U2B Rev A
Issue Date: 27th April 2015
Page: 42 of 70

Test Freq.	2472.8 MHz	Engineer	JMH
Variants	TX Spur	Temp (°C)	18
Freq. Range	1-18G	Rel. Hum.(%)	48
Power Setting	15	Press. (mBars)	1011
Ant	Internal		
Test Notes	NIC 451-0523-05, MAC: 00:13:50:07:00:00:03:CD, INT Antenna WPANT10061-S1C, GPS ON		

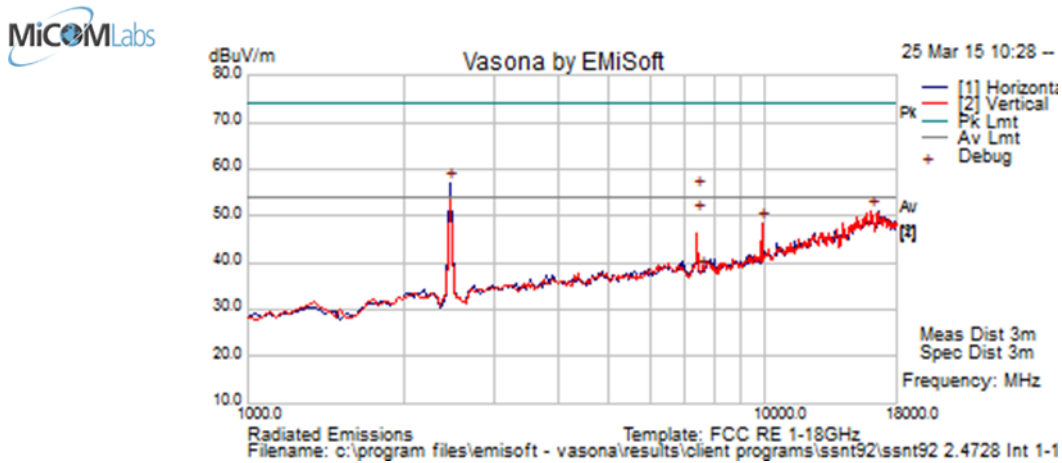

Formally measured emission peaks

Frequency MHz	Raw dBuV	Cable Loss	AF dB	Level dBuV/m	Measurement Type	Pol	Hgt cm	Azt Deg	Limit dBuV/m	Margin dB	Pass /Fail	Comments
2464.930	64.8	4.0	-11.7	57.110	Peak [Scan]							FUND
7418.420	55.5	7.3	-7.1	55.7	Peak Max	V	122	314	74.0	-18.3	Pass	NRB
7418.420	50.4	7.3	-7.1	50.6	Average Max	V	122	314	54.0	-3.4	Pass	NRB
9891.784	45.6	8.6	-5.7	48.5	Peak [Scan]	V						NRB
16058.116	38.3	11.9	0.8	51.1	Peak [Scan]	V	200	0	54.0	-2.9	Pass	Noise

Legend: DIG = Digital Device Emission; TX = Transmitter Emission; FUND = Fundamental Frequency
 TRNS= Transient Emission, Brbnd= Broadband emission

This test report may be reproduced in full only. The document may only be updated by MiCOM Labs personnel. Any changes will be noted in the Document History section of the report.



Band-Edge – Integral Antenna Peak Limit 74.0 dBµV/m, Average Limit 54.0 dBµV/m

2.4 GHz Frequency Band

Operational Mode	2390 MHz			2483.5 MHz		
	dBµV		Power Setting	dBµV		Power Setting
	Peak	Average		Peak	Average	
GFSK	53.48	43.26	15.0	60.05	47.26	15.0

This test report may be reproduced in full only. The document may only be updated by MiCOM Labs personnel. Any changes will be noted in the Document History section of the report.



Integral Antenna - Radiated Band-Edge @ 2390 MHz

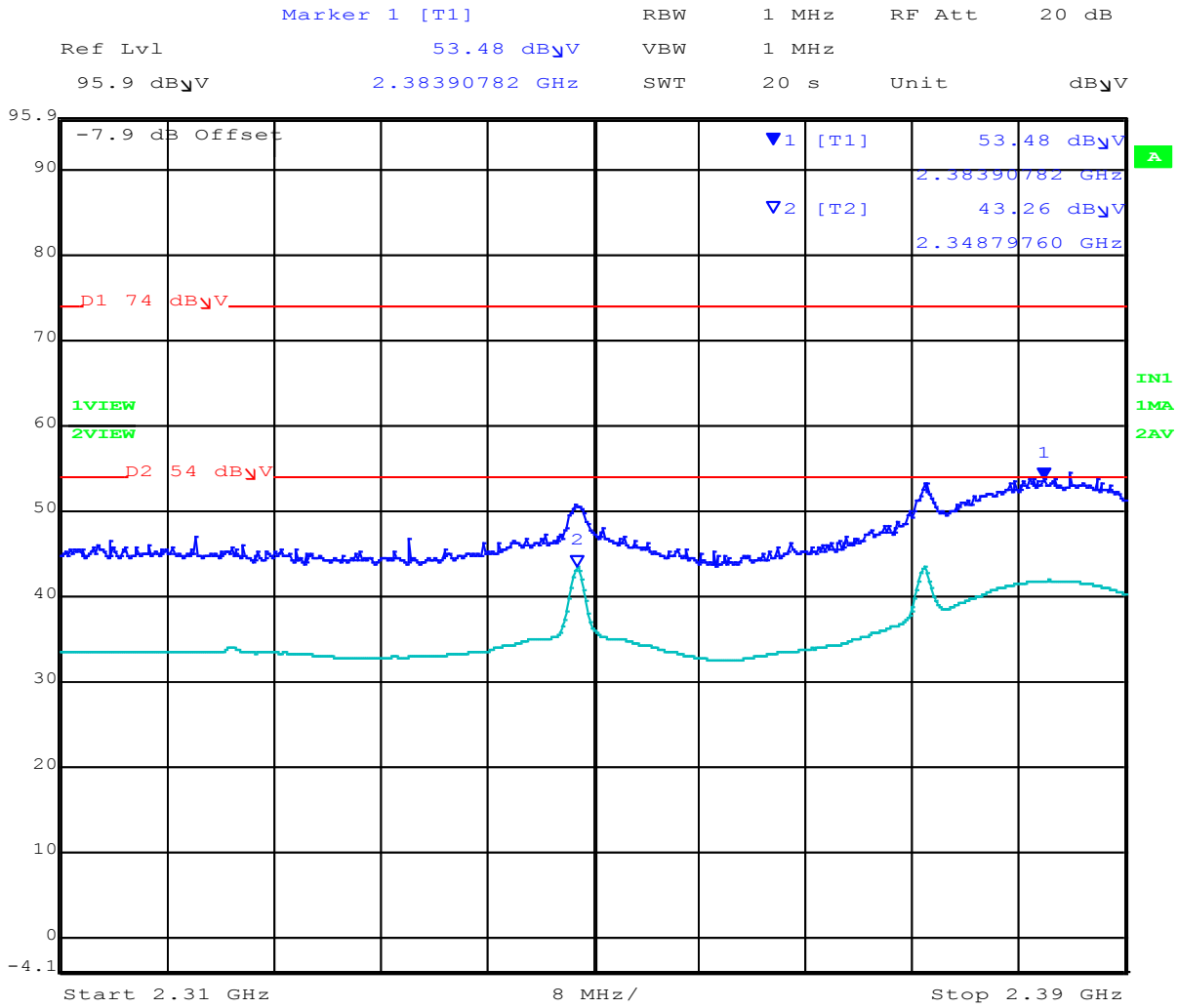

Date: 25.MAR.2015 11:03:36

This test report may be reproduced in full only. The document may only be updated by MiCOM Labs personnel. Any changes will be noted in the Document History section of the report.



Integral Antenna - Radiated Band-Edge @ 2483.5 MHz

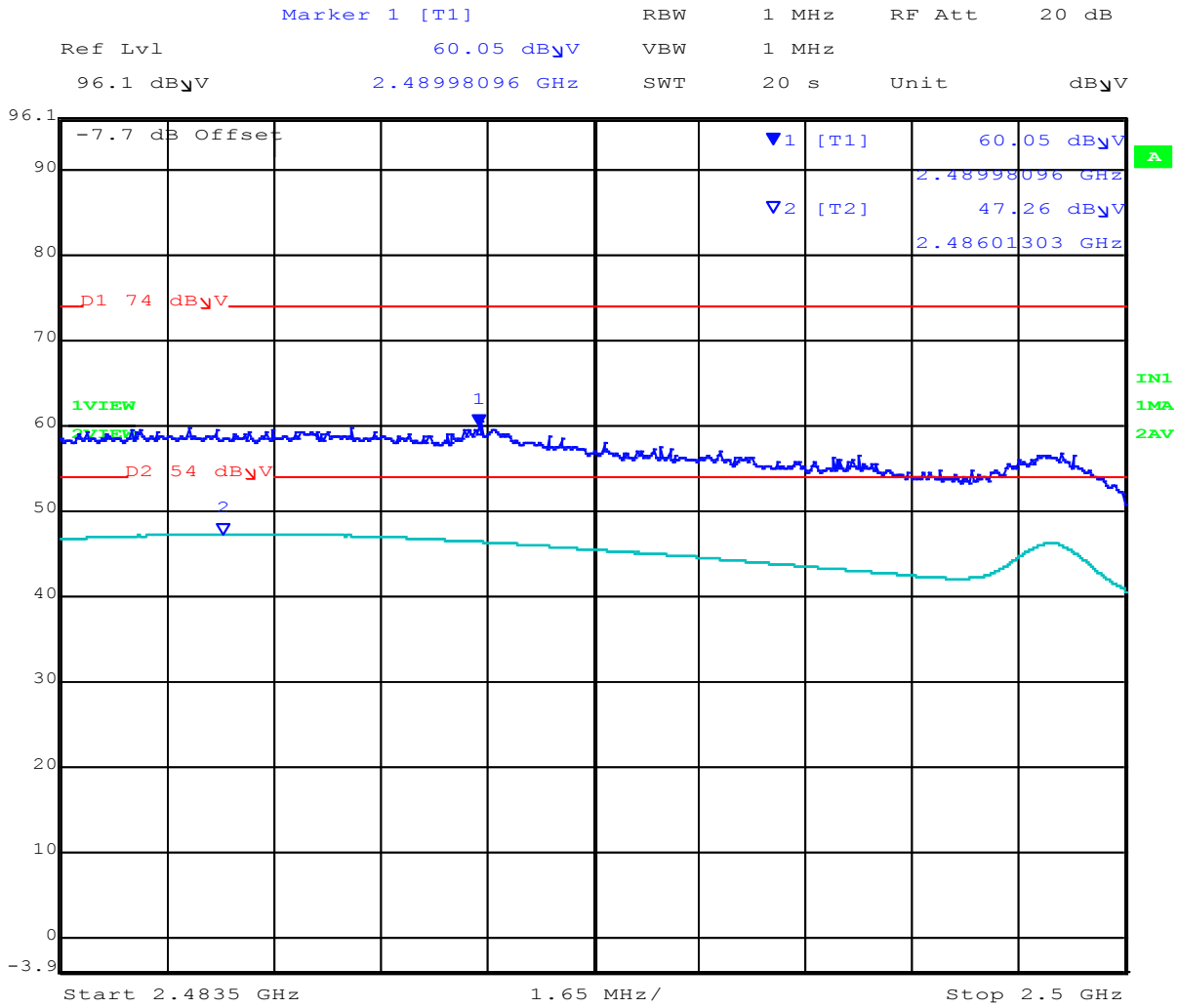

Date: 25.MAR.2015 11:15:21

This test report may be reproduced in full only. The document may only be updated by MiCOM Labs personnel. Any changes will be noted in the Document History section of the report.



Title: Silver Spring Networks NIC 451
To: FCC 47 CFR Part15.247 & IC RSS-210
Serial #: SSNT92-U2B Rev A
Issue Date: 27th April 2015
Page: 46 of 70

6.7.2. External Antenna - Radiated Spurious Emissions

Test Freq.	2400.8 MHz	Engineer	JMH
Variant	TX Spur	Temp (°C)	18
Freq. Range	1-18G	Rel. Hum.(%)	43
Power Setting	15	Press. (mBars)	1005
Ant	External		
Test Notes	NIC 451-0523-05, MAC: 00:13:50:07:00:00:03:CD, EXT Antenna WPANT30088-S1A, GPS ON		

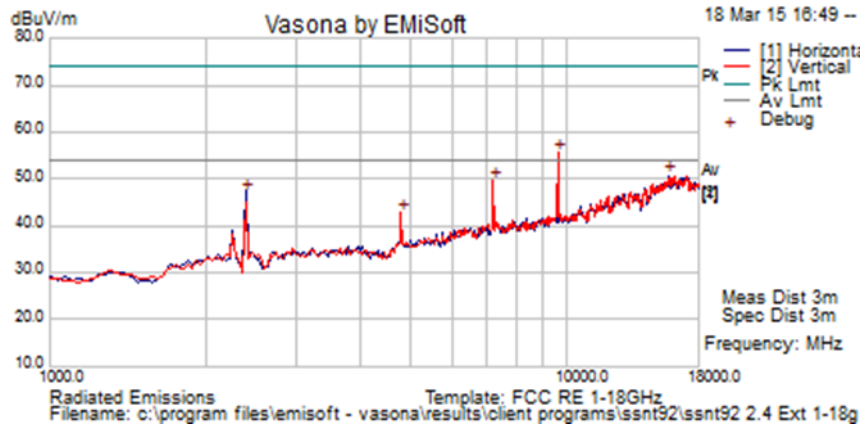

Formally measured emission peaks

Frequency MHz	Raw dBuV	Cable Loss	AF dB	Level dBuV/m	Measurement Type	Pol	Hgt cm	Azt Deg	Limit dBuV/m	Margin dB	Pass /Fail	Comments
2396.079	55.0	3.9	-11.9	47.0	Peak [Scan]	V						FUND
9619.238	53.2	8.5	-6.0	55.650	Peak [Scan]	V						NRB
15751.503	38.8	11.7	0.2	50.7	Peak [Scan]	H	150	0	54.0	-3.4	Pass	Noise
7200.401	49.9	7.1	-7.4	49.7	Peak [Scan]	V						NRB
4782.214	48.3	5.6	-11.1	42.8	Peak [Scan]	V	99	-1	54	-11.2	Pass	RB

Legend: DIG = Digital Device Emission; TX = Transmitter Emission; FUND = Fundamental Frequency
 TRNS= Transient Emission, Brbnd= Broadband emission

This test report may be reproduced in full only. The document may only be updated by MiCOM Labs personnel. Any changes will be noted in the Document History section of the report.



Title: Silver Spring Networks NIC 451
To: FCC 47 CFR Part15.247 & IC RSS-210
Serial #: SSNT92-U2B Rev A
Issue Date: 27th April 2015
Page: 47 of 70

Test Freq.	2440 MHz	Engineer	JMH
Variants	TX Spur	Temp (°C)	18
Freq. Range	1-18G	Rel. Hum.(%)	48
Power Setting	15	Press. (mBars)	1011
Ant	External		
Test Notes	NIC 451-0523-05, MAC: 00:13:50:07:00:03:CD, EXT Antenna WPANT30088-S1A, GPS ON		

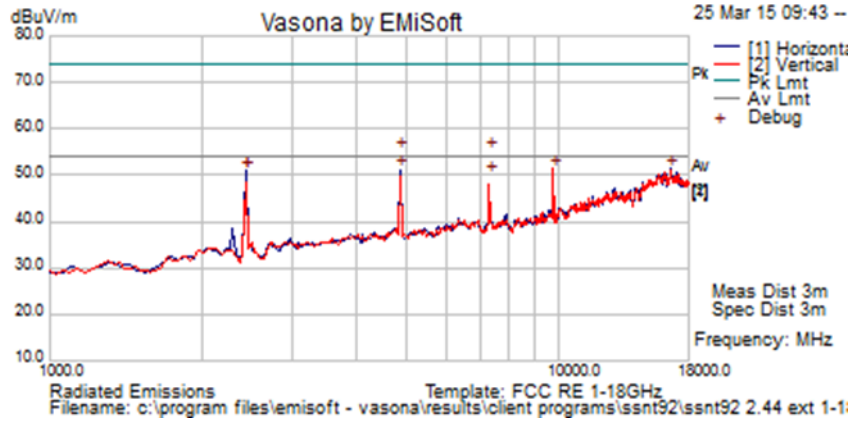

Formally measured emission peaks

Frequency MHz	Raw dBuV	Cable Loss	AF dB	Level dBuV/m	Measurement Type	Pol	Hgt cm	Azt Deg	Limit dBuV/m	Margin dB	Pass /Fail	Comments
2430.862	58.8	3.9	-11.8	50.960	Peak [Scan]							Fund
4880.110	60.8	5.7	-11.3	55.3	Peak Max	H	111	138	74.0	-18.7	Pass	RB
4880.110	57.0	5.7	-11.3	51.4	Average Max	H	111	138	54.0	-2.6	Pass	RB
7320.039	50.0	7.2	-7.3	49.9	Average Max	V	99	307	54.0	-4.1	Pass	RB
7320.039	55.4	7.2	-7.3	55.4	Peak Max	V	99	307	74.0	-18.6	Pass	RB
9755.511	49.1	8.6	-6.2	51.4	Peak [Scan]	V						NRB
16535.070	37.8	11.9	1.6	51.3	Peak [Scan]	H	150	0	54.0	-2.7	Pass	Noise

Legend: DIG = Digital Device Emission; TX = Transmitter Emission; FUND = Fundamental Frequency
 TRNS= Transient Emission, Brbnd= Broadband emission

This test report may be reproduced in full only. The document may only be updated by MiCOM Labs personnel. Any changes will be noted in the Document History section of the report.



Title: Silver Spring Networks NIC 451
To: FCC 47 CFR Part15.247 & IC RSS-210
Serial #: SSNT92-U2B Rev A
Issue Date: 27th April 2015
Page: 48 of 70

Test Freq.	2472.8 MHz	Engineer	JMH
Variant	TX Spur	Temp (°C)	18
Freq. Range	1-18G	Rel. Hum.(%)	43
Power Setting	15	Press. (mBars)	1005
Ant	External		
Test Notes	NIC 451-0523-05, MAC: 00:13:50:07:00:00:03:CD, EXT Antenna WPANT30088-S1A, GPS ON		

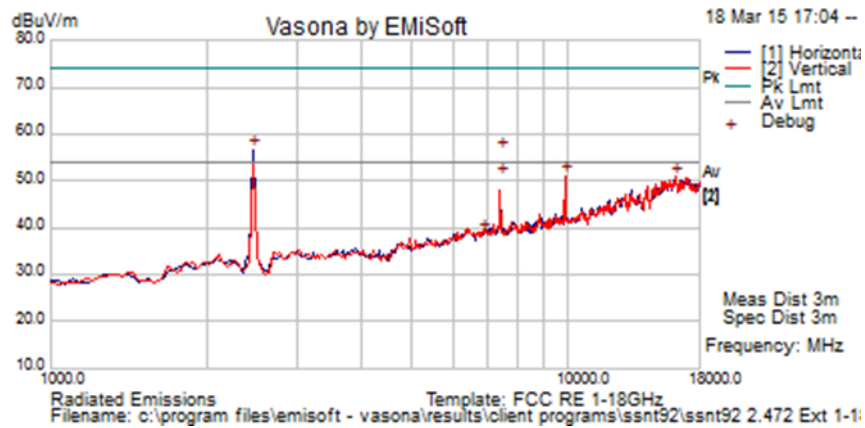

Formally measured emission peaks

Frequency MHz	Raw dBuV	Cable Loss	AF dB	Level dBuV/m	Measurement Type	Pol	Hgt cm	Azt Deg	Limit dBuV/m	Margin dB	Pass /Fail	Comments
2464.930	64.4	4.0	-11.7	56.740	Peak [Scan]	H						FUND
7418.424	56.2	7.3	-7.1	56.4	Peak Max	V	118	123	74.0	-17.6	Pass	RB
7418.424	50.5	7.3	-7.1	50.670	Average Max	V	118	123	54.0	-3.3	Pass	RB
9891.784	48.2	8.6	-5.7	51.1	Peak [Scan]	V						NRB
16160.321	37.9	12.0	1.1	50.960	Peak [Scan]	V	200	0	54.0	-3.0	Pass	Noise

Legend: DIG = Digital Device Emission; TX = Transmitter Emission; FUND = Fundamental Frequency
 TRNS= Transient Emission, Brbnd= Broadband emission

This test report may be reproduced in full only. The document may only be updated by MiCOM Labs personnel. Any changes will be noted in the Document History section of the report.



Band-Edge – External Antenna Peak Limit 74.0 dB μ V/m, Average Limit 54.0 dB μ V/m

2.4 GHz Frequency Band

Operational Mode	2390 MHz			2483.5 MHz		
	dB μ V		Power Setting	dB μ V		Power Setting
	Peak	Average		Peak	Average	
GFSK	52.24	41.77	15.0	55.56	43.70	15.0

This test report may be reproduced in full only. The document may only be updated by MiCOM Labs personnel. Any changes will be noted in the Document History section of the report.



External Antenna - Radiated Band-Edge @ 2390 MHz

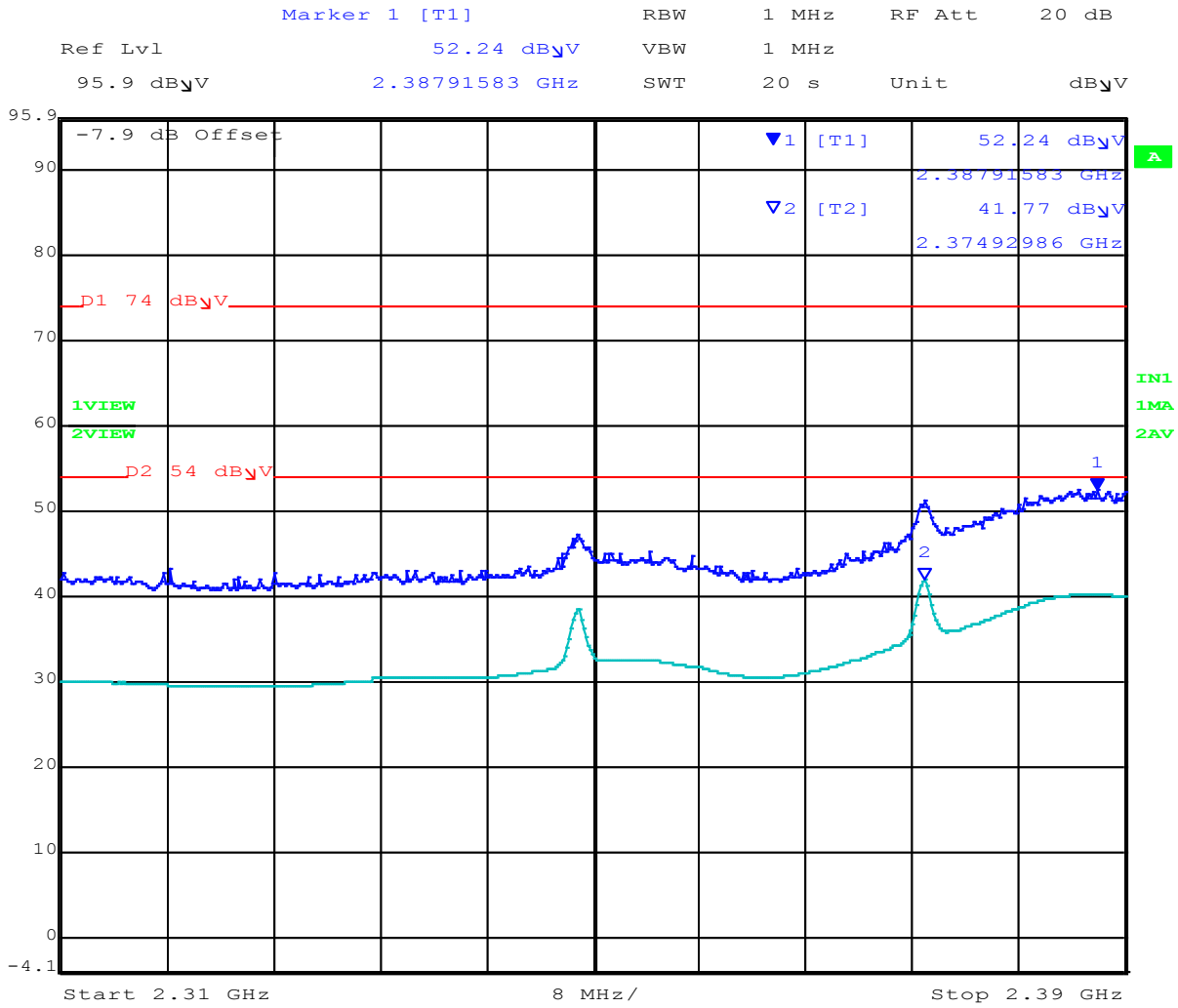

Date: 25.MAR.2015 11:35:45

This test report may be reproduced in full only. The document may only be updated by MiCOM Labs personnel. Any changes will be noted in the Document History section of the report.



External Antenna - Radiated Band-Edge @ 2483.5 MHz

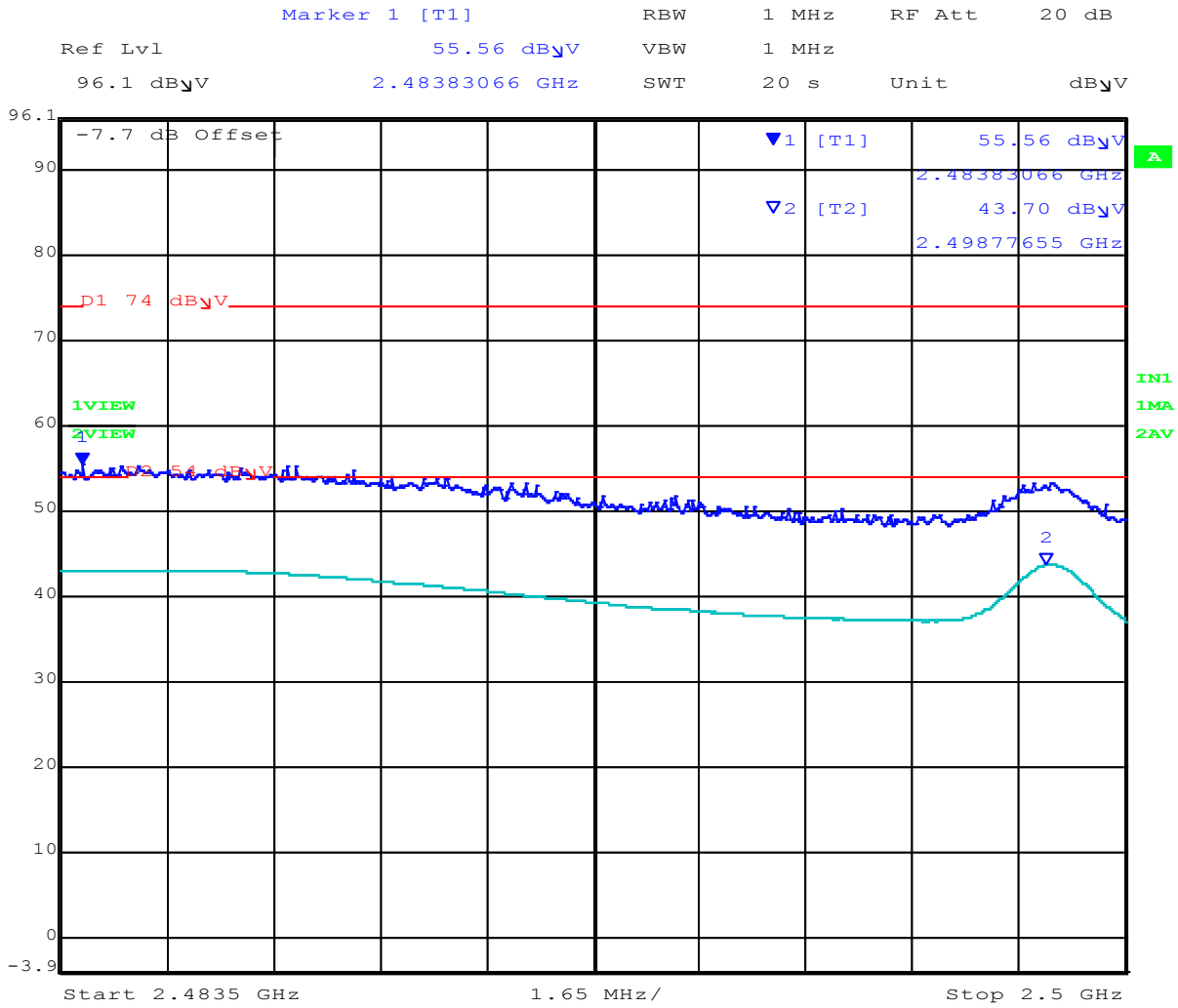

Date: 25.MAR.2015 11:23:40

This test report may be reproduced in full only. The document may only be updated by MiCOM Labs personnel. Any changes will be noted in the Document History section of the report.



Title: Silver Spring Networks NIC 451
To: FCC 47 CFR Part15.247 & IC RSS-210
Serial #: SSNT92-U2B Rev A
Issue Date: 27th April 2015
Page: 52 of 70

Specification

Limits

FCC Part 15 Subpart C §15.247(d)

Industry Canada §A8.5

In any 100 kHz bandwidth outside the frequency band in which the spread spectrum or digitally modulated intentional radiator is operating, the radio frequency power that is produced by the intentional radiator shall be at least 20 dB below that in the 100 kHz bandwidth within the band that contains the highest level of the desired power, based on either an RF conducted or a radiated measurement, provided the transmitter demonstrates compliance with the peak conducted power limits.

Laboratory Measurement Uncertainty for Radiated Emissions

Measurement uncertainty	+5.6/ -4.5 dB
-------------------------	---------------

Traceability

Method	Test Equipment Used
Measurements were made per work instruction WI-03 'Measurement of Radiated Emissions'	0287, 0335, 0338, 0158, 0134, 0304, 0311, 0315, 0310, 0312

This test report may be reproduced in full only. The document may only be updated by MiCOM Labs personnel. Any changes will be noted in the Document History section of the report.



6.8. Radiated Emissions – Digital Emissions (0.03-1 GHz)

FCC, Part 15 Subpart C §15.205/ §15.209
Industry Canada RSS-Gen §8.9

Test Procedure

Testing 30M-1 GHz was performed in a 3-meter anechoic chamber using a CISPR compliant receiver. Preliminary radiated emissions were measured on every azimuth and with the receiving antenna in both horizontal and vertical polarizations. To further maximize emissions the receive antenna was varied between 1 and 4 meters. The emissions are recorded with receiver in peak hold mode. Emissions closest to the limits are measured in the quasi-peak mode with the tuned receiver using a bandwidth of 120 kHz. Only the highest emissions relative to the limit are listed. The anechoic chamber test set-up is identified in Section 6 Test Set-Up Photographs.

The EUT had two methods of powering on ac/dc converter and Power over Ethernet (POE). Both modes were tested for emissions below 1GHz.

Field Strength Calculation

The field strength is calculated by adding the Antenna Factor and Cable Loss, and subtracting Amplifier Gain from the measured reading. In this test facility, the Antenna Factor, Cable Loss, and Amplifier Gains are loaded into the Rohde & Schwarz Receiver and the corrected field strength can be read directly on the receiver.

where:

$$FS = R + AF + CORR$$

FS = Field Strength
R = Measured Receiver Input Amplitude
AF = Antenna Factor
CORR = Correction Factor = CL – AG + NFL
CL = Cable Loss
AG = Amplifier Gain

For example:

Given a Receiver input reading of 51.5dB μ V; Antenna Factor of 8.5dB; Cable Loss of 1.3dB; Falloff Factor of 0dB, an Amplifier Gain of 26dB and Notch Filter Loss of 1dB. The Field Strength of the measured emission is:

$$FS = 51.5 + 8.5 + 1.3 - 26.0 + 1 = 36.3\text{dB}\mu\text{V/m}$$

Conversion between dB μ V/m (or dB μ V) and μ V/m (or μ V) are done as:

$$\text{Level (dB}\mu\text{V/m)} = 20 * \text{Log (level (\mu\text{V/m}))}$$

$$40 \text{ dB}\mu\text{V/m} = 100\mu\text{V/m}$$

This test report may be reproduced in full only. The document may only be updated by MiCOM Labs personnel. Any changes will be noted in the Document History section of the report.



6.8.1. Radiated Digital Emissions

Integral Antenna - Radiated Spurious Emissions

GPS turned on

EUT	NIC 451-0523-10	Engineer	JMH
Variant	Digital Emissions	Temp (°C)	18
Freq. Range	30 MHz - 1000 MHz	Rel. Hum.(%)	43
Standard Limit	FCC Class B	Press. (mBars)	1005
Support Equip	None		
Test Notes	MAC: 00:13:50:07:00:00:03:CD, INT Antenna WPANT10061-S1C, GPS ON		

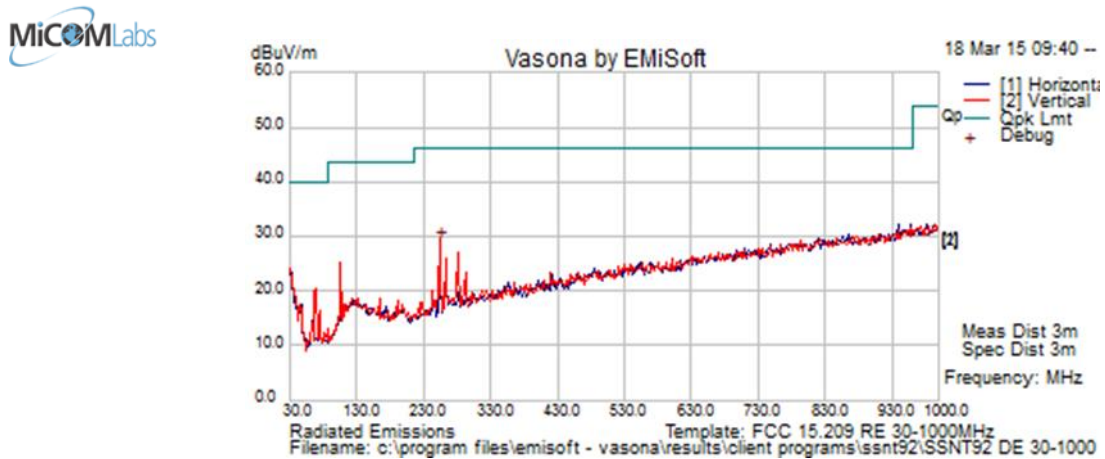

Formally measured emission peaks

Frequency MHz	Raw dBuV	Cable Loss	AF dB	Level dBuV/m	Measurement Type	PoI	Hgt cm	Azt Deg	Limit dBuV/m	Margin dB	Pass /Fail	Comments
253.771	43.4	4.5	-19.0	28.9	Peak [Scan]	V	99	-1	46	-17.1	Pass	
Legend: DIG = Digital Device Emission; TX = Transmitter Emission; FUND = Fundamental Frequency TRNS= Transient Emission, Brbnd= Broadband emission												

NOTE: The emission breaking the limit line is the fundamental frequency. A notch filter was used to attenuate the fundamental frequency

This test report may be reproduced in full only. The document may only be updated by MiCOM Labs personnel. Any changes will be noted in the Document History section of the report.



Title: Silver Spring Networks NIC 451
To: FCC 47 CFR Part15.247 & IC RSS-210
Serial #: SSNT92-U2B Rev A
Issue Date: 27th April 2015
Page: 55 of 70

Integral Antenna - Radiated Spurious Emissions

RTC turned on

RTC – real time clock

EUT	NIC 451-0503-10	Engineer	JMH
Variant	Digital Emissions	Temp (°C)	20
Freq. Range	30 MHz - 1000 MHz	Rel. Hum.(%)	42
Standard Limit	FCC Class B	Press. (mBars)	1011
Support Equip	None		
Test Notes	MAC: 00:13:50:07:00:00:03:CD, INT Antenna WPANT10061-S1C, RTC ON		

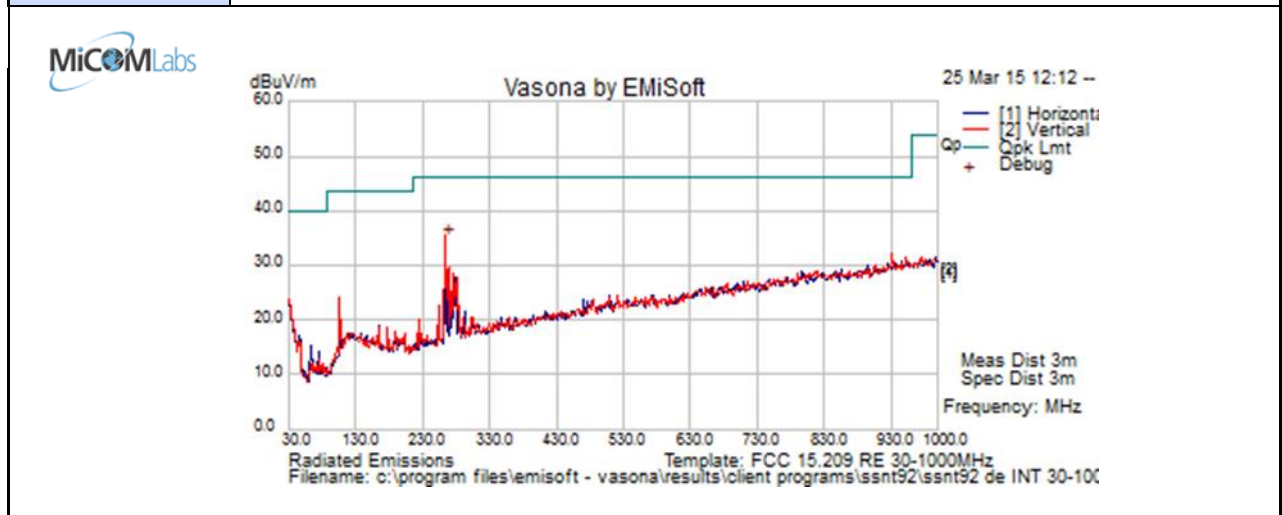

Formally measured emission peaks

Frequency MHz	Raw dBuV	Cable Loss	AF dB	Level dBuV/m	Measurement Type	Pol	Hgt cm	Azt Deg	Limit dBuV/m	Margin dB	Pass /Fail	Comments
265.256	48.2	4.6	-17.7	35.100	Peak [Scan]	V	98	361	46.0	-10.9	Pass	

Legend:	DIG = Digital Device Emission; TX = Transmitter Emission; FUND = Fundamental Frequency
	TRNS= Transient Emission, Brbnd= Broadband emission

NOTE: The emission breaking the limit line is the fundamental frequency. A notch filter was used to attenuate the fundamental frequency

This test report may be reproduced in full only. The document may only be updated by MiCOM Labs personnel. Any changes will be noted in the Document History section of the report.



Title: Silver Spring Networks NIC 451
To: FCC 47 CFR Part15.247 & IC RSS-210
Serial #: SSNT92-U2B Rev A
Issue Date: 27th April 2015
Page: 56 of 70

External Antenna - Radiated Spurious Emissions

GPS turned on

EUT	NIC 451-0523-10	Engineer	JMH
Variant	Digital Emissions	Temp (°C)	18
Freq. Range	30 MHz - 1000 MHz	Rel. Hum.(%)	43
Standard Limit	FCC Class B	Press. (mBars)	1005
Support Equip	None		
Test Notes	MAC: 00:13:50:07:00:00:03:CD, EXT Antenna WPANT30088-S1A, GPS ON		

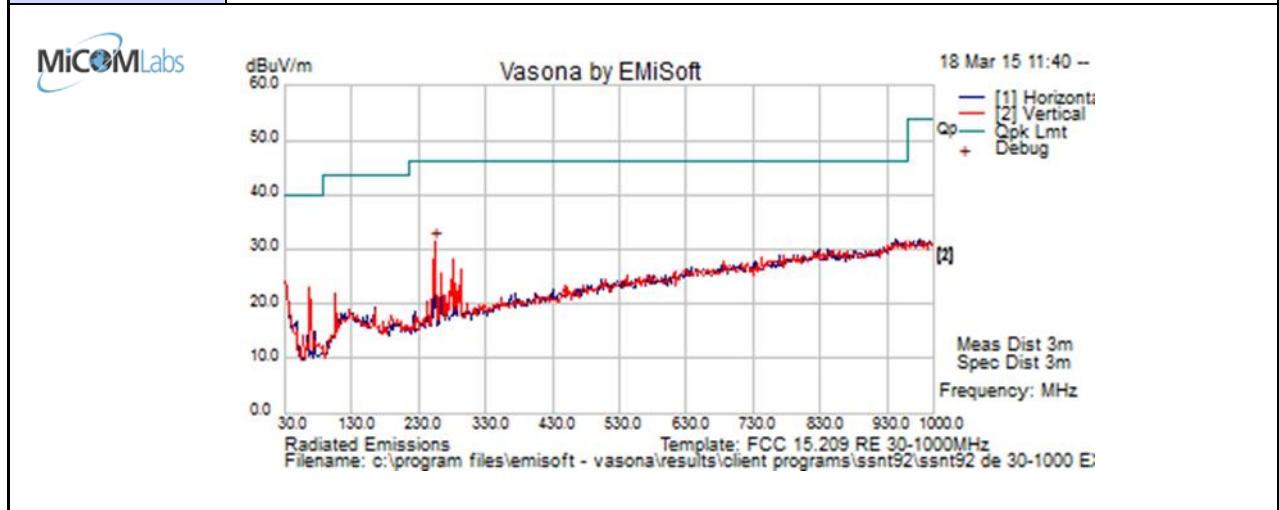

Formally measured emission peaks

Frequency MHz	Raw dBuV	Cable Loss	AF dB	Level dBuV/m	Measurement Type	Pol	Hgt cm	Azt Deg	Limit dBuV/m	Margin dB	Pass /Fail	Comments
253.653	45.8	4.5	-19.0	31.270	Peak [Scan]	V	98	361	46.0	-14.7	Pass	

Legend:	DIG = Digital Device Emission; TX = Transmitter Emission; FUND = Fundamental Frequency
	TRNS= Transient Emission, Brbnd= Broadband emission

NOTE: The emission breaking the limit line is the fundamental frequency. A notch filter was used to attenuate the fundamental frequency

This test report may be reproduced in full only. The document may only be updated by MiCOM Labs personnel. Any changes will be noted in the Document History section of the report.



Title: Silver Spring Networks NIC 451
To: FCC 47 CFR Part15.247 & IC RSS-210
Serial #: SSNT92-U2B Rev A
Issue Date: 27th April 2015
Page: 57 of 70

External Antenna - Radiated Spurious Emissions

RTC turned on

RTC – real time clock

EUT	NIC 451-0503-10	Engineer	JMH
Variant	Digital Emissions	Temp (°C)	20
Freq. Range	30 MHz - 1000 MHz	Rel. Hum.(%)	42
Standard Limit	FCC Class B	Press. (mBars)	1011
Support Equip	None		
Test Notes	MAC: 00:13:50:07:00:00:03:CD, EXT Antenna WPANT30088-S1A, RTC ON		

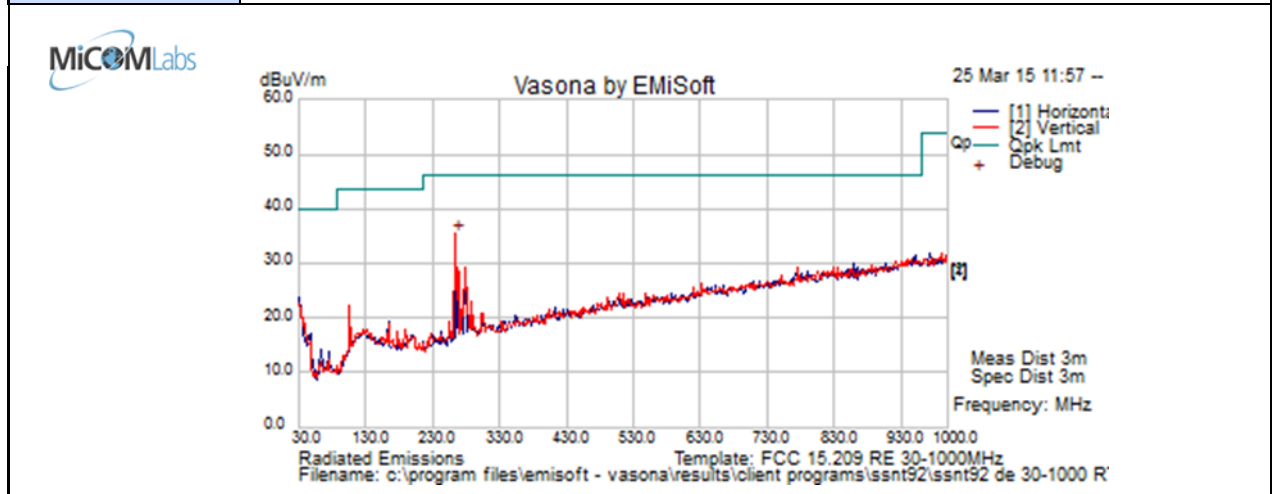

Formally measured emission peaks

Frequency MHz	Raw dBuV	Cable Loss	AF dB	Level dBuV/m	Measurement Type	Pol	Hgt cm	Azt Deg	Limit dBuV/m	Margin dB	Pass /Fail	Comments
265.174	48.5	4.6	-17.7	35.380	Peak [Scan]	V	100	361	46.0	-10.6	Pass	

Legend:	DIG = Digital Device Emission; TX = Transmitter Emission; FUND = Fundamental Frequency
	TRNS= Transient Emission, Brbnd= Broadband emission

NOTE: The emission breaking the limit line is the fundamental frequency. A notch filter was used to attenuate the fundamental frequency

This test report may be reproduced in full only. The document may only be updated by MiCOM Labs personnel. Any changes will be noted in the Document History section of the report.



Specification

Limits

§15.205 (a) Except as shown in paragraph (d) of 15.205 (a), only spurious emissions are permitted in any of the frequency bands listed.

§15.205 (a) Except as shown in paragraphs (d) and (e) of this section, the field strength of emissions appearing within these frequency bands shall not exceed the limits shown in Section §15.209. At frequencies equal to or less than 1000 MHz, compliance with the limits in Section 15.209 shall be demonstrated using measurement instrumentation employing a CISPR quasi-peak detector. Above 1000 MHz, compliance with the emission limits in Section 15.209 shall be demonstrated based on the average value of the measured emissions. The provisions in Section 15.35 apply to these measurements.

§15.209 (a) Except as provided elsewhere in this subpart, the emissions from an intentional radiator shall not exceed the field strength levels specified in the following table.

§15.209 (a) and RSS-Gen §8.9 Limit Matrix

Frequency(MHz)	Field Strength (μV/m)	Field Strength (dBμV/m)	Measurement Distance (meters)
30-88	100	40.0	3
88-216	150	43.5	3
216-960	200	46.0	3
Above 960	500	54.0	3

Laboratory Measurement Uncertainty for Radiated Emissions

Measurement uncertainty	+5.6/ -4.5 dB
-------------------------	---------------

6.9. AC Wireline Conducted Emissions (150 kHz – 30 MHz)

NOTE: Test not applicable EUT is dc powered

FCC, Part 15 Subpart C §15.207
Industry Canada RSS-Gen §8.8

Test Procedure

The EUT is configured in accordance with ANSI C63.4. The conducted emissions are measured in a shielded room with a spectrum analyzer in peak hold in the first instance. Emissions closest to the limit are measured in the quasi-peak mode (QP) with the tuned receiver using a bandwidth of 9 kHz. The emissions are maximized further by cable manipulation. The highest emissions relative to the limit are listed.

Test Measurement Set up

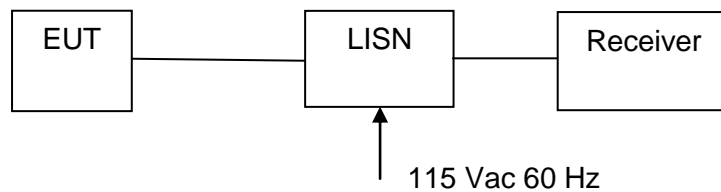

Measurement set up for AC Wireline Conducted Emissions Test

Measurement Results for AC Wireline Conducted Emissions (150 kHz – 30 MHz)



Specification

Limit

§15.207 (a) Except as shown in paragraphs (b) and (c) of this section, for an intentional radiator that is designed to be connected to the public utility (AC) power line, the radio frequency voltage that is conducted back onto the AC power line on any frequency or frequencies within the band 150 kHz to 30 MHz shall not exceed the limits in the following table, as measured using a 50 $\mu\Omega$ line impedance stabilization network (LISN), see §15.207 (a) matrix below. Compliance with the provisions of this paragraph shall be based on the measurement of the radio frequency voltage between each power line and ground at the power terminal. The lower limit applies at the boundary between the frequency ranges.

RSS-Gen §8.8

A radio apparatus that is designed to be connected to the public utility (AC) power line shall ensure that the radio frequency voltage, which is conducted back onto the AC power line on any frequency or frequencies within the band 150 kHz-30 MHz, shall not exceed the limits in Table 3.

§15.207 (a) and RSS-Gen §8.8 Limit Matrix

The lower limit applies at the boundary between frequency ranges

Frequency of Emission (MHz)	Conducted Limit (dB μ V)	
	Quasi-peak	Average
0.15-0.5	66 to 56*	56 to 46*
0.5-5	56	46
5-30	60	50

* Decreases with the logarithm of the frequency

Laboratory Measurement Uncertainty for Conducted Emissions

Measurement uncertainty	± 2.64 dB
-------------------------	---------------



Title: Silver Spring Networks NIC 451
To: FCC 47 CFR Part15.247 & IC RSS-210
Serial #: SSNT92-U2B Rev A
Issue Date: 27th April 2015
Page: 61 of 70

APPENDIX

A. SUPPORTING INFORMATION

A.1. CONDUCTED TEST PLOTS

This test report may be reproduced in full only. The document may only be updated by MiCOM Labs personnel. Any changes will be noted in the Document History section of the report.

A.1.1. 20 dB & 99% Bandwidth



20 dB & 99% Bandwidth

Variant: 500 GFSK, Channel: 2400.80 MHz, Chain a, Temp: 25 C, Voltage: 4 Vdc

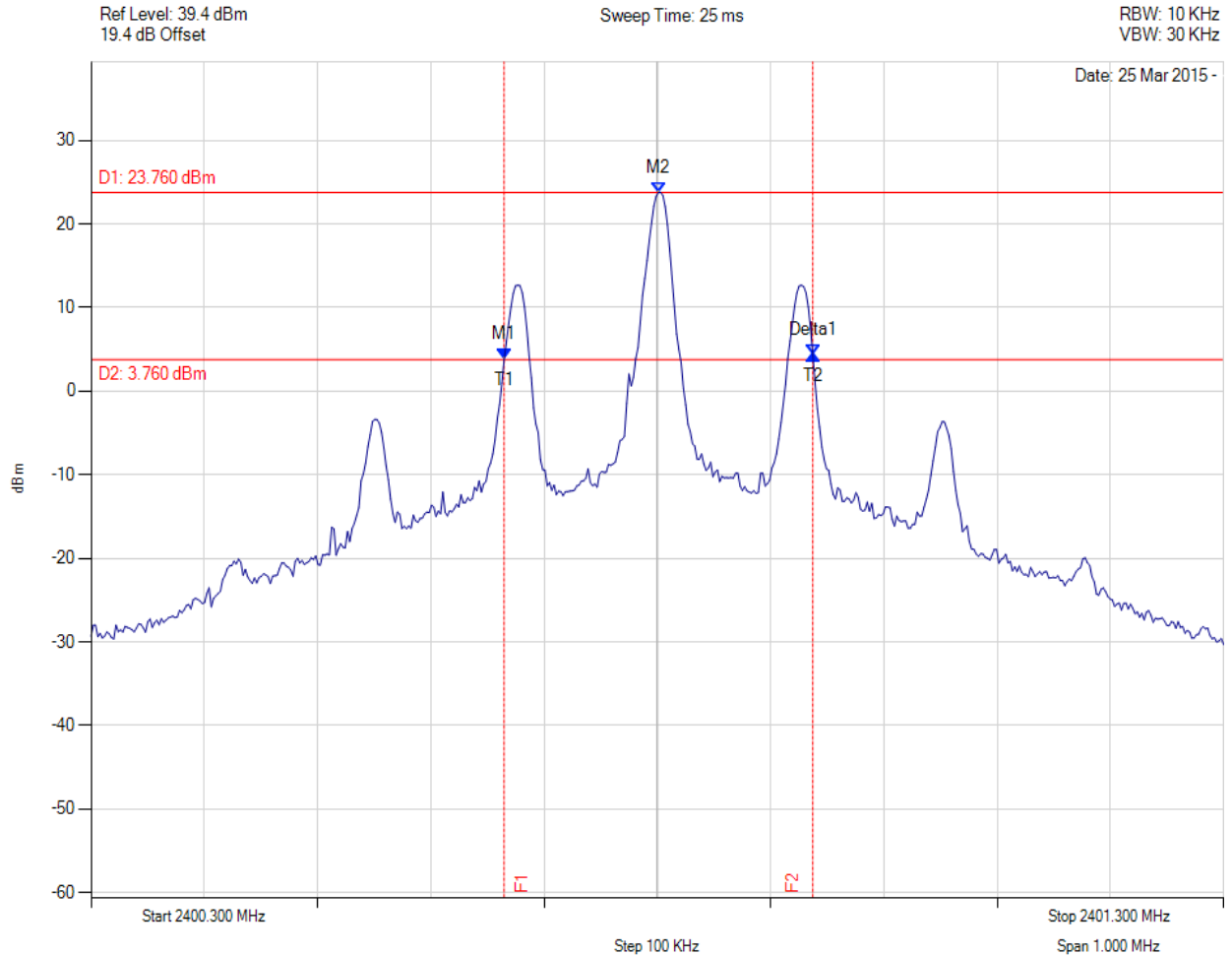

Analyser Setup	Marker:Frequency:Amplitude	Test Results
Detector = MAX PEAK Sweep Count = 0 RF Atten (dB) = 40 Trace Mode = VIEWS	M1 : 2400.665 MHz : 3.832 dBm M2 : 2400.801 MHz : 23.763 dBm Delta1 : 273 KHz : 0.498 dB T1 : 2400.665 MHz : 3.830 dBm T2 : 2400.937 MHz : 4.330 dBm OBW : 273 KHz	Channel Frequency: 2400.80 MHz

[Back to Matrix](#)

This test report may be reproduced in full only. The document may only be updated by MiCOM Labs personnel. Any changes will be noted in the Document History section of the report.



20 dB & 99% Bandwidth

Variant: 500 GFSK, Channel: 2440.00 MHz, Chain a, Temp: 25 C, Voltage: 4 Vdc

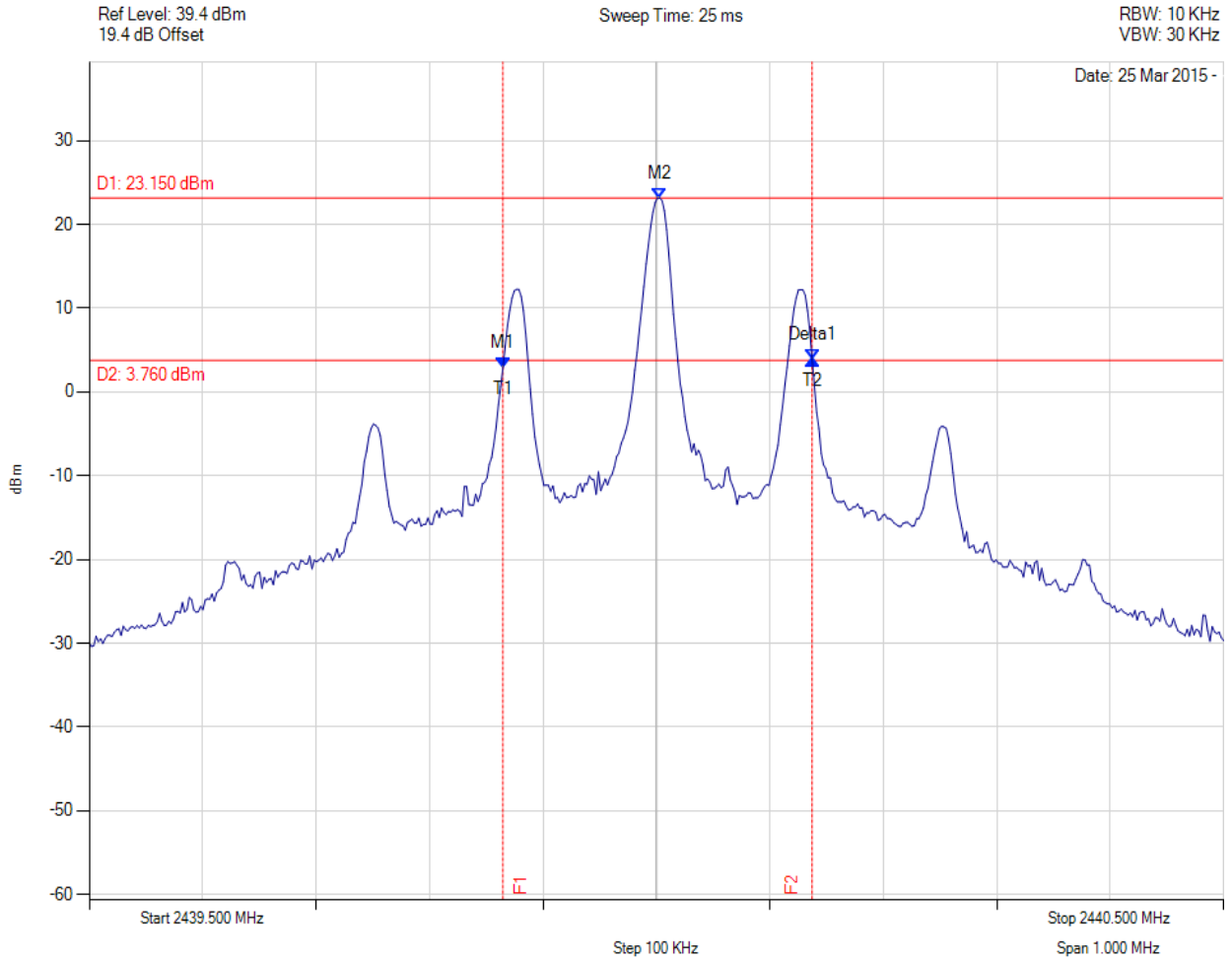

Analyser Setup	Marker:Frequency:Amplitude	Test Results
Detector = MAX PEAK Sweep Count = 0 RF Atten (dB) = 40 Trace Mode = VIEW	M1 : 2439.865 MHz : 2.898 dBm M2 : 2440.003 MHz : 23.152 dBm Delta1 : 273 KHz : 0.986 dB T1 : 2439.865 MHz : 2.900 dBm T2 : 2440.137 MHz : 3.880 dBm OBW : 273 KHz	Channel Frequency: 2440.00 MHz

[Back to Matrix](#)

This test report may be reproduced in full only. The document may only be updated by MiCOM Labs personnel. Any changes will be noted in the Document History section of the report.



20 dB & 99% Bandwidth

Variant: 500 GFSK, Channel: 2472.80 MHz, Chain a, Temp: 25 C, Voltage: 4 Vdc

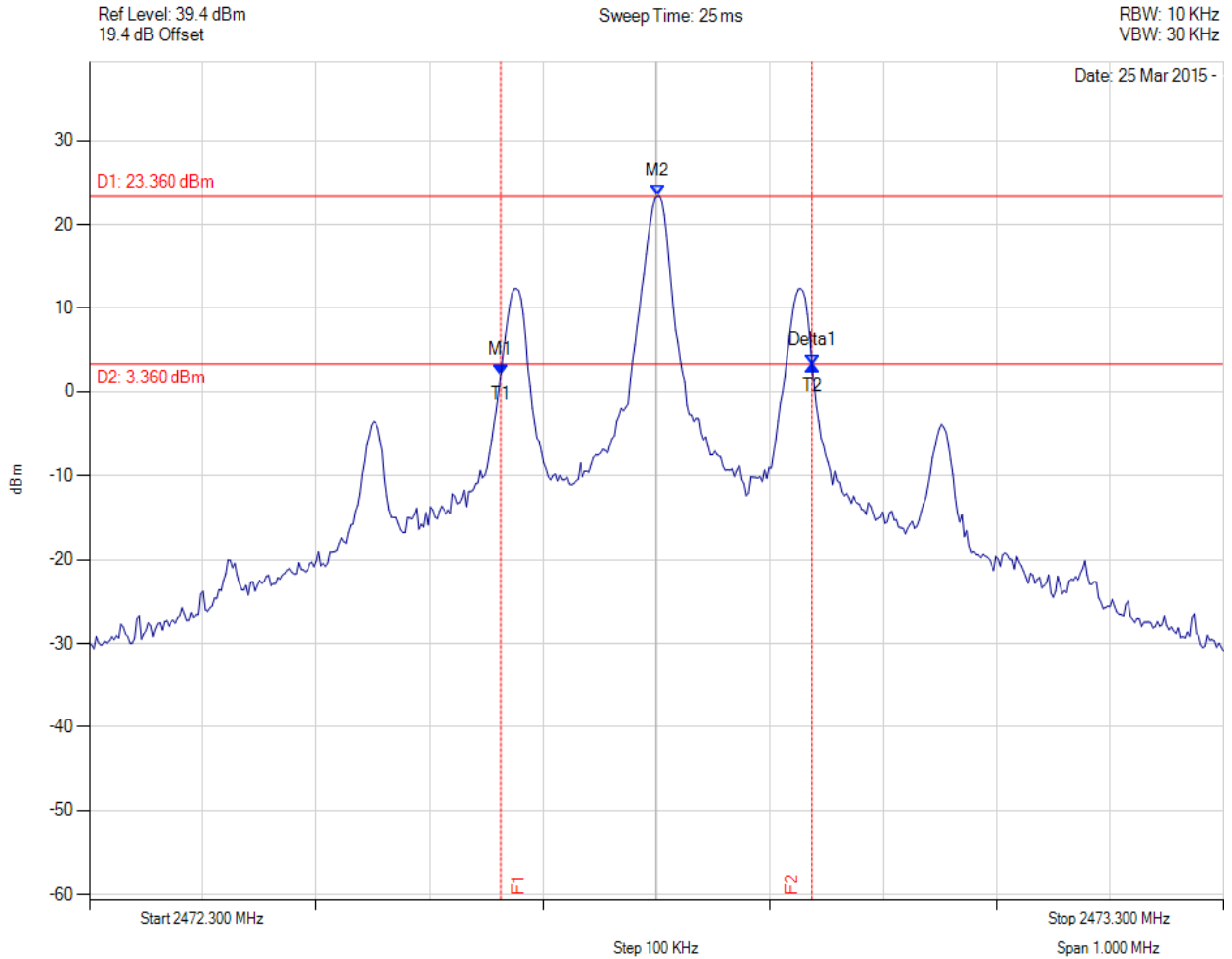

Analyser Setup	Marker:Frequency:Amplitude	Test Results
Detector = MAX PEAK Sweep Count = 0 RF Atten (dB) = 40 Trace Mode = VIEW	M1 : 2472.663 MHz : 2.146 dBm M2 : 2472.801 MHz : 23.360 dBm Delta1 : 275 KHz : 1.035 dB T1 : 2472.663 MHz : 2.150 dBm T2 : 2472.937 MHz : 3.180 dBm OBW : 275 KHz	Channel Frequency: 2472.80 MHz

[Back to Matrix](#)

This test report may be reproduced in full only. The document may only be updated by MiCOM Labs personnel. Any changes will be noted in the Document History section of the report.



A.1.2. Conducted Spurious and Band-Edge Emissions



Transmitter Band-Edge Emissions

Variant: 500 GFSK, Channel: 2400.80 MHz, Chain a, Temp: 25 C, Voltage: 4 Vdc

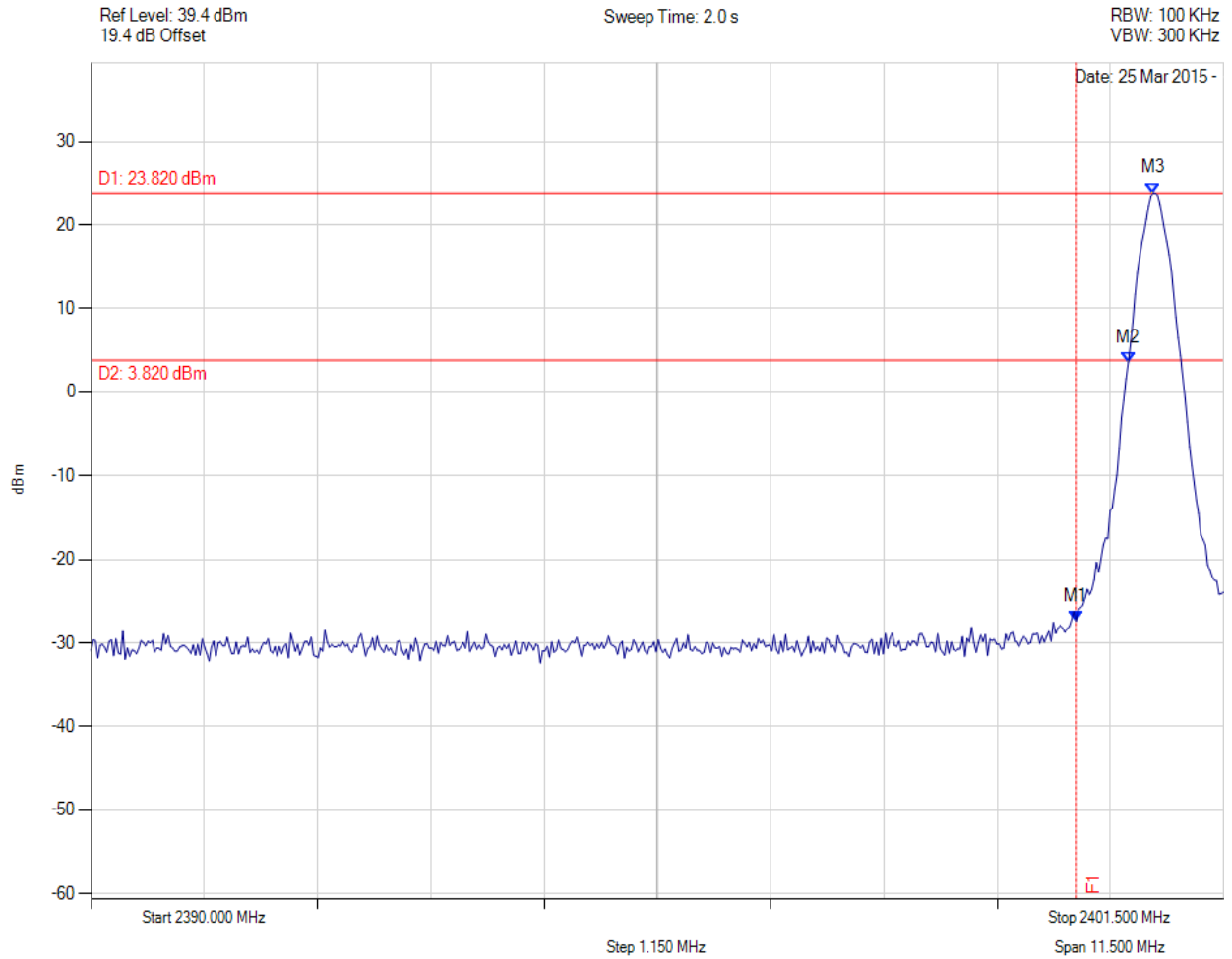

Analyser Setup	Marker:Frequency:Amplitude	Test Results
Detector = MAX PEAK Sweep Count = 0 RF Atten (dB) = 40 Trace Mode = VIEW	M1 : 2400.000 MHz : -27.374 dBm M2 : 2400.532 MHz : 3.555 dBm M3 : 2400.786 MHz : 23.824 dBm	Channel Frequency: 2400.80 MHz

[Back to Matrix](#)

This test report may be reproduced in full only. The document may only be updated by MiCOM Labs personnel. Any changes will be noted in the Document History section of the report.



Transmitter Band-Edge Emissions



Variant: 500 GFSK, Channel: 2472.80 MHz, Chain a, Temp: 25 C, Voltage: 4 Vdc

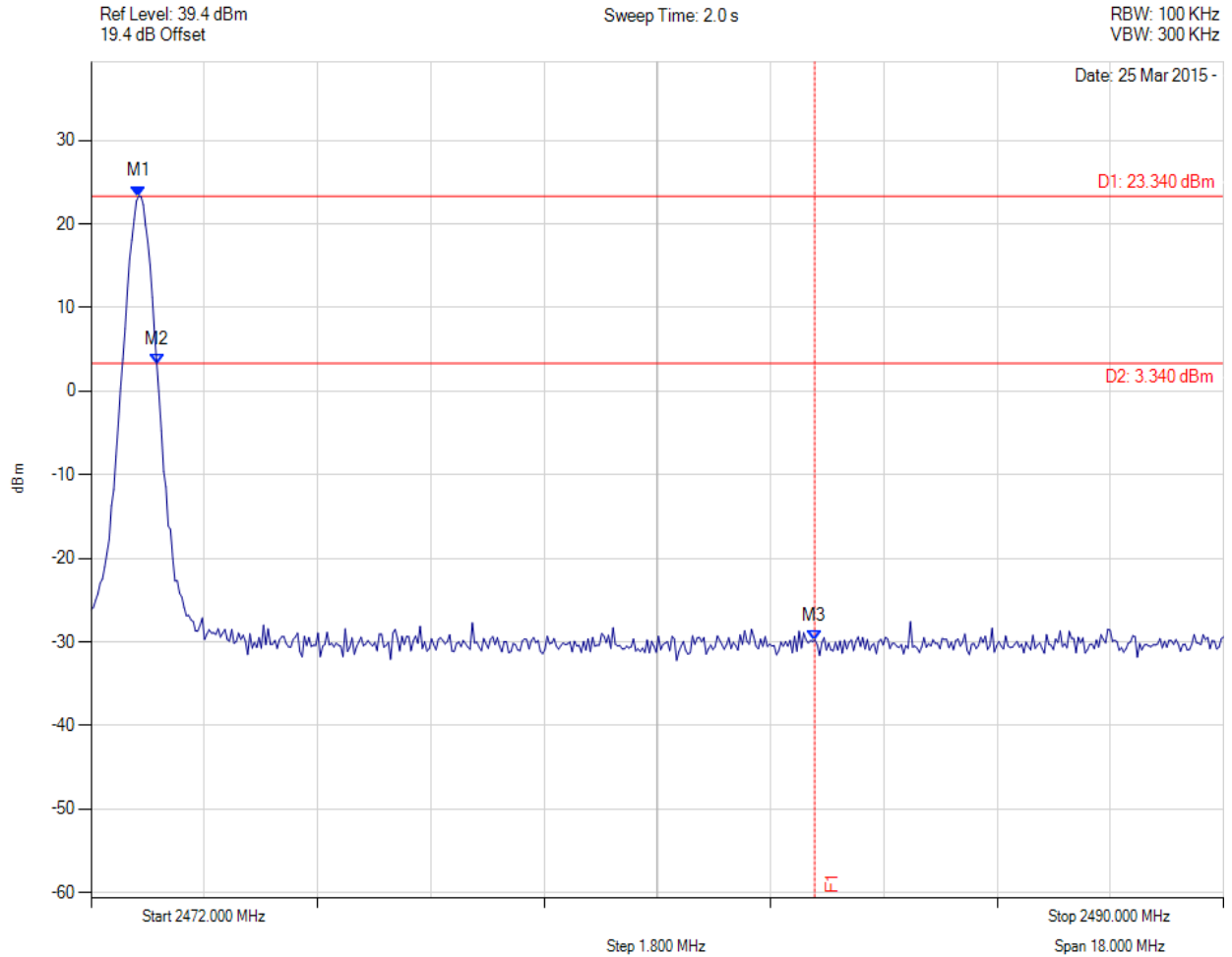

Analyser Setup	Marker:Frequency:Amplitude	Test Results
Detector = MAX PEAK Sweep Count = 0 RF Atten (dB) = 40 Trace Mode = VIEW	M1 : 2472.758 MHz : 23.342 dBm M2 : 2473.046 MHz : 3.197 dBm M3 : 2483.500 MHz : -29.782 dBm	Channel Frequency: 2472.80 MHz

[Back to Matrix](#)

This test report may be reproduced in full only. The document may only be updated by MiCOM Labs personnel. Any changes will be noted in the Document History section of the report.



Conducted Transmitter Emissions



Variant: 500 GFSK, Channel: 2400.80 MHz, Chain a, Temp: 25 C, Voltage: 4 Vdc

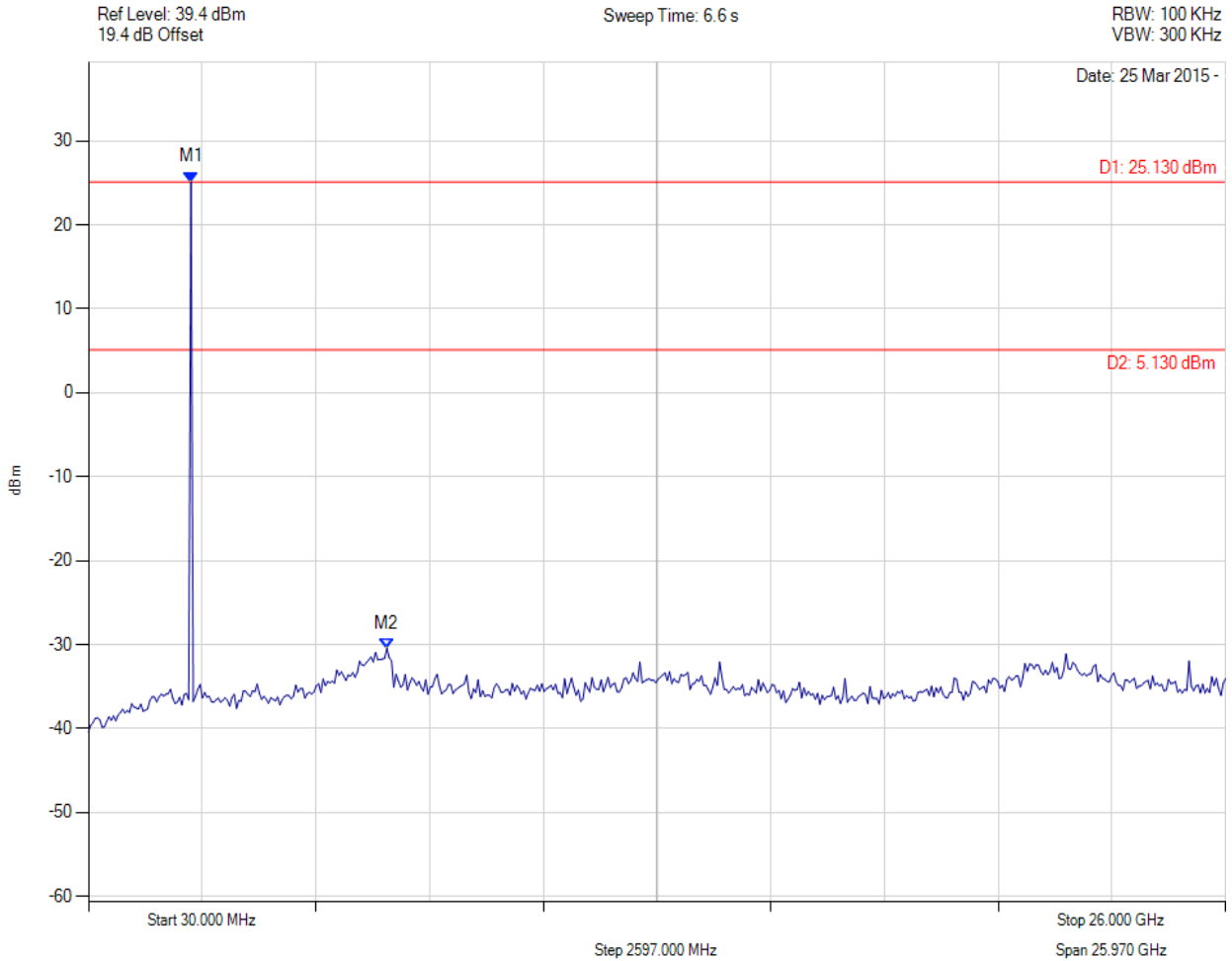

Analyser Setup	Marker:Frequency:Amplitude	Test Results
Detector = MAX PEAK Sweep Count = 0 RF Atten (dB) = 30 Trace Mode = CLR/WRITE	M1 : 2371.984 MHz : 25.131 dBm M2 : 6847.776 MHz : -30.435 dBm	Channel Frequency: 2400.80 MHz

[Back to Matrix](#)

This test report may be reproduced in full only. The document may only be updated by MiCOM Labs personnel. Any changes will be noted in the Document History section of the report.



Conducted Transmitter Emissions



Variant: 500 GFSK, Channel: 2440.00 MHz, Chain a, Temp: 25 C, Voltage: 4 Vdc

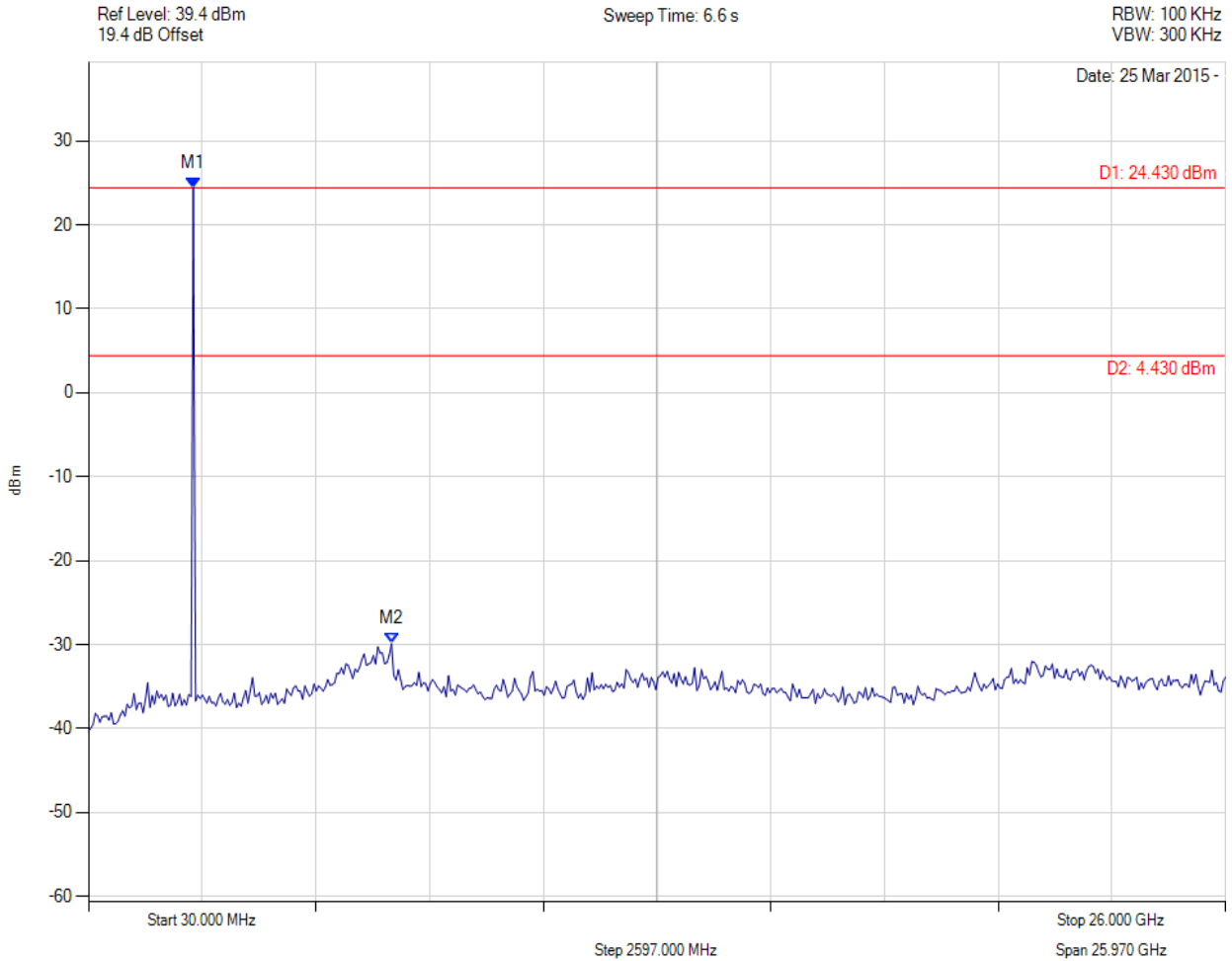

Analyser Setup	Marker:Frequency:Amplitude	Test Results
Detector = MAX PEAK Sweep Count = 0 RF Atten (dB) = 30 Trace Mode = CLR/WRITE	M1 : 2424.028 MHz : 24.430 dBm M2 : 6951.864 MHz : -29.888 dBm	Channel Frequency: 2440.00 MHz

[Back to Matrix](#)

This test report may be reproduced in full only. The document may only be updated by MiCOM Labs personnel. Any changes will be noted in the Document History section of the report.



Conducted Transmitter Emissions



Variants: 500 GFSK, Channel: 2472.80 MHz, Chain a, Temp: 25 C, Voltage: 4 Vdc

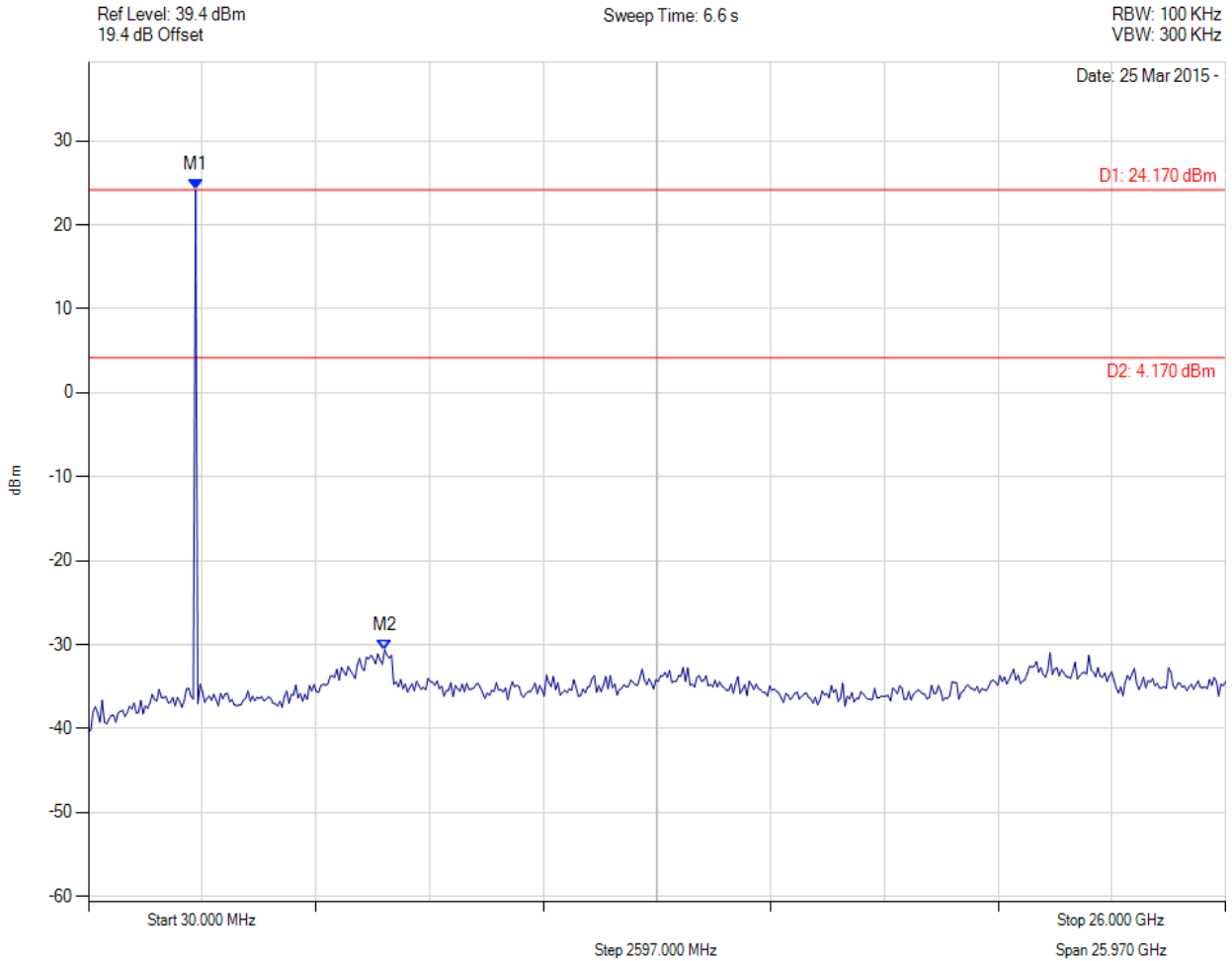

Analyser Setup	Marker:Frequency:Amplitude	Test Results
Detector = MAX PEAK Sweep Count = 0 RF Atten (dB) = 30 Trace Mode = CLR/WRITE	M1 : 2476.072 MHz : 24.165 dBm M2 : 6795.731 MHz : -30.638 dBm	Channel Frequency: 2472.80 MHz

[Back to Matrix](#)

This test report may be reproduced in full only. The document may only be updated by MiCOM Labs personnel. Any changes will be noted in the Document History section of the report.



575 Boulder Court,
Pleasanton,
California 94566,
USA
Tel: 1.925.462.0304
Fax: 1.925.462.0306
www.micomlabs.com