

EMISSIONS TEST REPORT FOR A LOW POWER TRANSMITTER

I. GENERAL INFORMATION

Requirement: FCC
Test Requirements: FCC Part 15

Applicant: Silver Spring Networks
575 Broadway Street
Redwood City, CA 94063

FCC ID: OWS-NIC44
IC: 5975A-NIC44
Model No.: NIC44

II. DESCRIPTION OF EQUIPMENT UNDER TEST (EUT)

The Silver Spring Networks (SSN) model NIC44 is a 900 MHz frequency hopping mesh network radio module for use in Smart Grid networks..

III. TEST DATES AND TEST LOCATION

Testing was performed between 11-13 December 2012 and on 5 March 2013.

Radiated emissions:
BACL Laboratories
1274 Anvilwood Ave.
Sunnyvale, CA 94089

Antenna port conducted emissions tests were performed at Silver Spring Networks.



T.N. Cokenias
EMC Consultant/Agent for Silver Spring Networks

5 March 2013

15.203 Antenna connector requirement

Antenna description	Mfr.	Model No.	Gain
External monopole	WP Wireless	WP ANT30017-CA	3 dBi at 915 MHz
External monopole	L-Com	HGV-906U	6 dBi at 915 MHz

The antennas use standard N-connectors. The EUT requires professional installation.

TEST PROCEDURES

All tests were performed in accordance with the applicable procedures called out in the following documents, unless otherwise noted:

FCC 47CFR15

DA 00-705: Filing and Measurement Guidelines for Frequency Hopping Spread Spectrum Systems

RSS-Gen Issue 3: General Requirements and Information for the Certification of Radio Apparatus

RSS-210 Issue 8: Low power license exempt radio frequency devices (December 2010)
RSS-212: Test Facilities and Test Methods for Radio Equipment

ANSI C63.4 – 2003, American National Standard for Methods of Measurement of Radio-Noise Emissions from Low-Voltage Electrical and Electronic Equipment in the Range of 9 kHz to 40 GHz.

Laboratory Accreditation Information

BACL

2.948 FCC Registration Number: 90464
Industry Canada Test Site Registration Number: 3062A
Accrediting Body:: A2LA

Test Equipment

Silver Spring Networks:

Equipment	Mfr	Model	Serial No.	Cal Due
Spectrum analyzer	Agilent	E4405B	MY45113391	01/23/13
Spectrum analyzer	Agilent	N9030A	MY48030147	01/23/13

BACL

Manufacturer	Description	Model No.	Serial No.	Calibration Due
Rohde & Schwarz	EMI Test Receiver	ESCI 1166.5950K03	100337	2013-03-22
Agilent	Spectrum Analyzer	E4440A	MY44303352	2013-05-10
Sunol Science Corp	System Controller	SC99V	122303-1	N/R
Sunol Science Corp	Combination Antenna	JB3	A0020106-3	2013-06-29
EMCO	Horn antenna 1-18 GHz	3115	9511-4627	2013-10-03
WiseWave	Horn antenna 18-26.5 GHz	ARH-4223-02	10555-01	2013-8-09
Hewlett Packard	Pre amplifier	8447D	2944A06639	2013-06-09
Mini-Circuits	Pre Amplifier	ZVA-183-S	570400946	2013-05-09

Test Set-up Diagram

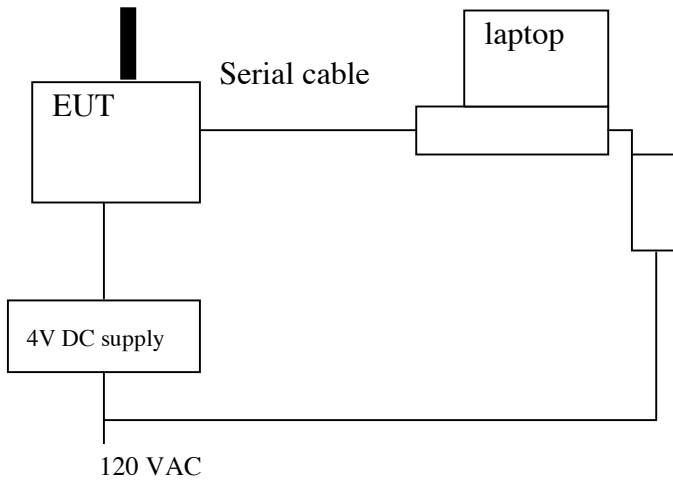

Support Equipment

Equipment	Mfr	Model	Asset No.
Laptop PC	Dell	PP01L	TW-0791UH1280-OC9-6558
AC/DC adapter	CUI Inc.	DSA-60W-20	2607HB

900 MHz FREQUENCY HOPPING SPREAD SPECTRUM RADIO EMISSIONS

The 900 MHz FHSS will employ the following channel separations and modulations:

<u>Data Rate</u>	<u>Modulation</u>
100 kHz	FSK
300 kHz	FSK

The number of channels, occupied bandwidths, and output powers are the same for both data rates. The difference between the two data rates is due to difference in hopping frequency (hops/second).

Except as indicated tests were conducted at the 300 kbps setting.

TEST RESULTS

Radiated Test Set-up, 30 MHz-9.3 GHz

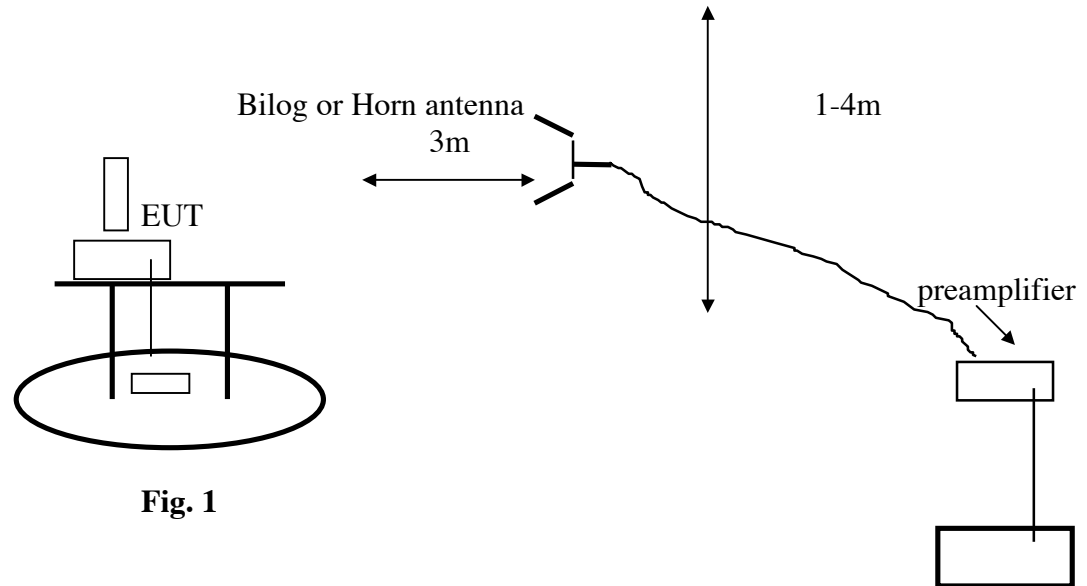

Fig. 1

Test Procedures

Radiated emissions generated by the transmitter portion of the EUT were measured.

1. The EUT was placed on a wooden table resting on a turntable on the test site. The search antenna was placed 3m from the EUT. The EUT antenna was mounted in the with the EUT TX antenna pointed directly to the search antenna.
2. The turntable was slowly rotated to locate the direction of maximum emission at each emission falling in the restricted bands of 15.205.
3. Emissions were investigated to the 10th harmonic of the fundamental.
4. Once maximum direction was determined, the search antenna was raised and lowered in both vertical and horizontal polarizations. The maximum readings so obtained are recorded in the data listed below.

Test Results: Worst-case results are presented. Refer to data sheets below. Restricted band emissions meet 54 dBuV/m. Other undesired emissions from the transmitter meet the -20 dBc requirement in 15.247(d).

15.205 Restricted Frequency Bands

MHz	MHz	MHz	GHz
0.090 - 0.110	16.42 - 16.423	399.9 - 410	4.5 - 5.15
0.495 - 0.505 (1)	16.69475 - 16.69525	608 - 614	5.35 - 5.46
2.1735 - 2.1905	16.80425 - 16.80475	960 - 1240	7.25 - 7.75
4.125 - 4.128	25.5 - 25.67	1300 - 1427	8.025 - 8.5
4.17725 - 4.17775	37.5 - 38.25	1435 - 1626.5	9.0 - 9.2
4.20725 - 4.20775	73 - 74.6	1645.5 - 1646.5	9.3 - 9.5
6.215 - 6.218	74.8 - 75.2	1660 - 1710	10.6 - 12.7
6.26775 - 6.26825	108 - 121.94	1718.8 - 1722.2	13.25 - 13.4
6.31175 - 6.31225	123 - 138	2200 - 2300	14.47 - 14.5
8.291 - 8.294	149.9 - 150.05	2310 - 2390	15.35 - 16.2
8.362 - 8.366	156.52475 -	2483.5 - 2500	17.7 - 21.4
8.37625 - 8.38675	156.52525	2655 - 2900	22.01 - 23.12
8.41425 - 8.41475	156.7 - 156.9	3260 - 3267	23.6 - 24.0
12.29 - 12.293	162.0125 - 167.17	3332 - 3339	31.2 - 31.8
12.51975 - 12.52025	167.72 - 173.2	3345.8 - 3358	36.43 - 36.5
12.57675 - 12.57725	240 - 285	3600 - 4400	
13.36 - 13.41	322 - 335.4		

15.209 General Field Strength Limits

Frequency (MHz)	Field Strength (microvolts/meter)	Measurement Distance (meters)
0.009 - 0.490	2400/F (kHz)	300
0.490 - 1.705	24000/F (kHz)	30
1.705 - 30.0	30	30
30 - 88	100 **	3
88 - 216	150 **	3
216 - 960	200 **	3
Above 960	500	3

Radiated Emissions Above 1 GHz

3 dBi antenna, 100 kbps



Company Name: Silver Spring Networks
 Product Type: Board
 Project Number: T1212111
 Tester: Wei Sun
 Date: 2012-12-11
 FCC 15 C in 5 M Chamber 2 at 3 meters distance
 Notes: Standard 3 dBi antenna, MAC: 300049 (RFFM6903) Part No. :170-0227-00R12

Frequency (MHz)	S.A. Reading (dBµV)	Azimuth (degrees)	Test Antenna			Cable Loss (dB)	Pre-Amp. (dB)	Cord. Reading (dBµV/m)	FCC 15.247		Comments	Power setting
			Height (cm)	Polarity (H/V)	Factor (dB/m)				Limit (dBµV/m)	Margin (dB)		
Low channel 902.3 MHz measured at 3 meters 100kbps												
1804.6	69.37	153	100	H	27.2	3.37	27.67	72.27		72.27	Peak	112=60
1804.6	71.69	185	100	V	27.2	3.37	27.67	74.59		74.59	Peak	112=60
2706.9	49.4	155	181	V	29.21	4.09	27.85	54.85	74	-19.15	Peak	112=60
2706.9	47.49	155	181	V	29.21	4.09	27.85	52.94	54	-1.06	Ave	112=60
2706.9	49.99	233	145	H	29.21	4.09	27.85	55.44	74	-18.56	Peak	112=60
2706.9	48.19	233	145	H	29.21	4.09	27.85	53.64	54	-0.36	Ave	112=60
3609.2	40.63	172	100	V	31.54	4.78	27.96	48.99	74	-25.01	Peak	112=60
3609.2	34.94	172	100	V	31.54	4.78	27.96	43.3	54	-10.7	Ave	112=60
3609.2	42.1	313	171	H	31.54	4.78	27.96	50.46	74	-23.54	Peak	112=60
3609.2	38.15	313	171	H	31.54	4.78	27.96	46.51	54	-7.49	Ave	112=60
3609.2	34.12	23	176	H	31.54	4.78	27.96	42.48	54	-11.52	Ave	112=60

Frequency (MHz)	S.A. Reading (dBµV)	Azimuth (degrees)	Test Antenna			Cable Loss (dB)	Pre-Amp. (dB)	Cord. Reading (dBµV/m)	FCC 15.247		Comments	Power setting
			Height (cm)	Polarity (H/V)	Factor (dB/m)				Limit (dBµV/m)	Margin (dB)		
Middle channel 914.6 MHz measured at 3 meters 100kbps												
1829.2	65.99	141	116	H	27.2	3.37	27.68	68.88		68.88	Peak	112=60
1829.2	66.41	173	130	V	27.2	3.37	27.68	69.3		69.3	Peak	112=60
2743.8	43.18	169	100	V	29.21	4.1	27.83	48.66	74	-25.34	Peak	112=60
2743.8	39.17	169	100	V	29.21	4.1	27.83	44.65	54	-9.35	Ave	112=60
2743.8	43.93	140	100	H	29.21	4.1	27.83	49.41	74	-24.59	Peak	112=60
2743.8	40.23	140	100	H	29.21	4.1	27.83	45.71	54	-8.29	Ave	112=60
3658.4	38.78	326	100	V	32.07	4.77	27.96	47.66	74	-26.34	Peak	112=60
3658.4	32.13	326	100	V	32.07	4.77	27.96	41.01	54	-12.99	Ave	112=60
3658.4	41.97	234	191	H	32.07	4.77	27.96	50.85	74	-23.15	Peak	112=60
3658.4	38.34	234	191	H	32.07	4.77	27.96	47.22	54	-6.78	Ave	112=60

Frequency (MHz)	S.A. Reading (dBµV)	Azimuth (degrees)	Test Antenna			Cable Loss (dB)	Pre-Amp. (dB)	Cord. Reading (dBµV/m)	FCC 15.247		Comments	Power setting
			Height (cm)	Polarity (H/V)	Factor (dB/m)				Limit (dBµV/m)	Margin (dB)		
High channel 926.9 MHz measured at 3 meters 100kbps												
1853.8	61.91	139	100	H	27.77	3.36	27.73	65.31		65.31	Peak	112=60
1853.8	60.83	174	100	V	27.77	3.36	27.73	64.23		64.23	Peak	112=60
2780.7	34	0	100	V	29.26	4.2	27.81	39.65	74	-34.35	Peak	112=60
2780.7	22	0	100	V	29.26	4.2	27.81	27.65	54	-26.35	Ave	112=60
2780.7	34	0	100	H	29.26	4.2	27.81	39.65	74	-34.35	Peak	112=60
2780.7	22	0	100	H	29.26	4.2	27.81	27.65	54	-26.35	Ave	112=60
3707.6	40.12	180	100	V	32.07	4.93	27.96	49.16	74	-24.84	Peak	112=60
3707.6	35.25	180	100	V	32.07	4.93	27.96	44.29	54	-9.71	Ave	112=60
3707.6	43.99	220	184	H	32.07	4.93	27.96	53.03	74	-20.97	Peak	112=60
3707.6	41.88	220	184	H	32.07	4.93	27.96	50.92	54	-3.08	Ave	112=60

3 dBi antenna 300 kbps



Company Name: Silver Spring Networks
 Product Type: Board
 Project Number:T1212111
 Tester: Wei Sun
 Date: 2012-12-11
 FCC 15 C in 5 M Chamber 2 at 3 meters distance
 Notes: Standard 3 dBi antenna, MAC: 300049 (RFFM6903) Part No. :170-0227-00R12

Frequency (MHz)	S.A. Reading (dBµV)	Azimuth (degrees)	Test Antenna			Cable Loss (dB)	Pre-Amp. (dB)	Cord. Reading (dBµV/m)	FCC 15.247		Comments	Power setting
			Height (cm)	Polarity (H/V)	Factor (dB/m)				Limit (dBµV/m)	Margin (dB)		
Low channel 902.3 MHz measured at 3 meters 300kbps												
1804.6	69.94	151	100	H	27.2	3.37	27.67	72.84		72.84	Peak	112=60
1804.6	71.78	187	100	V	27.2	3.37	27.67	74.68		74.68	Peak	112=60
2706.9	48.5	181	125	V	29.21	4.09	27.85	53.95	74	-20.05	Peak	112=60
2706.9	46.84	181	125	V	29.21	4.09	27.85	52.29	54	-1.71	Ave	112=60
2706.9	49.47	233	189	H	29.21	4.09	27.85	54.92	74	-19.08	Peak	112=60
2706.9	47.94	233	189	H	29.21	4.09	27.85	53.39	54	-0.61	Ave	112=60
3609.2	40.51	329	100	V	31.54	4.78	27.96	48.87	74	-25.13	Peak	112=60
3609.2	35.36	329	100	V	31.54	4.78	27.96	43.72	54	-10.28	Ave	112=60
3609.2	39.45	23	176	H	31.54	4.78	27.96	47.81	74	-26.19	Peak	112=60
3609.2	34.12	23	176	H	31.54	4.78	27.96	42.48	54	-11.52	Ave	112=60

Frequency (MHz)	S.A. Reading (dBµV)	Azimuth (degrees)	Test Antenna			Cable Loss (dB)	Pre-Amp. (dB)	Cord. Reading (dBµV/m)	FCC 15.247		Comments	Power setting
			Height (cm)	Polarity (H/V)	Factor (dB/m)				Limit (dBµV/m)	Margin (dB)		
Middle channel 914.6 MHz measured at 3 meters 300kbps												
1829.2	66.18	140	115	H	27.2	3.37	27.68	69.07		69.07	Peak	112=60
1829.2	65.51	171	100	V	27.2	3.37	27.68	68.4		68.4	Peak	112=60
2743.8	44.06	183	138	V	29.21	4.1	27.83	49.54	74	-24.46	Peak	112=60
2743.8	40.14	183	138	V	29.21	4.1	27.83	45.62	54	-8.38	Ave	112=60
2743.8	45.17	235	186	H	29.21	4.1	27.83	50.65	74	-23.35	Peak	112=60
2743.8	42.34	235	186	H	29.21	4.1	27.83	47.82	54	-6.18	Ave	112=60
3658.4	38.78	173	100	V	32.07	4.77	27.96	47.66	74	-26.34	Peak	112=60
3658.4	32.55	173	100	V	32.07	4.77	27.96	41.43	54	-12.57	Ave	112=60
3658.4	40.89	247	127	H	32.07	4.77	27.96	49.77	74	-24.23	Peak	112=60
3658.4	36.95	247	127	H	32.07	4.77	27.96	45.83	54	-8.17	Ave	112=60

Frequency (MHz)	S.A. Reading (dBµV)	Azimuth (degrees)	Test Antenna			Cable Loss (dB)	Pre-Amp. (dB)	Cord. Reading (dBµV/m)	FCC 15.247		Comments	Power setting
			Height (cm)	Polarity (H/V)	Factor (dB/m)				Limit (dBµV/m)	Margin (dB)		
High channel 926.9 MHz measured at 3 meters 300kbps												
1853.8	61.79	142	100	H	27.77	3.36	27.73	65.19		65.19	Peak	112=60
1853.8	60.89	172	100	V	27.77	3.36	27.73	64.29		64.29	Peak	112=60
2780.7	34	0	100	V	29.26	4.2	27.81	39.65	74	-34.35	Peak	112=60
2780.7	22	0	100	V	29.26	4.2	27.81	27.65	54	-26.35	Ave	112=60
2780.7	34	0	100	H	29.26	4.2	27.81	39.65	74	-34.35	Peak	112=60
2780.7	22	0	100	H	29.26	4.2	27.81	27.65	54	-26.35	Ave	112=60
3707.6	40.48	10	119	V	32.07	4.93	27.96	49.52	74	-24.48	Peak	112=60
3707.6	36.5	10	119	V	32.07	4.93	27.96	45.54	54	-8.46	Ave	112=60
3707.6	44.17	215	187	H	32.07	4.93	27.96	53.21	74	-20.79	Peak	112=60
3707.6	42.13	215	187	H	32.07	4.93	27.96	51.17	54	-2.83	Ave	112=60

6 dBi 100 kbps



Company Name: Silver Spring Networks
 Product Type: Board
 Project Number: T1212111
 Tester: Wei Sun
 Date: 2012-12-11

FCC 15 C in 5 M Chamber 2 at 3 meters distance
 Notes: Standard 6 dBi antenna, MAC: 300049 (RFFM6903) Part No.: 170-0227-00R12

Frequency (MHz)	S.A. Reading (dBµV)	Azimuth (degrees)	Test Antenna			Cable Loss (dB)	Pre-Amp. (dB)	Cord. Reading (dBµV/m)	FCC 15.247		Comments	Power setting
			Height (cm)	Polarity (H/V)	Factor (dB/m)				Limit (dBµV/m)	Margin (dB)		
Low channel 902.3 MHz measured at 3 meters 300kbps												
1804.6	66.43	154	100	H	27.2	3.37	27.67	69.33		69.33	Peak	112=50
1804.6	68.87	183	100	V	27.2	3.37	27.67	71.77		71.77	Peak	112=50
2706.9	40.38	219	100	V	29.21	4.09	27.85	45.83	74	-28.17	Peak	112=50
2706.9	46.16	219	100	V	29.21	4.09	27.85	51.61	54	-2.39	Ave	112=50
2706.9	49.56	237	151	H	29.21	4.09	27.85	55.01	74	-18.99	Peak	112=50
2706.9	47.95	237	151	H	29.21	4.09	27.85	53.4	54	-0.6	Ave	112=50
3609.2	39.47	181	100	V	31.54	4.78	27.96	47.83	74	-26.17	Peak	112=50
3609.2	33.19	181	100	V	31.54	4.78	27.96	41.55	54	-12.45	Ave	112=50
3609.2	38.89	221	131	H	31.54	4.78	27.96	47.25	74	-26.75	Peak	112=50
3609.2	31.68	221	131	H	31.54	4.78	27.96	40.04	54	-13.96	Ave	112=50

Frequency (MHz)	S.A. Reading (dBµV)	Azimuth (degrees)	Test Antenna			Cable Loss (dB)	Pre-Amp. (dB)	Cord. Reading (dBµV/m)	FCC 15.247		Comments	Power setting
			Height (cm)	Polarity (H/V)	Factor (dB/m)				Limit (dBµV/m)	Margin (dB)		
Middle channel 914.6 MHz measured at 3 meters 300kbps												
1829.2	66.44	141	127	H	27.2	3.37	27.68	69.33		69.33	Peak	112=60
1829.2	64.46	189	100	V	27.2	3.37	27.68	67.35		67.35	Peak	112=60
2743.8	41.81	221	100	V	29.21	4.1	27.83	47.29	74	-26.71	Peak	112=60
2743.8	36.79	221	100	V	29.21	4.1	27.83	42.27	54	-11.73	Ave	112=60
2743.8	42.82	214	126	H	29.21	4.1	27.83	48.3	74	-25.7	Peak	112=60
2743.8	38.71	214	126	H	29.21	4.1	27.83	44.19	54	-9.81	Ave	112=60
3658.4	39.5	174	100	V	32.07	4.77	27.96	48.38	74	-25.62	Peak	112=60
3658.4	34.38	174	100	V	32.07	4.77	27.96	43.26	54	-10.74	Ave	112=60
3658.4	42.22	221	180	H	32.07	4.77	27.96	51.1	74	-22.9	Peak	112=60
3658.4	39.02	221	180	H	32.07	4.77	27.96	47.9	54	-6.1	Ave	112=60

Frequency (MHz)	S.A. Reading (dBµV)	Azimuth (degrees)	Test Antenna			Cable Loss (dB)	Pre-Amp. (dB)	Cord. Reading (dBµV/m)	FCC 15.247		Comments	Power setting
			Height (cm)	Polarity (H/V)	Factor (dB/m)				Limit (dBµV/m)	Margin (dB)		
High channel 926.9 MHz measured at 3 meters 300kbps												
1853.8	61.79	142	100	H	27.77	3.36	27.73	65.19		65.19	Peak	112=60
1853.8	60.89	172	100	V	27.77	3.36	27.73	64.29		64.29	Peak	112=60
2780.7	34	0	100	V	29.26	4.2	27.81	39.65	74	-34.35	Peak	112=60
2780.7	22	0	100	V	29.26	4.2	27.81	27.65	54	-26.35	Ave	112=60
2780.7	34	0	100	H	29.26	4.2	27.81	39.65	74	-34.35	Peak	112=60
2780.7	22	0	100	H	29.26	4.2	27.81	27.65	54	-26.35	Ave	112=60
3707.6	40.48	10	119	V	32.07	4.93	27.96	49.52	74	-24.48	Peak	112=60
3707.6	36.5	10	119	V	32.07	4.93	27.96	45.54	54	-8.46	Ave	112=60
3707.6	44.17	215	187	H	32.07	4.93	27.96	53.21	74	-20.79	Peak	112=60
3707.6	42.13	215	187	H	32.07	4.93	27.96	51.17	54	-2.83	Ave	112=60

6 dBi antenna 300 kbps



Company Name: Silver Spring Networks
 Product Type: Board
 Project Number:T1212111
 Tester: Wei Sun
 Date: 2012-12-11

FCC 15 C in 5 M Chamber 2 at 3 meters distance

Notes: Standard 6 dBi antenna, MAC: 300049 (RFFM6903) Part No. :170-0227-00R12

Frequency (MHz)	S.A. Reading (dBuV)	Azimuth (degrees)	Test Antenna			Cable Loss (dB)	Pre-Amp. (dB)	Cord. Reading (dBuV/m)	FCC 15.247		Comments	Power setting
			Height (cm)	Polarity (H/V)	Factor (dB/m)				Limit (dBuV/m)	Margin (dB)		
Low channel 902.3 MHz measured at 3 meters 300kbps												
1804.6	66.43	154	100	H	27.2	3.37	27.67	69.33		69.33	Peak	112=50
1804.6	68.87	183	100	V	27.2	3.37	27.67	71.77		71.77	Peak	112=50
2706.9	40.38	219	100	V	29.21	4.09	27.85	45.83	74	-28.17	Peak	112=50
2706.9	46.16	219	100	V	29.21	4.09	27.85	51.61	54	-2.39	Ave	112=50
2706.9	49.56	237	151	H	29.21	4.09	27.85	55.01	74	-18.99	Peak	112=50
2706.9	47.95	237	151	H	29.21	4.09	27.85	53.4	54	-0.6	Ave	112=50
3609.2	39.47	181	100	V	31.54	4.78	27.96	47.83	74	-26.17	Peak	112=50
3609.2	33.19	181	100	V	31.54	4.78	27.96	41.55	54	-12.45	Ave	112=50
3609.2	38.89	221	131	H	31.54	4.78	27.96	47.25	74	-26.75	Peak	112=50
3609.2	31.68	221	131	H	31.54	4.78	27.96	40.04	54	-13.96	Ave	112=50

Frequency (MHz)	S.A. Reading (dBuV)	Azimuth (degrees)	Test Antenna			Cable Loss (dB)	Pre-Amp. (dB)	Cord. Reading (dBuV/m)	FCC 15.247		Comments	Power setting
			Height (cm)	Polarity (H/V)	Factor (dB/m)				Limit (dBuV/m)	Margin (dB)		
Middle channel 914.6 MHz measured at 3 meters 300kbps												
1829.2	66.44	141	127	H	27.2	3.37	27.68	69.33		69.33	Peak	112=60
1829.2	64.46	189	100	V	27.2	3.37	27.68	67.35		67.35	Peak	112=60
2743.8	41.81	221	100	V	29.21	4.1	27.83	47.29	74	-26.71	Peak	112=60
2743.8	36.79	221	100	V	29.21	4.1	27.83	42.27	54	-11.73	Ave	112=60
2743.8	42.82	214	126	H	29.21	4.1	27.83	48.3	74	-25.7	Peak	112=60
2743.8	38.71	214	126	H	29.21	4.1	27.83	44.19	54	-9.81	Ave	112=60
3658.4	39.5	174	100	V	32.07	4.77	27.96	48.38	74	-25.62	Peak	112=60
3658.4	34.38	174	100	V	32.07	4.77	27.96	43.26	54	-10.74	Ave	112=60
3658.4	42.22	221	180	H	32.07	4.77	27.96	51.1	74	-22.9	Peak	112=60
3658.4	39.02	221	180	H	32.07	4.77	27.96	47.9	54	-6.1	Ave	112=60

Frequency (MHz)	S.A. Reading (dBuV)	Azimuth (degrees)	Test Antenna			Cable Loss (dB)	Pre-Amp. (dB)	Cord. Reading (dBuV/m)	FCC 15.247		Comments	Power setting
			Height (cm)	Polarity (H/V)	Factor (dB/m)				Limit (dBuV/m)	Margin (dB)		
High channel 926.9 MHz measured at 3 meters 300kbps												
1853.8	61.79	142	100	H	27.77	3.36	27.73	65.19		65.19	Peak	112=60
1853.8	60.89	172	100	V	27.77	3.36	27.73	64.29		64.29	Peak	112=60
2780.7	34	0	100	V	29.26	4.2	27.81	39.65	74	-34.35	Peak	112=60
2780.7	22	0	100	V	29.26	4.2	27.81	27.65	54	-26.35	Ave	112=60
2780.7	34	0	100	H	29.26	4.2	27.81	39.65	74	-34.35	Peak	112=60
2780.7	22	0	100	H	29.26	4.2	27.81	27.65	54	-26.35	Ave	112=60
3707.6	40.48	10	119	V	32.07	4.93	27.96	49.52	74	-24.48	Peak	112=60
3707.6	36.5	10	119	V	32.07	4.93	27.96	45.54	54	-8.46	Ave	112=60
3707.6	44.17	215	187	H	32.07	4.93	27.96	53.21	74	-20.79	Peak	112=60
3707.6	42.13	215	187	H	32.07	4.93	27.96	51.17	54	-2.83	Ave	112=60

Radiated Emissions Below 1 GHZ

All emissions from transmitter more than 20 dB limits.

20 dB Bandwidth

LIMIT

15.247(a) i: 500 kHz maximum bandwidth allowed.

TEST PROCEDURE

The TX output is connected to a spectrum analyzer. The OCC BW function is activated.

RBW > 1% of 20 dB BW

VBW > RBW

Detector: PEAK

RESULTS

No non-compliance noted:

100 kbps

Channel	Frequency (MHz)	20 dB Bandwidth,
Low	902.3	207.2
Middle	914.6	206.8
High	926.9	206.3

300 kbps

Channel	Frequency (MHz)	20 dB
Low	902.4	207
Middle	914.6	206.9
High	926.8	206.4

100 kbps

20 dB BANDWIDTH LOW CHANNEL

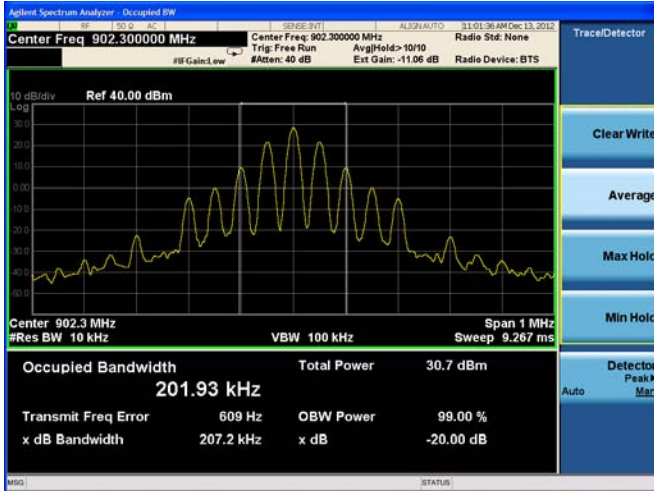

20 dB BANDWIDTH HIGH CHANNEL

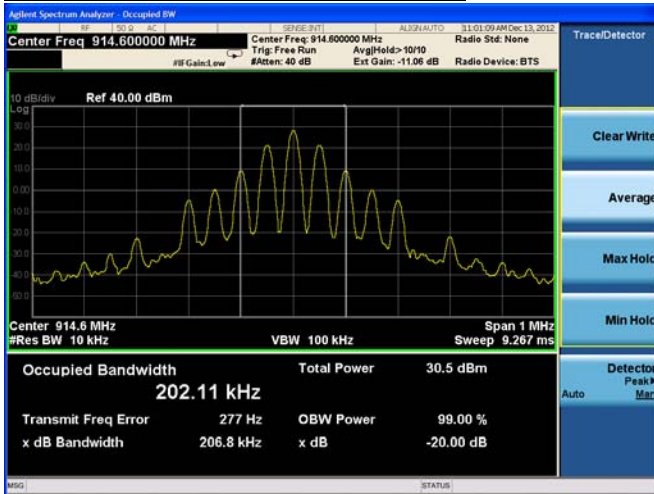

20 dB BANDWIDTH HIGH CHANNEL

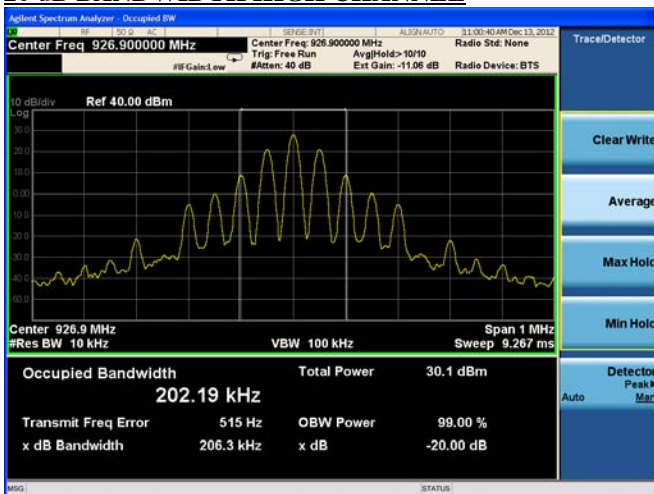

300 kbps

20 dB BANDWIDTH LOW CHANNEL

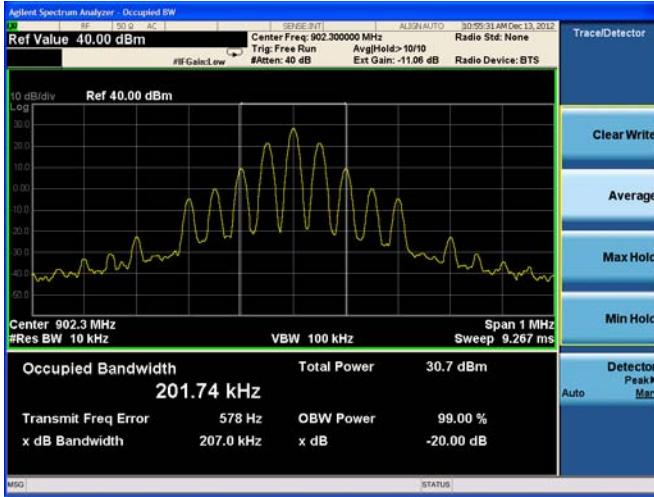

20 dB BANDWIDTH MID CHANNEL

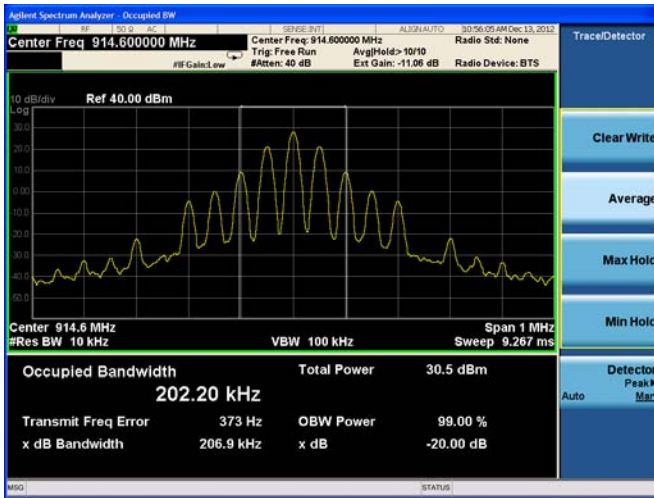

20 dB BANDWIDTH HIGH CHANNEL

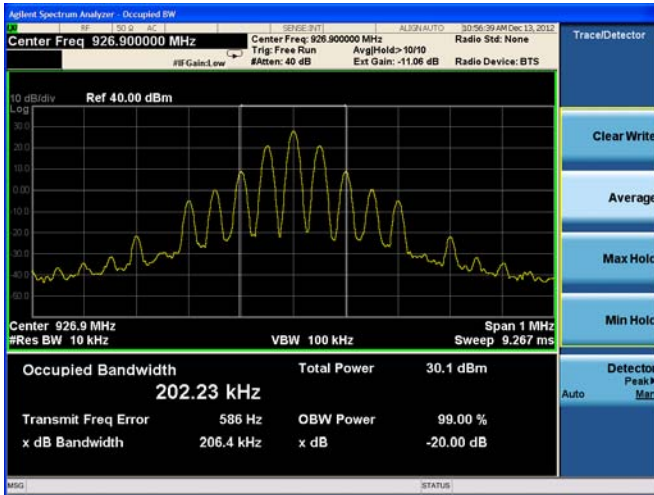

99% Occupied Bandwidth

LIMIT

None, for information purposes only.

The TX output is connected to a spectrum analyzer. The OCC BW function is activated.

RBW > 1% of SPAN

VBW > 3xRBW

Detector: SAMPLE

RESULTS

No non-compliance noted.

Plots below show worst-case occupied bandwidth for each channel separation.

Channel Separation	Worst-case Occupied BW
100 kbps	202.1 kHz
300 kbps	202 kHz

99% BW, 100 kbps

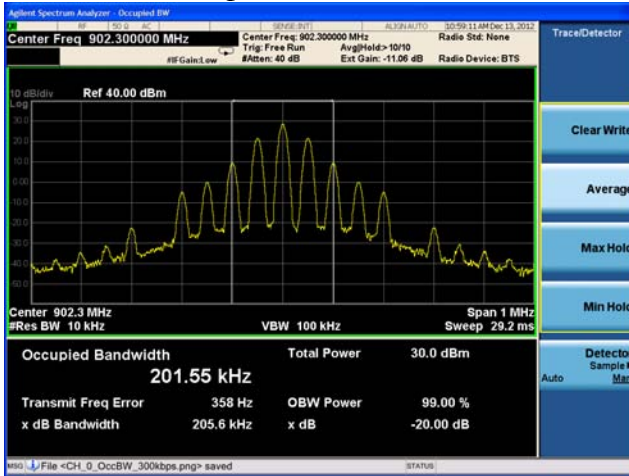

99% BW, 100 kbps

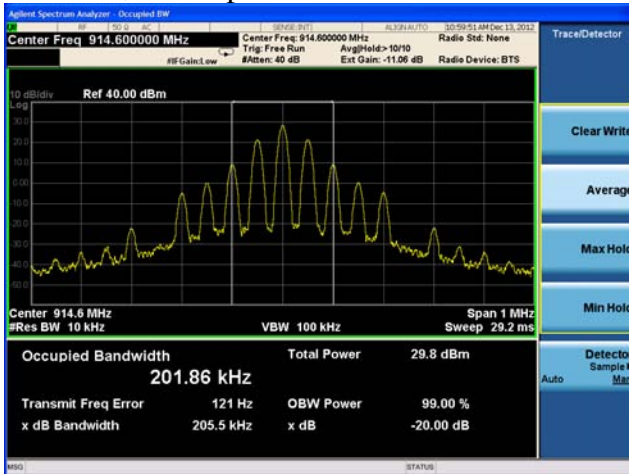

99% BW, 100 kbps

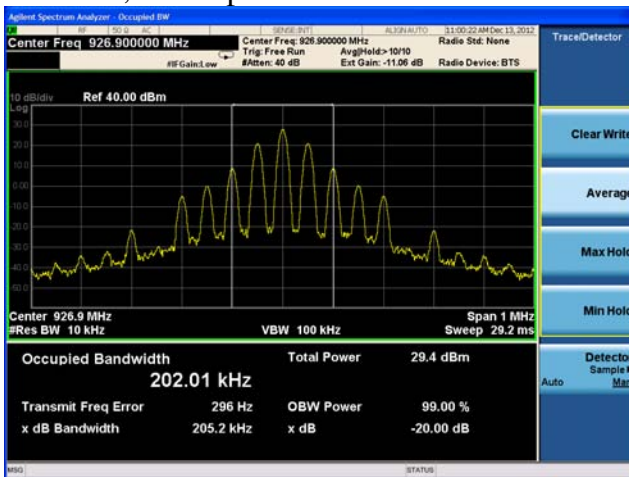

99% BW, 300 kbps

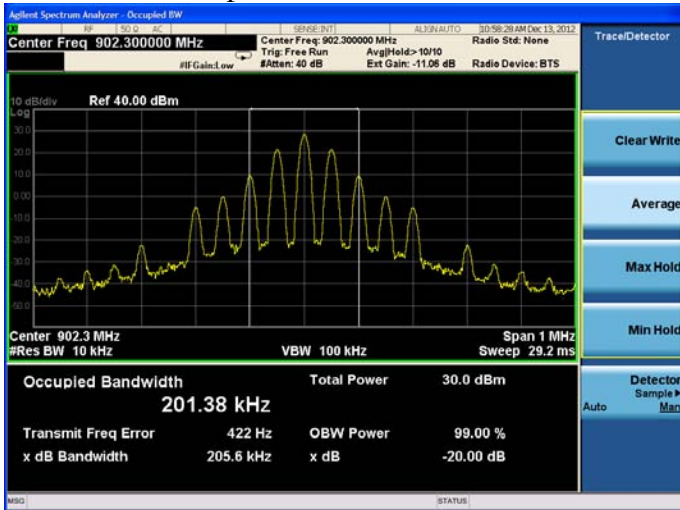

99% BW, 300 kbps

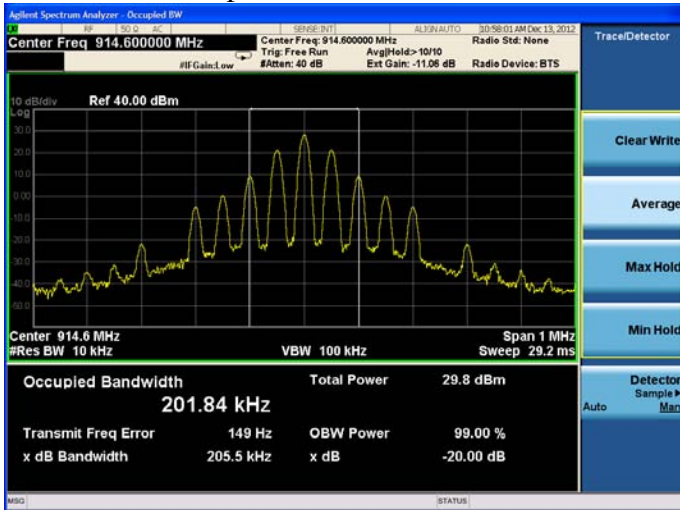

99% BW, 300 kbps

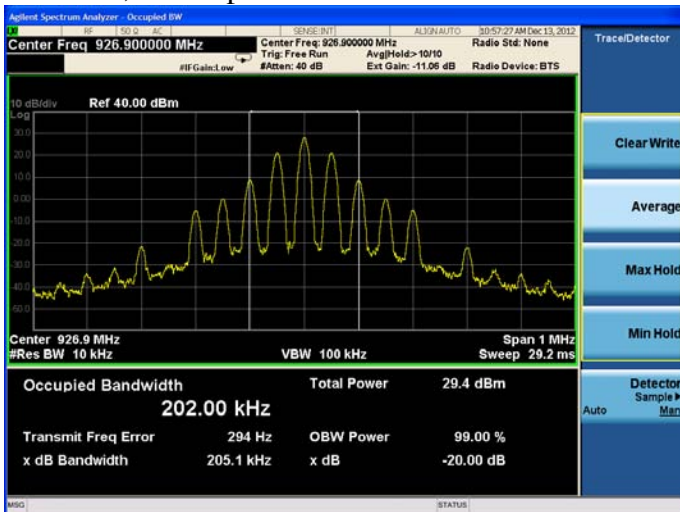

HOPPING FREQUENCY SEPARATION

LIMIT

§15.247 (a) (1) Frequency hopping systems shall have hopping channel carrier frequencies separated by a minimum of 25 kHz or the 20 dB bandwidth of the hopping channel, whichever is greater.

TEST PROCEDURE

The transmitter output is connected to a spectrum analyzer. The RBW is set to 100 kHz and the VBW is set to 300 kHz. The sweep time is coupled.

RESULTS

No non-compliance noted:

Channel separation: 300 kHz
Maximum 20 dB BW: 207 kHz

HOPPING FREQUENCY SEPARATION

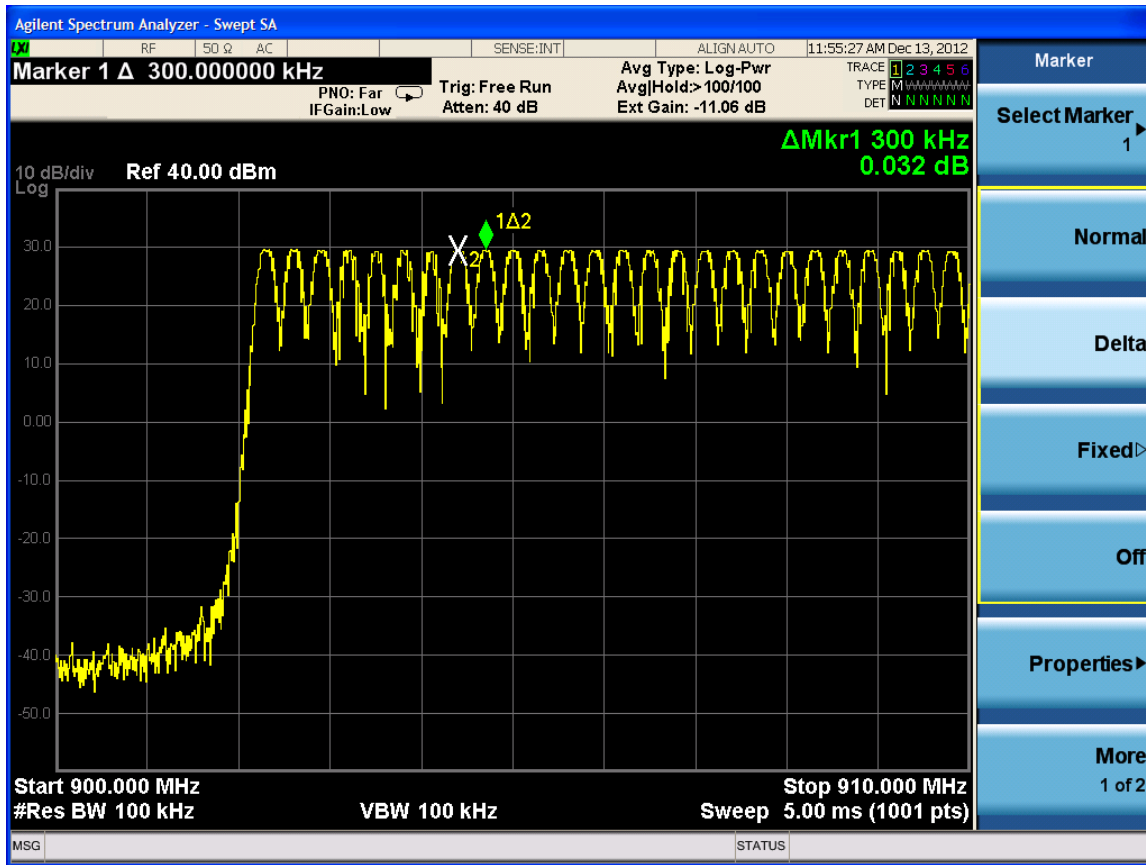

NUMBER OF HOPPING CHANNELS

LIMIT

§15.247 (a) (1) (i) For frequency hopping systems operating in the 902–928 MHz band: if the 20 dB bandwidth of the hopping channel is less than 250 kHz, the system shall use at least 50 hopping frequencies and the average time of occupancy on any frequency shall not be greater than 0.4 seconds within a 20 second period; if the 20 dB bandwidth of the hopping channel is 250 kHz or greater, the system shall use at least 25 hopping frequencies and the average time of occupancy on any frequency shall not be greater than 0.4 seconds within a 10 second period. The maximum allowed 20 dB bandwidth of the hopping channel is 500 kHz.

TEST PROCEDURE

The transmitter output is connected to a spectrum analyzer. The span is set to cover the entire authorized band, in either a single sweep or in multiple contiguous sweeps. The RBW is set to 3 % of the span. The analyzer is set to Max Hold.

RESULTS

No non-compliance noted: 83 hopping channels.

NUMBER OF HOPPING CHANNELS

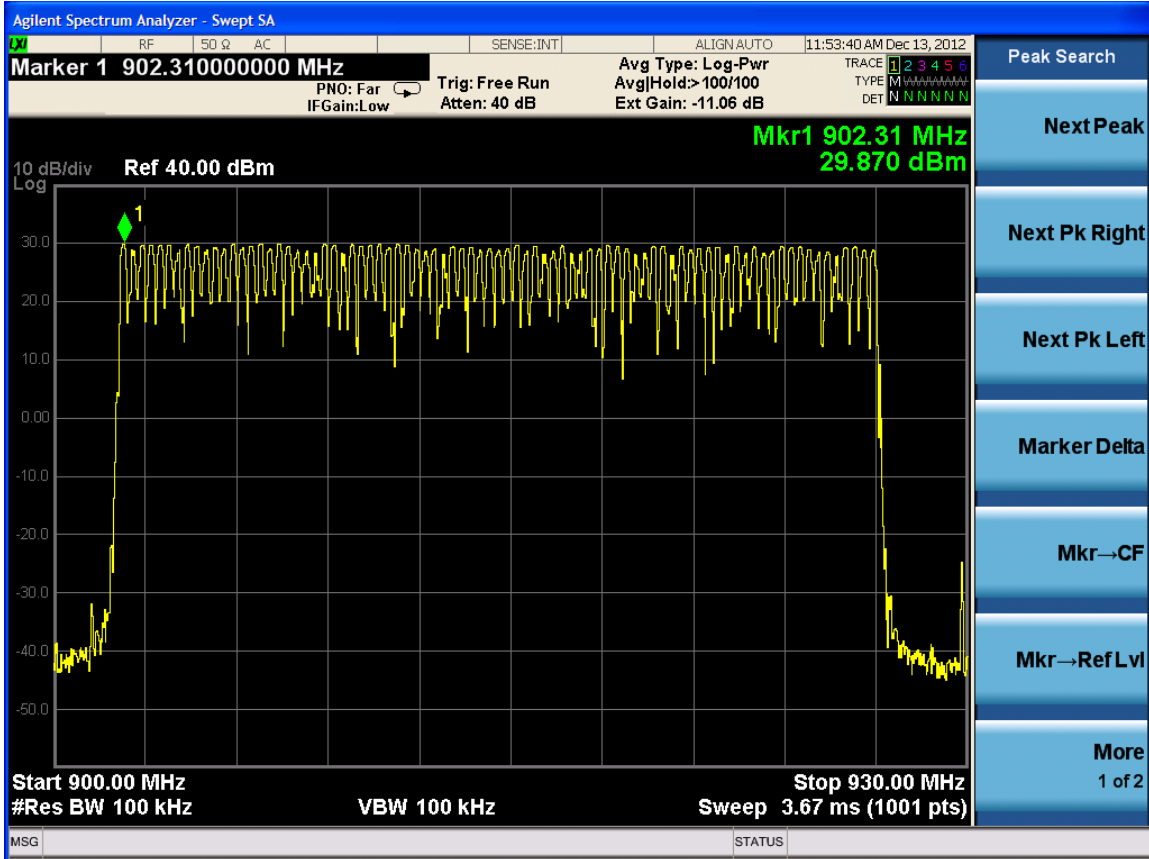

AVERAGE TIME OF OCCUPANCY

LIMIT

§15.247 (a) (1) (i) For frequency hopping systems operating in the 902–928 MHz band: if the 20 dB bandwidth of the hopping channel is less than 250 kHz, the system shall use at least 50 hopping frequencies and the average time of occupancy on any frequency shall not be greater than 0.4 seconds within a 20 second period; if the 20 dB bandwidth of the hopping channel is 250 kHz or greater, the system shall use at least 25 hopping frequencies and the average time of occupancy on any frequency shall not be greater than 0.4 seconds within a 10 second period. The maximum allowed 20 dB bandwidth of the hopping channel is 500 kHz.

TEST PROCEDURE

The transmitter output is connected to a spectrum analyzer. The span is set to 0 Hz, centered on a single, selected hopping channel. The width of a single pulse is measured in a fast scan. The number of pulses is measured in a 20 second scan, to enable resolution of each occurrence.

RESULTS

No non-compliance noted:

Hop duration msec	Total hops/20 sec	Average time of occupancy msec	Limit in 20 sec msec
18	12	216	400

Hop duration

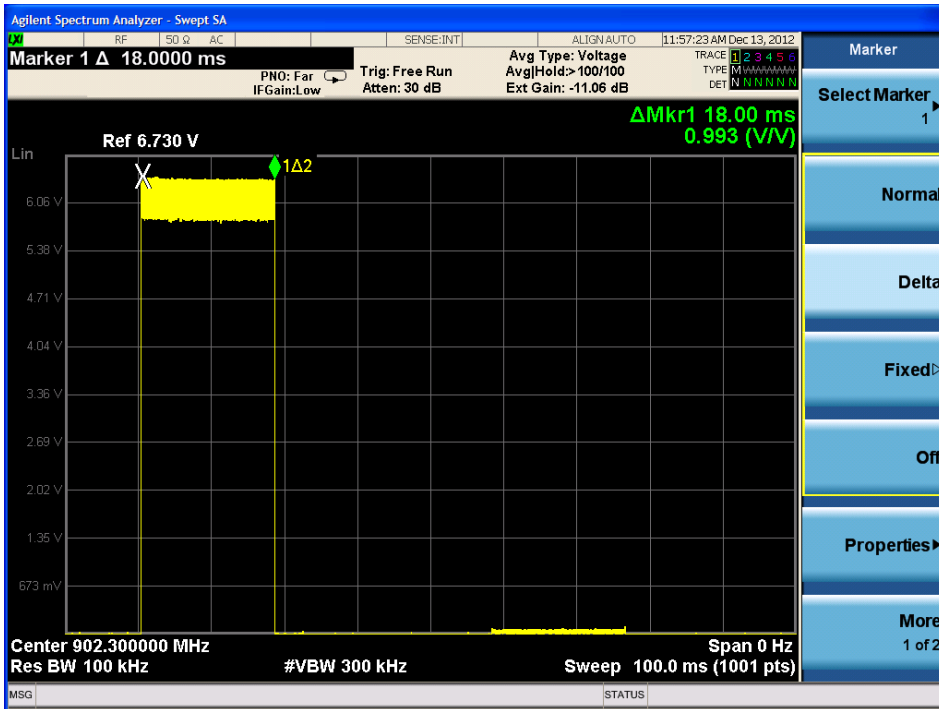

NUMBER OF PULSES IN 20 SECOND OBSERVATION PERIOD

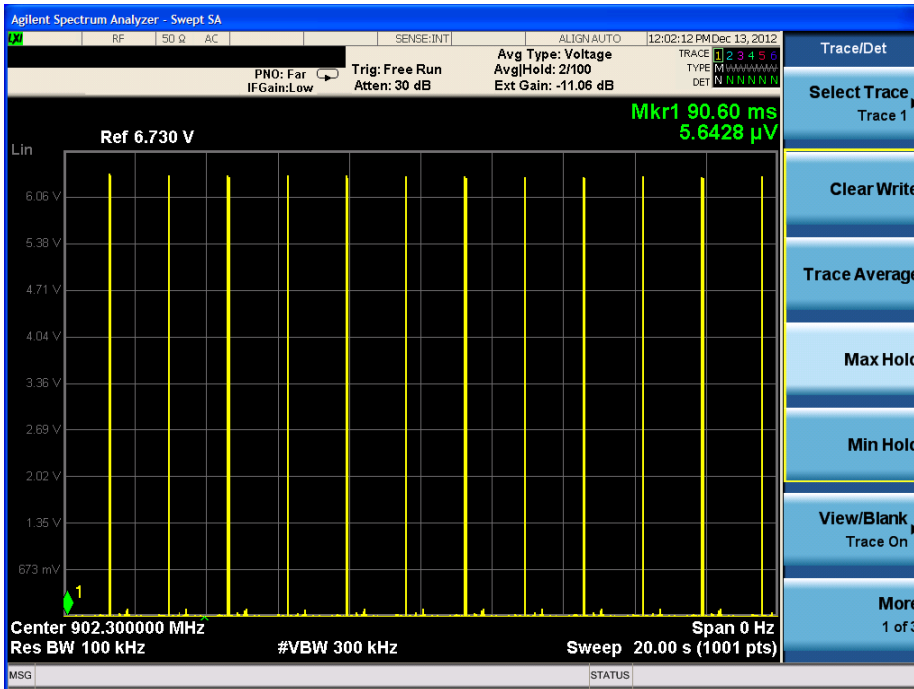

PEAK OUTPUT POWER

PEAK POWER LIMIT

§15.247 (b) The maximum peak output power of the intentional radiator shall not exceed the following:

§15.247 (b) (2) For frequency hopping systems operating in the 902-928 MHz band, employing at least 50 hopping channels: 1 watt; and employing less than 50 hopping channels, but at least 25 hopping channels: 0.25 watt.

§15.247 (b) (4) Except as shown in paragraphs (b)(3) (i), (ii) and (iii) of this section, if transmitting antennas of directional gain greater than 6 dBi are used the peak output power from the intentional radiator shall be reduced below the stated values in paragraphs (b)(1) or (b)(2) of this section, as appropriate, by the amount in dB that the directional gain of the antenna exceeds 6 dBi.

The maximum antenna gain is 6 dBi, therefore the power limit is 30 dBm.

TEST PROCEDURE

The transmitter output is connected to a spectrum analyzer through appropriate attenuation. Analyzer settings:

RBW > EBW
VBW = 3xRBW
Detector: PEAK

RESULTS

No non-compliance noted:

Channel	Frequency	P out
Low	902.3	29.95
Mid	914.9	29.78
High	926.9	29.34

OUTPUT POWER LOW CHANNEL

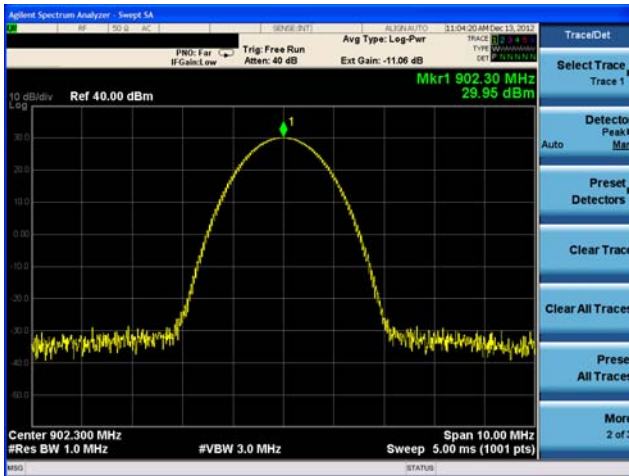

OUTPUT POWER MID CHANNEL

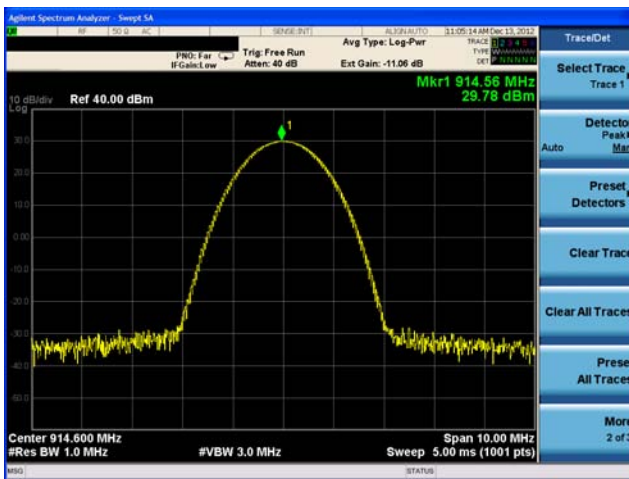

OUTPUT POWER HIGH CHANNEL

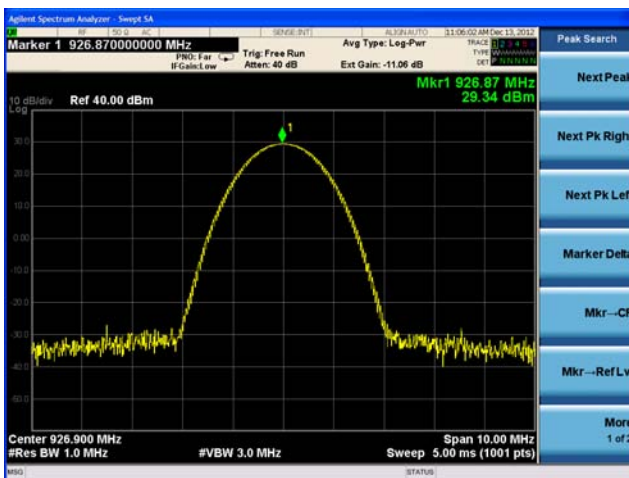

MAXIMUM PERMISSIBLE EXPOSURE

LIMITS

§1.1310 The criteria listed in Table 1 shall be used to evaluate the environmental impact of human exposure to radio-frequency (RF) radiation as specified in §1.1307(b), except in the case of portable devices which shall be evaluated according to the provisions of §2.1093 of this chapter.

TABLE 1—LIMITS FOR MAXIMUM PERMISSIBLE EXPOSURE (MPE)

Frequency range (MHz)	Electric field strength (V/m)	Magnetic field strength (A/m)	Power density (mW/cm ²)	Averaging time (minutes)
(A) Limits for Occupational/Controlled Exposures				
0.3–3.0	614	1.63	*(100)	6
3.0–30	1842/f	4.89/f	*(900/f ²)	6
30–300	61.4	0.163	1.0	6
300–1500	f/300	6
1500–100,000	5	6
(B) Limits for General Population/Uncontrolled Exposure				
0.3–1.34	614	1.63	*(100)	30
1.34–30	824/f	2.19/f	*(180/f ²)	30

TABLE 1—LIMITS FOR MAXIMUM PERMISSIBLE EXPOSURE (MPE)—Continued

Frequency range (MHz)	Electric field strength (V/m)	Magnetic field strength (A/m)	Power density (mW/cm ²)	Averaging time (minutes)
30–300	27.5	0.073	0.2	30
300–1500	f/1500	30
1500–100,000	1.0	30

f = frequency in MHz

* = Plane-wave equivalent power density

NOTE 1 TO TABLE 1: Occupational/controlled limits apply in situations in which persons are exposed as a consequence of their employment provided those persons are fully aware of the potential for exposure and can exercise control over their exposure. Limits for occupational/controlled exposure also apply in situations when an individual is transient through a location where occupational/controlled limits apply provided he or she is made aware of the potential for exposure.

NOTE 2 TO TABLE 1: General population/uncontrolled exposures apply in situations in which the general public may be exposed, or in which persons that are exposed as a consequence of their employment may not be fully aware of the potential for exposure or can not exercise control over their exposure.

CALCULATIONS

Given

$$E = \sqrt{(30 * P * G) / d}$$

and

$$S = E^2 / 3770$$

where

E = Field Strength in Volts/meter

P = Power in Watts

G = Numeric antenna gain

d = Distance in meters

S = Power Density in milliwatts/square centimeter

Combining equations and rearranging the terms to express the distance as a function of the remaining variables yields:

$$d = \sqrt{((30 * P * G) / (3770 * S))}$$

Changing to units of Power to mW and Distance to cm, using:

$$P \text{ (mW)} = P \text{ (W)} / 1000 \text{ and}$$

$$d \text{ (cm)} = 100 * d \text{ (m)}$$

yields

$$d = 100 * \sqrt{((30 * (P / 1000) * G) / (3770 * S))}$$

$$d = 0.282 * \sqrt{(P * G / S)}$$

where

d = distance in cm

P = Power in mW

G = Numeric antenna gain

S = Power Density in mW/cm²

Substituting the logarithmic form of power and gain using:

$$P \text{ (mW)} = 10^{(P \text{ (dBm)} / 10)} \text{ and}$$

$$G \text{ (numeric)} = 10^{(G \text{ (dBi)} / 10)}$$

yields

$$d = 0.282 * 10^{((P + G) / 20)} / \sqrt{S} \quad \text{Equation (1)}$$

where

d = MPE distance in cm

P = Power in dBm

G = Antenna Gain in dBi

S = Power Density Limit in mW/cm²

Equation (1) and the measured peak power is used to calculate the MPE distance.

LIMITS

From §1.1310 Table 1 (B), $S = 0.6 \text{ mW/cm}^2$

RESULTS

No non-compliance noted:

Worst-case RF exposure condition is for internal antenna operation as the gain is higher

RESULTS

Maximum RFx. Limit, mW/cm ²	Maximum Power, dBm	Antenna gain dBi	MPE Distance, cm	RFx at 20cm mW/cm ²
0.6	29.95	6.00	22.8	0.78

NOTE: For mobile or fixed location transmitters, the minimum separation distance is 20 cm, even if calculations indicate that the MPE distance would be less.

CONDUCTED SPURIOUS EMISSIONS

LIMITS

§15.247 (c) In any 100 kHz bandwidth outside the frequency band in which the spread spectrum intentional radiator is operating, the radio frequency power that is produced by the intentional radiator shall be at least 20 dB below that in the 100 kHz bandwidth within the band that contains the highest level of the desired power, based on either an RF conducted or a radiated measurement. Attenuation below the general limits specified in §15.209(a) is not required. In addition, radiated emissions which fall in the restricted bands, as defined in §15.205(a), must also comply with the radiated emission limits specified in §15.209(a) (see §15.205(c)).

TEST PROCEDURE

The transmitter output is connected to a spectrum analyzer. The resolution bandwidth is set to 100 kHz. The video bandwidth is set to 100 kHz.

The spectrum from 30 MHz to 10 GHz is investigated with the transmitter set to the lowest, middle, and highest channels.

Testing was performed for worst-case operation: 300 kbps

No non-compliance noted:

SPURIOUS EMISSIONS, LOW CHANNEL

Band Edge, hopping

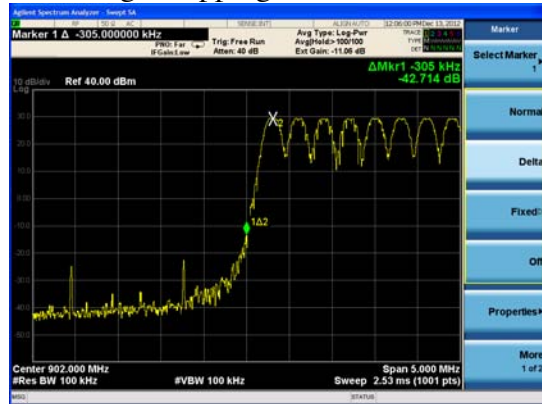

Band Edge, non-hopping

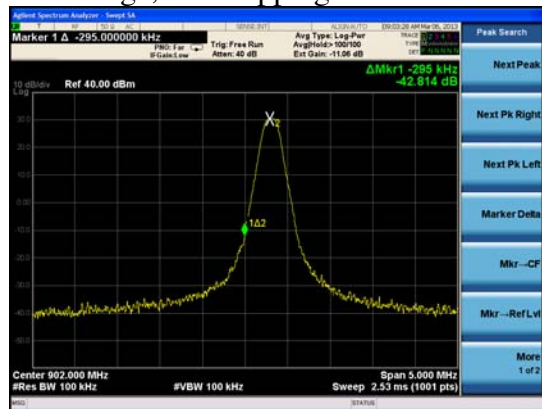

Spurious to 10th harmonic

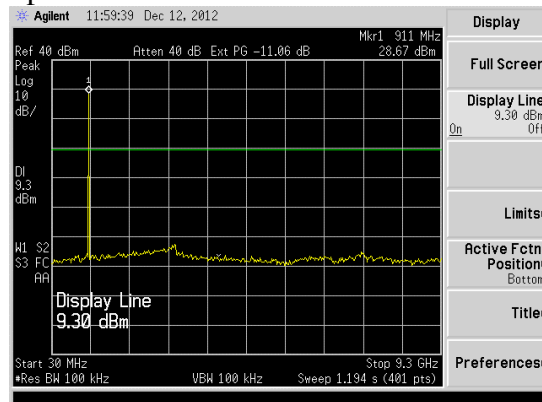

SPURIOUS EMISSIONS, MID CHANNEL

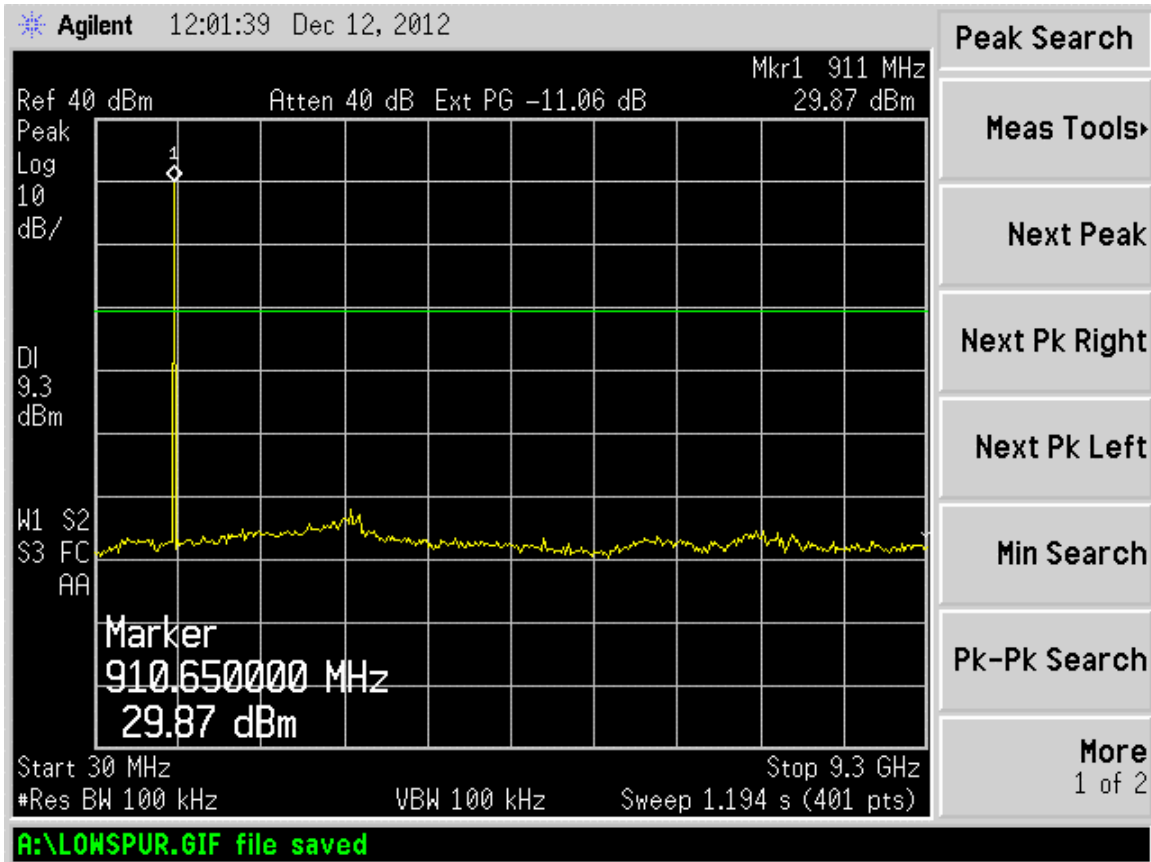

SPURIOUS EMISSIONS, HIGH CHANNEL

Band Edge, Hopping

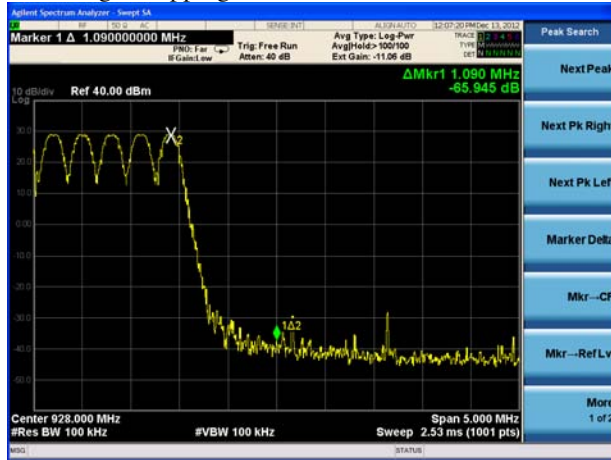

Band Edge, non-hopping

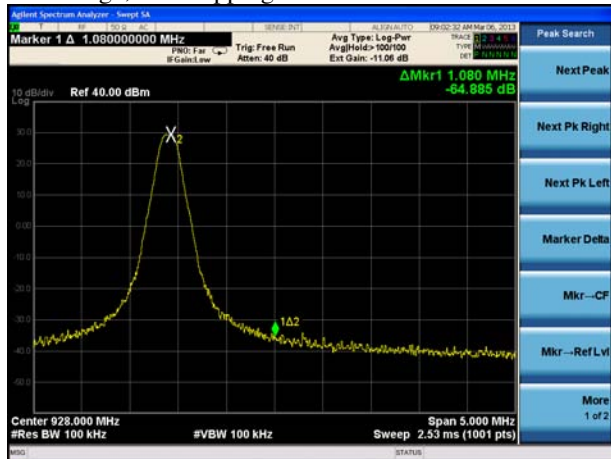

Spurious to 10th harmonic

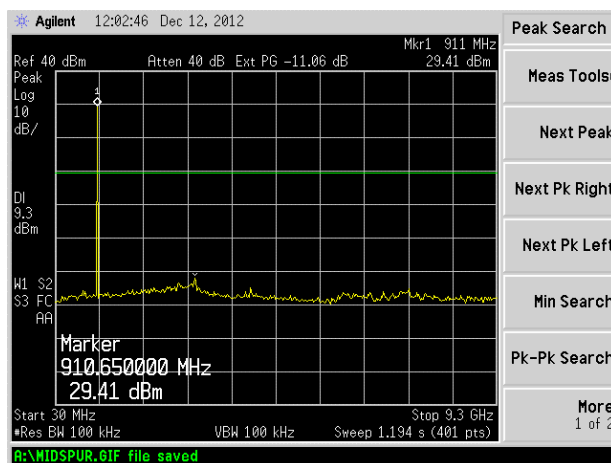

POWERLINE CONDUCTED EMISSIONS

LIMIT

§15.207 (a) Except as shown in paragraphs (b) and (c) of this section, for an intentional radiator that is designed to be connected to the public utility (AC) power line, the radio frequency voltage that is conducted back onto the AC power line on any frequency or frequencies within the band 150 kHz to 30 MHz shall not exceed the limits in the following table, as measured using a 50 μ H/50 ohms line impedance stabilization network (LISN). Compliance with the provisions of this paragraph shall be based on the measurement of the radio frequency voltage between each power line and ground at the power terminal.

The lower limit applies at the boundary between the frequency ranges.

Frequency of Emission (MHz)	Conducted Limit (dBuV)	
	Quasi-peak	Average
0.15-0.5	66 to 56*	56 to 46*
0.5-5	56	46
5-30	60	50

*Decreases with the logarithm of the frequency.

TEST PROCEDURE

The EUT is placed on a non-conducting table 40 cm from the vertical ground plane and 80 cm above the horizontal ground plane. The EUT is configured in accordance with ANSI C63.4.

The resolution bandwidth is set to 9 kHz for both peak detection and quasi-peak detection measurements. Peak detection is used unless otherwise noted as quasi-peak.

Line conducted data is recorded for both NEUTRAL and HOT lines.

RESULTS

No non-compliance noted:



Company Name: Silver Spring Networks
 Product Type: Board
 Project Number: T1212111
 Tester: Wei Sun
 Date: 2012-12-13
 FCC 15 C in 5 M Chamber 2 at 3 meters distance
 Notes: Standard 3 dBi antenna, MAC: 300049 (RFFM6903) Part No. :170-0227-00R12, 300kbps data rate, 112=60, Low Channel

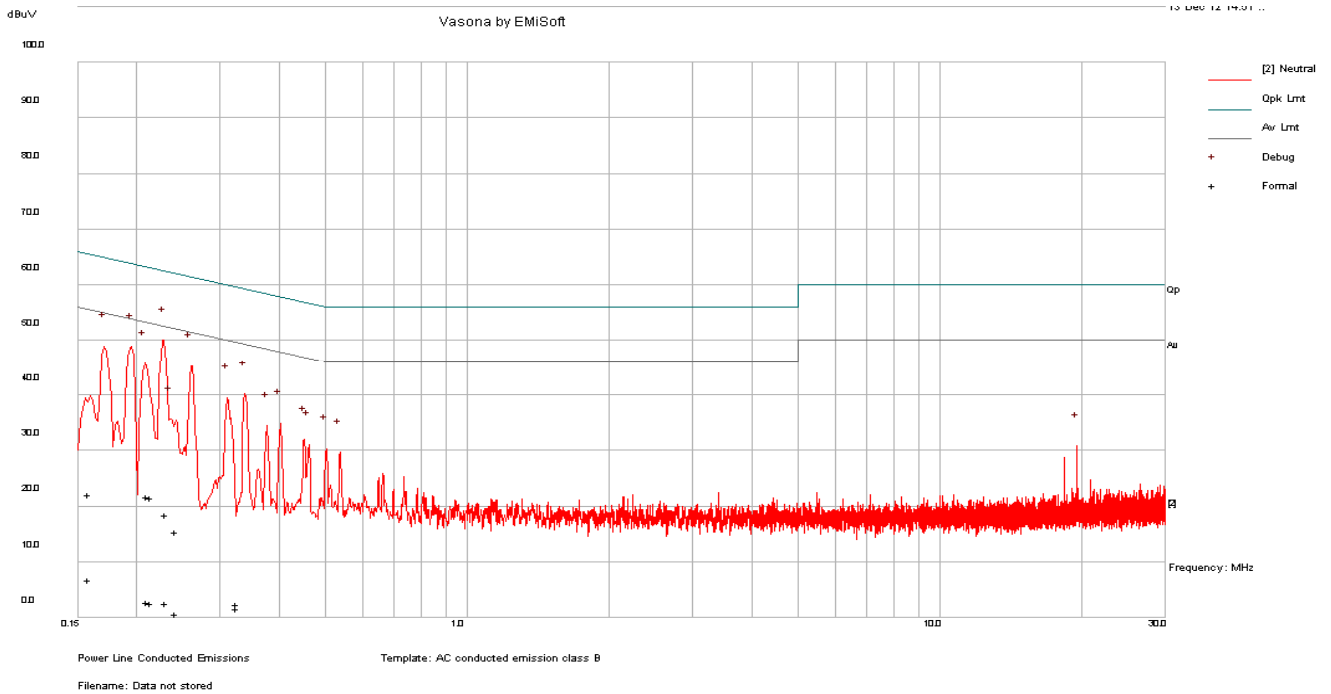

Vasona Data : Formally Assessed Peaks

No	Frequency MHz	Raw dBuV	Cable Loss	Factors	dB	Level	dBuV	Measurement	Line	Limit dBuV	Margin dB	Pass /Fail	Comments
1	0.231627	7.88	9.7	0.98	18.55	Quasi Peak	Neutral	62.39	-43.84	Pass			
2	0.210648	11.14	9.73	0.9	21.77	Quasi Peak	Neutral	63.18	-41.41	Pass			
3	0.159145	10.87	10.36	0.91	22.13	Quasi Peak	Neutral	65.51	-43.37	Pass			
4	0.243307	4.7	9.68	1.02	15.4	Quasi Peak	Neutral	61.98	-46.58	Pass			
5	0.214923	10.93	9.73	0.92	21.57	Quasi Peak	Neutral	63.01	-41.44	Pass			
6	0.32722	-8.63	9.62	0.59	1.58	Quasi Peak	Neutral	59.52	-57.94	Pass			
7	0.231627	-8.01	9.7	0.98	2.67	Average	Neutral	52.39	-49.72	Pass			
8	0.210648	-7.88	9.73	0.9	2.75	Average	Neutral	53.18	-50.43	Pass			
9	0.159145	-4.5	10.36	0.91	6.77	Average	Neutral	55.51	-48.74	Pass			
10	0.243307	-10.11	9.68	1.02	0.59	Average	Neutral	51.98	-51.39	Pass			
11	0.214923	-7.98	9.73	0.92	2.66	Average	Neutral	53.01	-50.35	Pass			
12	0.32722	-7.73	9.62	0.59	2.49	Average	Neutral	49.52	-47.03	Pass			

Hot AC Line Conducted Emissions



Company Name: Silver Spring Networks

Product Type: Board

Project Number:T1212111

Tester: Wei Sun

Date: 2012-12-13

FCC 15 C in 5 M Chamber 2 at 3 meters distance

Notes: Standard 3 dBi antenna, MAC: 300049 (RFFM6903) Part No. :170-0227-00R12, 300kbps data rate, 112=60, Low Channel

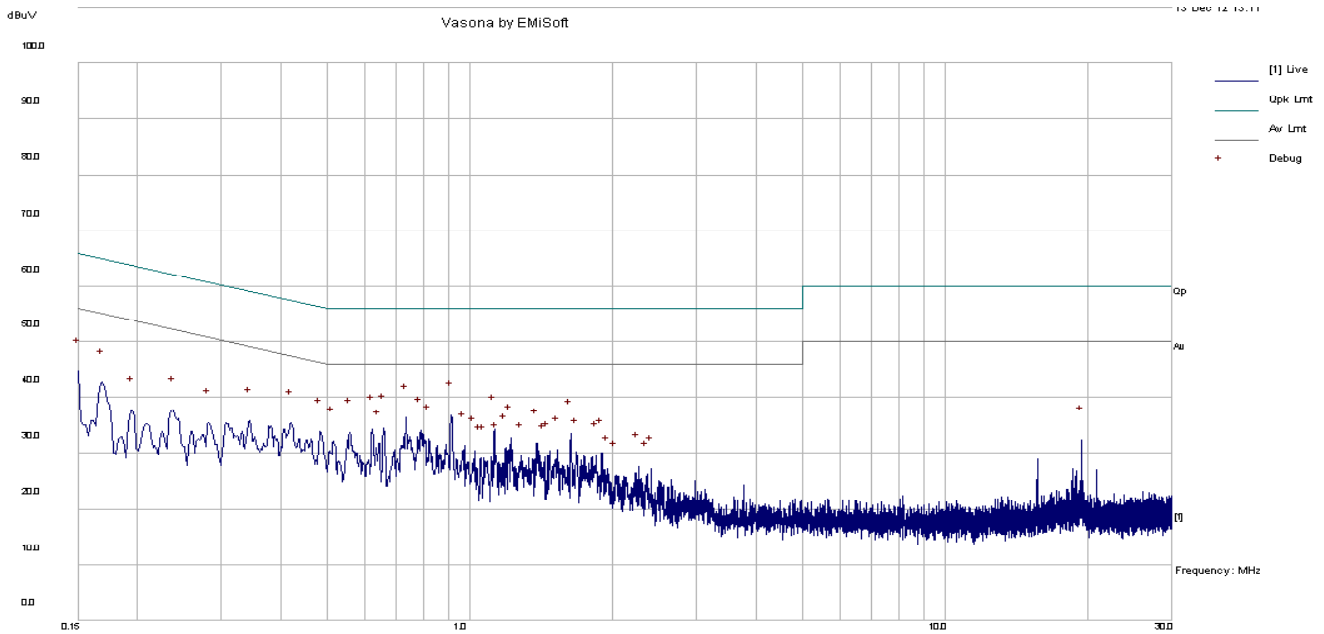

Power Line Conducted Emissions
 Template: AC conducted emission class B
 Filename: Data not stored

Vasona Data : Formally Assessed Peaks

No	Frequency MHz	Raw dBuV	Cable Loss	Factors dB	Level dBuV	Measurement	Line	Limit dBuV	Margin dB	Pass /Fail	Comments
1	0.93027	-7.79	9.67	0.16	2.04	Quasi Peak	Live	56	-53.96	Pass	
2	0.735126	-7.29	9.66	0.17	2.54	Quasi Peak	Live	56	-53.46	Pass	
3	0.150149	22.14	11.76	0.92	34.82	Quasi Peak	Live	65.99	-31.18	Pass	
4	0.675896	-7.18	9.66	0.17	2.64	Quasi Peak	Live	56	-53.36	Pass	
5	1.123605	-7.72	9.67	0.17	2.12	Quasi Peak	Live	56	-53.88	Pass	
6	0.614981	-7.03	9.66	0.18	2.8	Quasi Peak	Live	56	-53.2	Pass	
7	0.93027	-11.24	9.67	0.16	-1.41	Average	Live	46	-47.41	Pass	
8	0.735126	-11.04	9.66	0.17	-1.21	Average	Live	46	-47.21	Pass	
9	0.150149	0.6	11.76	0.92	13.28	Average	Live	55.99	-42.71	Pass	
10	0.675896	-10.96	9.66	0.17	-1.14	Average	Live	46	-47.14	Pass	
11	1.123605	-11.37	9.67	0.17	-1.54	Average	Live	46	-47.54	Pass	
12	0.614981	-10.77	9.66	0.18	-0.93	Average	Live	46	-46.93	Pass	

END OF REPORT

Report Revision History

Revision No.	Revision Description	Pages Revised	Revised by	Date
-	Original issue		T. Cokenias	3 January 2013
1	Add 18-26.5 GHz antenna cal data Add no hop band edge plots, L and H	2,30,32	T. Cokenias	5 March 2013