

Test of Silver Spring Network MicroAP

To: FCC 47 CFR Part 15.247 & IC RSS-210

Test Report Serial No.: SSNT62-U4 Rev A



TEST REPORT

FROM



Test of Silver Spring Network MicroAP

to

To FCC 47 CFR Part 15.247 & IC RSS-210

Test Report Serial No.: SSNT62-U4 Rev A

This report supersedes: NONE

Applicant: Silver Spring Networks
555 Broadway Street
Redwood City
California 94063, USA

Product Function: Micromesh allows machine to machine communication over 900 MHz and/or 2.4 GHz FHSS and transmit data over 3G GSM or CDMA cellular backhaul to utility or network provider. 2.4 GHz home area network paring with other Zigbee devices

Copy No: pdf Issue Date: 13th August 2013

This Test Report is Issued Under the Authority of:

MiCOM Labs, Inc.
440 Boulder Court, Suite 200
Pleasanton, CA 94566 USA
Phone: +1 (925) 462-0304
Fax: +1 (925) 462-0306
www.micomlabs.com



TEST CERTIFICATE #2381.01

MiCOM Labs is an ISO 17025 Accredited Testing Laboratory



Title: Silver Spring Network MicroAP
To: FCC 47 CFR Part 15.247 & IC RSS-210
Serial #: SSNT62-U4 Rev A
Issue Date: 13th August 2013
Page: 3 of 80

This page has been left intentionally blank



TABLE OF CONTENTS

ACCREDITATION, LISTINGS & RECOGNITION	5
TESTING ACCREDITATION	5
RECOGNITION	6
PRODUCT CERTIFICATION	7
TEST RESULT CERTIFICATE	9
1. REFERENCES AND MEASUREMENT UNCERTAINTY	10
1.1. Normative References	10
1.2. Test and Uncertainty Procedures	11
2. PRODUCT DETAILS AND TEST CONFIGURATIONS	12
2.1. Technical Details	12
2.2. Scope of Test Program	13
2.3. Equipment Model(s) and Serial Number(s)	15
2.4. Antenna Details	15
2.5. Cabling and I/O Ports	15
2.6. Test Configurations	16
2.7. Equipment Modifications	16
2.8. Deviations from the Test Standard	16
3. TEST EQUIPMENT CONFIGURATION(S)	17
3.1. Conducted RF Emission Test Set-up	17
3.2. Radiated Spurious Emission Test Set-up > 1 GHz	18
3.3. Digital Emissions Test Set-up (0.03 – 1 GHz)	19
4. TEST SUMMARY	20
5. TEST RESULTS	22
5.1. Device Characteristics	22
5.1.1. <i>Conducted Testing</i>	22
5.1.2. <i>Radiated Emission Testing</i>	36
5.1.3. <i>AC Wireline Conducted Emissions (150 kHz – 30 MHz)</i>	48
6. PHOTOGRAPHS	50
6.1. Conducted Test Setup	50
6.2. Test Setup - Digital Emissions below 1 GHz	51
6.3. Radiated Emissions Test Setup >1 GHz	52
7. TEST EQUIPMENT	53
APPENDIX	54
A. SUPPORTING INFORMATION	54
A.1. CONDUCTED TEST PLOTS	54
A.1.1. <i>6 dB & 99% Bandwidth</i>	55
A.1.2. <i>Peak Output Power</i>	61
A.1.3. <i>Power Spectral Density</i>	67
A.1.4. <i>Conducted Spurious Emissions</i>	73

This test report may be reproduced in full only. The document may only be updated by MiCOM Labs personnel. Any changes will be noted in the Document History section of the report.

ACCREDITATION, LISTINGS & RECOGNITION

TESTING ACCREDITATION

MiCOM Labs, Inc. is an accredited Electrical testing laboratory per the international standard EN ISO/IEC 17025. The company is accredited by the American Association for Laboratory Accreditation (A2LA) www.a2la.org test laboratory number 2381.01. MiCOM Labs test schedule is available at the following URL; <http://www.a2la.org/scopepdf/2381-01.pdf>



The American Association for Laboratory Accreditation

World Class Accreditation

Accredited Laboratory

A2LA has accredited

MICOM LABS

Pleasanton, CA

for technical competence in the field of

Electrical Testing

This laboratory is accredited in accordance with the recognized International Standard ISO/IEC 17025:2005 *General Requirements for the Competence of Testing and Calibration Laboratories*. This accreditation demonstrates technical competence for a defined scope and the operation of a laboratory quality management system (*refer to joint ISO-ILAC-IAF Communiqué dated 8 January 2009*).

Presented this 27th day of March 2012.



President & CEO
For the Accreditation Council
Certificate Number 2381.01
Valid to November 30, 2013

For the tests or types of tests to which this accreditation applies, please refer to the laboratory's Electrical Scope of Accreditation.

This test report may be reproduced in full only. The document may only be updated by MiCOM Labs personnel. Any changes will be noted in the Document History section of the report.



Title: Silver Spring Network MicroAP
To: FCC 47 CFR Part 15.247 & IC RSS-210
Serial #: SSNT62-U4 Rev A
Issue Date: 13th August 2013
Page: 6 of 80

RECOGNITION

MiCOM Labs, Inc has widely recognized Electrical testing capabilities. Our international recognition includes Conformity Assessment Body designation by APEC MRA** countries. Our test reports are widely accepted for global type approvals.

Country	Recognition Body	Status	Phase	Identification No.
USA	Federal Communications Commission (FCC)	TCB	-	US0159 Listing #: 102167
Canada	Industry Canada (IC)	FCB	APEC MRA 2	US0159 Listing #: 4143A-2
Japan	MIC (Ministry of Internal Affairs and Communication)	CAB	APEC MRA 2	RCB 210
	VCCI	--	--	A-0012
Europe	European Commission	NB	EU MRA	NB 2280
Australia	Australian Communications and Media Authority (ACMA)	CAB	APEC MRA 1	US0159
Hong Kong	Office of the Telecommunication Authority (OFTA)	CAB	APEC MRA 1	
Korea	Ministry of Information and Communication Radio Research Laboratory (RRL)	CAB	APEC MRA 1	
Singapore	Infocomm Development Authority (IDA)	CAB	APEC MRA 1	
Taiwan	National Communications Commission (NCC) Bureau of Standards, Metrology and Inspection (BSMI)	CAB	APEC MRA 1	
Vietnam	Ministry of Communication (MIC)	CAB	APEC MRA 1	

**APEC MRA – Asia Pacific Economic Community Mutual Recognition Agreement.

Is a recognition agreement under which test lab is accredited to regulatory standards of the APEC member countries.

Phase I - recognition for product testing

Phase II – recognition for both product testing and certification

N/A – Not Applicable

**EU MRA – European Union Mutual Recognition Agreement.

Is a recognition agreement under which test lab is accredited to regulatory standards of the EU member countries.

**NB – Notified Body

This test report may be reproduced in full only. The document may only be updated by MiCOM Labs personnel. Any changes will be noted in the Document History section of the report.

PRODUCT CERTIFICATION

MiCOM Labs, Inc. is an accredited Product Certification Body per the international standard EN ISO/IEC Guide 65. The company is accredited by the American Association for Laboratory Accreditation (A2LA) www.a2la.org test laboratory number 2381.02. MiCOM Labs test schedule is available at the following URL; <http://www.a2la.org/scopepdf/2381-02.pdf>



The American Association for Laboratory Accreditation

"World Class Accreditation"

Accredited Product Certification Body

A2LA has accredited

MICOM LABS

Pleasanton, CA

for technical competence as a

Product Certification Body

This product certification body is accredited in accordance with the recognized International Standard ISO/IEC Guide 65:1996 *General requirements for bodies operating product certification systems*. This accreditation demonstrates technical competence for a defined scope and the operation of a quality management system.

Presented this 27th day of March 2012.



President & CEO
For the Accreditation Council
Certificate Number 2381.02
Valid to November 30, 2013

For the product certification schemes to which this accreditation applies, please refer to the organization's Product Certification Scope of Accreditation

United States of America – Telecommunication Certification Body (TCB)

TCB Identifier – US0159

Industry Canada – Certification Body

CAB Identifier – US0159

Europe – Notified Body

Notified Body Identifier - 2280

Japan – Recognized Certification Body (RCB)

RCB Identifier - 210

This test report may be reproduced in full only. The document may only be updated by MiCOM Labs personnel. Any changes will be noted in the Document History section of the report.



Title: Silver Spring Network MicroAP
To: FCC 47 CFR Part 15.247 & IC RSS-210
Serial #: SSNT62-U4 Rev A
Issue Date: 13th August 2013
Page: 8 of 80

DOCUMENT HISTORY

Document History		
Revision	Date	Comments
Draft		
Rev A	13 th August 2013	Initial release.

This test report may be reproduced in full only. The document may only be updated by MiCOM Labs personnel. Any changes will be noted in the Document History section of the report.



Title: Silver Spring Network MicroAP
To: FCC 47 CFR Part 15.247 & IC RSS-210
Serial #: SSNT62-U4 Rev A
Issue Date: 13th August 2013
Page: 9 of 80

TEST RESULT CERTIFICATE

Manufacturer:	Silver Spring Networks 555 Broadway Street Redwood City California 94063, USA	Tested By:	MiCOM Labs, Inc. 440 Boulder Court Suite 200 Pleasanton California, 94566, USA
EUT:	Network Interface Card (NIC)	Telephone:	+1 925 462 0304
Model:	MicroAP (NIC 411-3G, NIC 411-3C)	Fax:	+1 925 462 0306
S/N's:	mac:00:13:50:02:00:a6:ff:bd		
Test Date(s):	3rd July to 12th August 2013	Website:	www.micomlabs.com

STANDARD(S)	TEST RESULTS
FCC 47 CFR Part 15.247 & IC RSS-210	EQUIPMENT COMPLIES

MiCOM Labs, Inc. tested the equipment mentioned in accordance with the requirements set forth in the above standards. Test results indicate that the equipment tested is capable of demonstrating compliance with the requirements as documented within this report.

Notes:

1. This document reports conditions under which testing was conducted and the results of testing performed.
2. Details of test methods used have been recorded and kept on file by the laboratory.
3. Test results apply only to the item(s) tested.

Approved & Released for MiCOM Labs, Inc. by:



TEST CERTIFICATE #2381.01



Graeme Grieve
Quality Manager MiCOM Labs,



Gordon Hurst
President & CEO MiCOM Labs, Inc.

This test report may be reproduced in full only. The document may only be updated by MiCOM Labs personnel. Any changes will be noted in the Document History section of the report.

1. REFERENCES AND MEASUREMENT UNCERTAINTY

1.1. Normative References

REF.	PUBLICATION	YEAR	TITLE
i.	FCC 47 CFR Part 15, Subpart C	2010	Title 47: Telecommunication PART 15—RADIO FREQUENCY DEVICES Subpart C—Intentional Radiators
ii.	RSS-210 Annex 8	2010	Radio Standards Specification 210, Issue 8, Low-power License-exempt Radiocommunication Devices (All Frequency Bands): Category I Equipment
iii.	FCC OET KDB 662911	4 th April 2011	Emissions Testing of Transmitters with Multiple Outputs in the Same Band
iv.	DA 00-705	2000	FCC DA 00-705 "Filing and Measurement Guidelines for Frequency Hopping Spread Spectrum Systems" released March 30, 2000
v.	RSS-GEN	2010	Radio Standards Specification-Gen, Issue 3, General Requirements and Information for the Certification of Radiocommunication Equipment
vi.	FCC 47 CFR Part 15, Subpart B	2010	47 CFR Part 15, SubPart B; Unintentional Radiators
vii.	ICES-003	2004	Spectrum Management and Telecommunications Policy Interference-Causing Equipment Standard Digital Apparatus; Issue 4
viii.	ANSI C63.4	2009	American National Standards for Methods of Measurement of Radio-Noise Emissions from Low-Voltage Electrical and Electronic Equipment in the Range of 9 kHz to 40 GHz
ix.	CISPR 22/ EN 55022	2008 2006+A1:2007	Limits and Methods of Measurements of Radio Disturbance Characteristics of Information Technology Equipment
x.	M 3003	Edition 1 Dec. 1997	Expression of Uncertainty and Confidence in Measurements
xi.	LAB34	Edition 1 Aug 2002	The expression of uncertainty in EMC Testing
xii.	ETSI TR 100 028	2001	Parts 1 and 2 Electromagnetic compatibility and Radio Spectrum Matters (ERM); Uncertainties in the measurement of mobile radio equipment characteristics
xiii.	A2LA	July 2012	Reference to A2LA Accreditation Status – A2LA Advertising Policy

This test report may be reproduced in full only. The document may only be updated by MiCOM Labs personnel. Any changes will be noted in the Document History section of the report.



Title: Silver Spring Network MicroAP
To: FCC 47 CFR Part 15.247 & IC RSS-210
Serial #: SSNT62-U4 Rev A
Issue Date: 13th August 2013
Page: 11 of 80

1.2. Test and Uncertainty Procedures

Conducted and radiated emission measurements were conducted in accordance with American National Standards Institute ANSI C63.4, listed in the Normative References section of this report.

Measurement uncertainty figures are calculated in accordance with ETSI TR 100 028 Parts 1 and 2.

Measurement uncertainties stated are based on a standard uncertainty multiplied by a coverage factor $k = 2$, providing a level of confidence of approximately 95 % in accordance with UKAS document M 3003 listed in the Normative References section of this report.

This test report may be reproduced in full only. The document may only be updated by MiCOM Labs personnel. Any changes will be noted in the Document History section of the report.



Title: Silver Spring Network MicroAP
To: FCC 47 CFR Part 15.247 & IC RSS-210
Serial #: SSNT62-U4 Rev A
Issue Date: 13th August 2013
Page: 12 of 80

2. PRODUCT DETAILS AND TEST CONFIGURATIONS

2.1. Technical Details

Details	Description
Purpose:	Test of the Silver Spring Network MicroAP (NIC 411-3G, NIC 411-3C) to FCC Part 15.247 and Industry Canada RSS-210 regulations.
Applicant:	Silver Spring Networks 555 Broadway Street Redwood City California 94063, USA
Manufacturer:	As applicant.
Laboratory performing the tests:	MiCOM Labs, Inc. 440 Boulder Court, Suite 200 Pleasanton, California 94566 USA
Test report reference number:	SSNT62-U4 Rev A
Date EUT received:	3 rd July 2013
Standard(s) applied:	FCC 47 CFR Part 15.247 & IC RSS-210
Dates of test (from - to):	3rd July to 12th August 2013
No of Units Tested:	One
Type of Equipment:	Network Interface Card (NIC)
Manufacturers Trade Name:	MicroAP
Model(s):	NIC 411-3G-070B, NIC 411-3G-0713, NIC 411-070A, NIC 411-3G-0712, NIC 411-3C-070B, NIC 411-3C-0713, NIC 411-3C-070A, NIC 411-3C-0712
Operational Technologies:	DSSS, FHSS, 3G GSM or CDMA2000
Location for use:	Indoor/Outdoor
Declared Frequency Range(s):	2400 - 2483.5 MHz
Hardware Rev	Rev A
Type of Modulation:	DSSS
Declared Nominal Average Output Power:	+23 dBm
EUT Modes of Operation:	250 kBit/s
Transmit/Receive Operation:	Time Division Duplex
Rated Input Voltage and Current:	4 Vdc
Operating Temperature Range:	Declared range -40° to +85°.
ITU Emission Designator:	2M50F1D
Equipment Dimensions:	108.2x46.99x14.22 (mm)
Weight:	39 grams
Primary function of equipment:	Micromesh allows machine to machine communication over 900 MHz and 2.4 GHz FHSS and transmit data over 3G GSM or CDMA cellular backhaul to utility or network provider. 2.4 GHz home area network paring with other Zigbee devices.

This test report may be reproduced in full only. The document may only be updated by MiCOM Labs personnel. Any changes will be noted in the Document History section of the report.



Title: Silver Spring Network MicroAP
To: FCC 47 CFR Part 15.247 & IC RSS-210
Serial #: SSNT62-U4 Rev A
Issue Date: 13th August 2013
Page: 13 of 80

2.2. Scope of Test Program

The scope of the test program was to test the Silver Spring Network MicroAP (NIC 411-3G, NIC411-3C) in the frequency ranges 2400 – 2483.5 MHz against FCC 47 CFR Part 15.247 and Industry Canada RSS-210 specifications for radiated and conducted emissions for intentional radiators. The intentional radiator was tested in a simulated typical installation to demonstrate compliance with the stated standards.

Co-Location Testing

Co-location measurements were performed on the cellular frequency bands together with the 915 MHz and 2.4 GHz DSSS and FHSS technologies. Test results are available and will be kept on file by the laboratory.

Model Numbers

NIC 411-3G-070B: 900 MHz FHSS NAN1, 2.4 GHz HAN, 2.4 GHz NAN2, 3G GSM cellular module, internal/external NAN antenna and internal cell antenna

NIC 411-3G-0713: 900 MHz FHSS NAN1, 2.4 GHz HAN, 2.4 GHz NAN2, 3G GSM cellular module, internal/external NAN antenna and external cell antenna

NIC 411-3G-070A: 900 MHz FHSS NAN1, 2.4 GHz HAN, 2.4 GHz NAN2, 3G GSM cellular module, external NAN antenna and internal cell antenna

NIC 411-3G-0712: 900 MHz FHSS NAN1, 2.4 GHz HAN, 2.4 GHz NAN2, 3G GSM cellular module, external NAN antenna and external cell antenna

NIC 411-3C-070B: 900 MHz FHSS NAN1, 2.4 GHz HAN, 2.4 GHz NAN2, CDMA-2000 cellular module, internal/external NAN antenna and internal cell antenna

NIC 411-3C-0713: 900 MHz FHSS NAN1, 2.4 GHz HAN, 2.4 GHz NAN2, CDMA-2000 cellular module, internal/external NAN antenna and external cell antenna

NIC 411-3C-070A: 900 MHz FHSS NAN1, 2.4 GHz HAN, 2.4 GHz NAN2, CDMA-2000 cellular module, external NAN antenna and internal cell antenna

NIC 411-3C-0712: 900 MHz FHSS NAN1, 2.4 GHz HAN, 2.4 GHz NAN2, CDMA-2000 cellular module, external NAN antenna and external cell antenna

NAN1: 900 MHz FHSS

NAN2: 2.4 GHz FHSS

HAN: 2.4 GHz DSSS (802.15.4 Zigbee)

This test report may be reproduced in full only. The document may only be updated by MiCOM Labs personnel. Any changes will be noted in the Document History section of the report.



Antenna Options

The MicroAP (NIC 411-3G, NIC 411-3C) has two antenna options integral and external, both options were tested. As cellular operation was provided via plug-in module(s) which have their own FCC and IC certification no cellular testing was required.

The MicroAP (NIC 411-3G, NIC 411-3C) operated with the following modulations and data rates, each modulation and data rate was tested during the program. Results for the external antenna are included in this report.

Frequency Band	Modulation	Data Rate
2400 -2483.5 MHz	DSSS	250 kBit/s



Title: Silver Spring Network MicroAP
To: FCC 47 CFR Part 15.247 & IC RSS-210
Serial #: SSNT62-U4 Rev A
Issue Date: 13th August 2013
Page: 15 of 80

2.3. Equipment Model(s) and Serial Number(s)

Equipment Type	Equipment Description (Including Brand Name)	Mfr	Model No.	Serial No.
EUT	Network Interface Card	Silver Spring Network	MicroAP (NIC 411-3G, NIC 411-3C)	mac:00:13:50:02:00:a6:ff:bd
Support	Laptop	IBM	ThinkPad	None

2.4. Antenna Details

Manufacturer	Model	Internal/ External	Frequency	Antenna Gain
F-Type	155-0010-00	Internal	900 MHz	1.2
F-Type	155-0010-00	Internal	2.4 GHz	5.6
SMD	A10376	Internal	824-960 MHz (cellular)	-1.2*
SMD	A10376	Internal	1710-1990 MHz (cellular)	-1.9*
Omni	WPANT30017-CA	External	902-928 MHz	3.0
Omni	WPANT30017-CA	External	2.4-2.5 GHz	4.0

*Module pre-certified no testing performed on this technology

2.5. Cabling and I/O Ports

Number and type of I/O ports

1. NONE

This test report may be reproduced in full only. The document may only be updated by MiCOM Labs personnel. Any changes will be noted in the Document History section of the report.



2.6. Test Configurations

Testing was performed to determine the highest power level versus bit rate. The variant with the highest power was used to exercise the product.

Operational Mode(s)	Data Rate with Highest Power	Frequencies (MHz)
DSSS	250 kBit/s	2405, 2440, 2480

Results for the above configurations are provided in this report

Antenna Test Configurations for Radiated Emissions

Results for the following configurations are provided in this report.

2,400 – 2483.5 MHz

15.247	
DSSS	SE 2405
	SE 2440
	SE 2480
	BE 2390
	BE 2483.5

KEY;-

SE – Spurious Emission
BE – Band-Edge

2.7. Equipment Modifications

The following modifications were required to bring the equipment into compliance:

1. NONE

2.8. Deviations from the Test Standard

The following deviations from the test standard were required in order to complete the test program:

1. NONE

3. TEST EQUIPMENT CONFIGURATION(S)

3.1. Conducted RF Emission Test Set-up

The following tests were performed using the conducted test set-up shown in the diagram below.

1. Section 5.1.1.1 6 dB and 99% Bandwidth
2. Section 5.1.1.2. Output Power
3. Section 6.1.1.3 Power Spectral Density
4. Section 6.1.1.4 Conducted Spurious & Band-Edge Emissions

Conducted Test Set-Up Pictorial Representation

Test Measurement set up

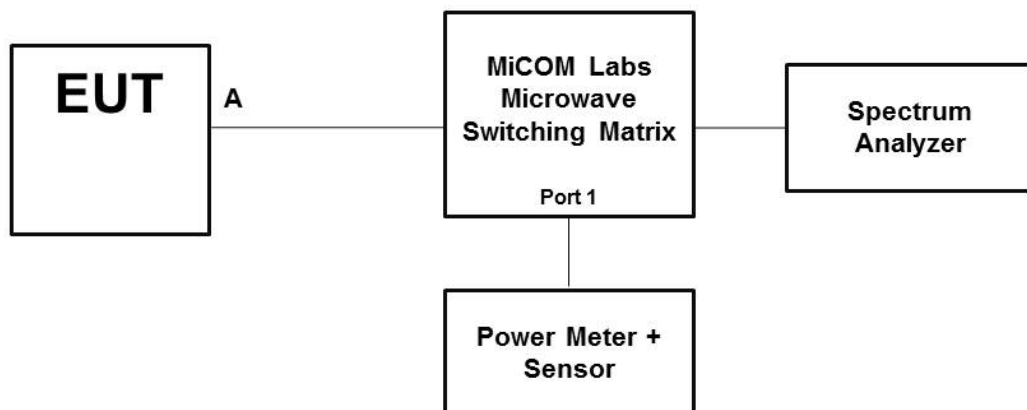

Conducted Test Measurement Setup

3.2. Radiated Spurious Emission Test Set-up > 1 GHz

The following tests were performed using the conducted test set-up shown in the diagram below.

Radiated Emission Measurement Setup – Above 1 GHz

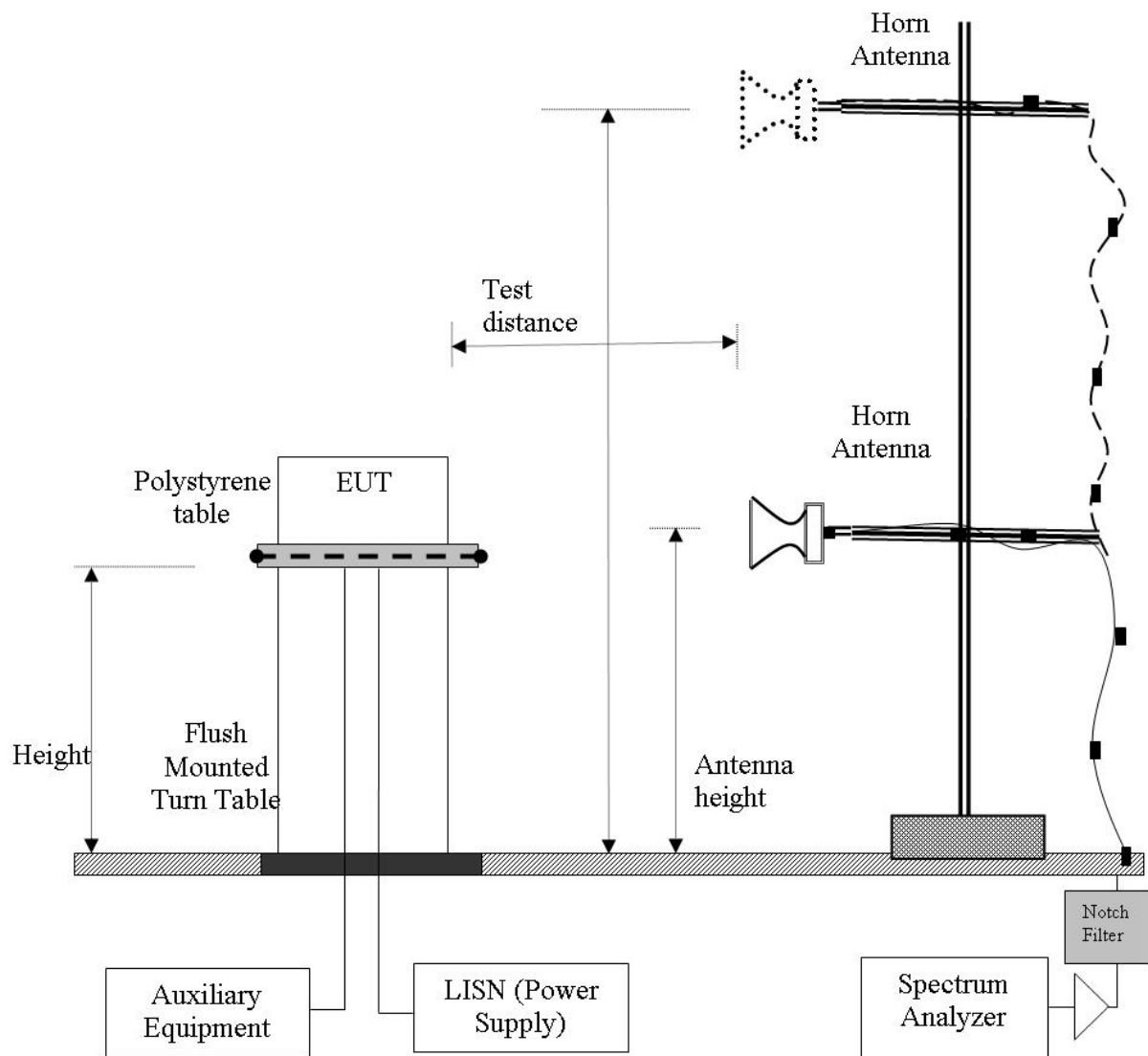

This test report may be reproduced in full only. The document may only be updated by MiCOM Labs personnel. Any changes will be noted in the Document History section of the report.

3.3. Digital Emissions Test Set-up (0.03 – 1 GHz)

The following tests were performed using the conducted test set-up shown in the diagram below.

Digital Emission Measurement Setup – Below 1 GHz

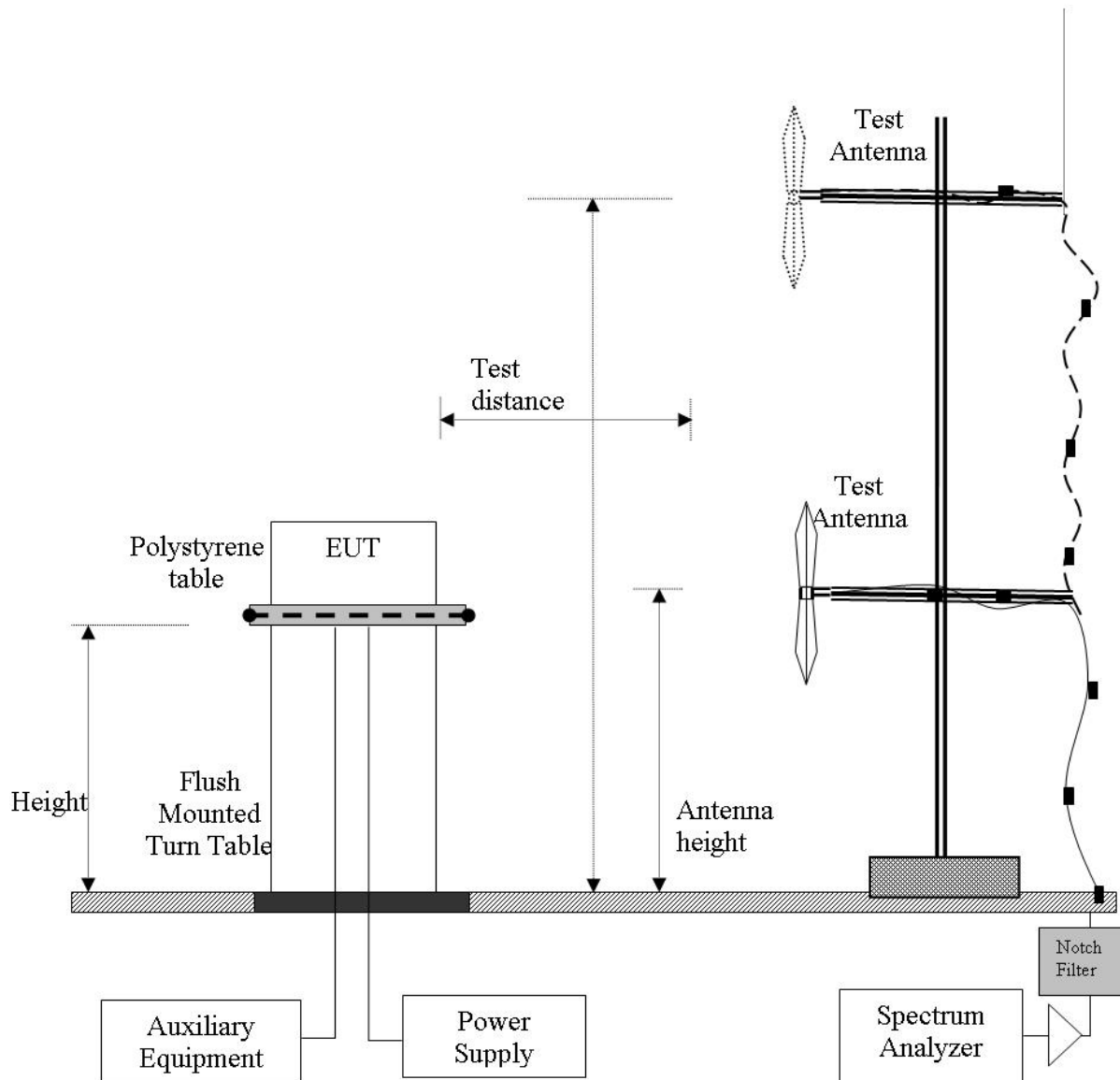

This test report may be reproduced in full only. The document may only be updated by MiCOM Labs personnel. Any changes will be noted in the Document History section of the report.



4. TEST SUMMARY

List of Measurements

The following table represents the list of measurements required under the **FCC CFR47 Part 15.247** and **Industry Canada RSS-210** and **Industry Canada RSS-Gen**.

Section(s)	Test Items	Description	Condition	Result	Test Report Section
15.247(a)(2) A8.2(1) 4.4	6 dB and 99 % Bandwidths	≥500 kHz	Conducted	Complies	5.1.1.1
15.247(b)(3) 15.31(e) A8.4(4)	Peak Output Power Voltage Variation	Shall not exceed 1W Variation of supply voltage 85 % -115 %	Conducted	Complies	5.1.1.2
15.247(e) A8.2	Peak Power Spectral Density	Shall not be greater than +8 dBm in any 3 kHz band	Conducted	Complies	5.1.1.3
15.247(d) 15.205 / 15.209 A8.5 2.2 4.7	Spurious Emissions (30MHz - 26 GHz b/g and 30 MHz – 40 GHz a)	The radiated emission in any 100 kHz of out-band shall be at least 20 dB below the highest in-band spectral density	Conducted	Complies	5.1.1.4

This test report may be reproduced in full only. The document may only be updated by MiCOM Labs personnel. Any changes will be noted in the Document History section of the report.



List of Measurements (continued)

The following table represents the list of measurements required under the **FCC CFR47 Part 15.247**, **Industry Canada RSS-210**, and **Industry Canada RSS-Gen**.

Section(s)	Test Items	Description	Condition	Result	Test Report Section
15.247(d) 15.205 / 15.209 A8.5 2.2 2.6 4.7	Radiated Emissions	Restricted Bands	Radiated	Complies	5.1.2
	Transmitter Radiated Spurious Emissions	Emissions above 1 GHz		Complies	
	Radiated Band Edge	Band-edge results Peak Emissions		Complies	
15.205 / 15.209 2.2	Radiated Spurious Emissions	Emissions <1 GHz (30M-1 GHz)	Radiated	Complies	5.1.2.4
15.207 7.2.2	AC Wireline Conducted Emissions 150 kHz–30 MHz	Conducted Emissions	Conducted	Not Applicable EUT was dc Powered	

Note 1: Test results reported in this document relate only to the items tested

Note 2: The required tests demonstrated compliance as per client declaration of test configuration, monitoring methodology and associated pass/fail criteria

Note 3: Section 2.7 Equipment Modifications highlights the equipment modifications that were required to bring the product into compliance with the above test matrix



Title: Silver Spring Network MicroAP
To: FCC 47 CFR Part 15.247 & IC RSS-210
Serial #: SSNT62-U4 Rev A
Issue Date: 13th August 2013
Page: 22 of 80

5. TEST RESULTS

5.1. Device Characteristics

5.1.1. Conducted Testing

5.1.1.1. 6 dB and 99 % Bandwidth

Conducted Test Conditions for 6 dB and 99% Bandwidth			
Standard:	FCC CFR 47:15.247	Ambient Temp. (°C):	24.0 - 27.5
Test Heading:	6 dB and 99 % Bandwidth	Rel. Humidity (%):	32 - 45
Standard Section(s):	15.247 (a)(2)	Pressure (mBars):	999 - 1001
Reference Document(s):	KDB 558074 - D01 DTS Measurement Guidance v01: Section 5.1 Emission Bandwidth		

Test Procedure for 6 dB and 99% Bandwidth Measurement
The bandwidth at 6 dB and 99 % was measured with a spectrum analyzer connected to the antenna terminal, while EUT is operating in transmission mode at the appropriate center frequency.

This test report may be reproduced in full only. The document may only be updated by MiCOM Labs personnel. Any changes will be noted in the Document History section of the report.



Title: Silver Spring Network MicroAP
To: FCC 47 CFR Part 15.247 & IC RSS-210
Serial #: SSNT62-U4 Rev A
Issue Date: 13th August 2013
Page: 23 of 80

Equipment Configuration for 6 dB & 99% Bandwidth

Variant:	802.15.4	Duty Cycle (%):	100
Data Rate:	250 kBit/s	Antenna Gain (dBi):	Not Applicable
Modulation:	DSSS	Beam Forming Gain (Y):	Not Applicable
TPC:	Not Applicable		
Engineering Test Notes:	Integral Antenna		

Test Measurement Results

Test Frequency MHz	Measured 6 dB Bandwidth (MHz)				6 dB Bandwidth (MHz)		Limit KHz	Lowest Margin MHz
	Port(s)				Highest	Lowest		
	a	b	c	d				
2405.0	1.603	--	--	--	1.603	1.603	≥500.0	-1.10
2440.0	1.623	--	--	--	1.623	1.623	≥500.0	-1.12
2480.0	1.623	--	--	--	1.623	1.623	≥500.0	-1.12

Test Frequency MHz	Measured 99% Bandwidth (MHz)				Maximum 99% Bandwidth (MHz)		
	Port(s)						
	a	b	c	d			
2405.0	2.265	--	--	--	2.265		
2440.0	2.325	--	--	--	2.325		
2480.0	2.385	--	--	--	2.385		

Traceability to Industry Recognized Test Methodologies

Work Instruction:	WI-03 MEASURING RF SPECTRUM MASK
Measurement Uncertainty:	±2.81 dB

Note: [click the link in the above results matrix to view the plot](#)

This test report may be reproduced in full only. The document may only be updated by MiCOM Labs personnel. Any changes will be noted in the Document History section of the report.



Title: Silver Spring Network MicroAP
To: FCC 47 CFR Part 15.247 & IC RSS-210
Serial #: SSNT62-U4 Rev A
Issue Date: 13th August 2013
Page: 24 of 80

Equipment Configuration for 6 dB & 99% Bandwidth

Variant:	802.15.4	Duty Cycle (%):	100
Data Rate:	250kBit/s	Antenna Gain (dBi):	Not Applicable
Modulation:	DSSS	Beam Forming Gain (Y):	Not Applicable
TPC:	Not Applicable		
Engineering Test Notes:	External Antenna		

Test Measurement Results

Test Frequency	Measured 6 dB Bandwidth (MHz)				6 dB Bandwidth (MHz)		Limit	Lowest Margin
	Port(s)				Highest	Lowest		
MHz	a	b	c	d			KHz	MHz
2405.0	1.583	--	--	--	1.583	1.583	≥500.0	-1.08
2440.0	1.603	--	--	--	1.603	1.603	≥500.0	-1.10
2480.0	1.623	--	--	--	1.623	1.623	≥500.0	-1.12

Test Frequency	Measured 99% Bandwidth (MHz)				Maximum 99% Bandwidth (MHz)		
	Port(s)						
MHz	a	b	c	d			
2405.0	2.265	--	--	--	2.265		
2440.0	2.305	--	--	--	2.305		
2480.0	2.345	--	--	--	2.345		

Traceability to Industry Recognized Test Methodologies	
Work Instruction:	WI-03 MEASURING RF SPECTRUM MASK
Measurement Uncertainty:	±2.81 dB

Note: [click the link in the above results matrix to view the plot](#)

This test report may be reproduced in full only. The document may only be updated by MiCOM Labs personnel. Any changes will be noted in the Document History section of the report.



Title: Silver Spring Network MicroAP
To: FCC 47 CFR Part 15.247 & IC RSS-210
Serial #: SSNT62-U4 Rev A
Issue Date: 13th August 2013
Page: 25 of 80

Specification

Limits

§15.247 (a)(2) & RSS-210 §A8.2(1)

The minimum 6 dB bandwidth shall be at least 500 kHz.

§ IC RSS-Gen 4.4.1 Occupied Bandwidth When an occupied bandwidth value is not specified in the applicable RSS, the transmitted signal bandwidth to be reported is to be its 99% emission bandwidth, as calculated or measured.

§ IC RSS-Gen 4.4.2 6 dB Bandwidth Where indicated, the 6 dB bandwidth is measured at the points when the spectral density of the signal is 6 dB down from the in-band spectral density of the modulated signal, with the transmitter modulated by a representative signal.

Traceability

Test Equipment Used

0158, 0287, 0252, 0313, 0314, 0070, 0116, 0117
--

This test report may be reproduced in full only. The document may only be updated by MiCOM Labs personnel. Any changes will be noted in the Document History section of the report.



Title: Silver Spring Network MicroAP
To: FCC 47 CFR Part 15.247 & IC RSS-210
Serial #: SSNT62-U4 Rev A
Issue Date: 13th August 2013
Page: 26 of 80

5.1.1.2. Peak Output Power

Conducted Test Conditions for Fundamental Emission Output Power			
Standard:	FCC CFR 47:15.247	Ambient Temp. (°C):	24.0 - 27.5
Test Heading:	Emission Output Power	Rel. Humidity (%):	32 - 45
Standard Section(s):	15.247 (a)(2)	Pressure (mBars):	999 - 1001
Reference Document(s):	KDB 558074 - D01 DTS Measurement Guidance v01: Section 5.2 Fundamental Emission Output Power KDB 662911 was implemented for In-band power measurements. The measure and sum technique was implemented in all cases.		

Test Procedure for Fundamental Emission Output Power Measurement

The transmitter terminal of EUT was connected to the input of the spectrum analyzer set to measure peak power. The resolution filter bandwidth was set to 6 dB, peak detector selected and the analyzer built-in power function was used to integrate peak power over the 20 dB bandwidth.

Supporting Information

Calculated Power = A + G + 10 log (1/x) dBm

A = Total Power [10 Log₁₀ (10^{a/10} + 10^{b/10} + 10^{c/10} + 10^{d/10})], G = Antenna Gain,

x = Duty Cycle

This test report may be reproduced in full only. The document may only be updated by MiCOM Labs personnel. Any changes will be noted in the Document History section of the report.



15.247 (c) Operation with directional antenna gains greater than 6 dBi.
 If transmitting antennas of directional gain greater than 6 dBi are used, the conducted output power from the intentional radiator shall be reduced by the amount in dB that the directional gain of the antenna exceeds 6 dBi.

Equipment Configuration for Peak Output Power

Variant:	802.15.4	Duty Cycle (%):	100
Data Rate:	250 kBit/s	Antenna Gain (dBi):	Not Applicable
Modulation:	DSSS	Beam Forming Gain (Y):	Not Applicable
TPC:	Not Applicable		
Engineering Test Notes:	Integral Antenna		

Test Measurement Results

Test Frequency	Measured Output Power (dBm)				Calculated Total Power Σ Port(s)	Limit	Margin	EUT Power Setting
	Port(s)							
MHz	a	b	c	d	dBm	dBm	dBm	
2405.0	22.71	--	--	--	22.71	30.00	-7.29	12.00
2440.0	22.57	--	--	--	22.57	30.00	-7.43	12.00
2480.0	0.36	--	--	--	0.36	30.00	-29.64	3.00

Traceability to Industry Recognized Test Methodologies

Work Instruction:	WI-01 MEASURING RF OUTPUT POWER
Measurement Uncertainty:	± 1.33 dB

Equipment Configuration for Peak Output Power

Variant:	802.15.4	Duty Cycle (%):	100
Data Rate:	250kBit/s	Antenna Gain (dBi):	Not Applicable
Modulation:	DSSS	Beam Forming Gain (Y):	Not Applicable
TPC:	Not Applicable		
Engineering Test Notes:	External Antenna		

Test Measurement Results

Test Frequency	Measured Output Power (dBm)				Calculated Total Power Σ Port(s)	Limit	Margin	EUT Power Setting
	Port(s)							
MHz	a	b	c	d	dBm	dBm	dBm	
2405.0	22.91	--	--	--	22.91	30.00	-7.09	15.00
2440.0	23.59	--	--	--	23.59	30.00	-6.41	15.00
2480.0	4.32	--	--	--	4.32	30.00	-25.68	4.00

Traceability to Industry Recognized Test Methodologies

Work Instruction:	WI-01 MEASURING RF OUTPUT POWER
Measurement Uncertainty:	± 1.33 dB

Note: [click the link in the above results matrix to view the plot](#)

This test report may be reproduced in full only. The document may only be updated by MiCOM Labs personnel. Any changes will be noted in the Document History section of the report.



Specification

Limits

§15.247 (b) The maximum peak output power of the intentional radiator shall not exceed the following:

§15.247 (b) (3) For systems using digital modulation in the 902-928 MHz, 2400-2483.5 MHz and 5725-5850 MHz bands: 1.0 watt.

15.247 (b) (4) The conducted output power limit specified in paragraph (b) of this section is based on the use of antennas with directional gains that do not exceed 6 dBi. Except as shown in paragraph (c) of this section, if transmitting antennas of directional gain greater than 6 dBi are used, the conducted output power from the intentional radiator shall be reduced below the stated values in paragraphs (b)(1), (b)(2), and (b)(3) of this section, as appropriate, by the amount in dB that the directional gain of the antenna exceeds 6 dBi.

15.247 (c) Operation with directional antenna gains greater than 6 dBi.

(1) Fixed point-to-point operation:

(i) Systems operating in the 2400–2483.5 MHz band that are used exclusively for fixed, point-to-point operations may employ transmitting antennas with directional gain greater than 6 dBi provided the maximum conducted output power of the intentional radiator is reduced by 1 dB for every 3 dB that the directional gain of the antenna exceeds 6 dBi.

(ii) Systems operating in the 5725–5850 MHz band that are used exclusively for fixed, point-to-point operations may employ transmitting antennas with directional gain greater than 6 dBi without any corresponding reduction in transmitter conducted output power.

§15.31 (e) For intentional radiators, measurements of the variation of the input power or the radiated signal level of the fundamental frequency component of the emission, as appropriate, shall be performed with the supply voltage varied between 85% and 115% of the nominal rated supply voltage. For battery operated equipment, the equipment tests shall be performed using a new battery.

§ RSS-210 A8.4(4) For systems employing digital modulation techniques operating in the 902-928 MHz, 2400-2483.5 MHz and 5725-5850 MHz bands the maximum peak conducted power shall not exceed 1 watt.

Traceability

Method	Test Equipment Used
Measurements were made per work instruction WI-01 'Measuring RF Output Power'	0158, 0287, 0252, 0313, 0314, 0070, 0116, 0117

This test report may be reproduced in full only. The document may only be updated by MiCOM Labs personnel. Any changes will be noted in the Document History section of the report.



Title: Silver Spring Network MicroAP
To: FCC 47 CFR Part 15.247 & IC RSS-210
Serial #: SSNT62-U4 Rev A
Issue Date: 13th August 2013
Page: 29 of 80

5.1.1.3. Power Spectral Density

Conducted Test Conditions for Power Spectral Density			
Standard:	FCC CFR 47:15.247	Ambient Temp. (°C):	24.0 - 27.5
Test Heading:	Power Spectral Density	Rel. Humidity (%):	32 - 45
Standard Section(s):	15.247 (e)	Pressure (mBars):	999 - 1001
Reference Document(s):	KDB 558074 - D01 DTS Measurement Guidance v01: Section 5.3 Maximum Power Spectral Density Level in the Emission Bandwidth		
Test Procedure for Power Spectral Density The transmitter output was connected to a spectrum analyzer and the maximum level in a 3 kHz bandwidth was measured. A peak value was found over the full emission bandwidth and the frequency span reduced to obtain enhanced resolution. Sweep time \geq span / 3 kHz with video averaging turned off. The Peak Power Spectral Density is the highest level found across the emission in a 3 kHz resolution bandwidth.			
Supporting Information Calculated Power = $A + 10 \log (1/x)$ dBm $A = \text{Total Power Spectral Density } [10 \text{ Log}_{10} (10^{a/10} + 10^{b/10} + 10^{c/10} + 10^{d/10})]$ $x = \text{Duty Cycle}$ Limit Line: KDB 662911 was implemented for In-band power spectral density (PSD) measurements - Option (2) measure and subtract $10 \log (N)$ dB from the limit for devices with multiple RF ports			

This test report may be reproduced in full only. The document may only be updated by MiCOM Labs personnel. Any changes will be noted in the Document History section of the report.



Title: Silver Spring Network MicroAP
To: FCC 47 CFR Part 15.247 & IC RSS-210
Serial #: SSNT62-U4 Rev A
Issue Date: 13th August 2013
Page: 30 of 80

Equipment Configuration for Power Spectral Density - Peak

Variant:	802.15.4	Duty Cycle (%):	100
Data Rate:	250 kBit/s	Antenna Gain (dBi):	Not Applicable
Modulation:	DSSS	Beam Forming Gain (Y):	Not Applicable
TPC:	Not Applicable		
Engineering Test Notes:	Integral Antenna		

Test Measurement Results

Test Frequency	Measured Power Spectral Density (dBm)				Calculated Total Power Spectral Density		Limit	Margin
	Port(s)				dBm			
MHz	a	b	c	d	Σ Port(s) per 30kHz RBW	Conversion to 3 kHz RBW	dBm	dB
2405.0	17.886	--	--	--	17.886	7.886	8.00	-0.11
2440.0	17.136	--	--	--	17.136	7.136	8.00	-0.86
2480.0	-5.175	--	--	--	-5.175	-15.175	8.00	-23.18

Traceability to Industry Recognized Test Methodologies	
Work Instruction:	WI-03 MEASURING RF SPECTRUM MASK
Measurement Uncertainty:	±2.81 dB

Equipment Configuration for Power Spectral Density - Peak

Variant:	802.15.4	Duty Cycle (%):	100
Data Rate:	250kBit/s	Antenna Gain (dBi):	Not Applicable
Modulation:	DSSS	Beam Forming Gain (Y):	Not Applicable
TPC:	Not Applicable		
Engineering Test Notes:	External Antenna		

Test Measurement Results

Test Frequency	Measured Power Spectral Density (dBm)				Calculated Total Power Spectral Density		Limit	Margin
	Port(s)				dBm			
MHz	a	b	c	d	Σ Port(s) per 30kHz RBW	Conversion to 3 kHz RBW	dBm	dB
2405.0	17.870	--	--	--	17.870	7.870	8.00	-0.13
2440.0	17.634	--	--	--	17.634	7.634	8.00	-0.37
2480.0	-1.675	--	--	--	-1.675	-11.675	8.00	-19.68

Traceability to Industry Recognized Test Methodologies	
Work Instruction:	WI-03 MEASURING RF SPECTRUM MASK
Measurement Uncertainty:	±2.81 dB

Note: [click the link in the above results matrix to view the p18](#)

This test report may be reproduced in full only. The document may only be updated by MiCOM Labs personnel. Any changes will be noted in the Document History section of the report.



Title: Silver Spring Network MicroAP
To: FCC 47 CFR Part 15.247 & IC RSS-210
Serial #: SSNT62-U4 Rev A
Issue Date: 13th August 2013
Page: 31 of 80

Specification
Peak Power Spectral Density Limits

§15.247(e) For digitally modulated systems, the power spectral density conducted from the intentional radiator to the antenna shall not be greater than +8 dBm in any 3 kHz band during any time interval of continuous transmission

RSS-210 §A8.2(2) The transmitter power spectral density (into the antenna) shall not be greater than +8 dBm in any 3 kHz band during any time interval of continuous transmission or over 1.0 second if the transmission exceeds 1.0 second duration.

Traceability

Method	Test Equipment Used
Measurements were made per work instruction WI-01 'Measuring RF Output Power'	0158, 0287, 0252, 0313, 0314, 0070, 0116, 0117

This test report may be reproduced in full only. The document may only be updated by MiCOM Labs personnel. Any changes will be noted in the Document History section of the report.



Title: Silver Spring Network MicroAP
To: FCC 47 CFR Part 15.247 & IC RSS-210
Serial #: SSNT62-U4 Rev A
Issue Date: 13th August 2013
Page: 32 of 80

5.1.1.4. Conducted Spurious Emissions

Conducted Test Conditions for Transmitter Conducted Spurious and Band-Edge Emissions			
Standard:	FCC CFR 47:15.247	Ambient Temp. (°C):	24.0 - 27.5
Test Heading:	Max Unwanted Emission Levels	Rel. Humidity (%):	32 - 45
Standard Section(s):	15.247 (d)	Pressure (mBars):	999 - 1001
Reference Document(s):	KDB 558074 - D01 DTS Measurement Guidance v01: Section 5.4 Maximum Unwanted Emission Levels		
Test Procedure for Transmitter Conducted Spurious and Band-Edge Emissions Measurement Transmitter Conducted Spurious and Band-Edge emissions were measured at a limit of 20 dB below the highest in-band spectral density measured with a spectrum analyzer connected to the antenna terminal. Measurements were made while EUT was operating in transmit mode of operation at the appropriate centre frequency closest to the band-edge. Emissions were maximized during the measurement and limits derived from the peak spectral power and drawn on each plot.			

This test report may be reproduced in full only. The document may only be updated by MiCOM Labs personnel. Any changes will be noted in the Document History section of the report.



Title: Silver Spring Network MicroAP
To: FCC 47 CFR Part 15.247 & IC RSS-210
Serial #: SSNT62-U4 Rev A
Issue Date: 13th August 2013
Page: 33 of 80

Equipment Configuration for Transmitter Conducted Spurious and Band-Edge Emissions

Variant:	802.15.4	Duty Cycle (%):	100
Data Rate:	250 kBit/s	Antenna Gain (dBi):	Not Applicable
Modulation:	DSSS	Beam Forming Gain (Y):	Not Applicable
TPC:	Not Applicable		
Engineering Test Notes:	Integral Antenna Port - Power reduced due to 3, radiated band-edge limitations		

Test Measurement Results

Test Frequency	Frequency Range	Transmitter Conducted Spurious Emissions (dBm)							
		Port a		Port b		Port c		Port d	
MHz	MHz	SE	Limit	SE	Limit	SE	Limit	SE	Limit
2405.0	30 - 26000	-41.452	-0.30	--	--	--	--	--	--
2440.0	30 - 26000	-38.255	-0.62	--	--	--	--	--	--
2480.0	30 - 26000	-40.193	-19.91	--	--	--	--	--	--

SE - Maximum spurious emission found

Test Frequency	Band-Edge Frequency	Transmitter Conducted Band-Edge Emissions (dBm)							
		Port a		Port b		Port c		Port d	
MHz	MHz	BE	Limit	BE	Limit	BE	Limit	BE	Limit
2405.0	2400.0	-34.248	1.04	--	--	--	--	--	--
2480.0	2483.5	-45.121	-21.98	--	--	--	--	--	--

BE - Maximum band-edge emission found

Traceability to Industry Recognized Test Methodologies

Work Instruction:	WI-05 MEASUREMENT OF SPURIOUS EMISSIONS
Measurement Uncertainty:	≤ 40 GHz ±2.37 dB, > 40 GHz ±4.6 dB

This test report may be reproduced in full only. The document may only be updated by MiCOM Labs personnel. Any changes will be noted in the Document History section of the report.



Title: Silver Spring Network MicroAP
To: FCC 47 CFR Part 15.247 & IC RSS-210
Serial #: SSNT62-U4 Rev A
Issue Date: 13th August 2013
Page: 34 of 80

Equipment Configuration for Transmitter Conducted Spurious and Band-Edge Emissions

Variant:	802.15.4	Duty Cycle (%):	100
Data Rate:	250kBit/s	Antenna Gain (dBi):	Not Applicable
Modulation:	DSSS	Beam Forming Gain (Y):	Not Applicable
TPC:	Not Applicable		
Engineering Test Notes:	External Antenna - Power reduced to a setting 4, radiated band-edge issue		

Test Measurement Results

Test Frequency	Frequency Range	Transmitter Conducted Spurious Emissions (dBm)							
		Port a		Port b		Port c		Port d	
MHz	MHz	SE	Limit	SE	Limit	SE	Limit	SE	Limit
SE - Maximum spurious emission found									

Test Frequency	Band-Edge Frequency	Transmitter Conducted Band-Edge Emissions (dBm)							
		Port a		Port b		Port c		Port d	
MHz	MHz	BE	Limit	BE	Limit	BE	Limit	BE	Limit
2405.0	2400.0	-35.130	0.95	--	--	--	--	--	--
2480.0	2483.5	-43.944	-18.27	--	--	--	--	--	--
BE - Maximum band-edge emission found									

Traceability to Industry Recognized Test Methodologies

Work Instruction:	WI-05 MEASUREMENT OF SPURIOUS EMISSIONS
Measurement Uncertainty:	= 40 GHz ±2.37 dB, > 40 GHz ±4.6 dB

This test report may be reproduced in full only. The document may only be updated by MiCOM Labs personnel. Any changes will be noted in the Document History section of the report.

Specification

Limits Band-Edge

Lower Limit Band-edge	Upper Limit Band-edge	Limit below highest level of desired power
2,400 MHz	2,483.5 MHz	≥ 20 dB
5725 MHz	5850 MHz	

§15.247(d) and RSS-210 §A8.5 In any 100 kHz bandwidth outside the frequency band in which the spread spectrum or digitally modulated intentional radiator is operating, the radio frequency power that is produced by the intentional radiator shall be at least 20 dB below that in the 100 kHz bandwidth within the band that contains the highest level of the desired power, based on either an RF conducted or radiated measurement, provided the transmitter demonstrates compliance with the peak conducted power limits.

§15.247(d)

If the transmitter complies with the conducted power limits based on the use of RMS averaging over a time interval, as permitted under paragraph (b)(3) of this section, the attenuation required under this paragraph shall be 30 dB instead of 20 dB. Attenuation below the general limits specified §15.209(a) is not required. In addition, radiated emissions which fall in the restricted bands, as defined in Section §15.205(a), must also comply with the radiated emission limits specified in Section 15.209(a) (see Section 15.205(a)).

RSS-210 §A8.5 If the transmitter complies with the conducted power limits based on the use of RMS averaging over a time interval, as permitted under section A8.4(4), the attenuation required shall be 30 dB instead of 20 dB. Attenuation below the general limits specified in Tables 2 and 3 is not required. In addition, radiated emissions which fall in the restricted bands of Table 1 must also comply with the radiated emission limits specified in Tables 2 and 3.

RSS-Gen §4.7

The search for unwanted emissions shall be from the lowest frequency internally generated or used in the device (local oscillator, intermediate of carrier frequency), or from 30 MHz , whichever is the lowest frequency, to the 5th harmonic of the highest frequency generated without exceeding 40 GHz.

Laboratory Measurement Uncertainty for Conducted Spurious Emissions

Measurement uncertainty	±2.37 dB
-------------------------	----------

Traceability

Method	Test Equipment Used
Measurements were made per work instruction WI-05 'Measurement of Spurious Emissions'	0088, 0158, 0287, 0252, 0313, 0314, 0070, 0116, 0117.

This test report may be reproduced in full only. The document may only be updated by MiCOM Labs personnel. Any changes will be noted in the Document History section of the report.



5.1.2. Radiated Emission Testing

Transmitter Radiated Spurious Emissions (above 1 GHz); Peak Field Strength Measurements; and Radiated Band Edge Measurements – Restricted Bands

FCC, Part 15 Subpart C §15.247(d) 15.205; 15.209

Industry Canada RSS-210 §A8.5, §2.2, §2.6

Industry Canada RSS-Gen §4.7

Test Procedure

Radiated emissions above 1 GHz are measured in the anechoic chamber at a 3-meter distance on every azimuth in both horizontal and vertical polarities. The emissions are recorded and maximized as a function of azimuth by rotation through 360° with a spectrum analyzer in peak hold mode. Depending on the frequency band spanned a notch filter and waveguide filter was used to remove the fundamental frequency. The highest emissions relative to the limit are listed for each frequency spanned.

All measurements on any frequency or frequencies over 1 MHz are based on the use of measurement instrumentation employing an average detector function. All measurements above 1 GHz were performed using a minimum resolution bandwidth of 1 MHz.

Field Strength Calculation

The field strength is calculated by adding the Antenna Factor and Cable Loss, and subtracting Amplifier Gain from the measured reading. All factors are included in the reported data.

$$FS = R + AF + CORR - FO$$

where: FS = Field Strength

R = Measured Spectrum analyzer Input Amplitude

AF = Antenna Factor

CORR = Correction Factor = CL – AG + NFL

CL = Cable Loss

AG = Amplifier Gain

FO = Distance Falloff Factor

NFL = Notch Filter Loss or Waveguide Loss

For example:

Given receiver input reading of 51.5 dB μ V; Antenna Factor of 8.5 dB; Cable Loss of 1.3 dB; Falloff Factor of 0 dB, an Amplifier Gain of 26 dB and Notch Filter Loss of 1 dB. The Field Strength of the measured emission is:

$$FS = 51.5 + 8.5 + 1.3 - 26.0 + 1 = 36.3 \text{ dB}\mu\text{V/m}$$

Conversion between dB μ V/m (or dB μ V) and μ V/m (or μ V) are done as:

$$\text{Level (dB}\mu\text{V/m)} = 20 * \text{Log (level (\mu\text{V/m}))}$$

$$40 \text{ dB}\mu\text{V/m} = 100 \mu\text{V/m}$$

$$48 \text{ dB}\mu\text{V/m} = 250 \mu\text{V/m}$$



Title: Silver Spring Network MicroAP
To: FCC 47 CFR Part 15.247 & IC RSS-210
Serial #: SSNT62-U4 Rev A
Issue Date: 13th August 2013
Page: 37 of 80

5.1.2.1. Integral antenna

Test Freq.	2405 MHz;	Engineer	SB
Variant	Cont TX	Temp (°C)	29
Freq. Range	1000 MHz - 18000 MHz	Rel. Hum.(%)	30
Power Setting	ATS112=15	Press. (mBars)	997
Antenna	Integral	Duty Cycle (%)	100
Test Notes 1	NIC 411-3G-070B;		
Test Notes 2	4VDC		

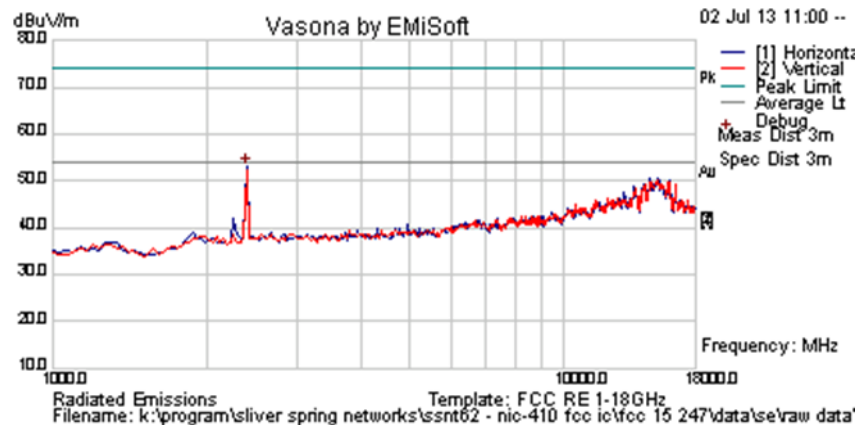

Formally measured emission peaks

Frequency MHz	Raw dBuV	Cable Loss	AF dB	Level dBuV/m	Measurement Type	Pol	Hgt cm	Azt Deg	Limit dBuV/m	Margin dB	Pass /Fail	Comments
2396.794	61.6	3.2	-11.7	53.1	Peak [Scan]	H	200					FUND
Legend: TX = Transmitter Emissions; DIG = Digital Emissions; FUND = Fundamental; WB = Wideband Emission RB = Restricted Band (15.209 Limits); NRB = Non Restricted Band, Limit is 20dB below fundamental peak												

This test report may be reproduced in full only. The document may only be updated by MiCOM Labs personnel. Any changes will be noted in the Document History section of the report.



Title: Silver Spring Network MicroAP
To: FCC 47 CFR Part 15.247 & IC RSS-210
Serial #: SSNT62-U4 Rev A
Issue Date: 13th August 2013
Page: 38 of 80

Test Freq.	2440 MHz;	Engineer	SB
Variant	Cont TX	Temp (°C)	29
Freq. Range	1000 MHz - 18000 MHz	Rel. Hum.(%)	30
Power Setting	ATS112=15	Press. (mBars)	997
Antenna	Integral	Duty Cycle (%)	100
Test Notes 1	NIC 411-3G-070B;		
Test Notes 2	4VDC		

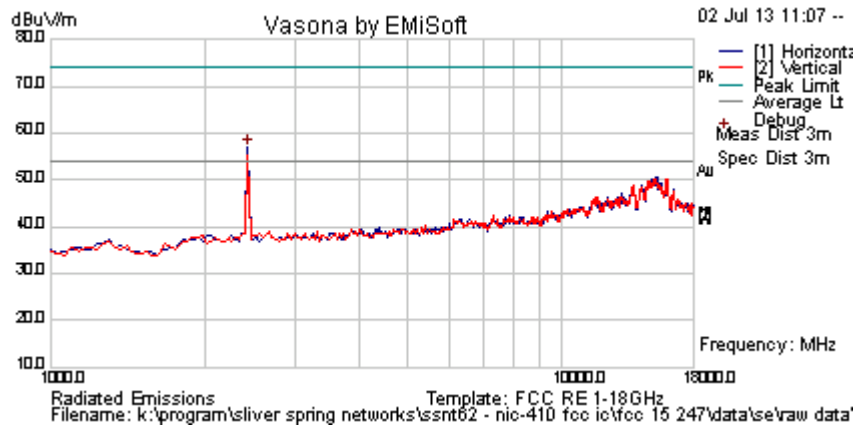

Formally measured emission peaks

Frequency MHz	Raw dBuV	Cable Loss	AF dB	Level dBuV/m	Measurement Type	Pol	Hgt cm	Azt Deg	Limit dBuV/m	Margin dB	Pass /Fail	Comments
2430.862	65.2	3.2	-11.6	56.9	Peak [Scan]	H	100					FUND
Legend: TX = Transmitter Emissions; DIG = Digital Emissions; FUND = Fundamental; WB = Wideband Emission RB = Restricted Band (15.209 Limits); NRB = Non Restricted Band, Limit is 20dB below fundamental peak												

This test report may be reproduced in full only. The document may only be updated by MiCOM Labs personnel. Any changes will be noted in the Document History section of the report.



Title: Silver Spring Network MicroAP
To: FCC 47 CFR Part 15.247 & IC RSS-210
Serial #: SSNT62-U4 Rev A
Issue Date: 13th August 2013
Page: 39 of 80

Test Freq.	2480 MHz;	Engineer	SB
Variant	Cont TX	Temp (°C)	29
Freq. Range	1000 MHz - 18000 MHz	Rel. Hum.(%)	30
Power Setting	ATS112=15	Press. (mBars)	997
Antenna	Integral	Duty Cycle (%)	100
Test Notes 1	NIC 411-3G-070B;		
Test Notes 2	4VDC		

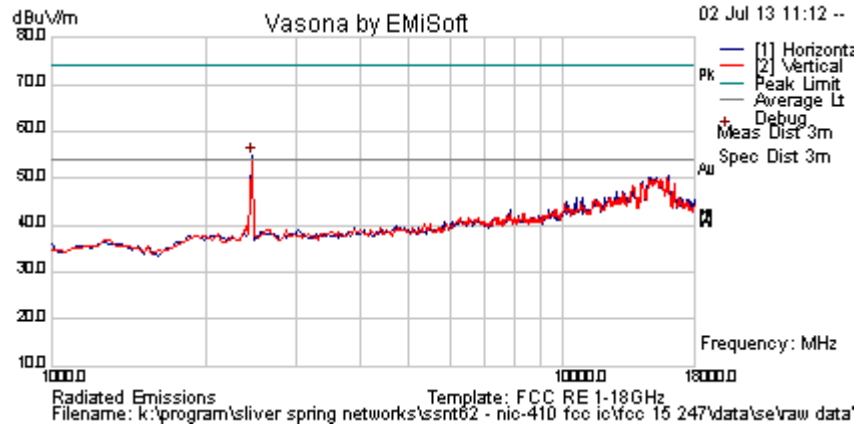

Formally measured emission peaks

Frequency MHz	Raw dBuV	Cable Loss	AF dB	Level dBuV/m	Measurement Type	Pol	Hgt cm	Azt Deg	Limit dBuV/m	Margin dB	Pass /Fail	Comments
2464.930	63.1	3.2	-11.5	54.8	Peak [Scan]	H	200					FUND
Legend: TX = Transmitter Emissions; DIG = Digital Emissions; FUND = Fundamental; WB = Wideband Emission RB = Restricted Band (15.209 Limits); NRB = Non Restricted Band, Limit is 20dB below fundamental peak												

This test report may be reproduced in full only. The document may only be updated by MiCOM Labs personnel. Any changes will be noted in the Document History section of the report.



Title: Silver Spring Network MicroAP
To: FCC 47 CFR Part 15.247 & IC RSS-210
Serial #: SSNT62-U4 Rev A
Issue Date: 13th August 2013
Page: 40 of 80

5.1.2.2. External antenna

Test Freq.	2405 MHz;	Engineer	SB
Variant	Cont TX	Temp (°C)	29
Freq. Range	1000 MHz - 18000 MHz	Rel. Hum.(%)	30
Power Setting	ATS112=15	Press. (mBars)	997
Antenna	WP WPANT 30017-CA (4 dBi)	Duty Cycle (%)	100
Test Notes 1	NIC 411-3G-070B;		
Test Notes 2	4VDC		

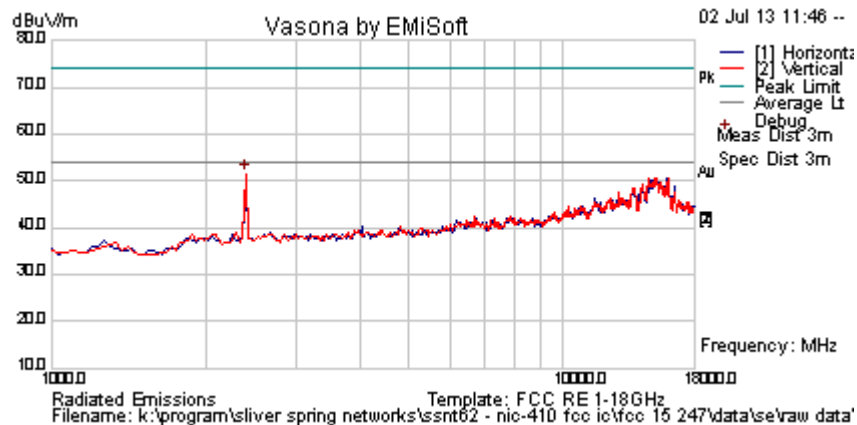

Formally measured emission peaks

Frequency MHz	Raw dBuV	Cable Loss	AF dB	Level dBuV/m	Measurement Type	Pol	Hgt cm	Azt Deg	Limit dBuV/m	Margin dB	Pass /Fail	Comments
2396.794	60.1	3.2	-11.7	51.6	Peak [Scan]	V	150					FUND
Legend: TX = Transmitter Emissions; DIG = Digital Emissions; FUND = Fundamental; WB = Wideband Emission RB = Restricted Band (15.209 Limits); NRB = Non Restricted Band, Limit is 20dB below fundamental peak												

This test report may be reproduced in full only. The document may only be updated by MiCOM Labs personnel. Any changes will be noted in the Document History section of the report.



Title: Silver Spring Network MicroAP
To: FCC 47 CFR Part 15.247 & IC RSS-210
Serial #: SSNT62-U4 Rev A
Issue Date: 13th August 2013
Page: 41 of 80

Test Freq.	2440 MHz;	Engineer	SB
Variant	Cont TX	Temp (°C)	29
Freq. Range	1000 MHz - 18000 MHz	Rel. Hum.(%)	30
Power Setting	ATS112=15	Press. (mBars)	997
Antenna	WP WPANT 30017-CA (4 dBi)	Duty Cycle (%)	100
Test Notes 1	NIC 411-3G-070B;		
Test Notes 2	4VDC		

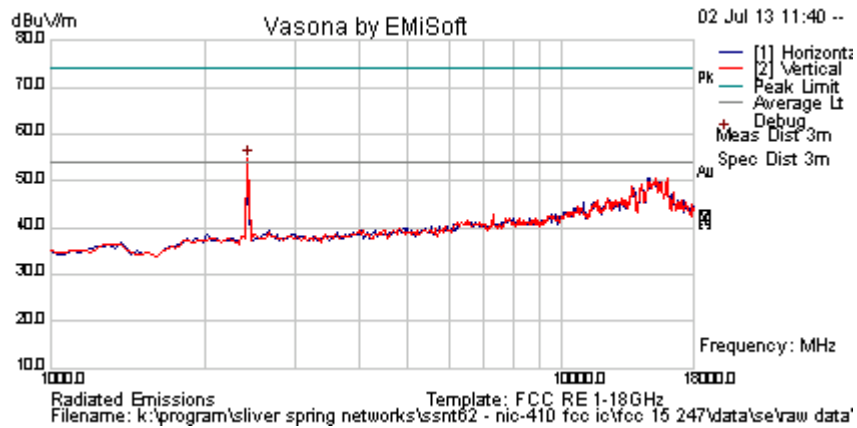

Formally measured emission peaks

Frequency MHz	Raw dBuV	Cable Loss	AF dB	Level dBuV/m	Measurement Type	Pol	Hgt cm	Azt Deg	Limit dBuV/m	Margin dB	Pass /Fail	Comments
2430.862	63.1	3.2	-11.6	54.7	Peak [Scan]	V	100					FUND
Legend: TX = Transmitter Emissions; DIG = Digital Emissions; FUND = Fundamental; WB = Wideband Emission RB = Restricted Band (15.209 Limits); NRB = Non Restricted Band, Limit is 20dB below fundamental peak												

This test report may be reproduced in full only. The document may only be updated by MiCOM Labs personnel. Any changes will be noted in the Document History section of the report.



Title: Silver Spring Network MicroAP
To: FCC 47 CFR Part 15.247 & IC RSS-210
Serial #: SSNT62-U4 Rev A
Issue Date: 13th August 2013
Page: 42 of 80

Test Freq.	2480 MHz;	Engineer	SB
Variant	Cont TX	Temp (°C)	29
Freq. Range	1000 MHz - 18000 MHz	Rel. Hum.(%)	30
Power Setting	ATS112=15	Press. (mBars)	997
Antenna	WP WPANT 30017-CA (4 dBi)	Duty Cycle (%)	100
Test Notes 1	NIC 411-3G-070B;		
Test Notes 2	4VDC		

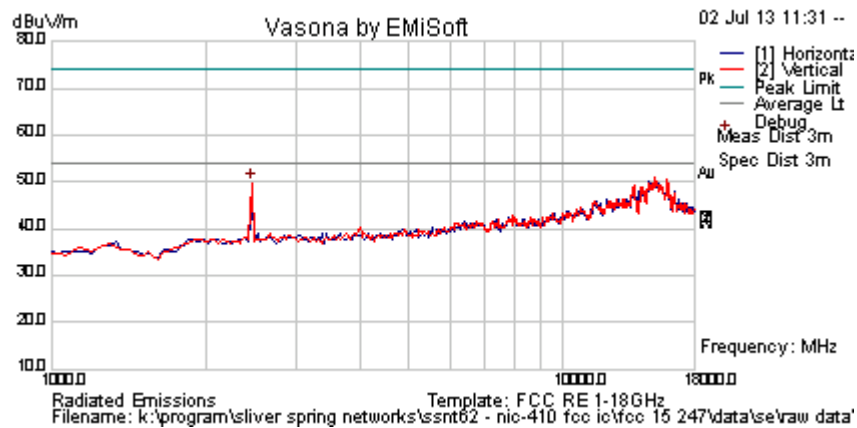

Formally measured emission peaks

Frequency MHz	Raw dBuV	Cable Loss	AF dB	Level dBuV/m	Measurement Type	Pol	Hgt cm	Azt Deg	Limit dBuV/m	Margin dB	Pass /Fail	Comments
2464.930	58.0	3.2	-11.5	49.7	Peak [Scan]	V	150					FUND

Legend: TX = Transmitter Emissions; DIG = Digital Emissions; FUND = Fundamental; WB = Wideband Emission
 RB = Restricted Band (15.209 Limits); NRB = Non Restricted Band, Limit is 20dB below fundamental peak

This test report may be reproduced in full only. The document may only be updated by MiCOM Labs personnel. Any changes will be noted in the Document History section of the report.

Specification Limits

FCC §15.247(d) and RSS-210 §A8.5 In any 100 kHz bandwidth outside the frequency band in which the spread spectrum or digitally modulated intentional radiator is operating, the radio frequency power that is produced by the intentional radiator shall be at least 20 dB below that in the 100 kHz bandwidth within the band that contains the highest level of the desired power, based on either an RF conducted or radiated measurement, provided the transmitter demonstrates compliance with the peak conducted power limits.

FCC §15.247(d)

If the transmitter complies with the conducted power limits based on the use of RMS averaging over a time interval, as permitted under paragraph (b)(3) of this section, the attenuation required under this paragraph shall be 30 dB instead of 20 dB. Attenuation below the general limits specified §15.209(a) is not required. In addition, radiated emissions which fall in the restricted bands, as defined in Section §15.205(a), must also comply with the radiated emission limits specified in Section 15.209(a) (see Section 15.205(a)).

IC RSS-210 §A8.5 If the transmitter complies with the conducted power limits based on the use of RMS averaging over a time interval, as permitted under section A8.4(4), the attenuation required shall be 30 dB instead of 20 dB. Attenuation below the general limits specified in Tables 2 and 3 is not required. In addition, radiated emissions which fall in the restricted bands of Table 1 must also comply with the radiated emission limits specified in Tables 2 and 3.

IC RSS-Gen §4.7

The search for unwanted emissions shall be from the lowest frequency internally generated or used in the device (local oscillator, intermediate or carrier frequency), or from 30 MHz, whichever is the lowest frequency, to the 5th harmonic of the highest frequency generated without exceeding 40 GHz.

FCC §15.205 (a) Except as shown in paragraph (d) of 15.205 (a), only spurious emissions are permitted in any of the frequency bands listed.

FCC §15.205 (a) Except as shown in paragraphs (d) and (e) of this section, the field strength of emissions appearing within these frequency bands shall not exceed the limits shown in Section §15.209. At frequencies equal to or less than 1000 MHz, compliance with the limits in Section 15.209 shall be demonstrated using measurement instrumentation employing a CISPR quasi-peak detector. Above 1000 MHz, compliance with the emission limits in Section 15.209 shall be demonstrated based on the average value of the measured emissions. The provisions in Section 15.35 apply to these measurements.

FCC §15.209 (a) Except as provided elsewhere in this subpart, the emissions from an intentional radiator shall not exceed the field strength levels specified in the following table.



Title: Silver Spring Network MicroAP
To: FCC 47 CFR Part 15.247 & IC RSS-210
Serial #: SSNT62-U4 Rev A
Issue Date: 13th August 2013
Page: 44 of 80

§15.209 (a) Limit Matrix

Frequency(MHz)	Field Strength ($\mu\text{V}/\text{m}$)	Field Strength ($\text{dB}\mu\text{V}/\text{m}$)	Measurement Distance (meters)
30-88	100	40.0	3
88-216	150	43.5	3
216-960	200	46.0	3
Above 960	500	54.0	3

Laboratory Measurement Uncertainty for Radiated Emissions

Measurement uncertainty	+5.6/ -4.5 dB
-------------------------	---------------

Traceability

Method	Test Equipment Used
Measurements were made per work instruction WI-03 'Measurement of Radiated Emissions'	0088, 0158, 0134, 0304, 0311, 0315, 0310, 0312

This test report may be reproduced in full only. The document may only be updated by MiCOM Labs personnel. Any changes will be noted in the Document History section of the report.

5.1.2.3. Digital Emissions (0.03-1 GHz)

FCC, Part 15 Subpart C §15.205/ §15.209
Industry Canada RSS-210 §2.2

Test Procedure

Testing 30M-1 GHz was performed in a 3-meter anechoic chamber using a CISPR compliant receiver. Preliminary radiated emissions were measured on every azimuth and with the receiving antenna in both horizontal and vertical polarizations. To further maximize emissions the receive antenna was varied between 1 and 4 meters. The emissions are recorded with receiver in peak hold mode. Emissions closest to the limits are measured in the quasi-peak mode with the tuned receiver using a bandwidth of 120 kHz. Only the highest emissions relative to the limit are listed. The anechoic chamber test set-up is identified in Section 6 Test Set-Up Photographs.

The EUT had two methods of powering on ac/dc converter and Power over Ethernet (POE). Both modes were tested for emissions below 1GHz.

Field Strength Calculation

The field strength is calculated by adding the Antenna Factor and Cable Loss, and subtracting Amplifier Gain from the measured reading. In this test facility, the Antenna Factor, Cable Loss, and Amplifier Gains are loaded into the Rohde & Schwarz Receiver and the corrected field strength can be read directly on the receiver.

$$FS = R + AF + CORR$$

where:

FS = Field Strength
R = Measured Receiver Input Amplitude
AF = Antenna Factor
CORR = Correction Factor = CL – AG + NFL
CL = Cable Loss
AG = Amplifier Gain

For example:

Given a Receiver input reading of 51.5dB μ V; Antenna Factor of 8.5dB; Cable Loss of 1.3dB; Falloff Factor of 0dB, an Amplifier Gain of 26dB and Notch Filter Loss of 1dB. The Field Strength of the measured emission is:

$$FS = 51.5 + 8.5 + 1.3 - 26.0 + 1 = 36.3\text{dB}\mu\text{V/m}$$

Conversion between dB μ V/m (or dB μ V) and μ V/m (or μ V) are done as:

$$\text{Level (dB}\mu\text{V/m)} = 20 * \text{Log (level (\mu\text{V/m}))}$$

$$40 \text{ dB}\mu\text{V/m} = 100\mu\text{V/m}$$

$$48 \text{ dB}\mu\text{V/m} = 250\mu\text{V/m}$$

This test report may be reproduced in full only. The document may only be updated by MiCOM Labs personnel. Any changes will be noted in the Document History section of the report.



Title: Silver Spring Network MicroAP
To: FCC 47 CFR Part 15.247 & IC RSS-210
Serial #: SSNT62-U4 Rev A
Issue Date: 13th August 2013
Page: 46 of 80

Test Freq.	915.2 MHz;	Engineer	SB
Variant	Digital Emissions	Temp (°C)	29
Freq. Range	30 MHz - 1000 MHz	Rel. Hum.(%)	30
Power Setting	ATS112=15	Press. (mBars)	997
Antenna	Integral	Duty Cycle (%)	100
Test Notes 1	NIC 411-3G-070B;		
Test Notes 2	4VDC		

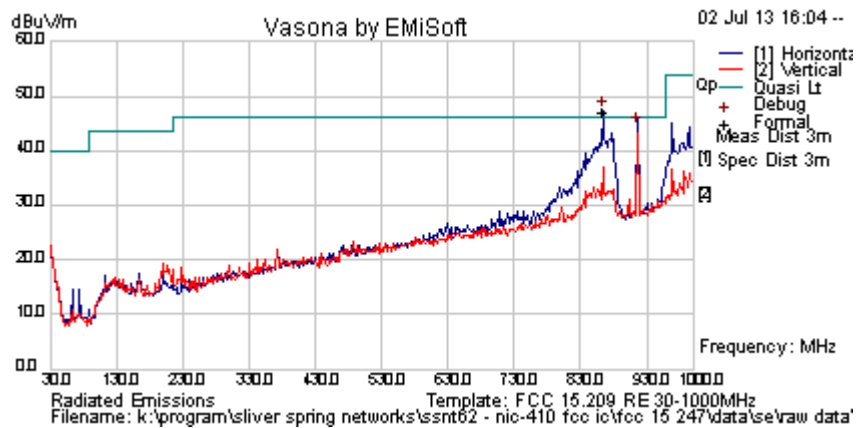

Formally measured emission peaks

Frequency MHz	Raw dBuV	Cable Loss	AF dB	Level dBuV/m	Measurement Type	Pol	Hgt cm	Azt Deg	Limit dBuV/m	Margin dB	Pass /Fail	Comments
863.144	48.6	7.0	-8.2	47.4	Peak [Scan]	H	100					NRB
916.586	45.0	7.2	-7.7	44.5	Peak [Scan]	H	98	360	46	-1.6	Pass	

Legend: DIG = Digital Device Emission; TX = Transmitter Emission; FUND = Fundamental Frequency
 NRB = Non-Restricted Band, Limit is 20 dB below Fundamental; RB = Restricted Band

This test report may be reproduced in full only. The document may only be updated by MiCOM Labs personnel. Any changes will be noted in the Document History section of the report.



Specification

Limits

§15.205 (a) Except as shown in paragraph (d) of 15.205 (a), only spurious emissions are permitted in any of the frequency bands listed.

§15.205 (a) Except as shown in paragraphs (d) and (e) of this section, the field strength of emissions appearing within these frequency bands shall not exceed the limits shown in Section §15.209. At frequencies equal to or less than 1000 MHz, compliance with the limits in Section 15.209 shall be demonstrated using measurement instrumentation employing a CISPR quasi-peak detector. Above 1000 MHz, compliance with the emission limits in Section 15.209 shall be demonstrated based on the average value of the measured emissions. The provisions in Section 15.35 apply to these measurements.

§15.209 (a) Except as provided elsewhere in this subpart, the emissions from an intentional radiator shall not exceed the field strength levels specified in the following table.

§15.209 (a) and RSS-Gen §2.2 Limit Matrix

Frequency(MHz)	Field Strength ($\mu\text{V/m}$)	Field Strength ($\text{dB}\mu\text{V/m}$)	Measurement Distance (meters)
30-88	100	40.0	3
88-216	150	43.5	3
216-960	200	46.0	3
Above 960	500	54.0	3

Laboratory Measurement Uncertainty for Radiated Emissions

Measurement uncertainty	+5.6/ -4.5 dB
-------------------------	---------------

Traceability

Method	Test Equipment Used
Measurements were made per work instruction WI-03 'Measurement of Radiated Emissions'	0088, 0158, 0134, 0304, 0311, 0315, 0310, 0312

This test report may be reproduced in full only. The document may only be updated by MiCOM Labs personnel. Any changes will be noted in the Document History section of the report.

5.1.3. AC Wireline Conducted Emissions (150 kHz – 30 MHz)

This test not required device is dc powered

FCC, Part 15 Subpart C §15.207
Industry Canada RSS-Gen §7.2.2

Test Procedure

The EUT is configured in accordance with ANSI C63.4. The conducted emissions are measured in a shielded room with a spectrum analyzer in peak hold in the first instance. Emissions closest to the limit are measured in the quasi-peak mode (QP) with the tuned receiver using a bandwidth of 9 kHz. The emissions are maximized further by cable manipulation. The highest emissions relative to the limit are listed.

Test Measurement Set up

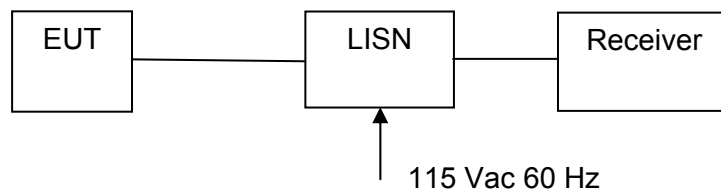

Measurement set up for AC Wireline Conducted Emissions Test

Measurement Results for AC Wireline Conducted Emissions (150 kHz – 30 MHz)

Ambient conditions.

Temperature: 17 to 23 °C Relative humidity: 31 to 57 % Pressure: 999 to 1012 mbar

Specification

Limit

§15.207 (a) Except as shown in paragraphs (b) and (c) of this section, for an intentional radiator that is designed to be connected to the public utility (AC) power line, the radio frequency voltage that is conducted back onto the AC power line on any frequency or frequencies within the band 150 kHz to 30 MHz shall not exceed the limits in the following table, as measured using a 50 $\mu\Omega$ line impedance stabilization network (LISN), see §15.207 (a) matrix below. Compliance with the provisions of this paragraph shall be based on the measurement of the radio frequency voltage between each power line and ground at the power terminal.

RSS-Gen §7.2.2

The radio frequency voltage that is conducted back into the AC power lines in the frequency range of 0.15 MHz to 30 MHz shall not exceed the limits shown in the table below. The tighter limit applies at the frequency range boundaries.

§15.207 (a) and RSS-Gen §7.2.2 Limit Matrix

The lower limit applies at the boundary between frequency ranges

Frequency of Emission (MHz)	Conducted Limit (dB μ V)	
	Quasi-peak	Average
0.15-0.5	66 to 56*	56 to 46*
0.5-5	56	46
5-30	60	50

* Decreases with the logarithm of the frequency

Laboratory Measurement Uncertainty for Conducted Emissions

Measurement uncertainty	± 2.64 dB
-------------------------	---------------

Traceability

Method	Test Equipment Used
Measurements were made per work instruction WI-EMC-01 'Measurement of Conducted Emissions'	0158, 0184, 0287, 0190, 0293, 0307

This test report may be reproduced in full only. The document may only be updated by MiCOM Labs personnel. Any changes will be noted in the Document History section of the report.

6. PHOTOGRAPHS

6.1. Conducted Test Setup

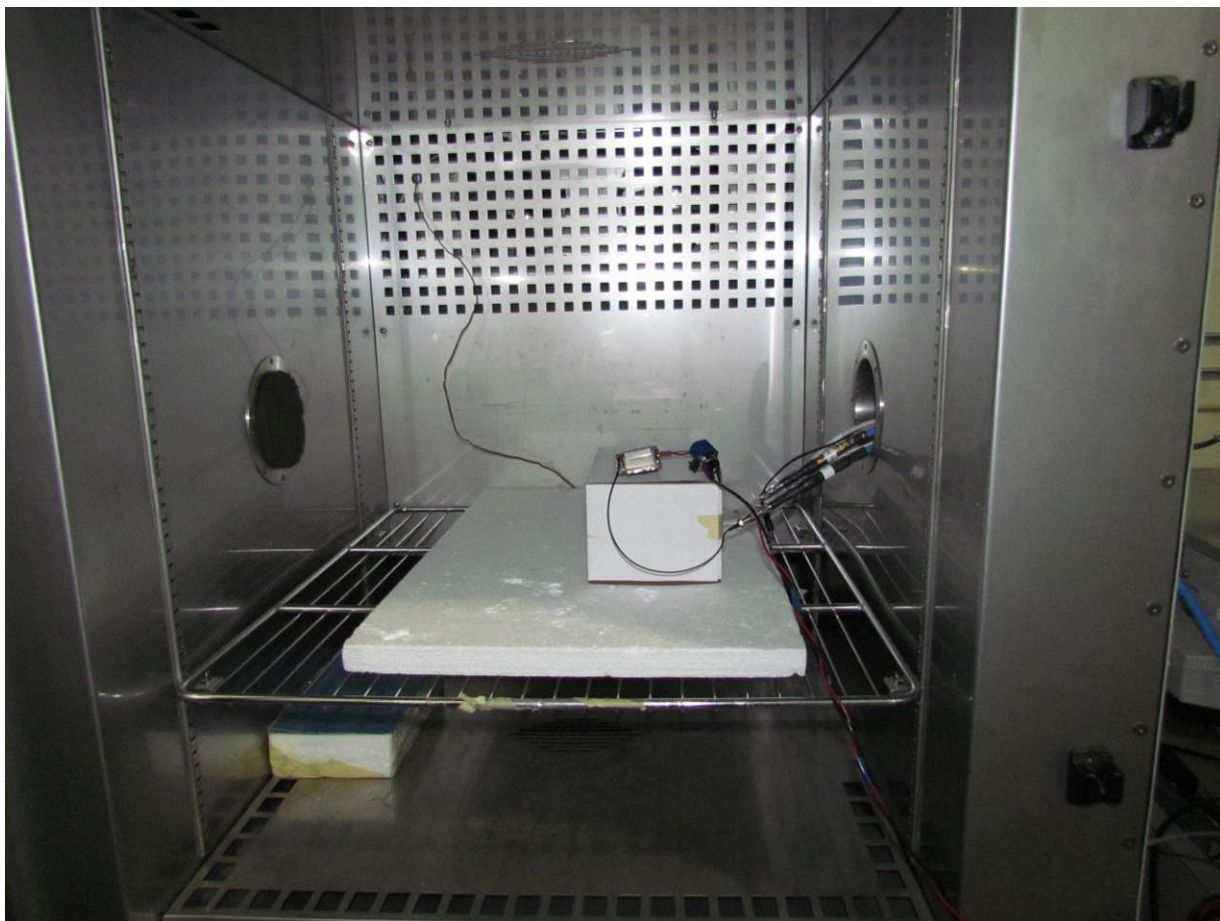

This test report may be reproduced in full only. The document may only be updated by MiCOM Labs personnel. Any changes will be noted in the Document History section of the report.

6.2. Test Setup - Digital Emissions below 1 GHz



This test report may be reproduced in full only. The document may only be updated by MiCOM Labs personnel. Any changes will be noted in the Document History section of the report.

6.3. Radiated Emissions Test Setup >1 GHz

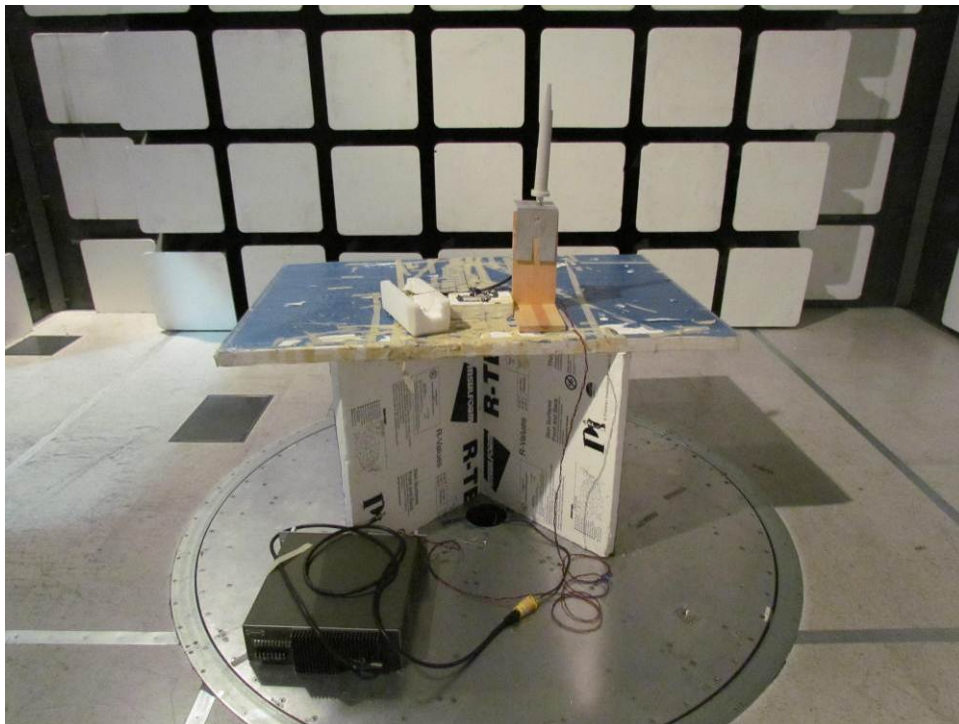
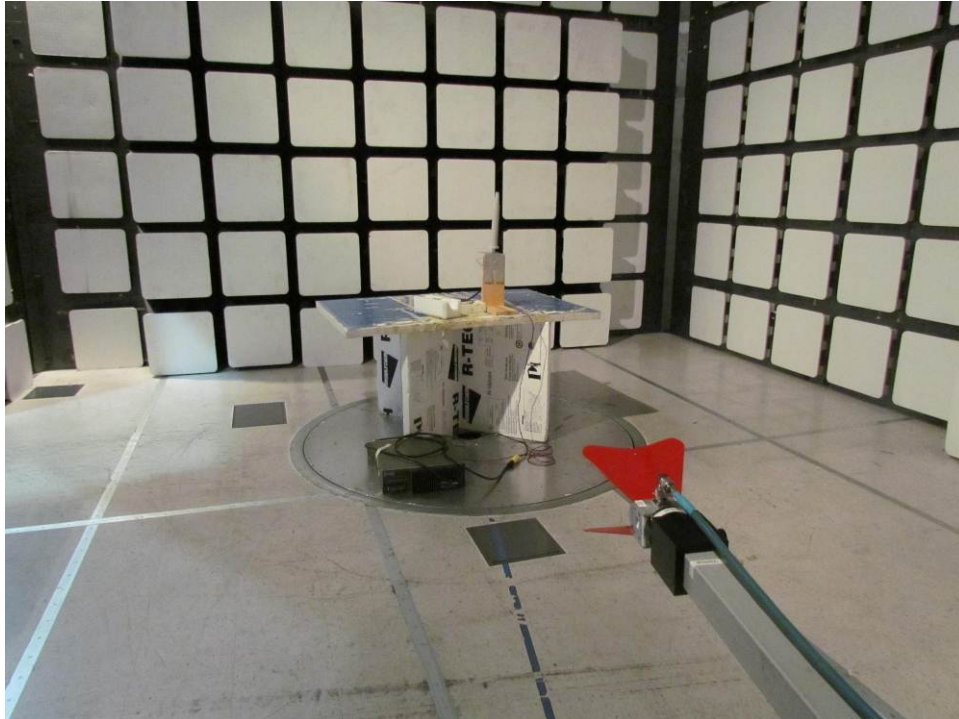

This test report may be reproduced in full only. The document may only be updated by MiCOM Labs personnel. Any changes will be noted in the Document History section of the report.



Title: Silver Spring Network MicroAP
To: FCC 47 CFR Part 15.247 & IC RSS-210
Serial #: SSNT62-U4 Rev A
Issue Date: 13th August 2013
Page: 53 of 80

7. TEST EQUIPMENT

Asset #	Instrument	Manufacturer	Part #	Serial #	Calibration Due Date
0070	Power Meter	Hewlett Packard	437B	3125U11552	28 th Nov 13
0117	Power Sensor	Hewlett Packard	8487D	3318A00371	15 th Nov 13
0223	Power Meter	Hewlett Packard	EPM-442A	US37480256	15 th Nov 13
0374	Power Sensor	Hewlett Packard	8485A	3318A19694	29 th Nov 13
0158	Barometer /Thermometer	Control Co.	4196	E2846	8 th Dec 13
0193	EMI Receiver	Rhode & Schwartz	ESI 7	838496/007	2 nd Dec 13
0287	EMI Receiver	Rhode & Schwartz	ESIB40	100201	16 th Nov 13
0338	30 - 3000 MHz Antenna	Sunol	JB3	A052907	8 th Nov 13
0335	1-18 GHz Horn Antenna	EMCO	3117	00066580	7 th Nov 13
0252	SMA Cable	Megaphase	Sucoflex 104	None	N/A
0293	BNC Cable	Megaphase	1689 1GVT4	15F50B001	N/A
0307	BNC Cable	Megaphase	1689 1GVT4	15F50B002	N/A
0310	2m SMA Cable	Micro-Coax	UFA210A-0-0787-3G03G0	209089-001	N/A
0312	3m SMA Cable	Micro-Coax	UFA210A-1-1181-3G0300	209092-001	N/A
0314	30dB N-Type Attenuator	ARRA	N9444-30	1623	N/A
	EMC Test Software	EMISoft	Vasona	5.0051	N/A
	RF Conducted Test Software	National Instruments	Labview	Version 8.2	N/A
	RF Conducted Test Software	MiCOM Labs ATS		Version 1.5	N/A

This test report may be reproduced in full only. The document may only be updated by MiCOM Labs personnel. Any changes will be noted in the Document History section of the report.



Title: Silver Spring Network MicroAP
To: FCC 47 CFR Part 15.247 & IC RSS-210
Serial #: SSNT62-U4 Rev A
Issue Date: 13th August 2013
Page: 54 of 80

APPENDIX

A. SUPPORTING INFORMATION

A.1. CONDUCTED TEST PLOTS

This test report may be reproduced in full only. The document may only be updated by MiCOM Labs personnel. Any changes will be noted in the Document History section of the report.

A.1.1. 6 dB & 99% Bandwidth



6 dB & 99% BANDWIDTH

Variant: 802.15.4, Channel: 2405.00 MHz, Chain a, Temp: Ambient, Voltage: 4 Vdc

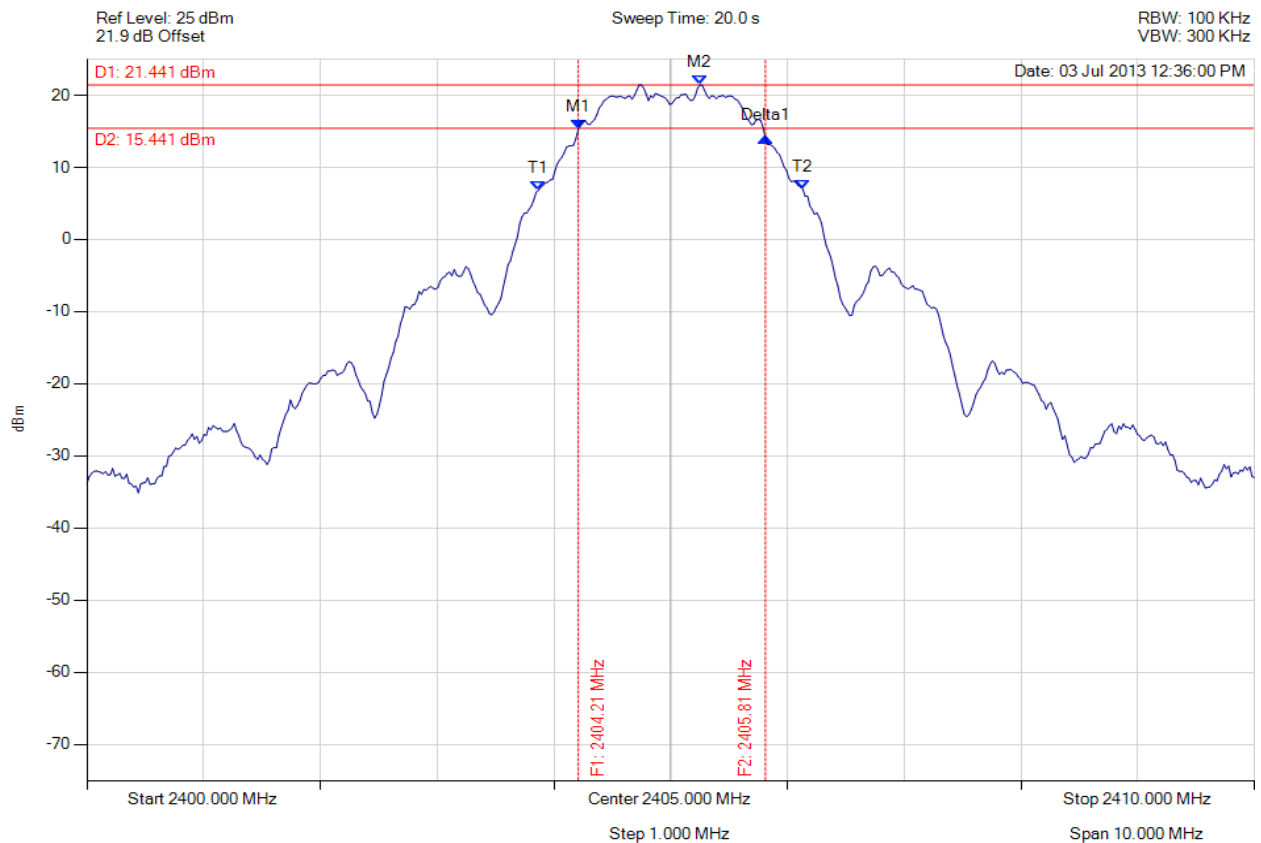

Analyser Setup	Marker : Frequency : Amplitude	Test Results
Detector = MAX PEAK Sweep Count = 0 RF Atten (dB) = 20 Trace Mode = VIEW	M1 : 2404.208 MHz : 15.250 dBm M2 : 2405.251 MHz : 21.441 dBm Delta1 : 1.603 MHz : -1.180 dB T1 : 2403.868 MHz : 6.812 dBm T2 : 2406.132 MHz : 6.936 dBm OBW : 2.265 MHz	Measured 6 dB Bandwidth: 1.603 MHz Limit: ≥ 500.0 kHz Margin: -1.10 MHz

[Back to the Matrix](#)

This test report may be reproduced in full only. The document may only be updated by MiCOM Labs personnel. Any changes will be noted in the Document History section of the report.



6 dB & 99% BANDWIDTH

Variant: 802.15.4, Channel: 2440.00 MHz, Chain a, Temp: Ambient, Voltage: 4 Vdc

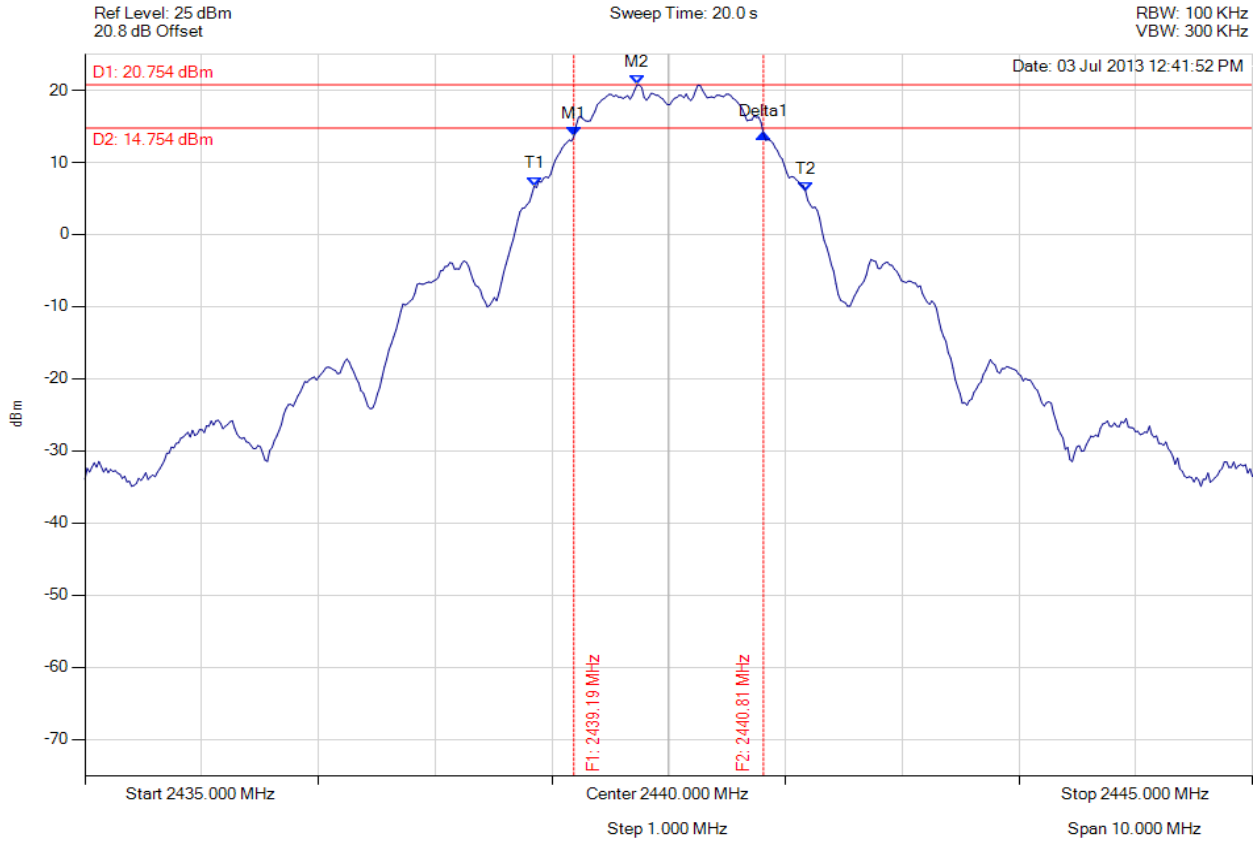

Analyser Setup	Marker : Frequency : Amplitude	Test Results
Detector = MAX PEAK Sweep Count = 0 RF Atten (dB) = 20 Trace Mode = VIEW	M1 : 2439.188 MHz : 13.601 dBm M2 : 2439.729 MHz : 20.754 dBm Delta1 : 1.623 MHz : 0.403 dB T1 : 2438.848 MHz : 6.717 dBm T2 : 2441.172 MHz : 5.976 dBm OBW : 2.325 MHz	Measured 6 dB Bandwidth: 1.623 MHz Limit: ≥500.0 kHz Margin: -1.12 MHz

[Back to the Matrix](#)

This test report may be reproduced in full only. The document may only be updated by MiCOM Labs personnel. Any changes will be noted in the Document History section of the report.



6 dB & 99% BANDWIDTH

Variant: 802.15.4, Channel: 2480.00 MHz, Chain a, Temp: Ambient, Voltage: 4 Vdc

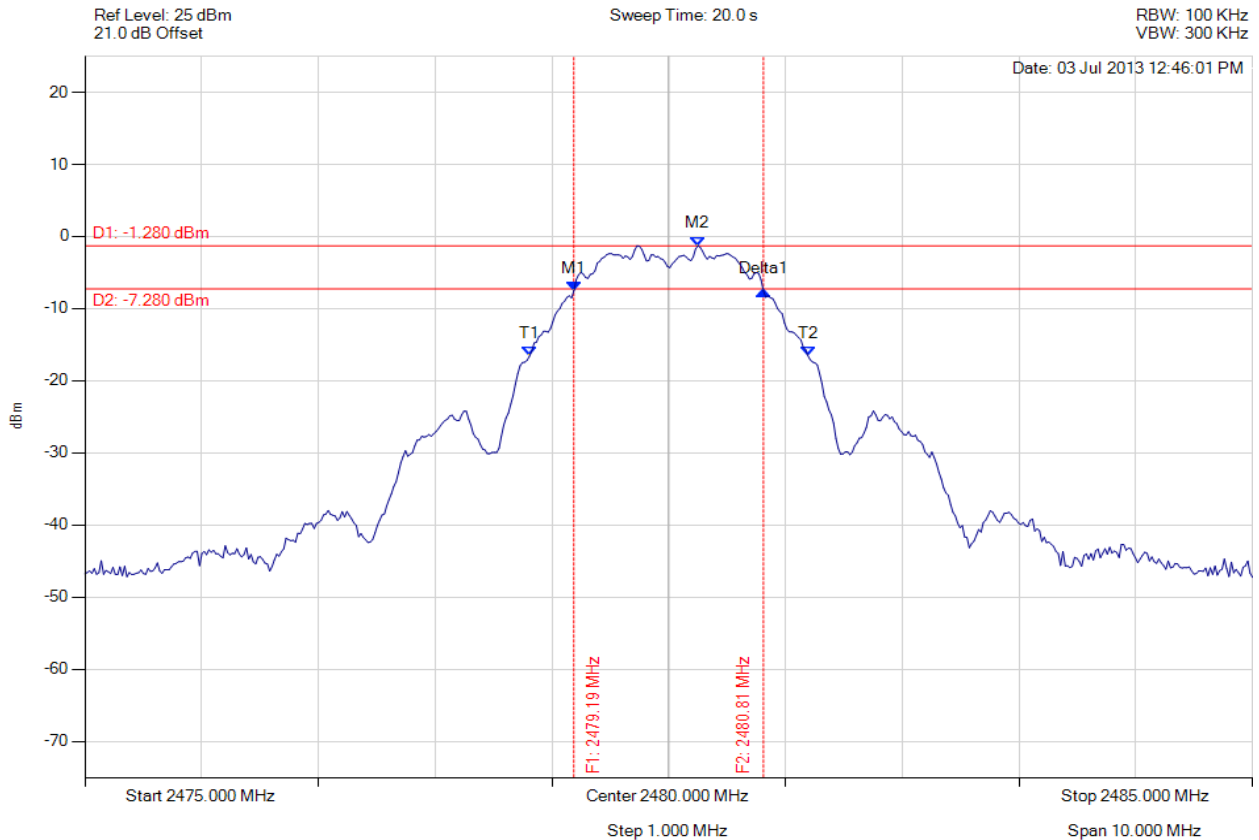

Analyser Setup	Marker : Frequency : Amplitude	Test Results
Detector = MAX PEAK Sweep Count = 0 RF Atten (dB) = 20 Trace Mode = VIEW	M1 : 2479.188 MHz : -7.540 dBm M2 : 2480.251 MHz : -1.280 dBm Delta1 : 1.623 MHz : 0.000 dB T1 : 2478.808 MHz : -16.600 dBm T2 : 2481.192 MHz : -16.509 dBm OBW : 2.385 MHz	Measured 6 dB Bandwidth: 1.623 MHz Limit: ≥500.0 kHz Margin: -1.12 MHz

[Back to the Matrix](#)

This test report may be reproduced in full only. The document may only be updated by MiCOM Labs personnel. Any changes will be noted in the Document History section of the report.



6 dB & 99% BANDWIDTH

Variant: 802.15.4, Channel: 2405.00 MHz, Chain a, Temp: Ambient, Voltage: 4 Vdc

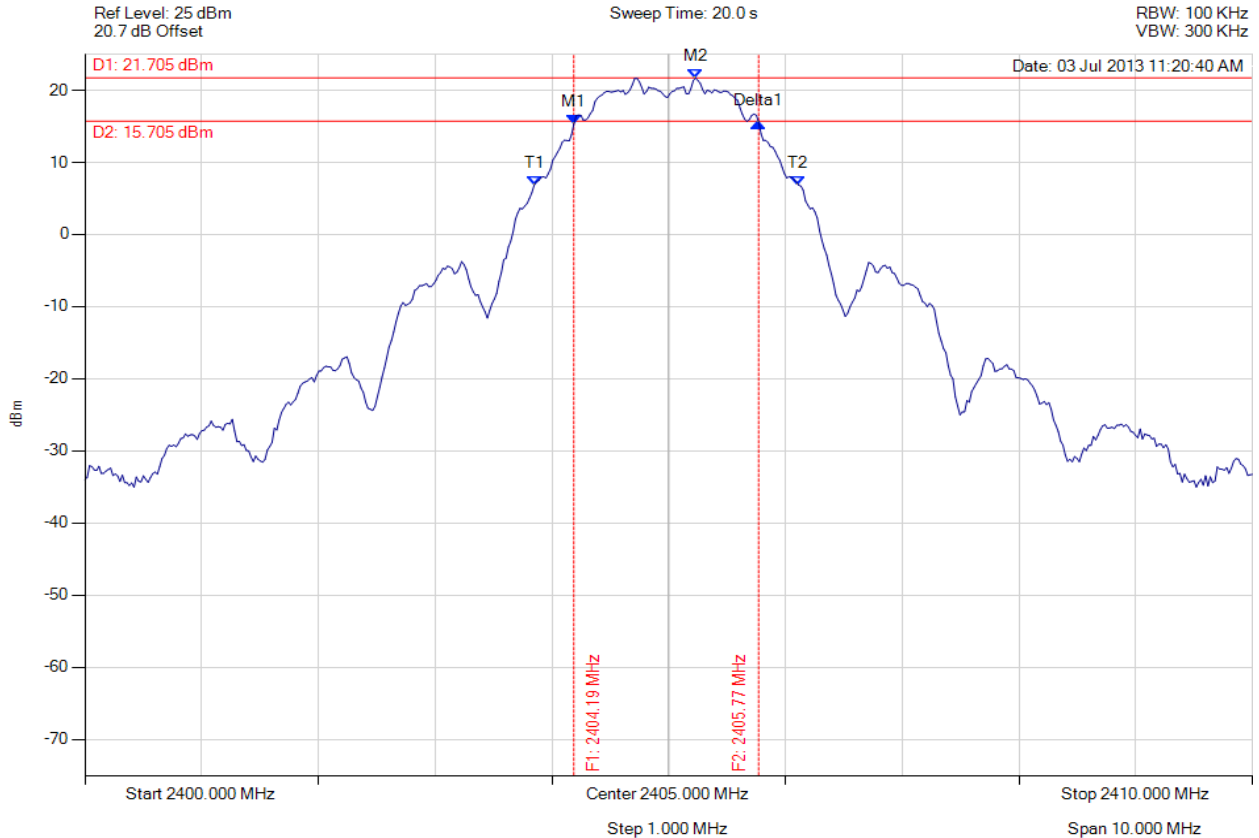

Analyser Setup	Marker : Frequency : Amplitude	Test Results
Detector = MAX PEAK Sweep Count = 0 RF Atten (dB) = 20 Trace Mode = VIEW	M1 : 2404.188 MHz : 15.342 dBm M2 : 2405.230 MHz : 21.705 dBm Delta1 : 1.583 MHz : 0.175 dB T1 : 2403.848 MHz : 6.833 dBm T2 : 2406.112 MHz : 6.859 dBm OBW : 2.265 MHz	Measured 6 dB Bandwidth: 1.583 MHz Limit: ≥ 500.0 kHz Margin: -1.08 MHz

[Back to the Matrix](#)

This test report may be reproduced in full only. The document may only be updated by MiCOM Labs personnel. Any changes will be noted in the Document History section of the report.



6 dB & 99% BANDWIDTH

Variant: 802.15.4, Channel: 2440.00 MHz, Chain a, Temp: Ambient, Voltage: 4 Vdc

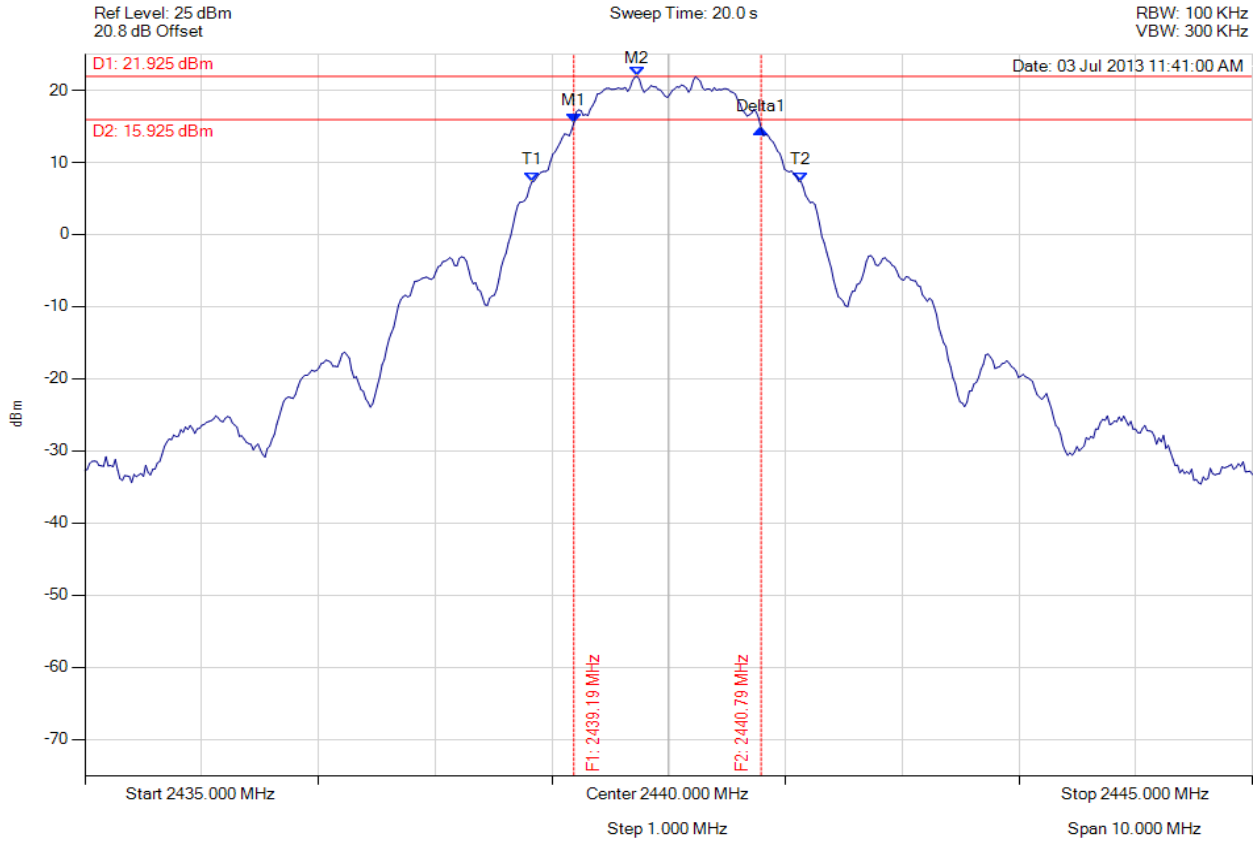

Analyser Setup	Marker : Frequency : Amplitude	Test Results
Detector = MAX PEAK Sweep Count = 0 RF Atten (dB) = 20 Trace Mode = VIEW	M1 : 2439.188 MHz : 15.474 dBm M2 : 2439.729 MHz : 21.925 dBm Delta1 : 1.603 MHz : -0.773 dB T1 : 2438.828 MHz : 7.276 dBm T2 : 2441.132 MHz : 7.371 dBm OBW : 2.305 MHz	Measured 6 dB Bandwidth: 1.603 MHz Limit: ≥500.0 kHz Margin: -1.10 MHz

[Back to the Matrix](#)

This test report may be reproduced in full only. The document may only be updated by MiCOM Labs personnel. Any changes will be noted in the Document History section of the report.



6 dB & 99% BANDWIDTH

Variant: 802.15.4, Channel: 2480.00 MHz, Chain a, Temp: Ambient, Voltage: 4 Vdc

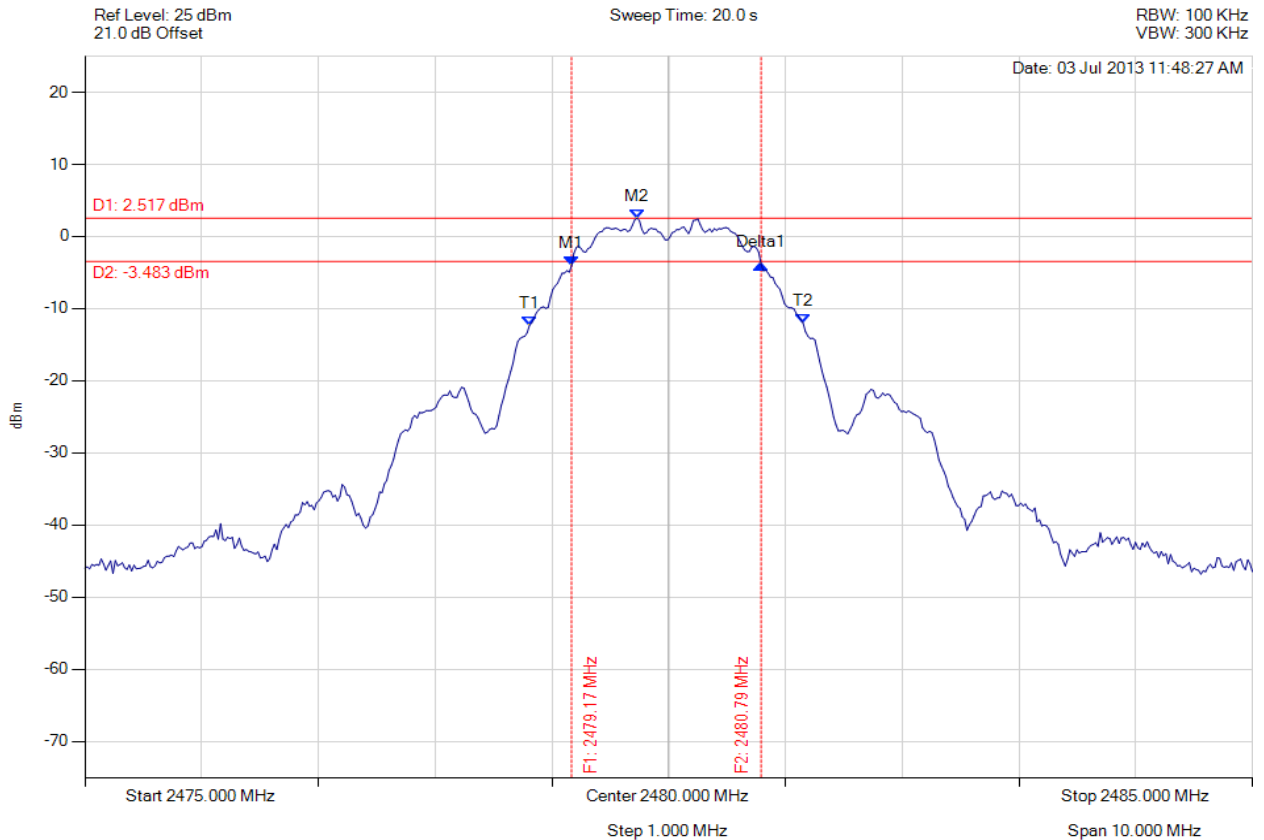

Analyser Setup	Marker : Frequency : Amplitude	Test Results
Detector = MAX PEAK Sweep Count = 0 RF Atten (dB) = 20 Trace Mode = VIEW	M1 : 2479.168 MHz : -4.042 dBm M2 : 2479.729 MHz : 2.517 dBm Delta1 : 1.623 MHz : 0.173 dB T1 : 2478.808 MHz : -12.333 dBm T2 : 2481.152 MHz : -12.073 dBm OBW : 2.345 MHz	Measured 6 dB Bandwidth: 1.623 MHz Limit: ≥500.0 kHz Margin: -1.12 MHz

[Back to the Matrix](#)

This test report may be reproduced in full only. The document may only be updated by MiCOM Labs personnel. Any changes will be noted in the Document History section of the report.

A.1.2. Peak Output Power



PEAK OUTPUT POWER

Variant: 802.15.4, Channel: 2405.00 MHz, Chain a, Temp: Ambient, Voltage: 4 Vdc

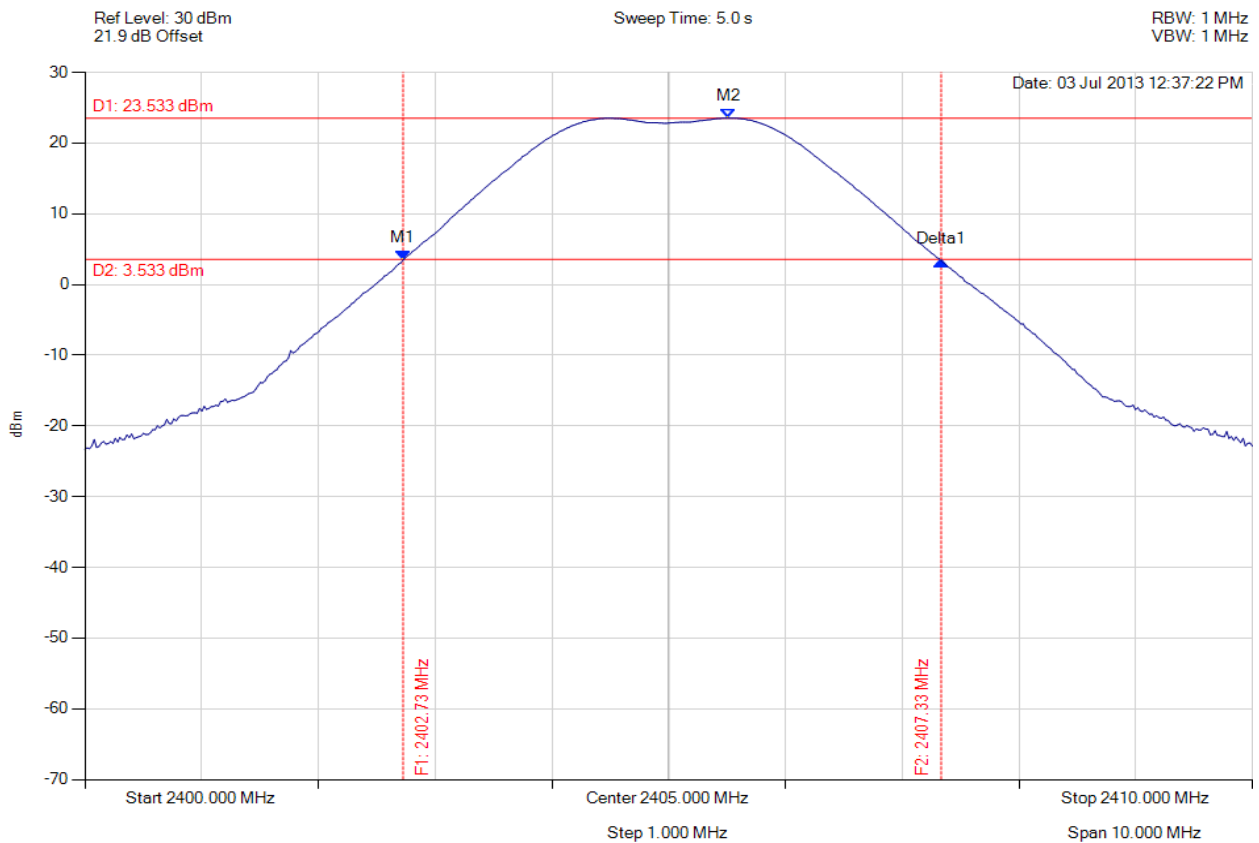

Analyser Setup	Marker : Frequency : Amplitude	Test Results
Detector = MAX PEAK Sweep Count = 0 RF Atten (dB) = 20 Trace Mode = VIEW	M1 : 2402.725 MHz : 3.437 dBm M2 : 2405.511 MHz : 23.533 dBm Delta1 : 4.609 MHz : -0.065 dB	Channel Power: 22.71 dBm Limit: 30.00 dBm Margin: dB

[Back to the Matrix](#)

This test report may be reproduced in full only. The document may only be updated by MiCOM Labs personnel. Any changes will be noted in the Document History section of the report.



PEAK OUTPUT POWER

Variant: 802.15.4, Channel: 2440.00 MHz, Chain a, Temp: Ambient, Voltage: 4 Vdc

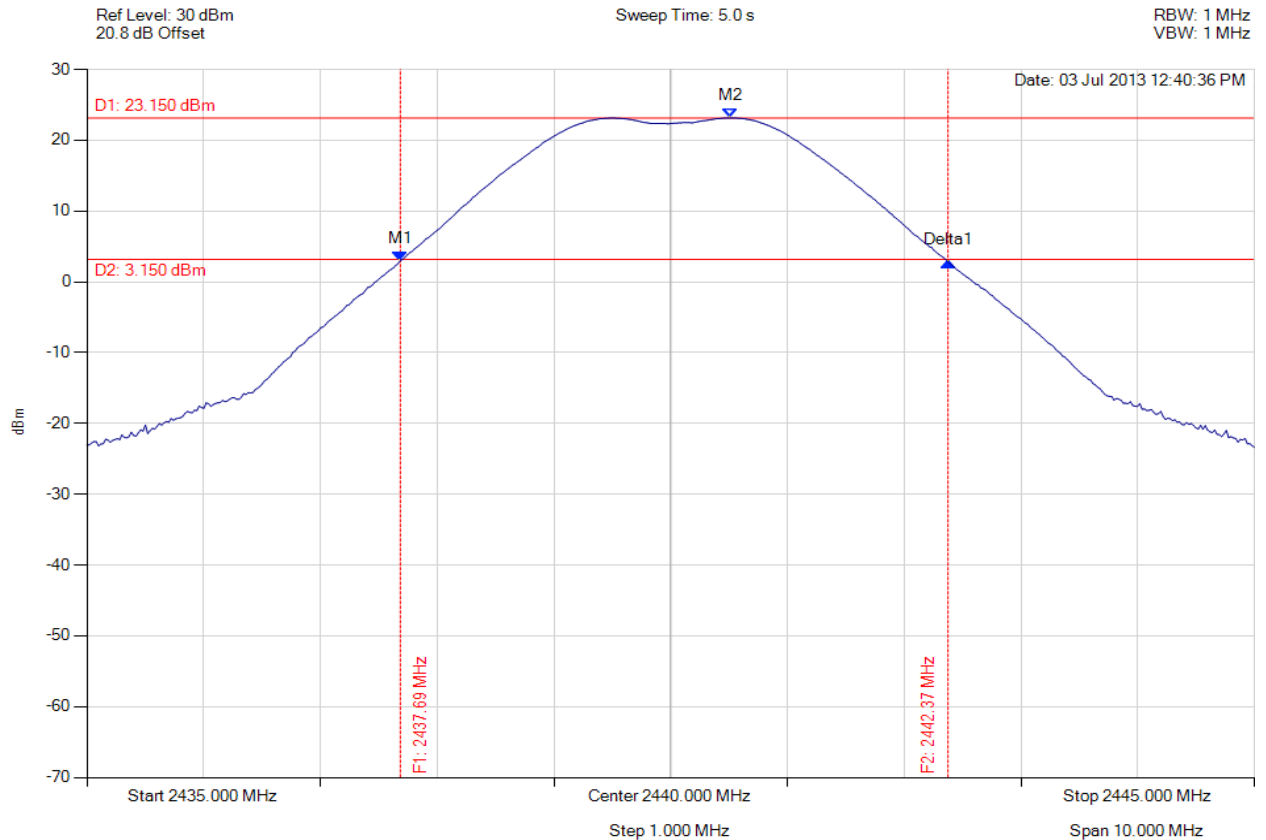

Analyser Setup	Marker : Frequency : Amplitude	Test Results
Detector = MAX PEAK Sweep Count = 0 RF Atten (dB) = 20 Trace Mode = VIEW	M1 : 2437.685 MHz : 3.008 dBm M2 : 2440.511 MHz : 23.150 dBm Delta1 : 4.689 MHz : -0.199 dB	Channel Power: 22.57 dBm Limit: 30.00 dBm Margin: dB

[Back to the Matrix](#)

This test report may be reproduced in full only. The document may only be updated by MiCOM Labs personnel. Any changes will be noted in the Document History section of the report.



PEAK OUTPUT POWER

Variant: 802.15.4, Channel: 2480.00 MHz, Chain a, Temp: Ambient, Voltage: 4 Vdc

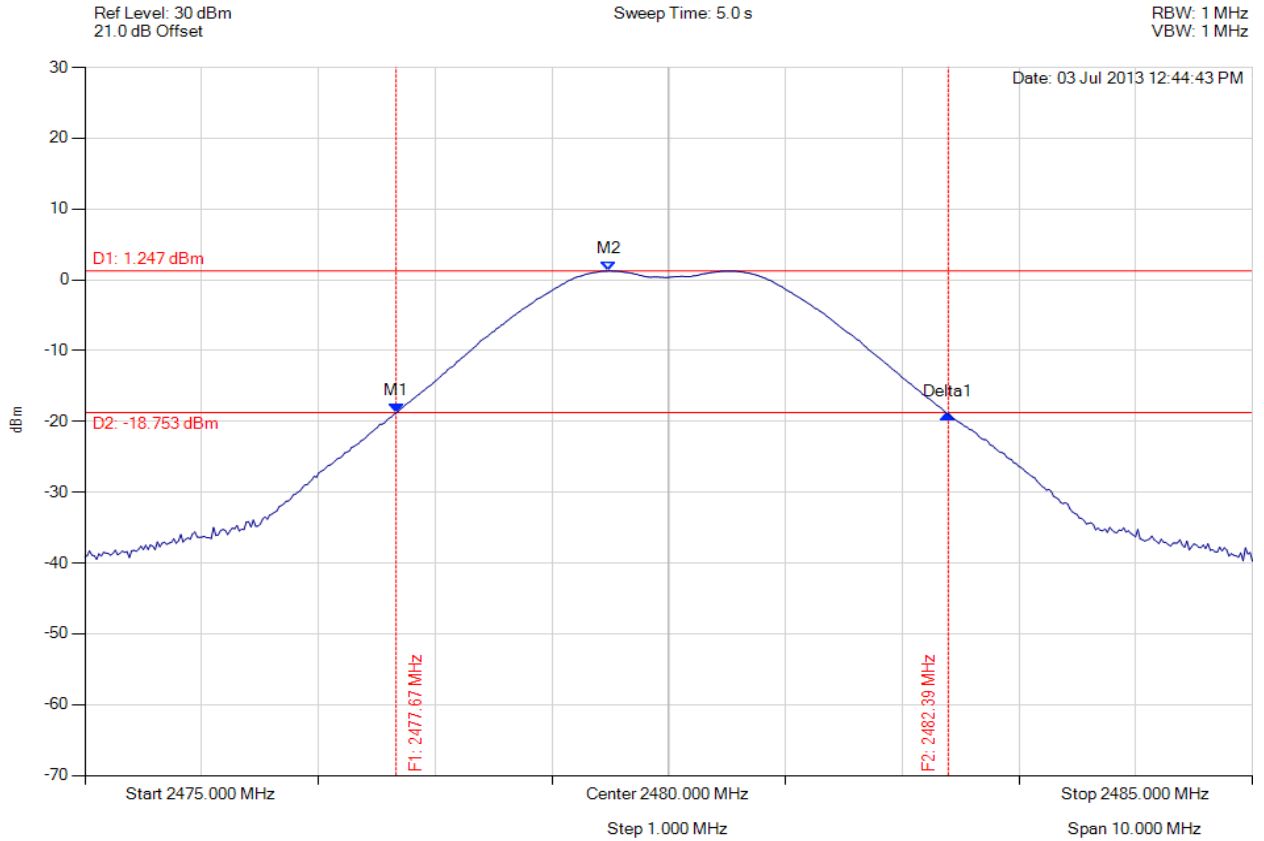

Analyser Setup	Marker : Frequency : Amplitude	Test Results
Detector = MAX PEAK Sweep Count = 0 RF Atten (dB) = 20 Trace Mode = VIEW	M1 : 2477.665 MHz : -18.798 dBm M2 : 2479.489 MHz : 1.247 dBm Delta1 : 4.729 MHz : -0.209 dB	Channel Power: 0.36 dBm Limit: 30.00 dBm Margin: dB

[Back to the Matrix](#)

This test report may be reproduced in full only. The document may only be updated by MiCOM Labs personnel. Any changes will be noted in the Document History section of the report.



AVERAGE OUTPUT POWER

Variant: 802.15.4, Channel: 2405.00 MHz, Chain a, Temp: Ambient, Voltage: 4 Vdc

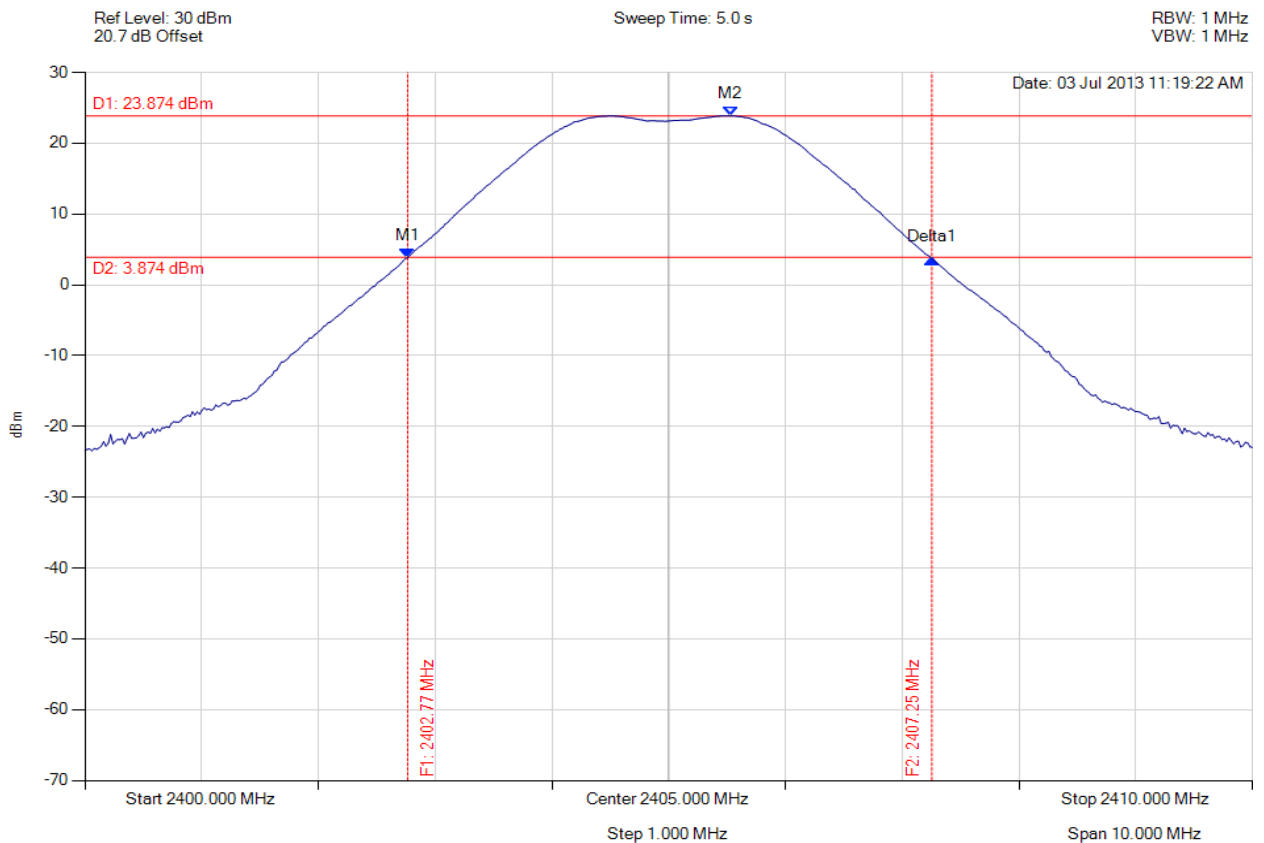

Analyser Setup	Marker : Frequency : Amplitude	Test Results
Detector = MAX PEAK Sweep Count = 0 RF Atten (dB) = 20 Trace Mode = VIEW	M1 : 2402.766 MHz : 3.868 dBm M2 : 2405.531 MHz : 23.874 dBm Delta1 : 4.489 MHz : -0.177 dB	Channel Power: 22.91 dBm Limit: 30.00 dBm Margin: dB

[Back to the Matrix](#)

This test report may be reproduced in full only. The document may only be updated by MiCOM Labs personnel. Any changes will be noted in the Document History section of the report.



AVERAGE OUTPUT POWER

Variant: 802.15.4, Channel: 2440.00 MHz, Chain a, Temp: Ambient, Voltage: 4 Vdc

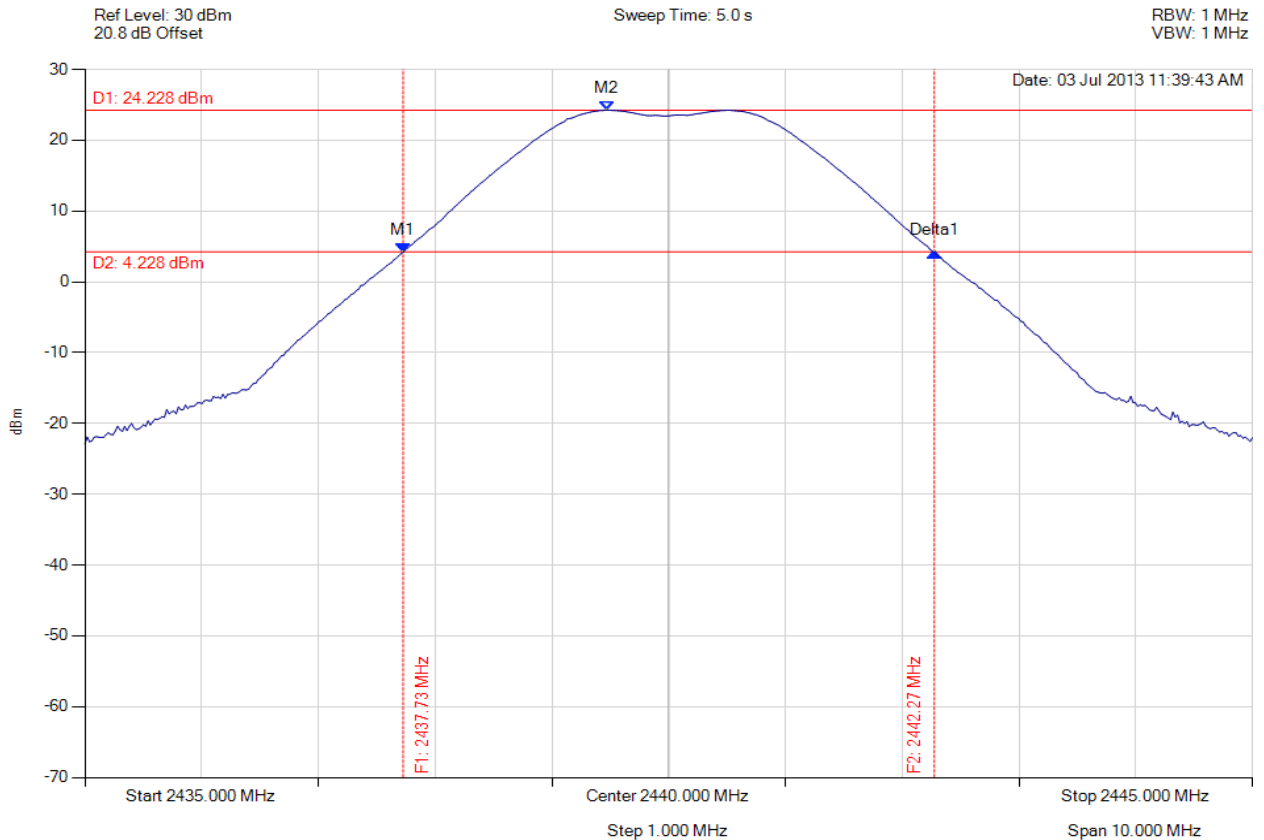

Analyser Setup	Marker : Frequency : Amplitude	Test Results
Detector = MAX PEAK Sweep Count = 0 RF Atten (dB) = 20 Trace Mode = VIEW	M1 : 2437.725 MHz : 4.169 dBm M2 : 2439.469 MHz : 24.228 dBm Delta1 : 4.549 MHz : -0.041 dB	Channel Power: 23.59 dBm Limit: 30.00 dBm Margin: dB

[Back to the Matrix](#)

This test report may be reproduced in full only. The document may only be updated by MiCOM Labs personnel. Any changes will be noted in the Document History section of the report.



AVERAGE OUTPUT POWER

Variant: 802.15.4, Channel: 2480.00 MHz, Chain a, Temp: Ambient, Voltage: 4 Vdc

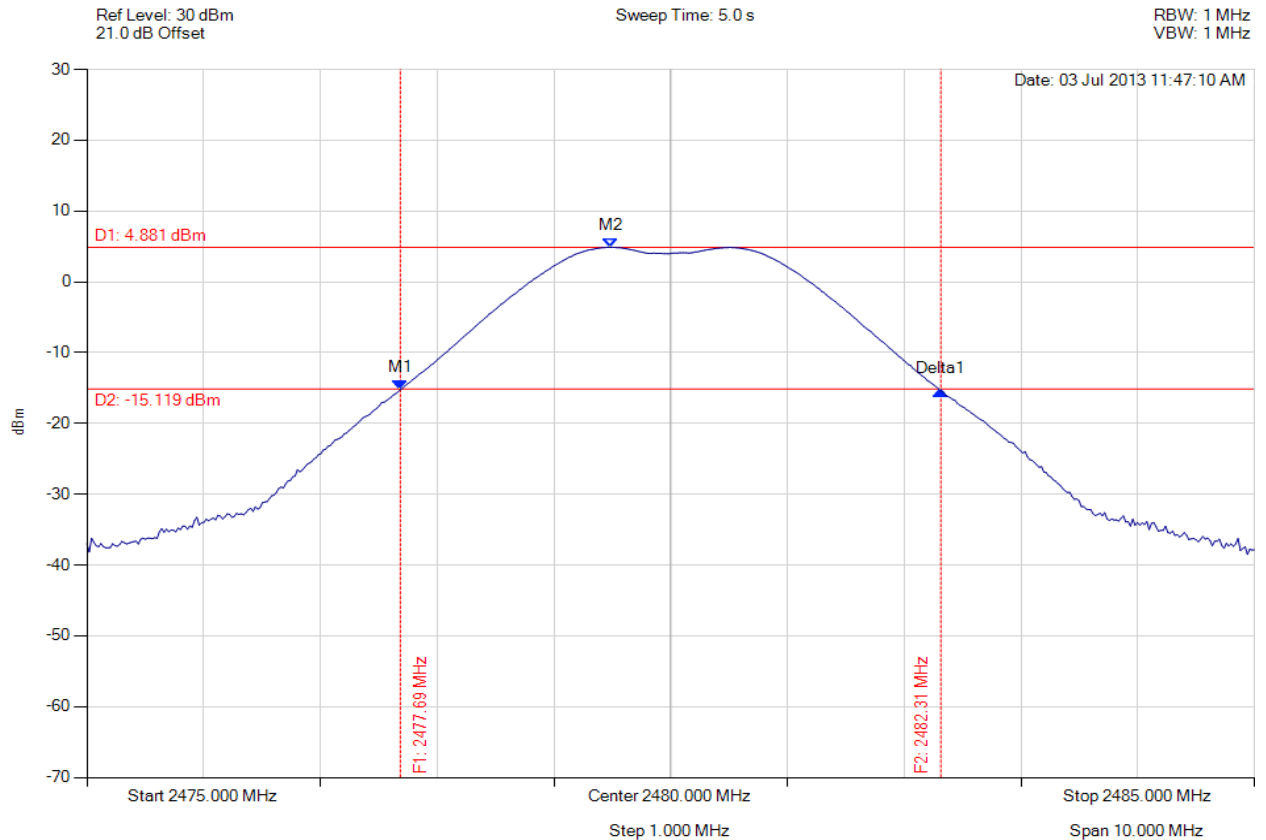

Analyser Setup	Marker : Frequency : Amplitude	Test Results
Detector = MAX PEAK Sweep Count = 0 RF Atten (dB) = 20 Trace Mode = VIEW	M1 : 2477.685 MHz : -15.235 dBm M2 : 2479.489 MHz : 4.881 dBm Delta1 : 4.629 MHz : -0.181 dB	Channel Power: 4.32 dBm Limit: 30.00 dBm Margin: dB

[Back to the Matrix](#)

This test report may be reproduced in full only. The document may only be updated by MiCOM Labs personnel. Any changes will be noted in the Document History section of the report.

A.1.3. Power Spectral Density



POWER SPECTRAL DENSITY - AVERAGE

Variant: 802.15.4, Channel: 2405.00 MHz, Chain a, Temp: Ambient, Voltage: 4 Vdc

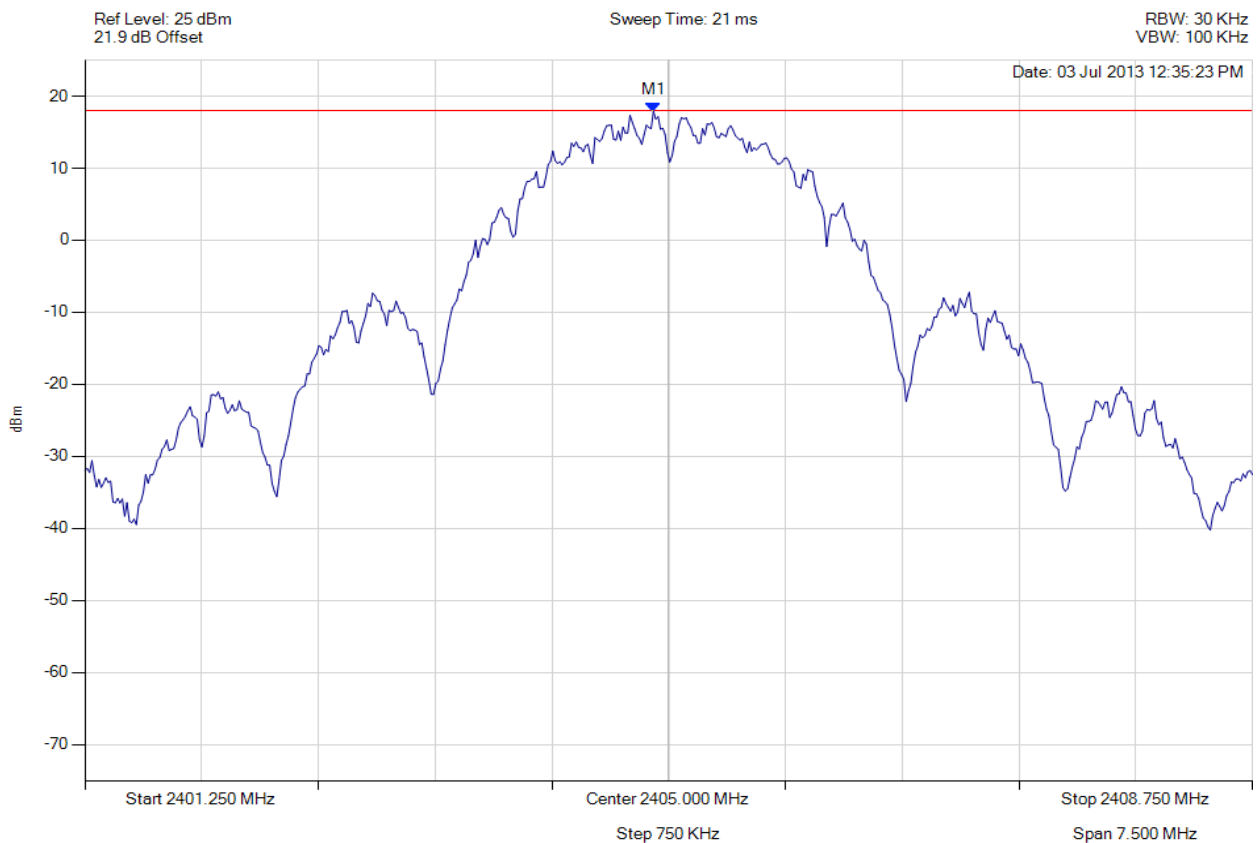

Analyser Setup	Marker : Frequency : Amplitude	Test Results
Detector = MAX PEAK Sweep Count = 0 RF Atten (dB) = 20 Trace Mode = VIEW	M1 : 2404.902 MHz : 17.886 dBm	Limit: ≤ 18.000 dBm Margin: -0.11 dB

[Back to the Matrix](#)

This test report may be reproduced in full only. The document may only be updated by MiCOM Labs personnel. Any changes will be noted in the Document History section of the report.



Title: Silver Spring Network MicroAP
To: FCC 47 CFR Part 15.247 & IC RSS-210
Serial #: SSNT62-U4 Rev A
Issue Date: 13th August 2013
Page: 68 of 80



POWER SPECTRAL DENSITY - AVERAGE

Variant: 802.15.4, Channel: 2440.00 MHz, Chain a, Temp: Ambient, Voltage: 4 Vdc

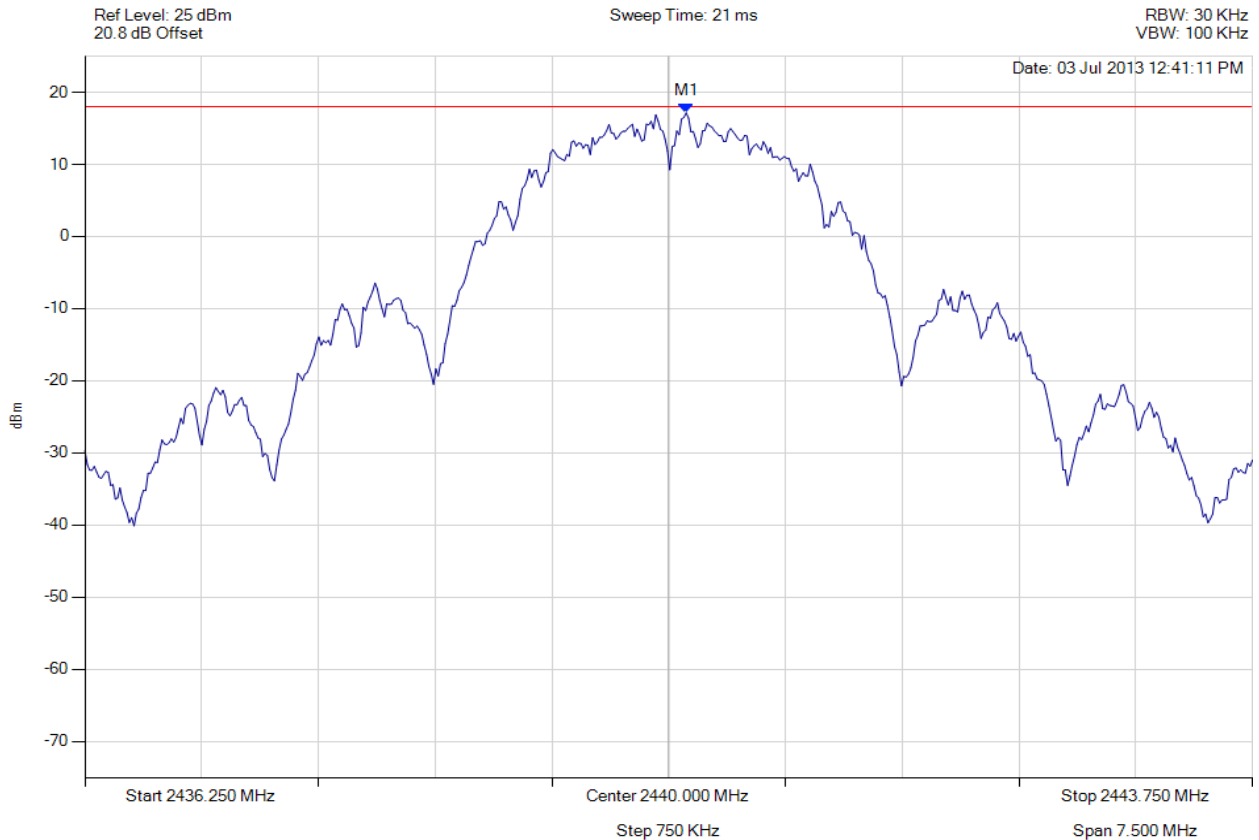

Analyser Setup	Marker : Frequency : Amplitude	Test Results
Detector = MAX PEAK Sweep Count = 0 RF Atten (dB) = 20 Trace Mode = VIEW	M1 : 2440.113 MHz : 17.136 dBm	Limit: ≤ 18.000 dBm Margin: -0.86 dB

[Back to the Matrix](#)

This test report may be reproduced in full only. The document may only be updated by MiCOM Labs personnel. Any changes will be noted in the Document History section of the report.



Title: Silver Spring Network MicroAP
To: FCC 47 CFR Part 15.247 & IC RSS-210
Serial #: SSNT62-U4 Rev A
Issue Date: 13th August 2013
Page: 69 of 80



POWER SPECTRAL DENSITY - AVERAGE

Variant: 802.15.4, Channel: 2480.00 MHz, Chain a, Temp: Ambient, Voltage: 4 Vdc

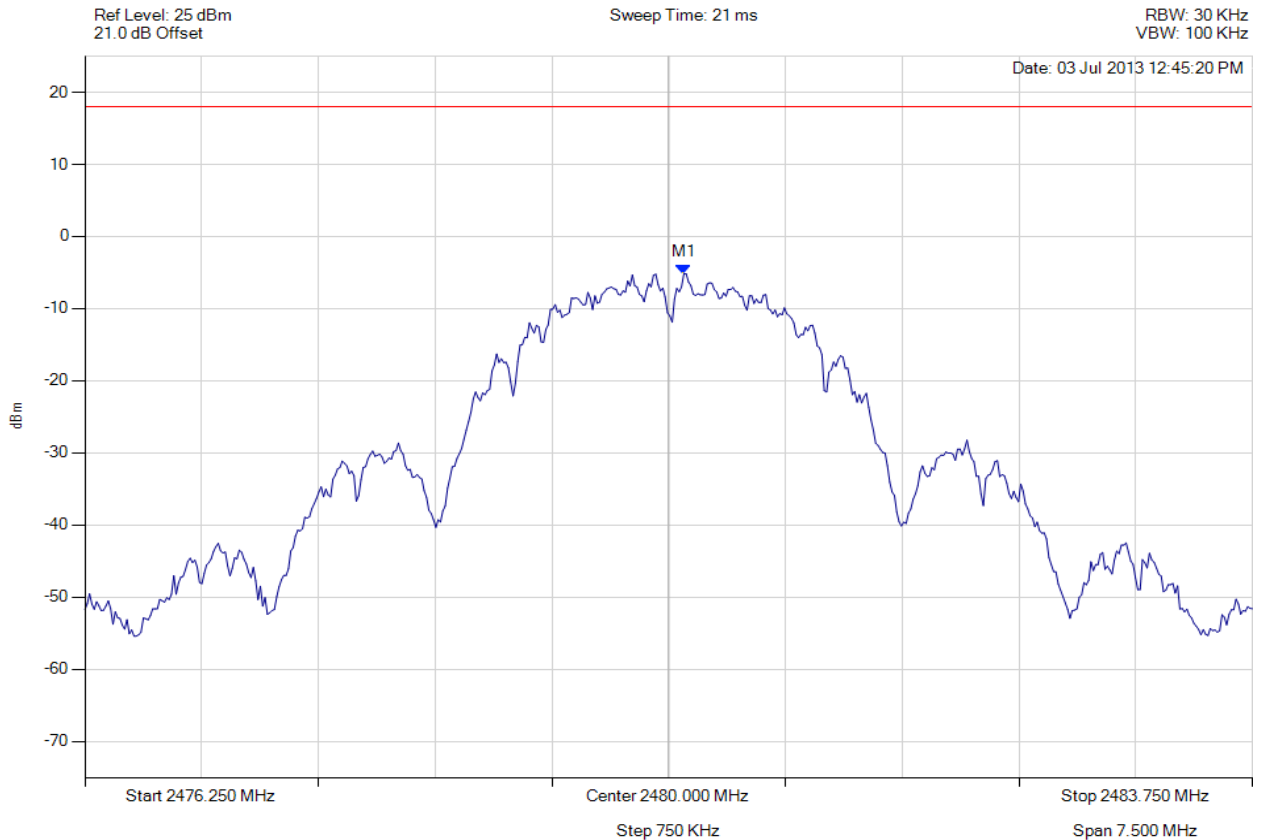

Analyser Setup	Marker : Frequency : Amplitude	Test Results
Detector = MAX PEAK Sweep Count = 0 RF Atten (dB) = 20 Trace Mode = VIEW	M1 : 2480.098 MHz : -5.175 dBm	Limit: ≤ 18.000 dBm Margin: -23.18 dB

[Back to the Matrix](#)

This test report may be reproduced in full only. The document may only be updated by MiCOM Labs personnel. Any changes will be noted in the Document History section of the report.



Title: Silver Spring Network MicroAP
To: FCC 47 CFR Part 15.247 & IC RSS-210
Serial #: SSNT62-U4 Rev A
Issue Date: 13th August 2013
Page: 70 of 80



POWER SPECTRAL DENSITY - AVERAGE

Variant: 802.15.4, Channel: 2405.00 MHz, Chain a, Temp: Ambient, Voltage: 4 Vdc

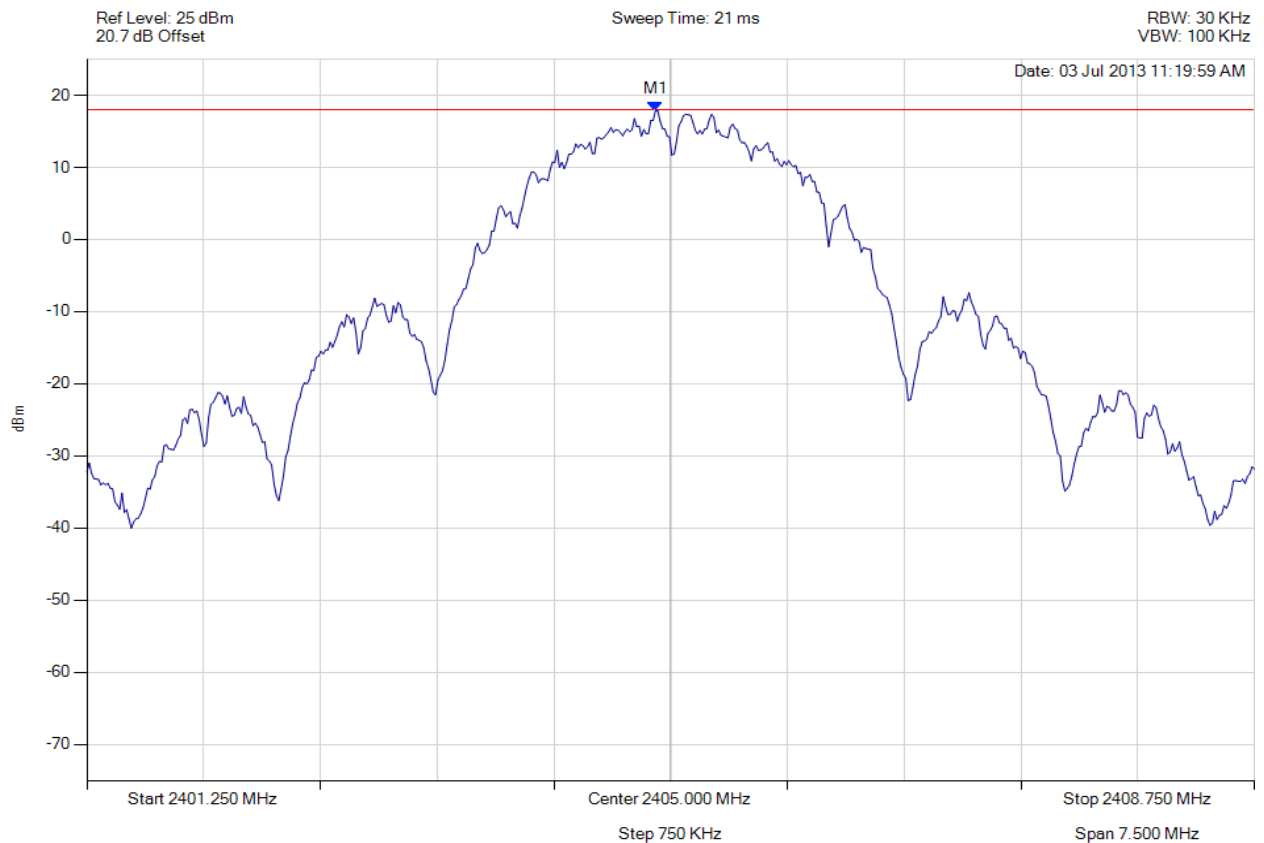

Analyser Setup	Marker : Frequency : Amplitude	Test Results
Detector = MAX PEAK Sweep Count = 0 RF Atten (dB) = 20 Trace Mode = VIEW	M1 : 2404.902 MHz : 17.870 dBm	Limit: ≤ 18.000 dBm Margin: -0.13 dB

[Back to the Matrix](#)

This test report may be reproduced in full only. The document may only be updated by MiCOM Labs personnel. Any changes will be noted in the Document History section of the report.



Title: Silver Spring Network MicroAP
To: FCC 47 CFR Part 15.247 & IC RSS-210
Serial #: SSNT62-U4 Rev A
Issue Date: 13th August 2013
Page: 71 of 80



POWER SPECTRAL DENSITY - AVERAGE

Variant: 802.15.4, Channel: 2440.00 MHz, Chain a, Temp: Ambient, Voltage: 4 Vdc

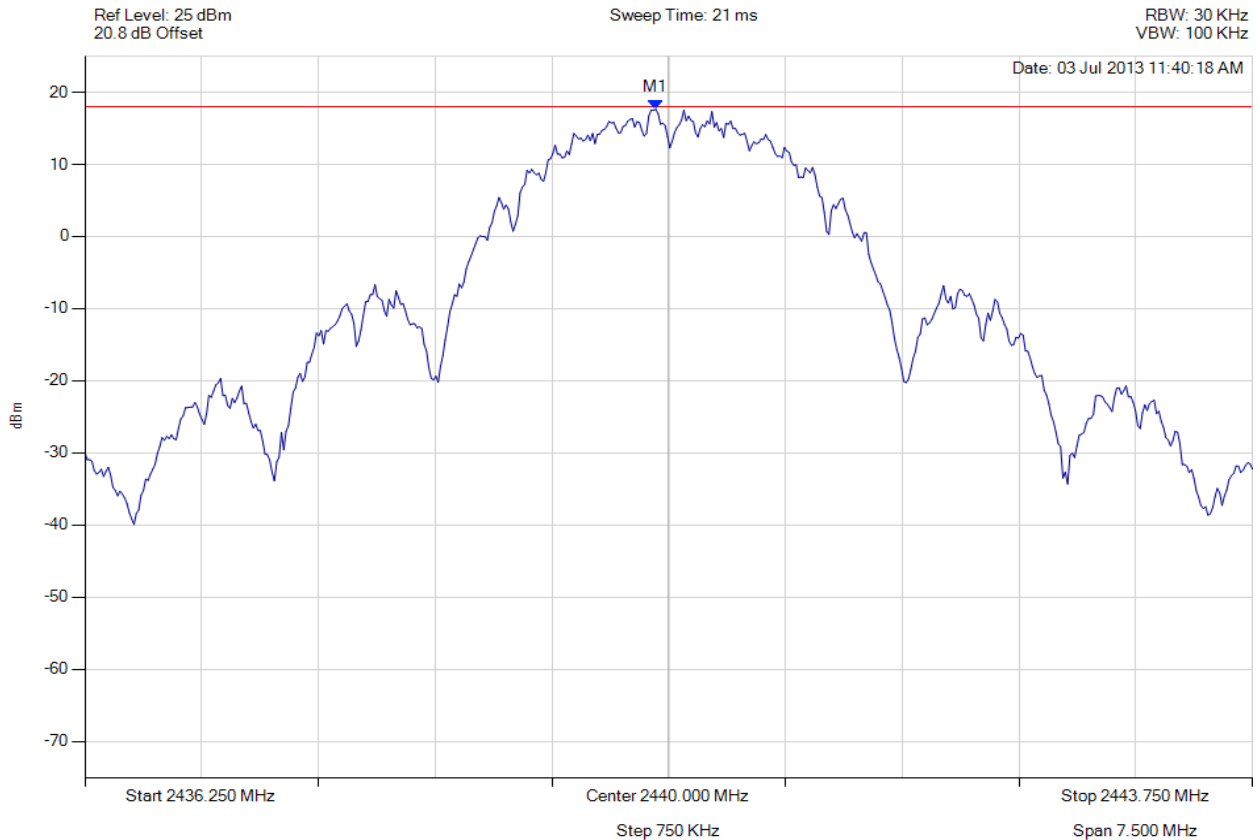

Analyser Setup	Marker : Frequency : Amplitude	Test Results
Detector = MAX PEAK Sweep Count = 0 RF Atten (dB) = 20 Trace Mode = VIEW	M1 : 2439.917 MHz : 17.634 dBm	Limit: ≤ 18.000 dBm Margin: -0.37 dB

[Back to the Matrix](#)

This test report may be reproduced in full only. The document may only be updated by MiCOM Labs personnel. Any changes will be noted in the Document History section of the report.



Title: Silver Spring Network MicroAP
To: FCC 47 CFR Part 15.247 & IC RSS-210
Serial #: SSNT62-U4 Rev A
Issue Date: 13th August 2013
Page: 72 of 80



POWER SPECTRAL DENSITY - AVERAGE

Variant: 802.15.4, Channel: 2480.00 MHz, Chain a, Temp: Ambient, Voltage: 4 Vdc

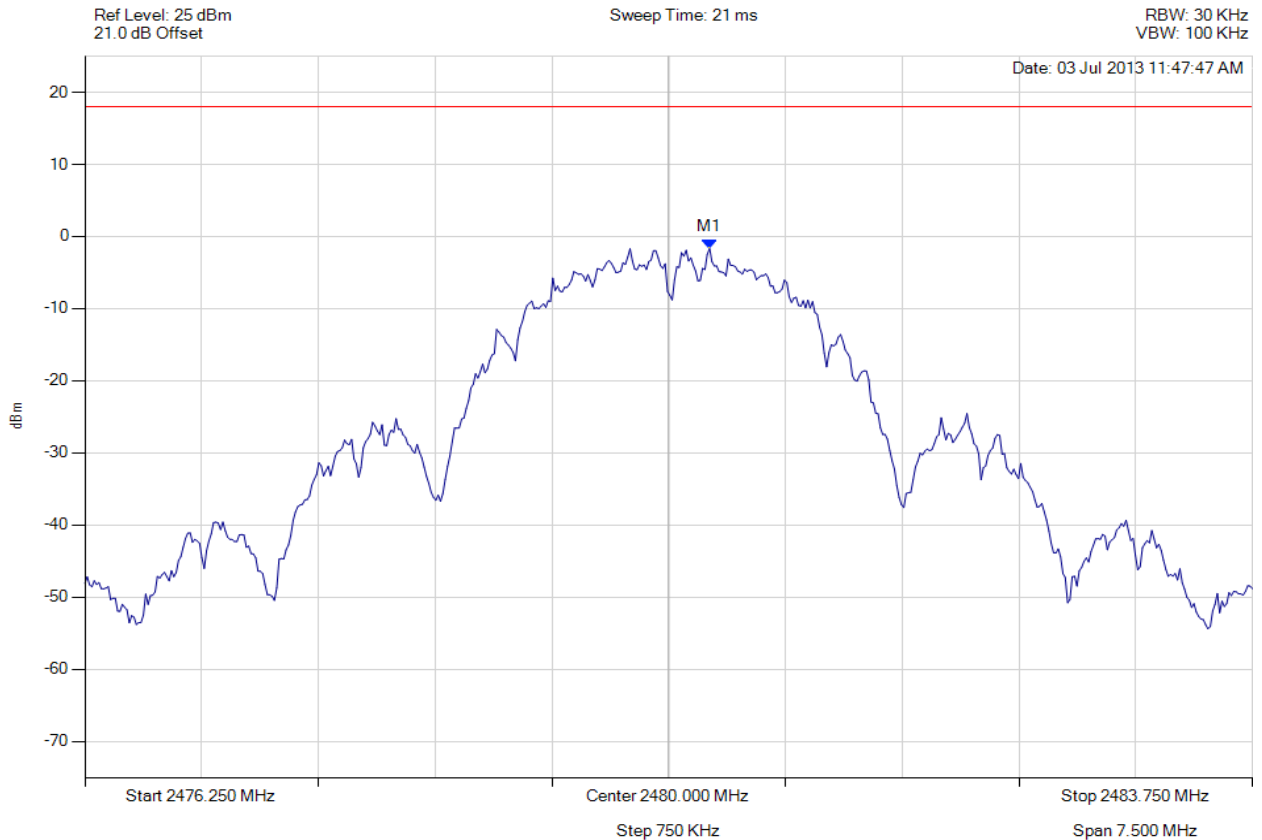

Analyser Setup	Marker : Frequency : Amplitude	Test Results
Detector = MAX PEAK Sweep Count = 0 RF Atten (dB) = 20 Trace Mode = VIEW	M1 : 2480.263 MHz : -1.675 dBm	Limit: ≤ 18.000 dBm Margin: -19.68 dB

[Back to the Matrix](#)

This test report may be reproduced in full only. The document may only be updated by MiCOM Labs personnel. Any changes will be noted in the Document History section of the report.

A.1.4. Conducted Spurious Emissions



CONDUCTED HIGH BAND-EDGE EMISSIONS - AVERAGE

Variant: 802.15.4, Channel: 2480.00 MHz, Chain a, Temp: Ambient, Voltage: 4 Vdc

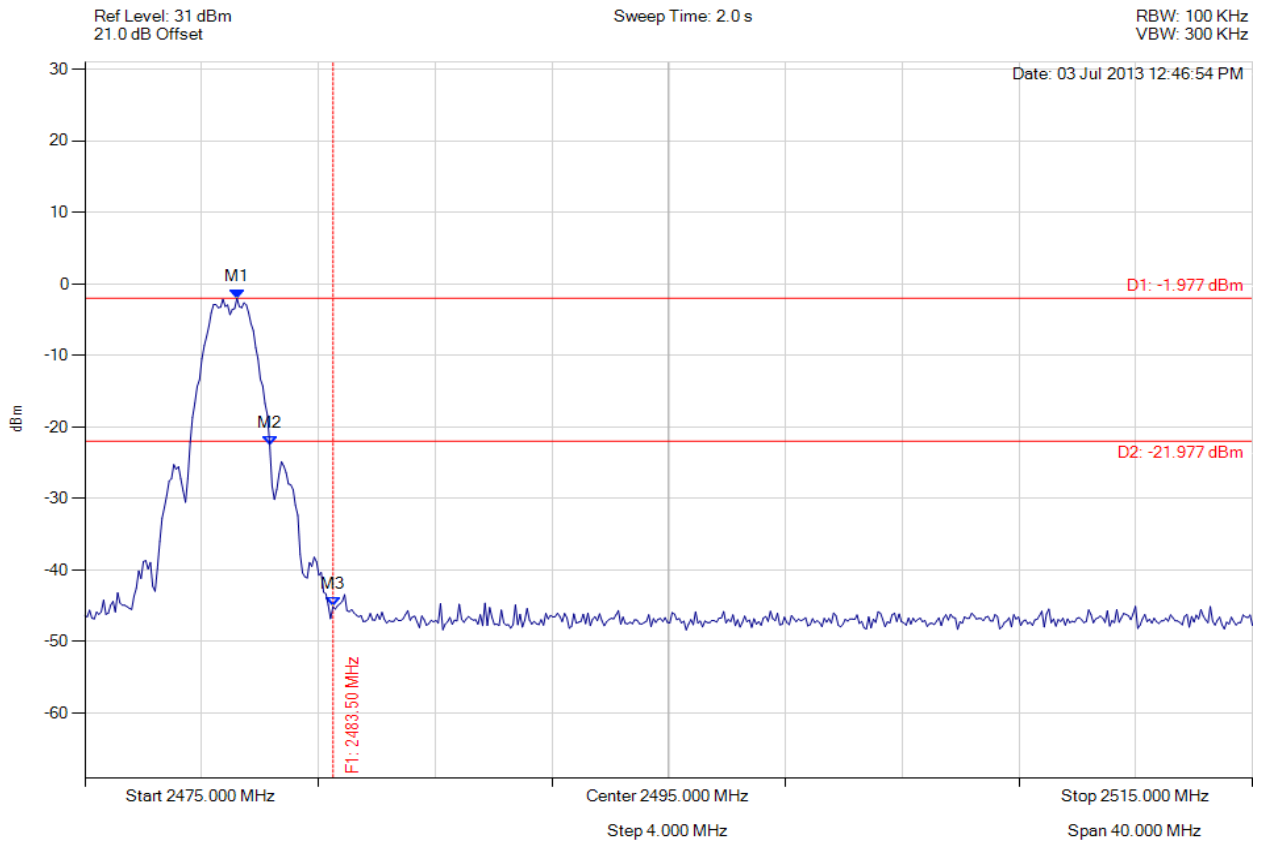

Analyser Setup	Marker : Frequency : Amplitude	Test Results
Detector = MAX PEAK Sweep Count = 0 RF Atten (dB) = 20 Trace Mode = VIEW	M1 : 2480.210 MHz : -1.977 dBm M2 : 2481.333 MHz : -22.504 dBm M3 : 2483.500 MHz : -45.121 dBm	Limit: -21.98 dBm Margin: -23.14 dB

[Back to the Matrix](#)

This test report may be reproduced in full only. The document may only be updated by MiCOM Labs personnel. Any changes will be noted in the Document History section of the report.



CONDUCTED LOW BAND-EDGE EMISSIONS - AVERAGE

Variant: 802.15.4, Channel: 2405.00 MHz, Chain a, Temp: Ambient, Voltage: 4 Vdc

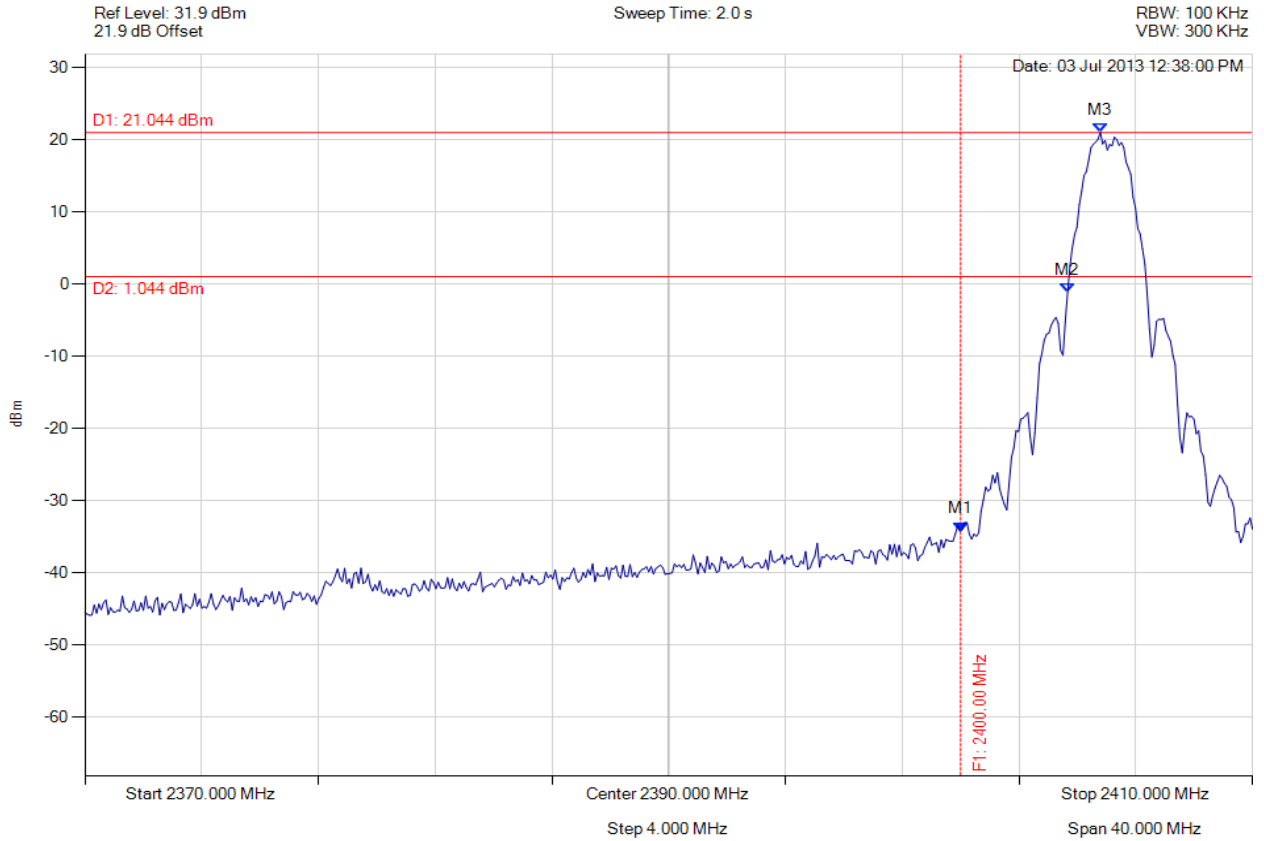

Analyser Setup	Marker : Frequency : Amplitude	Test Results
Detector = MAX PEAK Sweep Count = 0 RF Atten (dB) = 20 Trace Mode = VIEW	M1 : 2400.000 MHz : -34.248 dBm M2 : 2403.667 MHz : -1.067 dBm M3 : 2404.790 MHz : 21.044 dBm	Limit: 1.04 dBm Margin: -35.29 dB

[Back to the Matrix](#)

This test report may be reproduced in full only. The document may only be updated by MiCOM Labs personnel. Any changes will be noted in the Document History section of the report.



Title: Silver Spring Network MicroAP
To: FCC 47 CFR Part 15.247 & IC RSS-210
Serial #: SSNT62-U4 Rev A
Issue Date: 13th August 2013
Page: 75 of 80



CONDUCTED SPURIOUS EMISSIONS - AVERAGE

Variant: 802.15.4, Channel: 2405.00 MHz, Chain a, Temp: Ambient, Voltage: 4 Vdc

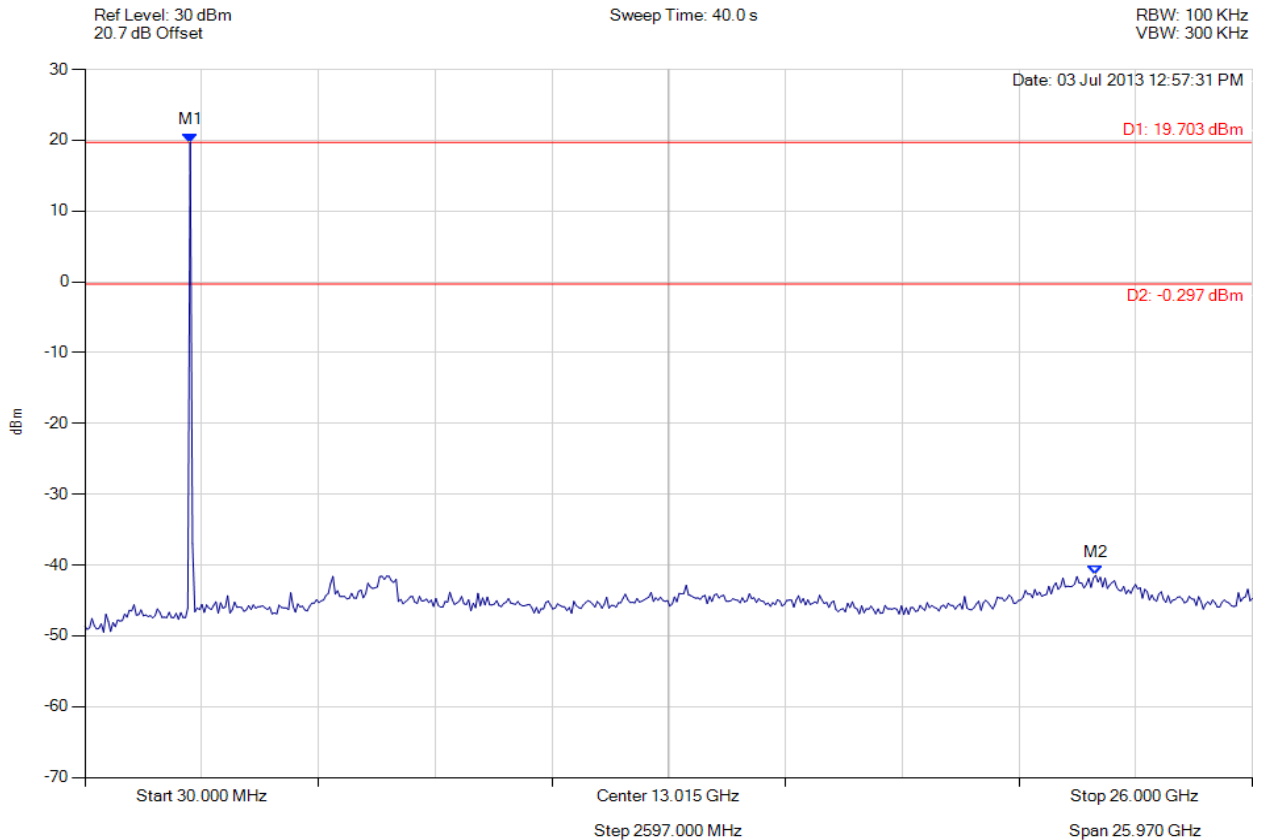

Analyser Setup	Marker : Frequency : Amplitude	Test Results
Detector = MAX PEAK Sweep Count = 0 RF Atten (dB) = 20 Trace Mode = VIEW	M1 : 2371.984 MHz : 19.703 dBm M2 : 22.513 GHz : -41.452 dBm	Limit: -0.30 dBm Margin: -41.15 dB

[Back to the Matrix](#)

This test report may be reproduced in full only. The document may only be updated by MiCOM Labs personnel. Any changes will be noted in the Document History section of the report.



Title: Silver Spring Network MicroAP
To: FCC 47 CFR Part 15.247 & IC RSS-210
Serial #: SSNT62-U4 Rev A
Issue Date: 13th August 2013
Page: 76 of 80



CONDUCTED SPURIOUS EMISSIONS - AVERAGE

Variant: 802.15.4, Channel: 2440.00 MHz, Chain a, Temp: Ambient, Voltage: 4 Vdc

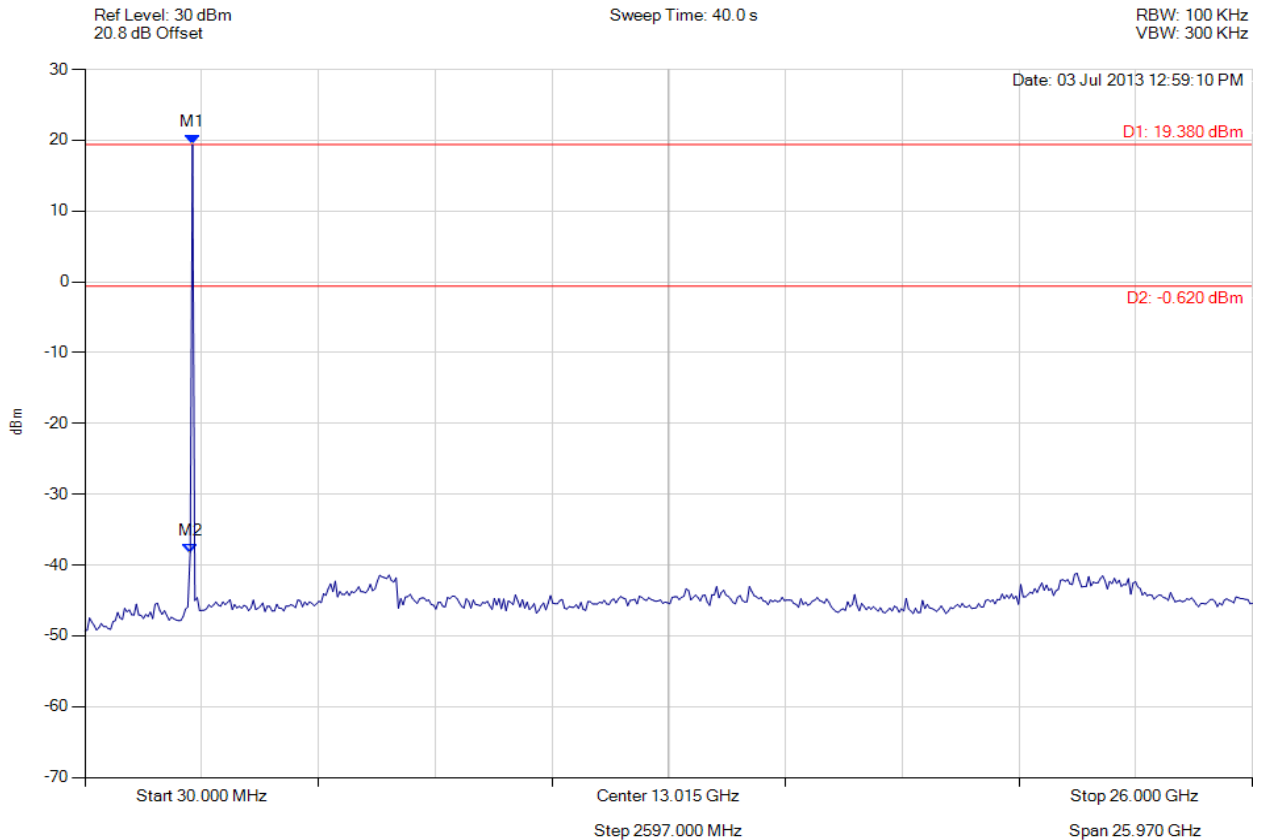

Analyser Setup	Marker : Frequency : Amplitude	Test Results
Detector = MAX PEAK Sweep Count = 0 RF Atten (dB) = 20 Trace Mode = VIEW	M1 : 2424.028 MHz : 19.380 dBm M2 : 2371.984 MHz : -38.255 dBm	Limit: -0.62 dBm Margin: -37.64 dB

[Back to the Matrix](#)

This test report may be reproduced in full only. The document may only be updated by MiCOM Labs personnel. Any changes will be noted in the Document History section of the report.



Title: Silver Spring Network MicroAP
To: FCC 47 CFR Part 15.247 & IC RSS-210
Serial #: SSNT62-U4 Rev A
Issue Date: 13th August 2013
Page: 77 of 80



CONDUCTED SPURIOUS EMISSIONS - AVERAGE

Variant: 802.15.4, Channel: 2480.00 MHz, Chain a, Temp: Ambient, Voltage: 4 Vdc

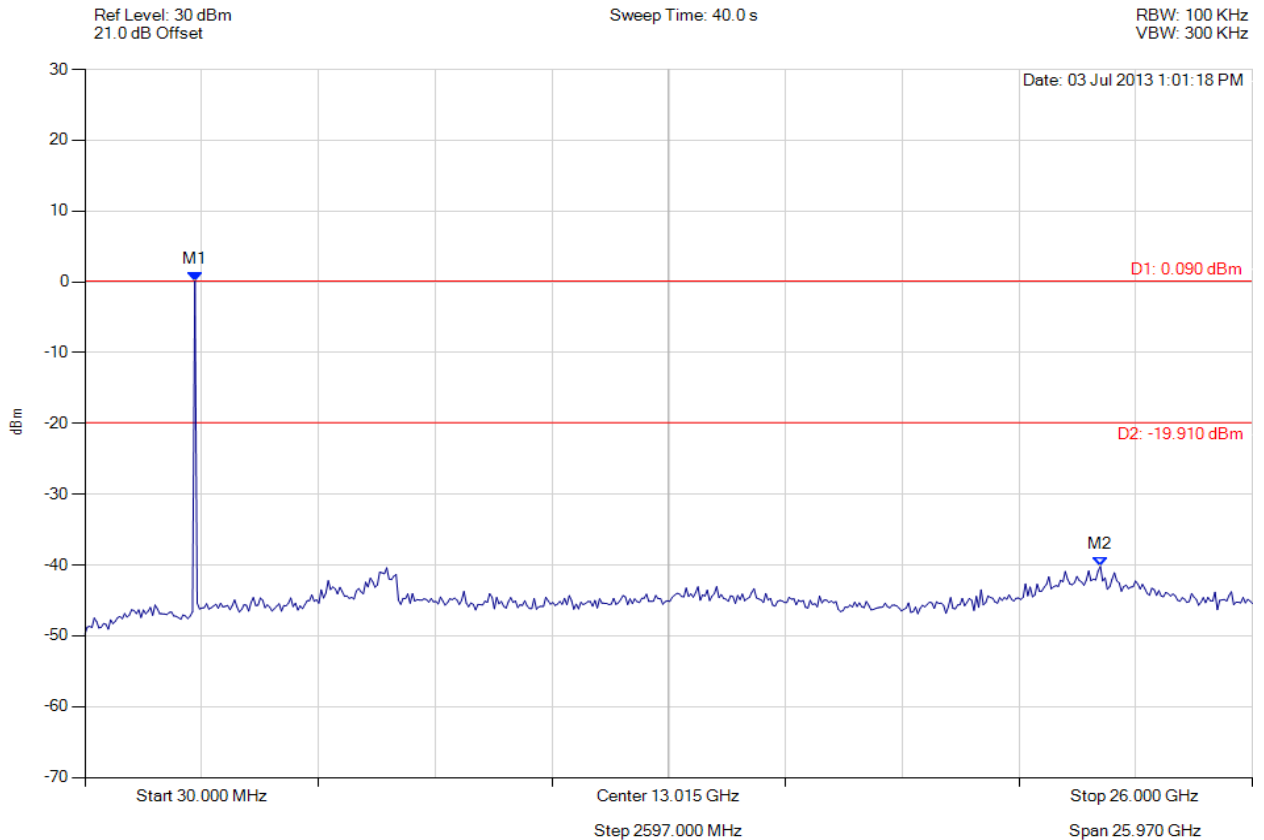

Analyser Setup	Marker : Frequency : Amplitude	Test Results
Detector = MAX PEAK Sweep Count = 0 RF Atten (dB) = 20 Trace Mode = VIEW	M1 : 2476.072 MHz : 0.090 dBm M2 : 22.617 GHz : -40.193 dBm	Limit: -19.91 dBm Margin: -20.28 dB

[Back to the Matrix](#)

This test report may be reproduced in full only. The document may only be updated by MiCOM Labs personnel. Any changes will be noted in the Document History section of the report.



CONDUCTED HIGH BAND-EDGE EMISSIONS - AVERAGE

Variant: 802.15.4, Channel: 2480.00 MHz, Chain a, Temp: Ambient, Voltage: 4 Vdc

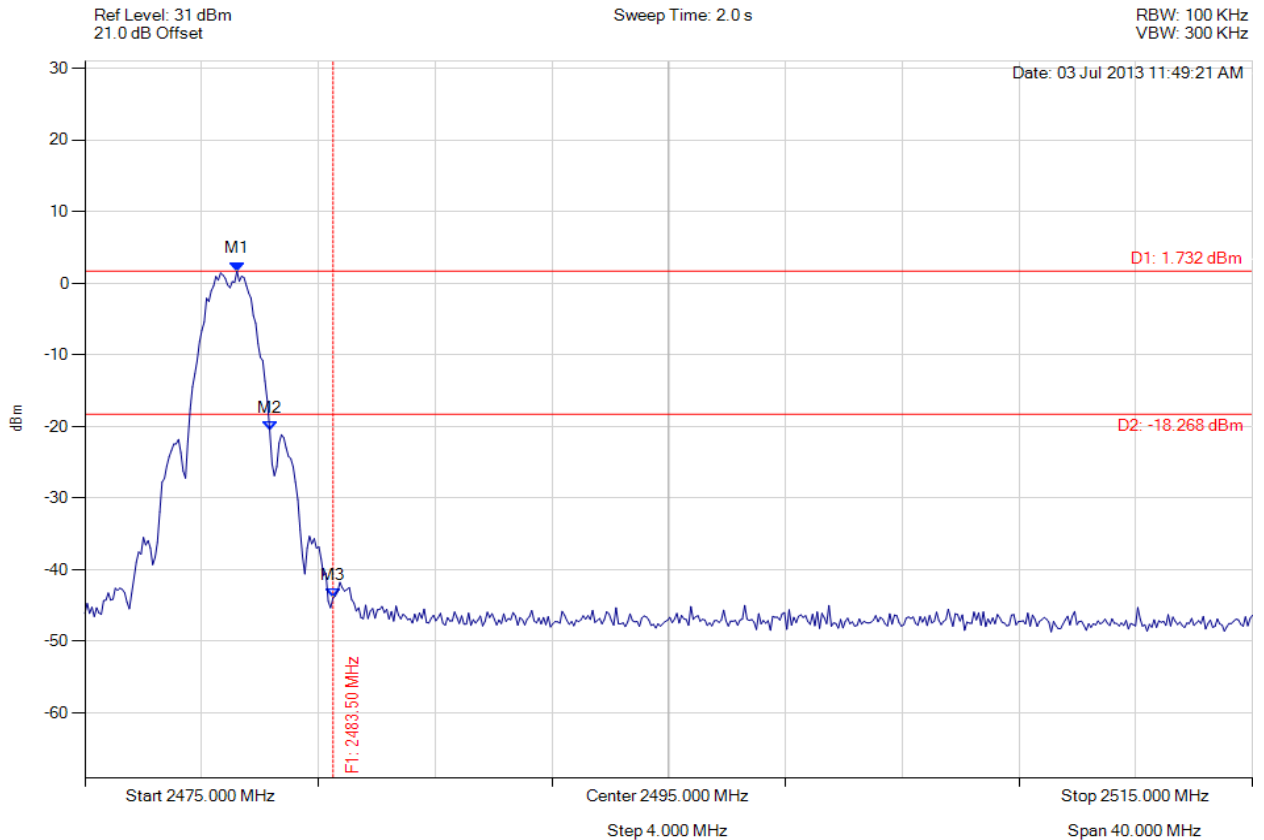

Analyser Setup	Marker : Frequency : Amplitude	Test Results
Detector = MAX PEAK Sweep Count = 0 RF Atten (dB) = 20 Trace Mode = VIEW	M1 : 2480.210 MHz : 1.732 dBm M2 : 2481.333 MHz : -20.515 dBm M3 : 2483.500 MHz : -43.944 dBm	Limit: -18.27 dBm Margin: -25.67 dB

[Back to the Matrix](#)

This test report may be reproduced in full only. The document may only be updated by MiCOM Labs personnel. Any changes will be noted in the Document History section of the report.



CONDUCTED LOW BAND-EDGE EMISSIONS - AVERAGE

Variant: 802.15.4, Channel: 2405.00 MHz, Chain a, Temp: Ambient, Voltage: 4 Vdc

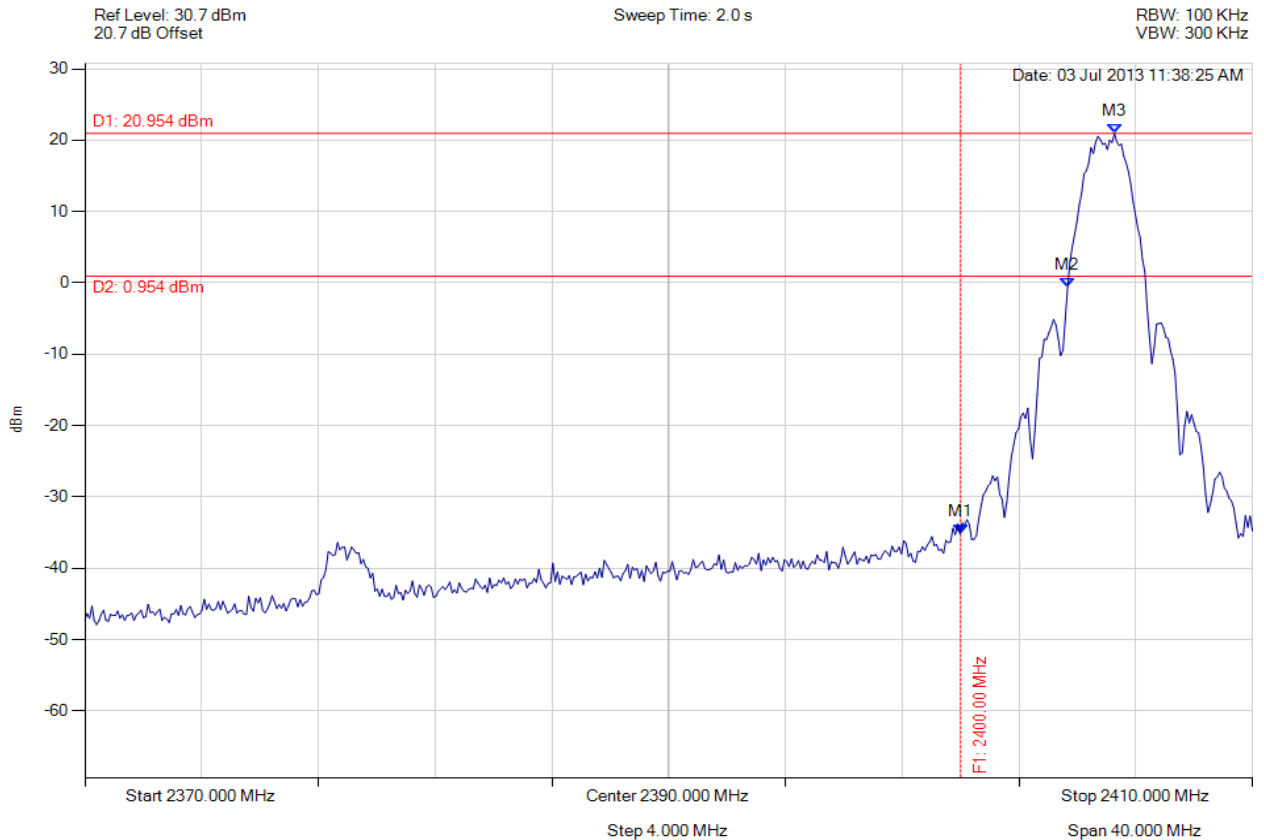

Analyser Setup	Marker : Frequency : Amplitude	Test Results
Detector = MAX PEAK Sweep Count = 0 RF Atten (dB) = 20 Trace Mode = VIEW	M1 : 2400.000 MHz : -35.130 dBm M2 : 2403.667 MHz : -0.628 dBm M3 : 2405.271 MHz : 20.954 dBm	Limit: 0.95 dBm Margin: -36.08 dB

[Back to the Matrix](#)

This test report may be reproduced in full only. The document may only be updated by MiCOM Labs personnel. Any changes will be noted in the Document History section of the report.



440 Boulder Court, Suite 200
Pleasanton, CA 94566, USA
Tel: 1.925.462.0304
Fax: 1.925.462.0306
www.micomlabs.com