

MEASUREMENT REPORT

FCC PART 15.225 NFC 13.56MHz

FCC ID: OWLV72
Applicant: Vanstone Electronic (Beijing) Co., Ltd.
Application Type: Certification
Product: Wireless POS Terminal
Model No.: V72
Brand Name: Aisino
FCC Classification: Part 15 Low Power Communication Device Transmitter (DXX)
FCC Rule Part(s): Part 15 Subpart C (Section 15.225)
Test Procedure(s): ANSI C63.10-2013
Test Date: October 12 ~ December 06, 2019

Reviewed By: 

(Sunny Sun)

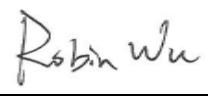
Approved By: 

(Robin Wu)



The test results relate only to the samples tested.

This equipment has been shown to be capable of compliance with the applicable technical standards as indicated in the measurement report and was tested in accordance with the measurement procedures specified in ANSI C63.10. Test results reported herein relate only to the item(s) tested.

The test report shall not be reproduced except in full without the written approval of MRT Technology (Suzhou) Co., Ltd.

Revision History

Report No.	Version	Description	Issue Date	Note
1909RSU034-U3	Rev. 01	Initial report	12-09-2019	Valid

CONTENTS

Description	Page
1. INTRODUCTION	6
1.1. Scope	6
1.2. MRT Test Location	6
2. PRODUCT INFORMATION	7
2.1. Equipment Description	7
2.2. Test Mode	7
2.3. Test Configuration	7
2.4. EMI Suppression Device(s)/Modifications	7
2.5. Labeling Requirements	7
3. DESCRIPTION OF TEST	8
3.1. Evaluation Procedure	8
3.2. AC Line Conducted Emissions	8
3.3. Radiated Emissions	9
4. ANTENNA REQUIREMENTS	10
5. TEST EQUIPMENT CALIBRATION DATA	11
6. MEASUREMENT UNCERTAINTY	12
7. TEST RESULT	13
7.1. Summary	13
7.2. In-band Emission	14
7.2.1. Test Limit	14
7.2.2. Test Procedure Used	14
7.2.3. Test Setting	14
7.2.4. Test Setup	15
7.2.5. Test Result	16
7.3. Out-band Emission	17
7.3.1. Test Limit	17
7.3.2. Test Procedure Used	17
7.3.3. Test Setting	17
7.3.4. Test Setup	18
7.3.5. Test Result	19
7.4. 20dB Bandwidth	20
7.4.1. Test Limit	20
7.4.2. Test Procedure Used	20

7.4.3.	Test Setting.....	20
7.4.4.	Test Setup	20
7.4.5.	Test Result.....	21
7.5.	Frequency Tolerance	22
7.5.1.	Test Limit	22
7.5.2.	Test Procedure Used.....	22
7.5.3.	Test Setting.....	22
7.5.4.	Test Setup	23
7.5.5.	Test Result.....	24
7.6.	AC Conducted Emissions Measurement.....	25
7.6.1.	Test Limit	25
7.6.2.	Test Setup	25
7.6.3.	Test Result.....	26
8.	CONCLUSION.....	28
	Appendix A - Test Setup Photograph.....	29
	Appendix B - EUT Photograph	30

General Information

Applicant:	Vanstone Electronic (Beijing) Co., Ltd.
Applicant Address:	Room 4-18, No.25, Landianchang South Road, Haidian, Beijing, China 100097
Manufacturer:	Vanstone Electronic (Beijing) Co., Ltd.
Manufacturer Address:	Room 4-18, No.25, Landianchang South Road, Haidian, Beijing, China 100097
Test Site:	MRT Technology (Suzhou) Co., Ltd
Test Site Address:	D8 Building, No.2 Tian'edang Rd., Wuzhong Economic Development Zone, Suzhou, China

Test Facility / Accreditations

Measurements were performed at MRT Laboratory located in Tian'edang Rd., Suzhou, China.

- MRT facility is a FCC registered (MRT Reg. No. 893164) test facility with the site description report on file and has met all the requirements specified in ANSI C63.4-2014.
- MRT facility is an IC registered (MRT Reg. No. 11384A-1) test laboratory with the site description on file at Industry Canada.
- MRT facility is a VCCI registered (R-20025, G-20034, C-20020, T-20020) test laboratory with the site description on file at VCCI Council.
- MRT Lab is accredited to ISO 17025 by the American Association for Laboratory Accreditation (A2LA) under the American Association for Laboratory Accreditation Program (A2LA Cert. No. 3628.01) in EMC, Telecommunications, Radio and SAR testing.



1. INTRODUCTION

1.1. Scope

Measurement and determination of electromagnetic emissions (EMC) of radio frequency devices including intentional and/or unintentional radiators for compliance with the technical rules and regulations of the Federal Communications Commission and the Innovation, Science and Economic Development Canada and Certification and Engineering Bureau.

1.2. MRT Test Location

The map below shows the location of the MRT LABORATORY, its proximity to the Taihu Lake. These measurement tests were conducted at the MRT Technology (Suzhou) Co., Ltd. Facility located at D8 Building, No.2 Tian'edang Rd., Wuzhong Economic Development Zone, Suzhou, China. The measurement facility compliant with the test site requirements specified in ANSI C63.4-2014..



2. PRODUCT INFORMATION

2.1. Equipment Description

Product Name:	Wireless POS Terminal
Model No.:	V72
Brand Name:	Aisino
GSM Specification:	GSM850/900/1800/1900
Wi-Fi Specification:	802.11b/g/n-HT20
NFC:	13.56MHz
Accessory	
Adapter:	Model No.: A8A-050200U-US1 Input: 100-240V ~ 50/60Hz 0.35A Output: 5V = 2.0A

2.2. Test Mode

Test Mode
Mode 1: Transmit by NFC

2.3. Test Configuration

This device was set to continuous transmission. This was performance using manufacturer software loaded on the terminal to allow for continuous transmission. This device was tested per the guidance of ANSI C63.10-2013, which is used as the reference of appropriate EUT setup for radiated spurious emissions testing and AC line conducted testing..

2.4. EMI Suppression Device(s)/Modifications

No EMI suppression device(s) were added and/or no modifications were made during testing.

2.5. Labeling Requirements

Per 2.1074 & 15.19; Docket 95-19

The label shall be permanently affixed at a conspicuous location on the device; instruction manual or pamphlet supplied to the user and be readily visible to the purchaser at the time of purchase.

However, when the device is so small wherein placement of the label with specified statement is not practical, only the FCC ID must be displayed on the device per Section 15.19(a)(5). Please see attachment for FCC ID label and label location.

3. DESCRIPTION OF TEST

3.1. Evaluation Procedure

The measurement procedures described in the American National Standard for Testing Unlicensed Wireless Devices (ANSI C63.10-2013) was used in the measurement.

Deviation from measurement procedure.....None

3.2. AC Line Conducted Emissions

The line-conducted facility is located inside an 8'x4'x4' shielded enclosure. A 1m x 2m wooden table 80cm high is placed 40cm away from the vertical wall and 80cm away from the sidewall of the shielded room. Two 10kHz-30MHz, 50Ω/50uH Line-Impedance Stabilization Networks (LISNs) are bonded to the shielded room floor. Power to the LISNs is filtered by external high-current high-insertion loss power line filters. These filters attenuate ambient signal noise from entering the measurement lines. These filters are also bonded to the shielded enclosure.

The EUT is powered from one LISN and the support equipment is powered from the second LISN. All interconnecting cables more than 1 meter were shortened to a 1 meter length by non-inductive bundling (serpentine fashion) and draped over the back edge of the test table. All cables were at least 40cm above the horizontal reference ground-plane. Power cables for support equipment were routed down to the second LISN while ensuring that that cables were not draped over the second LISN.

Sufficient time for the EUT, support equipment, and test equipment was allowed in order for them to warm up to their normal operating condition. The RF output of the LISN was connected to the receiver and exploratory measurements were made to determine the frequencies producing the maximum emission from the EUT. The receiver was scanned from 150kHz to 30MHz. The detector function was set to peak mode for exploratory measurements while the bandwidth of the analyzer was set to 9kHz. The EUT, support equipment, and interconnecting cables were arranged and manipulated to maximize each emission. Each emission was also maximized by varying: power lines, the mode of operation or data exchange speed, or support equipment whichever determined the worst-case emission. Once the worst case emissions have been identified, the one EUT cable configuration/arrangement and mode of operation that produced these emissions are used for final measurements on the same test site. The analyzer is set to CISPR quasi-peak and average detectors with a 9kHz resolution bandwidth for final measurements.

An extension cord was used to connect to a single LISN which powered by EUT. The extension cord was calibrated with LISN, the impedance and insertion loss are compliance with the requirements as stated in ANSI C63.10-2013 at Clause 4.3.

3.3. Radiated Emissions

The radiated test facilities consisted of an indoor 3 meter semi-anechoic chamber used for final measurements and exploratory measurements, when necessary. The measurement area is contained within the semi-anechoic chamber which is shielded from any ambient interference. For measurements above 1GHz absorbers are arranged on the floor between the turn table and the antenna mast in such a way so as to maximize the reduction of reflections. For measurements below 1GHz, the absorbers are removed. A MF Model 210SS turntable is used for radiated measurement. It is a continuously rotatable, remote controlled, metallic turntable and 2 meters (6.56 ft.) in diameter. The turn table is flush with the raised floor of the chamber in order to maintain its function as a ground plane. An 80cm high PVC support structure is placed on top of the turntable.

For all measurements, the spectrum was scanned through all EUT azimuths and from 1 to 4 meter receive antenna height using a broadband antenna from 30MHz up to the upper frequency shown in 15.33(b)(1) depending on the highest frequency generated or used in the device or on which the device operates or tunes. For frequencies above 1GHz, linearly polarized double ridge horn antennas were used. For frequencies below 30MHz, a calibrated loop antenna was used. When exploratory measurements were necessary, they were performed at 1 meter test distance inside the semi-anechoic chamber using broadband antennas, broadband amplifiers, and spectrum analyzers to determine the frequencies and modes producing the maximum emissions. Sufficient time for the EUT, support equipment, and test equipment was allowed in order for them to warm up to their normal operating condition. The test set-up was placed on top of the 0.8 meter high, 1 x 1.5 meter table. The EUT, support equipment, and interconnecting cables were arranged and manipulated to maximize each emission. Appropriate precaution was taken to ensure that all emissions from the EUT were maximized and investigated. The system configuration, clock speed, mode of operation or video resolution, if applicable, turntable azimuth, and receive antenna height was noted for each frequency found.

Final measurements were made in the semi-anechoic chamber using calibrated, linearly polarized broadband and horn antennas. The test setup was configured to the setup that produced the worst case emissions. The spectrum analyzer was set to investigate all frequencies required for testing to compare the highest radiated disturbances with respect to the specified limits. The turntable containing the EUT was rotated through 360 degrees and the height of the receive antenna was varied 1 to 4 meters and stopped at the azimuth and height producing the maximum emission. Each emission was maximized by changing the orientation of the EUT through three orthogonal planes and changing the polarity of the receive antenna, whichever produced the worst-case emissions. According to 3dB Beam-Width of horn antenna, the horn antenna should be always directed to the EUT when rising height.

4. ANTENNA REQUIREMENTS

Excerpt from §15.203 of the FCC Rules/Regulations:

“An intentional radiator antenna shall be designed to ensure that no antenna other than that furnished by the responsible party can be used with the device. The use of a permanently attached antenna or of an antenna that uses a unique coupling to the intentional radiator shall be considered sufficient to comply with the provisions of this section.”

- The antenna of the **Wireless POS Terminal** is **permanently attached**.
- There are no provisions for connection to an external antenna.

Conclusion:

The unit complies with the requirement of §15.203.

5. TEST EQUIPMENT CALIBRATION DATA

Conducted Emissions - SR2

Instrument	Manufacturer	Type No.	Asset No.	Cali. Interval	Cali. Due Date
EMI Test Receiver	R&S	ESR3	MRTSUE06185	1 year	2020/04/15
Two-Line V-Network	R&S	ENV 216	MRTSUE06002	1 year	2020/06/13
Two-Line V-Network	R&S	ENV 216	MRTSUE06003	1 year	2020/06/13
Thermohygrometer	Testo	608-H1	MRTSUE06404	1 year	2020/08/08
Shielding Room	MIX-BEP	Chamber-SR2	MRTSUE06215	N/A	N/A

Radiated Emissions - AC1

Instrument	Manufacturer	Type No.	Asset No.	Cali. Interval	Cali. Due Date
EMI Test Receiver	R&S	ESR7	MRTSUE06001	1 year	2020/08/01
PXA Signal Analyzer	Keysight	9030B	MRTSUE06395	1 year	2020/09/03
Loop Antenna	Schwarzbeck	FMZB 1519	MRTSUE06025	1 year	2020/11/10
Bilog Period Antenna	Schwarzbeck	VULB 9168	MRTSUE06172	1 year	2020/03/31
Broad Band Horn Antenna	Schwarzbeck	BBHA 9120D	MRTSUE06023	1 year	2020/10/13
Broad Band Horn Antenna	Schwarzbeck	BBHA 9170	MRTSUE06024	1 year	2019/12/17
Microwave System Amplifier	Agilent	83017A	MRTSUE06076	1 year	2020/11/15
Preamplifier	Schwarzbeck	BBV 9721	MRTSUE06121	1 year	2020/06/11
Thermohygrometer	Testo	608-H1	MRTSUE06403	1 year	2020/08/08
Anechoic Chamber	TDK	Chamber-AC1	MRTSUE06212	1 year	2020/04/30

Radiated Emission - AC2

Instrument	Manufacturer	Type No.	Asset No.	Cali. Interval	Cali. Due Date
Spectrum Analyzer	Keysight	N9038A	MRTSUE06125	1 year	2020/08/01
Loop Antenna	Schwarzbeck	FMZB 1519	MRTSUE06025	1 year	2020/11/10
Bilog Period Antenna	Schwarzbeck	VULB 9162	MRTSUE06022	1 year	2020/10/13
Horn Antenna	Schwarzbeck	BBHA9120D	MRTSUE06171	1 year	2020/10/27
Broad Band Horn Antenna	Schwarzbeck	BBHA 9170	MRTSUE06024	1 year	2019/12/17
Broadband Coaxial Preamplifier	Schwarzbeck	BBV 9718	MRTSUE06176	1 year	2020/11/15
Preamplifier	Schwarzbeck	BBV 9721	MRTSUE06121	1 year	2020/06/11
Temperature/Humidity Meter	Minggao	ETH529	MRTSUE06170	1 year	2019/12/13
Anechoic Chamber	RIKEN	Chamber-AC2	MRTSUE06213	1 year	2020/04/30

Software	Version	Function
EMI Software	V3	EMI Test Software

6. MEASUREMENT UNCERTAINTY

Where relevant, the following test uncertainty levels have been estimated for tests performed on the EUT as specified in CISPR 16-4-2. This uncertainty represents an expanded uncertainty expressed at approximately the 95% confidence level using a coverage factor of $k = 2$.

AC Conducted Emission Measurement - SR2
Measuring Uncertainty for a Level of Confidence of 95% ($U=2Uc(y)$): 9kHz~150kHz: 3.84dB 150kHz~30MHz: 3.46dB
Radiated Emission Measurement - AC1
Measuring Uncertainty for a Level of Confidence of 95% ($U=2Uc(y)$): Horizontal: 30MHz~300MHz: 4.07dB 300MHz~1GHz: 3.63dB 1GHz~18GHz: 4.16dB Vertical: 30MHz~300MHz: 4.18dB 300MHz~1GHz: 3.60dB 1GHz~18GHz: 4.76dB
Radiated Emission Measurement - AC2
Measuring Uncertainty for a Level of Confidence of 95% ($U=2Uc(y)$): Horizontal: 30MHz~300MHz: 3.75dB 300MHz~1GHz: 3.53dB 1GHz~18GHz: 4.28dB Vertical: 30MHz~300MHz: 3.86dB 300MHz~1GHz: 3.53dB 1GHz~18GHz: 4.33dB

7. TEST RESULT

7.1. Summary

FCC Part Section(s)	Test Description	Test Limit	Test Condition	Test Result	Reference
15.225 (a), (b), (c)	In-Band Emission	For 13.553 ~ 13.567 MHz: 15,848uV/m @ 30m For 13.410 ~ 13.553 MHz & 13.567 ~ 13.710 MHz: 334uV/m @ 30m For 13.110 ~ 13.410 MHz & 13.710 ~ 14.010 MHz: 106uV/m @ 30m	Radiated	Pass	Section 7.2
15.225(d)	Out-Band Emission	Emissions outside of the 13.110~14.010 MHz band shall not exceed the general radiated emission limits in §15.209.		Pass	Section 7.3
2.1049	20dB Bandwidth 99% Bandwidth	N/A		Pass	Section 7.4
15.225(e)	Frequency Stability Tolerance	±0.01% of operating frequency		Pass	Section 7.5
15.207	AC Conducted Emissions 150kHz - 30MHz	< §15.207 limits	Line Conducted	Pass	Section 7.6

Notes: All modes of operation and data rates were investigated. For radiated emission test, every axis (X, Y, Z) was also verified. The test results shown in the following sections represent the worst case emissions.

7.2. In-band Emission

7.2.1. Test Limit

FCC Part 15 Subpart C Paragraph 15.225		
Frequency (MHz)	Distance (m)	Level (uV/m)
13.553 ~13.567	30	15,848
13.410 ~13.553 13.567 ~13.710	30	334
13.110 ~13.410 13.710 ~14.010	30	106

Note 1: The lower limit shall apply at the transition frequency.

Note 2: Distance refers to the distance in meters between the measuring instrument antenna and the closed point of any part of the device or system.

Note 3: E field strength (dBuV/m) = 20 log E field strength (uV/m)

7.2.2. Test Procedure Used

ANSI C63.10 Section 6.3 (General Requirements)

ANSI C63.10 Section 6.4 (Standard test method below 30MHz)

7.2.3. Test Setting

1. Analyzer center frequency was set to the frequency of the radiated spurious emission of interest
2. Set the spectrum analyzer frequency span to capture fully the emission that is to be measured.
3. RBW = 9kHz
4. Detector = CISPR quasi-peak
5. Sweep time = auto couple
6. Trace was allowed to stabilize

7.2.4. Test Setup

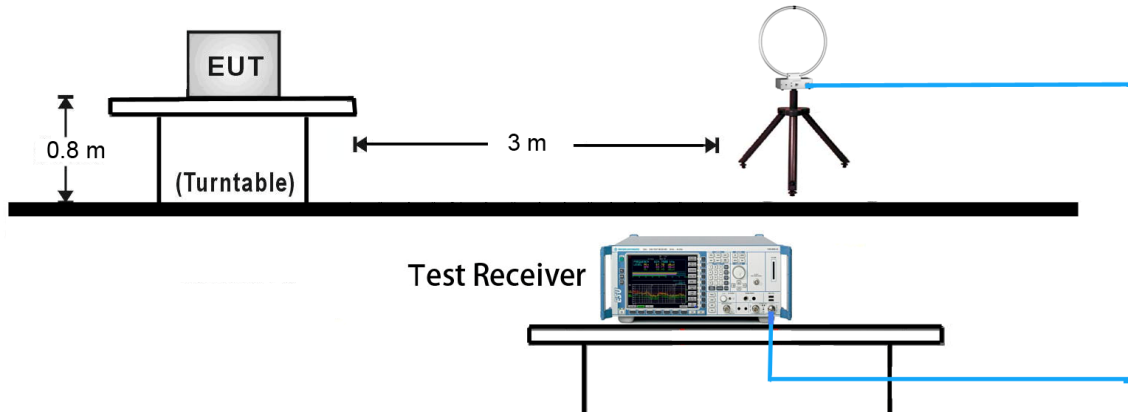

7.2.5. Test Result

Test Engineer	David Lv	Temperature	25°C
Test Time	2019/10/17	Relative Humidity	56%
Test Mode	Mode1	Test Site	AC1

Frequency	Reading Level (dBuV/m)	Factor (dB)	Measure Level (dBuV/m)	Limit (3m) (dBuV/m)	Margin [dB]	Detector
Face On						
13.14	29.41	19.85	49.26	80.51	-31.25	Peak
13.35	40.40	19.85	60.25	90.47	-30.22	Peak
13.56	59.69	19.87	79.56	124.00	-44.44	Peak
13.77	43.75	19.88	63.63	90.47	-26.84	Peak
13.99	33.71	19.85	53.56	80.51	-26.95	Peak
Face Off						
13.14	25.76	19.85	45.61	80.51	-34.90	Peak
13.35	36.88	19.85	56.73	90.47	-33.74	Peak
13.56	56.99	19.87	76.86	124.00	-47.14	Peak
13.77	39.72	19.88	59.60	90.47	-30.87	Peak
13.99	29.84	19.85	49.69	80.51	-30.82	Peak

Note:

- All measurements were performed using a loop antenna. The antenna was positioned in two orthogonal (face on and face off) and the position with the highest emission level was recorded.
- For below 30MHz, the limits were calculated as below:
 E field strength (dBuV/m) = 20 log E field strength (uV/m)
 Limit (dBuV/m)@3m = Limit (dBuV/m)@30m + 40*Log₁₀(30/3).
 For example, the limits of frequency range (13.553 ~ 13.567MHz) are calculated as below:
 Limit (dBuV/m)@3m = [20*log(15,848) + 40*Log₁₀(30/3)] (dBuV/m) ≈ 124.00 (dBuV/m).
- Measure Level (dBuV/m) = Reading Level (dBuV) + Factor (dB)
 Factor (dB) = Cable Loss (dB) + Antenna Factor (dB/m).

7.3. Out-band Emission

7.3.1. Test Limit

FCC Part 15 Subpart C Paragraph 15.209		
Frequency [MHz]	Field Strength [uV/m]	Measured Distance [Meters]
0.009 ~ 0.490	2400/F (kHz)	300
0.490 ~ 1.705	24000/F (kHz)	30
1.705 ~ 30	30	30
30 ~ 88	100	3
88 ~ 216	150	3
216 ~ 960	200	3
Above 960	500	3

Note 1: The lower limit shall apply at the transition frequency.

Note 2: Distance refers to the distance in meters between the measuring instrument antenna and the closed point of any part of the device or system.

Note 3: E field strength (dBuV/m) = 20 log E field strength (uV/m)

7.3.2. Test Procedure Used

ANSI C63.10 Section 6.3 (General Requirements)

ANSI C63.10 Section 6.4 (Standard test method below 30MHz)

ANSI C63.10 Section 6.5 (Standard test method above 30MHz to 1GHz)

7.3.3. Test Setting

1. Analyzer center frequency was set to the frequency of the radiated spurious emission of interest
2. Set the spectrum analyzer frequency span to capture fully the emission that is to be measured.
3. RBW = as specified in Table 1
4. Detector = CISPR quasi-peak or average
5. Sweep time = auto couple
6. Trace was allowed to stabilize

Table 1 - RBW as a function of frequency

Frequency	RBW
9 ~ 150 kHz	200 ~ 300 Hz
0.15 ~ 30 MHz	9 ~ 10 kHz
30 ~ 1000 MHz	100 ~ 120 kHz

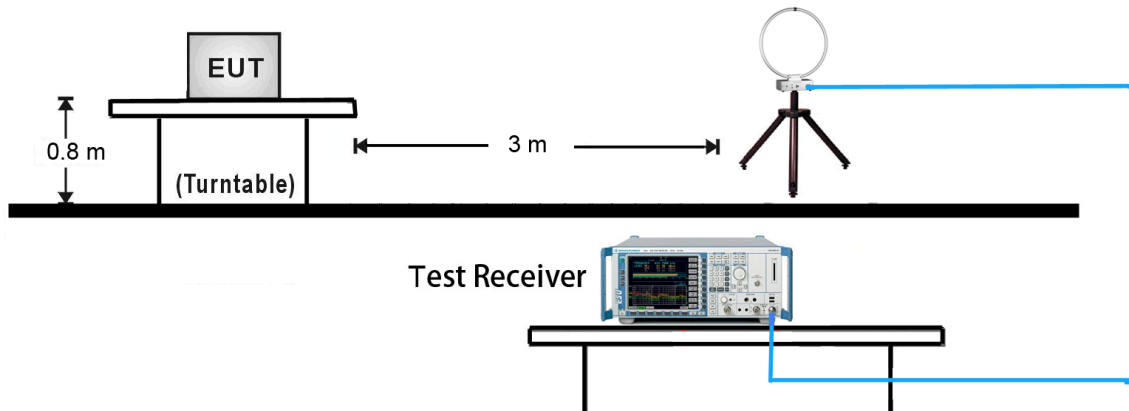
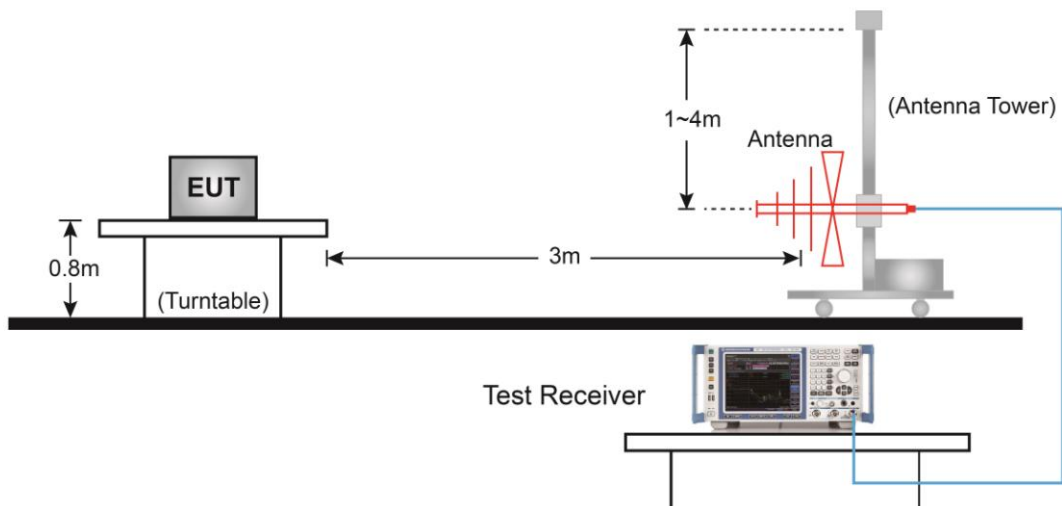
7.3.4. Test Setup
9kHz ~ 30MHz Test Setup:

30MHz ~ 1GHz Test Setup:

7.3.5. Test Result

Test Engineer	David Lv	Temperature	25°C
Test Time	2019/12/06	Relative Humidity	56%
Test Mode	Mode1	Test Site	AC1

Frequency (MHz)	Reading Level (dBuV/m)	Factor (dB)	Measure Level (dBuV/m)	Limit (dBuV/m)	Margin (dB)	Detector	Polarization
Below 30MHz							
27.12	7.58	19.51	27.09	69.54	-42.45	Peak	Face On
27.12	6.37	19.51	25.88	70.54	-44.66	Peak	Face Off
Above 30MHz							
51.3	-2.2	14.0	11.8	40.0	-28.2	Peak	Horizontal
103.7	-1.2	11.4	10.2	43.5	-33.3	Peak	Horizontal
206.1	-1.0	11.3	10.3	43.5	-33.2	Peak	Horizontal
250.0	3.4	13.0	16.4	46.0	-29.6	Peak	Horizontal
626.1	-1.8	21.1	19.3	46.0	-26.7	Peak	Horizontal
821.5	-0.9	23.5	22.6	46.0	-23.4	Peak	Horizontal
64.4	7.8	12.6	20.4	40.0	-19.6	Peak	Vertical
86.3	3.8	10.2	14.0	40.0	-26.0	Peak	Vertical
109.1	-1.3	12.0	10.7	43.5	-32.8	Peak	Vertical
249.7	6.4	13.0	19.4	46.0	-26.6	Peak	Vertical
549.0	-2.2	19.5	17.3	46.0	-28.7	Peak	Vertical
807.9	-2.0	23.4	21.4	46.0	-24.6	Peak	Vertical

- The measurements were performed using a loop antenna for below 30MHz. The antenna was positioned in two orthogonal (face on and face off) and the position with the highest emission level was recorded.
- For below 30MHz, the limits were calculated as below:
 $E \text{ field strength (dBuV/m)} = 20 \log E \text{ field strength (uV/m)} = 20 * \log(30) \text{ dBuV/m} = 29.54 \text{ dBuV/m}$
 $\text{Limit (dBuV/m)}@3\text{m} = \text{Limit (dBuV/m)}@30\text{m} + 40 * \log_{10}(30/3) = (29.54 + 40) \text{ dBuV/m} = 69.54 \text{ dBuV/m}.$
- Measure Level (dBuV/m) = Reading Level (dBuV) + Factor (dB)
 Factor (dB) = Cable Loss (dB) + Antenna Factor (dB/m).

7.4. 20dB Bandwidth

7.4.1. Test Limit

N/A

7.4.2. Test Procedure Used

ANSI C63.10 Clause 6.9.2

7.4.3. Test Setting

1. The span range shall be two times and five times the OBW
2. Set RBW = 1% to 5% of the OBW
3. VBW shall be approximately three times RBW
4. Detector = Peak
5. Trace mode = max hold
6. Sweep = auto couple
7. Allow the trace was allowed to stabilize and marker the highest level.
8. Determine the display level (the highest level - 20dB) and place two markers, one at the lowest frequency and the other at the highest frequency.

7.4.4. Test Setup

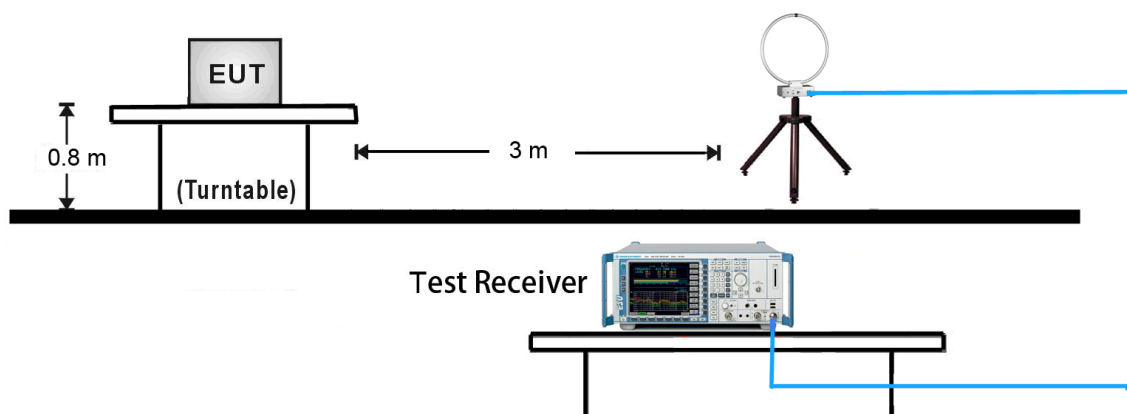

7.4.5. Test Result

Test Engineer	David Lv	Temperature	25°C
Test Time	2019/12/06	Relative Humidity	56%
Test Mode	Mode1	Test Site	AC1

Bandwidth		Limit
F _L	13.5479 MHz	> 13.110 MHz
F _H	13.5736 MHz	< 14.010 MHz
20dB Bandwidth	0.0257 MHz	
Result	Pass	

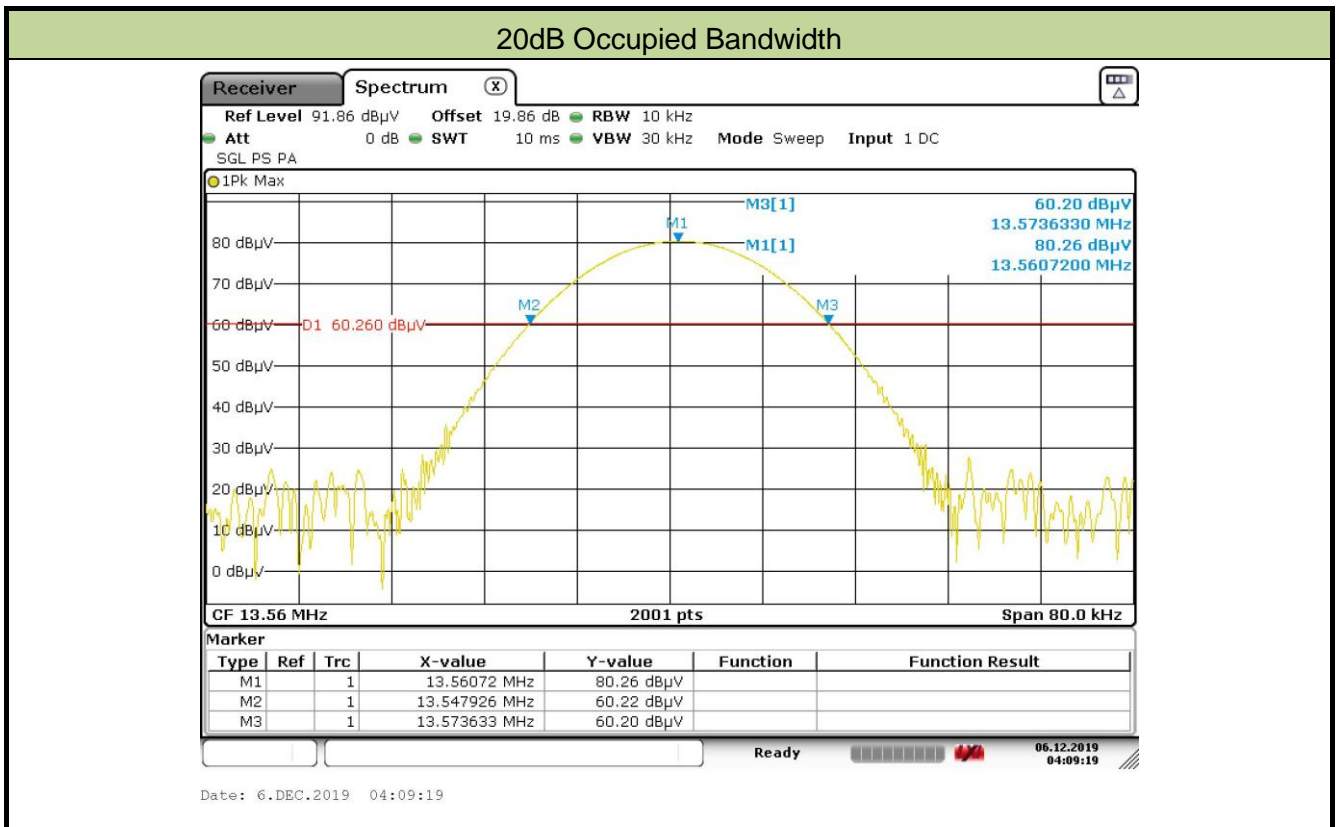

7.5. Frequency Tolerance

7.5.1. Test Limit

The frequency tolerance of the carrier signal shall be maintained within +/- 0.01% of the operating frequency.

7.5.2. Test Procedure Used

ANSI C63.10 Clause 6.8

7.5.3. Test Setting

Frequency stability with respect to ambient temperature

- a) Supply the EUT with a nominal ac voltage (120 V)
- b) Couple the EUT output to the measuring instrument by connecting an antenna to the measuring instrument with a suitable length of coaxial cable and placing the measuring antenna near the EUT (e.g., 15 cm away).
- c) Adjust the location of the measurement antenna and the controls on the measurement instrument to obtain a suitable signal level.
- d) Turn the EUT OFF and place it inside the environmental temperature chamber.
- e) Set the temperature control on the chamber to the highest (50 °C) and allow the oscillator heater and the chamber temperature to stabilize.
- f) While maintaining a constant temperature inside the environmental chamber, turn the EUT ON and record the operating frequency at startup, and at 2 minutes, 5 minutes, and 10 minutes after the EUT is energized. Four measurements in total are made.
- g) Switch OFF the EUT but do not switch OFF the oscillator heater.
- h) Lower the chamber temperature by not more than 10 °C, and allow the temperature inside the chamber to stabilize.
- i) Repeat step f) through step h) down to the lowest specified temperature (-20 °C).

Frequency stability when varying supply voltage

Unless otherwise specified, these tests shall be made at ambient room temperature (+15 °C to +25 °C)

- a) Supply the EUT with nominal voltage (120 V). Turn ON the EUT and couple its output to a

frequency counter or other frequency-measuring instrument.

- b) Adjust the location of the measurement antenna and the controls on the measurement instrument to obtain a suitable signal level.
- c) Repeat the above procedure at 85% and 115% of the nominal supply voltage.

7.5.4. Test Setup

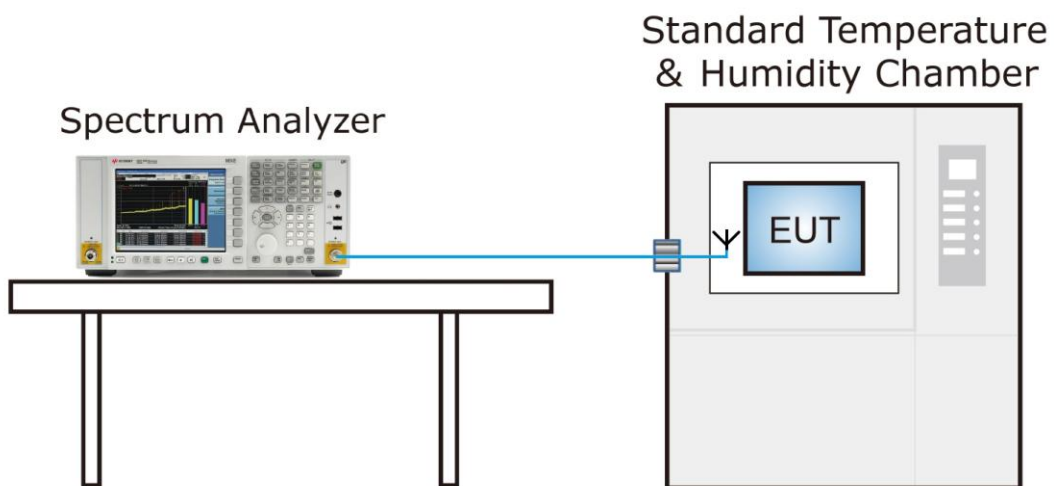

7.5.5. Test Result

Test Engineer	David Lv	Temperature	25°C
Test Time	2019/12/06	Relative Humidity	56%
Test Mode	Mode1	Test Site	AC1

Voltage (%)	Power (VAC)	Temp (°C)	Frequency Tolerance (%)			
			0 minutes	2 minutes	5 minutes	10 minutes
100%	120	- 20	-0.0038	-0.0032	-0.0027	-0.0021
		- 10	-0.0038	-0.0030	-0.0025	-0.0019
		0	-0.0038	-0.0030	-0.0026	-0.0018
		+ 10	-0.0037	-0.0030	-0.0024	-0.0017
		+ 20 (Ref)	-0.0037	-0.0031	-0.0023	-0.0018
		+ 30	-0.0037	-0.0029	-0.0022	-0.0016
		+ 40	-0.0037	-0.0031	-0.0021	-0.0014
		+ 50	-0.0037	-0.0031	-0.0022	-0.0013
115%	138	+ 20	-0.0037	-0.0030	-0.0023	-0.0015
85%	102	+ 20	-0.0037	-0.0031	-0.0024	-0.0015

7.6. AC Conducted Emissions Measurement

7.6.1. Test Limit

FCC 15.207 Limits		
Frequency (MHz)	QP (dBuV)	AV (dBuV)
0.15 ~ 0.50	66 ~ 56	56 ~ 46
0.50 ~ 5.0	56	46
5.0 ~ 30	60	50

Note 1: The lower limit shall apply at the transition frequencies.

Note 2: The limit decreases linearly with the logarithm of the frequency in the range 0.15MHz to 0.5MHz.

7.6.2. Test Setup

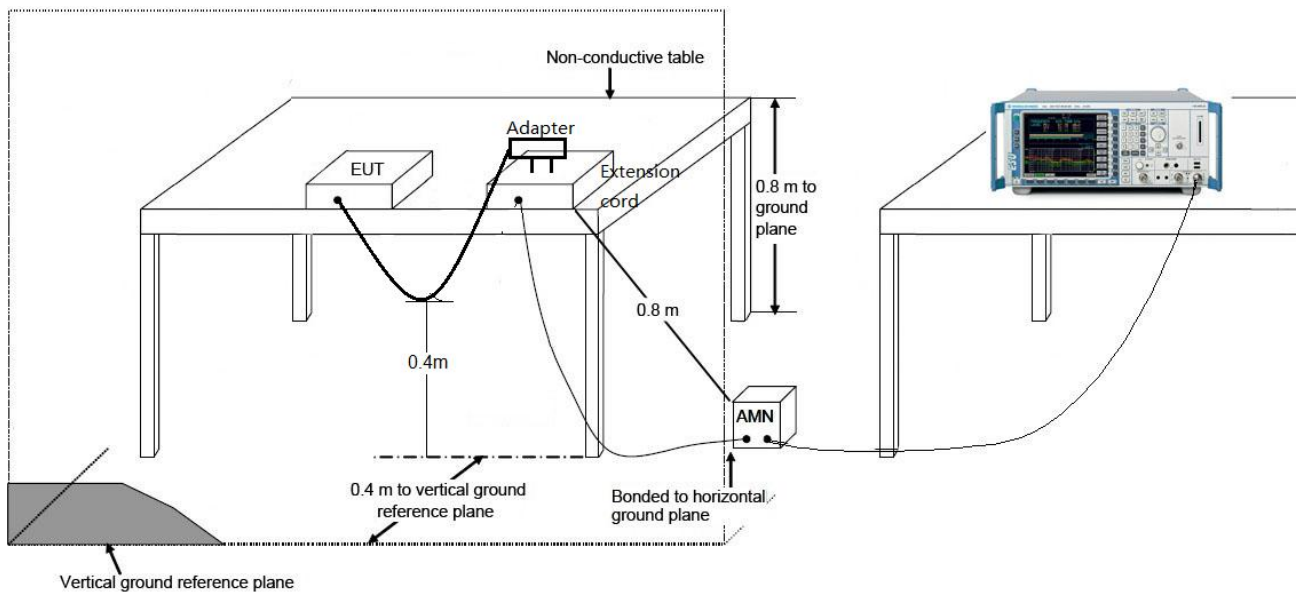

7.6.3. Test Result

Site: SR2	Time: 2019/12/06 - 16:39
Limit: FCC_Part15.207_CE_AC Power	Engineer: Liz Yuan
Probe: ENV216_101683_Filter On	Polarity: Line
EUT: Wireless POS Terminal	Power: AC 120V/60Hz
Test Mode 1	

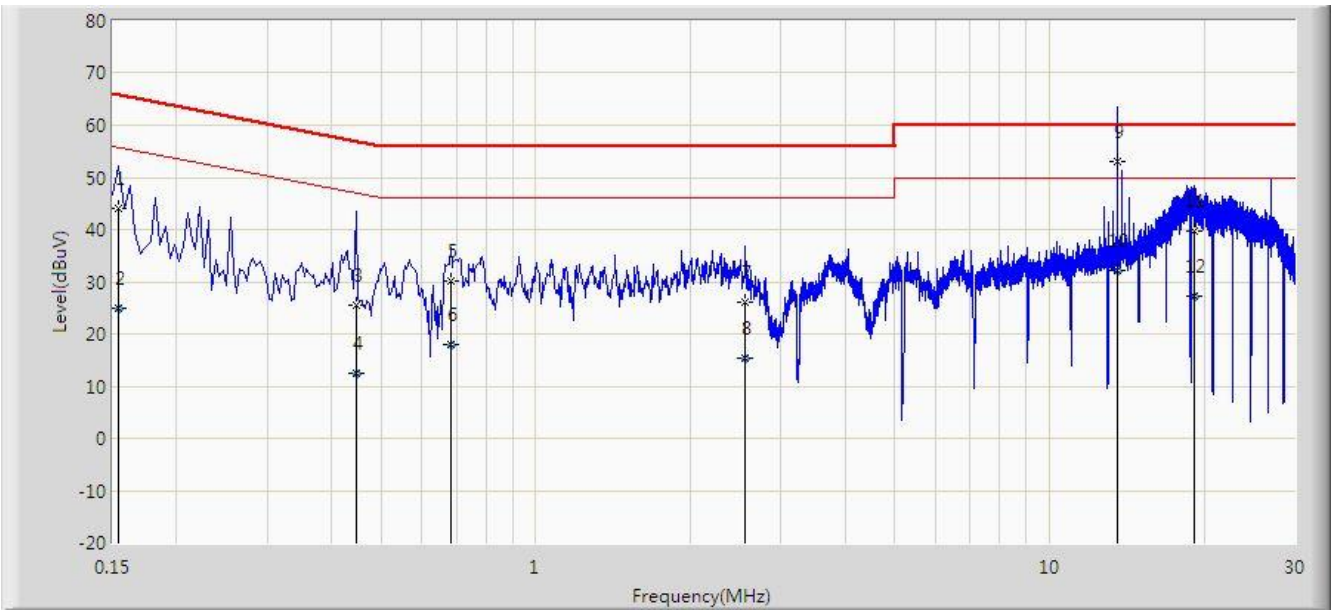

No	Flag	Mark	Frequency (MHz)	Measure Level (dBuV)	Reading Level (dBuV)	Margin (dB)	Limit (dBuV)	Factor (dB)	Type
1			0.154	43.983	33.244	-21.798	65.781	10.740	QP
2			0.154	24.861	14.121	-30.921	55.781	10.740	AV
3			0.446	25.541	15.418	-31.408	56.949	10.123	QP
4			0.446	12.364	2.241	-34.586	46.949	10.123	AV
5			0.682	30.062	19.990	-25.938	56.000	10.072	QP
6			0.682	18.080	8.008	-27.920	46.000	10.072	AV
7			2.550	26.134	16.279	-29.866	56.000	9.855	QP
8			2.550	15.411	5.556	-30.589	46.000	9.855	AV
9		*	13.550	53.057	43.000	-6.943	60.000	10.057	QP
10			13.550	32.057	22.000	-17.943	50.000	10.057	AV
11			19.094	39.849	29.735	-20.151	60.000	10.114	QP
12			19.094	27.380	17.266	-22.620	50.000	10.114	AV

Note 1: Measure Level (dBμV) = Reading Level (dBμV) + Factor (dB)

Factor (dB) = Cable Loss (dB) + LISN Factor (dB).

Note 2: 13.55MHz is NFC working frequency.

Site: SR2	Time: 2019/12/06 - 16:44
Limit: FCC_Part15.207_CE_AC Power	Engineer: Liz Yuan
Probe: ENV216_101683_Filter On	Polarity: Neutral
EUT: Wireless POS Terminal	Power: AC 120V/60Hz
Test Mode 1	

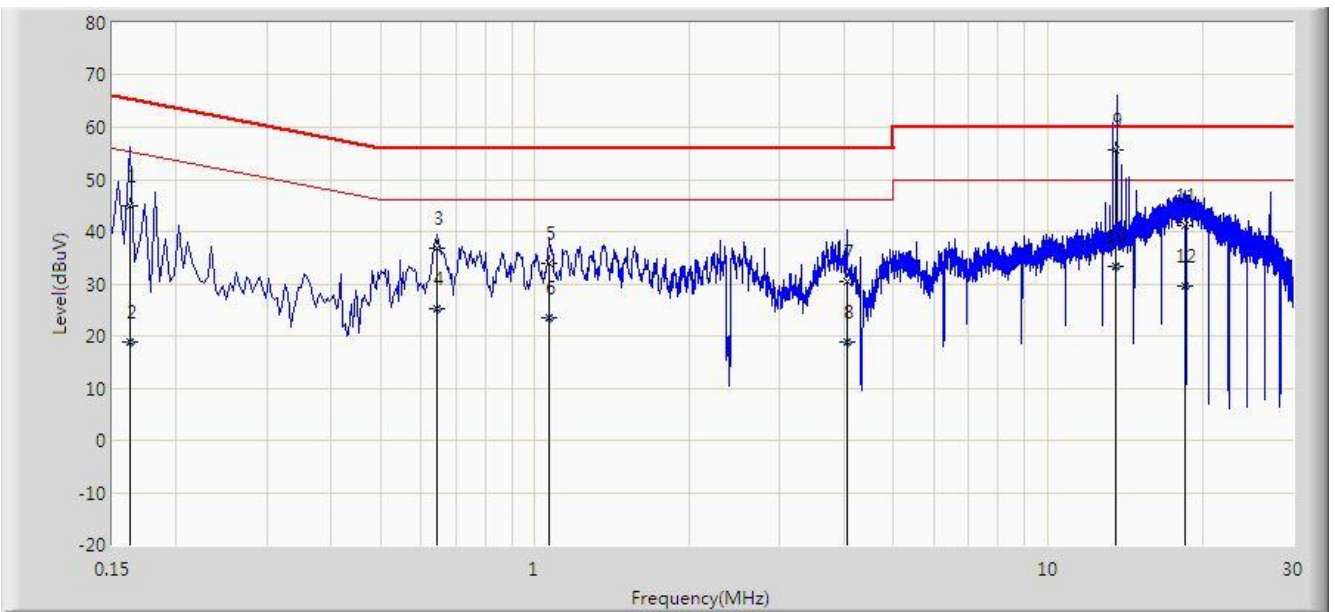

No	Flag	Mark	Frequency (MHz)	Measure Level (dBuV)	Reading Level (dBuV)	Margin (dB)	Limit (dBuV)	Factor (dB)	Type
1			0.162	44.848	34.770	-20.512	65.361	10.078	QP
2			0.162	18.716	8.638	-36.645	55.361	10.078	AV
3			0.646	36.956	26.851	-19.044	56.000	10.105	QP
4			0.646	25.272	15.166	-20.728	46.000	10.105	AV
5			1.062	33.960	24.053	-22.040	56.000	9.907	QP
6			1.062	23.391	13.484	-22.609	46.000	9.907	AV
7			4.050	30.328	20.353	-25.672	56.000	9.975	QP
8			4.050	18.828	8.853	-27.172	46.000	9.975	AV
9			13.550	55.598	45.500	-4.402	60.000	10.098	QP
10			13.550	33.298	23.200	-16.702	50.000	10.098	AV
11		*	18.530	41.095	30.947	-18.905	60.000	10.148	QP
12			18.530	29.559	19.411	-20.441	50.000	10.148	AV

Note 1: Measure Level (dBμV) = Reading Level (dBμV) + Factor (dB)

Factor (dB) = Cable Loss (dB) + LISN Factor (dB).

Note 2: 13.55MHz is NFC working frequency.

8. CONCLUSION

The data collected relate only the item(s) tested and show that this device is in compliance with Part 15C of the FCC Rules.

————— The End —————

Appendix A - Test Setup Photograph

Refer to "1909RSU034-UT" file.

Appendix B - EUT Photograph

Refer to "1909RSU034-UE" file.