



FCC PART 27, PART 90
FCC PART 22H, PART 24
TEST REPORT

For

Vanstone Electronic (Beijing) Co., Ltd.

3F No.2 Building, Aisino Corporation Park 18A, Xingshikou Road, Haidian District, Beijing,
China 100195

FCC ID: OWLA80

Report Type: Original Report	Product Type: Smart POS Terminal
Report Number:	SZXX1210513-17093E-RF-00A
Report Date:	2021-09-09
Reviewed By:	RF Engineer <i>Jimmy Xiao</i>
Prepared By:	Bay Area Compliance Laboratories Corp. (Shenzhen) 5F(B-West) ,6F,7F,the 3rd Phase of Wan Li Industrial Building D,Shihua Rd, FuTian Free Trade Zone, Shenzhen, China Tel: +86-755-33320018 Fax: +86-755-33320008 www.baclcorp.com.cn

Note: This report may contain data that are not covered by the A2LA accreditation and are marked with an asterisk “★”.

BACL is not responsible for the authenticity of any test data provided by the applicant. Data included from the applicant that may affect test results are marked with an asterisk “*”. Customer model name, addresses, names, trademarks etc. are not considered data.

This report cannot be reproduced except in full, without prior written approval of the Company. Unless otherwise stated the results shown in this test report refer only to the sample(s) tested. This report is valid only with a valid digital signature. The digital signature may be available only under the Adobe software above version 7.0.

TABLE OF CONTENTS

GENERAL INFORMATION	3
PRODUCT DESCRIPTION FOR EQUIPMENT UNDER TEST (EUT)	3
OBJECTIVE	3
TEST METHODOLOGY	4
MEASUREMENT UNCERTAINTY	4
TEST FACILITY	4
SYSTEM TEST CONFIGURATION	5
DESCRIPTION OF TEST CONFIGURATION	5
EQUIPMENT MODIFICATIONS	6
SUPPORT EQUIPMENT LIST AND DETAILS	6
SUPPORT CABLE DESCRIPTION	6
BLOCK DIAGRAM OF TEST SETUP	7
SUMMARY OF TEST RESULTS	8
TEST EQUIPMENT LIST	9
FCC §1.1307(B) & §2.1093 - RF EXPOSURE INFORMATION	11
APPLICABLE STANDARD	11
TEST RESULT	11
FCC §2.1047 - MODULATION CHARACTERISTIC	12
FCC § 2.1046, § 22.913 (A), § 24.232 (C), §27.50, §90.635 - RF OUTPUT POWER	13
APPLICABLE STANDARD	13
TEST PROCEDURE	13
TEST DATA	13
FCC §2.1049, §22.917, §22.905 & §24.238 & §27.53, §90.209- OCCUPIED BANDWIDTH	41
APPLICABLE STANDARD	41
TEST PROCEDURE	41
TEST DATA	41
FCC §2.1051, §22.917(A), §24.238(A), §27.53, §90.691 - SPURIOUS EMISSIONS AT ANTENNA TERMINALS	72
APPLICABLE STANDARD	72
TEST PROCEDURE	72
TEST DATA	72
FCC § 2.1053, § 22.917 (A),§ 24.238 (A), §27.53, §90.691-SPURIOUS RADIATED EMISSIONS	91
APPLICABLE STANDARD	91
TEST PROCEDURE	91
TEST DATA	91
FCC § 22.917 (A), § 24.238 (A), §27.53, §90.691 - BAND EDGES	102
APPLICABLE STANDARD	102
TEST PROCEDURE	102
TEST DATA	102
FCC § 2.1055, § 22.355, § 24.235, §27.54, §90.213- FREQUENCY STABILITY	116
APPLICABLE STANDARD	116
TEST PROCEDURE	116
TEST DATA	117

GENERAL INFORMATION

Product Description for Equipment under Test (EUT)

Product	Smart POS Terminal
Tested Model	A80
Frequency Range	GSM 850: 824-849MHz(TX); 869-894MHz(RX) PCS 1900: 1850-1910MHz(TX); 1930-1990MHz(RX) WCDMA Band 2: 1850-1910MHz(TX); 1930-1990MHz(RX) WCDMA Band 4: 1710-1755MHz(TX); 2110-2155MHz(RX) WCDMA Band 5: 824-849MHz(TX); 869-894MHz(RX) LTE Band 2: 1850-1910MHz(TX); 1930-1990MHz(RX) LTE Band 4: 1710-1755MHz(TX); 2110-2155MHz(RX) LTE Band 5: 824-849MHz(TX); 869-894MHz(RX) LTE Band 7: 2500-2570MHz(TX); 2620-2690MHz(RX) LTE Band 12: 699-716MHz(TX); 729-746MHz(RX) LTE Band 13: 777-787MHz(TX); 746-756MHz(RX) LTE Band 25: 1850-1915MHz(TX); 1930-1995MHz(RX) LTE Band 26: 814-849MHz(TX); 859-894MHz(RX)
Modulation Technique	2G: GMSK, 8PSK 3G: BPSK, QPSK, 16QAM 4G: QPSK, 16QAM
Antenna Specification*	GSM850/WCDMA Band 5/LTE Band 5/LTE Band 26: 0.5dBi PCS1900/WCDMA Band 2/ LTE Band 2/ LTE Band 25: 0.8dBi WCDMA Band 4/LTE Band 4: 0.8dBi LTE Band 7: 0.8dBi LTE Band 12/Band 13: 0.5dBi (provided by the applicant)
Voltage Range	DC 3.85V from battery or DC 5.0V from adapter
Sample number	SZXX1210513-17093E-RF-S_511 (Assigned by BAACL, Shenzhen)
Received date	2021-05-13
Sample/EUT Status	Good condition
Adapter information	Model: SW-0018C Input: AC 100-240V ~ 50/60Hz, 0.2A Output: DC 5.0V, 1.0A

Objective

This test report is in accordance with Part 2-Subpart J, Part 22-Subpart H and Part 24-Subpart E and Subpart 27, Part 90 of the Federal Communication Commissions rules.

The objective is to determine the compliance of the EUT with FCC rules for output power, modulation characteristic, occupied bandwidth, and spurious emission at antenna terminal, spurious radiated emission, frequency stability and band edge.

Test Methodology

All tests and measurements indicated in this document were performed in accordance with the Code of Federal Regulations Title 47 Part 2-Subpart J as well as the following parts:

Part 22 Subpart H - Public Mobile Services
 Part 24 Subpart E - Personal Communication Services
 Part 27 – Miscellaneous wireless communications services
 Part 90 – Private Land Mobile Radio Service

ANSI C63.26-2015: American National Standard for Compliance Testing of Transmitters Used in Licensed Radio Services

All emissions measurement was performed at Bay Area Compliance Laboratories Corp. (Shenzhen). The radiated testing was performed at an antenna-to-EUT distance of 3 meters. Each test item follows test standards and with no deviation.

Measurement Uncertainty

Parameter		Uncertainty
Occupied Channel Bandwidth		±5%
RF output power, conducted		±0.73dB
Unwanted Emission, conducted		±1.6dB
Emissions, Radiated	Below 1GHz	±4.75dB
	Above 1GHz	±4.88dB
Temperature		±1°C
Humidity		±6%
Supply voltages		±0.4%

Note: The extended uncertainty given in this report is obtained by combining the standard uncertainty times the coverage factor K with the 95% confidence interval. Otherwise required by the applicant or Product Regulations, Decision Rule in this report did not consider the uncertainty.

Test Facility

The Test site used by Bay Area Compliance Laboratories Corp. (Shenzhen) to collect test data is located on the 5F(B-West), 6F, 7F, the 3rd Phase of Wan Li Industrial Building D, Shihua Rd, FuTian Free Trade Zone, Shenzhen, China.

The test site has been approved by the FCC under the KDB 974614 D01 and is listed in the FCC Public Access Link (PAL) database, FCC Registration No.: 342867, the FCC Designation No.: CN1221.

The test site has been registered with ISED Canada under ISED Canada Registration Number 3062B.

SYSTEM TEST CONFIGURATION

Description of Test Configuration

The final qualification test was performed with the EUT operating at normal mode.

Test was performed as below table:

Frequency Band	Bandwidth (MHz)	Test Frequency (MHz)		
		Low	Middle	High
GSM850	0.25	824.2	836.6	848.8
PCS1900	0.25	1850.2	1880	1909.8
WCDMA B2	4.2	1852.4	1880	1907.6
WCDMA B4	4.2	1712.4	1732.6	1752.6
WCDMA B5	4.2	826.4	836.6	846.6
LTE B2	1.4	1850.7	1880	1909.3
	3	1851.5	1880	1908.5
	5	1852.5	1880	1907.5
	10	1855	1880	1905
	15	1857.5	1880	1902.5
	20	1860	1880	1900
LTE B4	1.4	1710.7	1732.5	1754.3
	3	1711.5	1732.5	1753.5
	5	1712.5	1732.5	1752.5
	10	1715	1732.5	1750
	15	1717.5	1732.5	1747.5
	20	1720	1732.5	1745
LTE B5	1.4	824.7	836.5	848.3
	3	825.5	836.5	847.5
	5	826.5	836.5	846.5
	10	829	836.5	844
LTE B7	5	2502.5	2535	2567.5
	10	2505	2535	2565
	15	2507.5	2535	2562.5
	20	2510	2535	2560
LTE B12	1.4	699.7	707.5	715.3
	3	700.5	707.5	714.5
	5	701.5	707.5	713.5
	10	704	707.5	711
LTE B13	15	779.5	782	784.5
	20	/	782	/

Frequency Band	Bandwidth (MHz)	Test Frequency (MHz)		
		Low	Middle	High
LTE B25	1.4	1850.7	1882.5	1914.3
	3	1851.5	1882.5	1913.5
	5	1852.5	1882.5	1912.5
	10	1855	1882.5	1910
	15	1857.5	1882.5	1907.5
	20	1860	1882.5	1905
LTE B26	1.4	814.7	831.5	848.3
	3	815.5	831.5	847.5
	5	816.5	831.5	846.5
	10	819	831.5	844
	15	821.5	831.5	841.5

Equipment Modifications

No modification was made to the EUT.

Support Equipment List and Details

Manufacturer	Description	Model	Serial Number
Rohde & Schwarz	Universal Radio Communication Tester	CMU200	110605
Rohde & Schwarz	Wideband Radio Communication tester	CMW500	146520

Support Cable Description

Cable Description	Length (m)	From / Port	To
Un-Shielded Detachable AC Cable	1.2	AC Power	CMW500/ CMU200

Block Diagram of Test Setup

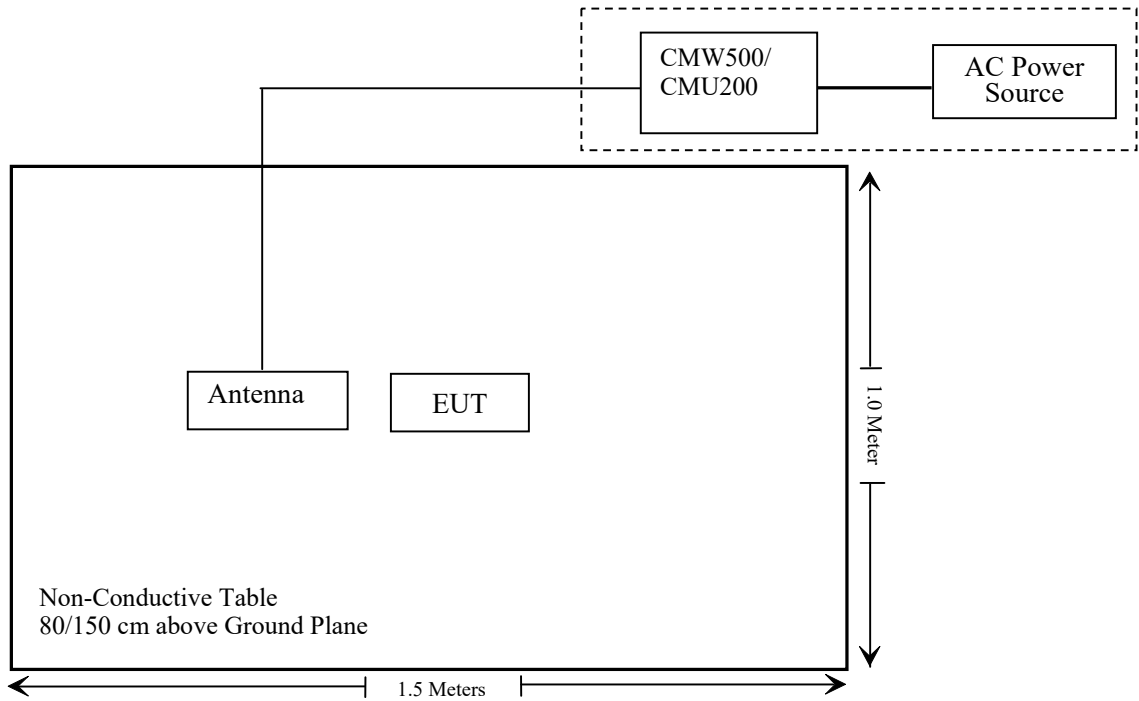

SUMMARY OF TEST RESULTS

FCC Rules	Description of Test	Result
§1.1307 , §2.1093	RF Exposure (SAR)	Compliant*
§2.1046; § 22.913 (a); § 24.232 (c); §27.50; §90.635	RF Output Power	Compliant
§ 2.1047	Modulation Characteristics	Not Applicable
§ 2.1049; § 22.905; § 22.917; § 24.238; §27.53; § 90.209	Occupied Bandwidth	Compliant
§ 2.1051; § 22.917 (a); § 24.238 (a); §27.53 §90.691	Spurious Emissions at Antenna Terminal	Compliant
§ 2.1053; § 22.917 (a); § 24.238 (a); §27.53 §90.691	Field Strength of Spurious Radiation	Compliant
§ 22.917 (a); § 24.238 (a); §27.53 § 90.691	Band Edge	Compliant
§ 2.1055; § 22.355; § 24.235; §27.54; § 90.213	Frequency stability	Compliant

Note: * Please refer to SAR report released by BACL, report number: SZXX1210513-17093E-20A.

TEST EQUIPMENT LIST

Manufacturer	Description	Model	Serial Number	Calibration Date	Calibration Due Date
Radiated Emission Test					
R&S	EMI Test Receiver	ESR3	102455	2020/08/04	2022/08/03
Sonoma instrument	Pre-amplifier	310 N	186238	2020/08/04	2022/08/03
Sunol Sciences	Broadband Antenna	JB1	A040904-2	2020/12/22	2023/12/21
COM-POWER	Dipole Antenna	AD-100	721027	NCR	NCR
Unknown	Cable	Chamber Cable 1	F-03-EM236	2020/11/29	2021/11/28
Unknown	Cable	Chamber Cable 4	EC-007	2020/11/29	2021/11/28
Rohde & Schwarz	Spectrum Analyzer	FSV40-N	102259	2020/07/06	2022/07/05
COM-POWER	Pre-amplifier	PA-122	181919	2020/11/29	2021/11/28
Quinstar	Amplifier	QLW-18405536-J0	15964001002	2020/11/28	2021/11/27
Sunol Sciences	Horn Antenna	3115	9107-3694	2021/01/15	2024/01/14
A.H.System	Horn Antenna	SAS-200/571	135	2018/07/14	2021/07/13
Insulted Wire Inc.	RF Cable	SPS-2503-3150	02222010	2020/11/29	2021/11/28
MICRO-TRONICS	Passband filter	HPM50111	F-19-EM006	2021/04/20	2022/04/20
Unknown	High Pass filter	1.3GHz	101120	2021/04/20	2022/04/20
the electro-Mechanics Co	Horn Antenna	3116	9510-2270	2019/10/13	2022/10/12
the electro-Mechanics Co	Horn Antenna	3116	2026	2019/10/13	2022/10/12
Agilent	Signal Generator	N5183A	MY51040755	2020/12/29	2021/12/28

Manufacturer	Description	Model	Serial Number	Calibration Date	Calibration Due Date
RF Conducted Test					
Rohde & Schwarz	SPECTRUM ANALYZER	FSU26	200120	2021/04/02	2022/04/01
Unknown	RF Cable	Unknown	0501 067	2020/11/29	2021/11/28
Weinschel	Power divider	1515	RH386	2021/04/20	2022/04/20
ESPEC	Temperature & Humidity Chamber	EL-10KA	9107726	2021/02/23	2022/02/22
Rohde & Schwarz	Universal Radio Communication Tester	CMU200	115500	2020/07/31	2022/07/30
Rohde & Schwarz	Wideband Radio Communication Tester	CMW500	1201.002K50-146520-wh	2020/08/04	2022/08/03
instek	DC Power Supply	GPS-3030DD	EM832096	NCR	NCR
Fluke	Digital Multimeter	287	19000011	2020/07/23	2022/07/22

* Statement of Traceability: Bay Area Compliance Laboratories Corp. (Shenzhen) attests that all calibrations have been performed in accordance to requirements that traceable to National Primary Standards and International System of Units (SI).

FCC §1.1307(b) & §2.1093 - RF EXPOSURE INFORMATION

Applicable Standard

FCC§1.1310 and §2.1093.

Test Result

Compliance, please refer to the SAR report: SZXX1210513-17093E-20A.

FCC §2.1047 - MODULATION CHARACTERISTIC

According to FCC § 2.1047(d), Part 22H & 24E & 27 & Part 90 there is no specific requirement for digital modulation, therefore modulation characteristic is not presented.

FCC § 2.1046, § 22.913 (a), § 24.232 (c), §27.50, §90.635 - RF OUTPUT POWER

Applicable Standard

According to FCC §2.1046 and §22.913 (a), the ERP of mobile transmitters and auxiliary test transmitters must not exceed 7 watts.

According to FCC §2.1046 and §24.232 (C), mobile and portable stations are limited to 2 watts EIRP and the equipment must employ a means for limiting power to the minimum necessary for successful communications.

The peak-to-average power ratio (PAPR) of the transmitter output power must not exceed 13 dB.

According to §27.50(b), Portable stations (hand-held devices) transmitting in the 746-757 MHz, 776-788 MHz, and 805-806 MHz bands are limited to 3 watts ERP..

According to §27.50(c), Portable stations (hand-held devices) in the 600 MHz uplink band and the 698-746 MHz band, and fixed and mobile stations in the 600 MHz uplink band are limited to 3 watts ERP.

According to §27.50(d), the maximum EIRP must not exceed 1Watts (30dBm) for 1710-1780MHz.

According to §27.50(h), the maximum EIRP must not exceed 2Watts (33dBm) for 2500-2570MHz & 2496-2690MHz.

Test Procedure

Conducted method:

The RF output of the transmitter was connected to the CMW500/CMU200 through sufficient attenuation.

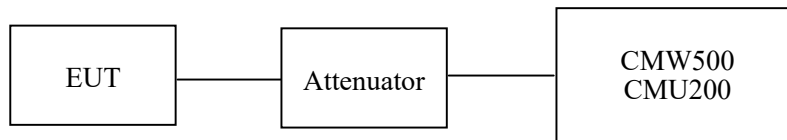

Test Data

Environmental Conditions

Temperature:	27.8~29.1 °C
Relative Humidity:	49~57 %
ATM Pressure:	100.9~101.2 kPa

The testing was performed by Pedro Yun from 2021-05-31 to 2021-07-18.

EUT operation mode: Transmitting

Test Result: Pass

Please refer to the following tables and plots.

Cellular 850

Mode	Channel	Frequency (MHz)	Average Output Power (dBm)				ERP(dBm)				Limit (dBm)
			1 slot	2 slots	3 slots	4 slots	1 slot	2 slots	3 slots	4 slots	
GPRS	128	824.2	32.13	30.35	27.98	26.58	30.48	28.70	26.33	24.93	38.45
	190	836.6	32.16	30.41	28.05	26.69	30.51	28.76	26.40	25.04	38.45
	251	848.8	32.21	31.56	28.14	26.77	30.56	29.91	26.49	25.12	38.45

Mode	Channel	Frequency (MHz)	Average Output Power (dBm)				ERP(dBm)				Limit (dBm)
			1 slot	2 slots	3 slots	4 slots	1 slot	2 slots	3 slots	4 slots	
EGPRS	128	824.2	27.52	26.04	24.22	22.82	25.87	24.39	22.57	21.17	38.45
	190	836.6	27.59	26.13	24.35	22.87	25.94	24.48	22.70	21.22	38.45
	251	848.8	27.63	26.14	24.51	22.91	25.98	24.49	22.86	21.26	38.45

Mode	Test Mode	3GPP Sub Test	Average Output Power (dBm)			ERP(dBm)		
			Low	Mid	High	Low	Mid	High
WCDMA (Band 5)	RMC12.2k		22.71	22.56	22.41	21.06	20.91	20.76
	HSDPA	1	22.35	22.16	22.15	20.70	20.51	20.50
		2	22.43	22.23	22.20	20.78	20.58	20.55
		3	22.48	22.27	22.25	20.83	20.62	20.60
		4	22.53	22.32	22.27	20.88	20.67	20.62
	HSUPA	1	21.84	21.63	21.55	20.19	19.98	19.90
		2	21.88	21.71	21.61	20.23	20.06	19.96
		3	21.95	21.75	21.65	20.30	20.10	20.00
		4	22.01	21.82	21.71	20.36	20.17	20.06
		5	22.07	21.89	21.78	20.42	20.24	20.13
	HSPA+	1	22.13	21.95	21.81	20.48	20.30	20.16

Note: ERP(dBm) = Conducted Power(dBm) + Antenna Gain(dBd)
 For GPRS850/WCDMA Band5: Antenna Gain = 0.5dBi = -1.65dBd (0dBd=2.15dBi) (provided by the applicant)
 Limit: ERP ≤ 38.45dBm

PCS 1900

Mode	Channel	Frequency (MHz)	Average Output Power (dBm)				EIRP(dBm)				Limit (dBm)
			1 slot	2 slots	3 slots	4 slots	1 slot	2 slots	3 slots	4 slots	
GPRS	512	1850.2	27.45	26.12	24.35	22.28	28.25	26.92	25.15	23.08	33
	661	1880.0	27.48	26.15	24.38	22.36	28.28	26.95	25.18	23.16	33
	810	1909.8	27.61	26.22	24.56	22.41	28.41	27.02	25.36	23.21	33

Mode	Channel	Frequency (MHz)	Average Output Power (dBm)				EIRP(dBm)				Limit (dBm)
			1 slot	2 slots	3 slots	4 slots	1 slot	2 slots	3 slots	4 slots	
EGPRS	512	1850.2	24.01	23.11	21.04	19.94	24.81	23.91	21.84	20.74	33
	661	1880.0	24.12	23.18	21.45	19.98	24.92	23.98	22.25	20.78	33
	810	1909.8	24.15	23.34	21.68	19.97	24.95	24.14	22.48	20.77	33

Mode	Test Mode	3GPP Sub Test	Average Output Power (dBm)			EIRP(dBm)		
			Low	Mid	High	Low	Mid	High
WCDMA (Band 2)	RMC12.2k		19.88	19.85	19.64	20.68	20.65	20.44
	HSDPA	1	19.62	19.60	19.52	20.42	20.40	20.32
		2	19.69	19.62	19.57	20.49	20.42	20.37
		3	19.74	19.65	19.60	20.54	20.45	20.40
		4	19.78	19.72	19.67	20.58	20.52	20.47
	HSUPA	1	19.51	19.53	19.48	20.31	20.33	20.28
		2	19.56	19.56	19.54	20.36	20.36	20.34
		3	19.58	19.62	19.56	20.38	20.42	20.36
		4	19.61	19.68	19.58	20.41	20.48	20.38
		5	19.63	19.74	19.64	20.43	20.54	20.44
HSPA+	1	19.69	19.81	19.68	20.49	20.61	20.48	

Note: EIRP(dBm) = Conducted Power(dBm) + Antenna Gain(dBi)
 For PCS1900/WCDMA Band 2: Antenna Gain = 0.8dBi (provided by the applicant)
 Limit: EIRP ≤ 33dBm

AWS Band

Mode	Test Mode	3GPP Sub Test	Average Output Power (dBm)			EIRP(dBm)		
			Low	Mid	High	Low	Mid	High
WCDMA Band 4	RMC12.2k		21.69	21.46	21.44	22.49	22.26	22.24
	HSDPA	1	20.66	20.38	20.35	21.46	21.18	21.15
		2	20.71	20.40	20.41	21.51	21.20	21.21
		3	20.77	20.45	20.45	21.57	21.25	21.25
		4	20.80	20.50	20.50	21.60	21.30	21.30
	HSUPA	1	20.80	20.57	20.54	21.60	21.37	21.34
		2	20.82	20.63	20.61	21.62	21.43	21.41
		3	20.89	20.69	20.66	21.69	21.49	21.46
		4	20.94	20.74	20.72	21.74	21.54	21.52
		5	21.00	20.78	20.78	21.80	21.58	21.58
	HSPA+	1	21.07	20.85	20.82	21.87	21.65	21.62

Note: EIRP(dBm) = Conducted Power(dBm) + Antenna Gain(dBi)
 For Band 4: Antenna Gain = 0.8dBi (provided by the applicant)
 Limit: EIRP ≤ 30dBm

Peak-to-average ratio (PAR)

Cellular Band

Mode	Channel	PAR (dB)	Limit (dB)
GPRS	Low	3.18	13
	Middle	3.43	13
	High	3.45	13
EGPRS	Low	3.35	13
	Middle	3.49	13
	High	3.53	13

Mode	Channel	PAR (dB)	Limit (dB)
RMC (BPSK)	Low	3.44	13
	Middle	3.32	13
	High	3.48	13
HSDPA (16QAM)	Low	3.43	13
	Middle	3.16	13
	High	3.37	13
HSUPA (BPSK)	Low	3.14	13
	Middle	3.15	13
	High	3.33	13
HSUPA+	Low	3.43	13
	Middle	3.31	13
	High	3.18	13

PCS Band

Mode	Channel	PAR (dB)	Limit (dB)
GPRS	Low	3.19	13
	Middle	3.15	13
	High	3.47	13
EGPRS	Low	3.53	13
	Middle	3.58	13
	High	3.61	13

Mode	Channel	PAR (dB)	Limit (dB)
RMC (BPSK)	Low	3.54	13
	Middle	3.43	13
	High	3.36	13
HSDPA (16QAM)	Low	3.50	13
	Middle	3.33	13
	High	3.43	13
HSUPA (BPSK)	Low	3.31	13
	Middle	3.63	13
	High	3.47	13
HSUPA+	Low	3.14	13
	Middle	3.31	13
	High	3.24	13

AWS Band

Mode	Channel	PAR (dB)	Limit (dB)
RMC (BPSK)	Low	3.24	13
	Middle	3.26	13
	High	3.58	13
HSDPA (16QAM)	Low	3.37	13
	Middle	3.46	13
	High	3.55	13
HSUPA (BPSK)	Low	3.15	13
	Middle	3.47	13
	High	3.32	13
HSUPA+	Low	3.29	13
	Middle	3.36	13
	High	3.59	13

LTE Band 2

Bandwidth (MHz)	Modulation	RB size/ RB Offset	Conducted Average Output Power (dBm)			EIRP(dBm)		
			Low	Mid	High	Low	Mid	High
1.4	QPSK	RB1#0	19.86	19.89	20.19	20.66	20.69	20.99
		RB1#3	20.02	19.93	20.21	20.82	20.73	21.01
		RB1#5	20.05	19.94	20.19	20.85	20.74	20.99
		RB3#0	20.05	20.05	20.26	20.85	20.85	21.06
		RB3#3	20.04	20.04	20.16	20.84	20.84	20.96
		RB6#0	18.98	19.04	19.15	19.78	19.84	19.95
	16QAM	RB1#0	19.16	18.77	19.84	19.96	19.57	20.64
		RB1#3	19.19	18.82	19.81	19.99	19.62	20.61
		RB1#5	19.17	18.75	19.81	19.97	19.55	20.61
		RB3#0	18.89	19.27	19.29	19.69	20.07	20.09
		RB3#3	18.93	19.28	19.34	19.73	20.08	20.14
		RB6#0	18.03	18.12	18.45	18.83	18.92	19.25
3.0	QPSK	RB1#0	19.88	19.88	20.06	20.68	20.68	20.86
		RB1#8	19.89	19.90	20.10	20.69	20.70	20.90
		RB1#14	19.88	19.95	20.11	20.68	20.75	20.91
		RB6#0	18.92	19.00	19.22	19.72	19.80	20.02
		RB6#9	18.92	19.06	19.14	19.72	19.86	19.94
		RB15#0	18.98	18.91	19.10	19.78	19.71	19.90
	16QAM	RB1#0	19.15	19.50	18.91	19.95	20.30	19.71
		RB1#8	19.18	19.49	18.93	19.98	20.29	19.73
		RB1#14	19.14	19.49	18.98	19.94	20.29	19.78
		RB6#0	18.14	18.20	18.49	18.94	19.00	19.29
		RB6#9	18.08	18.23	18.46	18.88	19.03	19.26
		RB15#0	18.07	17.96	18.27	18.87	18.76	19.07

Bandwidth (MHz)	Modulation	RB size/ RB Offset	Conducted Average Output Power (dBm)			EIRP(dBm)		
			Low	Mid	High	Low	Mid	High
5.0	QPSK	RB1#0	19.90	20.05	20.04	20.70	20.85	20.84
		RB1#13	19.90	20.00	20.07	20.70	20.80	20.87
		RB1#24	19.91	20.10	20.09	20.71	20.90	20.89
		RB15#0	19.04	19.02	19.22	19.84	19.82	20.02
		RB15#10	18.94	18.96	19.17	19.74	19.76	19.97
		RB25#0	18.90	18.97	19.13	19.70	19.77	19.93
	16QAM	RB1#0	18.19	19.11	18.74	18.99	19.91	19.54
		RB1#13	18.24	19.21	18.86	19.04	20.01	19.66
		RB1#24	18.22	19.19	18.85	19.02	19.99	19.65
		RB15#0	18.11	17.96	18.25	18.91	18.76	19.05
		RB15#10	18.13	18.03	18.31	18.93	18.83	19.11
		RB25#0	18.11	18.06	18.09	18.91	18.86	18.89
10.0	QPSK	RB1#0	19.92	20.03	20.06	20.72	20.83	20.86
		RB1#25	19.94	19.97	20.08	20.74	20.77	20.88
		RB1#49	19.94	20.09	20.20	20.74	20.89	21.00
		RB25#0	18.89	18.95	19.14	19.69	19.75	19.94
		RB25#25	19.03	18.94	19.18	19.83	19.74	19.98
		RB50#0	19.09	18.95	19.01	19.89	19.75	19.81
	16QAM	RB1#0	19.40	19.15	18.59	20.20	19.95	19.39
		RB1#25	19.38	19.13	18.65	20.18	19.93	19.45
		RB1#49	19.37	19.20	18.66	20.17	20.00	19.46
		RB25#0	18.05	18.15	18.28	18.85	18.95	19.08
		RB25#25	18.11	18.15	18.31	18.91	18.95	19.11
		RB50#0	18.00	18.14	18.28	18.80	18.94	19.08

Bandwidth (MHz)	Modulation	RB size/ RB Offset	Conducted Average Output Power (dBm)			EIRP(dBm)		
			Low	Mid	High	Low	Mid	High
15.0	QPSK	RB1#0	19.92	19.89	19.99	20.72	20.69	20.79
		RB1#38	19.87	19.86	19.99	20.67	20.66	20.79
		RB1#74	19.95	19.91	20.15	20.75	20.71	20.95
		RB36#0	18.97	19.04	19.04	19.77	19.84	19.84
		RB36#39	18.99	18.99	19.23	19.79	19.79	20.03
		RB75#0	18.93	19.04	19.10	19.73	19.84	19.90
	16QAM	RB1#0	19.35	19.19	19.40	20.15	19.99	20.20
		RB1#38	19.42	19.77	19.48	20.22	20.57	20.28
		RB1#74	19.35	19.76	19.56	20.15	20.56	20.36
		RB36#0	17.99	18.09	18.24	18.79	18.89	19.04
		RB36#39	18.09	18.07	18.29	18.89	18.87	19.09
		RB75#0	18.09	18.05	18.16	18.89	18.85	18.96
20.0	QPSK	RB1#0	20.08	20.01	20.07	20.88	20.81	20.87
		RB1#50	20.14	20.03	20.10	20.94	20.83	20.90
		RB1#99	20.10	20.03	20.28	20.90	20.83	21.08
		RB50#0	18.96	19.05	19.09	19.76	19.85	19.89
		RB50#50	19.03	19.09	19.10	19.83	19.89	19.90
		RB100#0	18.95	18.95	19.08	19.75	19.75	19.88
	16QAM	RB1#0	18.99	19.03	19.72	19.79	19.83	20.52
		RB1#50	19.00	19.07	19.75	19.80	19.87	20.55
		RB1#99	18.99	19.09	19.87	19.79	19.89	20.67
		RB50#0	18.09	18.11	18.01	18.89	18.91	18.81
		RB50#50	18.17	18.20	18.18	18.97	19.00	18.98
		RB100#0	18.11	18.03	18.33	18.91	18.83	19.13

Note: EIRP(dBm) = Conducted Power(dBm) + Antenna Gain(dBi)
 For Band 2: Antenna Gain = 0.8dBi (provided by the applicant)
 Limit: EIRP ≤ 33dBm

LTE Band 4

Bandwidth (MHz)	Modulation	RB size/ RB Offset	Conducted Average Output Power (dBm)			EIRP(dBm)		
			Low	Mid	High	Low	Mid	High
1.4	QPSK	RB1#0	21.29	21.42	21.43	22.09	22.22	22.23
		RB1#3	21.29	21.33	21.44	22.09	22.13	22.24
		RB1#5	21.28	21.41	21.43	22.08	22.21	22.23
		RB3#0	21.31	21.48	21.45	22.11	22.28	22.25
		RB3#3	21.31	21.52	21.34	22.11	22.32	22.14
		RB6#0	20.31	20.42	20.29	21.11	21.22	21.09
	16QAM	RB1#0	20.95	21.14	20.41	21.75	21.94	21.21
		RB1#3	20.93	21.13	20.45	21.73	21.93	21.25
		RB1#5	20.97	21.15	20.53	21.77	21.95	21.33
		RB3#0	20.35	20.33	20.39	21.15	21.13	21.19
		RB3#3	20.40	20.36	20.40	21.20	21.16	21.20
		RB6#0	19.58	19.47	19.73	20.38	20.27	20.53
3.0	QPSK	RB1#0	21.22	21.35	21.47	22.02	22.15	22.27
		RB1#8	21.24	21.38	21.47	22.04	22.18	22.27
		RB1#14	21.24	21.33	21.43	22.04	22.13	22.23
		RB6#0	20.26	20.36	20.30	21.06	21.16	21.10
		RB6#9	20.25	20.39	20.35	21.05	21.19	21.15
		RB15#0	20.28	20.41	20.42	21.08	21.21	21.22
	16QAM	RB1#0	20.77	21.09	20.43	21.57	21.89	21.23
		RB1#8	20.70	21.16	20.42	21.50	21.96	21.22
		RB1#14	20.76	21.12	20.46	21.56	21.92	21.26
		RB6#0	19.25	19.48	19.77	20.05	20.28	20.57
		RB6#9	19.25	19.55	19.66	20.05	20.35	20.46
		RB15#0	19.45	19.40	19.63	20.25	20.20	20.43

Bandwidth (MHz)	Modulation	RB size/ RB Offset	Conducted Average Output Power (dBm)			EIRP(dBm)		
			Low	Mid	High	Low	Mid	High
5.0	QPSK	RB1#0	21.38	21.49	21.19	22.18	22.29	21.99
		RB1#13	21.25	21.41	21.20	22.05	22.21	22.00
		RB1#24	21.26	21.43	21.24	22.06	22.23	22.04
		RB15#0	20.38	20.40	20.44	21.18	21.20	21.24
		RB15#10	20.33	20.33	20.38	21.13	21.13	21.18
		RB25#0	20.30	20.39	20.36	21.10	21.19	21.16
	16QAM	RB1#0	19.52	20.58	19.95	20.32	21.38	20.75
		RB1#13	19.48	20.52	19.97	20.28	21.32	20.77
		RB1#24	19.44	20.62	19.97	20.24	21.42	20.77
		RB15#0	19.46	19.35	19.48	20.26	20.15	20.28
		RB15#10	19.41	19.22	19.45	20.21	20.02	20.25
		RB25#0	19.44	19.38	19.38	20.24	20.18	20.18
10.0	QPSK	RB1#0	21.25	21.39	21.52	22.05	22.19	22.32
		RB1#25	21.20	21.40	21.54	22.00	22.20	22.34
		RB1#49	21.31	21.43	21.50	22.11	22.23	22.30
		RB25#0	20.26	20.28	20.33	21.06	21.08	21.13
		RB25#25	20.34	20.36	20.40	21.14	21.16	21.20
		RB50#0	20.30	20.27	20.33	21.10	21.07	21.13
	16QAM	RB1#0	20.47	20.51	19.94	21.27	21.31	20.74
		RB1#25	20.51	20.55	19.94	21.31	21.35	20.74
		RB1#49	20.54	20.61	19.95	21.34	21.41	20.75
		RB25#0	19.40	19.54	19.54	20.20	20.34	20.34
		RB25#25	19.44	19.51	19.60	20.24	20.31	20.40
		RB50#0	19.39	19.48	19.45	20.19	20.28	20.25

Bandwidth (MHz)	Modulation	RB size/ RB Offset	Conducted Average Output Power (dBm)			EIRP(dBm)		
			Low	Mid	High	Low	Mid	High
15.0	QPSK	RB1#0	21.26	21.43	21.45	22.06	22.23	22.25
		RB1#38	21.32	21.45	21.57	22.12	22.25	22.37
		RB1#74	21.35	21.45	21.50	22.15	22.25	22.30
		RB36#0	20.32	20.36	20.40	21.12	21.16	21.20
		RB36#39	20.36	20.36	20.44	21.16	21.16	21.24
		RB75#0	20.37	20.42	20.44	21.17	21.22	21.24
	16QAM	RB1#0	20.50	20.55	20.82	21.30	21.35	21.62
		RB1#38	20.52	20.57	20.80	21.32	21.37	21.60
		RB1#74	20.56	20.51	20.78	21.36	21.31	21.58
		RB36#0	19.44	19.49	19.52	20.24	20.29	20.32
		RB36#39	19.47	19.55	19.56	20.27	20.35	20.36
		RB75#0	19.49	19.48	19.42	20.29	20.28	20.22
20.0	QPSK	RB1#0	21.43	21.41	21.49	22.23	22.21	22.29
		RB1#50	21.45	21.36	21.50	22.25	22.16	22.30
		RB1#99	21.50	21.44	21.53	22.30	22.24	22.33
		RB50#0	20.33	20.37	20.34	21.13	21.17	21.14
		RB50#50	20.39	20.49	20.35	21.19	21.29	21.15
		RB100#0	20.38	20.45	20.38	21.18	21.25	21.18
	16QAM	RB1#0	20.28	20.83	20.98	21.08	21.63	21.78
		RB1#50	20.38	20.82	20.94	21.18	21.62	21.74
		RB1#99	20.38	20.86	21.04	21.18	21.66	21.84
		RB50#0	19.44	19.50	19.40	20.24	20.30	20.20
		RB50#50	19.47	19.56	19.45	20.27	20.36	20.25
		RB100#0	19.50	19.39	19.46	20.30	20.19	20.26

Note: EIRP(dBm) = Conducted Power(dBm) + Antenna Gain(dBi)
 For Band 4: Antenna Gain = 0.8dBi (provided by the applicant)
 Limit: EIRP ≤ 30dBm

LTE Band 5

Bandwidth (MHz)	Modulation	RB size/ RB Offset	Conducted Average Output Power (dBm)			ERP(dBm)		
			Low	Mid	High	Low	Mid	High
1.4	QPSK	RB1#0	22.69	22.50	22.67	21.04	20.85	21.02
		RB1#3	22.58	22.58	22.65	20.93	20.93	21.00
		RB1#5	22.59	22.57	22.65	20.94	20.92	21.00
		RB3#0	22.78	22.73	22.73	21.13	21.08	21.08
		RB3#3	22.77	22.72	22.67	21.12	21.07	21.02
		RB6#0	21.61	21.73	21.70	19.96	20.08	20.05
	16QAM	RB1#0	22.10	22.26	21.55	20.45	20.61	19.90
		RB1#3	22.00	22.37	21.55	20.35	20.72	19.90
		RB1#5	22.06	22.37	21.58	20.41	20.72	19.93
		RB3#0	21.68	21.69	21.77	20.03	20.04	20.12
		RB3#3	21.77	21.61	21.78	20.12	19.96	20.13
		RB6#0	20.87	20.79	20.99	19.22	19.14	19.34
3.0	QPSK	RB1#0	22.68	22.53	22.70	21.03	20.88	21.05
		RB1#8	22.63	22.63	22.75	20.98	20.98	21.10
		RB1#14	22.59	22.54	22.72	20.94	20.89	21.07
		RB6#0	21.63	21.73	21.64	19.98	20.08	19.99
		RB6#9	21.75	21.74	21.64	20.10	20.09	19.99
		RB15#0	21.68	21.69	21.63	20.03	20.04	19.98
	16QAM	RB1#0	21.94	22.46	21.31	20.29	20.81	19.66
		RB1#8	21.93	22.40	21.35	20.28	20.75	19.70
		RB1#14	22.02	22.39	21.41	20.37	20.74	19.76
		RB6#0	20.82	20.68	20.91	19.17	19.03	19.26
		RB6#9	20.73	20.73	20.86	19.08	19.08	19.21
		RB15#0	20.78	20.76	20.64	19.13	19.11	18.99

Bandwidth (MHz)	Modulation	RB size/ RB Offset	Conducted Average Output Power (dBm)			ERP(dBm)		
			Low	Mid	High	Low	Mid	High
5.0	QPSK	RB1#0	22.80	22.66	22.62	21.15	21.01	20.97
		RB1#13	22.69	22.77	22.64	21.04	21.12	20.99
		RB1#24	22.84	22.78	22.56	21.19	21.13	20.91
		RB15#0	21.81	21.72	21.68	20.16	20.07	20.03
		RB15#10	21.73	21.72	21.59	20.08	20.07	19.94
		RB25#0	21.75	21.78	21.65	20.10	20.13	20.00
	16QAM	RB1#0	21.02	21.83	21.27	19.37	20.18	19.62
		RB1#13	21.01	21.86	21.35	19.36	20.21	19.70
		RB1#24	21.00	21.79	21.38	19.35	20.14	19.73
		RB15#0	20.86	20.62	20.83	19.21	18.97	19.18
		RB15#10	20.92	20.59	20.72	19.27	18.94	19.07
		RB25#0	20.91	20.74	20.59	19.26	19.09	18.94
10.0	QPSK	RB1#0	22.74	22.82	22.72	21.09	21.17	21.07
		RB1#25	22.72	22.70	22.68	21.07	21.05	21.03
		RB1#49	22.71	22.72	22.56	21.06	21.07	20.91
		RB25#0	21.75	21.75	21.72	20.10	20.10	20.07
		RB25#25	21.69	21.72	21.67	20.04	20.07	20.02
		RB50#0	21.78	21.69	21.73	20.13	20.04	20.08
	16QAM	RB1#0	21.81	21.83	21.14	20.16	20.18	19.49
		RB1#25	21.83	21.79	21.22	20.18	20.14	19.57
		RB1#49	21.79	21.84	21.22	20.14	20.19	19.57
		RB25#0	20.81	20.78	20.80	19.16	19.13	19.15
		RB25#25	20.76	20.79	20.74	19.11	19.14	19.09
		RB50#0	20.88	20.82	20.72	19.23	19.17	19.07

Note: ERP(dBm) = Conducted Power(dBm) + Antenna Gain(dBd)
 For Band5: Antenna Gain =0.5dBi = -1.65dBd (0dBd=2.15dBi) (provided by the applicant)
 Limit: ERP ≤ 38.45dBm

LTE Band 7

Bandwidth (MHz)	Modulation	RB size/ RB Offset	Conducted Average Output Power (dBm)			EIRP(dBm)		
			Low	Mid	High	Low	Mid	High
5.0	QPSK	RB1#0	20.13	20.05	19.66	20.93	20.85	20.46
		RB1#13	20.05	20.05	19.69	20.85	20.85	20.49
		RB1#24	20.06	20.05	19.07	20.86	20.85	19.87
		RB15#0	19.22	19.10	18.92	20.02	19.90	19.72
		RB15#10	19.07	18.98	18.97	19.87	19.78	19.77
		RB25#0	19.15	19.10	18.98	19.95	19.90	19.78
	16QAM	RB1#0	18.50	19.17	18.62	19.30	19.97	19.42
		RB1#13	18.44	19.12	18.61	19.24	19.92	19.41
		RB1#24	18.58	19.16	18.64	19.38	19.96	19.44
		RB15#0	18.31	18.01	18.10	19.11	18.81	18.90
		RB15#10	18.30	18.12	18.12	19.10	18.92	18.92
		RB25#0	18.31	18.10	18.02	19.11	18.90	18.82
10.0	QPSK	RB1#0	19.98	20.02	20.18	20.78	20.82	20.98
		RB1#25	19.93	19.90	20.04	20.73	20.70	20.84
		RB1#49	19.96	19.93	19.61	20.76	20.73	20.41
		RB25#0	19.13	18.93	19.01	19.93	19.73	19.81
		RB25#25	19.12	18.93	18.96	19.92	19.73	19.76
		RB50#0	19.17	19.12	19.04	19.97	19.92	19.84
	16QAM	RB1#0	19.33	19.38	18.62	20.13	20.18	19.42
		RB1#25	19.32	19.34	18.57	20.12	20.14	19.37
		RB1#49	19.35	19.33	18.55	20.15	20.13	19.35
		RB25#0	18.21	18.18	18.21	19.01	18.98	19.01
		RB25#25	18.18	18.24	18.22	18.98	19.04	19.02
		RB50#0	18.30	18.20	18.06	19.10	19.00	18.86

Bandwidth (MHz)	Modulation	RB size/ RB Offset	Conducted Average Output Power (dBm)			EIRP(dBm)		
			Low	Mid	High	Low	Mid	High
15.0	QPSK	RB1#0	20.07	20.07	20.12	20.87	20.87	20.92
		RB1#38	20.03	19.90	20.06	20.83	20.70	20.86
		RB1#74	20.17	19.90	18.97	20.97	20.70	19.77
		RB36#0	19.06	19.11	19.06	19.86	19.91	19.86
		RB36#39	19.11	18.99	18.88	19.91	19.79	19.68
		RB75#0	19.02	19.06	19.03	19.82	19.86	19.83
	16QAM	RB1#0	19.46	19.96	19.42	20.26	20.76	20.22
		RB1#38	19.34	19.78	19.46	20.14	20.58	20.26
		RB1#74	19.52	19.76	19.22	20.32	20.56	20.02
		RB36#0	18.21	18.19	18.14	19.01	18.99	18.94
		RB36#39	18.31	18.11	18.09	19.11	18.91	18.89
		RB75#0	18.26	18.21	18.15	19.06	19.01	18.95
20.0	QPSK	RB1#0	20.18	20.14	20.07	20.98	20.94	20.87
		RB1#50	20.16	20.02	20.17	20.96	20.82	20.97
		RB1#99	20.21	19.92	19.20	21.01	20.72	20.00
		RB50#0	19.01	19.03	19.04	19.81	19.83	19.84
		RB50#50	18.98	18.97	18.93	19.78	19.77	19.73
		RB100#0	19.04	19.00	19.04	19.84	19.80	19.84
	16QAM	RB1#0	18.96	19.64	19.55	19.76	20.44	20.35
		RB1#50	19.01	19.53	19.63	19.81	20.33	20.43
		RB1#99	18.82	19.51	19.55	19.62	20.31	20.35
		RB50#0	18.28	18.22	18.06	19.08	19.02	18.86
		RB50#50	18.21	18.27	18.06	19.01	19.07	18.86
		RB100#0	18.09	18.15	18.19	18.89	18.95	18.99

Note: EIRP(dBm) = Conducted Power(dBm) + Antenna Gain(dBi)
 For Band 7: Antenna Gain = 0.8dBi (provided by the applicant)
 Limit: EIRP ≤ 33dBm

LTE Band12

Bandwidth (MHz)	Modulation	RB size/ RB Offset	Conducted Average Output Power (dBm)			ERP(dBm)		
			Low	Mid	High	Low	Mid	High
1.4	QPSK	RB1#0	22.97	22.76	23.01	21.32	21.11	21.36
		RB1#3	22.92	22.85	23.10	21.27	21.20	21.45
		RB1#5	22.91	22.82	23.04	21.26	21.17	21.39
		RB3#0	21.97	21.83	21.84	20.32	20.18	20.19
		RB3#3	22.01	21.85	21.81	20.36	20.20	20.16
		RB6#0	22.07	21.72	21.88	20.42	20.07	20.23
	16QAM	RB1#0	22.02	22.45	21.80	20.37	20.80	20.15
		RB1#3	22.01	22.34	21.88	20.36	20.69	20.23
		RB1#5	22.06	22.34	21.82	20.41	20.69	20.17
		RB3#0	21.11	20.90	21.21	19.46	19.25	19.56
		RB3#3	21.03	20.94	21.11	19.38	19.29	19.46
		RB6#0	20.98	20.96	20.94	19.33	19.31	19.29
3.0	QPSK	RB1#0	22.86	22.81	22.73	21.21	21.16	21.08
		RB1#8	22.94	22.90	22.73	21.29	21.25	21.08
		RB1#14	22.78	22.87	22.80	21.13	21.22	21.15
		RB6#0	22.00	21.73	21.77	20.35	20.08	20.12
		RB6#9	22.04	21.78	21.89	20.39	20.13	20.24
		RB15#0	22.08	21.71	21.76	20.43	20.06	20.11
	16QAM	RB1#0	21.08	21.40	21.52	19.43	19.75	19.87
		RB1#8	21.15	21.27	21.49	19.50	19.62	19.84
		RB1#14	21.16	21.26	21.70	19.51	19.61	20.05
		RB6#0	21.04	20.79	20.98	19.39	19.14	19.33
		RB6#9	20.97	20.84	20.89	19.32	19.19	19.24
		RB15#0	20.96	20.79	20.89	19.31	19.14	19.24

Bandwidth (MHz)	Modulation	RB size/ RB Offset	Conducted Average Output Power (dBm)			ERP(dBm)		
			Low	Mid	High	Low	Mid	High
5.0	QPSK	RB1#0	22.88	22.74	22.84	21.23	21.09	21.19
		RB1#13	22.87	22.79	22.88	21.22	21.14	21.23
		RB1#24	22.85	22.72	23.00	21.20	21.07	21.35
		RB15#0	21.97	21.80	21.91	20.32	20.15	20.26
		RB15#10	21.91	21.81	21.78	20.26	20.16	20.13
		RB25#0	21.88	21.76	21.79	20.23	20.11	20.14
	16QAM	RB1#0	22.30	22.12	21.34	20.65	20.47	19.69
		RB1#13	22.24	21.98	21.43	20.59	20.33	19.78
		RB1#24	22.18	21.94	21.42	20.53	20.29	19.77
		RB15#0	20.97	20.85	20.91	19.32	19.20	19.26
		RB15#10	20.90	20.86	20.96	19.25	19.21	19.31
		RB25#0	20.85	20.94	20.96	19.20	19.29	19.31
10.0	QPSK	RB1#0	22.85	22.85	22.78	21.20	21.20	21.13
		RB1#25	22.81	22.78	22.90	21.16	21.13	21.25
		RB1#49	22.79	22.73	23.10	21.14	21.08	21.45
		RB25#0	21.74	21.87	21.73	20.09	20.22	20.08
		RB25#25	21.68	21.72	21.77	20.03	20.07	20.12
		RB50#0	21.94	21.80	21.90	20.29	20.15	20.25
	16QAM	RB1#0	21.99	22.05	21.97	20.34	20.40	20.32
		RB1#25	21.93	21.96	22.10	20.28	20.31	20.45
		RB1#49	22.01	22.08	22.11	20.36	20.43	20.46
		RB25#0	20.99	20.97	20.86	19.34	19.32	19.21
		RB25#25	21.07	21.00	21.05	19.42	19.35	19.40
		RB50#0	21.01	20.86	20.88	19.36	19.21	19.23

Note: ERP(dBm) = Conducted Power(dBm) + Antenna Gain(dBd)
 For Band12: Antenna Gain =0.5dBi = -1.65dBd (0dBd=2.15dBi) (provided by the applicant)
 Limit: ERP ≤ 34.77dBm

LTE Band 13:

Bandwidth (MHz)	Modulation	RB size/ RB Offset	Conducted Average Output Power (dBm)			ERP(dBm)		
			Low	Mid	High	Low	Mid	High
5	QPSK	RB1#0	22.24	22.15	22.22	20.59	20.50	20.57
		RB1#13	22.27	22.15	22.22	20.62	20.50	20.57
		RB1#24	22.27	22.17	22.21	20.62	20.52	20.56
		RB15#0	22.24	22.39	22.36	20.59	20.74	20.71
		RB15#10	22.23	22.39	22.44	20.58	20.74	20.79
		RB25#0	21.10	21.33	21.35	19.45	19.68	19.70
	16QAM	RB1#0	21.38	21.98	21.06	19.73	20.33	19.41
		RB1#13	21.44	22.00	21.08	19.79	20.35	19.43
		RB1#24	21.38	21.97	21.08	19.73	20.32	19.43
		RB15#0	21.02	21.30	21.51	19.37	19.65	19.86
		RB15#10	21.06	21.37	21.47	19.41	19.72	19.82
		RB25#0	20.17	20.27	20.58	18.52	18.62	18.93
10	QPSK	RB1#0	/	22.19	/	/	20.54	/
		RB1#25	/	22.15	/	/	20.50	/
		RB1#49	/	22.22	/	/	20.57	/
		RB25#0	/	21.34	/	/	19.69	/
		RB25#25	/	21.38	/	/	19.73	/
		RB50#0	/	21.28	/	/	19.63	/
	16QAM	RB1#0	/	22.03	/	/	20.38	/
		RB1#25	/	21.99	/	/	20.34	/
		RB1#49	/	21.95	/	/	20.30	/
		RB25#0	/	20.33	/	/	18.68	/
		RB25#25	/	20.34	/	/	18.69	/
		RB50#0	/	20.41	/	/	18.76	/

Note: ERP(dBm) = Conducted Power(dBm) + Antenna Gain(dBd)
 For Band13: Antenna Gain = 0.5dBi = -1.65dBd (0dBd=2.15dBi) (provided by the applicant)
 Limit: ERP ≤ 34.77dBm

LTE Band 25:

Bandwidth (MHz)	Modulation	RB size/ RB Offset	Conducted Average Output Power (dBm)			EIRP(dBm)		
			Low	Mid	High	Low	Mid	High
1.4	QP SK	RB1#0	20.18	20.19	20.24	20.98	20.99	21.04
		RB1#3	20.13	19.90	19.95	20.93	20.70	20.75
		RB1#5	20.18	20.32	20.11	20.98	21.12	20.91
		RB3#0	19.17	19.23	19.20	19.97	20.03	20.00
		RB3#3	19.22	19.22	19.13	20.02	20.02	19.93
		RB6#0	19.21	19.18	18.98	20.01	19.98	19.78
	16QAM	RB1#0	19.30	19.39	19.50	20.10	20.19	20.30
		RB1#3	19.13	19.10	19.04	19.93	19.90	19.84
		RB1#5	19.18	19.14	19.31	19.98	19.94	20.11
		RB3#0	19.01	18.99	18.93	19.81	19.79	19.73
		RB3#3	19.00	19.02	18.88	19.80	19.82	19.68
		RB6#0	18.79	18.64	18.73	19.59	19.44	19.53
3.0	QPSK	RB1#0	20.93	21.19	21.16	21.73	21.99	21.96
		RB1#8	20.79	20.80	20.73	21.59	21.60	21.53
		RB1#14	20.97	21.19	21.26	21.77	21.99	22.06
		RB6#0	19.93	19.97	19.89	20.73	20.77	20.69
		RB6#9	19.97	20.09	20.12	20.77	20.89	20.92
		RB15#0	19.90	19.71	19.74	20.70	20.51	20.54
	16QAM	RB1#0	20.25	20.35	20.22	21.05	21.15	21.02
		RB1#8	20.14	20.29	20.53	20.94	21.09	21.33
		RB1#14	20.30	20.17	20.31	21.10	20.97	21.11
		RB6#0	18.77	18.77	18.96	19.57	19.57	19.76
		RB6#9	19.09	19.17	18.90	19.89	19.97	19.70
		RB15#0	18.81	18.55	18.52	19.61	19.35	19.32

Bandwidth (MHz)	Modulation	RB size/ RB Offset	Conducted Average Output Power (dBm)			EIRP(dBm)		
			Low	Mid	High	Low	Mid	High
5.0	QP SK	RB1#0	20.18	20.19	20.24	20.98	20.99	21.04
		RB1#13	20.13	19.90	19.95	20.93	20.70	20.75
		RB1#24	20.18	20.32	20.11	20.98	21.12	20.91
		RB15#0	19.17	19.23	19.20	19.97	20.03	20.00
		RB15#10	19.22	19.22	19.13	20.02	20.02	19.93
		RB25#0	19.21	19.18	18.98	20.01	19.98	19.78
	16QAM	RB1#0	19.30	19.39	19.50	20.10	20.19	20.30
		RB1#13	19.13	19.10	19.04	19.93	19.90	19.84
		RB1#24	19.18	19.14	19.31	19.98	19.94	20.11
		RB15#0	19.01	18.99	18.93	19.81	19.79	19.73
		RB15#10	19.00	19.02	18.88	19.80	19.82	19.68
		RB25#0	18.79	18.64	18.73	19.59	19.44	19.53
10.0	QPSK	RB1#0	20.93	21.19	21.16	21.73	21.99	21.96
		RB1#25	20.79	20.80	20.73	21.59	21.60	21.53
		RB1#49	20.97	21.19	21.26	21.77	21.99	22.06
		RB25#0	19.93	19.97	19.89	20.73	20.77	20.69
		RB25#25	19.97	20.09	20.12	20.77	20.89	20.92
		RB50#0	19.90	19.71	19.74	20.70	20.51	20.54
	16QAM	RB1#0	20.25	20.35	20.22	21.05	21.15	21.02
		RB1#25	20.14	20.29	20.53	20.94	21.09	21.33
		RB1#49	20.30	20.17	20.31	21.10	20.97	21.11
		RB25#0	18.77	18.77	18.96	19.57	19.57	19.76
		RB25#25	19.09	19.17	18.90	19.89	19.97	19.70
		RB50#0	18.81	18.55	18.52	19.61	19.35	19.32

Bandwidth (MHz)	Modulation	RB size/ RB Offset	Conducted Average Output Power (dBm)			EIRP(dBm)		
			Low	Mid	High	Low	Mid	High
15.0	QPSK	RB1#0	20.63	20.74	20.76	21.43	21.54	21.56
		RB1#38	20.66	20.70	20.62	21.46	21.50	21.42
		RB1#74	21.00	21.14	21.14	21.80	21.94	21.94
		RB36#0	19.80	19.62	19.46	20.60	20.42	20.26
		RB36#39	19.75	19.61	19.61	20.55	20.41	20.41
		RB75#0	20.17	20.34	20.35	20.97	21.14	21.15
	16QAM	RB1#0	19.87	19.94	19.95	20.67	20.74	20.75
		RB1#38	19.99	19.98	20.19	20.79	20.78	20.99
		RB1#74	20.03	20.00	20.02	20.83	20.80	20.82
		RB36#0	19.08	19.08	19.26	19.88	19.88	20.06
		RB36#39	19.15	19.16	19.24	19.95	19.96	20.04
		RB75#0	19.14	19.29	19.33	19.94	20.09	20.13
20.0	QPSK	RB1#0	21.05	21.04	20.95	21.85	21.84	21.75
		RB1#50	21.21	21.29	21.26	22.01	22.09	22.06
		RB1#99	20.96	21.11	20.89	21.76	21.91	21.69
		RB50#0	19.97	19.98	19.76	20.77	20.78	20.56
		RB50#50	19.82	19.60	19.85	20.62	20.40	20.65
		RB100#0	19.83	19.73	19.62	20.63	20.53	20.42
	16QAM	RB1#0	19.78	19.91	19.94	20.58	20.71	20.74
		RB1#50	19.84	19.81	20.02	20.64	20.61	20.82
		RB1#99	20.01	20.10	20.13	20.81	20.90	20.93
		RB50#0	19.01	18.81	18.81	19.81	19.61	19.61
		RB50#50	18.96	18.94	18.96	19.76	19.74	19.76
		RB100#0	18.95	19.12	19.16	19.75	19.92	19.96

Note: EIRP(dBm) = Conducted Power(dBm) + Antenna Gain(dBi)
 For Band 25: Antenna Gain =0.8dBi (provided by the applicant)
 Limit: EIRP ≤ 33dBm

LTE Band 26:

Bandwidth (MHz)	Modulation	RB size/ RB Offset	Conducted Average Output Power (dBm)			ERP(dBm)		
			Low	Mid	High	Low	Mid	High
1.4	QP SK	RB1#0	22.92	22.93	22.98	21.27	21.28	21.33
		RB1#3	22.87	22.64	22.69	21.22	20.99	21.04
		RB1#5	22.92	23.06	22.85	21.27	21.41	21.20
		RB3#0	21.91	21.97	21.94	20.26	20.32	20.29
		RB3#3	21.96	21.96	21.87	20.31	20.31	20.22
		RB6#0	21.95	21.92	21.72	20.30	20.27	20.07
	16QAM	RB1#0	22.04	22.13	22.24	20.39	20.48	20.59
		RB1#3	21.87	21.84	21.78	20.22	20.19	20.13
		RB1#5	21.92	21.88	22.05	20.27	20.23	20.40
		RB3#0	21.75	21.73	21.67	20.10	20.08	20.02
		RB3#3	21.74	21.76	21.62	20.09	20.11	19.97
		RB6#0	21.53	21.38	21.47	19.88	19.73	19.82
3.0	QPSK	RB1#0	23.67	23.93	23.90	22.02	22.28	22.25
		RB1#8	23.53	23.54	23.47	21.88	21.89	21.82
		RB1#14	23.71	23.93	24.00	22.06	22.28	22.35
		RB6#0	22.67	22.71	22.63	21.02	21.06	20.98
		RB6#9	22.71	22.83	22.86	21.06	21.18	21.21
		RB15#0	22.64	22.45	22.48	20.99	20.80	20.83
	16QAM	RB1#0	22.99	23.09	22.96	21.34	21.44	21.31
		RB1#8	22.88	23.03	23.27	21.23	21.38	21.62
		RB1#14	23.04	22.91	23.05	21.39	21.26	21.40
		RB6#0	21.51	21.51	21.70	19.86	19.86	20.05
		RB6#9	21.83	21.91	21.64	20.18	20.26	19.99
		RB15#0	21.55	21.29	21.26	19.90	19.64	19.61

Bandwidth (MHz)	Modulation	RB size/ RB Offset	Conducted Average Output Power (dBm)			ERP(dBm)		
			Low	Mid	High	Low	Mid	High
5.0	QP SK	RB1#0	22.62	22.63	22.68	20.97	20.98	21.03
		RB1#13	22.57	22.34	22.39	20.92	20.69	20.74
		RB1#24	22.62	22.76	22.55	20.97	21.11	20.90
		RB15#0	21.61	21.67	21.64	19.96	20.02	19.99
		RB15#10	21.66	21.66	21.57	20.01	20.01	19.92
		RB25#0	21.65	21.62	21.42	20.00	19.97	19.77
	16QAM	RB1#0	21.74	21.83	21.94	20.09	20.18	20.29
		RB1#13	21.57	21.54	21.48	19.92	19.89	19.83
		RB1#24	21.62	21.58	21.75	19.97	19.93	20.10
		RB15#0	21.45	21.43	21.37	19.80	19.78	19.72
		RB15#10	21.44	21.46	21.32	19.79	19.81	19.67
		RB25#0	21.23	21.08	21.17	19.58	19.43	19.52
10.0	QPSK	RB1#0	23.37	23.63	23.60	21.72	21.98	21.95
		RB1#25	23.23	23.24	23.17	21.58	21.59	21.52
		RB1#49	23.41	23.63	23.70	21.76	21.98	22.05
		RB25#0	22.37	22.41	22.33	20.72	20.76	20.68
		RB25#25	22.41	22.53	22.56	20.76	20.88	20.91
		RB50#0	22.34	22.15	22.18	20.69	20.50	20.53
	16QAM	RB1#0	22.69	22.79	22.66	21.04	21.14	21.01
		RB1#25	22.58	22.73	22.97	20.93	21.08	21.32
		RB1#49	22.74	22.61	22.75	21.09	20.96	21.10
		RB25#0	21.21	21.21	21.40	19.56	19.56	19.75
		RB25#25	21.53	21.61	21.34	19.88	19.96	19.69
		RB50#0	21.25	20.99	20.96	19.60	19.34	19.31

Bandwidth (MHz)	Modulation	RB size/ RB Offset	Conducted Average Output Power (dBm)			ERP(dBm)		
			Low	Mid	High	Low	Mid	High
15.0	QPSK	RB1#0	23.07	23.18	23.20	21.42	21.53	21.55
		RB1#38	23.10	23.14	23.06	21.45	21.49	21.41
		RB1#74	23.44	23.58	23.58	21.79	21.93	21.93
		RB36#0	22.24	22.06	21.90	20.59	20.41	20.25
		RB36#39	22.19	22.05	22.05	20.54	20.40	20.40
		RB75#0	22.61	22.78	22.79	20.96	21.13	21.14
	16QAM	RB1#0	22.31	22.38	22.39	20.66	20.73	20.74
		RB1#38	22.43	22.42	22.63	20.78	20.77	20.98
		RB1#74	22.47	22.44	22.46	20.82	20.79	20.81
		RB36#0	21.52	21.52	21.70	19.87	19.87	20.05
		RB36#39	21.59	21.60	21.68	19.94	19.95	20.03
		RB75#0	21.58	21.73	21.77	19.93	20.08	20.12

Note: ERP(dBm) = Conducted Power(dBm) + Antenna Gain(dBd)
 For Band 26: Antenna Gain = 0.5dBi = -1.65dBd (0dBd=2.15dBi) (provided by the applicant)
 Limit: ERP ≤ 38.45dBm

Peak-to-average ratio (PAR)

**LTE Band 2
20MHz Bandwidth**

Modulation	Low channel (dB)	Middle channel (dB)	High channel (dB)	PAR Limit (dB)	Result
QPSK (1RB Size)	4.49	4.52	4.20	13	Pass
QPSK (100RB Size)	5.54	5.45	5.38	13	Pass
16QAM (1RB Size)	5.54	5.45	4.90	13	Pass
16QAM (100RB Size)	6.41	6.31	6.31	13	Pass

**LTE Band 4
20MHz Bandwidth**

Modulation	Low channel (dB)	Middle channel (dB)	High channel (dB)	PAR Limit (dB)	Result
QPSK (1RB Size)	4.29	4.20	4.42	13	Pass
QPSK (100RB Size)	5.42	5.16	5.38	13	Pass
16QAM (1RB Size)	5.26	5.22	5.38	13	Pass
16QAM (100RB Size)	6.28	5.99	6.31	13	Pass

**LTE Band 5
10MHz Bandwidth**

Modulation	Low channel (dB)	Middle channel (dB)	High channel (dB)	PAR Limit (dB)	Result
QPSK (1RB Size)	4.36	4.39	4.07	13	Pass
QPSK (50RB Size)	5.42	5.03	5.32	13	Pass
16QAM (1RB Size)	5.26	5.35	4.78	13	Pass
16QAM (50RB Size)	6.31	5.99	6.15	13	Pass

LTE Band 7

20MHz Bandwidth

Modulation	Low channel (dB)	Middle channel (dB)	High channel (dB)	PAR Limit (dB)	Result
QPSK (1RB Size)	4.46	4.17	3.72	13	Pass
QPSK (100RB Size)	5.19	5.54	5.45	13	Pass
16QAM (1RB Size)	5.54	5.19	4.78	13	Pass
16QAM (100RB Size)	6.15	6.47	6.38	13	Pass

LTE Band 12

10MHz Bandwidth

Modulation	Low channel (dB)	Middle channel (dB)	High channel (dB)	PAR Limit (dB)	Result
QPSK (1RB Size)	4.84	4.39	4.65	13	Pass
QPSK (50RB Size)	5.38	5.67	5.45	13	Pass
16QAM (1RB Size)	5.77	5.45	5.61	13	Pass
16QAM (50RB Size)	6.28	6.60	6.38	13	Pass

LTE Band 13

10MHz Bandwidth

Modulation	Low channel (dB)	Middle channel (dB)	High channel (dB)	PAR Limit (dB)	Result
QPSK (1RB Size)	/	3.94	/	13	Pass
QPSK (50RB Size)	/	5.22	/	13	Pass
16QAM (1RB Size)	/	5.22	/	13	Pass
16QAM (50RB Size)	/	6.09	/	13	Pass

LTE Band 25
20MHz Bandwidth

Modulation	Low channel (dB)	Middle channel (dB)	High channel (dB)	PAR Limit (dB)	Result
QPSK (1RB Size)	4.62	4.81	4.65	13	Pass
QPSK (100RB Size)	5.54	5.64	5.38	13	Pass
16QAM (1RB Size)	5.71	5.90	5.71	13	Pass
16QAM (100RB Size)	6.60	6.57	6.41	13	Pass

LTE Band 26
15MHz Bandwidth

Modulation	Low channel (dB)	Middle channel (dB)	High channel (dB)	PAR Limit (dB)	Result
QPSK (1RB Size)	4.10	4.20	3.91	13	Pass
QPSK (75RB Size)	4.94	5.22	5.32	13	Pass
16QAM (1RB Size)	5.00	5.10	4.71	13	Pass
16QAM (75RB Size)	5.77	6.12	6.12	13	Pass

FCC §2.1049, §22.917, §22.905 & §24.238 & §27.53, §90.209- OCCUPIED BANDWIDTH

Applicable Standard

FCC 47 §2.1049, §22.917, §22.905, §24.238, §27.53 and §90.209.

Test Procedure

The RF output of the transmitter was connected to the simulator and the spectrum analyzer through sufficient attenuation.

The resolution bandwidth of the spectrum analyzer was set at 1% to 5% of the anticipated emission bandwidth and the 26 dB & 99% bandwidth was recorded.

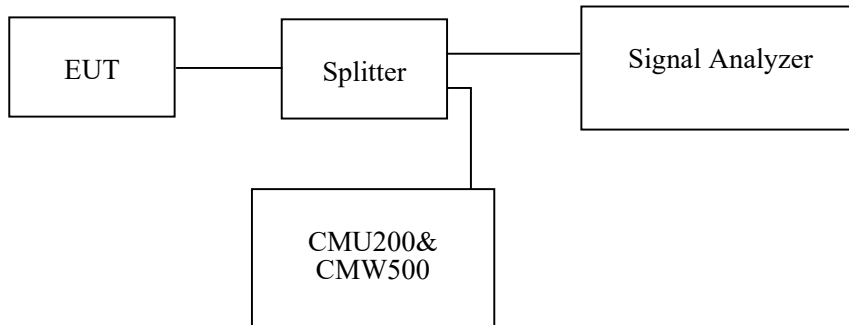

Test Data

Environmental Conditions

Temperature:	27.8~29.1 °C
Relative Humidity:	49~57 %
ATM Pressure:	100.9~101.2 kPa

The testing was performed by Pedro Yun from 2021-05-31 to 2021-07-18.

EUT operation mode: Transmitting

Test Result: Pass

Please refer to the following tables and plots.

Cellular Band (Part 22H)

Mode	Frequency (MHz)	99% Occupied Bandwidth (kHz)	26 dB Emission Bandwidth (kHz)
GPRS	824.2	245.19	317.31
	836.6	240.38	306.73
	848.8	241.99	319.55

Mode	Frequency (MHz)	99% Occupied Bandwidth (kHz)	26 dB Emission Bandwidth (kHz)
EGPRS	824.2	245.19	315.06
	836.6	246.79	309.94
	848.8	246.79	307.05

	Frequency (MHz)	Occupied Bandwidth (MHz)	26dB Bandwidth (MHz)
RMC	826.4	4.17	4.74
	836.6	4.13	4.72
	846.6	4.12	4.73
HSDPA	826.4	4.18	4.80
	836.6	4.15	4.75
	846.6	4.12	4.72
HSUPA	826.4	4.18	4.84
	836.6	4.15	4.71
	846.6	4.13	4.71

PCS Band (Part 24E)

Mode	Frequency (MHz)	99% Occupied Bandwidth (kHz)	26 dB Emission Bandwidth (kHz)
GPRS	1850.2	246.79	318.91
	1880.0	248.40	312.50
	1909.8	243.59	316.35

Mode	Frequency (MHz)	99% Occupied Bandwidth (kHz)	26 dB Emission Bandwidth (kHz)
EGPRS	1850.2	251.60	316.67
	1880.0	248.40	310.90
	1909.8	246.79	315.06

	Frequency (MHz)	Occupied Bandwidth (MHz)	26dB Bandwidth (MHz)
RMC	1852.4	4.15	4.73
	1880.0	4.17	4.71
	1907.6	4.17	4.72
HSDPA	1852.4	4.10	4.76
	1880.0	4.17	4.76
	1907.6	4.10	4.73
HSUPA	1852.4	4.18	4.73
	1880.0	4.18	4.73
	1907.6	4.18	4.74

AWS Band (Part 27)

	Frequency (MHz)	Occupied Bandwidth (MHz)	26dB Bandwidth (MHz)
RMC	1712.4	4.16	4.74
	1732.6	4.16	4.76
	1752.6	4.16	4.76
HSDPA	1712.4	4.18	4.78
	1732.6	4.18	4.79
	1752.6	4.20	4.76
HSUPA	1712.4	4.18	4.87
	1732.6	4.18	4.75
	1752.6	4.20	4.81

Cellular Band (Part 22H)

26 dB Emissions & 99% Occupied Bandwidth for GSM (GMSK) Mode, Low channel

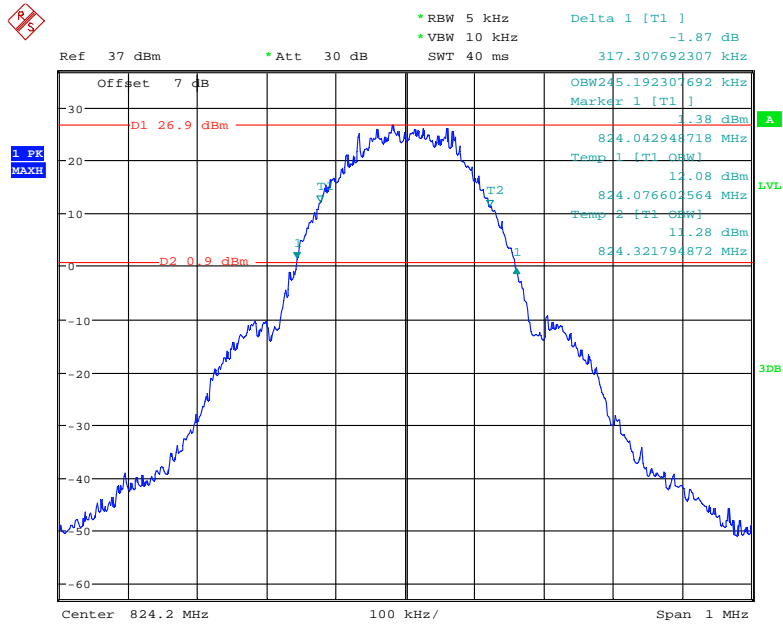

Date: 31.MAY.2021 20:31:50

26 dB Emissions & 99% Occupied Bandwidth for GSM (GMSK) Mode, Middle channel

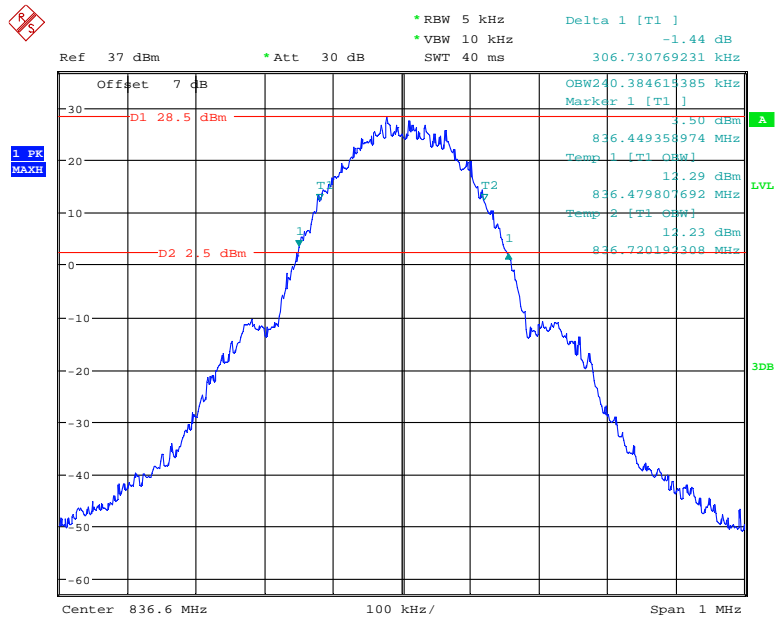

Date: 31.MAY.2021 20:33:53

26 dB Emissions & 99% Occupied Bandwidth for GSM (GMSK) Mode, High channel

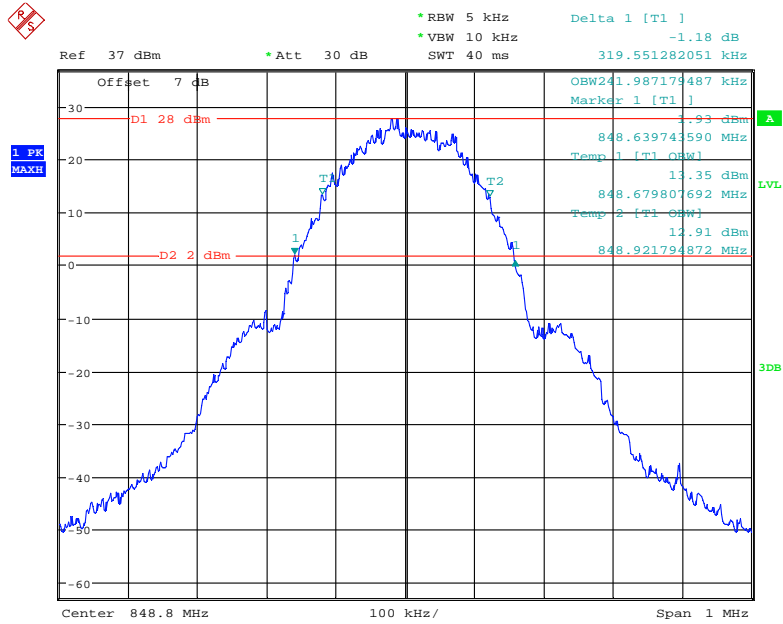

Date: 31.MAY.2021 20:35:18

26 dB Emissions & 99% Occupied Bandwidth for EGPRS (8PSK) Mode, Low channel

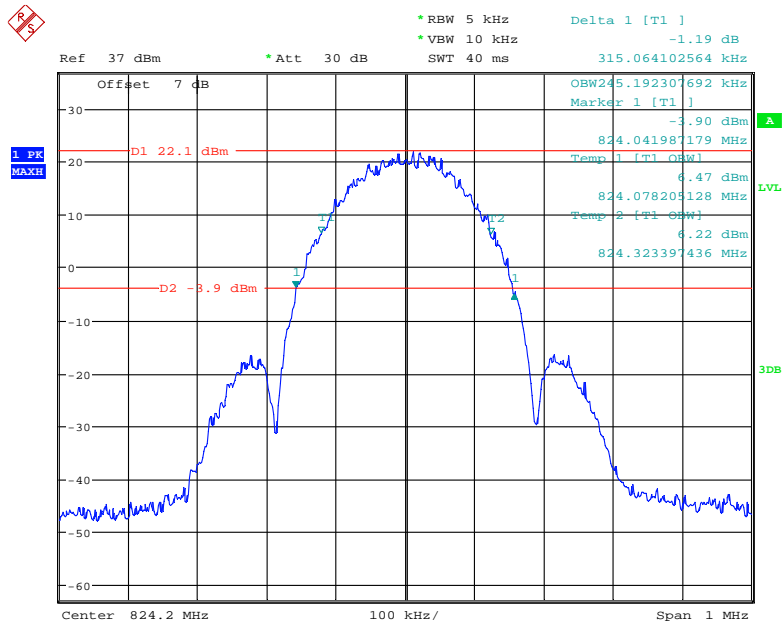

Date: 31.MAY.2021 20:51:09

26 dB Emissions & 99% Occupied Bandwidth for EGPRS (8PSK) Mode, Middle channel

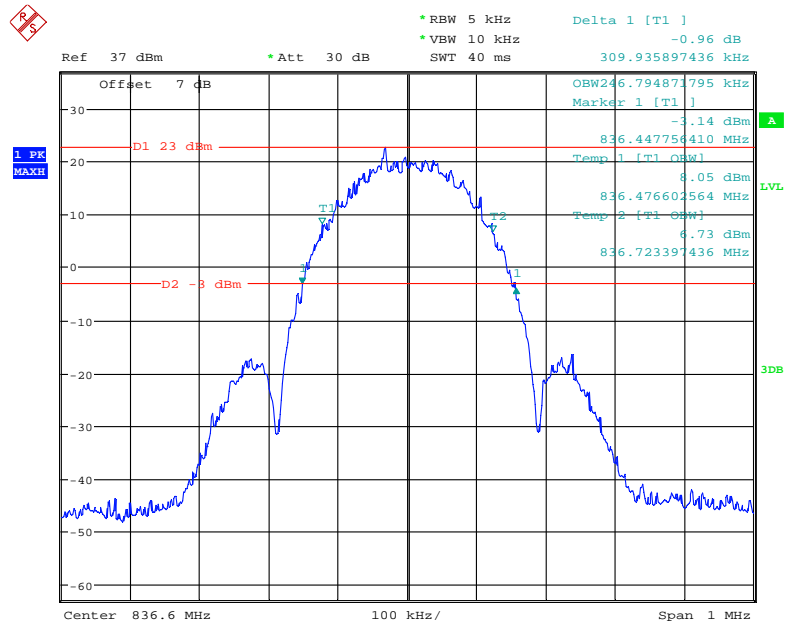

Date: 31.MAY.2021 20:53:35

26 dB Emissions & 99% Occupied Bandwidth for EGPRS (8PSK) Mode, High channel

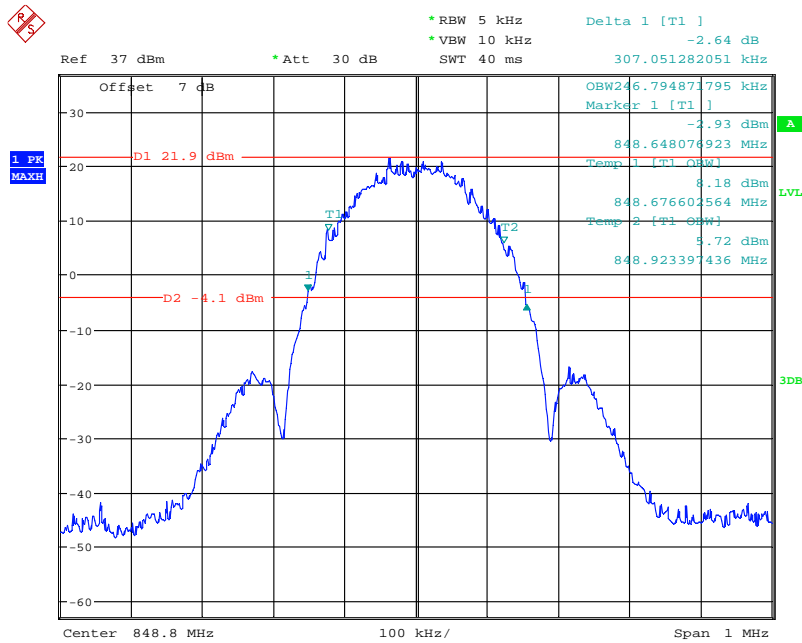

Date: 31.MAY.2021 20:55:15

26 dB Emissions & 99% Occupied Bandwidth for RMC (BPSK) Mode, Low channel

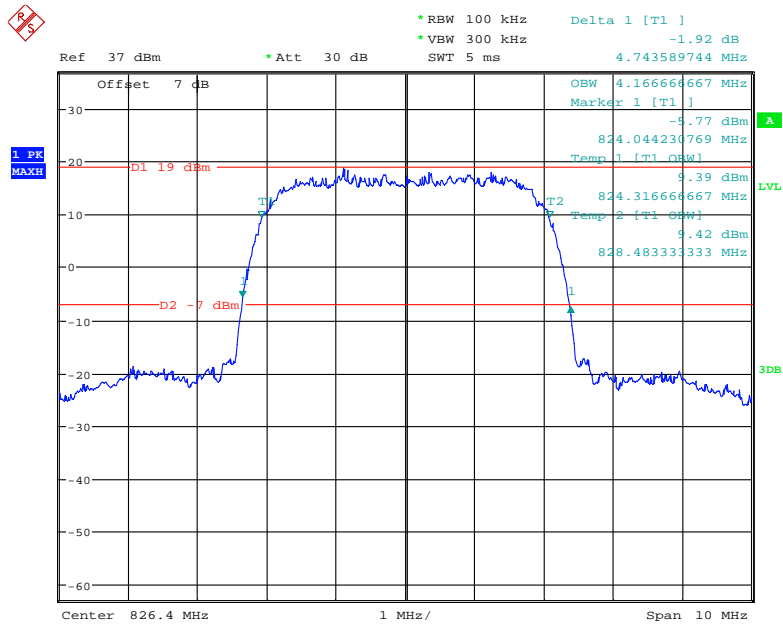

Date: 31.MAY.2021 23:15:22

26 dB Emissions & 99% Occupied Bandwidth for RMC (BPSK) Mode, Middle channel

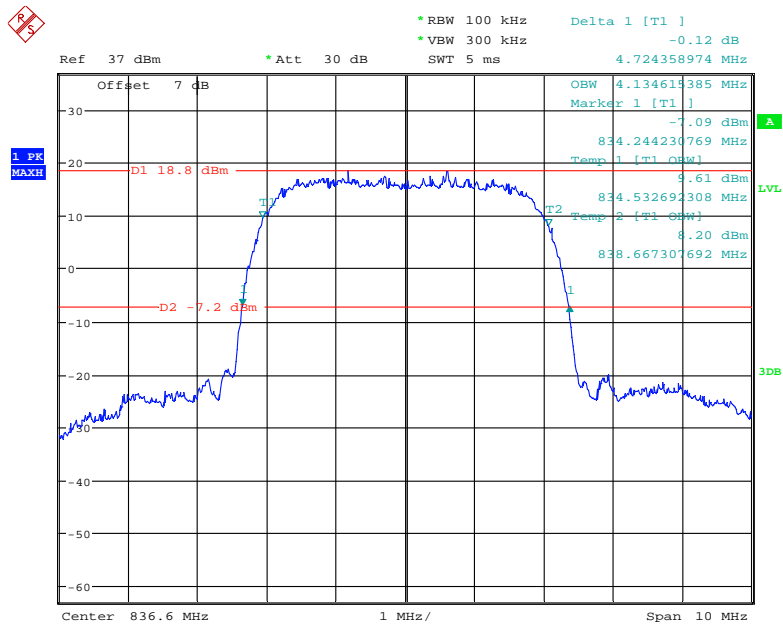

Date: 31.MAY.2021 23:17:27

26 dB Emissions & 99% Occupied Bandwidth for RMC (BPSK) Mode, High channel

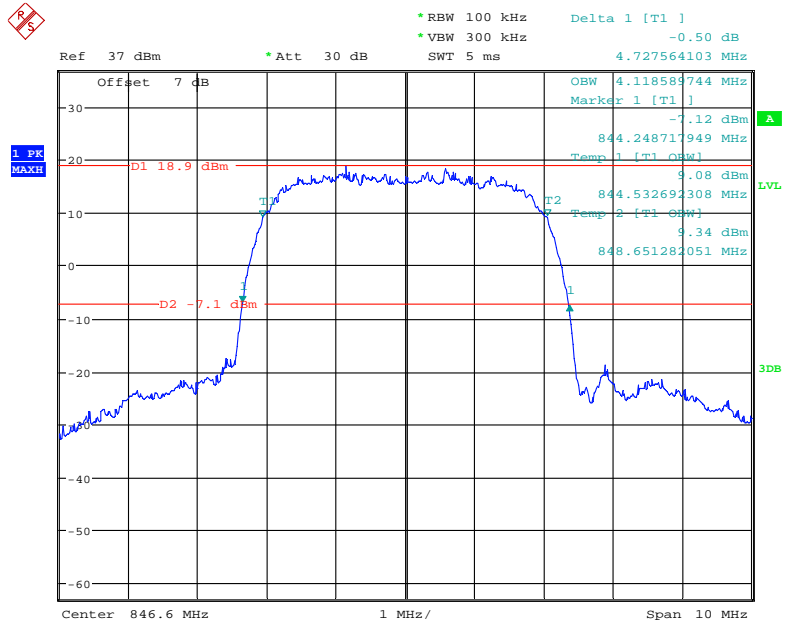

Date: 31.MAY.2021 23:19:29

26 dB Emissions & 99% Occupied Bandwidth for HSUPA (BPSK) Mode, Low channel

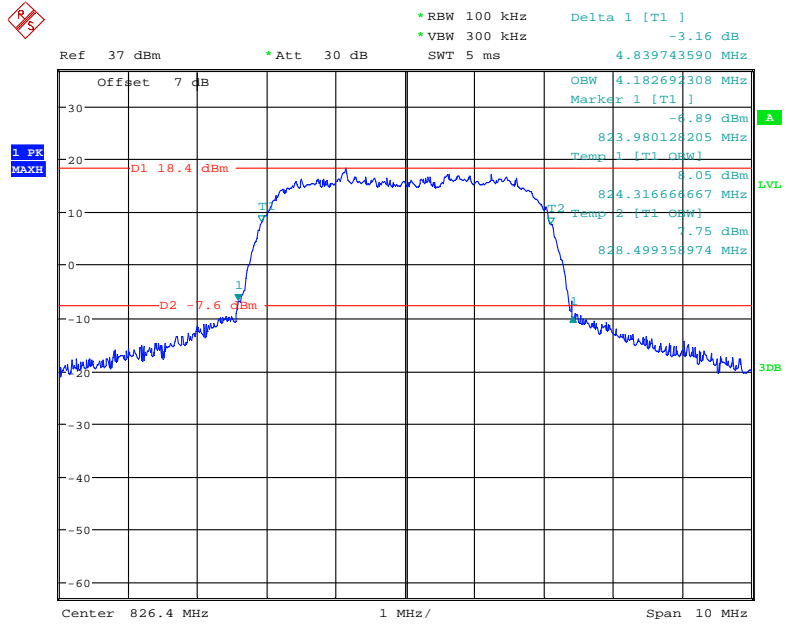

Date: 31.MAY.2021 23:52:46

26 dB Emissions & 99% Occupied Bandwidth for HSUPA (BPSK) Mode, Middle channel

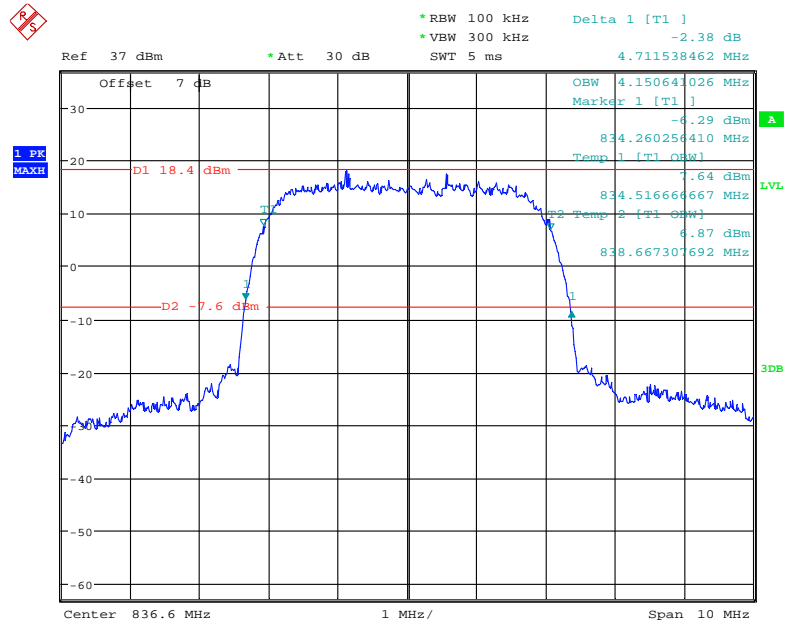

Date: 31.MAY.2021 23:50:00

26 dB Emissions & 99% Occupied Bandwidth for HSUPA (BPSK) Mode, High channel

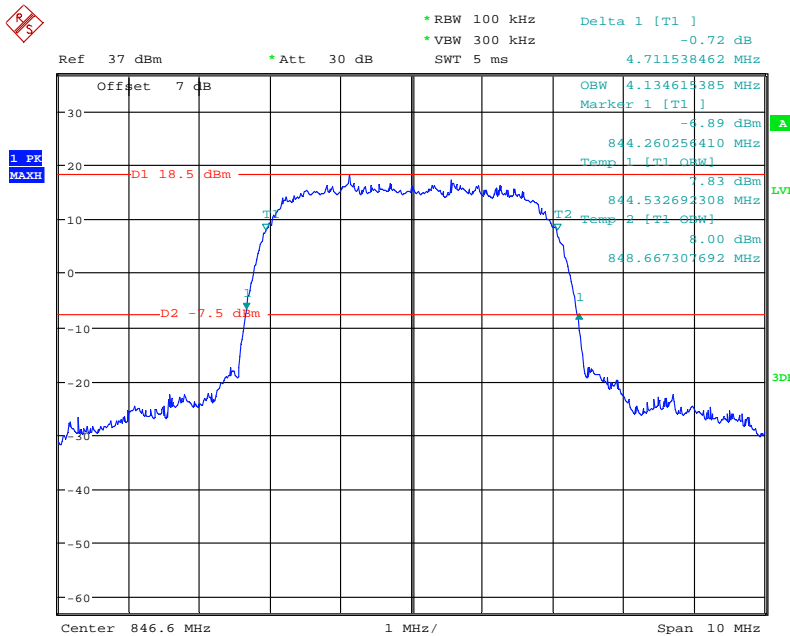

Date: 31.MAY.2021 23:48:23

26 dB Emissions & 99% Occupied Bandwidth for HSDPA (16QAM) Mode, Low channel

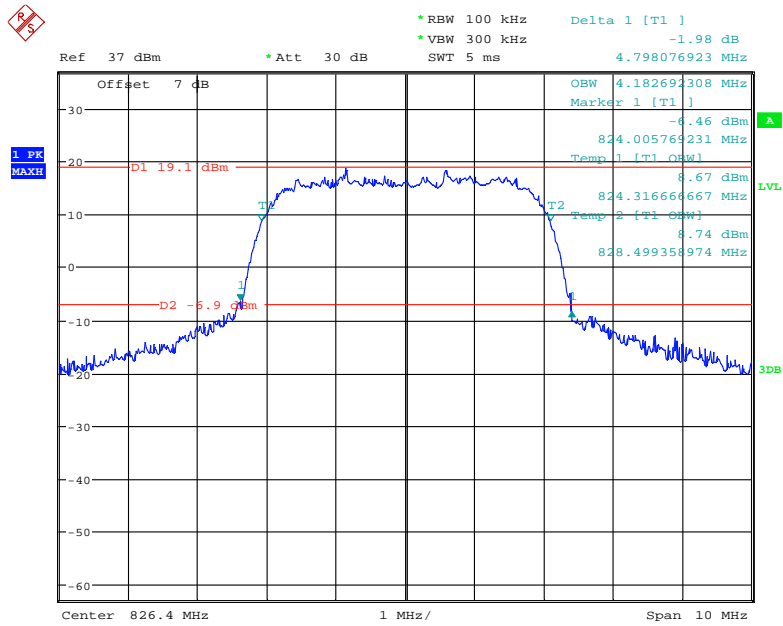

Date: 31.MAY.2021 23:37:10

26 dB Emissions & 99% Occupied Bandwidth for HSDPA (16QAM) Mode, Middle channel

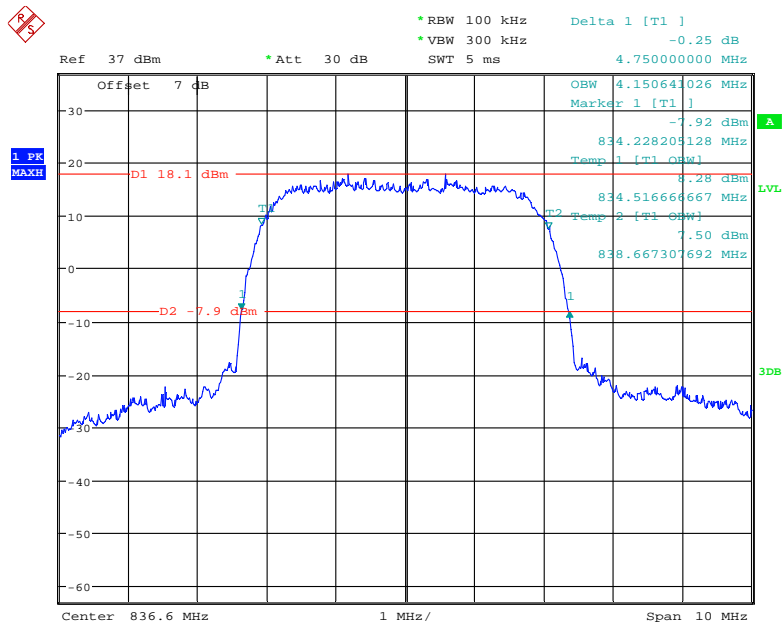

Date: 31.MAY.2021 23:38:53

26 dB Emissions & 99% Occupied Bandwidth for HSDPA (16QAM) Mode, High channel

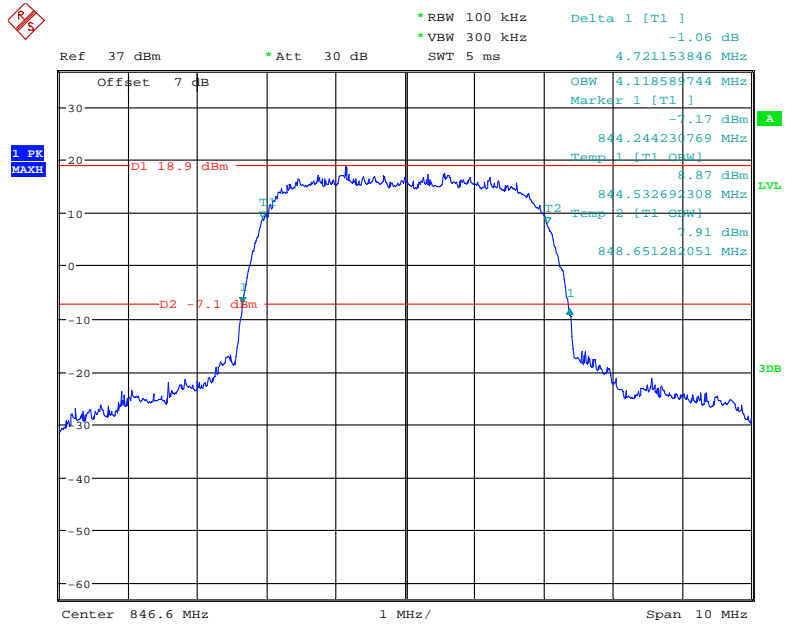

Date: 31.MAY.2021 23:40:24

PCS Band (Part 24E)

26 dB Emissions & 99% Occupied Bandwidth for GSM (GMSK) Mode, Low channel

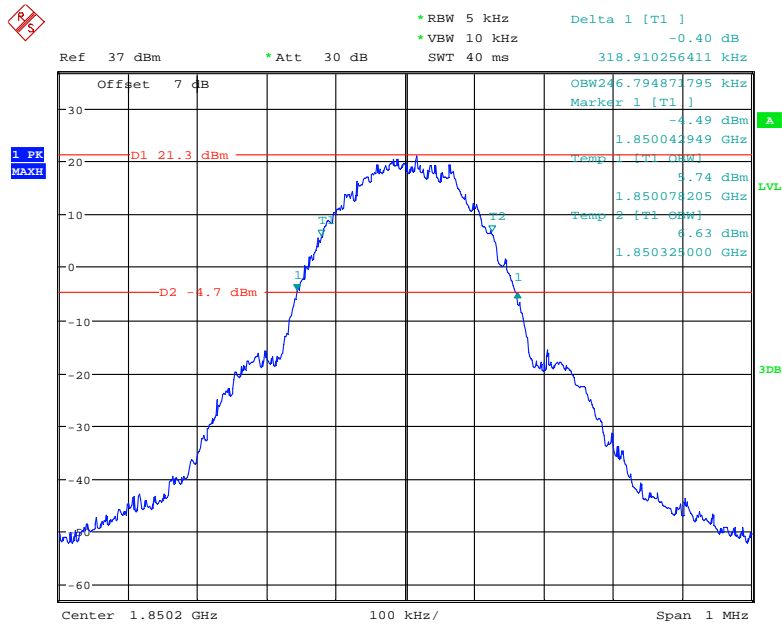

Date: 31.MAY.2021 21:34:05

26 dB Emissions & 99% Occupied Bandwidth for GSM (GMSK) Mode, Middle channel

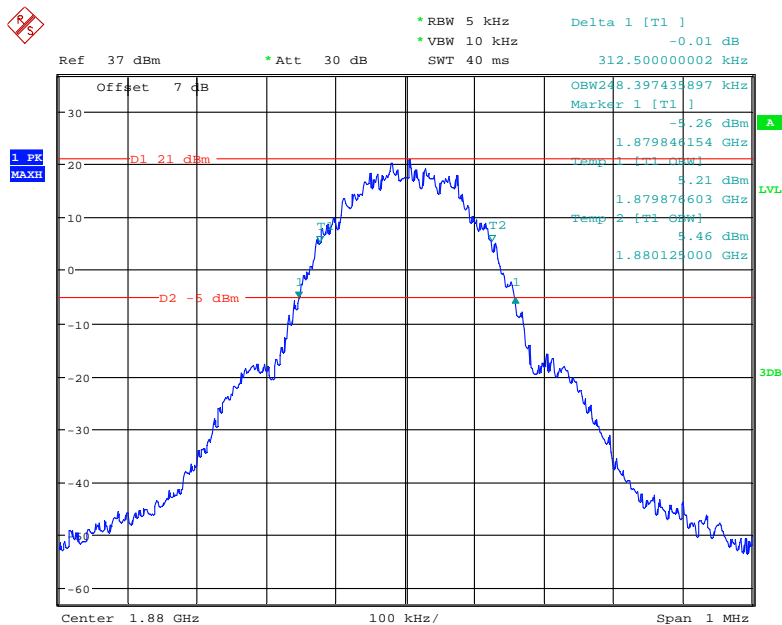

Date: 31.MAY.2021 21:35:18

26 dB Emissions & 99% Occupied Bandwidth for GSM (GMSK) Mode, High channel

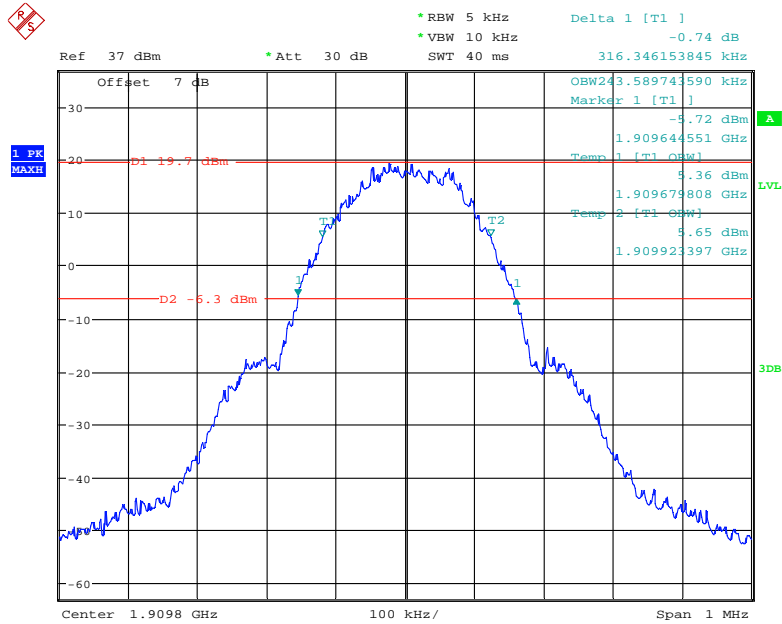

Date: 31.MAY.2021 21:37:54

26 dB Emissions & 99% Occupied Bandwidth for EGPRS (8PSK) Mode, Low channel

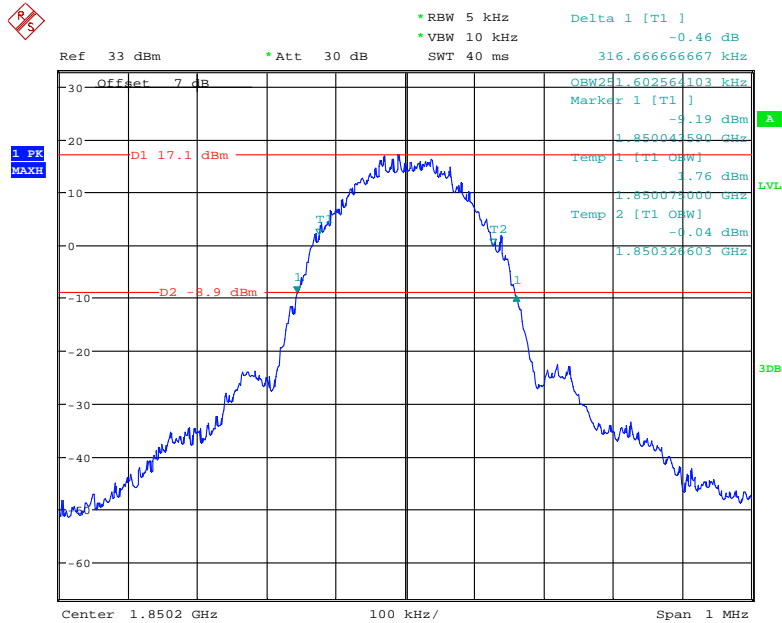

Date: 31.MAY.2021 21:48:33

26 dB Emissions & 99% Occupied Bandwidth for EGPRS (8PSK) Mode, Middle channel

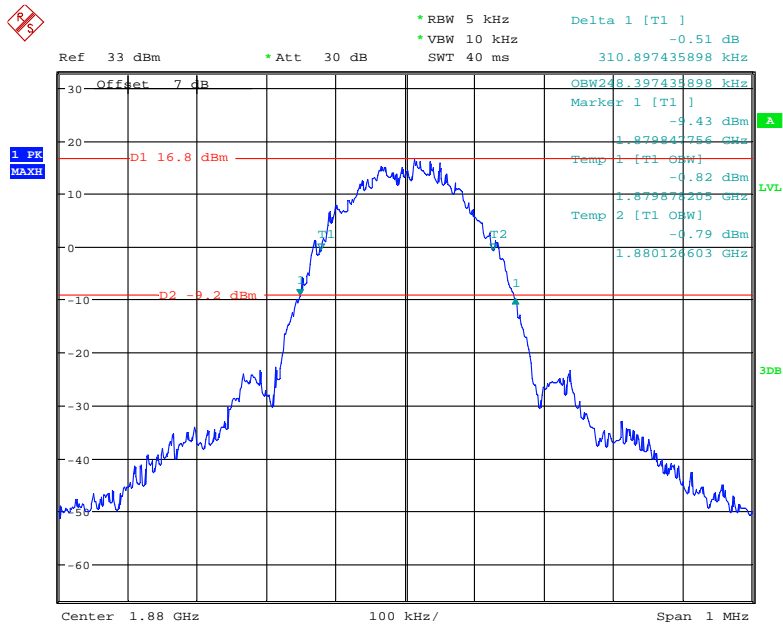

Date: 31.MAY.2021 21:49:35

26 dB Emissions & 99% Occupied Bandwidth for EGPRS (8PSK) Mode, High channel

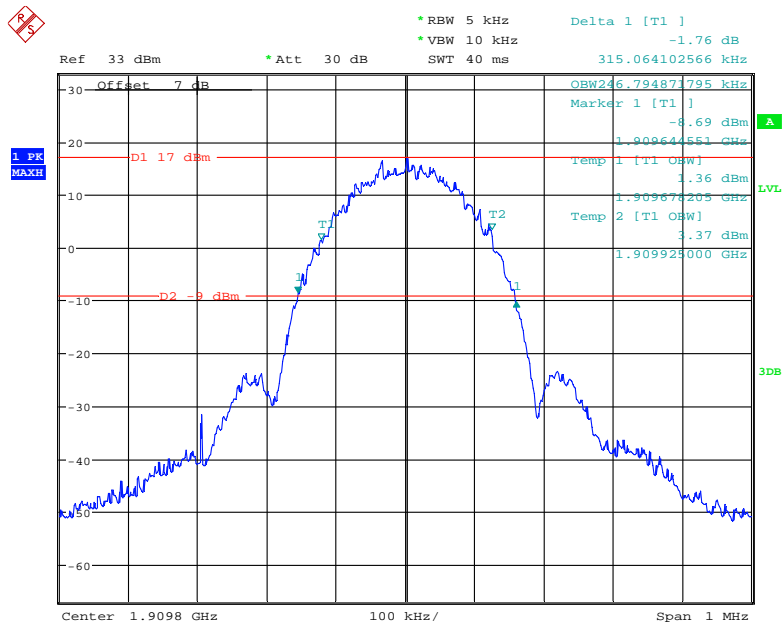

Date: 31.MAY.2021 21:52:23

26 dB Emissions & 99% Occupied Bandwidth for RMC (BPSK) Mode, Low channel

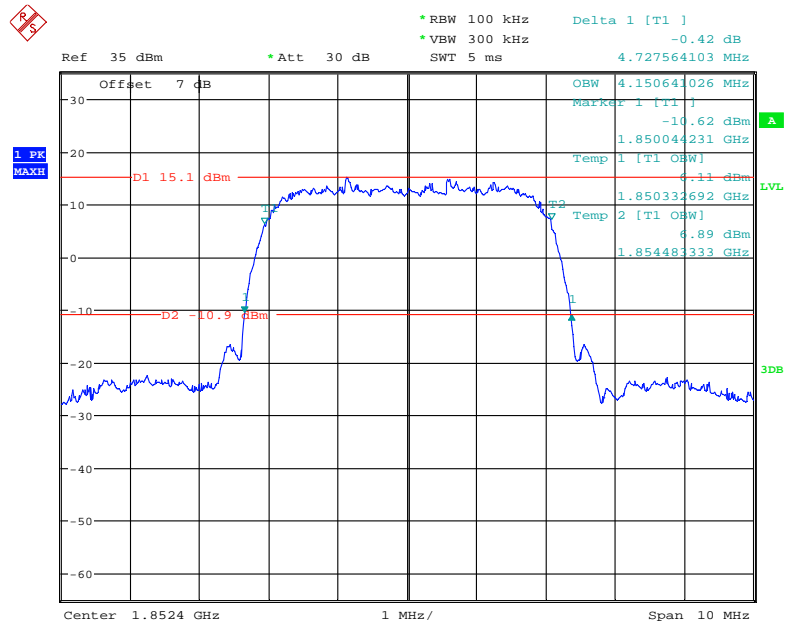

Date: 31.MAY.2021 22:54:13

26 dB Emissions & 99% Occupied Bandwidth for RMC (BPSK) Mode, Middle channel

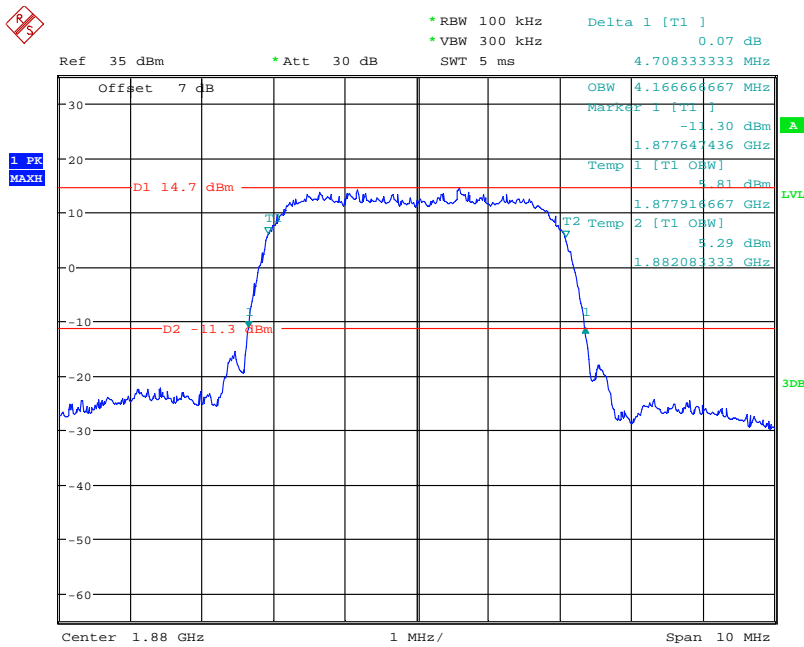

Date: 31.MAY.2021 22:55:49

26 dB Emissions & 99% Occupied Bandwidth for RMC (BPSK) Mode, High channel

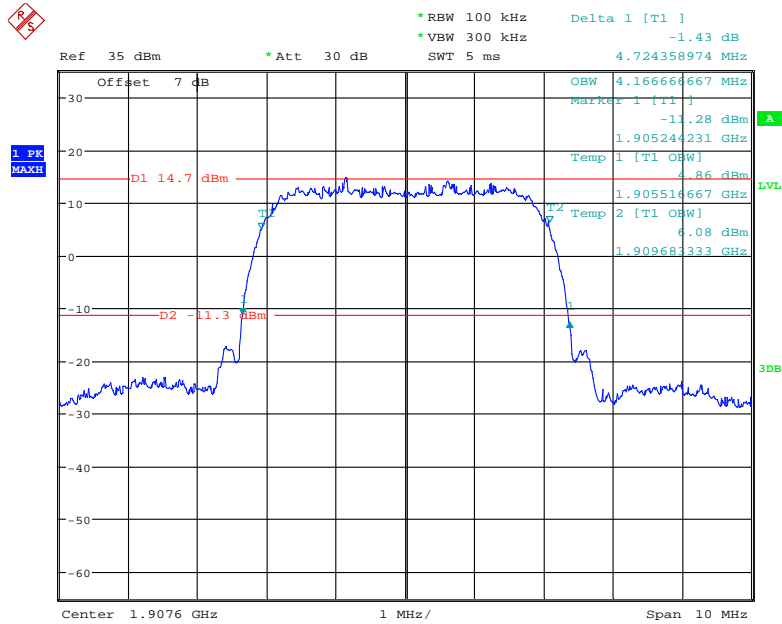

Date: 31.MAY.2021 22:57:46

26 dB Emissions & 99% Occupied Bandwidth for HSUPA (BPSK) Mode, Low channel

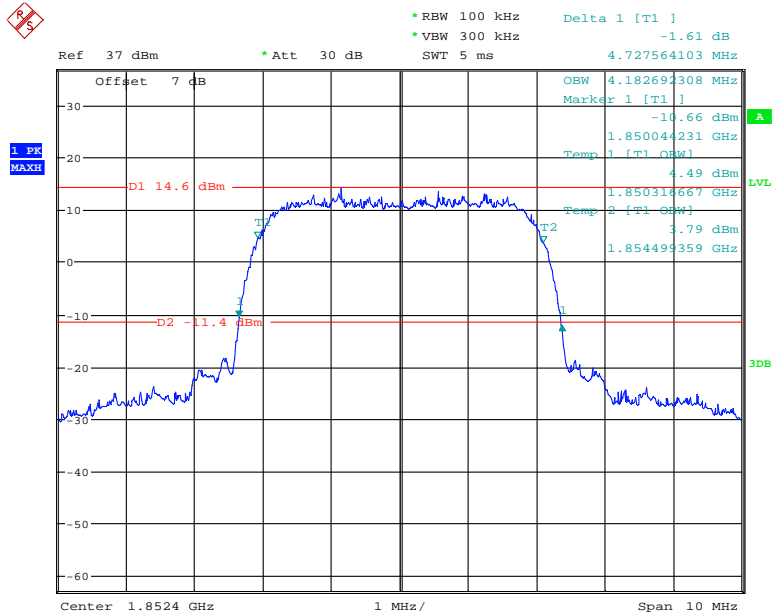

Date: 31.MAY.2021 23:54:13

26 dB Emissions & 99% Occupied Bandwidth for HSUPA (BPSK) Mode, Middle channel

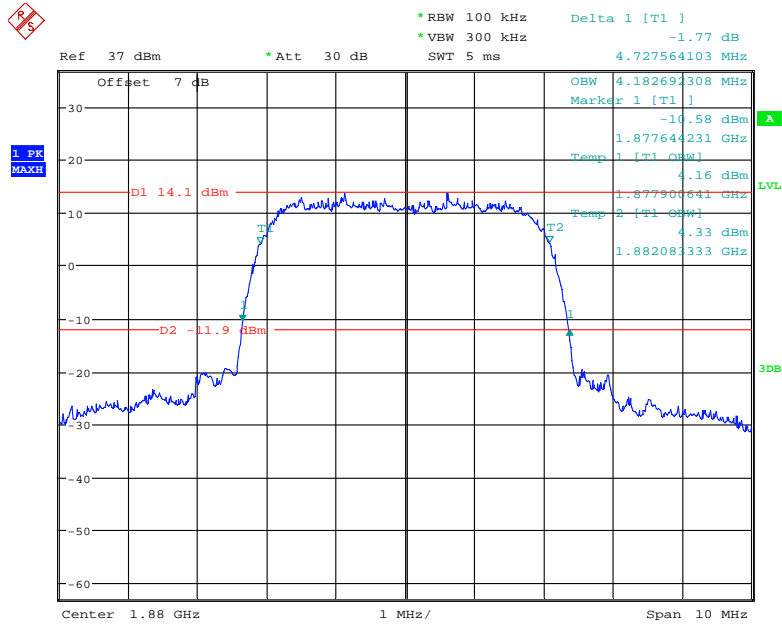

Date: 31.MAY.2021 23:55:33

26 dB Emissions & 99% Occupied Bandwidth for HSUPA (BPSK) Mode, High channel

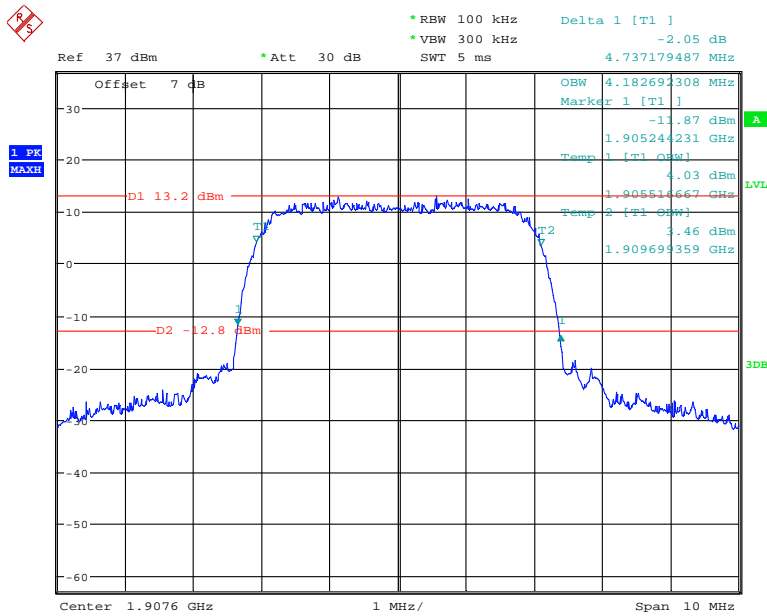

Date: 31.MAY.2021 23:57:01

26 dB Emissions & 99% Occupied Bandwidth for HSDPA (16QAM) Mode, Low channel

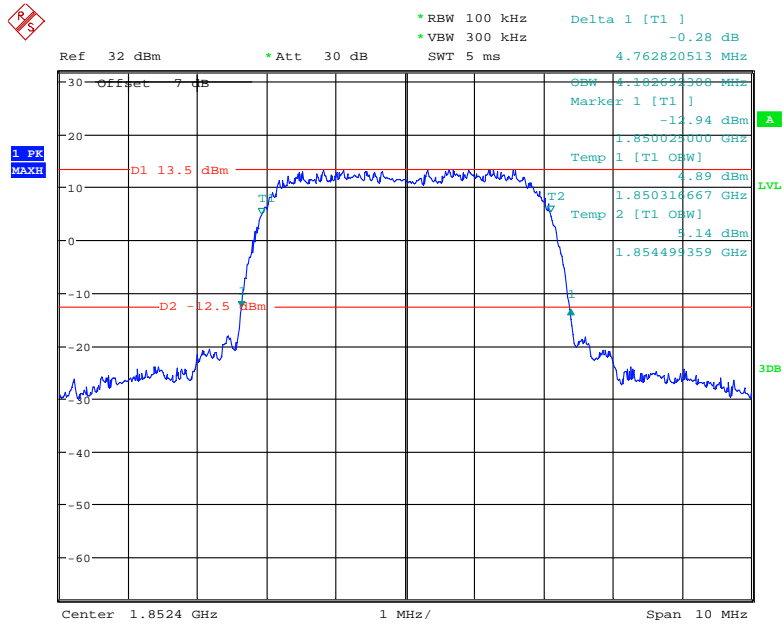

Date: 31.MAY.2021 23:33:57

26 dB Emissions & 99% Occupied Bandwidth for HSDPA (16QAM) Mode, Middle channel

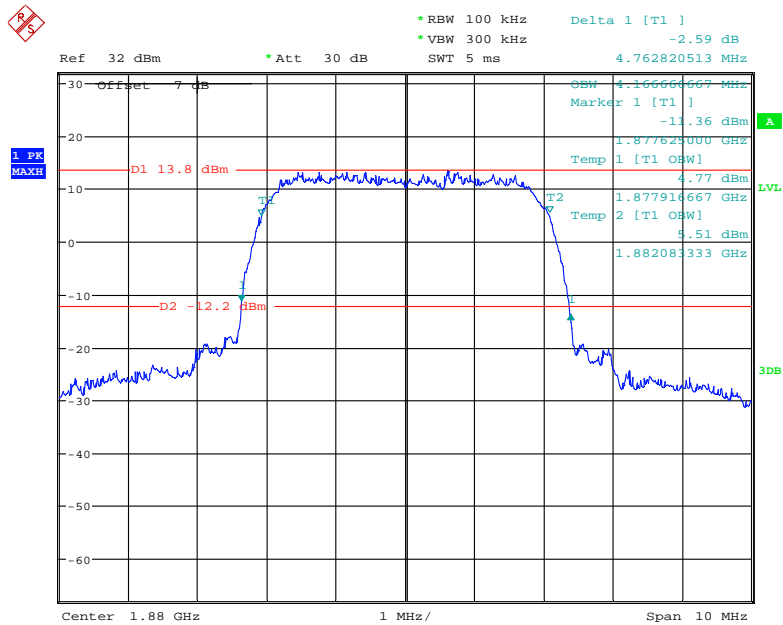

Date: 31.MAY.2021 23:32:19

26 dB Emissions & 99% Occupied Bandwidth for HSDPA (16QAM) Mode, High channel

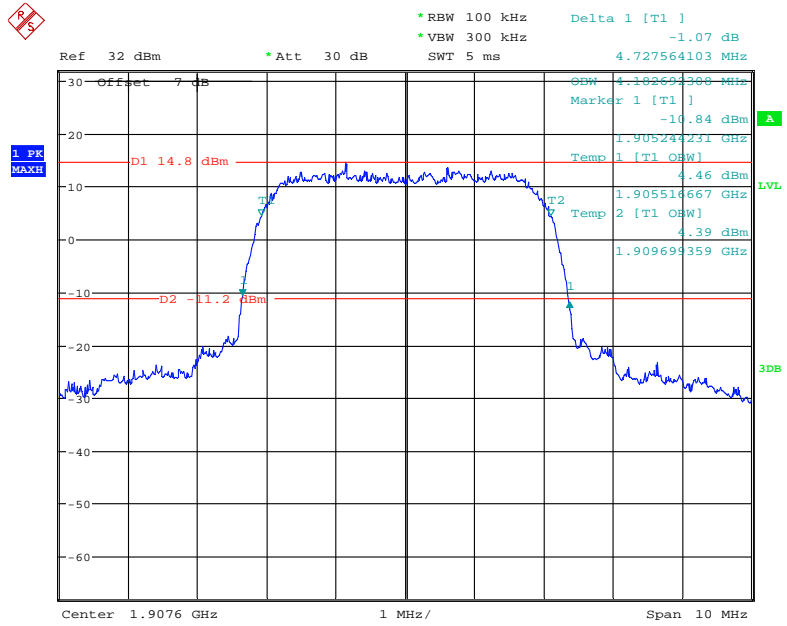

Date: 31.MAY.2021 23:30:36

AWS Band (Part 27)

26 dB Emissions & 99% Occupied Bandwidth for RMC (BPSK) Mode, Low channel

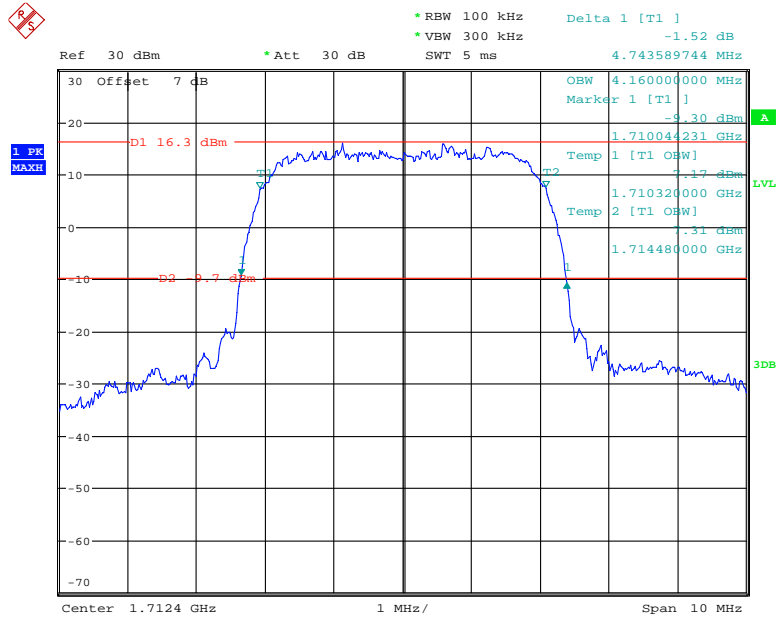

Date: 11.JUL.2021 15:34:51

26 dB Emissions & 99% Occupied Bandwidth for RMC (BPSK) Mode, Middle channel

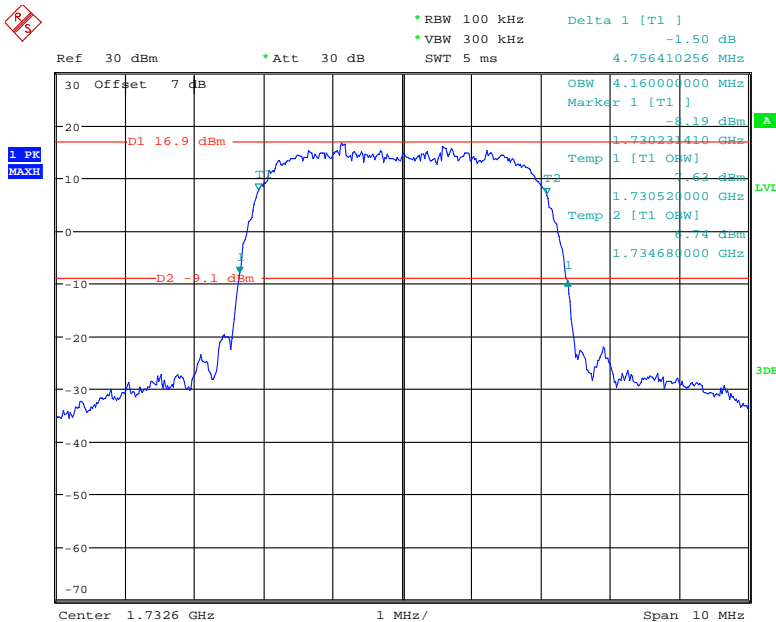

Date: 11.JUL.2021 15:33:38

26 dB Emissions & 99% Occupied Bandwidth for RMC (BPSK) Mode, High channel

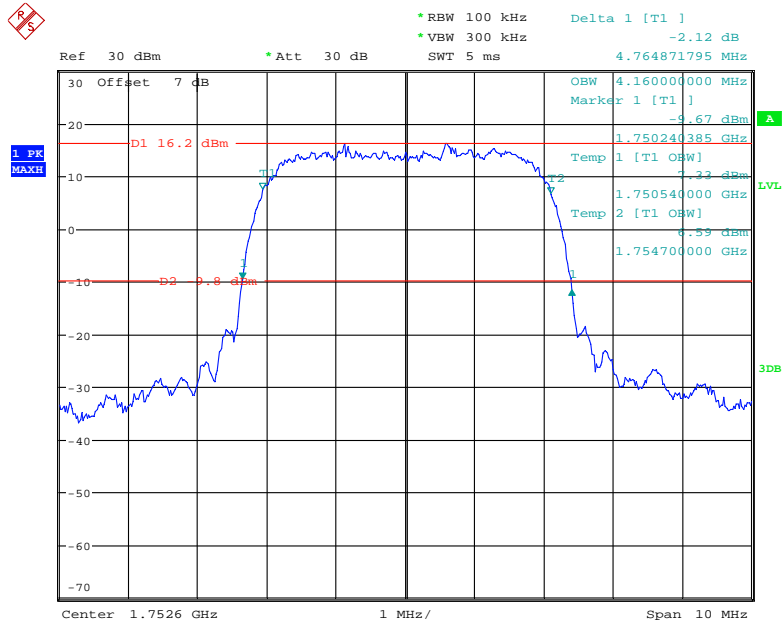

Date: 11.JUL.2021 15:32:17

26 dB Emissions & 99% Occupied Bandwidth for HSUPA (BPSK) Mode, Low channel

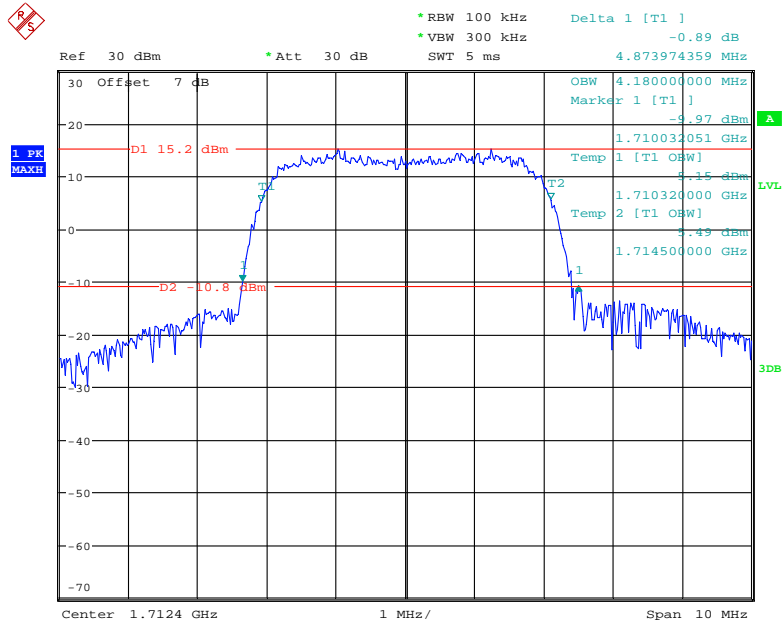

Date: 11.JUL.2021 15:58:15

26 dB Emissions & 99% Occupied Bandwidth for HSUPA (BPSK) Mode, Middle channel

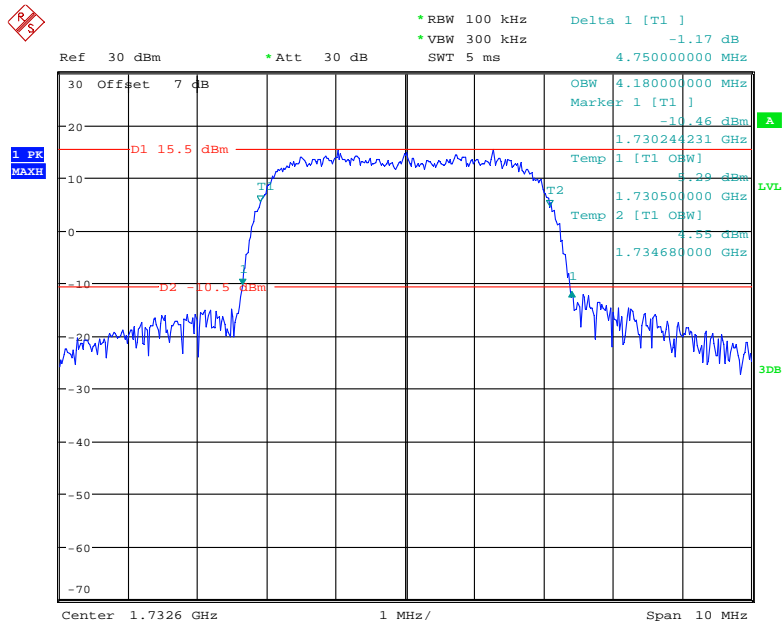

Date: 11.JUL.2021 15:59:23

26 dB Emissions & 99% Occupied Bandwidth for HSUPA (BPSK) Mode, High channel

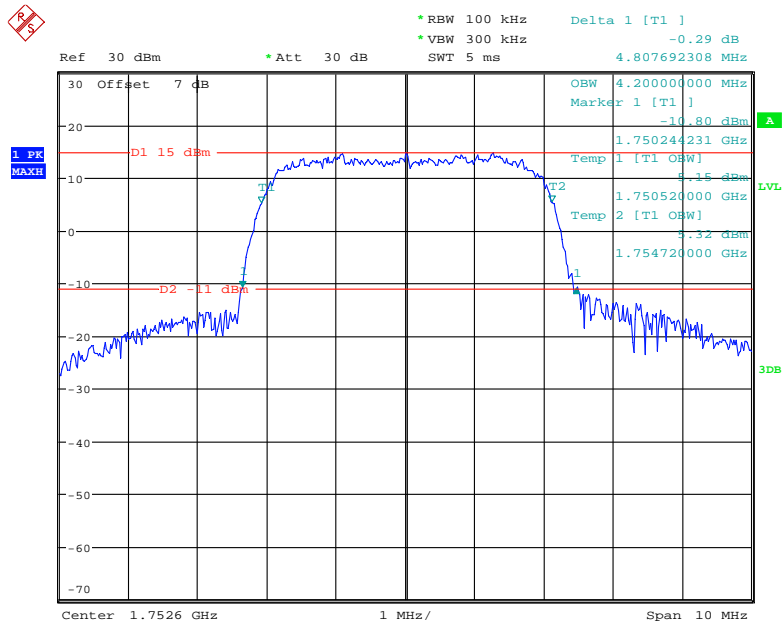

Date: 11.JUL.2021 16:01:13

26 dB Emissions & 99% Occupied Bandwidth for HSDPA (16QAM) Mode, Low channel

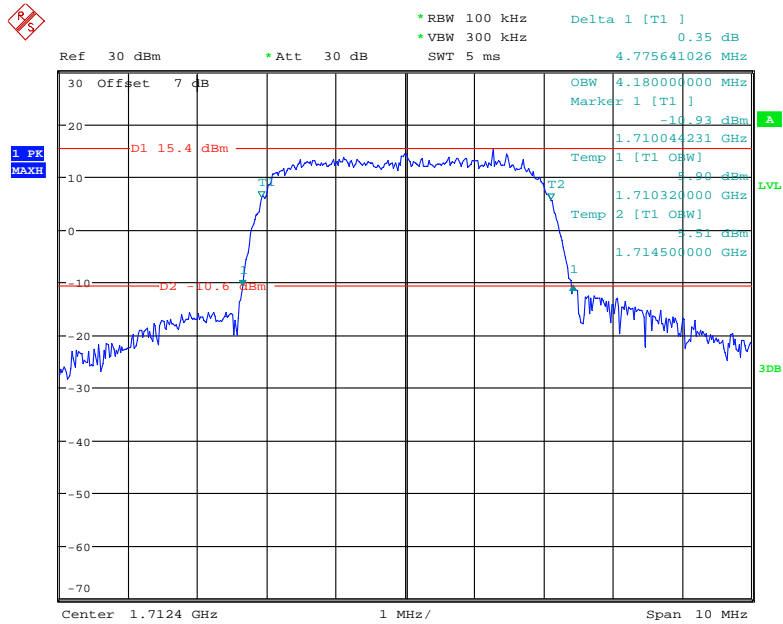

Date: 11.JUL.2021 15:49:37

26 dB Emissions & 99% Occupied Bandwidth for HSDPA (16QAM) Mode, Middle channel

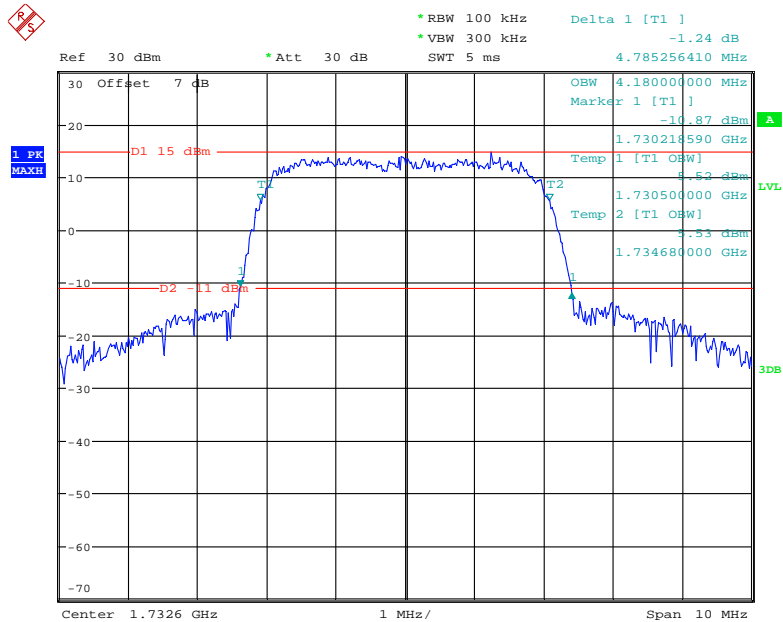

Date: 11.JUL.2021 15:47:53

26 dB Emissions & 99% Occupied Bandwidth for HSDPA (16QAM) Mode, High channel

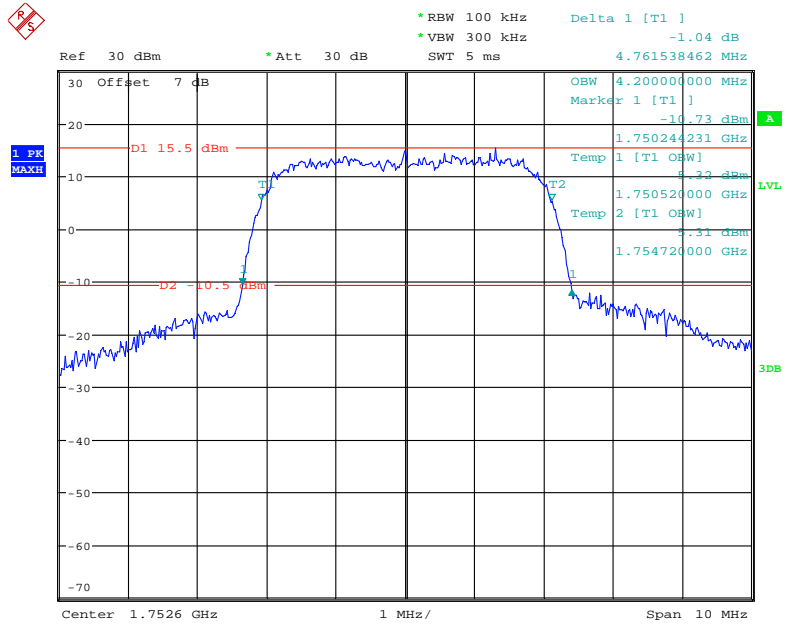

Date: 11.JUL.2021 15:46:20

LTE Band 2:

Bandwidth (MHz)	Modulation	Channel	99% Occupied Bandwidth (MHz)	26 dB Emission Bandwidth (MHz)
1.4	QPSK	Low	1.110	1.320
		Middle	1.110	1.320
		High	1.104	1.320
	16QAM	Low	1.104	1.314
		Middle	1.110	1.326
		High	1.098	1.314
3	QPSK	Low	2.700	2.940
		Middle	2.700	2.952
		High	2.688	2.940
	16QAM	Low	2.688	2.976
		Middle	2.688	2.952
		High	2.688	2.952
5	QPSK	Low	4.540	5.000
		Middle	4.520	5.040
		High	4.520	5.000
	16QAM	Low	4.540	5.040
		Middle	4.540	5.040
		High	4.540	5.040
10	QPSK	Low	8.960	9.720
		Middle	8.960	9.720
		High	8.960	9.800
	16QAM	Low	9.000	9.800
		Middle	8.960	9.680
		High	8.960	9.680
15	QPSK	Low	13.560	14.940
		Middle	13.560	14.880
		High	13.560	15.000
	16QAM	Low	13.500	14.700
		Middle	13.500	14.880
		High	13.560	14.820
20	QPSK	Low	17.920	19.280
		Middle	18.000	19.520
		High	17.920	19.440
	16QAM	Low	18.000	19.200
		Middle	18.080	19.520
		High	17.920	19.440

LTE Band 4:

Bandwidth (MHz)	Modulation	Channel	99% Occupied Bandwidth (MHz)	26 dB Emission Bandwidth (MHz)
1.4	QPSK	Low	1.104	1.308
		Middle	1.104	1.320
		High	1.104	1.290
	16QAM	Low	1.110	1.314
		Middle	1.104	1.302
		High	1.110	1.332
3	QPSK	Low	2.700	2.940
		Middle	2.700	2.952
		High	2.688	2.952
	16QAM	Low	2.688	2.952
		Middle	2.688	2.964
		High	2.688	2.952
5	QPSK	Low	4.540	5.020
		Middle	4.520	5.060
		High	4.500	5.000
	16QAM	Low	4.520	5.000
		Middle	4.540	5.040
		High	4.540	5.060
10	QPSK	Low	8.960	9.720
		Middle	8.960	9.680
		High	8.960	9.720
	16QAM	Low	8.960	9.680
		Middle	8.960	9.600
		High	8.960	9.680
15	QPSK	Low	13.560	14.880
		Middle	13.500	14.760
		High	13.560	14.940
	16QAM	Low	13.560	14.880
		Middle	13.500	14.880
		High	13.560	14.940
20	QPSK	Low	17.920	19.360
		Middle	18.000	19.520
		High	18.000	19.520
	16QAM	Low	17.920	19.360
		Middle	17.920	19.440
		High	18.080	19.440

LTE Band 5:

Bandwidth (MHz)	Modulation	Channel	99% Occupied Bandwidth (MHz)	26 dB Emission Bandwidth (MHz)
1.4	QPSK	Low	1.104	1.314
		Middle	1.104	1.326
		High	1.104	1.296
	16QAM	Low	1.104	1.302
		Middle	1.104	1.290
		High	1.098	1.302
3	QPSK	Low	2.712	2.928
		Middle	2.700	2.928
		High	2.700	2.976
	16QAM	Low	2.688	2.976
		Middle	2.688	2.964
		High	2.700	2.964
5	QPSK	Low	4.540	5.060
		Middle	4.520	5.000
		High	4.520	5.040
	16QAM	Low	4.520	5.100
		Middle	4.540	5.000
		High	4.540	5.040
10	QPSK	Low	9.000	9.760
		Middle	8.960	9.640
		High	8.960	9.720
	16QAM	Low	9.000	9.760
		Middle	8.920	9.600
		High	8.960	9.720

LTE Band 7:

Bandwidth (MHz)	Modulation	Channel	99% Occupied Bandwidth (MHz)	26 dB Emission Bandwidth (MHz)
5	QPSK	Low	4.540	5.040
		Middle	4.520	5.020
		High	4.520	5.020
	16QAM	Low	4.520	5.020
		Middle	4.540	5.020
		High	4.560	5.060
10	QPSK	Low	8.960	9.760
		Middle	8.960	9.760
		High	8.960	9.760
	16QAM	Low	8.960	9.560
		Middle	9.000	9.880
		High	8.960	9.640
15	QPSK	Low	13.440	14.880
		Middle	13.560	14.880
		High	13.560	14.940
	16QAM	Low	13.440	14.820
		Middle	13.560	14.880
		High	13.620	14.820
20	QPSK	Low	17.920	19.280
		Middle	18.000	19.520
		High	18.080	19.760
	16QAM	Low	17.840	19.280
		Middle	18.080	19.440
		High	18.080	19.440

LTE Band 12

Bandwidth (MHz)	Modulation	Channel	99% Occupied Bandwidth (MHz)	26 dB Emission Bandwidth (MHz)
1.4	QPSK	Low	1.104	1.320
		Middle	1.110	1.314
		High	1.104	1.296
	16QAM	Low	1.110	1.308
		Middle	1.098	1.284
		High	1.110	1.314
3	QPSK	Low	2.700	2.928
		Middle	2.700	2.952
		High	2.688	2.964
	16QAM	Low	2.688	2.976
		Middle	2.688	2.940
		High	2.688	2.952
5	QPSK	Low	4.520	5.000
		Middle	4.520	5.060
		High	4.520	4.980
	16QAM	Low	4.500	4.980
		Middle	4.560	5.080
		High	4.540	5.020
10	QPSK	Low	8.960	9.720
		Middle	8.960	9.680
		High	8.960	9.680
	16QAM	Low	8.920	9.760
		Middle	9.000	9.720
		High	8.960	9.720

LTE Band 13

Bandwidth (MHz)	Modulation	Channel	99% Occupied Bandwidth (MHz)	26 dB Emission Bandwidth (MHz)
5	QPSK	Low	4.540	5.060
		Middle	4.520	5.060
		High	4.520	5.020
	16QAM	Low	4.500	5.000
		Middle	4.520	5.020
		High	4.540	5.040
10	QPSK	Middle	8.960	9.800
	16QAM	Middle	8.960	9.640

LTE Band 25

Bandwidth (MHz)	Modulation	Channel	99% Occupied Bandwidth (MHz)	26 dB Emission Bandwidth (MHz)
1.4	QPSK	Low	1.110	1.314
		Middle	1.116	1.350
		High	1.104	1.308
	16QAM	Low	1.110	1.314
		Middle	1.104	1.308
		High	1.098	1.308
3	QPSK	Low	2.700	2.952
		Middle	2.712	2.940
		High	2.700	2.952
	16QAM	Low	2.688	2.964
		Middle	2.688	2.952
		High	2.700	2.940
5	QPSK	Low	4.540	5.060
		Middle	4.520	5.040
		High	4.520	4.980
	16QAM	Low	4.520	5.040
		Middle	4.540	5.000
		High	4.520	5.020
10	QPSK	Low	9.000	9.760
		Middle	8.960	9.800
		High	8.960	9.640
	16QAM	Low	9.000	9.760
		Middle	8.960	9.760
		High	8.960	9.640
15	QPSK	Low	13.620	14.880
		Middle	13.620	14.820
		High	13.560	14.940
	16QAM	Low	13.500	14.820
		Middle	13.560	14.880
		High	13.560	14.880
20	QPSK	Low	17.840	19.360
		Middle	18.080	19.520
		High	17.920	19.440
	16QAM	Low	17.920	19.440
		Middle	18.080	19.680
		High	18.000	19.360

LTE Band 26

Bandwidth (MHz)	Modulation	Channel	99% Occupied Bandwidth (MHz)	26 dB Emission Bandwidth (MHz)
1.4	QPSK	Low	1.104	1.332
		Middle	1.104	1.308
		High	1.110	1.320
	16QAM	Low	1.110	1.320
		Middle	1.104	1.314
		High	1.104	1.338
3	QPSK	Low	2.700	2.952
		Middle	2.700	2.952
		High	2.700	2.976
	16QAM	Low	2.700	2.988
		Middle	2.700	2.952
		High	2.688	2.964
5	QPSK	Low	4.520	5.020
		Middle	4.540	5.000
		High	4.520	5.020
	16QAM	Low	4.520	5.020
		Middle	4.520	5.040
		High	4.520	5.040
10	QPSK	Low	8.960	9.800
		Middle	8.920	9.640
		High	8.960	9.760
	16QAM	Low	8.960	9.680
		Middle	8.920	9.720
		High	8.960	9.680
15	QPSK	Low	13.560	14.820
		Middle	13.500	14.760
		High	13.560	15.000
	16QAM	Low	13.560	14.820
		Middle	13.500	14.760
		High	13.560	14.880

The test plots of LTE bands please refer to the Appendix A.

FCC §2.1051, §22.917(a), §24.238(a), §27.53, §90.691 - SPURIOUS EMISSIONS AT ANTENNA TERMINALS

Applicable Standard

FCC §2.1051, §22.917(a) and §24.238(a) and §27.53 and §90.691

The spectrum was to be investigated to the tenth harmonics of the highest fundamental frequency as specified in § 2.1051.

Test Procedure

The RF output of the transceiver was connected to a spectrum analyzer and simulator through appropriate attenuation. The resolution bandwidth of the spectrum analyzer was set at 1MHz. Sufficient scans were taken to show any out of band emissions up to 10th harmonic.

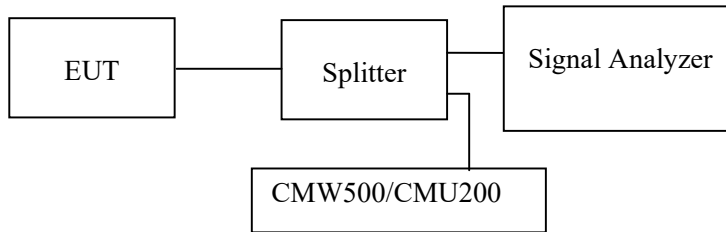

Test Data

Environmental Conditions

Temperature:	27.8~29.1 °C
Relative Humidity:	49~57 %
ATM Pressure:	100.9~101.2 kPa

The testing was performed by Pedro Yun from 2021-05-31 to 2021-07-18.

EUT operation mode: Transmitting

Test result: Pass

Please refer to the following plots.

**Cellular Band (Part 22H)
Low Channel:**

30 MHz – 1 GHz (GSM Mode)

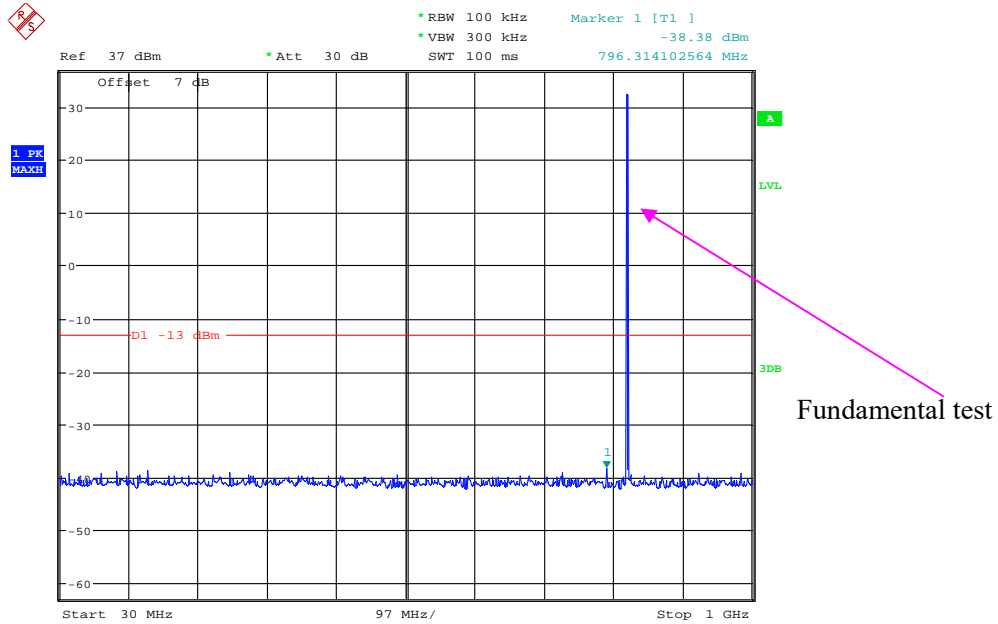

Date: 31.MAY.2021 20:41:50

1 GHz – 10 GHz (GSM Mode)

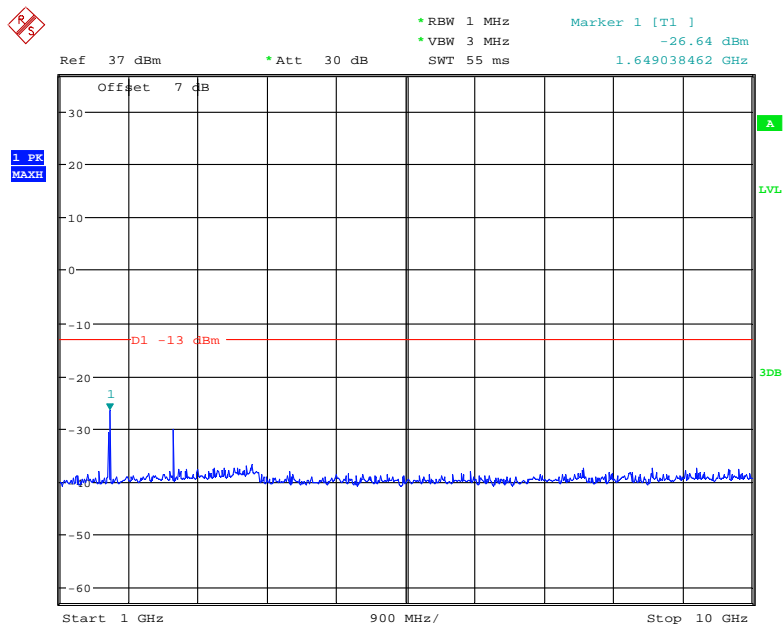

Date: 31.MAY.2021 20:45:34

30 MHz – 1 GHz (WCDMA Mode)

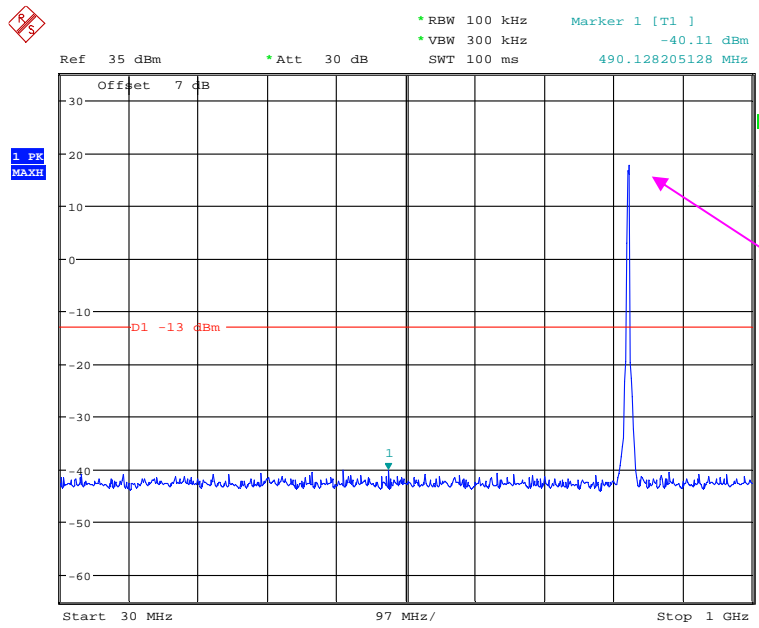

Fundamental test

Date: 31.MAY.2021 23:12:59

1 GHz – 20 GHz (WCDMA Mode)

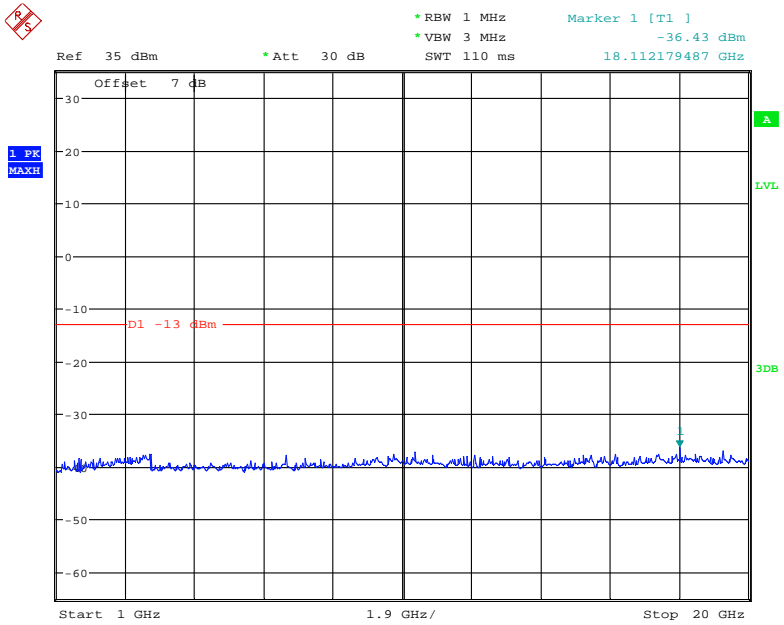

Date: 31.MAY.2021 23:09:23

Middle Channel:

30 MHz – 1 GHz (GSM Mode)

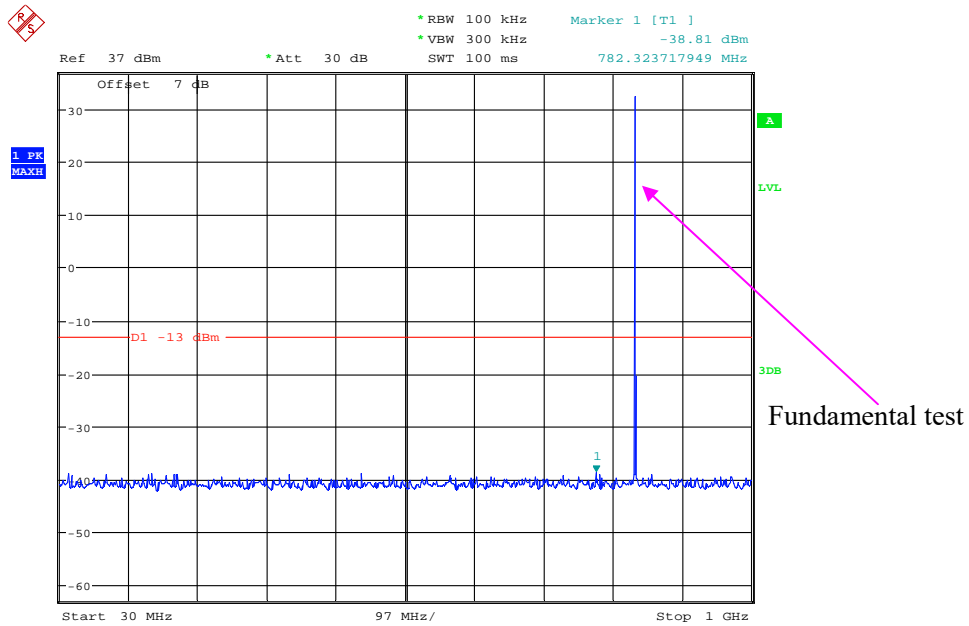

Date: 31.MAY.2021 20:43:15

1 GHz – 10 GHz (GSM Mode)

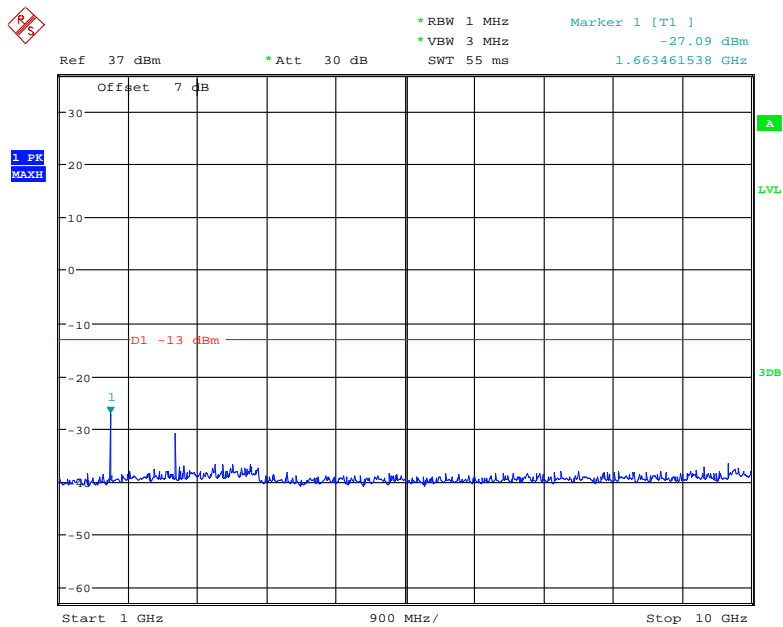

Date: 31.MAY.2021 20:45:12

30 MHz – 1 GHz (WCDMA Mode)

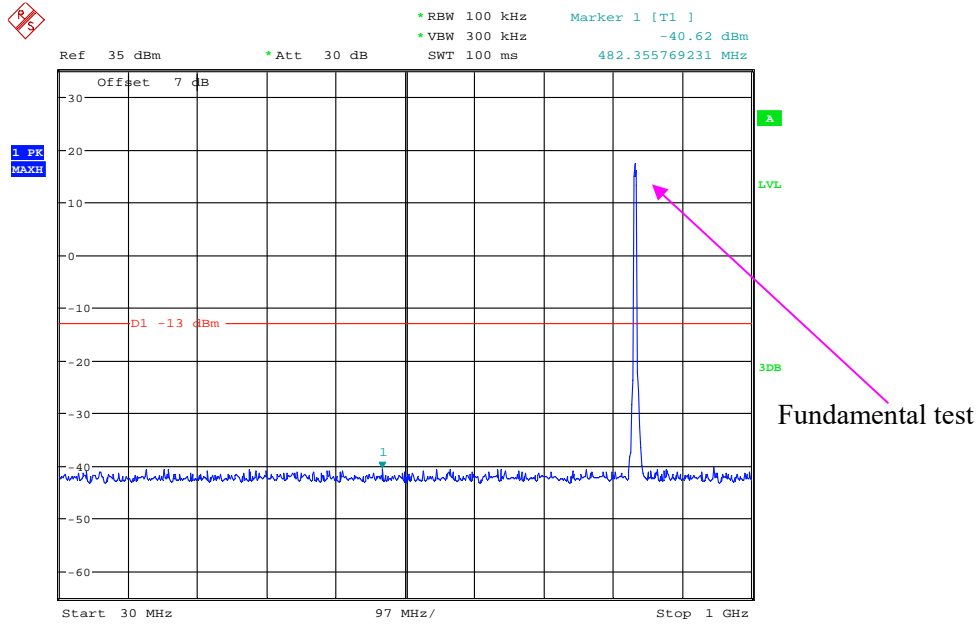

Date: 31.MAY.2021 23:11:58

1 GHz – 20 GHz (WCDMA Mode)

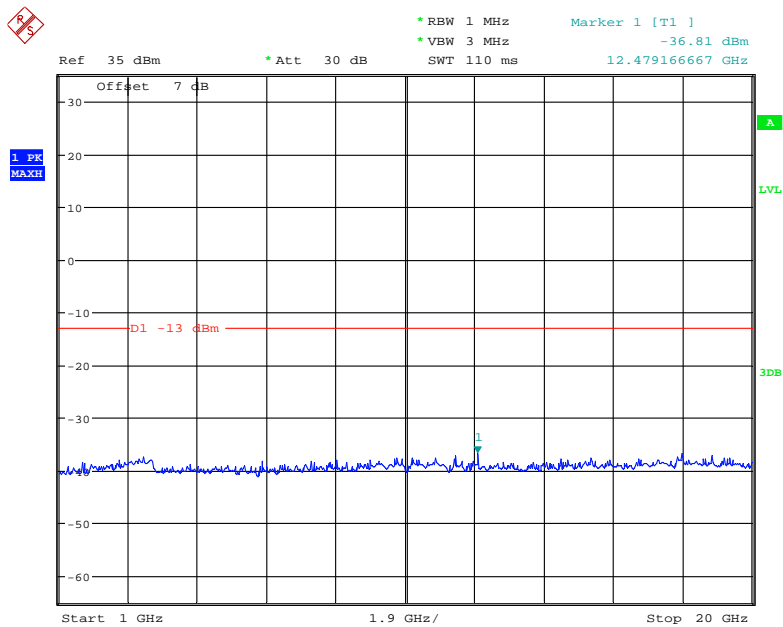

Date: 31.MAY.2021 23:08:43

High Channel:

30 MHz – 1 GHz (GSM Mode)

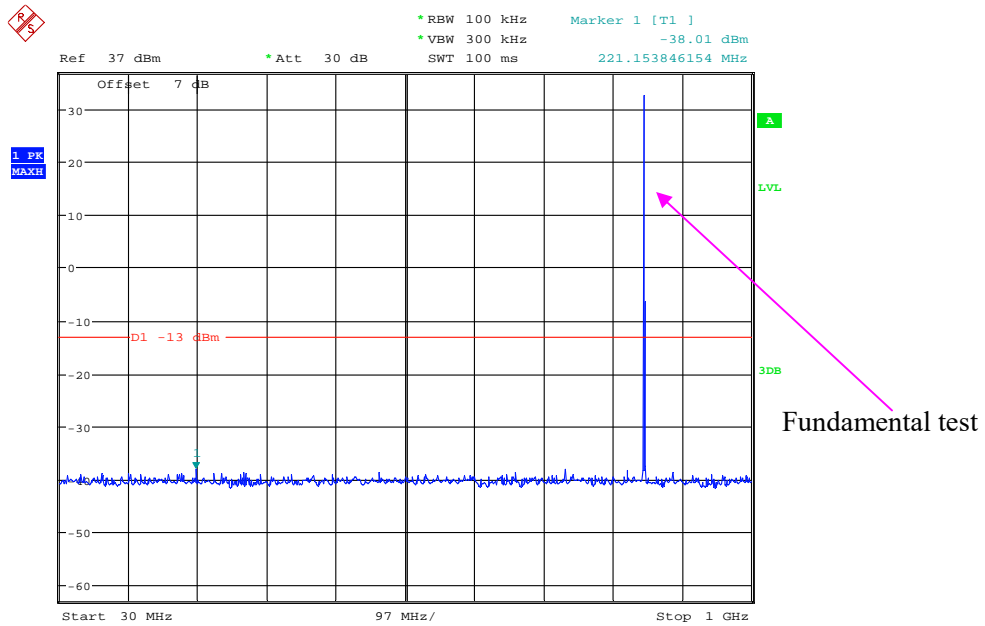

Date: 31.MAY.2021 20:44:07

1 GHz – 10 GHz (GSM Mode)

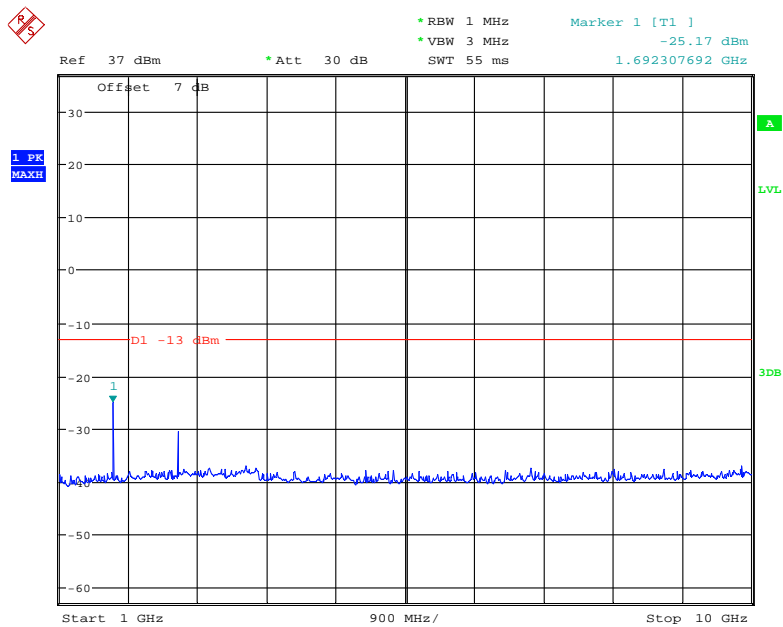

Date: 31.MAY.2021 20:44:39

30 MHz – 1 GHz (WCDMA Mode)

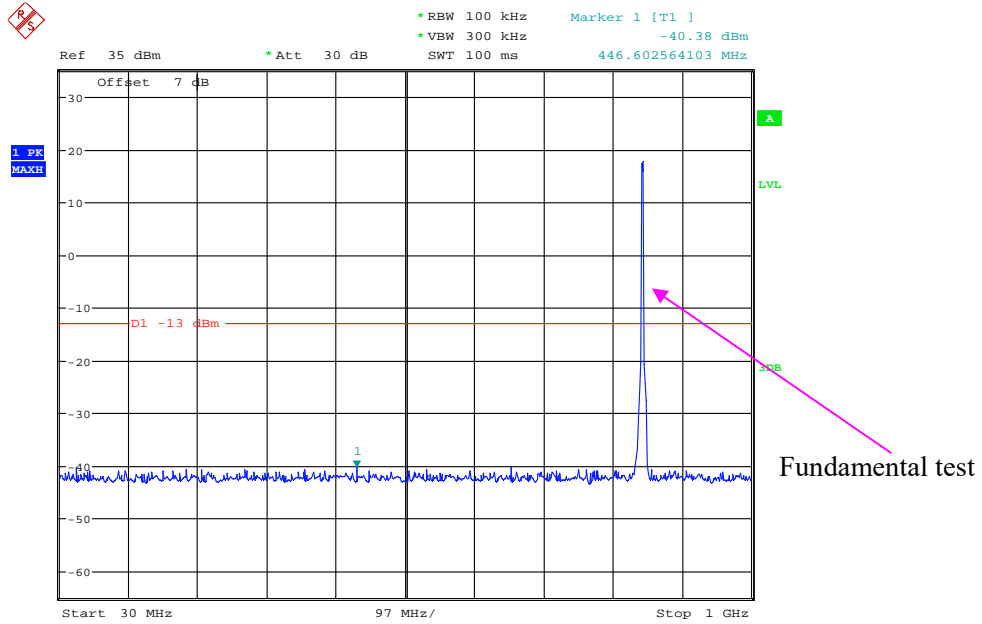

Date: 31.MAY.2021 23:10:43

1 GHz – 20 GHz (WCDMA Mode)

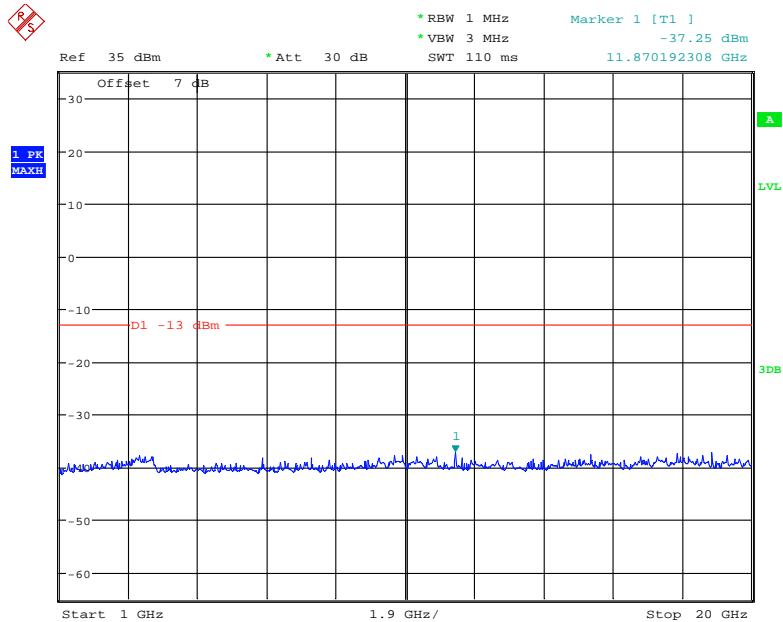

Date: 31.MAY.2021 23:08:26

**PCS Band (Part 24E)
Low Channel:**

30 MHz – 1 GHz (GSM Mode)

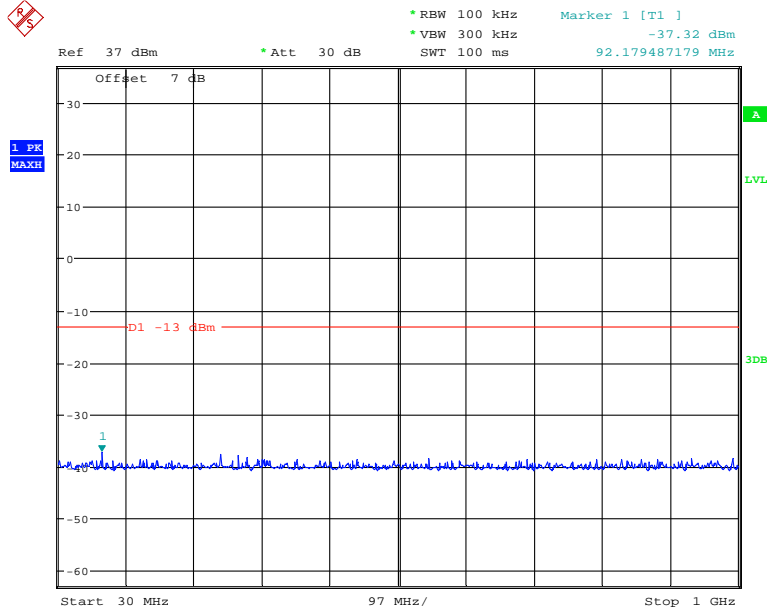

Date: 31.MAY.2021 21:40:13

1 GHz – 2 GHz (GSM Mode)

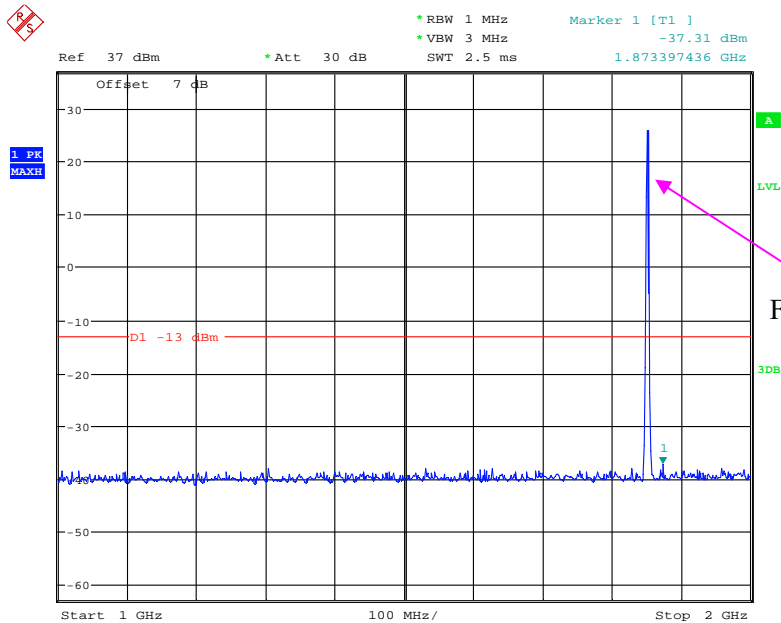

Date: 31.MAY.2021 21:43:14

2 GHz – 20 GHz (GSM Mode)

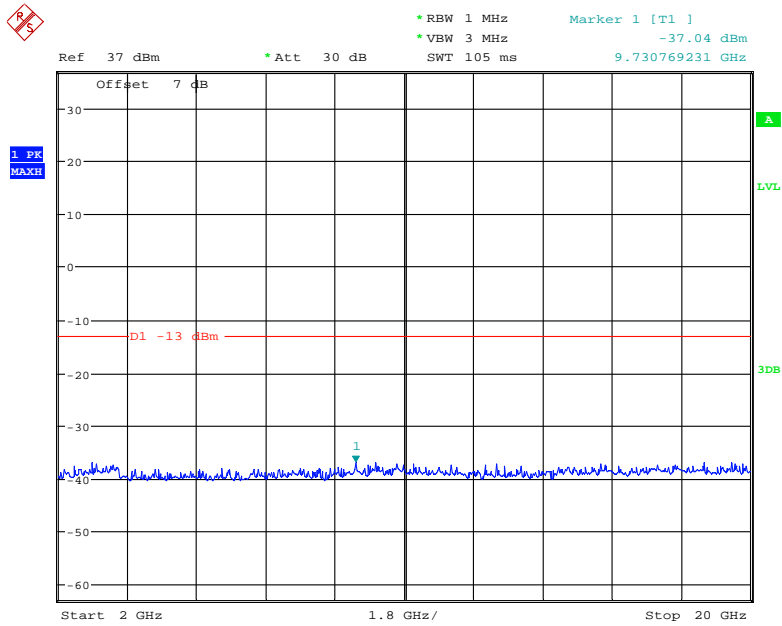

Date: 31.MAY.2021 21:43:40

30 MHz – 1 GHz (WCDMA Mode)

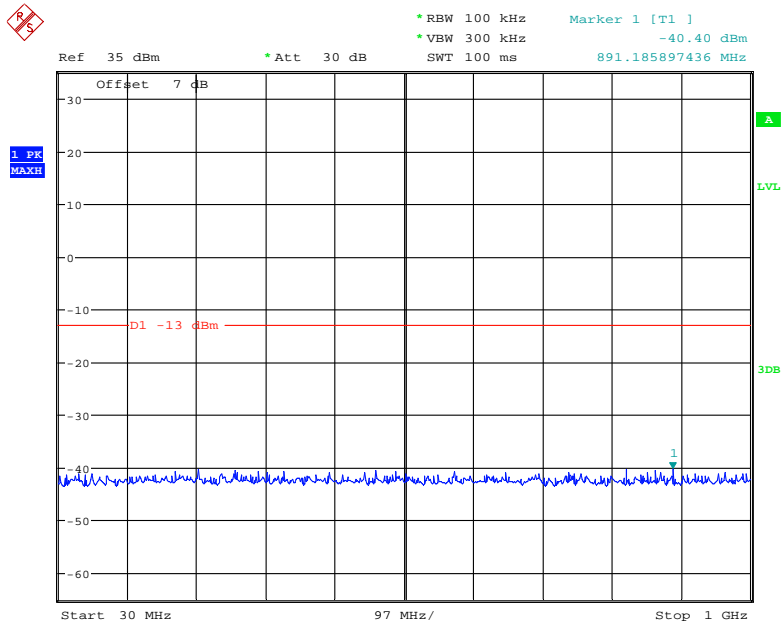

Date: 31.MAY.2021 23:01:22

1 GHz – 20 GHz (WCDMA Mode)

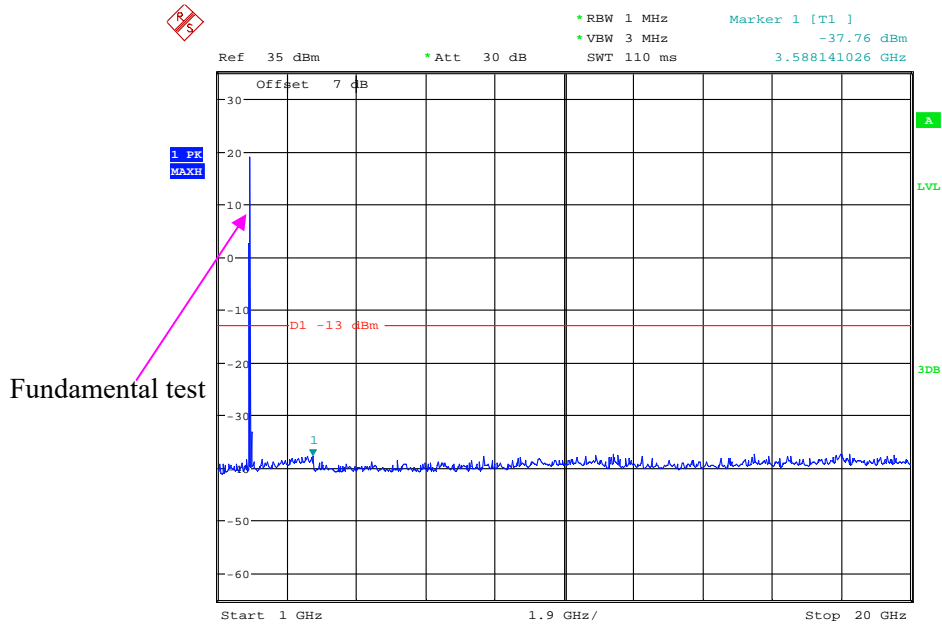

Date: 31.MAY.2021 23:02:59

Middle Channel:

30 MHz – 1 GHz (GSM Mode)

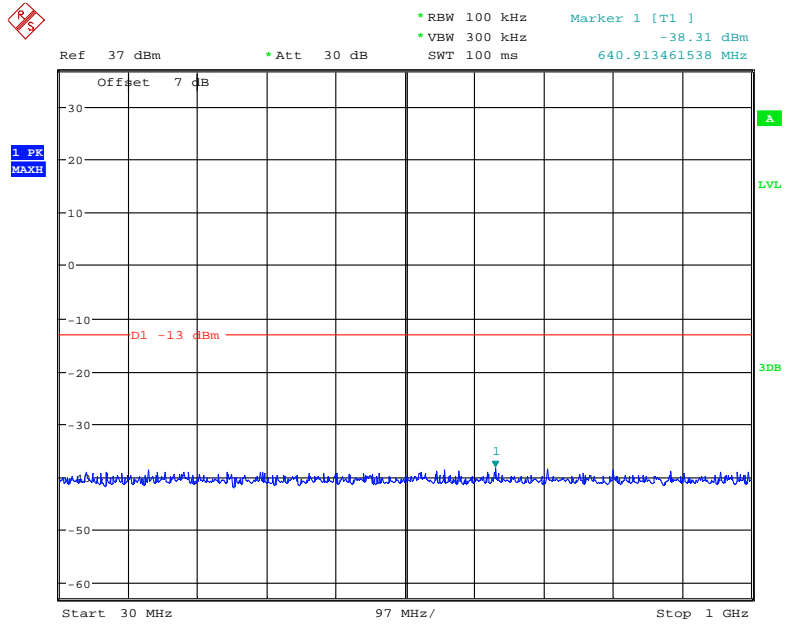

Date: 31.MAY.2021 21:40:43

1 GHz – 2 GHz (GSM Mode)

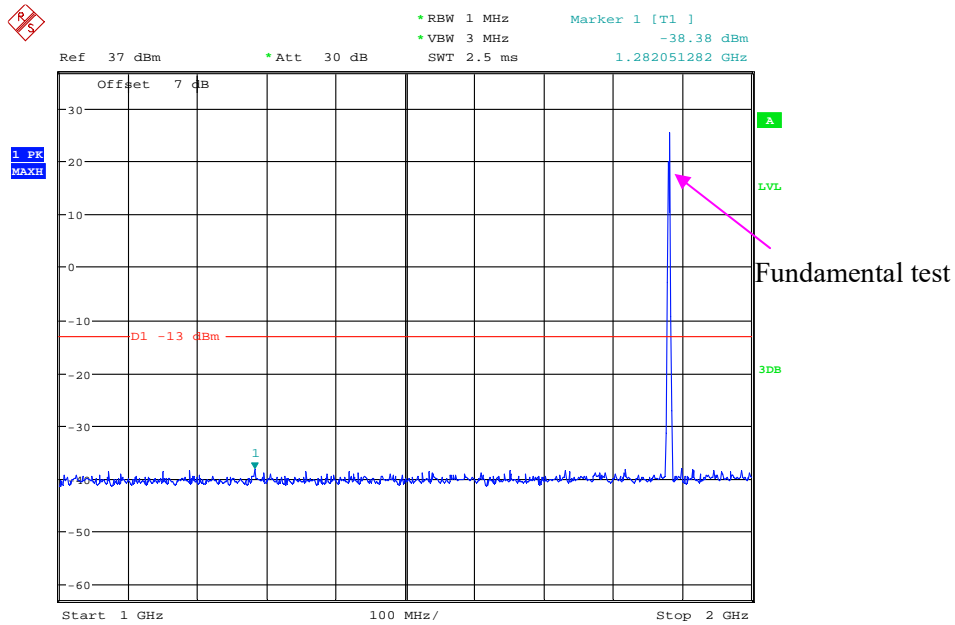

Date: 31.MAY.2021 21:42:23

2 GHz – 20 GHz (GSM Mode)

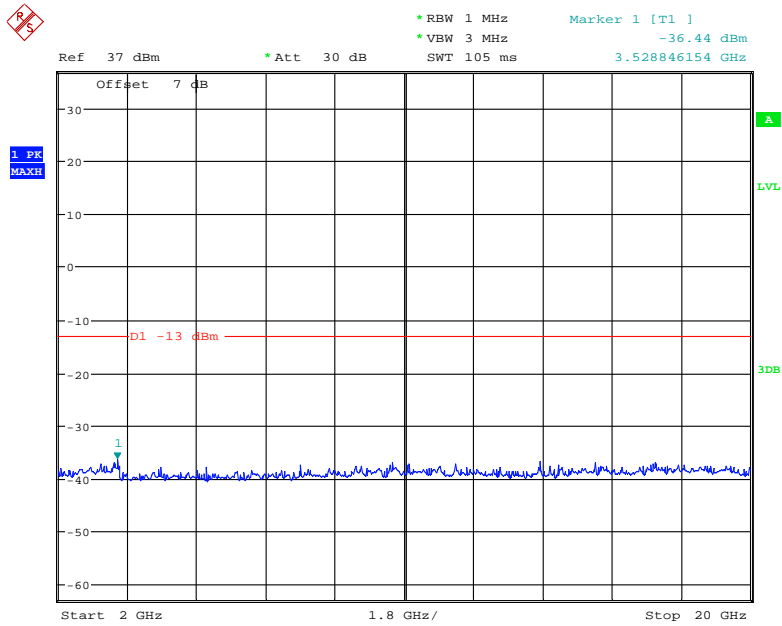

Date: 31.MAY.2021 21:44:12

30 MHz – 1 GHz (WCDMA Mode)

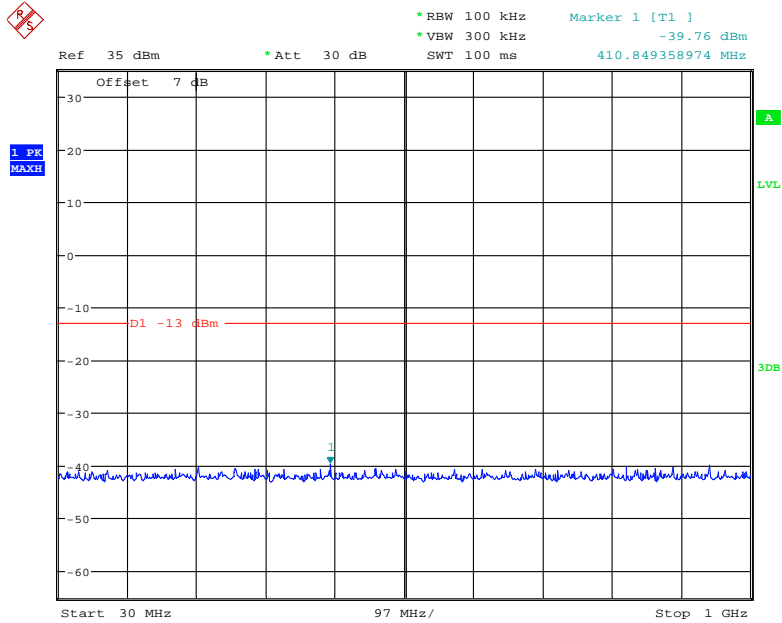

Date: 31.MAY.2021 23:01:48

1 GHz – 20 GHz (WCDMA Mode)

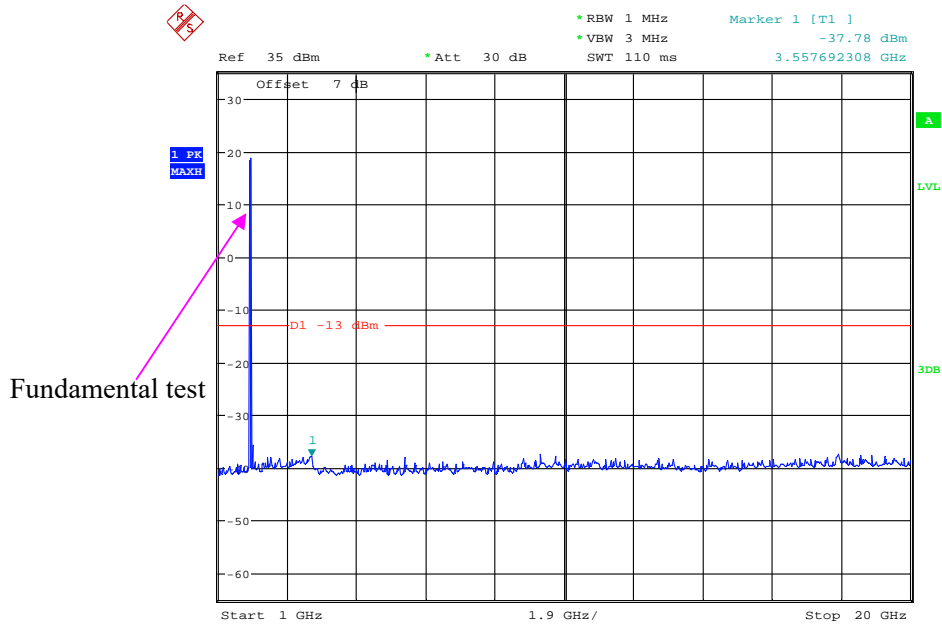

Date: 31.MAY.2021 23:04:37

High Channel:

30 MHz – 1 GHz (GSM Mode)

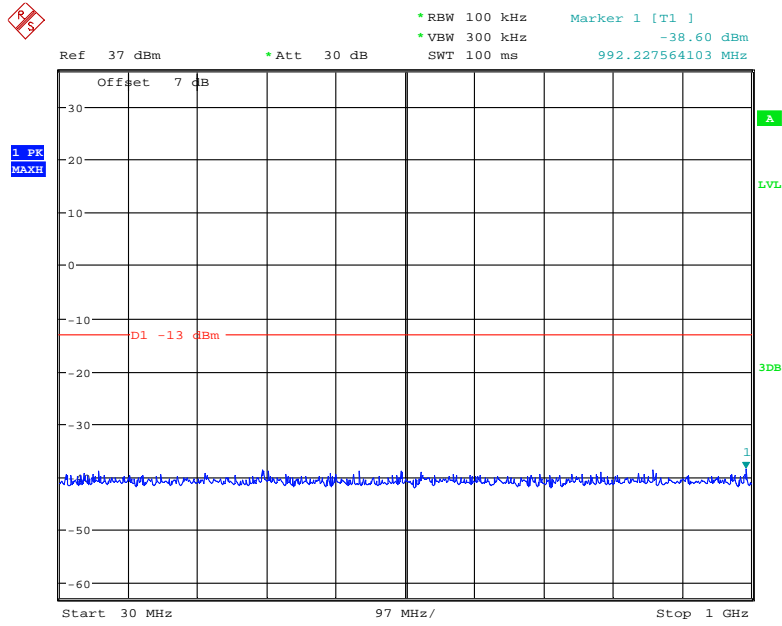

Date: 31.MAY.2021 21:39:02

1 GHz – 2 GHz (GSM Mode)

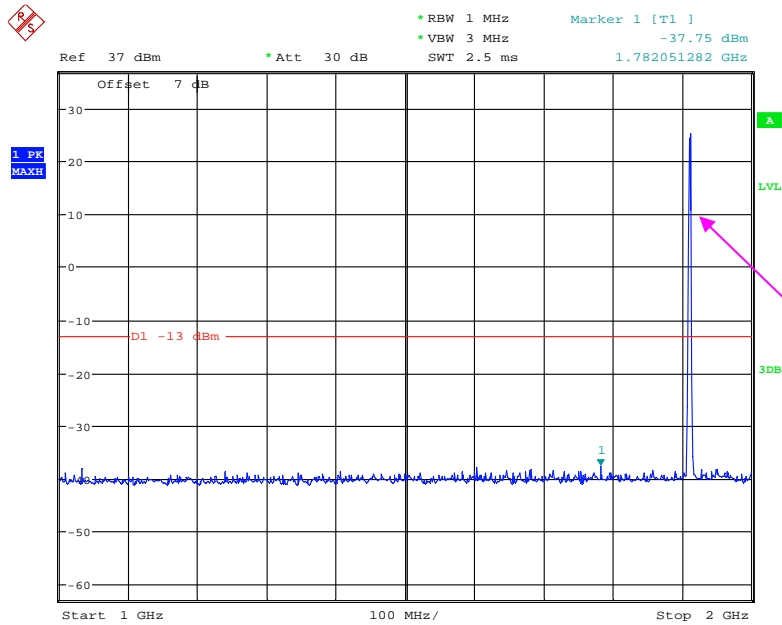

Date: 31.MAY.2021 21:41:26

2 GHz – 20 GHz (GSM Mode)

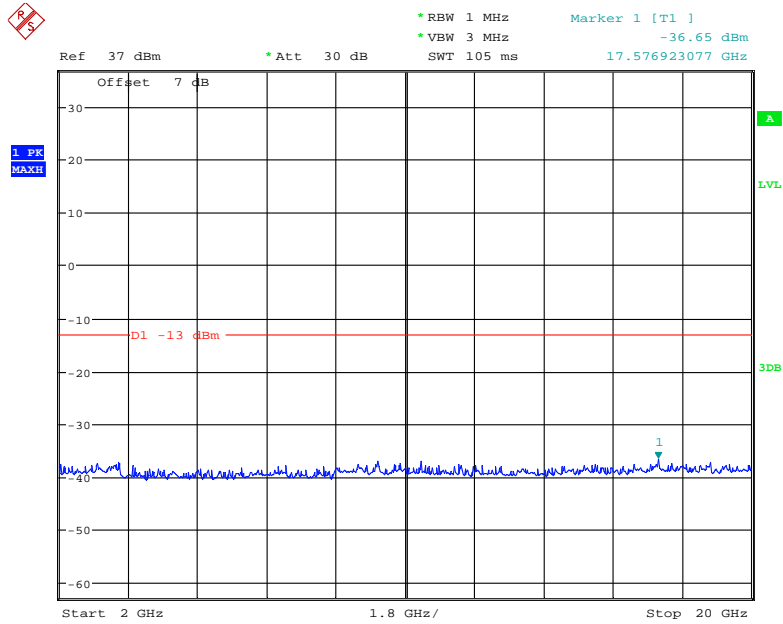

Date: 31.MAY.2021 21:44:40

30 MHz – 1 GHz (WCDMA Mode)

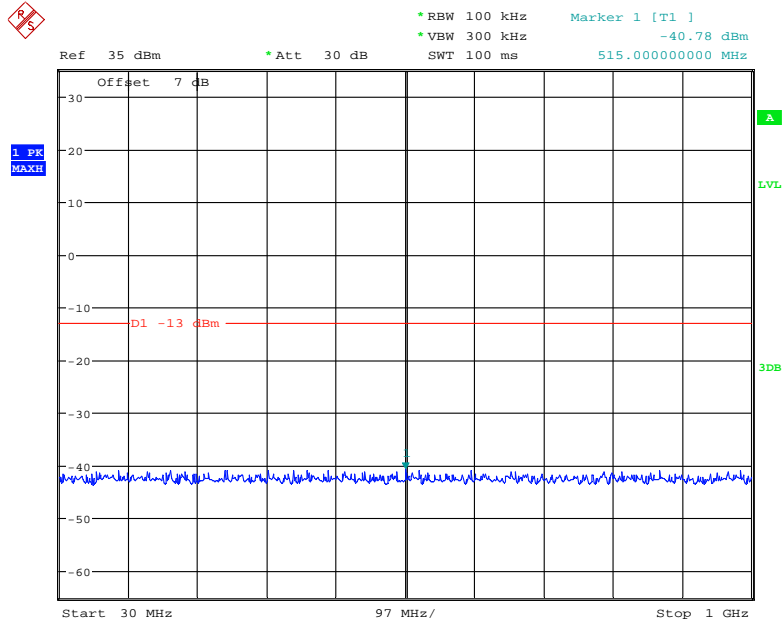

Date: 31.MAY.2021 23:02:16

1 GHz – 20 GHz (WCDMA Mode)

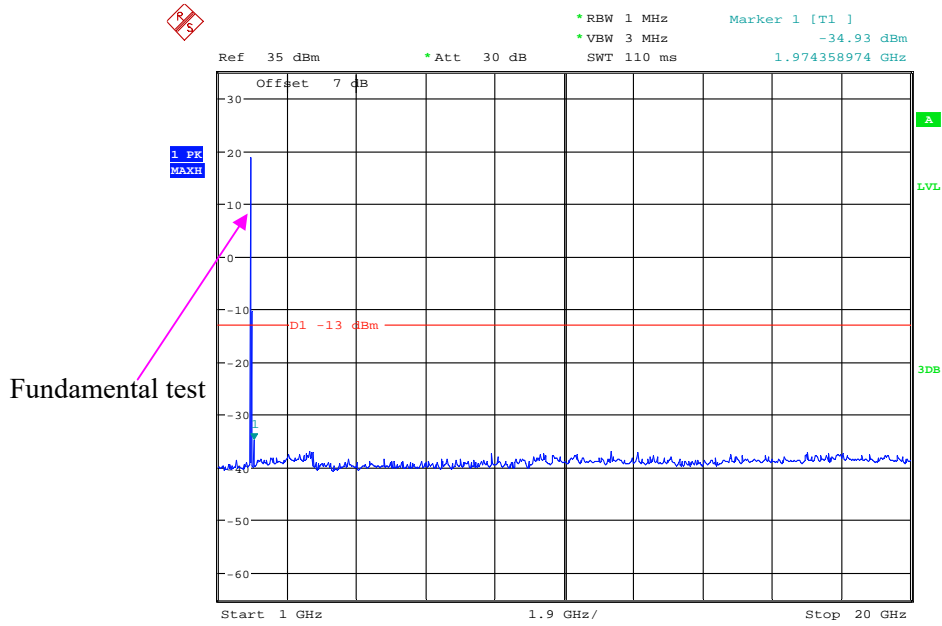

Date: 31.MAY.2021 23:05:58

AWS Band (Part 27)

Low Channel:

30 MHz – 1 GHz (WCDMA Mode)

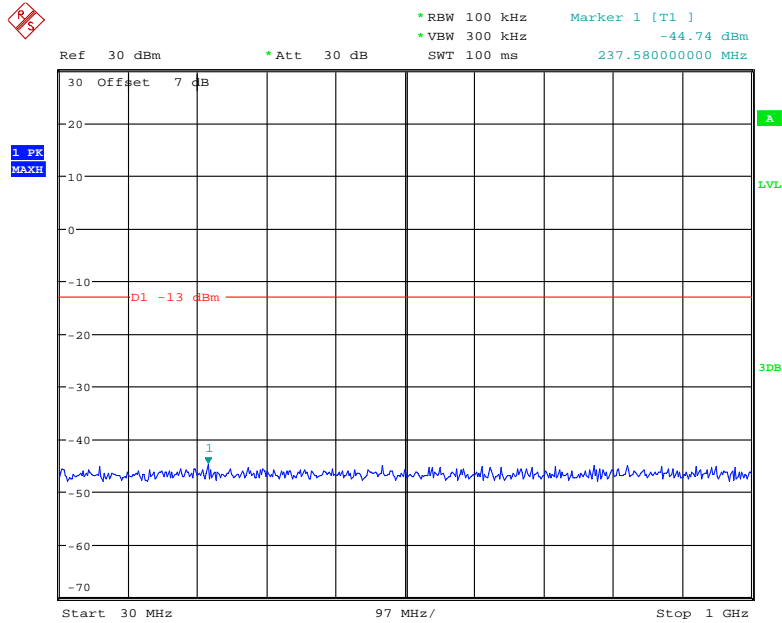

Date: 11.JUL.2021 15:40:45

1 GHz – 20 GHz (WCDMA Mode)

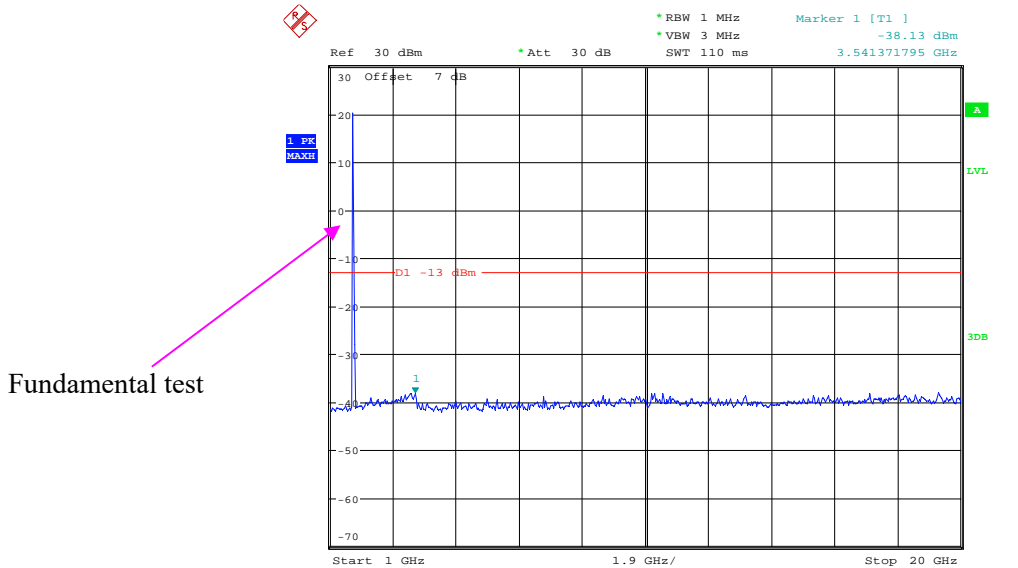

Fundamental test

Date: 11.JUL.2021 15:42:17

Middle Channel

30 MHz – 1 GHz (WCDMA Mode)

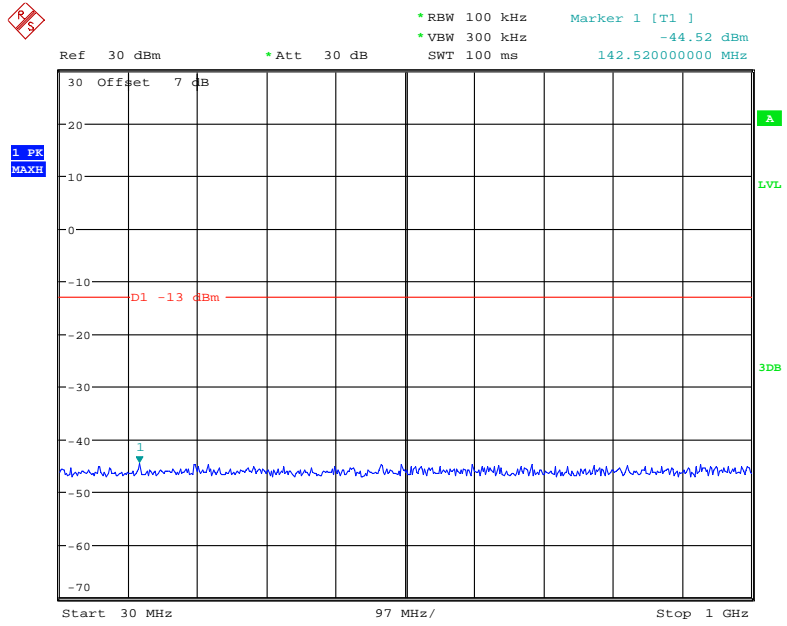

Date: 11.JUL.2021 15:41:12

1 GHz – 20 GHz (WCDMA Mode)

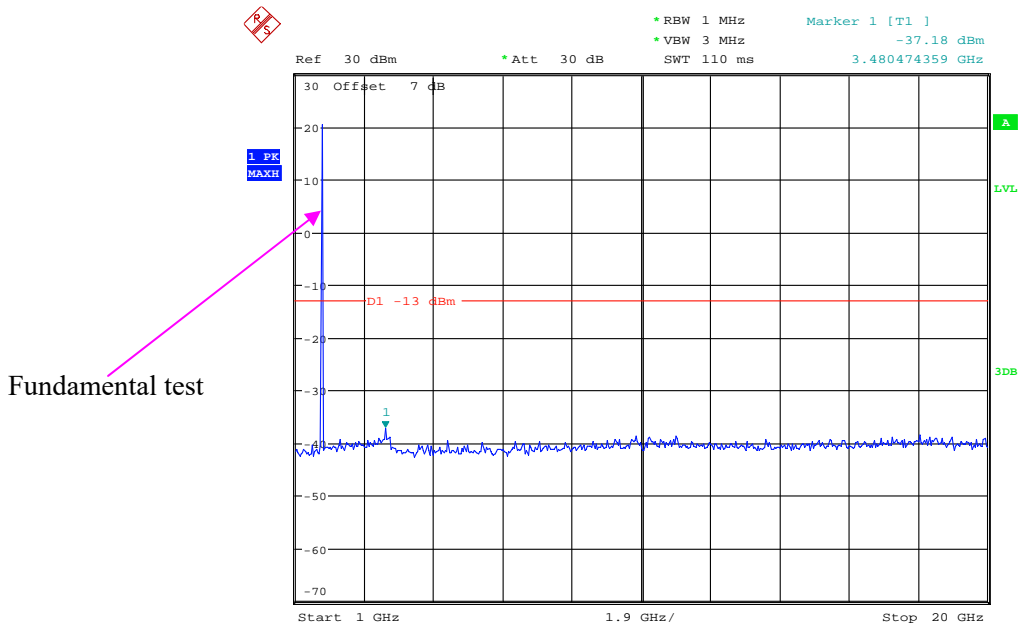

Date: 11.JUL.2021 15:42:57

High Channel:

30 MHz – 1 GHz (WCDMA Mode)

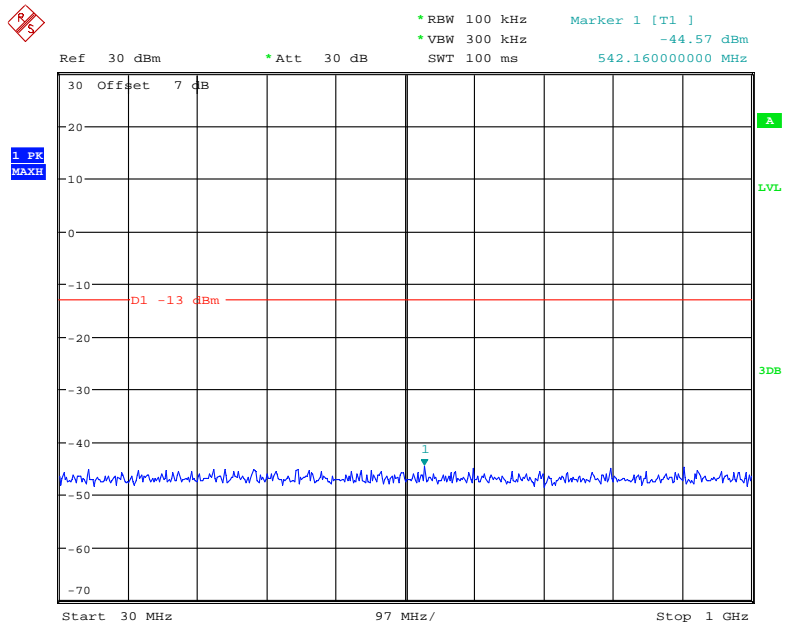

Date: 11.JUL.2021 15:41:28

1 GHz – 20 GHz (WCDMA Mode)

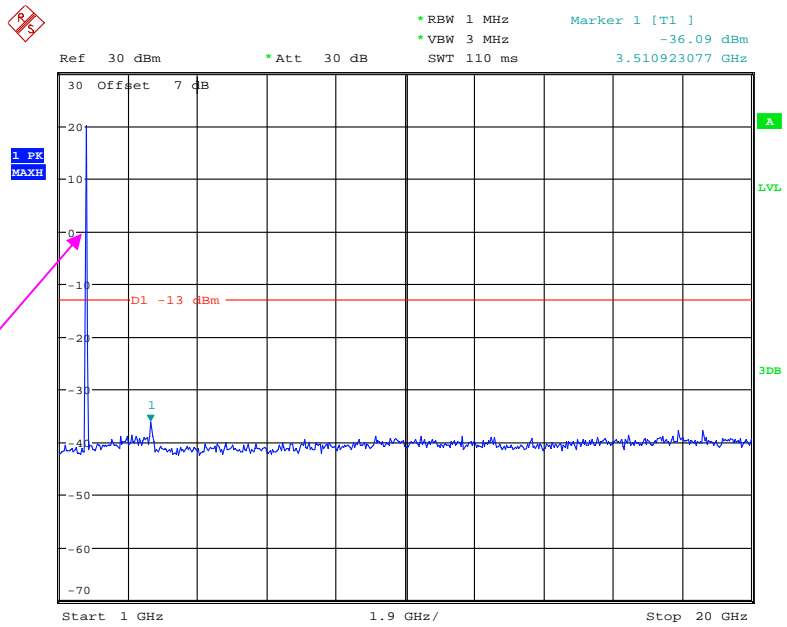

Fundamental test

Date: 11.JUL.2021 15:43:28

The test plots of LTE band please refer to the Appendix B

FCC § 2.1053, § 22.917 (a), § 24.238 (a), §27.53, §90.691-SPURIOUS RADIATED EMISSIONS

Applicable Standard

FCC § 2.1053, §22.917(a) and § 24.238(a) and § 27.53 and §90.691.

Test Procedure

The transmitter was placed on a wooden turntable, and it was transmitting into a non-radiating load which was also placed on the turntable.

The measurement antenna was placed at a distance of 3 meters from the EUT. During the tests, the receiving antenna height and polarization as well as EUT azimuth were varied in order to identify the maximum level of emissions from the EUT. The test was performed by placing the EUT on 3-orthogonal axis.

The frequency range up to tenth harmonic of the fundamental frequency was investigated.

Test Data

Environmental Conditions

Temperature:	27~29.3 °C
Relative Humidity:	50~59 %
ATM Pressure:	101.0~101.1 kPa

The testing was performed by Zero Yan 2021-05-29 for below 1GHz and Bruce Lin on 2021-06-03 for above 1GHz.

EUT operation mode: Transmitting

30 MHz ~ 10 GHz:

Cellular Band

Frequency (MHz)	Receiver Reading (dBµV)	Turntable Angle Degree	Rx Antenna		Substituted			Absolute Level (dBm)	FCC Part 22H	
			Height (m)	Polar (H/V)	Level (dBm)	Cable Loss (dB)	Antenna Gain (dBd/dBi)		Limit (dBm)	Margin (dB)
GSM Mode										
Low channel										
962.3	30.77	351	1.2	H	-65.7	1.36	0.0	-67.06	-13	54.06
962.3	32.06	253	2.0	V	-62.0	1.36	0.0	-63.36	-13	50.36
1648.4	62.14	285	2.5	H	-45.9	1.40	8.70	-38.60	-13	25.60
1648.4	59.38	328	2.1	V	-48.5	1.40	8.70	-41.20	-13	28.20
2472.6	63.24	201	1.8	H	-40.1	2.60	10.20	-32.50	-13	19.50
2472.6	60.24	199	2.3	V	-42.5	2.60	10.20	-34.90	-13	21.90
3296.8	44.12	202	2.1	H	-56.8	1.50	11.70	-46.60	-13	33.60
3296.8	43.96	32	1.4	V	-57.0	1.50	11.70	-46.80	-13	33.80
Middle channel										
960.6	30.75	167	2.2	H	-65.8	1.36	0.0	-67.16	-13	54.16
960.6	32.12	248	1.3	V	-61.9	1.36	0.0	-63.26	-13	50.26
1673.2	63.14	1	1.7	H	-43.2	1.30	8.90	-35.60	-13	22.60
1673.2	60.24	128	2.0	V	-45.5	1.30	8.90	-37.90	-13	24.90
2509.8	61.33	238	2.2	H	-42.0	2.60	10.20	-34.40	-13	21.40
2509.8	60.25	213	1.0	V	-42.5	2.60	10.20	-34.90	-13	21.90
3346.4	44.12	272	1.7	H	-56.8	1.50	11.70	-46.60	-13	33.60
3346.4	43.96	95	1.6	V	-57.0	1.50	11.70	-46.80	-13	33.80
High channel										
961.8	30.71	104	2.0	H	-65.8	1.36	0.0	-67.16	-13	54.16
961.8	32.11	282	2.5	V	-61.9	1.36	0.0	-63.26	-13	50.26
1697.6	61.58	339	1.5	H	-44.8	1.30	8.90	-37.20	-13	24.20
1697.6	59.68	262	2.4	V	-46.1	1.30	8.90	-38.50	-13	25.50
2546.4	58.69	166	1.3	H	-44.7	2.60	10.20	-37.10	-13	24.10
2546.4	57.68	74	2.3	V	-45.1	2.60	10.20	-37.50	-13	24.50
3395.2	44.35	214	2.3	H	-56.9	1.40	11.80	-46.50	-13	33.50
3395.2	44.18	159	2.1	V	-56.9	1.40	11.80	-46.50	-13	33.50

Frequency (MHz)	Receiver Reading (dBµV)	Turntable Angle Degree	Rx Antenna		Substituted			Absolute Level (dBm)	FCC Part 22H	
			Height (m)	Polar (H/V)	Level (dBm)	Cable Loss (dB)	Antenna Gain (dBd/dBi)		Limit (dBm)	Margin (dB)
WCDMA Mode										
Low channel										
956.3	30.53	200	2.0	H	-66.0	1.36	0.0	-67.36	-13	54.36
956.3	32.09	126	2.2	V	-62.0	1.36	0.0	-63.36	-13	50.36
1652.80	43.66	218	1.3	H	-62.7	1.30	8.90	-55.10	-13	42.10
1652.80	43.58	356	1.4	V	-62.2	1.30	8.90	-54.60	-13	41.60
2479.20	48.34	206	2.0	H	-55.0	2.60	10.20	-47.40	-13	34.40
2479.20	45.21	86	1.3	V	-57.5	2.60	10.20	-49.90	-13	36.90
3305.60	44.34	357	2.5	H	-56.6	1.50	11.70	-46.40	-13	33.40
3305.60	44.27	218	2.4	V	-56.7	1.50	11.70	-46.50	-13	33.50
Middle channel										
958.6	30.59	330	2.1	H	-65.9	1.36	0.0	-67.26	-13	54.26
958.6	32.06	230	2.1	V	-62.0	1.36	0.0	-63.36	-13	50.36
1673.20	44.15	10	1.9	H	-62.2	1.30	8.90	-54.60	-13	41.60
1673.20	43.76	303	2.0	V	-62.0	1.30	8.90	-54.40	-13	41.40
2509.80	45.12	61	1.0	H	-58.2	2.60	10.20	-50.60	-13	37.60
2509.80	44.37	54	1.6	V	-58.4	2.60	10.20	-50.80	-13	37.80
3346.40	43.68	253	2.4	H	-57.2	1.50	11.70	-47.00	-13	34.00
3346.40	44.24	268	2.2	V	-56.7	1.50	11.70	-46.50	-13	33.50
High channel										
960.8	30.57	8	1.9	H	-65.9	1.36	0.0	-67.26	-13	54.26
960.8	32.12	318	2.4	V	-61.9	1.36	0.0	-63.26	-13	50.26
1693.20	43.61	326	2.0	H	-62.7	1.30	8.90	-55.10	-13	42.10
1693.20	43.57	255	2.2	V	-62.2	1.30	8.90	-54.60	-13	41.60
2539.80	44.64	245	2.0	H	-58.7	2.60	10.20	-51.10	-13	38.10
2539.80	44.16	96	1.4	V	-58.6	2.60	10.20	-51.00	-13	38.00
3386.40	44.67	175	2.2	H	-56.6	1.40	11.80	-46.20	-13	33.20
3386.40	44.39	108	1.3	V	-56.7	1.40	11.80	-46.30	-13	33.30

30 MHz ~ 20 GHz:

PCS Band

Frequency (MHz)	Receiver Reading (dBµV)	Turntable Angle Degree	Rx Antenna		Substituted			Absolute Level (dBm)	FCC Part 24E	
			Height (m)	Polar (H/V)	Level (dBm)	Cable Loss (dB)	Antenna Gain (dBd/dBi)		Limit (dBm)	Margin (dB)
GSM Mode										
Low channel										
962.1	30.67	241	2.3	H	-65.8	1.36	0.0	-67.16	-13	54.16
962.1	32.07	106	1.7	V	-62.0	1.36	0.0	-63.36	-13	50.36
3700.4	45.76	179	2.0	H	-56.0	1.60	11.90	-45.70	-13	32.70
3700.4	44.61	136	1.2	V	-56.6	1.60	11.90	-46.30	-13	33.30
Middle channel										
963.2	30.69	224	1.5	H	-65.8	1.36	0.0	-67.16	-13	54.16
963.2	32.02	233	2.2	V	-62.0	1.36	0.0	-63.36	-13	50.36
3760.0	45.35	276	1.1	H	-56.7	1.50	11.80	-46.40	-13	33.40
3760.0	44.86	42	2.2	V	-56.7	1.50	11.80	-46.40	-13	33.40
High channel										
960.5	30.75	27	1.8	H	-65.8	1.36	0.0	-67.16	-13	54.16
960.5	32.05	342	2.4	V	-62.0	1.36	0.0	-63.36	-13	50.36
3819.6	44.96	6	1.2	H	-57.1	1.50	11.80	-46.80	-13	33.80
3819.6	44.54	276	1.1	V	-57.0	1.50	11.80	-46.70	-13	33.70
WCDMA Mode										
Low channel										
956.8	30.58	227	1.1	H	-65.9	1.36	0.0	-67.26	-13	54.26
956.8	32.07	310	1.6	V	-62.0	1.36	0.0	-63.36	-13	50.36
3704.80	44.33	194	2.0	H	-57.5	1.60	11.90	-47.20	-13	34.20
3704.80	43.64	292	1.1	V	-57.6	1.60	11.90	-47.30	-13	34.30
Middle channel										
954.7	30.51	271	2.2	H	-66.0	1.36	0.0	-67.36	-13	54.36
954.7	32.11	101	2.2	V	-61.9	1.36	0.0	-63.26	-13	50.26
3760.00	44.26	294	2.2	H	-57.8	1.50	11.80	-47.50	-13	34.50
3760.00	43.83	349	1.0	V	-57.8	1.50	11.80	-47.50	-13	34.50
High channel										
961.2	30.55	243	2.3	H	-66.0	1.36	0.0	-67.36	-13	54.36
961.2	32.14	335	2.4	V	-61.9	1.36	0.0	-63.26	-13	50.26
3815.20	44.78	74	2.5	H	-57.3	1.50	11.80	-47.00	-13	34.00
3815.20	44.02	49	1.0	V	-57.6	1.50	11.80	-47.30	-13	34.30

30 MHz ~ 20 GHz:

AWS Band

Frequency (MHz)	Receiver Reading (dBµV)	Turntable Angle Degree	Rx Antenna		Substituted			Absolute Level (dBm)	FCC Part 27	
			Height (m)	Polar (H/V)	Level (dBm)	Cable Loss (dB)	Antenna Gain (dBd/dBi)		Limit (dBm)	Margin (dB)
WCDMA Mode										
Low channel										
952.6	30.85	330	1.8	H	-65.7	1.36	0.0	-67.06	-13	54.06
952.6	32.37	5	1.3	V	-61.7	1.36	0.0	-63.06	-13	50.06
3424.80	45.02	327	1.0	H	-55.8	1.40	11.80	-45.40	-13	32.40
3424.80	44.66	175	2.2	V	-55.9	1.40	11.80	-45.50	-13	32.50
5137.20	44.37	162	2.4	H	-55.6	1.60	12.10	-45.10	-13	32.10
5137.20	45.75	149	2.3	V	-54.3	1.60	12.10	-43.80	-13	30.80
Middle channel										
953.2	31.08	12	1.4	H	-65.4	1.36	0.0	-66.76	-13	53.76
953.2	32.96	35	2.3	V	-61.1	1.36	0.0	-62.46	-13	49.46
3465.20	44.85	231	1.8	H	-55.9	1.50	12.00	-45.40	-13	32.40
3465.20	45.11	352	1.4	V	-56.4	1.50	12.00	-45.90	-13	32.90
5197.80	44.11	144	1.9	H	-56.0	1.60	12.10	-45.50	-13	32.50
5197.80	46.31	295	2.3	V	-53.3	1.60	12.10	-42.80	-13	29.80
High channel										
954.9	30.99	174	1.3	H	-65.5	1.36	0.0	-66.86	-13	53.86
954.9	32.88	181	1.0	V	-61.2	1.36	0.0	-62.56	-13	49.56
3505.20	44.10	109	1.6	H	-56.6	1.50	12.00	-46.10	-13	33.10
3505.20	44.94	146	2.3	V	-56.6	1.50	12.00	-46.10	-13	33.10
5257.80	43.91	42	1.1	H	-55.8	1.60	12.20	-45.20	-13	32.20
5257.80	46.28	281	2.5	V	-52.9	1.60	12.20	-42.30	-13	29.30

LTE Band: (Pre-scan with all the bandwidth, and worst case as below)

Frequency (MHz)	Receiver Reading (dBμV)	Turntable Angle Degree	Rx Antenna		Substituted			Absolute Level (dBm)	Limit (dBm)	Margin (dB)
			Height (m)	Polar (H/V)	Level (dBm)	Cable Loss (dB)	Antenna Gain (dBd/dBi)			
Band 2										
Test frequency range: 30 MHz ~ 20 GHz										
1.4MHz, Low channel										
961.6	30.72	193	2.2	H	-65.8	1.36	0.0	-67.16	-13	54.16
961.6	32.03	155	1.5	V	-62.0	1.36	0.0	-63.36	-13	50.36
3701.40	45.56	280	1.7	H	-56.2	1.60	11.90	-45.90	-13	32.90
3701.40	44.87	227	1.8	V	-56.4	1.60	11.90	-46.10	-13	33.10
1.4MHz, Middle channel										
961.3	30.66	322	1.9	H	-65.8	1.36	0.0	-67.16	-13	54.16
961.3	32.01	148	2.4	V	-62.0	1.36	0.0	-63.36	-13	50.36
3760.00	44.91	120	1.9	H	-57.1	1.50	11.80	-46.80	-13	33.80
3760.00	44.69	167	1.3	V	-56.9	1.50	11.80	-46.60	-13	33.60
1.4MHz, High channel										
959.6	30.62	95	2.1	H	-65.9	1.36	0.0	-67.26	-13	54.26
959.6	32.13	352	1.4	V	-61.9	1.36	0.0	-63.26	-13	50.26
3818.60	43.69	156	1.0	H	-58.4	1.50	11.80	-48.10	-13	35.10
3818.60	43.55	148	1.9	V	-58.0	1.50	11.80	-47.70	-13	34.70
Band 4										
Test frequency range:30 MHz ~ 20 GHz										
1.4MHz, Low channel										
963.1	30.65	108	1.6	H	-65.9	1.36	0.0	-67.26	-13	54.26
963.1	32.07	49	1.0	V	-62.0	1.36	0.0	-63.36	-13	50.36
3421.40	47.88	39	1.6	H	-52.9	1.40	11.80	-42.50	-13	29.50
3421.40	46.06	136	1.8	V	-54.5	1.40	11.80	-44.10	-13	31.10
1.4MHz, Middle channel										
958.6	30.64	326	1.1	H	-65.9	1.36	0.0	-67.26	-13	54.26
958.6	32.05	267	1.6	V	-62.0	1.36	0.0	-63.36	-13	50.36
3465.00	47.68	59	1.4	H	-53.1	1.50	12.00	-42.60	-13	29.60
3465.00	45.96	112	2.0	V	-55.5	1.50	12.00	-45.00	-13	32.00
1.4MHz, High channel										
959.7	30.68	63	2.0	H	-65.8	1.36	0.0	-67.16	-13	54.16
959.7	32.14	89	1.8	V	-61.9	1.36	0.0	-63.26	-13	50.26
3465.00	48.15	255	1.8	H	-52.6	1.50	12.00	-42.10	-13	29.10
3465.00	47.22	70	2.0	V	-54.3	1.50	12.00	-43.80	-13	30.80

Frequency (MHz)	Receiver Reading (dBμV)	Turntable Angle Degree	Rx Antenna		Substituted			Absolute Level (dBm)	Limit (dBm)	Margin (dB)
			Height (m)	Polar (H/V)	Level (dBm)	Cable Loss (dB)	Antenna Gain (dBd/dBi)			
Band 5										
Test frequency range:30 MHz ~ 10 GHz										
1.4MHz, Low channel										
956.8	30.73	210	1.8	H	-65.8	1.36	0.0	-67.16	-13	54.16
956.8	32.09	317	1.4	V	-62.0	1.36	0.0	-63.36	-13	50.36
1649.40	43.15	316	1.3	H	-64.9	1.40	8.70	-57.60	-13	44.60
1649.40	43.11	333	1.0	V	-64.7	1.40	8.70	-57.40	-13	44.40
2474.10	45.54	69	1.2	H	-57.8	2.60	10.20	-50.20	-13	37.20
2474.10	44.25	329	1.4	V	-58.5	2.60	10.20	-50.90	-13	37.90
3298.80	43.56	294	2.2	H	-57.3	1.50	11.70	-47.10	-13	34.10
3298.80	43.39	248	2.3	V	-57.5	1.50	11.70	-47.30	-13	34.30
1.4MHz, Middle channel										
964.7	30.71	63	2.2	H	-65.8	1.36	0.0	-67.16	-13	54.16
964.7	32.11	5	1.8	V	-61.9	1.36	0.0	-63.26	-13	50.26
1673.00	45.09	327	2.3	H	-61.2	1.30	8.90	-53.60	-13	40.60
1673.00	44.78	277	2.2	V	-61.0	1.30	8.90	-53.40	-13	40.40
2509.50	44.68	360	1.7	H	-58.7	2.60	10.20	-51.10	-13	38.10
2509.50	44.16	177	1.8	V	-58.6	2.60	10.20	-51.00	-13	38.00
3346.00	43.93	32	1.8	H	-57.0	1.50	11.70	-46.80	-13	33.80
3346.00	43.53	344	1.7	V	-57.4	1.50	11.70	-47.20	-13	34.20
1.4MHz, High channel										
961.2	30.64	215	1.7	H	-65.9	1.36	0.0	-67.26	-13	54.26
961.2	32.15	341	2.1	V	-61.9	1.36	0.0	-63.26	-13	50.26
1696.60	46.11	125	1.6	H	-60.2	1.30	8.90	-52.60	-13	39.60
1696.60	45.76	185	1.4	V	-60.0	1.30	8.90	-52.40	-13	39.40
2544.90	44.68	224	2.2	H	-58.7	2.60	10.20	-51.10	-13	38.10
2544.90	44.17	244	1.5	V	-58.6	2.60	10.20	-51.00	-13	38.00
3393.20	44.25	145	1.4	H	-57.0	1.40	11.80	-46.60	-13	33.60
3393.20	43.69	163	1.0	V	-57.4	1.40	11.80	-47.00	-13	34.00
Band 7										
Test frequency range: 30 MHz ~ 26.5 GHz										
5MHz, Low channel										
957.3	30.66	271	1.3	H	-65.8	1.36	0.0	-67.16	-25	42.16
957.3	32.12	232	2.0	V	-61.9	1.36	0.0	-63.26	-25	38.26
5005.00	45.15	156	1.4	H	-55.4	1.70	12.00	-45.10	-25	20.10
5005.00	44.75	16	1.4	V	-55.3	1.70	12.00	-45.00	-25	20.00
5MHz, Middle channel										
957.6	30.62	59	1.5	H	-65.9	1.36	0.0	-67.26	-25	42.26
951.6	32.05	347	2.0	V	-62.0	1.36	0.0	-63.36	-25	38.36
5070.00	44.86	357	1.6	H	-55.1	1.60	12.10	-44.60	-25	19.60
5070.00	44.57	297	1.9	V	-55.4	1.60	12.10	-44.90	-25	19.90
5MHz, High channel										
966.8	30.69	86	1.8	H	-65.8	1.36	0.0	-67.16	-25	42.16
966.8	32.02	32	2.2	V	-62.0	1.36	0.0	-63.36	-25	38.36
5135.00	46.35	206	1.2	H	-53.7	1.60	12.10	-43.20	-25	18.20
5135.00	46.02	314	1.2	V	-54.0	1.60	12.10	-43.50	-25	18.50

Frequency (MHz)	Receiver Reading (dBµV)	Turntable Angle Degree	Rx Antenna		Substituted			Absolute Level (dBm)	Limit (dBm)	Margin (dB)
			Height (m)	Polar (H/V)	Level (dBm)	Cable Loss (dB)	Antenna Gain (dBd/dBi)			
Band 12										
Test frequency range: 30 MHz ~10 GHz										
1.4MHz, Low channel										
962.5	30.73	301	1.2	H	-65.8	1.36	0.0	-67.16	-13	54.16
962.5	32.04	89	2.5	V	-62.0	1.36	0.0	-63.36	-13	50.36
1399.40	57.93	134	1.3	H	-50.2	1.60	7.90	-43.90	-13	30.90
1399.40	54.83	161	1.6	V	-53.6	1.60	7.90	-47.30	-13	34.30
2099.10	47.86	15	1.2	H	-53.3	1.30	9.70	-44.90	-13	31.90
2099.10	47.35	203	2.2	V	-54.6	1.30	9.70	-46.20	-13	33.20
2798.80	45.92	231	1.4	H	-58.0	1.80	10.50	-49.30	-13	36.30
2798.80	45.12	21	1.1	V	-58.5	1.80	10.50	-49.80	-13	36.80
1.4MHz, Middle channel										
961.7	30.71	308	2.2	H	-65.8	1.36	0.0	-67.16	-13	54.16
961.7	32.01	142	2.0	V	-62.0	1.36	0.0	-63.36	-13	50.36
1415.00	56.57	41	1.7	H	-51.6	1.60	7.90	-45.30	-13	32.30
1415.00	54.25	248	1.5	V	-54.2	1.60	7.90	-47.90	-13	34.90
2122.50	46.15	142	1.8	H	-55.0	1.30	9.70	-46.60	-13	33.60
2122.50	45.87	54	1.3	V	-56.1	1.30	9.70	-47.70	-13	34.70
2830.00	44.36	189	2.0	H	-59.6	1.80	10.50	-50.90	-13	37.90
2830.00	44.25	131	1.2	V	-59.4	1.80	10.50	-50.70	-13	37.70
1.4MHz, High channel										
963.6	30.67	345	1.8	H	-65.8	1.36	0.0	-67.16	-13	54.16
963.6	32.03	280	1.7	V	-62.0	1.36	0.0	-63.36	-13	50.36
1430.60	55.58	335	1.9	H	-52.6	1.60	7.90	-46.30	-13	33.30
1430.60	53.24	41	1.0	V	-55.2	1.60	7.90	-48.90	-13	35.90
2145.90	45.74	138	2.4	H	-55.4	1.30	9.70	-47.00	-13	34.00
2145.90	45.22	29	2.4	V	-56.7	1.30	9.70	-48.30	-13	35.30
2861.20	44.24	328	2.2	H	-60.4	1.70	10.70	-51.40	-13	38.40
2861.20	44.64	123	2.0	V	-60.1	1.70	10.70	-51.10	-13	38.10

Frequency (MHz)	Receiver Reading (dBµV)	Turntable Angle Degree	Rx Antenna		Substituted			Absolute Level (dBm)	Limit (dBm)	Margin (dB)
			Height (m)	Polar (H/V)	Level (dBm)	Cable Loss (dB)	Antenna Gain (dBd/dBi)			
Band 13										
Test frequency range: 30 MHz ~ 10GHz										
5MHz, Low channel										
962.3	30.75	177	2.1	H	-65.8	1.36	0.0	-67.16	-13	54.16
962.3	32.06	357	2.2	V	-62.0	1.36	0.0	-63.36	-13	50.36
1559.00	49.15	157	2.1	H	-58.9	1.40	8.70	-51.60	-40	11.60
1559.00	47.33	301	1.4	V	-60.5	1.40	8.70	-53.20	-40	13.20
2338.50	44.76	178	1.3	H	-60.5	1.30	10.00	-51.80	-13	38.80
2338.50	44.57	350	1.4	V	-60.6	1.30	10.00	-51.90	-13	38.90
3118.00	43.57	312	1.8	H	-58.0	1.70	11.30	-48.40	-13	35.40
3118.00	43.25	351	1.9	V	-58.2	1.70	11.30	-48.60	-13	35.60
5MHz, Middle channel										
959.3	30.59	287	1.2	H	-65.9	1.36	0.0	-67.26	-13	54.26
959.3	32.03	347	1.1	V	-62.0	1.36	0.0	-63.36	-13	50.36
1564.00	47.82	322	2.0	H	-60.3	1.40	8.70	-53.00	-40	13.00
1564.00	46.88	202	1.5	V	-61.0	1.40	8.70	-53.70	-40	13.70
2346.00	46.22	266	2.2	H	-59.1	1.30	10.00	-50.40	-13	37.40
2346.00	45.38	158	2.3	V	-59.8	1.30	10.00	-51.10	-13	38.10
3128.00	44.36	340	1.7	H	-57.2	1.70	11.30	-47.60	-13	34.60
3128.00	43.92	100	1.7	V	-57.5	1.70	11.30	-47.90	-13	34.90
5MHz, High channel										
960.1	30.57	306	2.3	H	-65.9	1.36	0.0	-67.26	-13	54.26
960.1	32.11	14	1.4	V	-61.9	1.36	0.0	-63.26	-13	50.26
1569.00	47.21	219	2.4	H	-60.9	1.40	8.70	-53.60	-40	13.60
1569.00	46.51	62	1.9	V	-61.3	1.40	8.70	-54.00	-40	14.00
2353.50	45.65	279	1.1	H	-58.7	2.30	10.10	-50.90	-13	37.90
2353.50	44.95	23	1.4	V	-58.4	2.30	10.10	-50.60	-13	37.60
3138.00	44.22	352	2.3	H	-57.4	1.70	11.30	-47.80	-13	34.80
3138.00	43.79	53	1.5	V	-57.7	1.70	11.30	-48.10	-13	35.10

Frequency (MHz)	Receiver Reading (dBµV)	Turntable Angle Degree	Rx Antenna		Substituted			Absolute Level (dBm)	Limit (dBm)	Margin (dB)
			Height (m)	Polar (H/V)	Level (dBm)	Cable Loss (dB)	Antenna Gain (dBd/dBi)			
Band 25										
Test frequency range: 30 MHz ~ 20GHz										
1.4MHz, Low channel										
965.3	30.62	191	1.2	H	-65.9	1.36	0.0	-67.26	-13	54.26
965.3	32.13	143	1.5	V	-61.9	1.36	0.0	-63.26	-13	50.26
3701.40	44.91	304	1.7	H	-56.9	1.60	11.90	-46.60	-13	33.60
3701.40	44.81	347	1.4	V	-56.4	1.60	11.90	-46.10	-13	33.10
1.4MHz, Middle channel										
960.6	30.58	357	2.4	H	-65.9	1.36	0.0	-67.26	-13	54.26
960.6	32.14	220	1.9	V	-61.9	1.36	0.0	-63.26	-13	50.26
3765.00	45.19	71	2.3	H	-56.9	1.50	11.80	-46.60	-13	33.60
3765.00	44.68	28	1.2	V	-56.9	1.50	11.80	-46.60	-13	33.60
1.4MHz, High channel										
965.8	30.55	173	2.2	H	-66.0	1.36	0.0	-67.36	-13	54.36
965.8	32.08	94	2.2	V	-62.0	1.36	0.0	-63.36	-13	50.36
3828.60	44.35	46	2.0	H	-57.7	1.50	11.80	-47.40	-13	34.40
3828.60	43.85	20	2.2	V	-57.7	1.50	11.80	-47.40	-13	34.40

Frequency (MHz)	Receiver Reading (dBμV)	Turntable Angle Degree	Rx Antenna		Substituted			Absolute Level (dBm)	Limit (dBm)	Margin (dB)
			Height (m)	Polar (H/V)	Level (dBm)	Cable Loss (dB)	Antenna Gain (dBd/dBi)			
Band 26										
Test frequency range: 30 MHz ~ 10GHz										
1.4MHz, Low channel										
963.2	30.63	299	1.0	H	-65.9	1.36	0.0	-67.26	-13	54.26
963.2	32.15	309	2.2	V	-61.9	1.36	0.0	-63.26	-13	50.26
1629.40	46.42	224	1.9	H	-61.7	1.40	8.70	-54.40	-13	41.40
1629.40	45.58	5	1.1	V	-62.3	1.40	8.70	-55.00	-13	42.00
2444.10	45.35	19	1.5	H	-59.0	2.30	10.10	-51.20	-13	38.20
2444.10	45.10	109	1.3	V	-58.3	2.30	10.10	-50.50	-13	37.50
3258.80	44.65	104	1.2	H	-56.2	1.50	11.70	-46.00	-13	33.00
3258.80	44.29	306	1.7	V	-56.6	1.50	11.70	-46.40	-13	33.40
1.4MHz, Middle channel										
962.1	30.62	340	2.2	H	-65.9	1.36	0.0	-67.26	-13	54.26
962.1	32.12	85	2.1	V	-61.9	1.36	0.0	-63.26	-13	50.26
1663.00	46.81	5	1.8	H	-59.5	1.30	8.90	-51.90	-13	38.90
1663.00	46.24	168	1.7	V	-59.5	1.30	8.90	-51.90	-13	38.90
2494.50	44.96	120	2.3	H	-58.4	2.60	10.20	-50.80	-13	37.80
2494.50	44.76	348	1.8	V	-58.0	2.60	10.20	-50.40	-13	37.40
3326.00	44.24	102	1.5	H	-56.7	1.50	11.70	-46.50	-13	33.50
3326.00	43.87	345	2.5	V	-57.1	1.50	11.70	-46.90	-13	33.90
1.4MHz, High channel										
966.0	30.57	85	1.6	H	-65.9	1.36	0.0	-67.26	-13	54.26
966.0	32.07	12	1.0	V	-62.0	1.36	0.0	-63.36	-13	50.36
1696.60	47.26	117	2.4	H	-59.1	1.30	8.90	-51.50	-13	38.50
1696.60	46.67	146	1.1	V	-59.1	1.30	8.90	-51.50	-13	38.50
2544.90	45.06	290	1.4	H	-58.3	2.60	10.20	-50.70	-13	37.70
2544.90	44.56	328	1.3	V	-58.2	2.60	10.20	-50.60	-13	37.60
3393.20	43.86	164	1.8	H	-57.4	1.40	11.80	-47.00	-13	34.00
3393.20	43.64	306	2.2	V	-57.4	1.40	11.80	-47.00	-13	34.00

Note:
 Absolute Level = Substituted Level - Cable loss + Antenna Gain
 Margin = Limit- Absolute Level
 dBd is for the ERP, dBi is for EIRP.

FCC § 22.917 (a), § 24.238 (a), §27.53, §90.691 - BAND EDGES

Applicable Standard

According to § 22.917(a), the power of any emissions outside of the authorized operating frequency ranges must be attenuated below the transmitting power (P) by a factor of at least $43 + 10 \log(P)$ dB.

According to §24.238(a), the power of any emissions outside of the authorized operating frequency ranges must be attenuated below the transmitting power (P) by a factor of at least $43 + 10 \log(P)$ dB.

According to FCC §27.53 (c)(h)(m), the power of any emission outside of the authorized operating frequency ranges must be attenuated below the transmitting power (P) by a factor of at least $43 + 10 \log(P)$ dB.

Test Procedure

The RF output of the transmitter was connected to the input of the spectrum analyzer through sufficient attenuation.

The center of the spectrum analyzer was set to block edge frequency

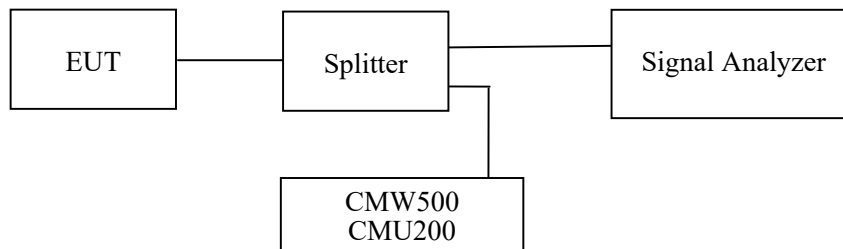

Test Data

Environmental Conditions

Temperature:	27.8~29.1 °C
Relative Humidity:	49~57 %
ATM Pressure:	100.9~101.2 kPa

The testing was performed by Pedro Yun from 2021-05-31 to 2021-09-09.

EUT operation mode: Transmitting (Worst case)

Test Result: Pass

Please refer to the following plots.

Cellular Band, Left Band Edge for GSM (GMSK) Mode

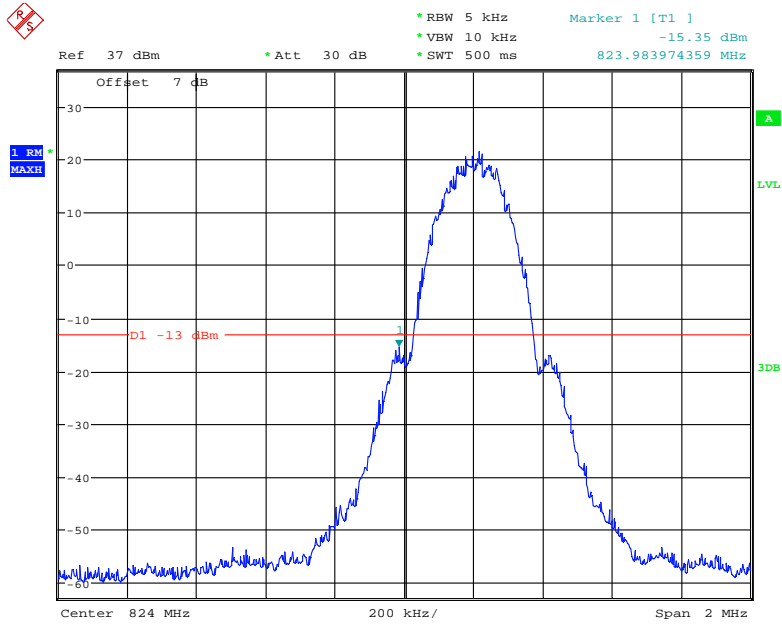

Date: 31.MAY.2021 20:39:22

Cellular Band, Right Band Edge for GSM (GMSK) Mode

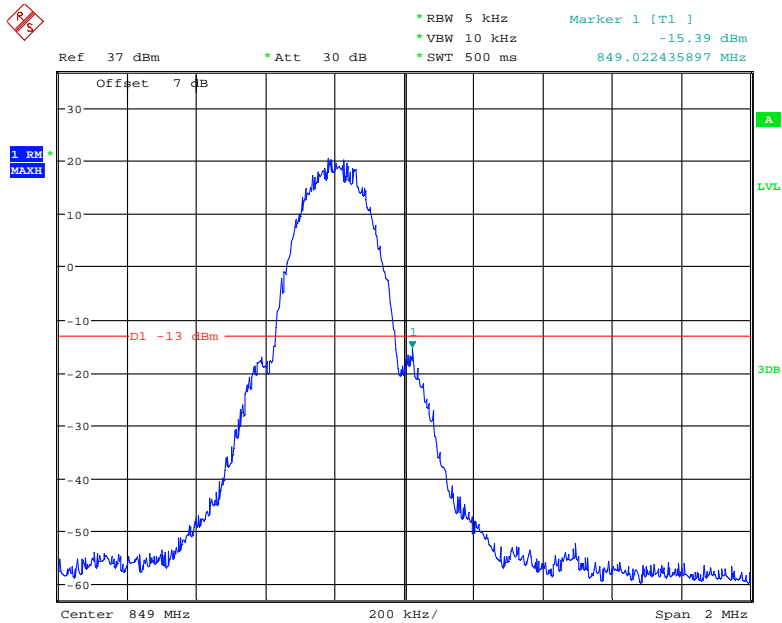

Date: 31.MAY.2021 20:38:08

Cellular Band, Left Band Edge for EGPRS (8PSK) Mode

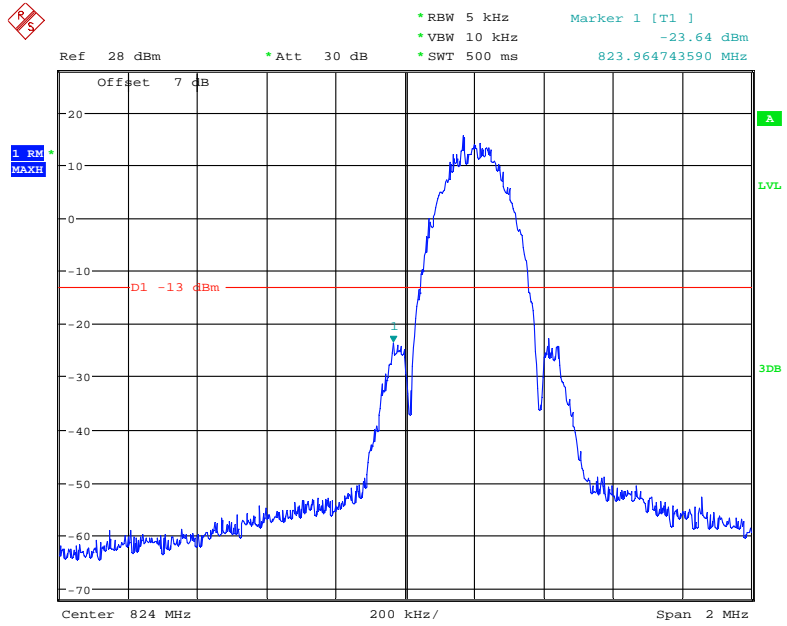

Date: 31.MAY.2021 20:59:18

Cellular Band, Right Band Edge for EGPRS (8PSK) Mode

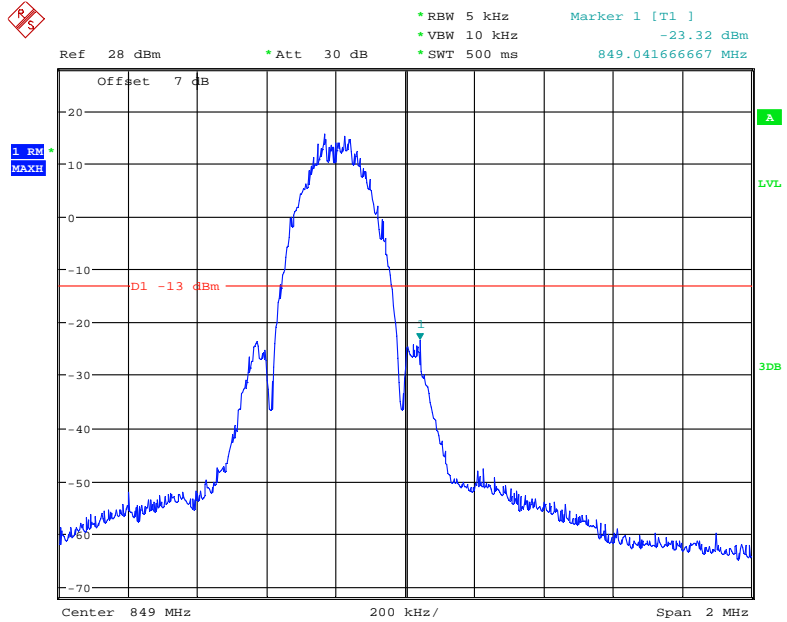

Date: 31.MAY.2021 20:58:00

Cellular Band, Left Band Edge for WCDMA (BPSK) Mode

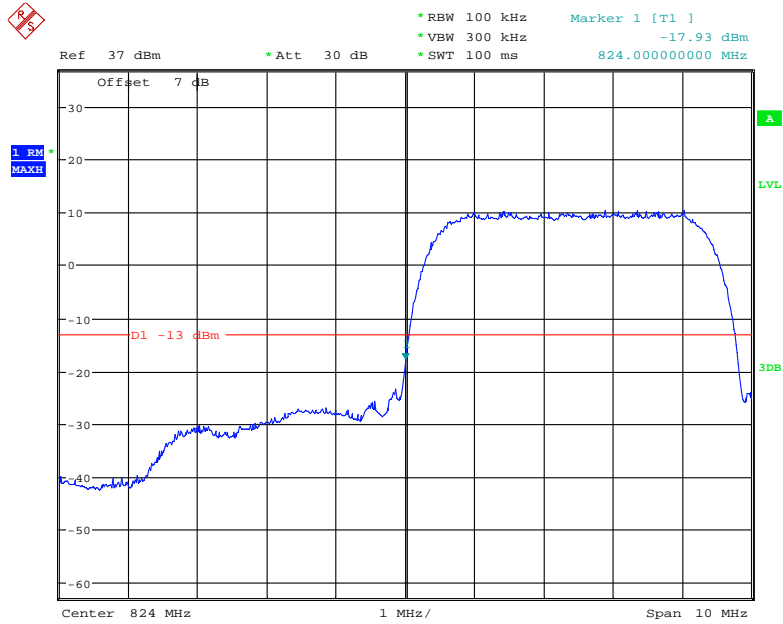

Date: 31.MAY.2021 23:22:34

Cellular Band, Right Band Edge for WCDMA (BPSK) Mode

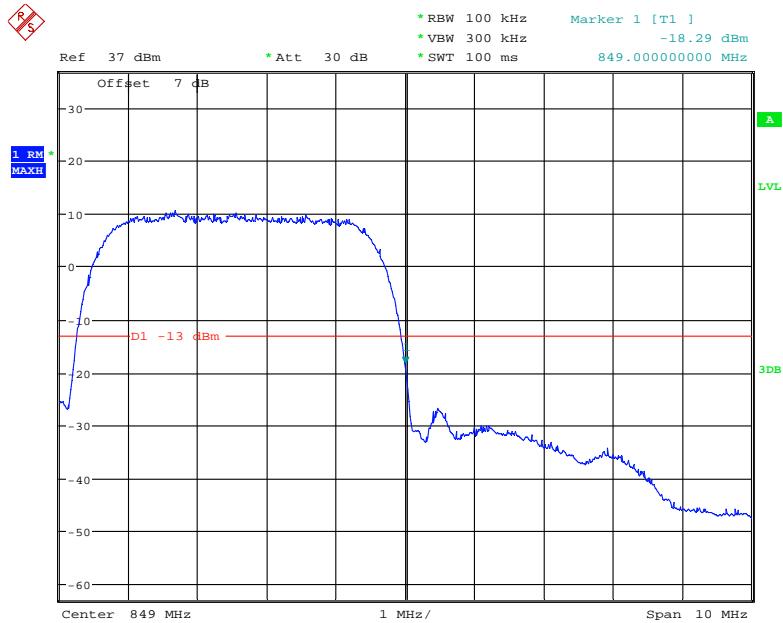

Date: 31.MAY.2021 23:21:52

Cellular Band, Left Band Edge for HSDPA (16QAM) Mode

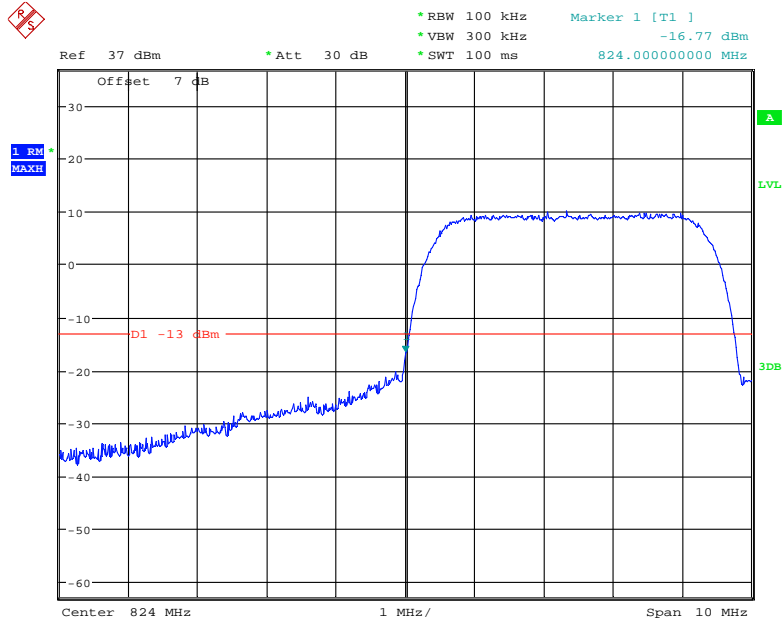

Date: 31.MAY.2021 23:42:37

Cellular Band, Right Band Edge for HSDPA (16QAM) Mode

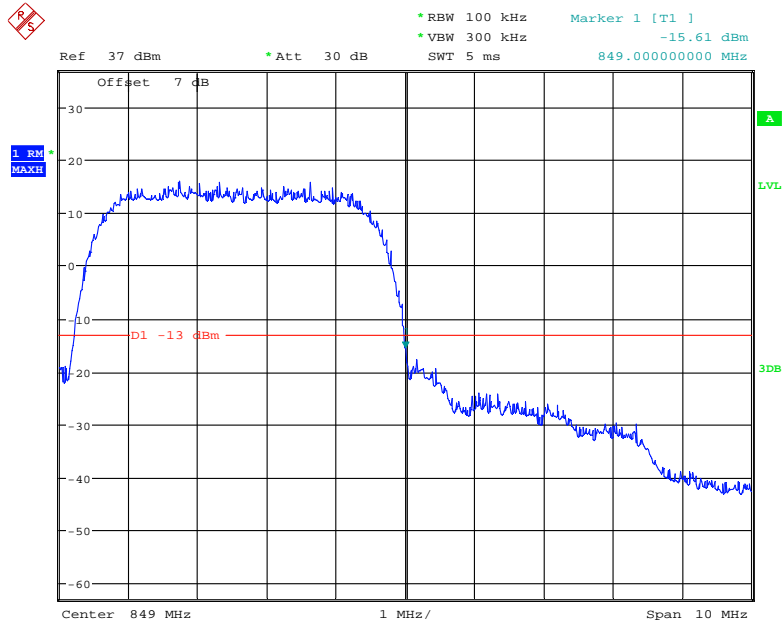

Date: 31.MAY.2021 23:41:26

Cellular Band, Left Band Edge for HSUPA (BPSK) Mode

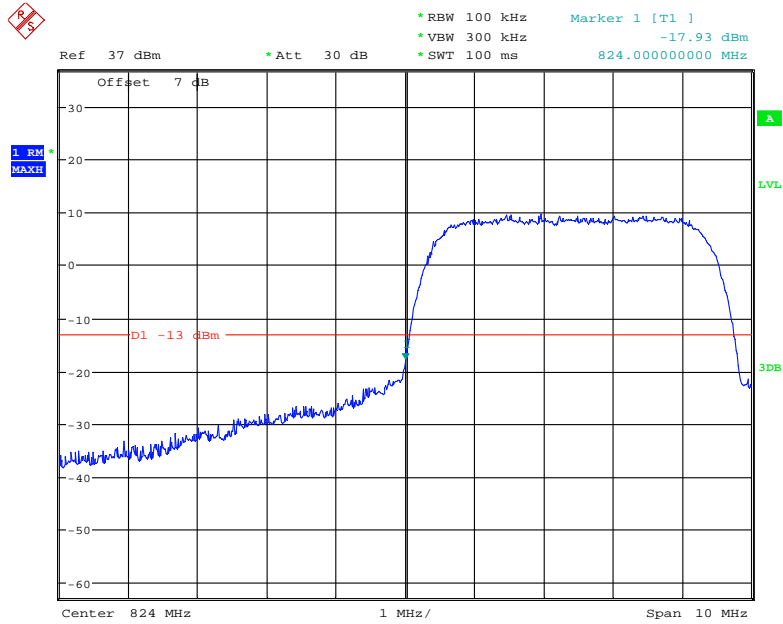

Date: 31.MAY.2021 23:44:54

Cellular Band, Right Band Edge for HSUPA (BPSK) Mode

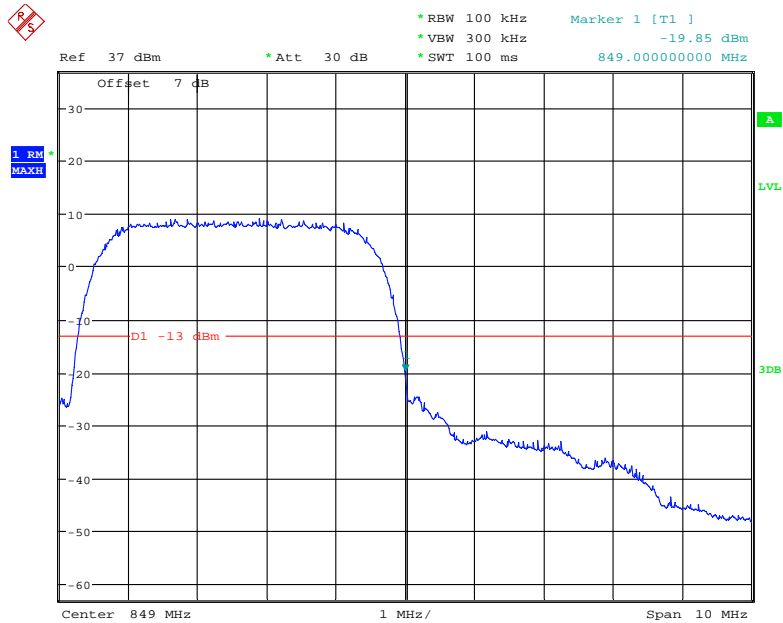

Date: 31.MAY.2021 23:45:44

PCS Band, Left Band Edge for EGPRS (8PSK) Mode

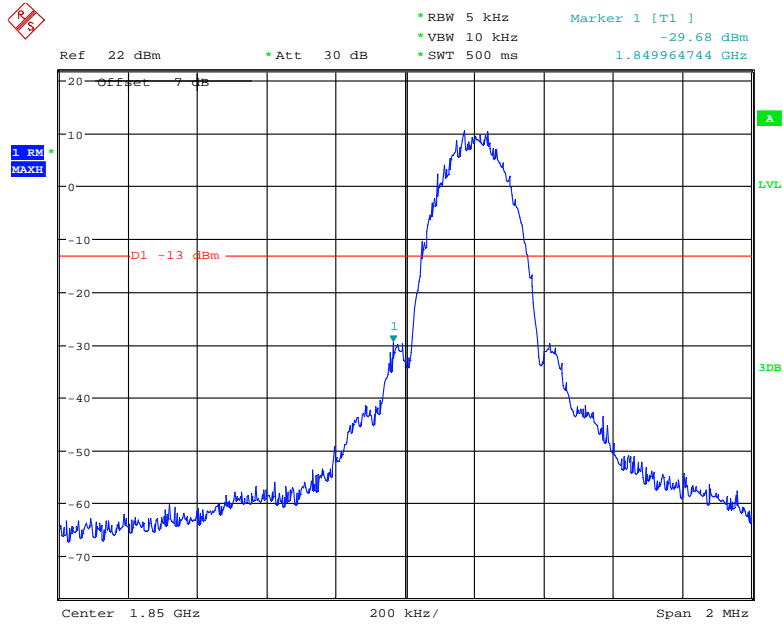

Date: 31.MAY.2021 21:55:36

PCS Band, Right Band Edge for EGPRS (8PSK) Mode

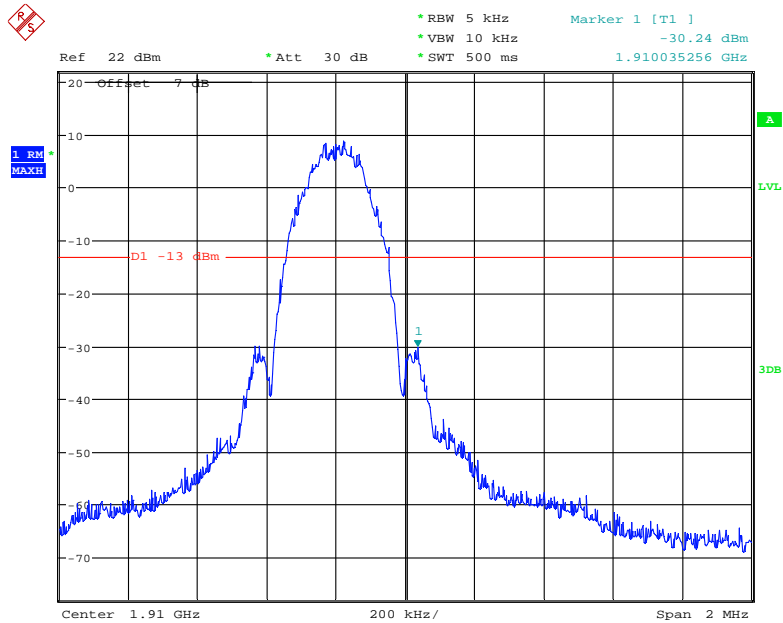

Date: 31.MAY.2021 21:53:45

PCS Band, Left Band Edge for WCDMA (BPSK) Mode

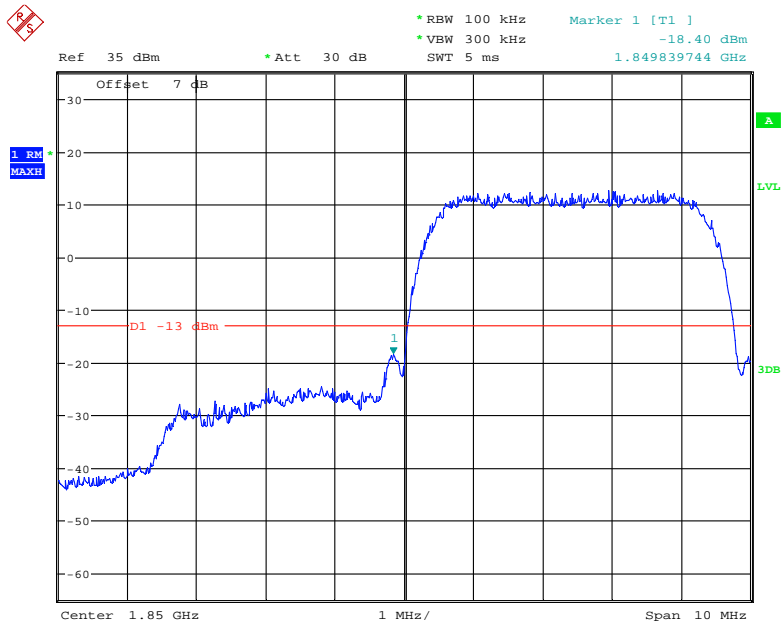

Date: 31.MAY.2021 23:00:26

PCS Band, Right Band Edge for WCDMA (BPSK) Mode

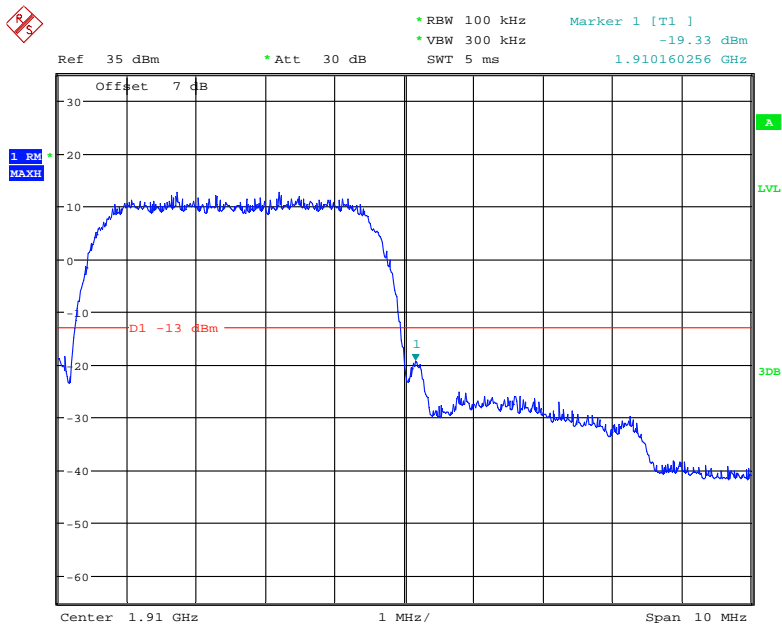

Date: 31.MAY.2021 22:59:14

PCS Band, Left Band Edge for HSDPA (16QAM) Mode

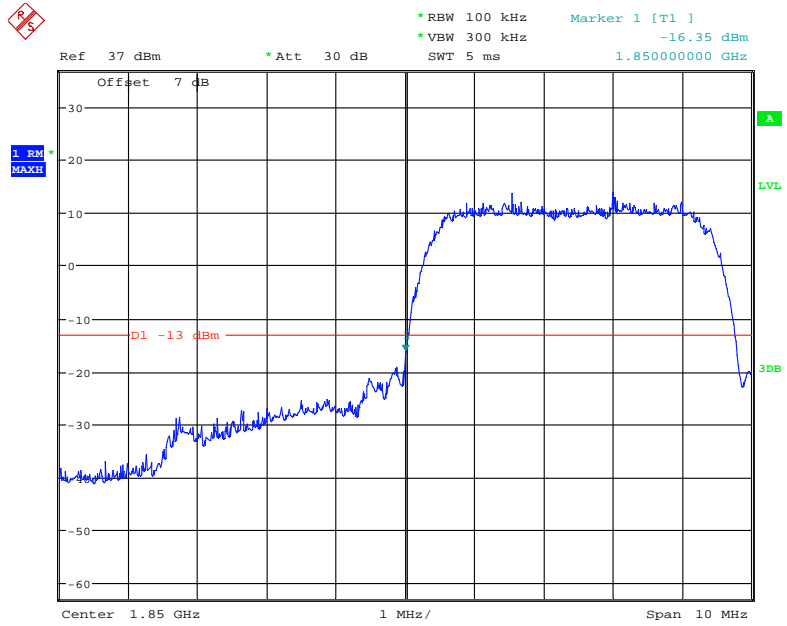

Date: 31.MAY.2021 23:25:30

PCS Band, Right Band Edge for HSDPA (16QAM) Mode

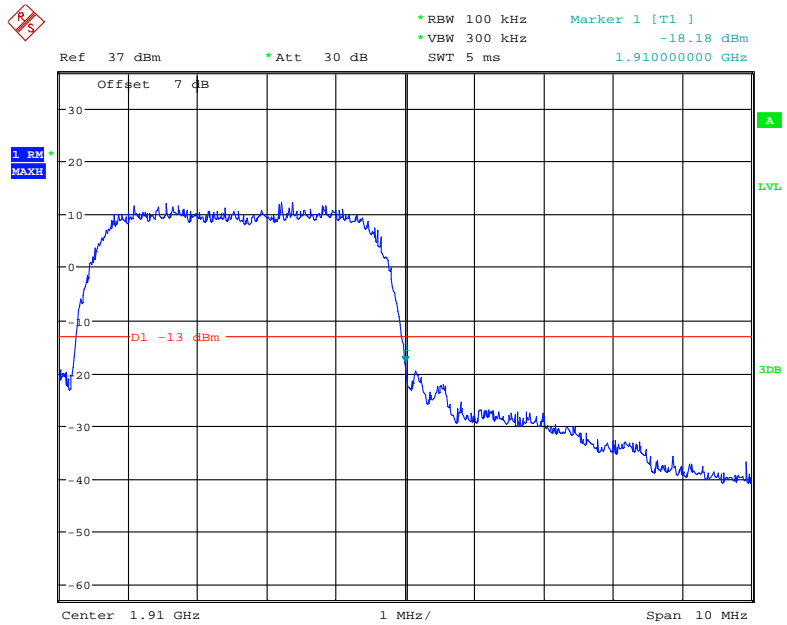

Date: 31.MAY.2021 23:26:56

PCS Band, Left Band Edge for HSUPA (BPSK) Mode

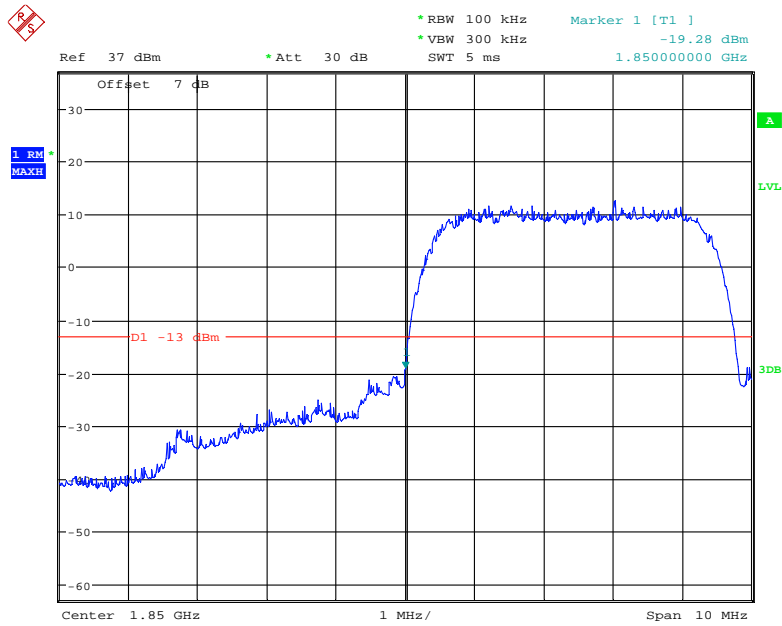

Date: 31.MAY.2021 23:59:08

PCS Band, Right Band Edge for HSUPA (BPSK) Mode

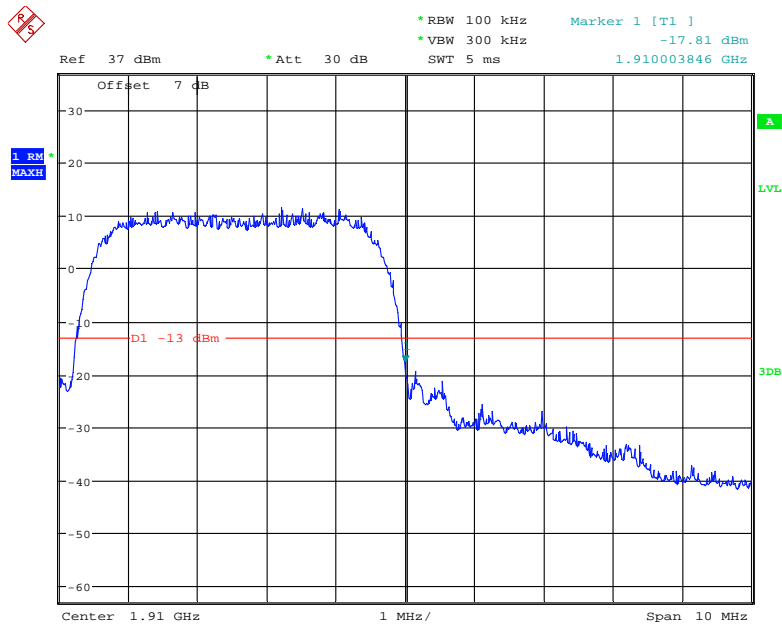

Date: 31.MAY.2021 23:58:04

AWS Band, Left Band Edge for WCDMA (BPSK) Mode

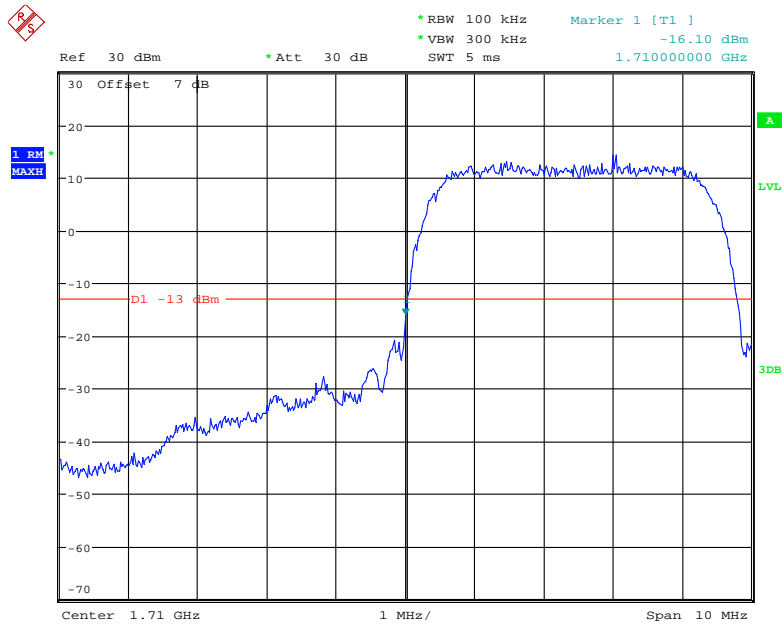

Date: 11.JUL.2021 15:29:15

AWS Band, Right Band Edge for WCDMA (BPSK) Mode

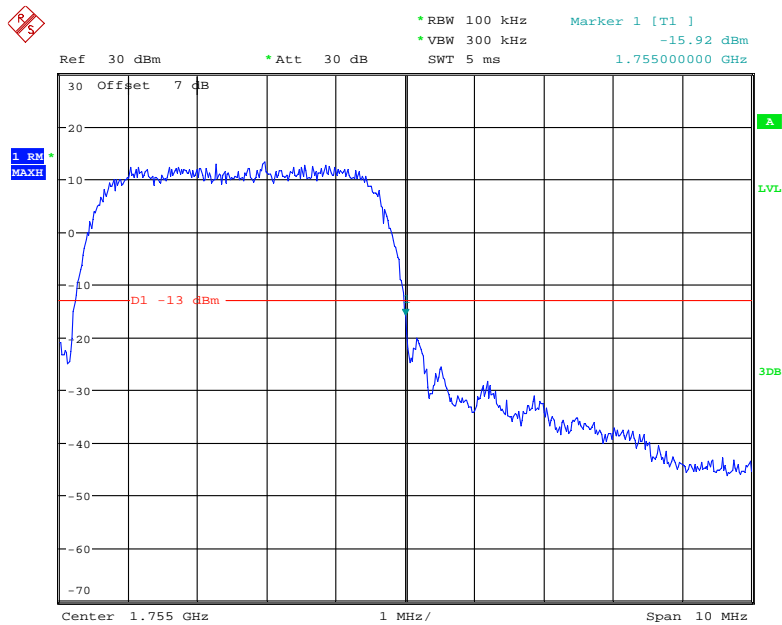

Date: 11.JUL.2021 15:30:19

AWS Band, Left Band Edge for HSDPA (16QAM) Mode

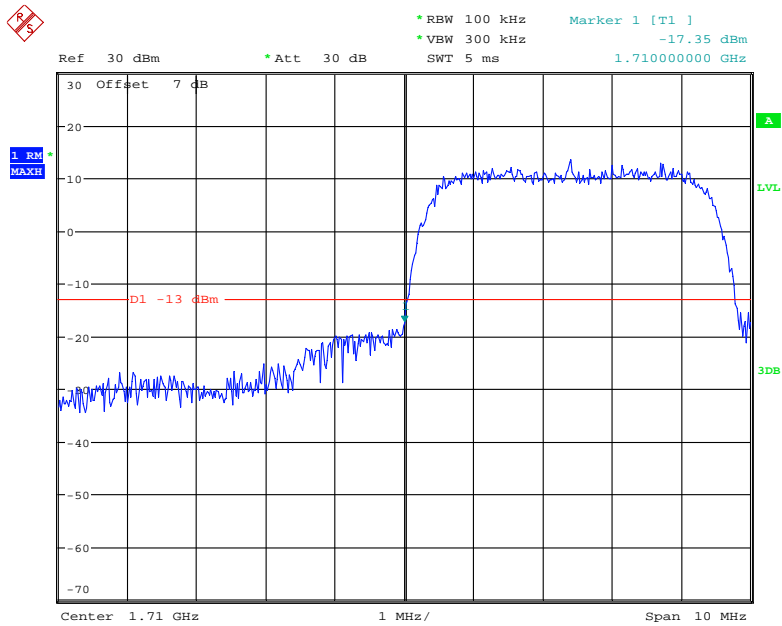

Date: 11.JUL.2021 15:51:17

AWS Band, Right Band Edge for HSDPA (16QAM) Mode

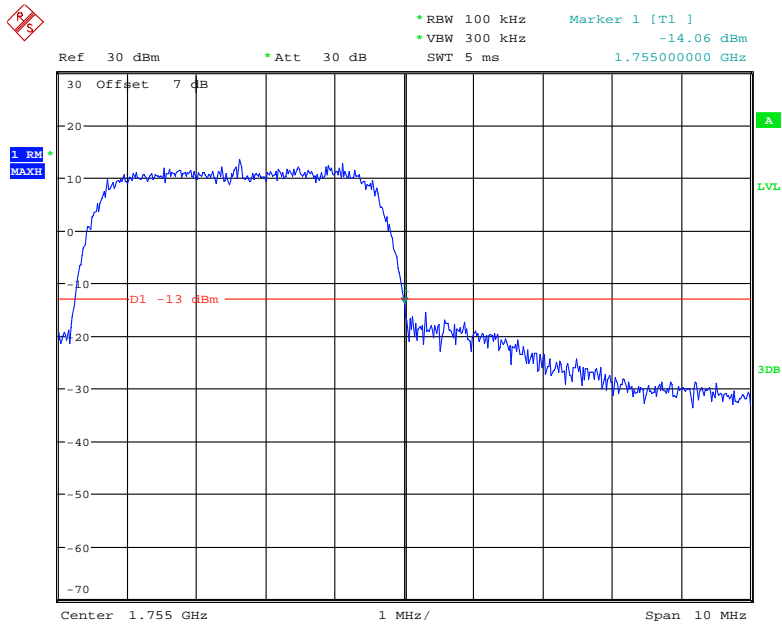

Date: 11.JUL.2021 15:53:00

AWS Band, Left Band Edge for HSUPA (BPSK) Mode

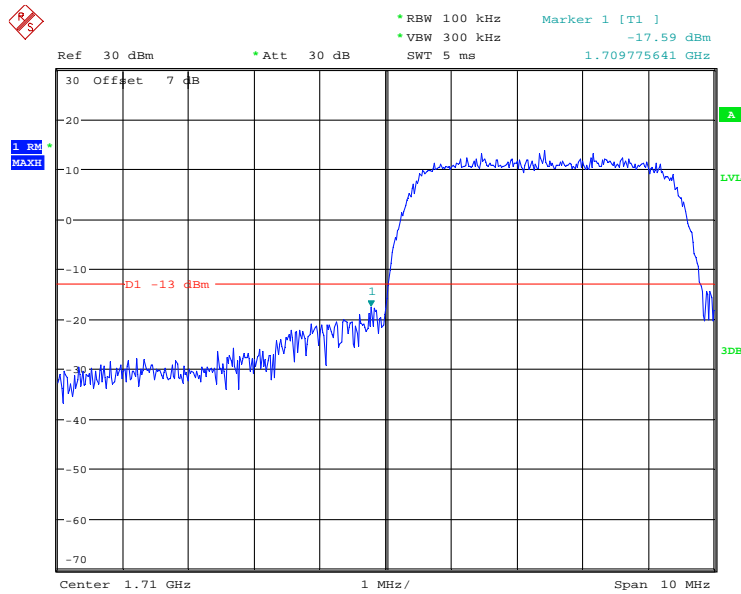

Date: 11.JUL.2021 15:56:36

AWS Band, Right Band Edge for HSUPA (BPSK) Mode

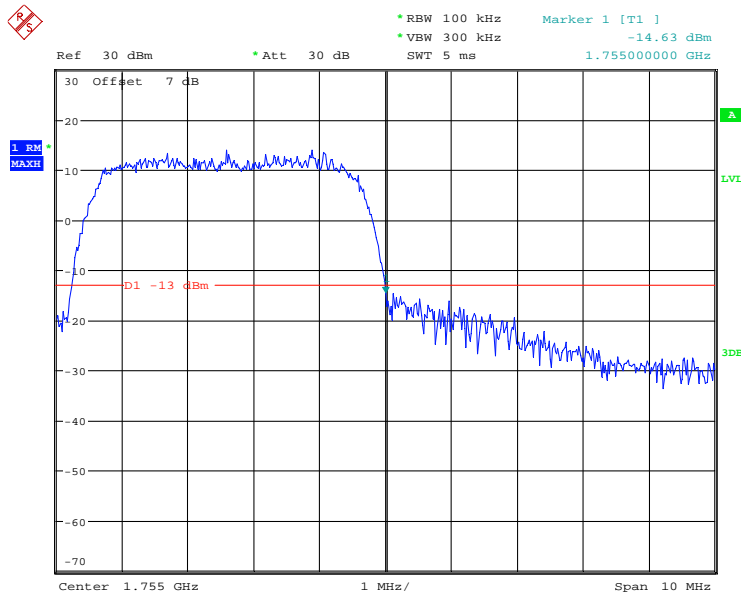

Date: 11.JUL.2021 15:55:18

The test plots of LTE bands please refer to the Appendix C.

FCC § 2.1055, § 22.355, § 24.235, §27.54, §90.213- FREQUENCY STABILITY

Applicable Standard

FCC § 2.1055, §22.355, §24.235, §27.54 and §90.213.

According to FCC §2.1055, the frequency stability shall be sufficient to ensure that the fundamental emissions stay within the authorized bands of operation.

According to §22.355, the carrier frequency of each transmitter in the Public Mobile Services must be maintained within the tolerances given in Table below:

Frequency Tolerance for Transmitters in the Public Mobile Services

Frequency Range (MHz)	Base, fixed (ppm)	Mobile ≤ 3 watts (ppm)	Mobile > 3 watts (ppm)
25 to 50	20.0	20.0	50.0
50 to 450	5.0	5.0	50.0
450 to 512	2.5	5.0	5.0
821 to 896	1.5	2.5	2.5
928 to 929.	5.0	N/A	N/A
929 to 960.	1.5	N/A	N/A
2110 to 2220	10.0	N/A	N/A

According to §24.235, the frequency stability shall be sufficient to ensure that the fundamental emissions stays within the authorized frequency block.

Test Procedure

Frequency Stability vs. Temperature: The equipment under test was connected to an external DC power supply and the RF output was connected to communication test set via feed-through attenuators. The EUT was placed inside the temperature chamber. The DC leads and RF output cable exited the chamber through an opening made for the purpose.

After the temperature stabilized for approximately 20 minutes, the frequency output was recorded from the communication test set.

Frequency Stability vs. Voltage: For hand carried, battery powered equipment; reduce primary supply voltage to the battery operating end point which shall be specified by the manufacturer.

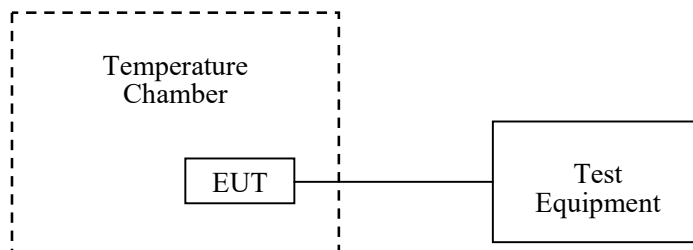

Test Data

Environmental Conditions

Temperature:	27.8~29.1 °C
Relative Humidity:	49~57 %
ATM Pressure:	100.9~101.2 kPa

The testing was performed by Pedro Yun from 2021-05-31 to 2021-07-18.

EUT operation mode: Transmitting

Test Result: Pass

Please refer to the following tables.

Cellular Band (Part 22H)

GPRS Mode

Middle Channel, $f_0 = 836.6\text{MHz}$				
Temperature (°C)	Voltage Supplied (V _{DC})	Frequency Error (Hz)	Frequency Error (ppm)	Limit (ppm)
-30	3.85	5	0.0060	2.5
-20		4	0.0048	2.5
-10		4	0.0048	2.5
0		3	0.0036	2.5
10		2	0.0024	2.5
20		1	0.0012	2.5
30		2	0.0024	2.5
40		3	0.0036	2.5
50		4	0.0048	2.5
20		3.30	3	0.0036
	4.40	5	0.0060	2.5

EDGE Mode

Middle Channel, $f_0=836.6\text{MHz}$				
Temperature (°C)	Voltage Supplied (V _{DC})	Frequency Error (Hz)	Frequency Error (ppm)	Limit (ppm)
-30	3.85	3	0.0036	2.5
-20		4	0.0048	2.5
-10		6	0.0072	2.5
0		5	0.0060	2.5
10		4	0.0048	2.5
20		6	0.0072	2.5
30		4	0.0048	2.5
40		2	0.0024	2.5
50		4	0.0048	2.5
20	3.30	7	0.0084	2.5
	4.40	8	0.0096	2.5

WCDMA Mode

Middle Channel, $f_0=836.6\text{MHz}$				
Temperature (°C)	Voltage Supplied (V _{DC})	Frequency Error (Hz)	Frequency Error (ppm)	Limit (ppm)
-30	3.85	5	0.0060	2.5
-20		4	0.0048	2.5
-10		7	0.0084	2.5
0		9	0.0108	2.5
10		8	0.0096	2.5
20		4	0.0048	2.5
30		6	0.0072	2.5
40		5	0.0060	2.5
50		3	0.0036	2.5
20	3.30	9	0.0108	2.5
	4.40	5	0.0060	2.5

PCS Band (Part 24E)

GPRS Mode

Middle Channel, $f_0=1880.0$ MHz				
Temperature (°C)	Voltage Supplied (V _{DC})	Frequency Error (Hz)	Frequency Error (ppm)	Result
-30	3.85	4	0.0021	Pass
-20		5	0.0027	Pass
-10		7	0.0037	Pass
0		3	0.0016	Pass
10		2	0.0011	Pass
20		4	0.0021	Pass
30		5	0.0027	Pass
40		7	0.0037	Pass
50		3	0.0016	Pass
20	3.30	4	0.0021	Pass
	4.40	3	0.0016	Pass

EDGE Mode

Middle Channel, $f_0=1880.0$ MHz				
Temperature (°C)	Voltage Supplied (V _{DC})	Frequency Error (Hz)	Frequency Error (ppm)	Result
-30	3.85	8	0.0043	Pass
-20		5	0.0027	Pass
-10		4	0.0021	Pass
0		6	0.0032	Pass
10		5	0.0027	Pass
20		3	0.0016	Pass
30		4	0.0021	Pass
40		6	0.0032	Pass
50		3	0.0016	Pass
20	3.30	4	0.0021	Pass
	4.40	7	0.0037	Pass

PCS Band (Part 24E)

WCDMA Mode

Middle Channel, $f_0 = 1880.0$ MHz				
Temperature (°C)	Voltage Supplied (V _{DC})	Frequency Error (Hz)	Frequency Error (ppm)	Result
-30	3.85	-2	-0.0011	Pass
-20		-1	-0.0005	Pass
-10		2	0.0011	Pass
0		4	0.0021	Pass
10		5	0.0027	Pass
20		-2	-0.0011	Pass
30		-2	-0.0011	Pass
40		-4	-0.0021	Pass
50		-5	-0.0027	Pass
20		3.30	-2	-0.0011
	4.40	-3	-0.0016	Pass

AWS Band (Part 27)

Temperature (°C)	Power Supplied (V _{DC})	F _L (MHz)	F _H (MHz)	F _L Limit (MHz)	F _H Limit (MHz)
-30	3.85	1710.1299	1754.0589	1710	1755
-20		1710.2115	1754.4478	1710	1755
-10		1710.0395	1754.0403	1710	1755
0		1710.0769	1754.0126	1710	1755
10		1710.2699	1754.0719	1710	1755
20		1710.1809	1754.0215	1710	1755
30		1710.0687	1754.2730	1710	1755
40		1710.0173	1754.0065	1710	1755
50		1710.0295	1754.3449	1710	1755
20		3.30	1710.0005	1754.0807	1710
	4.40	1710.0691	1754.0566	1710	1755

LTE:

QPSK:

Band 2:

10.0 MHz Middle Channel, $f_0=1880\text{MHz}$				
Temperature (°C)	Voltage Supplied (V _{DC})	Frequency Error (Hz)	Frequency Error (ppm)	Result
-30	3.85	-5.69	-0.0030	Pass
-20		-9.97	-0.0053	Pass
-10		-6.12	-0.0033	Pass
0		6.15	0.0033	Pass
10		7.88	0.0042	Pass
20		6.54	0.0035	Pass
30		-6.46	-0.0034	Pass
40		7.18	0.0038	Pass
50		-9.61	-0.0051	Pass
20		3.30	-8.13	-0.0043
	4.40	-7.08	-0.0038	Pass

Band 4:

10 MHz Bandwidth, $f_0=1732.5\text{MHz}$					
Temperature (°C)	Power Supplied (V _{DC})	F _L (MHz)	F _H (MHz)	F _L Limit (MHz)	F _H Limit (MHz)
-30	3.85	1710.5018	1754.5865	1710	1755
-20		1710.2690	1754.5195	1710	1755
-10		1710.3975	1754.5281	1710	1755
0		1710.1224	1754.6900	1710	1755
10		1710.5100	1754.7475	1710	1755
20		1710.3811	1754.4755	1710	1755
30		1710.1447	1754.5536	1710	1755
40		1710.5071	1754.5129	1710	1755
50		1710.3607	1754.8362	1710	1755
20		3.30	1710.3998	1754.6197	1710
	4.40	1710.2446	1754.8029	1710	1755

Band 5:

10.0 MHz Middle Channel, $f_0 = 836.5\text{MHz}$				
Temperature (°C)	Voltage Supplied (V _{DC})	Frequency Error (Hz)	Frequency Error (ppm)	Limit (ppm)
-30	3.85	-8.95	-0.0107	2.5
-20		9.18	0.0110	2.5
-10		8.52	0.0102	2.5
0		-7.13	-0.0085	2.5
10		-5.18	-0.0062	2.5
20		7.16	0.0086	2.5
30		-5.79	-0.0069	2.5
40		5.44	0.0065	2.5
50		6.81	0.0081	2.5
20	3.30	9.76	0.0117	2.5
	4.40	9.82	0.0117	2.5

Band 7:

10 MHz Bandwidth, $f_0 = 2535\text{MHz}$					
Temperature (°C)	Power Supplied (V _{DC})	F _L (MHz)	F _H (MHz)	F _L Limit (MHz)	F _H Limit (MHz)
-30	3.85	2500.4632	2569.3974	2500	2570
-20		2500.3828	2569.3787	2500	2570
-10		2500.4729	2569.5763	2500	2570
0		2500.5172	2569.5383	2500	2570
10		2500.4325	2569.6837	2500	2570
20		2500.4504	2569.5244	2500	2570
30		2500.3489	2569.3272	2500	2570
40		2500.4419	2569.7474	2500	2570
50		2500.5695	2569.5820	2500	2570
20	3.30	2500.5758	2569.3541	2500	2570
	4.40	2500.2450	2569.3867	2500	2570

Band 12:

10 MHz Bandwidth, $f_0=707.5\text{MHz}$					
Temperature (°C)	Power Supplied (V _{DC})	F _L (MHz)	F _H (MHz)	F _L Limit (MHz)	F _H Limit (MHz)
-30	3.85	699.3574	715.4855	699	716
-20		699.4761	715.3139	699	716
-10		699.4721	715.5749	699	716
0		699.6540	715.3827	699	716
10		699.3429	715.5495	699	716
20		699.4813	715.5285	699	716
30		699.4049	715.4683	699	716
40		699.5542	715.6852	699	716
50		699.7046	715.5114	699	716
20	3.30	699.5078	715.5490	699	716
	4.40	699.3438	715.4073	699	716

Band 13

10 MHz Bandwidth, $f_0=782\text{MHz}$					
Temperature (°C)	Power Supplied (V _{DC})	F _L (MHz)	F _H (MHz)	F _L Limit (MHz)	F _H Limit (MHz)
-30	3.85	777.3306	786.7888	777	787
-20		777.1310	786.7135	777	787
-10		777.3385	786.6096	777	787
0		777.4584	786.5436	777	787
10		777.1081	786.8073	777	787
20		777.3772	786.6208	777	787
30		777.5911	786.5590	777	787
40		777.1842	786.7541	777	787
50		777.3870	786.4579	777	787
20	3.30	777.0865	786.4739	777	787
	4.40	777.3511	786.7137	777	787

Band 25

10.0 MHz Middle Channel, $f_0=1882.5\text{MHz}$				
Temperature (°C)	Voltage Supplied (V _{DC})	Frequency Error (Hz)	Frequency Error (ppm)	Result
-30	3.85	-6	-0.0032	Pass
-20		-4	-0.0021	Pass
-10		5	0.0027	Pass
0		-4	-0.0021	Pass
10		7	0.0037	Pass
20		-6	-0.0032	Pass
30		-7	-0.0037	Pass
40		-4	-0.0021	Pass
50		8	0.0042	Pass
20		3.30	9	0.0048
	4.40	9	0.0048	Pass

Band 26

10.0 MHz Middle Channel, $f_0=831.5\text{MHz}$				
Temperature (°C)	Voltage Supplied (V _{DC})	Frequency Error (Hz)	Frequency Error (ppm)	Result (ppm)
-30	3.85	5	0.0060	2.5
-20		6	0.0072	2.5
-10		3	0.0036	2.5
0		4	0.0048	2.5
10		7	0.0084	2.5
20		8	0.0096	2.5
30		6	0.0072	2.5
40		5	0.0060	2.5
50		7	0.0084	2.5
20		3.30	6	0.0072
	4.40	6	0.0072	2.5

16QAM:

Band 2:

10.0 MHz Middle Channel, $f_0 = 1880\text{MHz}$				
Temperature (°C)	Voltage Supplied (V _{DC})	Frequency Error (Hz)	Frequency Error (ppm)	Result
-30	3.85	-7	-0.0037	Pass
-20		-6	-0.0032	Pass
-10		13	0.0069	Pass
0		-4	-0.0021	Pass
10		7	0.0037	Pass
20		-8	-0.0043	Pass
30		-6	-0.0032	Pass
40		-4	-0.0021	Pass
50		11	0.0059	Pass
20		3.30	12	0.0064
	4.40	11	0.0059	Pass

Band 4:

10 MHz Bandwidth, $f_0 = 1732.5\text{MHz}$					
Temperature (°C)	Power Supplied (V _{DC})	F _L (MHz)	F _H (MHz)	F _L Limit (MHz)	F _H Limit (MHz)
-30	3.85	1710.1120	1754.4730	1710	1755
-20		1710.2486	1754.4962	1710	1755
-10		1710.5072	1754.5642	1710	1755
0		1710.3323	1754.5314	1710	1755
10		1710.5157	1754.7054	1710	1755
20		1710.2001	1754.4619	1710	1755
30		1710.4567	1754.6709	1710	1755
40		1710.5458	1754.6050	1710	1755
50		1710.5334	1754.5225	1710	1755
20		3.30	1710.2410	1754.8227	1710
	4.40	1710.6141	1754.2941	1710	1755

Band 5:

10.0 MHz Middle Channel, $f_0=836.5\text{MHz}$				
Temperature (°C)	Voltage Supplied (V _{DC})	Frequency Error (Hz)	Frequency Error (ppm)	Limit (ppm)
-30	3.85	-3.65	-0.0044	2.5
-20		6.89	0.0082	2.5
-10		-9.58	-0.0115	2.5
0		-8.27	-0.0099	2.5
10		-8.99	-0.0107	2.5
20		-9.65	-0.0115	2.5
30		8.35	0.0100	2.5
40		6.74	0.0081	2.5
50		-5.81	-0.0069	2.5
20	3.30	8.96	0.0107	2.5
	4.40	-7.82	-0.0093	2.5

Band 7:

10 MHz Bandwidth, $f_0=2535\text{MHz}$					
Temperature (°C)	Power Supplied (V _{DC})	F _L (MHz)	F _H (MHz)	F _L Limit (MHz)	F _H Limit (MHz)
-30	3.85	2500.4226	2569.2523	2500	2570
-20		2500.5590	2569.4601	2500	2570
-10		2500.5102	2569.5386	2500	2570
0		2500.5239	2569.7384	2500	2570
10		2500.6042	2569.5958	2500	2570
20		2500.5036	2569.4579	2500	2570
30		2500.7131	2569.7106	2500	2570
40		2500.2602	2569.3949	2500	2570
50		2500.5292	2569.6490	2500	2570
20	3.30	2500.6017	2569.4746	2500	2570
	4.40	2500.2839	2569.5394	2500	2570

Band 12:

10 MHz Bandwidth, $f_0=707.5\text{MHz}$					
Temperature (°C)	Power Supplied (V _{DC})	F _L (MHz)	F _H (MHz)	F _L Limit (MHz)	F _H Limit (MHz)
-30	3.85	699.5643	715.6196	699	716
-20		699.6579	715.6372	699	716
-10		699.4721	715.5749	699	716
0		699.5295	715.5386	699	716
10		699.3076	715.4976	699	716
20		699.6001	715.6400	699	716
30		699.4467	715.4731	699	716
40		699.6534	715.6194	699	716
50		699.2846	715.4655	699	716
20		3.30	699.3369	715.3518	699
	4.40	699.2981	715.7299	699	716

Band 13

10 MHz Bandwidth, $f_0=782\text{MHz}$					
Temperature (°C)	Power Supplied (V _{DC})	F _L (MHz)	F _H (MHz)	F _L Limit (MHz)	F _H Limit (MHz)
-30	3.85	777.6387	786.6647	777	787
-20		777.2897	786.6883	777	787
-10		777.3385	786.6096	777	787
0		777.1132	786.4805	777	787
10		777.2021	786.5445	777	787
20		777.4342	786.7262	777	787
30		777.2594	786.6147	777	787
40		777.1940	786.6515	777	787
50		777.2898	786.6759	777	787
20		3.30	777.5546	786.7750	777
	4.40	777.3978	786.8093	777	787

Band 25

10.0 MHz Middle Channel, $f_0=1882.5\text{MHz}$				
Temperature (°C)	Voltage Supplied (V _{DC})	Frequency Error (Hz)	Frequency Error (ppm)	Result
-30	3.85	6	0.0032	Pass
-20		5	0.0027	Pass
-10		-4	-0.0021	Pass
0		-5	-0.0027	Pass
10		8	0.0042	Pass
20		6	0.0032	Pass
30		5	0.0027	Pass
40		-6	-0.0032	Pass
50		8	0.0042	Pass
20		3.30	10	0.0053
	4.40	10	0.0053	Pass

Band 26

10.0 MHz Middle Channel, $f_0=831.5\text{MHz}$				
Temperature (°C)	Voltage Supplied (V _{DC})	Frequency Error (Hz)	Frequency Error (ppm)	Result (ppm)
-30	3.85	8	0.0096	2.5
-20		7	0.0084	2.5
-10		9	0.0108	2.5
0		10	0.0120	2.5
10		11	0.0132	2.5
20		9	0.0108	2.5
30		8	0.0096	2.5
40		6	0.0072	2.5
50		8	0.0096	2.5
20		3.30	9	0.0108
	4.40	9	0.0108	2.5

***** END OF REPORT *****