

Test Mode: 09; Polarity: Horizontal; Modulation:802.11n; Bandwidth:20MHz; Channel:High

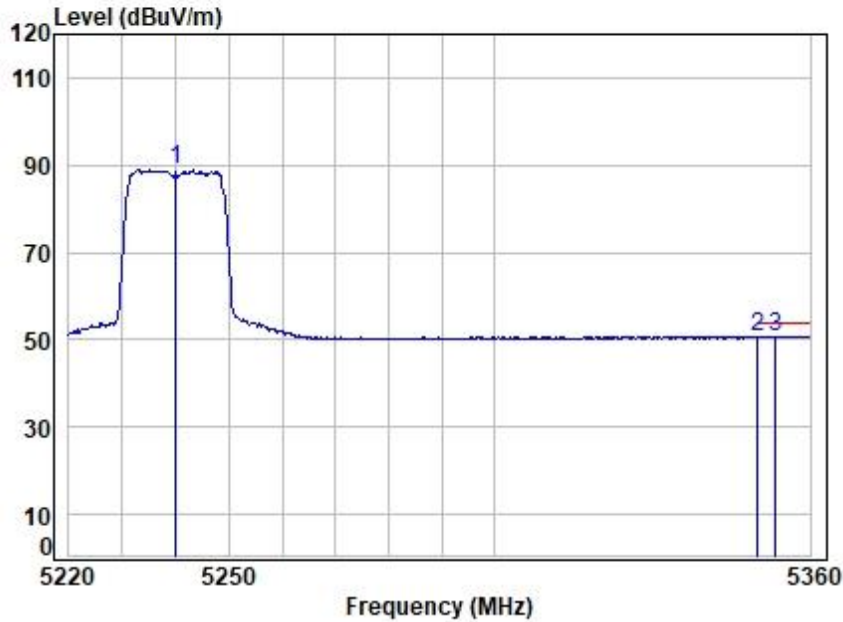

Site : chamber
 Condition: 3m HORIZONTAL
 Job No : 00466AT
 Mode : 5240 Band edge
 : 5G WIFI 11N20

	Freq	Cable Loss	Ant Factor	Preamp Factor	Read Level	Level	Limit Line	Over Limit	Remark
	MHz	dB	dB/m	dB	dBuV	dBuV/m	dBuV/m	dB	
1	5240.000	8.29	31.99	31.94	80.69	89.03	-----	-----	Average
2	5350.020	8.28	32.25	32.10	42.25	50.68	54.00	-3.32	Average
3	5353.337	8.28	32.26	32.10	42.32	50.76	54.00	-3.24	Average



Unless otherwise agreed in writing, this document is issued by the Company subject to its General Conditions of Service printed overleaf, available on request or accessible at <http://www.sgs.com/en/Terms-and-Conditions.aspx> and, for electronic format documents, subject to Terms and Conditions for Electronic Documents at <http://www.sgs.com/en/Terms-and-Conditions/Terms-e-Documents.aspx>. Attention is drawn to the limitation of liability, indemnification and jurisdiction issues defined therein. Any holder of this document is advised that information contained hereon reflects the Company's findings at the time of its intervention only and within the limits of Client's instructions, if any. The Company's sole responsibility is to its Client and this document does not exonerate parties to a transaction from exercising all their rights and obligations under the transaction documents. This document cannot be reproduced except in full, without prior written approval of the Company. Any unauthorized alteration, forgery or falsification of the content or appearance of this document is unlawful and offenders may be prosecuted to the fullest extent of the law. Unless otherwise stated the results shown in this test report refer only to the sample(s) tested and such sample(s) are retained for 30 days only.
Attention: To check the authenticity of testing /inspection report & certificate, please contact us at telephone: (86-755) 8307 1443, or email: CN.Doccheck@sgs.com

Fuyong lab, Xinlong TechnoPark, Fengtang Road, Fuyong Subdistrict, Bao'an, Shenzhen, China 518103 t (86-755) 88663988 f (86-755) 26710594 www.sgs.com.cn
 中国·深圳·宝安区福永街道凤塘大道鑫龙科技园福永实验室 邮编: 518103 t (86-755) 88663988 f (86-755) 26710594 sgs.china@sgs.com

Compliance Certification Services (Kunshan) Inc. Shenzhen Branch

SZCCS-TRF-01 Rev. A/0 Aug01,2022

Report No.: FYCR221100046605

Page: 100 of 344

Test Mode: 09; Polarity: Vertical; Modulation:802.11n; Bandwidth:20MHz; Channel:High

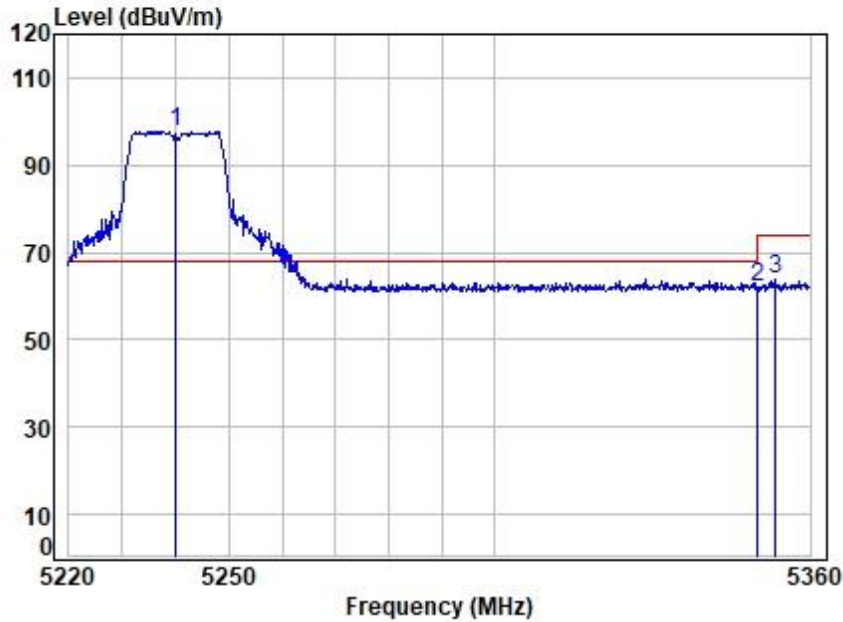

Site : chamber
 Condition: 3m VERTICAL
 Job No : 00466AT
 Mode : 5240 Band edge
 : 5G WIFI 11N20

	Freq	Cable Loss	Ant Factor	Preamp Factor	Read Level	Limit Level	Over Limit	Remark
	MHz	dB	dB/m	dB	dBuV	dBuV/m	dBuV/m	dB
1	5240.000	8.29	31.99	31.94	89.51	97.85	68.20	29.65 Peak
2	5350.020	8.28	32.25	32.10	53.59	62.02	74.00	-11.98 Peak
3	5353.479	8.28	32.26	32.10	55.40	63.84	74.00	-10.16 Peak



Unless otherwise agreed in writing, this document is issued by the Company subject to its General Conditions of Service printed overleaf, available on request or accessible at <http://www.sgs.com/en/Terms-and-Conditions.aspx> and, for electronic format documents, subject to Terms and Conditions for Electronic Documents at <http://www.sgs.com/en/Terms-and-Conditions/Terms-e-Documents.aspx>. Attention is drawn to the limitation of liability, indemnification and jurisdiction issues defined therein. Any holder of this document is advised that information contained hereon reflects the Company's findings at the time of its intervention only and within the limits of Client's instructions, if any. The Company's sole responsibility is to its Client and this document does not exonerate parties to a transaction from exercising all their rights and obligations under the transaction documents. This document cannot be reproduced except in full, without prior written approval of the Company. Any unauthorized alteration, forgery or falsification of the content or appearance of this document is unlawful and offenders may be prosecuted to the fullest extent of the law. Unless otherwise stated the results shown in this test report refer only to the sample(s) tested and such sample(s) are retained for 30 days only.
Attention: To check the authenticity of testing /inspection report & certificate, please contact us at telephone: (86-755) 8307 1443, or email: CN.Doccheck@sgs.com

Fuyong lab, Xinlong TechnoPark, Fengtang Road, Fuyong Subdistrict, Bao'an, Shenzhen, China 518103 t (86-755) 88663988 f (86-755) 26710594 www.sgsgroup.com.cn
 中国·深圳·宝安区福永街道凤塘大道鑫龙科技园福永实验室 邮编: 518103 t (86-755) 88663988 f (86-755) 26710594 sgs.china@sgs.com

Test Mode: 09; Polarity: Vertical; Modulation:802.11n; Bandwidth:20MHz; Channel:High

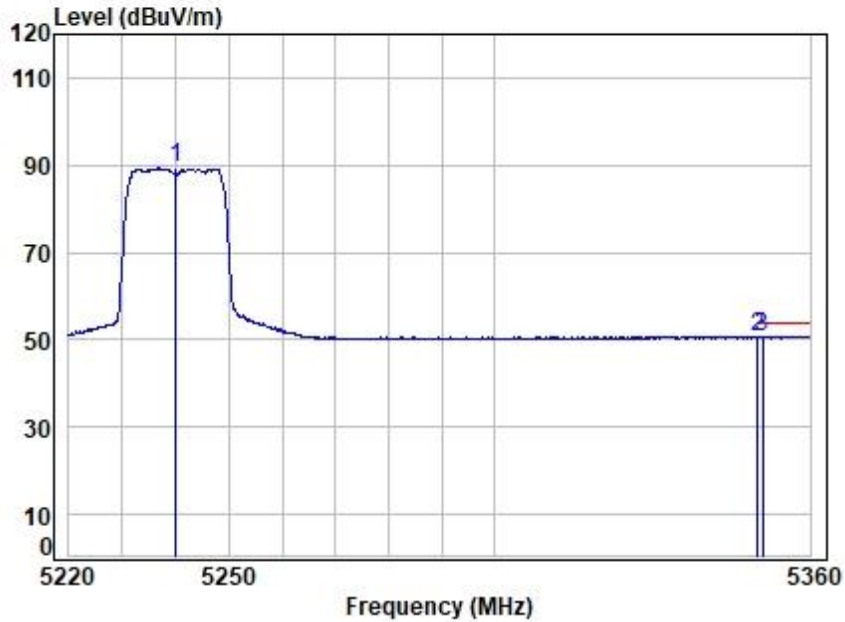

Site : chamber
 Condition: 3m VERTICAL
 Job No : 00466AT
 Mode : 5240 Band edge
 : 5G WIFI 11N20

	Freq	Cable Loss	Ant Factor	Preamp Factor	Read Level	Level	Limit Line	Over Limit	Remark
	MHz	dB	dB/m	dB	dBuV	dBuV/m	dBuV/m	dB	
1	5240.000	8.29	31.99	31.94	80.88	89.22	-----	-----	Average
2	5350.020	8.28	32.25	32.10	42.27	50.70	54.00	-3.30	Average
3	5350.929	8.28	32.25	32.10	42.32	50.75	54.00	-3.25	Average



Unless otherwise agreed in writing, this document is issued by the Company subject to its General Conditions of Service printed overleaf, available on request or accessible at <http://www.sgs.com/en/Terms-and-Conditions.aspx> and, for electronic format documents, subject to Terms and Conditions for Electronic Documents at <http://www.sgs.com/en/Terms-and-Conditions/Terms-e-Documents.aspx>. Attention is drawn to the limitation of liability, indemnification and jurisdiction issues defined therein. Any holder of this document is advised that information contained hereon reflects the Company's findings at the time of its intervention only and within the limits of Client's instructions, if any. The Company's sole responsibility is to its Client and this document does not exonerate parties to a transaction from exercising all their rights and obligations under the transaction documents. This document cannot be reproduced except in full, without prior written approval of the Company. Any unauthorized alteration, forgery or falsification of the content or appearance of this document is unlawful and offenders may be prosecuted to the fullest extent of the law. Unless otherwise stated the results shown in this test report refer only to the sample(s) tested and such sample(s) are retained for 30 days only.
Attention: To check the authenticity of testing /inspection report & certificate, please contact us at telephone: (86-755) 8307 1443, or email: CN.Doccheck@sgs.com

Fuyong lab, Xinlong TechnoPark, Fengtang Road, Fuyong Subdistrict, Bao'an, Shenzhen, China 518103 t (86-755) 88663988 f (86-755) 26710594 www.sgsgroup.com.cn
 中国·深圳·宝安区福永街道凤塘大道鑫龙科技园福永实验室 邮编: 518103 t (86-755) 88663988 f (86-755) 26710594 sgs.china@sgs.com

Compliance Certification Services (Kunshan) Inc. Shenzhen Branch

SZCCS-TRF-01 Rev. A/0 Aug01,2022

Report No.: FYCR221100046605

Page: 102 of 344

Test Mode: 09; Polarity: Horizontal; Modulation:802.11n; Bandwidth:40MHz; Channel:Low

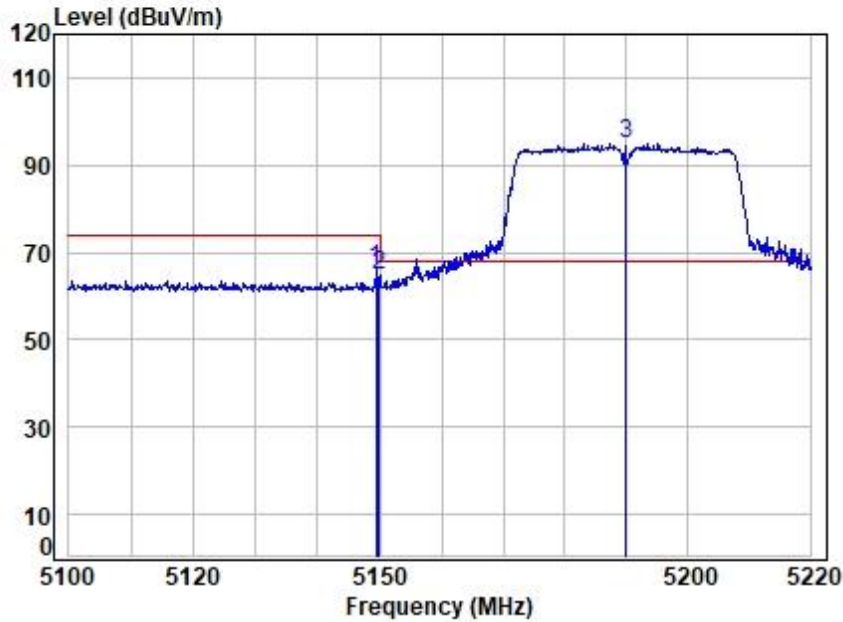

Site : chamber
 Condition: 3m HORIZONTAL
 Job No : 00466AT
 Mode : 5190 Band edge
 : 5G WIFI 11N40

	Freq	Cable Loss	Ant Factor	Preamp Factor	Read Level	Level	Limit	Over	Remark
	MHz	dB	dB/m	dB	dBuV	dBuV/m	dBuV/m	dB	
1	5149.461	8.29	31.77	31.82	57.88	66.12	74.00	-7.88	peak
2	5149.980	8.29	31.77	31.82	56.77	65.01	74.00	-8.99	peak
3	5190.000	8.29	31.87	31.87	86.76	95.05	68.20	26.85	peak



Unless otherwise agreed in writing, this document is issued by the Company subject to its General Conditions of Service printed overleaf, available on request or accessible at <http://www.sgs.com/en/Terms-and-Conditions.aspx> and, for electronic format documents, subject to Terms and Conditions for Electronic Documents at <http://www.sgs.com/en/Terms-and-Conditions/Terms-e-Documents.aspx>. Attention is drawn to the limitation of liability, indemnification and jurisdiction issues defined therein. Any holder of this document is advised that information contained hereon reflects the Company's findings at the time of its intervention only and within the limits of Client's instructions, if any. The Company's sole responsibility is to its Client and this document does not exonerate parties to a transaction from exercising all their rights and obligations under the transaction documents. This document cannot be reproduced except in full, without prior written approval of the Company. Any unauthorized alteration, forgery or falsification of the content or appearance of this document is unlawful and offenders may be prosecuted to the fullest extent of the law. Unless otherwise stated the results shown in this test report refer only to the sample(s) tested and such sample(s) are retained for 30 days only.
Attention: To check the authenticity of testing /inspection report & certificate, please contact us at telephone: (86-755) 8307 1443, or email: CN.Doccheck@sgs.com

Fuyong lab, Xinlong TechnoPark, Fengtang Road, Fuyong Subdistrict, Bao'an, Shenzhen, China 518103 t (86-755) 88663988 f (86-755) 26710594 www.sgsgroup.com.cn
 中国·深圳·宝安区福永街道凤塘大道鑫龙科技园福永实验室 邮编: 518103 t (86-755) 88663988 f (86-755) 26710594 sgs.china@sgs.com

Compliance Certification Services (Kunshan) Inc. Shenzhen Branch

SZCCS-TRF-01 Rev. A/0 Aug01,2022

Report No.: FYCR221100046605

Page: 103 of 344

Test Mode: 09; Polarity: Horizontal; Modulation:802.11n; Bandwidth:40MHz; Channel:Low

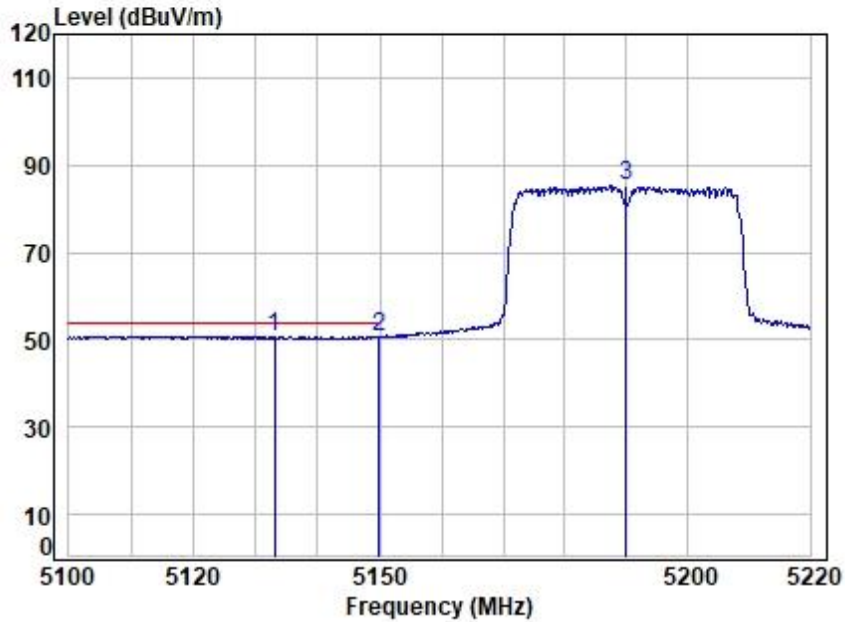

Site : chamber
 Condition: 3m HORIZONTAL
 Job No : 00466AT
 Mode : 5190 Band edge
 : 5G WIFI 11N40

	Freq	Cable Loss	Ant Factor	Preamp Factor	Read Level	Level	Limit	Over	Remark
	MHz	dB	dB/m	dB	dBuV	dBuV/m	dBuV/m	dB	
1	5133.081	8.29	31.73	31.79	42.52	50.75	54.00	-3.25	Average
2	5149.980	8.29	31.77	31.82	42.54	50.78	54.00	-3.22	Average
3	5190.000	8.29	31.87	31.87	76.89	85.18	-----	-----	Average



Unless otherwise agreed in writing, this document is issued by the Company subject to its General Conditions of Service printed overleaf, available on request or accessible at <http://www.sgs.com/en/Terms-and-Conditions.aspx> and, for electronic format documents, subject to Terms and Conditions for Electronic Documents at <http://www.sgs.com/en/Terms-and-Conditions/Terms-e-Documents.aspx>. Attention is drawn to the limitation of liability, indemnification and jurisdiction issues defined therein. Any holder of this document is advised that information contained hereon reflects the Company's findings at the time of its intervention only and within the limits of Client's instructions, if any. The Company's sole responsibility is to its Client and this document does not exonerate parties to a transaction from exercising all their rights and obligations under the transaction documents. This document cannot be reproduced except in full, without prior written approval of the Company. Any unauthorized alteration, forgery or falsification of the content or appearance of this document is unlawful and offenders may be prosecuted to the fullest extent of the law. Unless otherwise stated the results shown in this test report refer only to the sample(s) tested and such sample(s) are retained for 30 days only.
Attention: To check the authenticity of testing /inspection report & certificate, please contact us at telephone: (86-755) 8307 1443, or email: CN.Doccheck@sgs.com

Fuyong lab, Xinlong TechnoPark, Fengtang Road, Fuyong Subdistrict, Bao'an, Shenzhen, China 518103 t (86-755) 88663988 f (86-755) 26710594 www.sgsgroup.com.cn
 中国·深圳·宝安区福永街道凤塘大道鑫龙科技园福永实验室 邮编: 518103 t (86-755) 88663988 f (86-755) 26710594 sgs.china@sgs.com

Compliance Certification Services (Kunshan) Inc. Shenzhen Branch

SZCCS-TRF-01 Rev. A/0 Aug01,2022

Report No.: FYCR221100046605

Page: 104 of 344

Test Mode: 09; Polarity: Vertical; Modulation:802.11n; Bandwidth:40MHz; Channel:Low

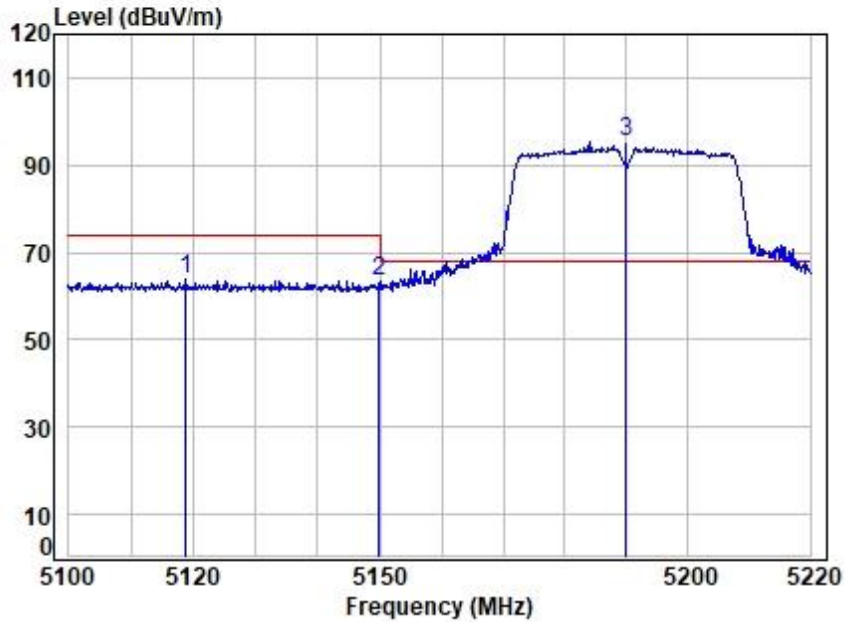

Site : chamber
 Condition: 3m VERTICAL
 Job No : 00466AT
 Mode : 5190 Band edge
 : 5G WIFI 11N40

		Cable	Ant	Preamp	Read	Limit	Over	
	Freq	Loss	Factor	Factor	Level	Line	Limit	Remark
	MHz	dB	dB/m	dB	dBuV	dBuV/m	dBuV/m	dB
1	5118.775	8.29	31.70	31.77	55.46	63.68	74.00	-10.32 Peak
2	5149.980	8.29	31.77	31.82	55.30	63.54	74.00	-10.46 Peak
3	5190.000	8.29	31.87	31.87	87.04	95.33	68.20	27.13 Peak



Unless otherwise agreed in writing, this document is issued by the Company subject to its General Conditions of Service printed overleaf, available on request or accessible at <http://www.sgs.com/en/Terms-and-Conditions.aspx> and, for electronic format documents, subject to Terms and Conditions for Electronic Documents at <http://www.sgs.com/en/Terms-and-Conditions/Terms-e-Documents.aspx>. Attention is drawn to the limitation of liability, indemnification and jurisdiction issues defined therein. Any holder of this document is advised that information contained hereon reflects the Company's findings at the time of its intervention only and within the limits of Client's instructions, if any. The Company's sole responsibility is to its Client and this document does not exonerate parties to a transaction from exercising all their rights and obligations under the transaction documents. This document cannot be reproduced except in full, without prior written approval of the Company. Any unauthorized alteration, forgery or falsification of the content or appearance of this document is unlawful and offenders may be prosecuted to the fullest extent of the law. Unless otherwise stated the results shown in this test report refer only to the sample(s) tested and such sample(s) are retained for 30 days only.
Attention: To check the authenticity of testing /inspection report & certificate, please contact us at telephone: (86-755) 8307 1443, or email: CN.Doccheck@sgs.com

Fuyong lab, Xinlong TechnoPark, Fengtang Road, Fuyong Subdistrict, Bao'an, Shenzhen, China 518103 t (86-755) 88663988 f (86-755) 26710594 www.sgsgroup.com.cn
 中国·深圳·宝安区福永街道凤塘大道鑫龙科技园福永实验室 邮编: 518103 t (86-755) 88663988 f (86-755) 26710594 sgs.china@sgs.com

Test Mode: 09; Polarity: Vertical; Modulation:802.11n; Bandwidth:40MHz; Channel:Low

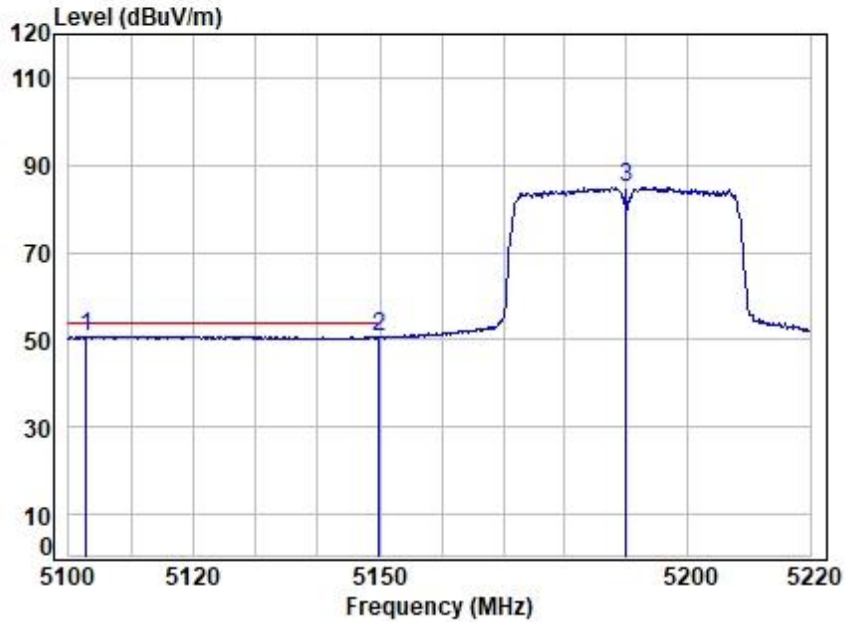

Site : chamber
 Condition: 3m VERTICAL
 Job No : 00466AT
 Mode : 5190 Band edge
 : 5G WIFI 11N40

	Freq	Cable Loss	Ant Factor	Preamp Factor	Read Level	Limit	Over	Remark
	MHz	dB	dB/m	dB	dBuV	dBuV/m	dB	
1	5102.848	8.29	31.66	31.75	42.62	50.82	54.00	-3.18 Average
2	5149.980	8.29	31.77	31.82	42.31	50.55	54.00	-3.45 Average
3	5190.000	8.29	31.87	31.87	76.80	85.09	-----	----- Average



Unless otherwise agreed in writing, this document is issued by the Company subject to its General Conditions of Service printed overleaf, available on request or accessible at <http://www.sgs.com/en/Terms-and-Conditions.aspx> and, for electronic format documents, subject to Terms and Conditions for Electronic Documents at <http://www.sgs.com/en/Terms-and-Conditions/Terms-e-Documents.aspx>. Attention is drawn to the limitation of liability, indemnification and jurisdiction issues defined therein. Any holder of this document is advised that information contained hereon reflects the Company's findings at the time of its intervention only and within the limits of Client's instructions, if any. The Company's sole responsibility is to its Client and this document does not exonerate parties to a transaction from exercising all their rights and obligations under the transaction documents. This document cannot be reproduced except in full, without prior written approval of the Company. Any unauthorized alteration, forgery or falsification of the content or appearance of this document is unlawful and offenders may be prosecuted to the fullest extent of the law. Unless otherwise stated the results shown in this test report refer only to the sample(s) tested and such sample(s) are retained for 30 days only.
Attention: To check the authenticity of testing /inspection report & certificate, please contact us at telephone: (86-755) 8307 1443, or email: CN.Doccheck@sgs.com

Fuyong lab, Xinlong TechnoPark, Fengtang Road, Fuyong Subdistrict, Bao'an, Shenzhen, China 518103 t (86-755) 88663988 f (86-755) 26710594 www.sgsgroup.com.cn
 中国·深圳·宝安区福永街道凤塘大道鑫龙科技园福永实验室 邮编: 518103 t (86-755) 88663988 f (86-755) 26710594 sgs.china@sgs.com

Test Mode: 09; Polarity: Horizontal; Modulation:802.11n; Bandwidth:40MHz; Channel:High

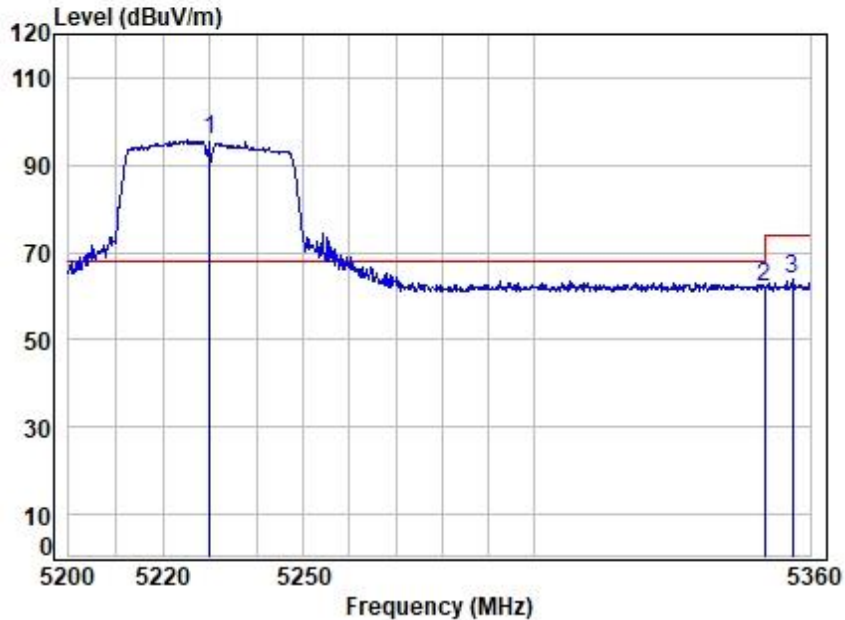

Site : chamber
 Condition: 3m HORIZONTAL
 Job No : 00466AT
 Mode : 5230 Band edge
 : 5G WIFI 11N40

	Freq	Cable Loss	Ant Factor	Preamp Factor	Read Level	Level	Limit	Over	Remark
	MHz	dB	dB/m	dB	dBuV	dBuV/m	dBuV/m	dB	
1	5230.000	8.29	31.97	31.93	87.66	95.99	68.20	27.79	peak
2	5350.020	8.28	32.25	32.10	53.75	62.18	74.00	-11.82	peak
3	5356.103	8.28	32.27	32.11	55.23	63.67	74.00	-10.33	peak



Unless otherwise agreed in writing, this document is issued by the Company subject to its General Conditions of Service printed overleaf, available on request or accessible at <http://www.sgs.com/en/Terms-and-Conditions.aspx> and, for electronic format documents, subject to Terms and Conditions for Electronic Documents at <http://www.sgs.com/en/Terms-and-Conditions/Terms-e-Documents.aspx>. Attention is drawn to the limitation of liability, indemnification and jurisdiction issues defined therein. Any holder of this document is advised that information contained hereon reflects the Company's findings at the time of its intervention only and within the limits of Client's instructions, if any. The Company's sole responsibility is to its Client and this document does not exonerate parties to a transaction from exercising all their rights and obligations under the transaction documents. This document cannot be reproduced except in full, without prior written approval of the Company. Any unauthorized alteration, forgery or falsification of the content or appearance of this document is unlawful and offenders may be prosecuted to the fullest extent of the law. Unless otherwise stated the results shown in this test report refer only to the sample(s) tested and such sample(s) are retained for 30 days only.
Attention: To check the authenticity of testing /inspection report & certificate, please contact us at telephone: (86-755) 8307 1443, or email: CN.Doccheck@sgs.com

Fuyong lab, Xinlong TechnoPark, Fengtang Road, Fuyong Subdistrict, Bao'an, Shenzhen, China 518103 t (86-755) 88663988 f (86-755) 26710594 www.sgsgroup.com.cn
 中国·深圳·宝安区福永街道凤塘大道鑫龙科技园福永实验室 邮编: 518103 t (86-755) 88663988 f (86-755) 26710594 sgs.china@sgs.com

Test Mode: 09; Polarity: Horizontal; Modulation:802.11n; Bandwidth:40MHz; Channel:High

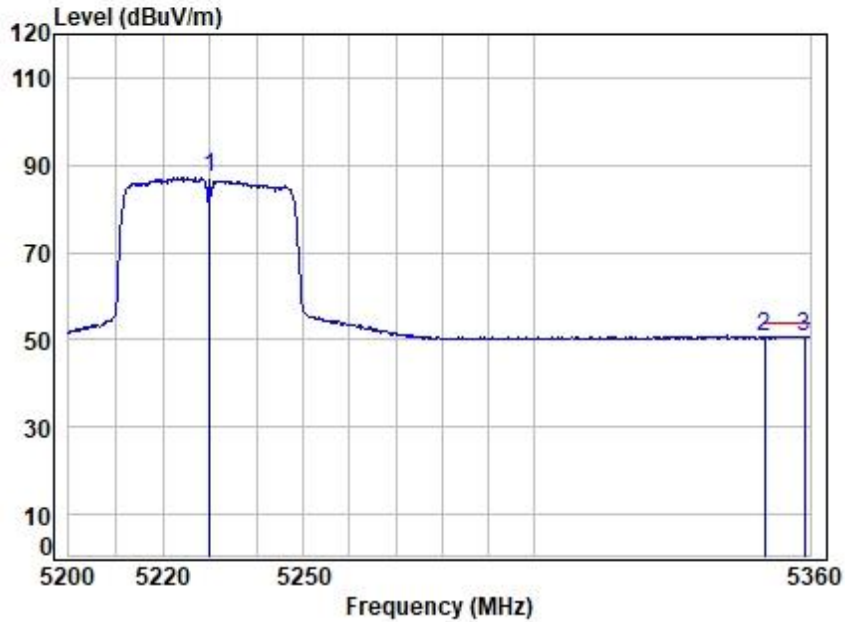

Site : chamber
 Condition: 3m HORIZONTAL
 Job No : 00466AT
 Mode : 5230 Band edge
 : 5G WIFI 11N40

	Freq	Cable Loss	Ant Factor	Preamp Factor	Read Level	Level	Limit	Over	Remark
	MHz	dB	dB/m	dB	dBuV	dBuV/m	dBuV/m	dB	
1	5230.000	8.29	31.97	31.93	78.74	87.07	-----	-----	Average
2	5350.020	8.28	32.25	32.10	42.08	50.51	54.00	-3.49	Average
3	5358.701	8.28	32.27	32.11	42.32	50.76	54.00	-3.24	Average



Unless otherwise agreed in writing, this document is issued by the Company subject to its General Conditions of Service printed overleaf, available on request or accessible at <http://www.sgs.com/en/Terms-and-Conditions.aspx> and, for electronic format documents, subject to Terms and Conditions for Electronic Documents at <http://www.sgs.com/en/Terms-and-Conditions/Terms-e-Documents.aspx>. Attention is drawn to the limitation of liability, indemnification and jurisdiction issues defined therein. Any holder of this document is advised that information contained hereon reflects the Company's findings at the time of its intervention only and within the limits of Client's instructions, if any. The Company's sole responsibility is to its Client and this document does not exonerate parties to a transaction from exercising all their rights and obligations under the transaction documents. This document cannot be reproduced except in full, without prior written approval of the Company. Any unauthorized alteration, forgery or falsification of the content or appearance of this document is unlawful and offenders may be prosecuted to the fullest extent of the law. Unless otherwise stated the results shown in this test report refer only to the sample(s) tested and such sample(s) are retained for 30 days only.
Attention: To check the authenticity of testing /inspection report & certificate, please contact us at telephone: (86-755) 8307 1443, or email: CN.Doccheck@sgs.com

Fuyong lab, Xinlong TechnoPark, Fengtang Road, Fuyong Subdistrict, Bao'an, Shenzhen, China 518103 t (86-755) 88663988 f (86-755) 26710594 www.sgsgroup.com.cn
 中国·深圳·宝安区福永街道凤塘大道鑫龙科技园福永实验室 邮编: 518103 t (86-755) 88663988 f (86-755) 26710594 sgs.china@sgs.com

Test Mode: 09; Polarity: Vertical; Modulation:802.11n; Bandwidth:40MHz; Channel:High

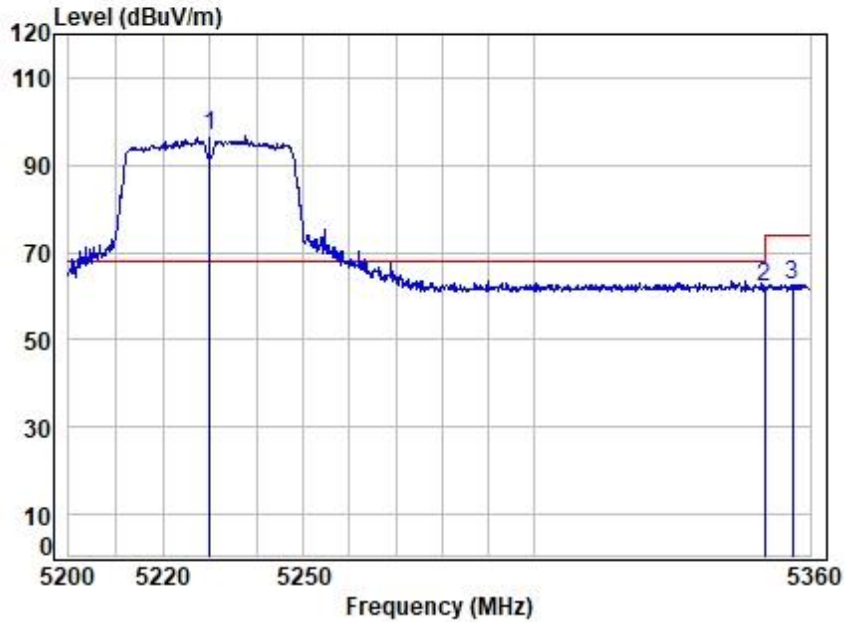

Site : chamber
 Condition: 3m VERTICAL
 Job No : 00466AT
 Mode : 5230 Band edge
 : 5G WIFI 11N40

	Freq	Cable Loss	Ant Factor	Preamp Factor	Read Level	Limit Level	Over Limit	Remark
	MHz	dB	dB/m	dB	dBuV	dBuV/m	dB	
1	5230.000	8.29	31.97	31.93	88.18	68.20	28.31	Peak
2	5350.020	8.28	32.25	32.10	53.74	74.00	-11.83	Peak
3	5356.265	8.28	32.27	32.11	54.16	74.00	-11.40	Peak



Unless otherwise agreed in writing, this document is issued by the Company subject to its General Conditions of Service printed overleaf, available on request or accessible at <http://www.sgs.com/en/Terms-and-Conditions.aspx> and, for electronic format documents, subject to Terms and Conditions for Electronic Documents at <http://www.sgs.com/en/Terms-and-Conditions/Terms-e-Documents.aspx>. Attention is drawn to the limitation of liability, indemnification and jurisdiction issues defined therein. Any holder of this document is advised that information contained hereon reflects the Company's findings at the time of its intervention only and within the limits of Client's instructions, if any. The Company's sole responsibility is to its Client and this document does not exonerate parties to a transaction from exercising all their rights and obligations under the transaction documents. This document cannot be reproduced except in full, without prior written approval of the Company. Any unauthorized alteration, forgery or falsification of the content or appearance of this document is unlawful and offenders may be prosecuted to the fullest extent of the law. Unless otherwise stated the results shown in this test report refer only to the sample(s) tested and such sample(s) are retained for 30 days only.
Attention: To check the authenticity of testing /inspection report & certificate, please contact us at telephone: (86-755) 8307 1443, or email: CN.Doccheck@sgs.com

Fuyong lab, Xinlong TechnoPark, Fengtang Road, Fuyong Subdistrict, Bao'an, Shenzhen, China 518103 t (86-755) 88663988 f (86-755) 26710594 www.sgsgroup.com.cn
 中国·深圳·宝安区福永街道凤塘大道鑫龙科技园福永实验室 邮编: 518103 t (86-755) 88663988 f (86-755) 26710594 sgs.china@sgs.com

Test Mode: 09; Polarity: Vertical; Modulation:802.11n; Bandwidth:40MHz; Channel:High

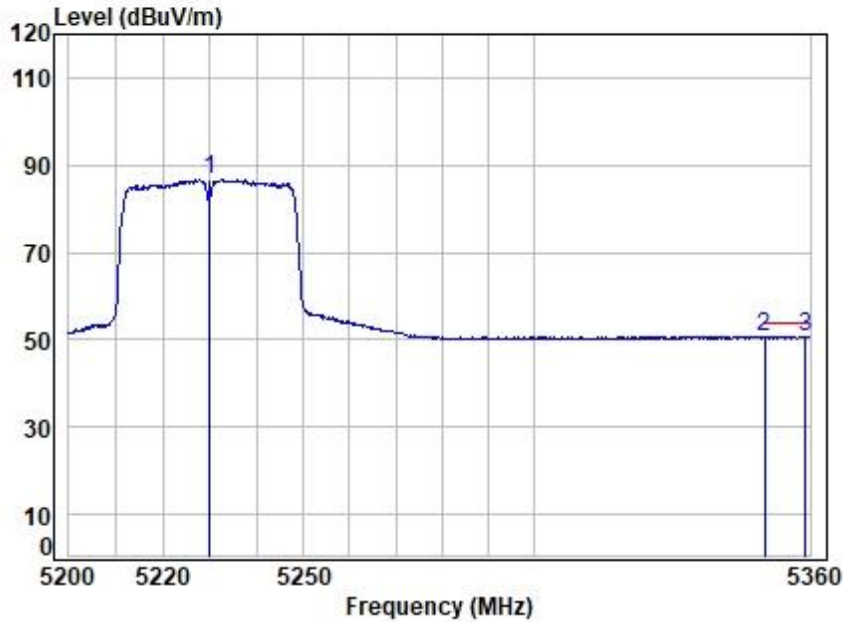

Site : chamber
 Condition: 3m VERTICAL
 Job No : 00466AT
 Mode : 5230 Band edge
 : 5G WIFI 11N40

	Freq	Cable Loss	Ant Factor	Preamp Factor	Read Level	Limit Level	Over Limit	Remark
	MHz	dB	dB/m	dB	dBuV	dBuV/m	dB	
1	5230.000	8.29	31.97	31.93	78.32	86.65	-----	Average
2	5350.020	8.28	32.25	32.10	42.12	50.55	-3.45	Average
3	5359.025	8.28	32.27	32.11	42.28	50.72	-3.28	Average



Unless otherwise agreed in writing, this document is issued by the Company subject to its General Conditions of Service printed overleaf, available on request or accessible at <http://www.sgs.com/en/Terms-and-Conditions.aspx> and, for electronic format documents, subject to Terms and Conditions for Electronic Documents at <http://www.sgs.com/en/Terms-and-Conditions/Terms-e-Documents.aspx>. Attention is drawn to the limitation of liability, indemnification and jurisdiction issues defined therein. Any holder of this document is advised that information contained hereon reflects the Company's findings at the time of its intervention only and within the limits of Client's instructions, if any. The Company's sole responsibility is to its Client and this document does not exonerate parties to a transaction from exercising all their rights and obligations under the transaction documents. This document cannot be reproduced except in full, without prior written approval of the Company. Any unauthorized alteration, forgery or falsification of the content or appearance of this document is unlawful and offenders may be prosecuted to the fullest extent of the law. Unless otherwise stated the results shown in this test report refer only to the sample(s) tested and such sample(s) are retained for 30 days only.
Attention: To check the authenticity of testing /inspection report & certificate, please contact us at telephone: (86-755) 8307 1443, or email: CN.Doccheck@sgs.com

Fuyong lab, Xinlong TechnoPark, Fengtang Road, Fuyong Subdistrict, Bao'an, Shenzhen, China 518103 t (86-755) 88663988 f (86-755) 26710594 www.sgsgroup.com.cn
 中国·深圳·宝安区福永街道凤塘大道鑫龙科技园福永实验室 邮编: 518103 t (86-755) 88663988 f (86-755) 26710594 sgs.china@sgs.com

Compliance Certification Services (Kunshan) Inc. Shenzhen Branch

SZCCS-TRF-01 Rev. A/0 Aug01,2022

Report No.: FYCR221100046605

Page: 110 of 344

Test Mode: 09; Polarity: Horizontal; Modulation:802.11ac; Bandwidth:80MHz; Channel:middle

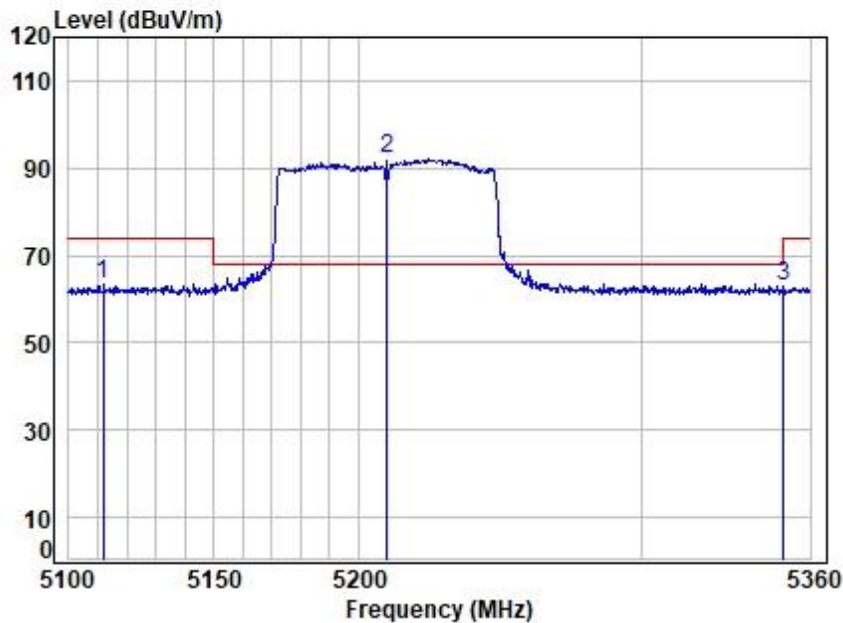

Site : chamber
 Condition: 3m HORIZONTAL
 Job No : 00466AT
 Mode : 5210 Band edge
 : 5G WIFI 11AC80

	Freq	Cable Loss	Ant Factor	Preamp Factor	Read Level	Limit Level	Over Limit	Remark
	MHz	dB	dB/m	dB	dBuV	dBuV/m	dB	
1	5111.933	8.29	31.68	31.76	55.09	74.00	-10.70	peak
2	5210.000	8.29	31.92	31.90	83.75	68.20	23.86	peak
3	5350.414	8.28	32.25	32.10	54.45	74.00	-11.12	peak



Unless otherwise agreed in writing, this document is issued by the Company subject to its General Conditions of Service printed overleaf, available on request or accessible at <http://www.sgs.com/en/Terms-and-Conditions.aspx> and, for electronic format documents, subject to Terms and Conditions for Electronic Documents at <http://www.sgs.com/en/Terms-and-Conditions/Terms-e-Documents.aspx>. Attention is drawn to the limitation of liability, indemnification and jurisdiction issues defined therein. Any holder of this document is advised that information contained hereon reflects the Company's findings at the time of its intervention only and within the limits of Client's instructions, if any. The Company's sole responsibility is to its Client and this document does not exonerate parties to a transaction from exercising all their rights and obligations under the transaction documents. This document cannot be reproduced except in full, without prior written approval of the Company. Any unauthorized alteration, forgery or falsification of the content or appearance of this document is unlawful and offenders may be prosecuted to the fullest extent of the law. Unless otherwise stated the results shown in this test report refer only to the sample(s) tested and such sample(s) are retained for 30 days only.
Attention: To check the authenticity of testing /inspection report & certificate, please contact us at telephone: (86-755) 8307 1443, or email: CN.Doccheck@sgs.com

Fuyong lab, Xinlong TechnoPark, Fengtang Road, Fuyong Subdistrict, Bao'an, Shenzhen, China 518103 t (86-755) 88663988 f (86-755) 26710594 www.sgsgroup.com.cn
 中国·深圳·宝安区福永街道凤塘大道鑫龙科技园福永实验室 邮编: 518103 t (86-755) 88663988 f (86-755) 26710594 sgs.china@sgs.com

Compliance Certification Services (Kunshan) Inc. Shenzhen Branch

SZCCS-TRF-01 Rev. A/0 Aug01,2022

Report No.: FYCR221100046605

Page: 111 of 344

Test Mode: 09; Polarity: Horizontal; Modulation:802.11ac; Bandwidth:80MHz; Channel:middle

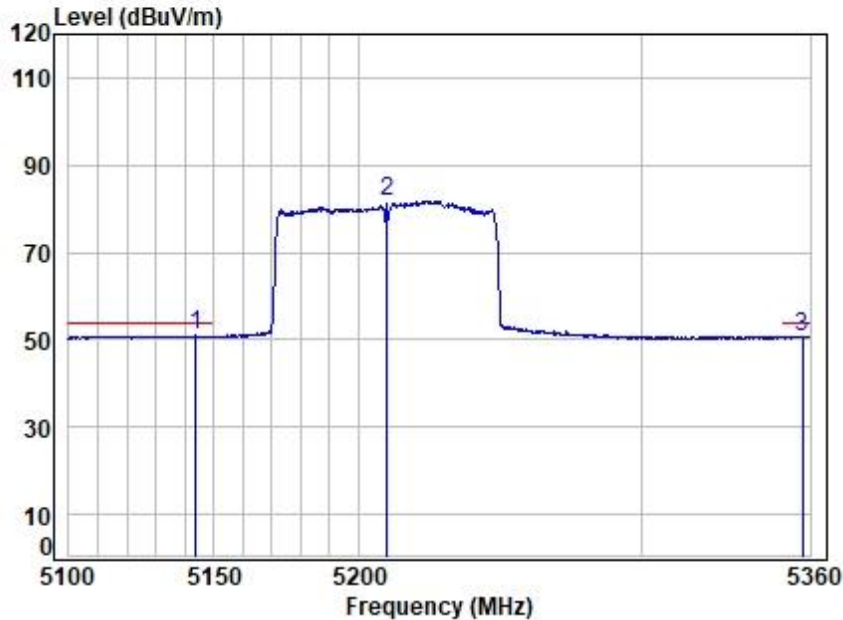

Site : chamber
 Condition: 3m HORIZONTAL
 Job No : 00466AT
 Mode : 5210 Band edge
 : 5G WIFI 11AC80

	Freq	Cable Loss	Ant Factor	Preamp Factor	Read Level	Limit	Over	Remark
	MHz	dB	dB/m	dB	dBuV	dBuV/m	dB	
1	5143.549	8.29	31.76	31.81	42.72	50.96	54.00	-3.04 Average
2	5210.000	8.29	31.92	31.90	73.49	81.80	-----	----- Average
3	5357.335	8.28	32.27	32.11	42.27	50.71	54.00	-3.29 Average



Unless otherwise agreed in writing, this document is issued by the Company subject to its General Conditions of Service printed overleaf, available on request or accessible at <http://www.sgs.com/en/Terms-and-Conditions.aspx> and, for electronic format documents, subject to Terms and Conditions for Electronic Documents at <http://www.sgs.com/en/Terms-and-Conditions/Terms-e-Documents.aspx>. Attention is drawn to the limitation of liability, indemnification and jurisdiction issues defined therein. Any holder of this document is advised that information contained hereon reflects the Company's findings at the time of its intervention only and within the limits of Client's instructions, if any. The Company's sole responsibility is to its Client and this document does not exonerate parties to a transaction from exercising all their rights and obligations under the transaction documents. This document cannot be reproduced except in full, without prior written approval of the Company. Any unauthorized alteration, forgery or falsification of the content or appearance of this document is unlawful and offenders may be prosecuted to the fullest extent of the law. Unless otherwise stated the results shown in this test report refer only to the sample(s) tested and such sample(s) are retained for 30 days only.
Attention: To check the authenticity of testing /inspection report & certificate, please contact us at telephone: (86-755) 8307 1443, or email: CN.Doccheck@sgs.com

Fuyong lab, Xinlong TechnoPark, Fengtang Road, Fuyong Subdistrict, Bao'an, Shenzhen, China 518103 t (86-755) 88663988 f (86-755) 26710594 www.sgsgroup.com.cn
 中国·深圳·宝安区福永街道凤塘大道鑫龙科技园福永实验室 邮编: 518103 t (86-755) 88663988 f (86-755) 26710594 sgs.china@sgs.com

Compliance Certification Services (Kunshan) Inc. Shenzhen Branch

SZCCS-TRF-01 Rev. A/0 Aug01,2022

Report No.: FYCR221100046605

Page: 112 of 344

Test Mode: 09; Polarity: Vertical; Modulation:802.11ac; Bandwidth:80MHz; Channel:middle

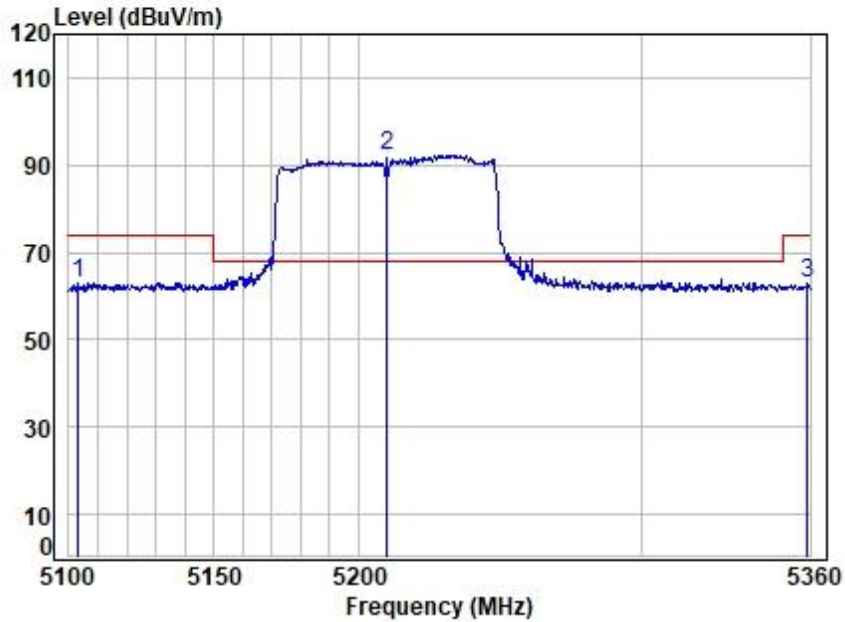

Site : chamber
 Condition: 3m VERTICAL
 Job No : 00466AT
 Mode : 5210 Band edge
 : 5G WIFI 11AC80

	Freq	Cable Loss	Ant Factor	Preamp Factor	Read Level	Level	Limit Line	Over Limit	Remark
	MHz	dB	dB/m	dB	dBuV	dBuV/m	dBuV/m	dB	
1	5103.298	8.29	31.66	31.75	54.84	63.04	74.00	-10.96	Peak
2	5210.000	8.29	31.92	31.90	84.00	92.31	68.20	24.11	Peak
3	5359.201	8.28	32.27	32.11	54.66	63.10	74.00	-10.90	Peak



Unless otherwise agreed in writing, this document is issued by the Company subject to its General Conditions of Service printed overleaf, available on request or accessible at <http://www.sgs.com/en/Terms-and-Conditions.aspx> and, for electronic format documents, subject to Terms and Conditions for Electronic Documents at <http://www.sgs.com/en/Terms-and-Conditions/Terms-e-Documents.aspx>. Attention is drawn to the limitation of liability, indemnification and jurisdiction issues defined therein. Any holder of this document is advised that information contained hereon reflects the Company's findings at the time of its intervention only and within the limits of Client's instructions, if any. The Company's sole responsibility is to its Client and this document does not exonerate parties to a transaction from exercising all their rights and obligations under the transaction documents. This document cannot be reproduced except in full, without prior written approval of the Company. Any unauthorized alteration, forgery or falsification of the content or appearance of this document is unlawful and offenders may be prosecuted to the fullest extent of the law. Unless otherwise stated the results shown in this test report refer only to the sample(s) tested and such sample(s) are retained for 30 days only.
Attention: To check the authenticity of testing /inspection report & certificate, please contact us at telephone: (86-755) 8307 1443, or email: CN.Doccheck@sgs.com

Fuyong lab, Xinlong TechnoPark, Fengtang Road, Fuyong Subdistrict, Bao'an, Shenzhen, China 518103 t (86-755) 88663988 f (86-755) 26710594 www.sgsgroup.com.cn
 中国·深圳·宝安区福永街道凤塘大道鑫龙科技园福永实验室 邮编: 518103 t (86-755) 88663988 f (86-755) 26710594 sgs.china@sgs.com

Compliance Certification Services (Kunshan) Inc. Shenzhen Branch

SZCCS-TRF-01 Rev. A/0 Aug01,2022

Report No.: FYCR221100046605

Page: 113 of 344

Test Mode: 09; Polarity: Vertical; Modulation:802.11ac; Bandwidth:80MHz; Channel:middle

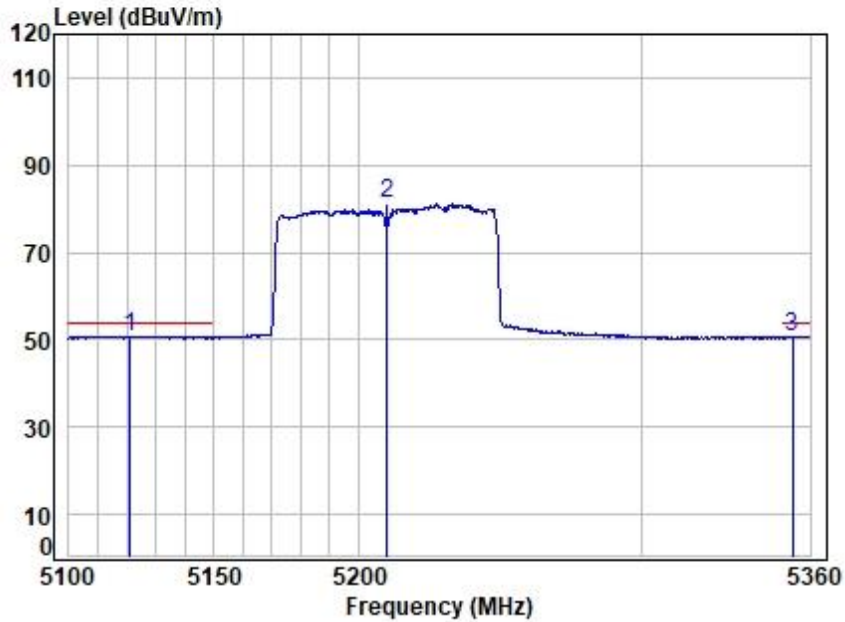

Site : chamber
 Condition: 3m VERTICAL
 Job No : 00466AT
 Mode : 5210 Band edge
 : 5G WIFI 11AC80

	Freq	Cable Loss	Ant Factor	Preamp Factor	Read Level	Limit Level	Over Limit	Remark
	MHz	dB	dB/m	dB	dBuV	dBuV/m	dB	
1	5121.091	8.29	31.70	31.78	42.62	50.83	54.00	-3.17 Average
2	5210.000	8.29	31.92	31.90	72.74	81.05	-----	----- Average
3	5353.874	8.28	32.26	32.10	42.26	50.70	54.00	-3.30 Average



Unless otherwise agreed in writing, this document is issued by the Company subject to its General Conditions of Service printed overleaf, available on request or accessible at <http://www.sgs.com/en/Terms-and-Conditions.aspx> and, for electronic format documents, subject to Terms and Conditions for Electronic Documents at <http://www.sgs.com/en/Terms-and-Conditions/Terms-e-Documents.aspx>. Attention is drawn to the limitation of liability, indemnification and jurisdiction issues defined therein. Any holder of this document is advised that information contained hereon reflects the Company's findings at the time of its intervention only and within the limits of Client's instructions, if any. The Company's sole responsibility is to its Client and this document does not exonerate parties to a transaction from exercising all their rights and obligations under the transaction documents. This document cannot be reproduced except in full, without prior written approval of the Company. Any unauthorized alteration, forgery or falsification of the content or appearance of this document is unlawful and offenders may be prosecuted to the fullest extent of the law. Unless otherwise stated the results shown in this test report refer only to the sample(s) tested and such sample(s) are retained for 30 days only.
Attention: To check the authenticity of testing /inspection report & certificate, please contact us at telephone: (86-755) 8307 1443, or email: CN.Doccheck@sgs.com

Fuyong lab, Xinlong TechnoPark, Fengtang Road, Fuyong Subdistrict, Bao'an, Shenzhen, China 518103 t (86-755) 88663988 f (86-755) 26710594 www.sgsgroup.com.cn
 中国·深圳·宝安区福永街道凤塘大道鑫龙科技园福永实验室 邮编: 518103 t (86-755) 88663988 f (86-755) 26710594 sgs.china@sgs.com

Test Mode: 10; Polarity: Horizontal; Modulation:802.11a; Bandwidth:20MHz; Channel:Low

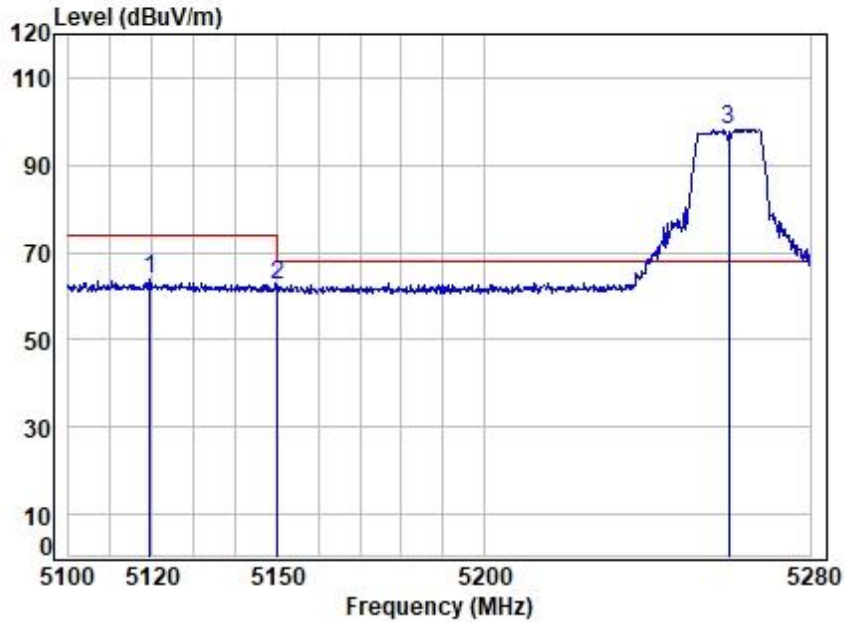

Site : chamber
 Condition: 3m HORIZONTAL
 Job No : 00466AT
 Mode : 5260 Band edge
 : 5G WIFI 11A

	Freq	Cable Loss	Ant Factor	Preamp Factor	Read Level	Level	Limit	Over	Remark
	MHz	dB	dB/m	dB	dBuV	dBuV/m	dBuV/m	dB	
1	5119.496	8.29	31.70	31.77	55.88	64.10	74.00	-9.90	peak
2	5149.980	8.29	31.77	31.82	54.40	62.64	74.00	-11.36	peak
3	5260.000	8.28	32.04	31.97	89.92	98.27	68.20	30.07	peak



Unless otherwise agreed in writing, this document is issued by the Company subject to its General Conditions of Service printed overleaf, available on request or accessible at <http://www.sgs.com/en/Terms-and-Conditions.aspx> and, for electronic format documents, subject to Terms and Conditions for Electronic Documents at <http://www.sgs.com/en/Terms-and-Conditions/Terms-e-Documents.aspx>. Attention is drawn to the limitation of liability, indemnification and jurisdiction issues defined therein. Any holder of this document is advised that information contained hereon reflects the Company's findings at the time of its intervention only and within the limits of Client's instructions, if any. The Company's sole responsibility is to its Client and this document does not exonerate parties to a transaction from exercising all their rights and obligations under the transaction documents. This document cannot be reproduced except in full, without prior written approval of the Company. Any unauthorized alteration, forgery or falsification of the content or appearance of this document is unlawful and offenders may be prosecuted to the fullest extent of the law. Unless otherwise stated the results shown in this test report refer only to the sample(s) tested and such sample(s) are retained for 30 days only.
Attention: To check the authenticity of testing /inspection report & certificate, please contact us at telephone: (86-755) 8307 1443, or email: CN.Doccheck@sgs.com

Fuyong lab, Xinlong TechnoPark, Fengtang Road, Fuyong Subdistrict, Bao'an, Shenzhen, China 518103 t (86-755) 88663988 f (86-755) 26710594 www.sgsgroup.com.cn
 中国·深圳·宝安区福永街道凤塘大道鑫龙科技园福永实验室 邮编: 518103 t (86-755) 88663988 f (86-755) 26710594 sgs.china@sgs.com

Compliance Certification Services (Kunshan) Inc. Shenzhen Branch

SZCCS-TRF-01 Rev. A/0 Aug01,2022

Report No.: FYCR221100046605

Page: 115 of 344

Test Mode: 10; Polarity: Horizontal; Modulation:802.11a; Bandwidth:20MHz; Channel:Low

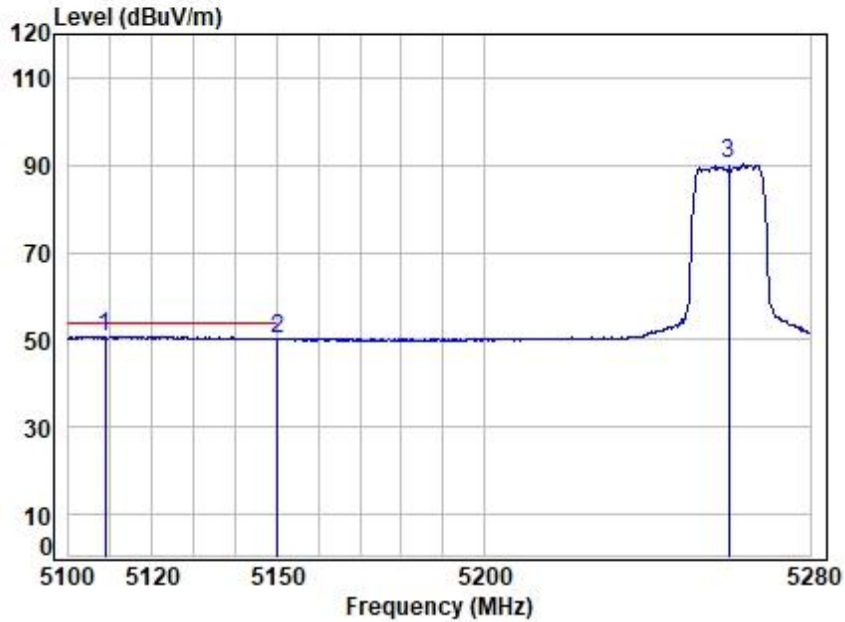

Site : chamber
 Condition: 3m HORIZONTAL
 Job No : 00466AT
 Mode : 5260 Band edge
 : 5G WIFI 11A

	Freq	Cable Loss	Ant Factor	Preamp Factor	Read Level	Limit Level	Over Limit	Remark
	MHz	dB	dB/m	dB	dBuV	dBuV/m	dBuV/m	dB
1	5108.675	8.29	31.67	31.76	42.54	50.74	54.00	-3.26 Average
2	5149.980	8.29	31.77	31.82	41.89	50.13	54.00	-3.87 Average
3	5260.000	8.28	32.04	31.97	81.83	90.18	-----	----- Average



Unless otherwise agreed in writing, this document is issued by the Company subject to its General Conditions of Service printed overleaf, available on request or accessible at <http://www.sgs.com/en/Terms-and-Conditions.aspx> and, for electronic format documents, subject to Terms and Conditions for Electronic Documents at <http://www.sgs.com/en/Terms-and-Conditions/Terms-e-Documents.aspx>. Attention is drawn to the limitation of liability, indemnification and jurisdiction issues defined therein. Any holder of this document is advised that information contained hereon reflects the Company's findings at the time of its intervention only and within the limits of Client's instructions, if any. The Company's sole responsibility is to its Client and this document does not exonerate parties to a transaction from exercising all their rights and obligations under the transaction documents. This document cannot be reproduced except in full, without prior written approval of the Company. Any unauthorized alteration, forgery or falsification of the content or appearance of this document is unlawful and offenders may be prosecuted to the fullest extent of the law. Unless otherwise stated the results shown in this test report refer only to the sample(s) tested and such sample(s) are retained for 30 days only.
Attention: To check the authenticity of testing /inspection report & certificate, please contact us at telephone: (86-755) 8307 1443, or email: CN.Doccheck@sgs.com

Fuyong lab, Xinlong TechnoPark, Fengtang Road, Fuyong Subdistrict, Bao'an, Shenzhen, China 518103 t (86-755) 88663988 f (86-755) 26710594 www.sgs.com.cn
 中国·深圳·宝安区福永街道凤塘大道鑫龙科技园福永实验室 邮编: 518103 t (86-755) 88663988 f (86-755) 26710594 sgs.china@sgs.com

Test Mode: 10; Polarity: Vertical; Modulation:802.11a; Bandwidth:20MHz; Channel:Low

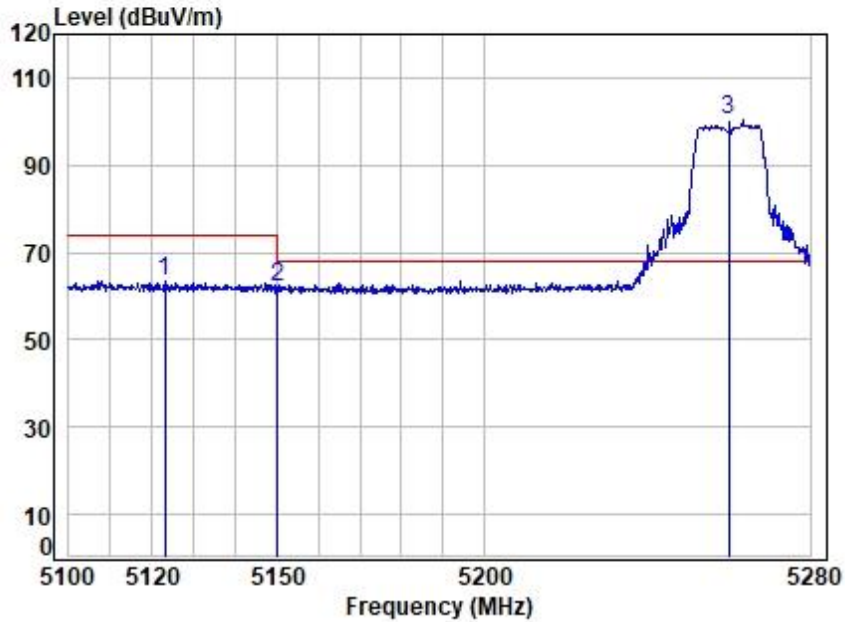

Site : chamber
 Condition: 3m VERTICAL
 Job No : 00466AT
 Mode : 5260 Band edge
 : 5G WIFI 11A

	Freq	Cable Loss	Ant Factor	Preamp Factor	Read Level	Level	Limit	Over	Remark
	MHz	dB	dB/m	dB	dBuV	dBuV/m	dBuV/m	dB	
1	5123.048	8.29	31.71	31.78	55.43	63.65	74.00	-10.35	Peak
2	5149.980	8.29	31.77	31.82	53.77	62.01	74.00	-11.99	Peak
3	5260.000	8.28	32.04	31.97	91.91	100.26	68.20	32.06	Peak



Unless otherwise agreed in writing, this document is issued by the Company subject to its General Conditions of Service printed overleaf, available on request or accessible at <http://www.sgs.com/en/Terms-and-Conditions.aspx> and, for electronic format documents, subject to Terms and Conditions for Electronic Documents at <http://www.sgs.com/en/Terms-and-Conditions/Terms-e-Documents.aspx>. Attention is drawn to the limitation of liability, indemnification and jurisdiction issues defined therein. Any holder of this document is advised that information contained hereon reflects the Company's findings at the time of its intervention only and within the limits of Client's instructions, if any. The Company's sole responsibility is to its Client and this document does not exonerate parties to a transaction from exercising all their rights and obligations under the transaction documents. This document cannot be reproduced except in full, without prior written approval of the Company. Any unauthorized alteration, forgery or falsification of the content or appearance of this document is unlawful and offenders may be prosecuted to the fullest extent of the law. Unless otherwise stated the results shown in this test report refer only to the sample(s) tested and such sample(s) are retained for 30 days only.
Attention: To check the authenticity of testing /inspection report & certificate, please contact us at telephone: (86-755) 8307 1443, or email: CN.Doccheck@sgs.com

Fuyong lab, Xinlong TechnoPark, Fengtang Road, Fuyong Subdistrict, Bao'an, Shenzhen, China 518103 t (86-755) 88663988 f (86-755) 26710594 www.sgsgroup.com.cn
 中国·深圳·宝安区福永街道凤塘大道鑫龙科技园福永实验室 邮编: 518103 t (86-755) 88663988 f (86-755) 26710594 sgs.china@sgs.com

Compliance Certification Services (Kunshan) Inc. Shenzhen Branch

SZCCS-TRF-01 Rev. A/0 Aug01,2022

Report No.: FYCR221100046605

Page: 117 of 344

Test Mode: 10; Polarity: Vertical; Modulation:802.11a; Bandwidth:20MHz; Channel:Low

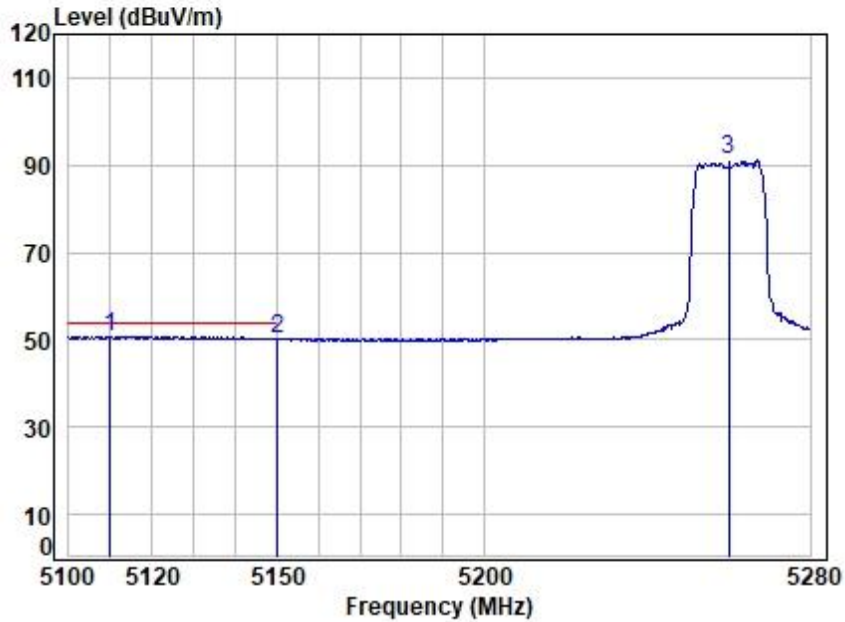

Site : chamber
 Condition: 3m VERTICAL
 Job No : 00466AT
 Mode : 5260 Band edge
 : 5G WIFI 11A

		Cable	Ant	Preamp	Read	Limit	Over	
	Freq	Loss	Factor	Factor	Level	Line	Limit	Remark
	MHz	dB	dB/m	dB	dBuV	dBuV/m	dBuV/m	dB
1	5109.916	8.29	31.67	31.76	42.57	50.77	54.00	-3.23 Average
2	5149.980	8.29	31.77	31.82	41.99	50.23	54.00	-3.77 Average
3	5260.000	8.28	32.04	31.97	82.69	91.04	-----	----- Average



Unless otherwise agreed in writing, this document is issued by the Company subject to its General Conditions of Service printed overleaf, available on request or accessible at <http://www.sgs.com/en/Terms-and-Conditions.aspx> and, for electronic format documents, subject to Terms and Conditions for Electronic Documents at <http://www.sgs.com/en/Terms-and-Conditions/Terms-e-Documents.aspx>. Attention is drawn to the limitation of liability, indemnification and jurisdiction issues defined therein. Any holder of this document is advised that information contained hereon reflects the Company's findings at the time of its intervention only and within the limits of Client's instructions, if any. The Company's sole responsibility is to its Client and this document does not exonerate parties to a transaction from exercising all their rights and obligations under the transaction documents. This document cannot be reproduced except in full, without prior written approval of the Company. Any unauthorized alteration, forgery or falsification of the content or appearance of this document is unlawful and offenders may be prosecuted to the fullest extent of the law. Unless otherwise stated the results shown in this test report refer only to the sample(s) tested and such sample(s) are retained for 30 days only.
Attention: To check the authenticity of testing /inspection report & certificate, please contact us at telephone: (86-755) 8307 1443, or email: CN.Doccheck@sgs.com

Fuyong lab, Xinlong TechnoPark, Fengtang Road, Fuyong Subdistrict, Bao'an, Shenzhen, China 518103 t (86-755) 88663988 f (86-755) 26710594 www.sgsgroup.com.cn
 中国·深圳·宝安区福永街道凤塘大道鑫龙科技园福永实验室 邮编: 518103 t (86-755) 88663988 f (86-755) 26710594 sgs.china@sgs.com

Test Mode: 10; Polarity: Horizontal; Modulation:802.11a; Bandwidth:20MHz; Channel:High

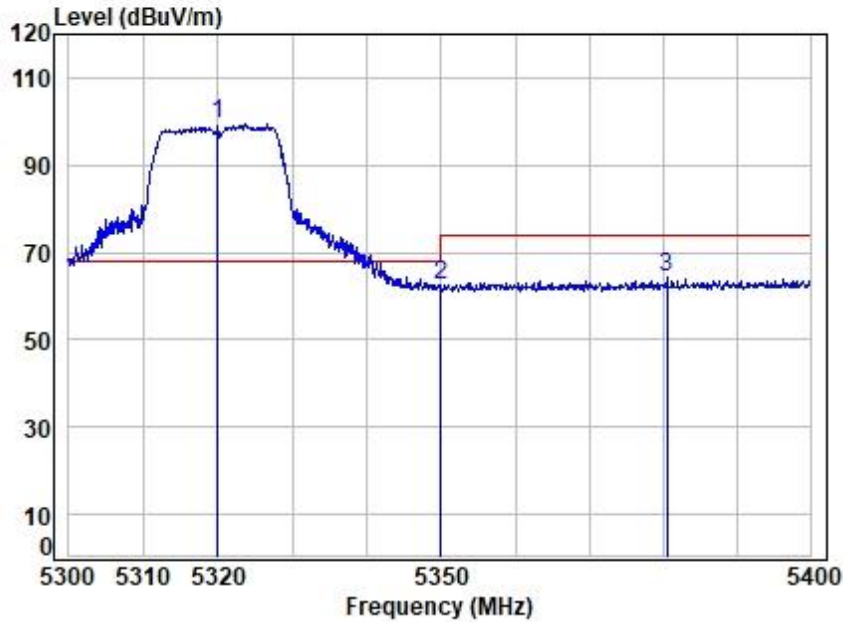

Site : chamber
 Condition: 3m HORIZONTAL
 Job No : 00466AT
 Mode : 5320 Band edge
 : 5G WIFI 11A

	Cable	Ant	Preamp	Read	Limit	Over		
Freq	Loss	Factor	Factor	Level	Level	Line	Limit	Remark
MHz	dB	dB/m	dB	dBuV	dBuV/m	dBuV/m	dB	
1 . 5320.000	8.28	32.18	32.06	91.13	99.53	68.20	31.33	peak
2 5350.020	8.28	32.25	32.10	54.26	62.69	74.00	-11.31	peak
3 5380.554	8.28	32.32	32.14	55.67	64.13	74.00	-9.87	peak



Unless otherwise agreed in writing, this document is issued by the Company subject to its General Conditions of Service printed overleaf, available on request or accessible at <http://www.sgs.com/en/Terms-and-Conditions.aspx> and, for electronic format documents, subject to Terms and Conditions for Electronic Documents at <http://www.sgs.com/en/Terms-and-Conditions/Terms-e-Documents.aspx>. Attention is drawn to the limitation of liability, indemnification and jurisdiction issues defined therein. Any holder of this document is advised that information contained hereon reflects the Company's findings at the time of its intervention only and within the limits of Client's instructions, if any. The Company's sole responsibility is to its Client and this document does not exonerate parties to a transaction from exercising all their rights and obligations under the transaction documents. This document cannot be reproduced except in full, without prior written approval of the Company. Any unauthorized alteration, forgery or falsification of the content or appearance of this document is unlawful and offenders may be prosecuted to the fullest extent of the law. Unless otherwise stated the results shown in this test report refer only to the sample(s) tested and such sample(s) are retained for 30 days only.
Attention: To check the authenticity of testing /inspection report & certificate, please contact us at telephone: (86-755) 8307 1443, or email: CN.Doccheck@sgs.com

Fuyong lab, Xinlong TechnoPark, Fengtang Road, Fuyong Subdistrict, Bao'an, Shenzhen, China 518103 t (86-755) 88663988 f (86-755) 26710594 www.sgsgroup.com.cn
 中国·深圳·宝安区福永街道凤塘大道鑫龙科技园福永实验室 邮编: 518103 t (86-755) 88663988 f (86-755) 26710594 sgs.china@sgs.com

Compliance Certification Services (Kunshan) Inc. Shenzhen Branch

SZCCS-TRF-01 Rev. A/0 Aug01,2022

Report No.: FYCR221100046605

Page: 119 of 344

Test Mode: 10; Polarity: Horizontal; Modulation:802.11a; Bandwidth:20MHz; Channel:High

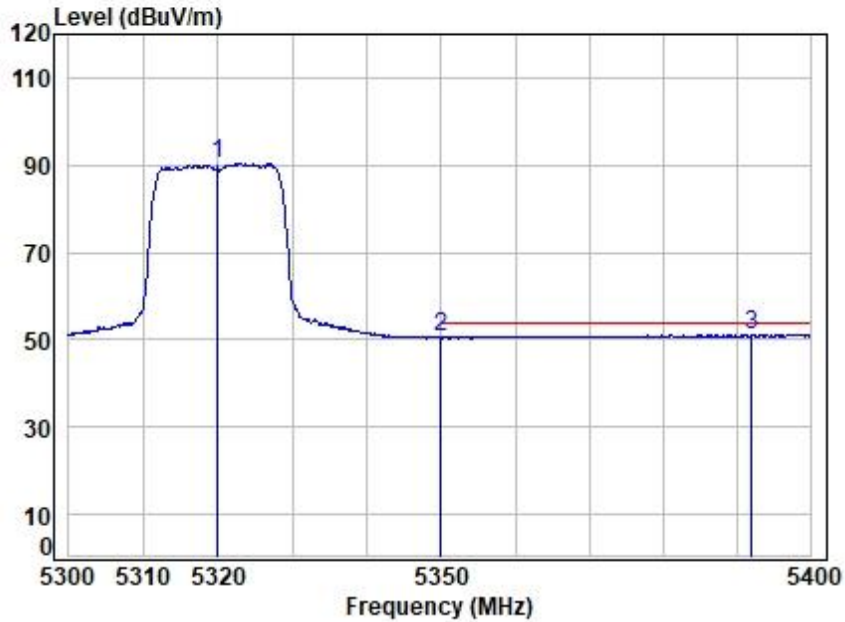

Site : chamber
 Condition: 3m HORIZONTAL
 Job No : 00466AT
 Mode : 5320 Band edge
 : 5G WIFI 11A

	Freq	Cable Loss	Ant Factor	Preamp Factor	Read Level	Level	Limit	Over	Remark
	MHz	dB	dB/m	dB	dBuV	dBuV/m	dBuV/m	dB	
1	5320.000	8.28	32.18	32.06	81.96	90.36	54.00	36.36	Average
2	5350.020	8.28	32.25	32.10	42.13	50.56	54.00	-3.44	Average
3	5392.032	8.28	32.35	32.15	42.65	51.13	54.00	-2.87	Average



Unless otherwise agreed in writing, this document is issued by the Company subject to its General Conditions of Service printed overleaf, available on request or accessible at <http://www.sgs.com/en/Terms-and-Conditions.aspx> and, for electronic format documents, subject to Terms and Conditions for Electronic Documents at <http://www.sgs.com/en/Terms-and-Conditions/Terms-e-Documents.aspx>. Attention is drawn to the limitation of liability, indemnification and jurisdiction issues defined therein. Any holder of this document is advised that information contained hereon reflects the Company's findings at the time of its intervention only and within the limits of Client's instructions, if any. The Company's sole responsibility is to its Client and this document does not exonerate parties to a transaction from exercising all their rights and obligations under the transaction documents. This document cannot be reproduced except in full, without prior written approval of the Company. Any unauthorized alteration, forgery or falsification of the content or appearance of this document is unlawful and offenders may be prosecuted to the fullest extent of the law. Unless otherwise stated the results shown in this test report refer only to the sample(s) tested and such sample(s) are retained for 30 days only.
Attention: To check the authenticity of testing /inspection report & certificate, please contact us at telephone: (86-755) 8307 1443, or email: CN.Doccheck@sgs.com

Fuyong lab, Xinlong TechnoPark, Fengtang Road, Fuyong Subdistrict, Bao'an, Shenzhen, China 518103 t (86-755) 88663988 f (86-755) 26710594 www.sgsgroup.com.cn
 中国·深圳·宝安区福永街道凤塘大道鑫龙科技园福永实验室 邮编: 518103 t (86-755) 88663988 f (86-755) 26710594 sgs.china@sgs.com

Test Mode: 10; Polarity: Vertical; Modulation:802.11a; Bandwidth:20MHz; Channel:High

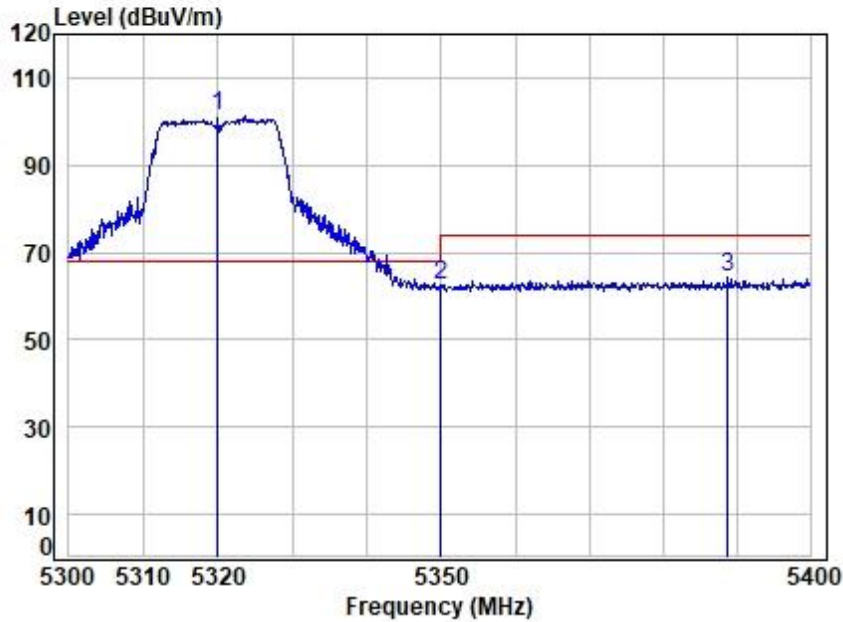

Site : chamber
 Condition: 3m VERTICAL
 Job No : 00466AT
 Mode : 5320 Band edge
 : 5G WIFI 11A

	Cable	Ant	Preamp	Read	Limit	Over		
Freq	Loss	Factor	Factor	Level	Level	Line	Limit	Remark
MHz	dB	dB/m	dB	dBuV	dBuV/m	dBuV/m	dB	
1 . 5320.000	8.28	32.18	32.06	92.68	101.08	68.20	32.88	Peak
2 5350.020	8.28	32.25	32.10	53.98	62.41	74.00	-11.59	Peak
3 5388.808	8.28	32.34	32.15	55.77	64.24	74.00	-9.76	Peak



Unless otherwise agreed in writing, this document is issued by the Company subject to its General Conditions of Service printed overleaf, available on request or accessible at <http://www.sgs.com/en/Terms-and-Conditions.aspx> and, for electronic format documents, subject to Terms and Conditions for Electronic Documents at <http://www.sgs.com/en/Terms-and-Conditions/Terms-e-Documents.aspx>. Attention is drawn to the limitation of liability, indemnification and jurisdiction issues defined therein. Any holder of this document is advised that information contained hereon reflects the Company's findings at the time of its intervention only and within the limits of Client's instructions, if any. The Company's sole responsibility is to its Client and this document does not exonerate parties to a transaction from exercising all their rights and obligations under the transaction documents. This document cannot be reproduced except in full, without prior written approval of the Company. Any unauthorized alteration, forgery or falsification of the content or appearance of this document is unlawful and offenders may be prosecuted to the fullest extent of the law. Unless otherwise stated the results shown in this test report refer only to the sample(s) tested and such sample(s) are retained for 30 days only.
Attention: To check the authenticity of testing /inspection report & certificate, please contact us at telephone: (86-755) 8307 1443, or email: CN.Doccheck@sgs.com

Fuyong lab, Xinlong TechnoPark, Fengtang Road, Fuyong Subdistrict, Bao'an, Shenzhen, China 518103 t (86-755) 88663988 f (86-755) 26710594 www.sgsgroup.com.cn
 中国·深圳·宝安区福永街道凤塘大道鑫龙科技园福永实验室 邮编: 518103 t (86-755) 88663988 f (86-755) 26710594 sgs.china@sgs.com

Compliance Certification Services (Kunshan) Inc. Shenzhen Branch

SZCCS-TRF-01 Rev. A/0 Aug01,2022

Report No.: FYCR221100046605

Page: 121 of 344

Test Mode: 10; Polarity: Vertical; Modulation:802.11a; Bandwidth:20MHz; Channel:High

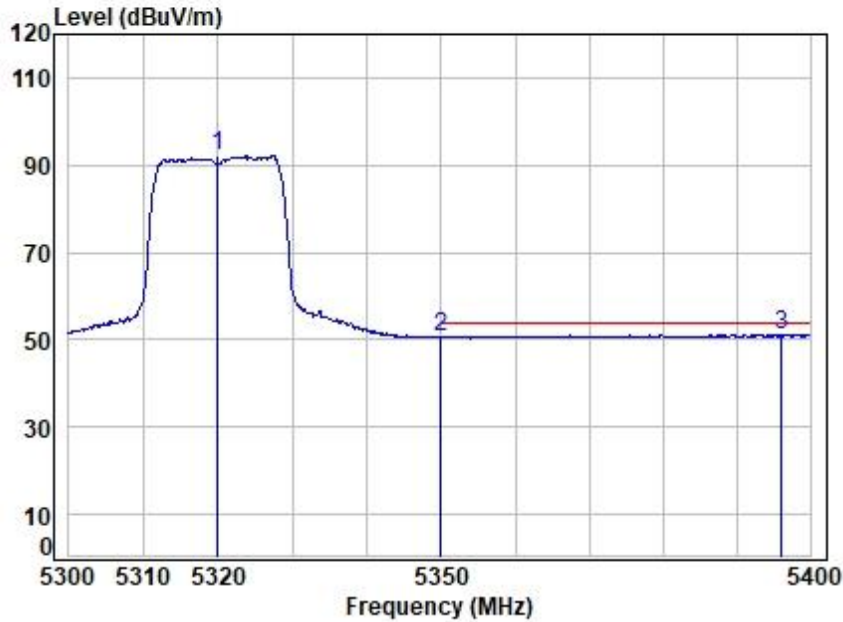

Site : chamber
 Condition: 3m VERTICAL
 Job No : 00466AT
 Mode : 5320 Band edge
 : 5G WIFI 11A

	Freq	Cable Loss	Ant Factor	Preamp Factor	Read Level	Level	Limit	Over	Remark
	MHz	dB	dB/m	dB	dBuV	dBuV/m	dBuV/m	dB	
1	5320.000	8.28	32.18	32.06	83.70	92.10	54.00	38.10	Average
2	5350.020	8.28	32.25	32.10	42.23	50.66	54.00	-3.34	Average
3	5396.065	8.28	32.36	32.16	42.65	51.13	54.00	-2.87	Average



Unless otherwise agreed in writing, this document is issued by the Company subject to its General Conditions of Service printed overleaf, available on request or accessible at <http://www.sgs.com/en/Terms-and-Conditions.aspx> and, for electronic format documents, subject to Terms and Conditions for Electronic Documents at <http://www.sgs.com/en/Terms-and-Conditions/Terms-e-Documents.aspx>. Attention is drawn to the limitation of liability, indemnification and jurisdiction issues defined therein. Any holder of this document is advised that information contained hereon reflects the Company's findings at the time of its intervention only and within the limits of Client's instructions, if any. The Company's sole responsibility is to its Client and this document does not exonerate parties to a transaction from exercising all their rights and obligations under the transaction documents. This document cannot be reproduced except in full, without prior written approval of the Company. Any unauthorized alteration, forgery or falsification of the content or appearance of this document is unlawful and offenders may be prosecuted to the fullest extent of the law. Unless otherwise stated the results shown in this test report refer only to the sample(s) tested and such sample(s) are retained for 30 days only.
Attention: To check the authenticity of testing /inspection report & certificate, please contact us at telephone: (86-755) 8307 1443, or email: CN.Doccheck@sgs.com

Fuyong lab, Xinlong TechnoPark, Fengtang Road, Fuyong Subdistrict, Bao'an, Shenzhen, China 518103 t (86-755) 88663988 f (86-755) 26710594 www.sgsgroup.com.cn
 中国·深圳·宝安区福永街道凤塘大道鑫龙科技园福永实验室 邮编: 518103 t (86-755) 88663988 f (86-755) 26710594 sgs.china@sgs.com

Test Mode: 10; Polarity: Horizontal; Modulation:802.11n; Bandwidth:20MHz; Channel:Low

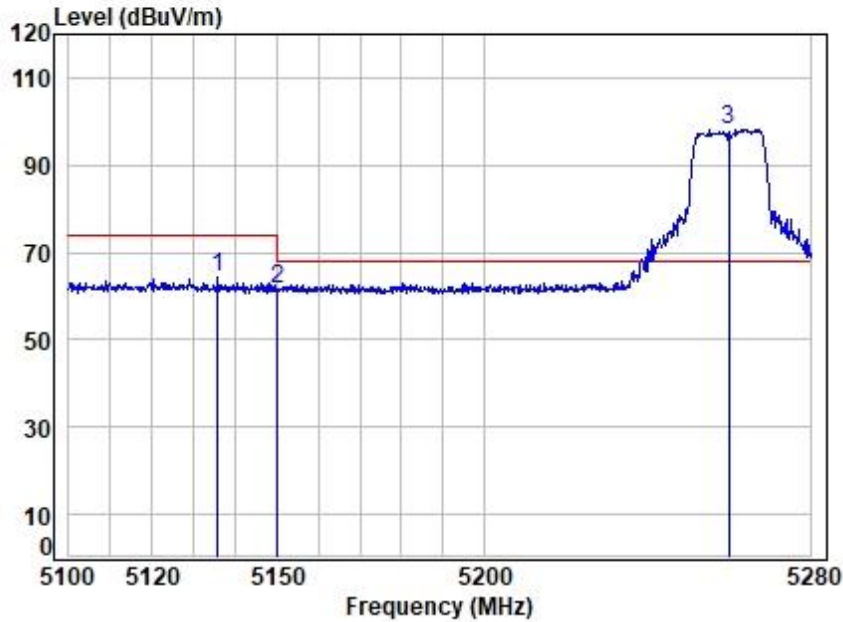

Site : chamber
 Condition: 3m HORIZONTAL
 Job No : 00466AT
 Mode : 5260 Band edge
 : 5G WIFI 11N20

		Cable	Ant	Preamp	Read	Limit	Over	
	Freq	Loss	Factor	Factor	Level	Line	Limit	Remark
	MHz	dB	dB/m	dB	dBuV	dBuV/m	dBuV/m	dB
1	5135.680	8.29	31.74	31.80	56.00	64.23	74.00	-9.77 peak
2	5149.980	8.29	31.77	31.82	53.51	61.75	74.00	-12.25 peak
3	5260.000	8.28	32.04	31.97	89.81	98.16	68.20	29.96 peak



Unless otherwise agreed in writing, this document is issued by the Company subject to its General Conditions of Service printed overleaf, available on request or accessible at <http://www.sgs.com/en/Terms-and-Conditions.aspx> and, for electronic format documents, subject to Terms and Conditions for Electronic Documents at <http://www.sgs.com/en/Terms-and-Conditions/Terms-e-Documents.aspx>. Attention is drawn to the limitation of liability, indemnification and jurisdiction issues defined therein. Any holder of this document is advised that information contained hereon reflects the Company's findings at the time of its intervention only and within the limits of Client's instructions, if any. The Company's sole responsibility is to its Client and this document does not exonerate parties to a transaction from exercising all their rights and obligations under the transaction documents. This document cannot be reproduced except in full, without prior written approval of the Company. Any unauthorized alteration, forgery or falsification of the content or appearance of this document is unlawful and offenders may be prosecuted to the fullest extent of the law. Unless otherwise stated the results shown in this test report refer only to the sample(s) tested and such sample(s) are retained for 30 days only.
Attention: To check the authenticity of testing /inspection report & certificate, please contact us at telephone: (86-755) 8307 1443, or email: CN.Doccheck@sgs.com

Fuyong lab, Xinlong TechnoPark, Fengtang Road, Fuyong Subdistrict, Bao'an, Shenzhen, China 518103 t (86-755) 88663988 f (86-755) 26710594 www.sgsgroup.com.cn
 中国·深圳·宝安区福永街道凤塘大道鑫龙科技园福永实验室 邮编: 518103 t (86-755) 88663988 f (86-755) 26710594 sgs.china@sgs.com

Test Mode: 10; Polarity: Horizontal; Modulation:802.11n; Bandwidth:20MHz; Channel:Low

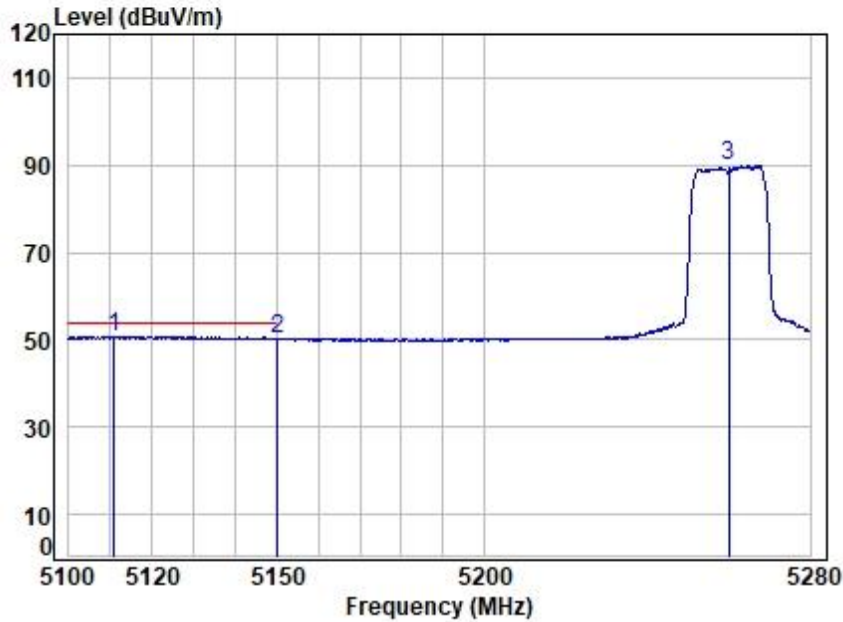

Site : chamber
 Condition: 3m HORIZONTAL
 Job No : 00466AT
 Mode : 5260 Band edge
 : 5G WIFI 11N20

	Freq	Cable Loss	Ant Factor	Preamp Factor	Read Level	Level	Limit	Over	Remark
	MHz	dB	dB/m	dB	dBuV	dBuV/m	dBuV/m	dB	
1	5110.802	8.29	31.68	31.76	42.53	50.74	54.00	-3.26	Average
2	5149.980	8.29	31.77	31.82	42.04	50.28	54.00	-3.72	Average
3	5260.000	8.28	32.04	31.97	81.46	89.81	-----	-----	Average



Unless otherwise agreed in writing, this document is issued by the Company subject to its General Conditions of Service printed overleaf, available on request or accessible at <http://www.sgs.com/en/Terms-and-Conditions.aspx> and, for electronic format documents, subject to Terms and Conditions for Electronic Documents at <http://www.sgs.com/en/Terms-and-Conditions/Terms-e-Documents.aspx>. Attention is drawn to the limitation of liability, indemnification and jurisdiction issues defined therein. Any holder of this document is advised that information contained hereon reflects the Company's findings at the time of its intervention only and within the limits of Client's instructions, if any. The Company's sole responsibility is to its Client and this document does not exonerate parties to a transaction from exercising all their rights and obligations under the transaction documents. This document cannot be reproduced except in full, without prior written approval of the Company. Any unauthorized alteration, forgery or falsification of the content or appearance of this document is unlawful and offenders may be prosecuted to the fullest extent of the law. Unless otherwise stated the results shown in this test report refer only to the sample(s) tested and such sample(s) are retained for 30 days only.
Attention: To check the authenticity of testing /inspection report & certificate, please contact us at telephone: (86-755) 8307 1443, or email: CN.Doccheck@sgs.com

Fuyong lab, Xinlong TechnoPark, Fengtang Road, Fuyong Subdistrict, Bao'an, Shenzhen, China 518103 t (86-755) 88663988 f (86-755) 26710594 www.sgs.com.cn
 中国·深圳·宝安区福永街道凤塘大道鑫龙科技园福永实验室 邮编: 518103 t (86-755) 88663988 f (86-755) 26710594 sgs.china@sgs.com

Test Mode: 10; Polarity: Vertical; Modulation:802.11n; Bandwidth:20MHz; Channel:Low

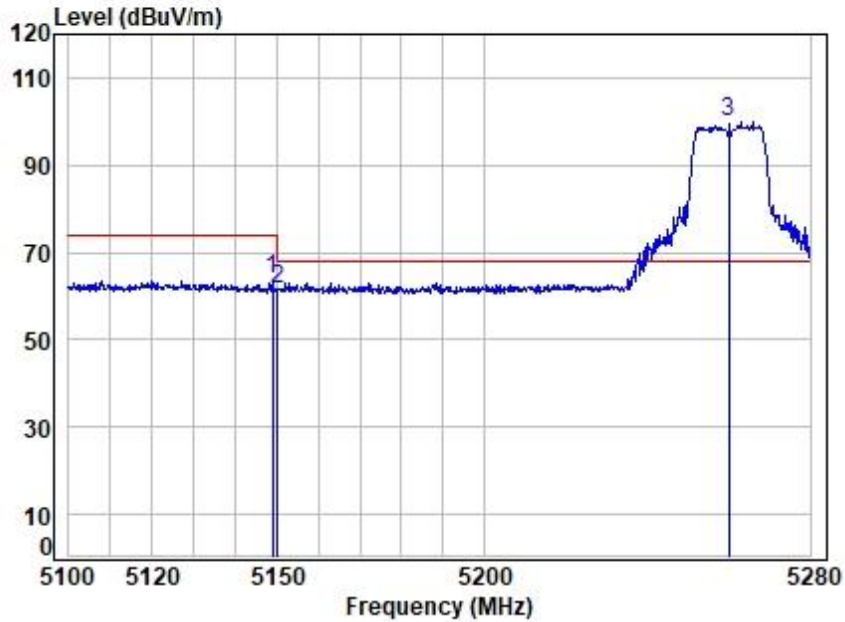

Site : chamber
 Condition: 3m VERTICAL
 Job No : 00466AT
 Mode : 5260 Band edge
 : 5G WIFI 11N20

		Cable	Ant	Preamp	Read	Limit	Over	
	Freq	Loss	Factor	Factor	Level	Line	Limit	Remark
	MHz	dB	dB/m	dB	dBuV	dBuV/m	dBuV/m	dB
1	5148.879	8.29	31.77	31.82	55.44	63.68	74.00	-10.32 Peak
2	5149.980	8.29	31.77	31.82	53.40	61.64	74.00	-12.36 Peak
3	5260.000	8.28	32.04	31.97	91.58	99.93	68.20	31.73 Peak



Unless otherwise agreed in writing, this document is issued by the Company subject to its General Conditions of Service printed overleaf, available on request or accessible at <http://www.sgs.com/en/Terms-and-Conditions.aspx> and, for electronic format documents, subject to Terms and Conditions for Electronic Documents at <http://www.sgs.com/en/Terms-and-Conditions/Terms-e-Documents.aspx>. Attention is drawn to the limitation of liability, indemnification and jurisdiction issues defined therein. Any holder of this document is advised that information contained hereon reflects the Company's findings at the time of its intervention only and within the limits of Client's instructions, if any. The Company's sole responsibility is to its Client and this document does not exonerate parties to a transaction from exercising all their rights and obligations under the transaction documents. This document cannot be reproduced except in full, without prior written approval of the Company. Any unauthorized alteration, forgery or falsification of the content or appearance of this document is unlawful and offenders may be prosecuted to the fullest extent of the law. Unless otherwise stated the results shown in this test report refer only to the sample(s) tested and such sample(s) are retained for 30 days only.
Attention: To check the authenticity of testing /inspection report & certificate, please contact us at telephone: (86-755) 8307 1443, or email: CN.Doccheck@sgs.com

Fuyong lab, Xinlong TechnoPark, Fengtang Road, Fuyong Subdistrict, Bao'an, Shenzhen, China 518103 t (86-755) 88663988 f (86-755) 26710594 www.sgsgroup.com.cn
 中国·深圳·宝安区福永街道凤塘大道鑫龙科技园福永实验室 邮编: 518103 t (86-755) 88663988 f (86-755) 26710594 sgs.china@sgs.com

Test Mode: 10; Polarity: Vertical; Modulation:802.11n; Bandwidth:20MHz; Channel:Low

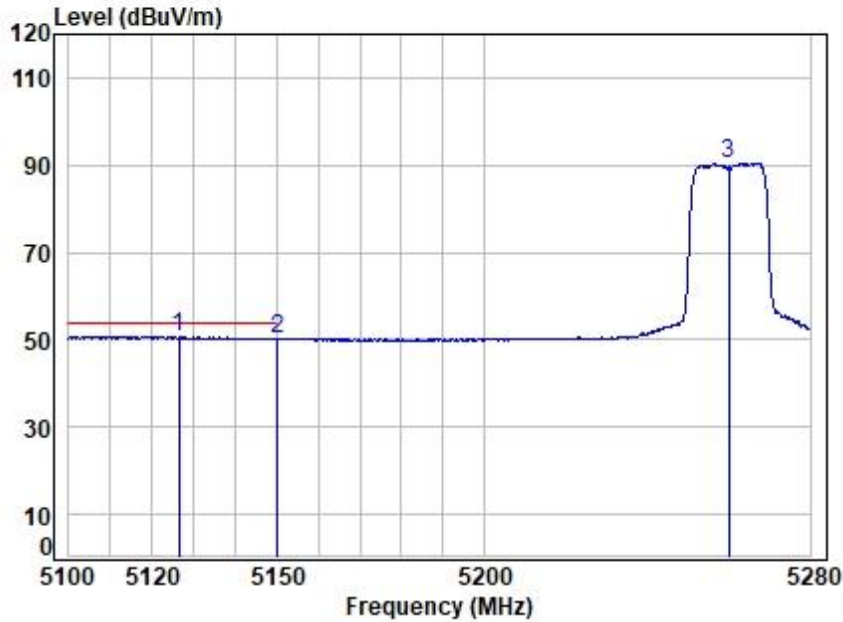

Site : chamber
 Condition: 3m VERTICAL
 Job No : 00466AT
 Mode : 5260 Band edge
 : 5G WIFI 11N20

		Cable	Ant	Preamp	Read	Limit	Over	
	Freq	Loss	Factor	Factor	Level	Line	Limit	Remark
	MHz	dB	dB/m	dB	dBuV	dBuV/m	dBuV/m	dB
1	5126.248	8.29	31.71	31.78	42.52	50.74	54.00	-3.26 Average
2	5149.980	8.29	31.77	31.82	42.06	50.30	54.00	-3.70 Average
3	5260.000	8.28	32.04	31.97	82.12	90.47	-----	----- Average



Unless otherwise agreed in writing, this document is issued by the Company subject to its General Conditions of Service printed overleaf, available on request or accessible at <http://www.sgs.com/en/Terms-and-Conditions.aspx> and, for electronic format documents, subject to Terms and Conditions for Electronic Documents at <http://www.sgs.com/en/Terms-and-Conditions/Terms-e-Documents.aspx>. Attention is drawn to the limitation of liability, indemnification and jurisdiction issues defined therein. Any holder of this document is advised that information contained hereon reflects the Company's findings at the time of its intervention only and within the limits of Client's instructions, if any. The Company's sole responsibility is to its Client and this document does not exonerate parties to a transaction from exercising all their rights and obligations under the transaction documents. This document cannot be reproduced except in full, without prior written approval of the Company. Any unauthorized alteration, forgery or falsification of the content or appearance of this document is unlawful and offenders may be prosecuted to the fullest extent of the law. Unless otherwise stated the results shown in this test report refer only to the sample(s) tested and such sample(s) are retained for 30 days only.
Attention: To check the authenticity of testing /inspection report & certificate, please contact us at telephone: (86-755) 8307 1443, or email: CN.Doccheck@sgs.com

Fuyong lab, Xinlong TechnoPark, Fengtang Road, Fuyong Subdistrict, Bao'an, Shenzhen, China 518103 t (86-755) 88663988 f (86-755) 26710594 www.sgsgroup.com.cn
 中国·深圳·宝安区福永街道凤塘大道鑫龙科技园福永实验室 邮编: 518103 t (86-755) 88663988 f (86-755) 26710594 sgs.china@sgs.com

Test Mode: 10; Polarity: Horizontal; Modulation:802.11n; Bandwidth:20MHz; Channel:High

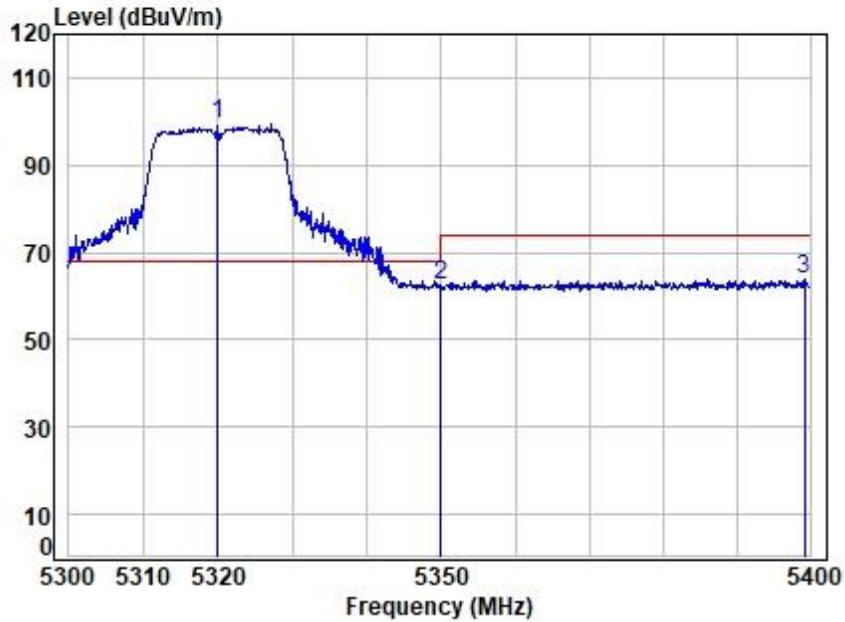

Site : chamber
 Condition: 3m HORIZONTAL
 Job No : 00466AT
 Mode : 5320 Band edge
 : 5G WIFI 11N20

		Cable	Ant	Preamp	Read	Limit	Over	
	Freq	Loss	Factor	Factor	Level	Level	Line	Limit
	MHz	dB	dB/m	dB	dBuV	dBuV/m	dBuV/m	dB
1	5320.000	8.28	32.18	32.06	90.95	99.35	68.20	31.15 peak
2	5350.020	8.28	32.25	32.10	53.96	62.39	74.00	-11.61 peak
3	5399.192	8.28	32.37	32.16	55.35	63.84	74.00	-10.16 peak



Unless otherwise agreed in writing, this document is issued by the Company subject to its General Conditions of Service printed overleaf, available on request or accessible at <http://www.sgs.com/en/Terms-and-Conditions.aspx> and, for electronic format documents, subject to Terms and Conditions for Electronic Documents at <http://www.sgs.com/en/Terms-and-Conditions/Terms-e-Documents.aspx>. Attention is drawn to the limitation of liability, indemnification and jurisdiction issues defined therein. Any holder of this document is advised that information contained hereon reflects the Company's findings at the time of its intervention only and within the limits of Client's instructions, if any. The Company's sole responsibility is to its Client and this document does not exonerate parties to a transaction from exercising all their rights and obligations under the transaction documents. This document cannot be reproduced except in full, without prior written approval of the Company. Any unauthorized alteration, forgery or falsification of the content or appearance of this document is unlawful and offenders may be prosecuted to the fullest extent of the law. Unless otherwise stated the results shown in this test report refer only to the sample(s) tested and such sample(s) are retained for 30 days only.
Attention: To check the authenticity of testing /inspection report & certificate, please contact us at telephone: (86-755) 8307 1443, or email: CN.Doccheck@sgs.com

Fuyong lab, Xinlong TechnoPark, Fengtang Road, Fuyong Subdistrict, Bao'an, Shenzhen, China 518103 t (86-755) 88663988 f (86-755) 26710594 www.sgsgroup.com.cn
 中国·深圳·宝安区福永街道凤塘大道鑫龙科技园福永实验室 邮编: 518103 t (86-755) 88663988 f (86-755) 26710594 sgs.china@sgs.com

Compliance Certification Services (Kunshan) Inc. Shenzhen Branch

SZCCS-TRF-01 Rev. A/0 Aug01,2022

Report No.: FYCR221100046605

Page: 127 of 344

Test Mode: 10; Polarity: Horizontal; Modulation:802.11n; Bandwidth:20MHz; Channel:High

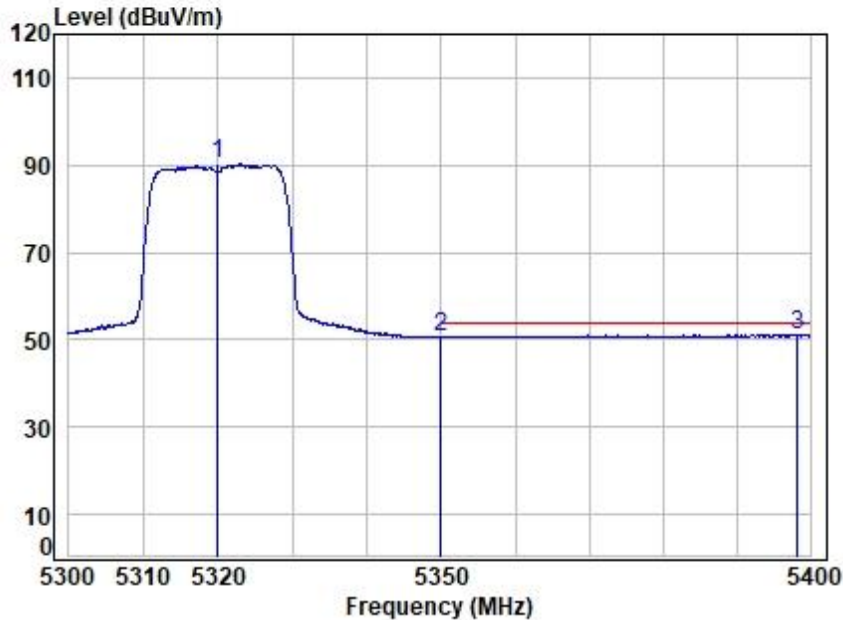

Site : chamber
 Condition: 3m HORIZONTAL
 Job No : 00466AT
 Mode : 5320 Band edge
 : 5G WIFI 11N20

	Freq	Cable Loss	Ant Factor	Preamp Factor	Read Level	Level	Limit	Over	Remark
	MHz	dB	dB/m	dB	dBuV	dBuV/m	dBuV/m	dB	
1	5320.000	8.28	32.18	32.06	81.94	90.34	54.00	36.34	Average
2	5350.020	8.28	32.25	32.10	42.28	50.71	54.00	-3.29	Average
3	5398.284	8.28	32.36	32.16	42.67	51.15	54.00	-2.85	Average



Unless otherwise agreed in writing, this document is issued by the Company subject to its General Conditions of Service printed overleaf, available on request or accessible at <http://www.sgs.com/en/Terms-and-Conditions.aspx> and, for electronic format documents, subject to Terms and Conditions for Electronic Documents at <http://www.sgs.com/en/Terms-and-Conditions/Terms-e-Documents.aspx>. Attention is drawn to the limitation of liability, indemnification and jurisdiction issues defined therein. Any holder of this document is advised that information contained hereon reflects the Company's findings at the time of its intervention only and within the limits of Client's instructions, if any. The Company's sole responsibility is to its Client and this document does not exonerate parties to a transaction from exercising all their rights and obligations under the transaction documents. This document cannot be reproduced except in full, without prior written approval of the Company. Any unauthorized alteration, forgery or falsification of the content or appearance of this document is unlawful and offenders may be prosecuted to the fullest extent of the law. Unless otherwise stated the results shown in this test report refer only to the sample(s) tested and such sample(s) are retained for 30 days only.
Attention: To check the authenticity of testing /inspection report & certificate, please contact us at telephone: (86-755) 8307 1443, or email: CN.Doccheck@sgs.com

Fuyong lab, Xinlong TechnoPark, Fengtang Road, Fuyong Subdistrict, Bao'an, Shenzhen, China 518103 t (86-755) 88663988 f (86-755) 26710594 www.sgsgroup.com.cn
 中国·深圳·宝安区福永街道凤塘大道鑫龙科技园福永实验室 邮编: 518103 t (86-755) 88663988 f (86-755) 26710594 sgs.china@sgs.com

Test Mode: 10; Polarity: Vertical; Modulation:802.11n; Bandwidth:20MHz; Channel:High

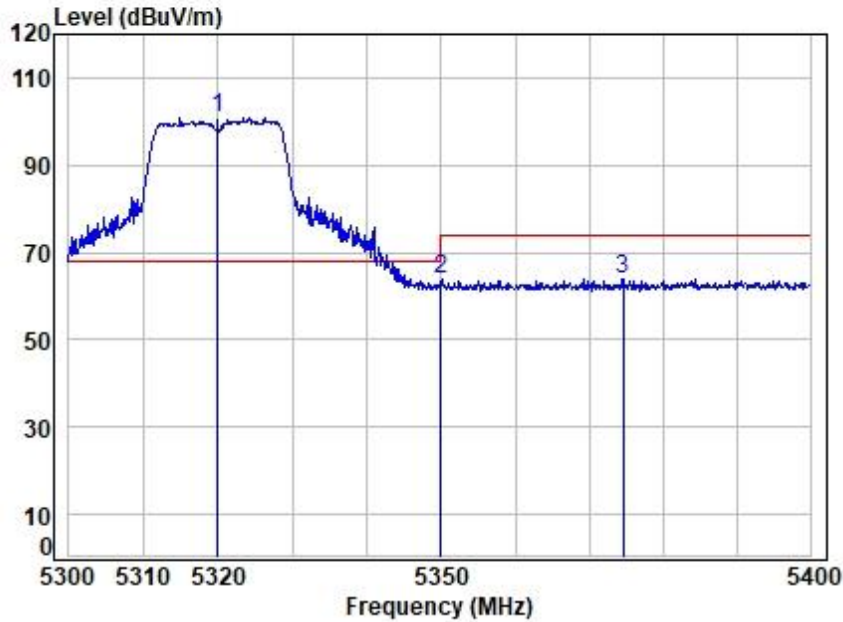

Site : chamber
 Condition: 3m VERTICAL
 Job No : 00466AT
 Mode : 5320 Band edge
 : 5G WIFI 11N20

		Cable	Ant	Preamp	Read	Limit	Over	
	Freq	Loss	Factor	Factor	Level	Line	Limit	Remark
	MHz	dB	dB/m	dB	dBuV	dBuV/m	dBuV/m	dB
1	5320.000	8.28	32.18	32.06	92.57	100.97	68.20	32.77 Peak
2	5350.020	8.28	32.25	32.10	55.59	64.02	74.00	-9.98 Peak
3	5374.624	8.28	32.31	32.13	55.37	63.83	74.00	-10.17 Peak



Unless otherwise agreed in writing, this document is issued by the Company subject to its General Conditions of Service printed overleaf, available on request or accessible at <http://www.sgs.com/en/Terms-and-Conditions.aspx> and, for electronic format documents, subject to Terms and Conditions for Electronic Documents at <http://www.sgs.com/en/Terms-and-Conditions/Terms-e-Documents.aspx>. Attention is drawn to the limitation of liability, indemnification and jurisdiction issues defined therein. Any holder of this document is advised that information contained hereon reflects the Company's findings at the time of its intervention only and within the limits of Client's instructions, if any. The Company's sole responsibility is to its Client and this document does not exonerate parties to a transaction from exercising all their rights and obligations under the transaction documents. This document cannot be reproduced except in full, without prior written approval of the Company. Any unauthorized alteration, forgery or falsification of the content or appearance of this document is unlawful and offenders may be prosecuted to the fullest extent of the law. Unless otherwise stated the results shown in this test report refer only to the sample(s) tested and such sample(s) are retained for 30 days only.
Attention: To check the authenticity of testing /inspection report & certificate, please contact us at telephone: (86-755) 8307 1443, or email: CN.Doccheck@sgs.com

Fuyong lab, Xinlong TechnoPark, Fengtang Road, Fuyong Subdistrict, Bao'an, Shenzhen, China 518103 t (86-755) 88663988 f (86-755) 26710594 www.sgsgroup.com.cn
 中国·深圳·宝安区福永街道凤塘大道鑫龙科技园福永实验室 邮编: 518103 t (86-755) 88663988 f (86-755) 26710594 sgs.china@sgs.com

Test Mode: 10; Polarity: Vertical; Modulation:802.11n; Bandwidth:20MHz; Channel:High

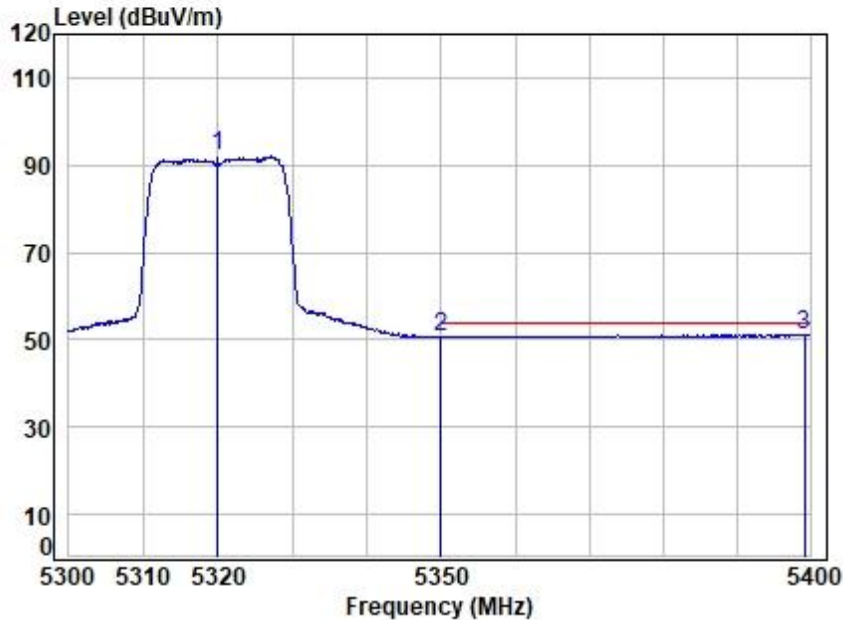

Site : chamber
 Condition: 3m VERTICAL
 Job No : 00466AT
 Mode : 5320 Band edge
 : 5G WIFI 11N20

	Freq	Cable Loss	Ant Factor	Preamp Factor	Read Level	Level	Limit	Over	Remark
	MHz	dB	dB/m	dB	dBuV	dBuV/m	dBuV/m	dB	
1	5320.000	8.28	32.18	32.06	83.65	92.05	54.00	38.05	Average
2	5350.020	8.28	32.25	32.10	42.26	50.69	54.00	-3.31	Average
3	5399.192	8.28	32.37	32.16	42.74	51.23	54.00	-2.77	Average



Unless otherwise agreed in writing, this document is issued by the Company subject to its General Conditions of Service printed overleaf, available on request or accessible at <http://www.sgs.com/en/Terms-and-Conditions.aspx> and, for electronic format documents, subject to Terms and Conditions for Electronic Documents at <http://www.sgs.com/en/Terms-and-Conditions/Terms-e-Documents.aspx>. Attention is drawn to the limitation of liability, indemnification and jurisdiction issues defined therein. Any holder of this document is advised that information contained hereon reflects the Company's findings at the time of its intervention only and within the limits of Client's instructions, if any. The Company's sole responsibility is to its Client and this document does not exonerate parties to a transaction from exercising all their rights and obligations under the transaction documents. This document cannot be reproduced except in full, without prior written approval of the Company. Any unauthorized alteration, forgery or falsification of the content or appearance of this document is unlawful and offenders may be prosecuted to the fullest extent of the law. Unless otherwise stated the results shown in this test report refer only to the sample(s) tested and such sample(s) are retained for 30 days only.
Attention: To check the authenticity of testing /inspection report & certificate, please contact us at telephone: (86-755) 8307 1443, or email: CN.Doccheck@sgs.com

Fuyong lab, Xinlong TechnoPark, Fengtang Road, Fuyong Subdistrict, Bao'an, Shenzhen, China 518103 t (86-755) 88663988 f (86-755) 26710594 www.sgsgroup.com.cn
 中国·深圳·宝安区福永街道凤塘大道鑫龙科技园福永实验室 邮编: 518103 t (86-755) 88663988 f (86-755) 26710594 sgs.china@sgs.com

Test Mode: 10; Polarity: Horizontal; Modulation:802.11n; Bandwidth:40MHz; Channel:Low

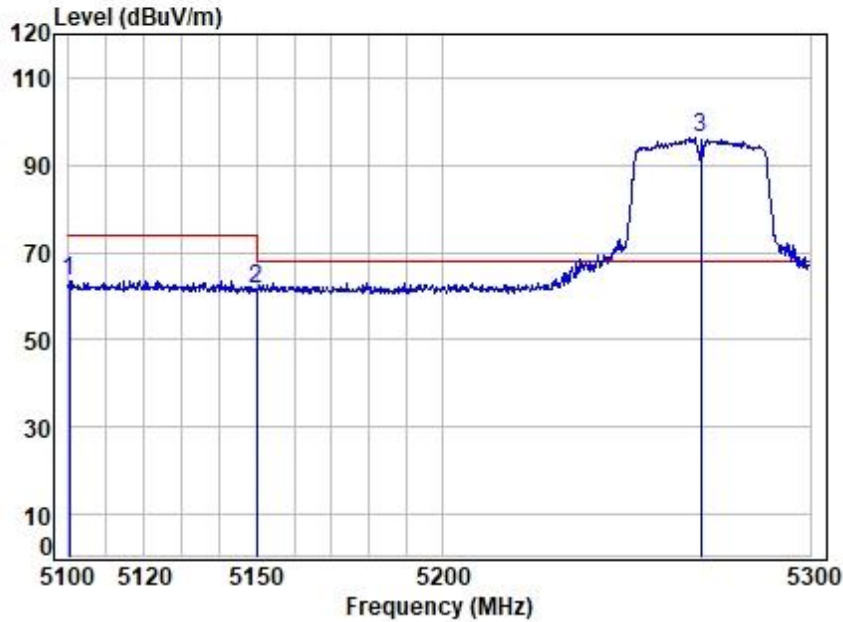

Site : chamber
 Condition: 3m HORIZONTAL
 Job No : 00466AT
 Mode : 5270 Band edge
 : 5G WIFI 11N40

	Freq	Cable Loss	Ant Factor	Preamp Factor	Read Level	Level	Limit	Over	Remark
	MHz	dB	dB/m	dB	dBuV	dBuV/m	dBuV/m	dB	
1	5100.196	8.29	31.65	31.75	55.43	63.62	74.00	-10.38	peak
2	5149.980	8.29	31.77	31.82	53.38	61.62	74.00	-12.38	peak
3	5270.000	8.28	32.06	31.99	87.82	96.17	68.20	27.97	peak



Unless otherwise agreed in writing, this document is issued by the Company subject to its General Conditions of Service printed overleaf, available on request or accessible at <http://www.sgs.com/en/Terms-and-Conditions.aspx> and, for electronic format documents, subject to Terms and Conditions for Electronic Documents at <http://www.sgs.com/en/Terms-and-Conditions/Terms-e-Documents.aspx>. Attention is drawn to the limitation of liability, indemnification and jurisdiction issues defined therein. Any holder of this document is advised that information contained hereon reflects the Company's findings at the time of its intervention only and within the limits of Client's instructions, if any. The Company's sole responsibility is to its Client and this document does not exonerate parties to a transaction from exercising all their rights and obligations under the transaction documents. This document cannot be reproduced except in full, without prior written approval of the Company. Any unauthorized alteration, forgery or falsification of the content or appearance of this document is unlawful and offenders may be prosecuted to the fullest extent of the law. Unless otherwise stated the results shown in this test report refer only to the sample(s) tested and such sample(s) are retained for 30 days only.
Attention: To check the authenticity of testing /inspection report & certificate, please contact us at telephone: (86-755) 8307 1443, or email: CN.Doccheck@sgs.com

Fuyong lab, Xinlong TechnoPark, Fengtang Road, Fuyong Subdistrict, Bao'an, Shenzhen, China 518103 t (86-755) 88663988 f (86-755) 26710594 www.sgsgroup.com.cn
 中国·深圳·宝安区福永街道凤塘大道鑫龙科技园福永实验室 邮编: 518103 t (86-755) 88663988 f (86-755) 26710594 sgs.china@sgs.com

Test Mode: 10; Polarity: Horizontal; Modulation:802.11n; Bandwidth:40MHz; Channel:Low

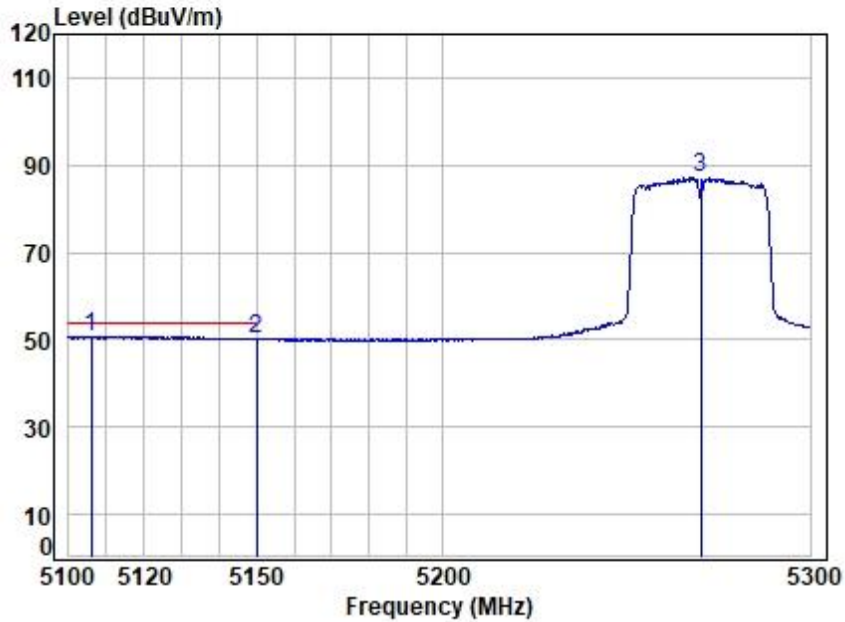

Site : chamber
 Condition: 3m HORIZONTAL
 Job No : 00466AT
 Mode : 5270 Band edge
 : 5G WIFI 11N40

	Freq	Cable Loss	Ant Factor	Preamp Factor	Read Level	Limit Level	Over Limit	Remark
	MHz	dB	dB/m	dB	dBuV	dBuV/m	dBuV/m	dB
1	5105.889	8.29	31.66	31.75	42.50	50.70	54.00	-3.30 Average
2	5149.980	8.29	31.77	31.82	41.86	50.10	54.00	-3.90 Average
3	5270.000	8.28	32.06	31.99	78.85	87.20	-----	----- Average



Unless otherwise agreed in writing, this document is issued by the Company subject to its General Conditions of Service printed overleaf, available on request or accessible at <http://www.sgs.com/en/Terms-and-Conditions.aspx> and, for electronic format documents, subject to Terms and Conditions for Electronic Documents at <http://www.sgs.com/en/Terms-and-Conditions/Terms-e-Documents.aspx>. Attention is drawn to the limitation of liability, indemnification and jurisdiction issues defined therein. Any holder of this document is advised that information contained hereon reflects the Company's findings at the time of its intervention only and within the limits of Client's instructions, if any. The Company's sole responsibility is to its Client and this document does not exonerate parties to a transaction from exercising all their rights and obligations under the transaction documents. This document cannot be reproduced except in full, without prior written approval of the Company. Any unauthorized alteration, forgery or falsification of the content or appearance of this document is unlawful and offenders may be prosecuted to the fullest extent of the law. Unless otherwise stated the results shown in this test report refer only to the sample(s) tested and such sample(s) are retained for 30 days only.
Attention: To check the authenticity of testing /inspection report & certificate, please contact us at telephone: (86-755) 8307 1443, or email: CN.Doccheck@sgs.com

Fuyong lab, Xinlong TechnoPark, Fengtang Road, Fuyong Subdistrict, Bao'an, Shenzhen, China 518103 t (86-755) 88663988 f (86-755) 26710594 www.sgs.com.cn
 中国·深圳·宝安区福永街道凤塘大道鑫龙科技园福永实验室 邮编: 518103 t (86-755) 88663988 f (86-755) 26710594 sgs.china@sgs.com

Test Mode: 10; Polarity: Vertical; Modulation:802.11n; Bandwidth:40MHz; Channel:Low

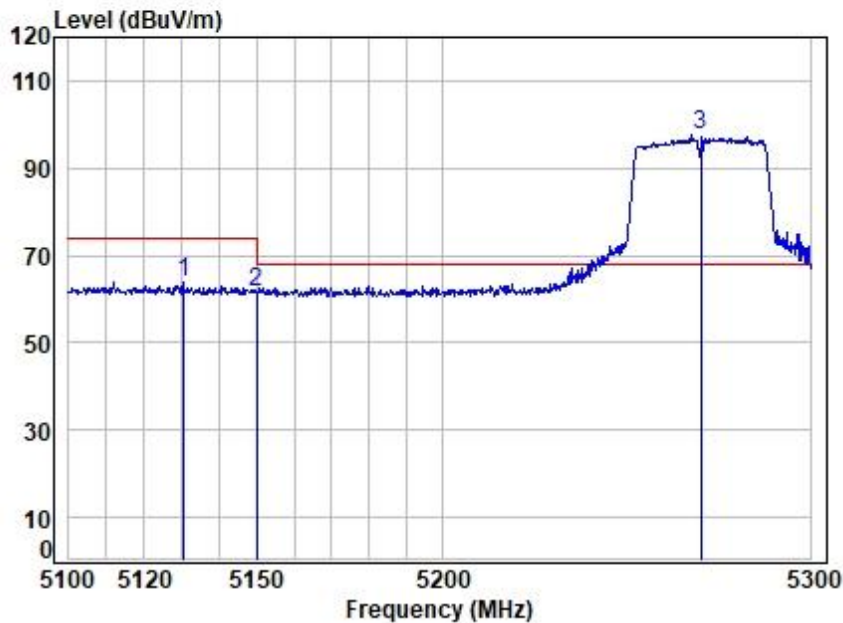

Site : chamber
 Condition: 3m VERTICAL
 Job No : 00466AT
 Mode : 5270 Band edge
 : 5G WIFI 11N40

	Freq	Cable Loss	Ant Factor	Preamp Factor	Read Level	Limit Level	Over Limit	Remark
	MHz	dB	dB/m	dB	dBuV	dBuV/m	dBuV/m	dB
1	5130.499	8.29	31.72	31.79	55.72	63.94	74.00	-10.06 Peak
2	5149.980	8.29	31.77	31.82	53.15	61.39	74.00	-12.61 Peak
3	5270.000	8.28	32.06	31.99	89.41	97.76	68.20	29.56 Peak



Unless otherwise agreed in writing, this document is issued by the Company subject to its General Conditions of Service printed overleaf, available on request or accessible at <http://www.sgs.com/en/Terms-and-Conditions.aspx> and, for electronic format documents, subject to Terms and Conditions for Electronic Documents at <http://www.sgs.com/en/Terms-and-Conditions/Terms-e-Documents.aspx>. Attention is drawn to the limitation of liability, indemnification and jurisdiction issues defined therein. Any holder of this document is advised that information contained hereon reflects the Company's findings at the time of its intervention only and within the limits of Client's instructions, if any. The Company's sole responsibility is to its Client and this document does not exonerate parties to a transaction from exercising all their rights and obligations under the transaction documents. This document cannot be reproduced except in full, without prior written approval of the Company. Any unauthorized alteration, forgery or falsification of the content or appearance of this document is unlawful and offenders may be prosecuted to the fullest extent of the law. Unless otherwise stated the results shown in this test report refer only to the sample(s) tested and such sample(s) are retained for 30 days only.
Attention: To check the authenticity of testing /inspection report & certificate, please contact us at telephone: (86-755) 8307 1443, or email: CN.Doccheck@sgs.com

Fuyong lab, Xinlong TechnoPark, Fengtang Road, Fuyong Subdistrict, Bao'an, Shenzhen, China 518103 t (86-755) 88663988 f (86-755) 26710594 www.sgsgroup.com.cn
 中国·深圳·宝安区福永街道凤塘大道鑫龙科技园福永实验室 邮编: 518103 t (86-755) 88663988 f (86-755) 26710594 sgs.china@sgs.com

Test Mode: 10; Polarity: Vertical; Modulation:802.11n; Bandwidth:40MHz; Channel:Low

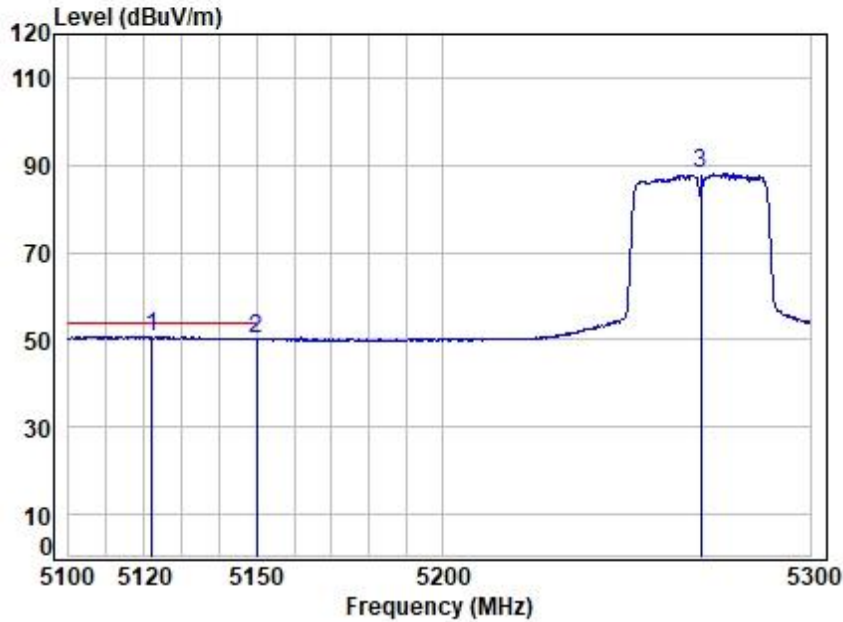

Site : chamber
 Condition: 3m VERTICAL
 Job No : 00466AT
 Mode : 5270 Band edge
 : 5G WIFI 11N40

	Freq	Cable Loss	Ant Factor	Preamp Factor	Read Level	Level	Limit	Over	Remark
	MHz	dB	dB/m	dB	dBuV	dBuV/m	dBuV/m	dB	
1	5122.020	8.29	31.70	31.78	42.55	50.76	54.00	-3.24	Average
2	5149.980	8.29	31.77	31.82	42.11	50.35	54.00	-3.65	Average
3	5270.000	8.28	32.06	31.99	79.70	88.05	-----	-----	Average



Unless otherwise agreed in writing, this document is issued by the Company subject to its General Conditions of Service printed overleaf, available on request or accessible at <http://www.sgs.com/en/Terms-and-Conditions.aspx> and, for electronic format documents, subject to Terms and Conditions for Electronic Documents at <http://www.sgs.com/en/Terms-and-Conditions/Terms-e-Documents.aspx>. Attention is drawn to the limitation of liability, indemnification and jurisdiction issues defined therein. Any holder of this document is advised that information contained hereon reflects the Company's findings at the time of its intervention only and within the limits of Client's instructions, if any. The Company's sole responsibility is to its Client and this document does not exonerate parties to a transaction from exercising all their rights and obligations under the transaction documents. This document cannot be reproduced except in full, without prior written approval of the Company. Any unauthorized alteration, forgery or falsification of the content or appearance of this document is unlawful and offenders may be prosecuted to the fullest extent of the law. Unless otherwise stated the results shown in this test report refer only to the sample(s) tested and such sample(s) are retained for 30 days only.
Attention: To check the authenticity of testing /inspection report & certificate, please contact us at telephone: (86-755) 8307 1443, or email: CN.Doccheck@sgs.com

Fuyong lab, Xinlong TechnoPark, Fengtang Road, Fuyong Subdistrict, Bao'an, Shenzhen, China 518103 t (86-755) 88663988 f (86-755) 26710594 www.sgsgroup.com.cn
 中国·深圳·宝安区福永街道凤塘大道鑫龙科技园福永实验室 邮编: 518103 t (86-755) 88663988 f (86-755) 26710594 sgs.china@sgs.com

Test Mode: 10; Polarity: Horizontal; Modulation:802.11n; Bandwidth:40MHz; Channel:High

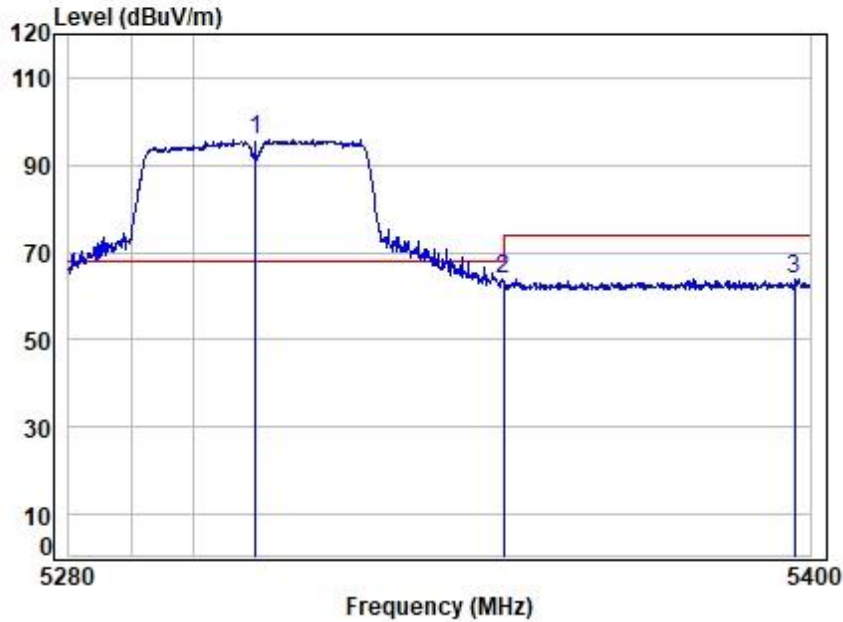

Site : chamber
 Condition: 3m HORIZONTAL
 Job No : 00466AT
 Mode : 5310 Band edge
 : 5G WIFI 11N40

	Freq	Cable Loss	Ant Factor	Preamp Factor	Read Level	Limit Level	Over Limit	Remark
	MHz	dB	dB/m	dB	dBuV	dBuV/m	dBuV/m	dB
1	5310.000	8.28	32.16	32.04	87.54	95.94	68.20	27.74 peak
2	5350.020	8.28	32.25	32.10	55.33	63.76	74.00	-10.24 peak
3	5397.452	8.28	32.36	32.16	55.37	63.85	74.00	-10.15 peak



Unless otherwise agreed in writing, this document is issued by the Company subject to its General Conditions of Service printed overleaf, available on request or accessible at <http://www.sgs.com/en/Terms-and-Conditions.aspx> and, for electronic format documents, subject to Terms and Conditions for Electronic Documents at <http://www.sgs.com/en/Terms-and-Conditions/Terms-e-Documents.aspx>. Attention is drawn to the limitation of liability, indemnification and jurisdiction issues defined therein. Any holder of this document is advised that information contained hereon reflects the Company's findings at the time of its intervention only and within the limits of Client's instructions, if any. The Company's sole responsibility is to its Client and this document does not exonerate parties to a transaction from exercising all their rights and obligations under the transaction documents. This document cannot be reproduced except in full, without prior written approval of the Company. Any unauthorized alteration, forgery or falsification of the content or appearance of this document is unlawful and offenders may be prosecuted to the fullest extent of the law. Unless otherwise stated the results shown in this test report refer only to the sample(s) tested and such sample(s) are retained for 30 days only.
Attention: To check the authenticity of testing /inspection report & certificate, please contact us at telephone: (86-755) 8307 1443, or email: CN.Doccheck@sgs.com

Fuyong lab, Xinlong TechnoPark, Fengtang Road, Fuyong Subdistrict, Bao'an, Shenzhen, China 518103 t (86-755) 88663988 f (86-755) 26710594 www.sgsgroup.com.cn
 中国·深圳·宝安区福永街道凤塘大道鑫龙科技园福永实验室 邮编: 518103 t (86-755) 88663988 f (86-755) 26710594 sgs.china@sgs.com

Test Mode: 10; Polarity: Horizontal; Modulation:802.11n; Bandwidth:40MHz; Channel:High

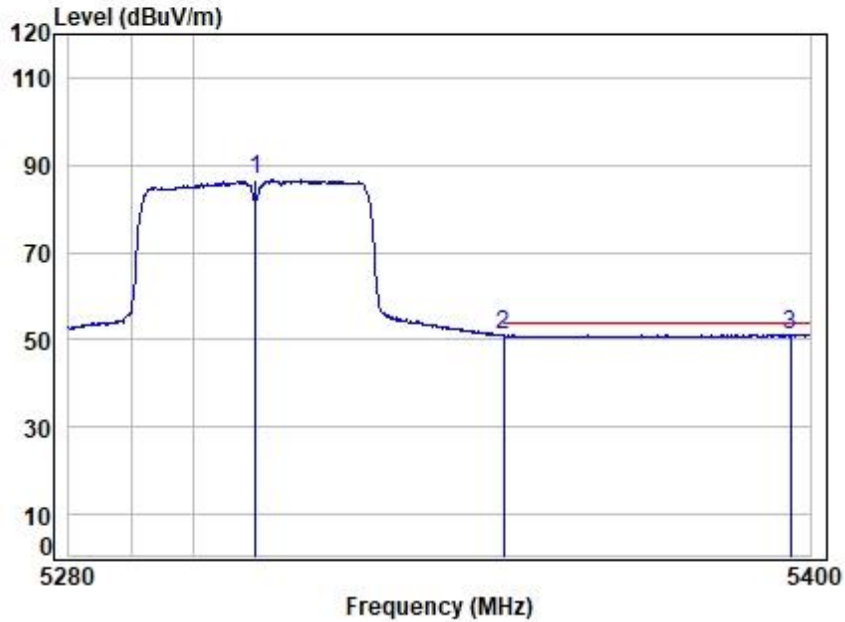

Site : chamber
 Condition: 3m HORIZONTAL
 Job No : 00466AT
 Mode : 5310 Band edge
 : 5G WIFI 11N40

	Freq	Cable Loss	Ant Factor	Preamp Factor	Read Level	Level	Limit	Over	Remark
	MHz	dB	dB/m	dB	dBuV	dBuV/m	dBuV/m	dB	
1	5310.000	8.28	32.16	32.04	78.46	86.86	-----	-----	Average
2	5350.020	8.28	32.25	32.10	42.66	51.09	54.00	-2.91	Average
3	5396.725	8.28	32.36	32.16	42.62	51.10	54.00	-2.90	Average



Unless otherwise agreed in writing, this document is issued by the Company subject to its General Conditions of Service printed overleaf, available on request or accessible at <http://www.sgs.com/en/Terms-and-Conditions.aspx> and, for electronic format documents, subject to Terms and Conditions for Electronic Documents at <http://www.sgs.com/en/Terms-and-Conditions/Terms-e-Documents.aspx>. Attention is drawn to the limitation of liability, indemnification and jurisdiction issues defined therein. Any holder of this document is advised that information contained hereon reflects the Company's findings at the time of its intervention only and within the limits of Client's instructions, if any. The Company's sole responsibility is to its Client and this document does not exonerate parties to a transaction from exercising all their rights and obligations under the transaction documents. This document cannot be reproduced except in full, without prior written approval of the Company. Any unauthorized alteration, forgery or falsification of the content or appearance of this document is unlawful and offenders may be prosecuted to the fullest extent of the law. Unless otherwise stated the results shown in this test report refer only to the sample(s) tested and such sample(s) are retained for 30 days only.
Attention: To check the authenticity of testing /inspection report & certificate, please contact us at telephone: (86-755) 8307 1443, or email: CN.Doccheck@sgs.com

Fuyong lab, Xinlong TechnoPark, Fengtang Road, Fuyong Subdistrict, Bao'an, Shenzhen, China 518103 t (86-755) 88663988 f (86-755) 26710594 www.sgs.com.cn
 中国·深圳·宝安区福永街道凤塘大道鑫龙科技园福永实验室 邮编: 518103 t (86-755) 88663988 f (86-755) 26710594 sgs.china@sgs.com

Compliance Certification Services (Kunshan) Inc. Shenzhen Branch

SZCCS-TRF-01 Rev. A/0 Aug01,2022

Report No.: FYCR221100046605

Page: 136 of 344

Test Mode: 10; Polarity: Vertical; Modulation:802.11n; Bandwidth:40MHz; Channel:High

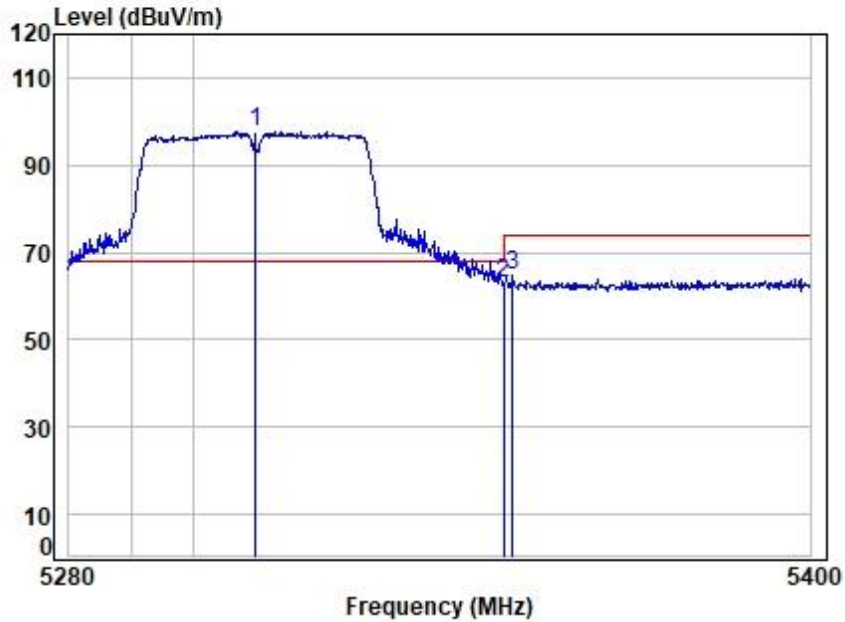

Site : chamber
 Condition: 3m VERTICAL
 Job No : 00466AT
 Mode : 5310 Band edge
 : 5G WIFI 11N40

	Freq	Cable Loss	Ant Factor	Preamp Factor	Read Level	Limit	Over	Remark
	MHz	dB	dB/m	dB	dBuV	dBuV/m	dB	
1	5310.000	8.28	32.16	32.04	89.32	68.20	29.52	Peak
2	5350.020	8.28	32.25	32.10	54.62	74.00	-10.95	Peak
3	5351.556	8.28	32.26	32.10	56.47	74.00	-9.09	Peak



Unless otherwise agreed in writing, this document is issued by the Company subject to its General Conditions of Service printed overleaf, available on request or accessible at <http://www.sgs.com/en/Terms-and-Conditions.aspx> and, for electronic format documents, subject to Terms and Conditions for Electronic Documents at <http://www.sgs.com/en/Terms-and-Conditions/Terms-e-Documents.aspx>. Attention is drawn to the limitation of liability, indemnification and jurisdiction issues defined therein. Any holder of this document is advised that information contained hereon reflects the Company's findings at the time of its intervention only and within the limits of Client's instructions, if any. The Company's sole responsibility is to its Client and this document does not exonerate parties to a transaction from exercising all their rights and obligations under the transaction documents. This document cannot be reproduced except in full, without prior written approval of the Company. Any unauthorized alteration, forgery or falsification of the content or appearance of this document is unlawful and offenders may be prosecuted to the fullest extent of the law. Unless otherwise stated the results shown in this test report refer only to the sample(s) tested and such sample(s) are retained for 30 days only.
Attention: To check the authenticity of testing /inspection report & certificate, please contact us at telephone: (86-755) 8307 1443, or email: CN.Doccheck@sgs.com

Fuyong lab, Xinlong TechnoPark, Fengtang Road, Fuyong Subdistrict, Bao'an, Shenzhen, China 518103 t (86-755) 88663988 f (86-755) 26710594 www.sgsgroup.com.cn
 中国·深圳·宝安区福永街道凤塘大道鑫龙科技园福永实验室 邮编: 518103 t (86-755) 88663988 f (86-755) 26710594 sgs.china@sgs.com

Test Mode: 10; Polarity: Vertical; Modulation:802.11n; Bandwidth:40MHz; Channel:High

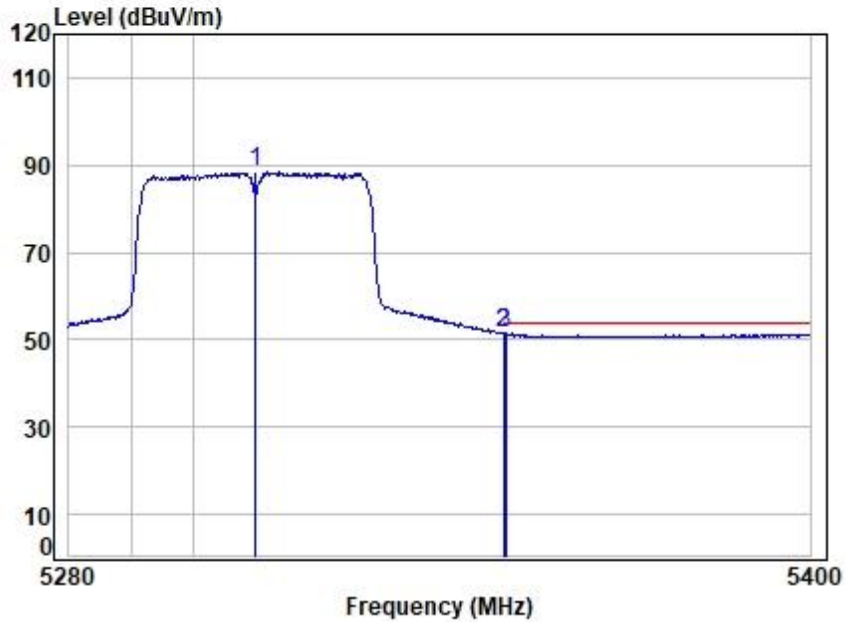

Site : chamber
 Condition: 3m VERTICAL
 Job No : 00466AT
 Mode : 5310 Band edge
 : 5G WIFI 11N40

	Freq	Cable Loss	Ant Factor	Preamp Factor	Read Level	Level	Limit	Over	Remark
	MHz	dB	dB/m	dB	dBuV	dBuV/m	dBuV/m	dB	
1	5310.000	8.28	32.16	32.04	80.01	88.41	-----	-----	Average
2	5350.020	8.28	32.25	32.10	43.16	51.59	54.00	-2.41	Average
3	5350.474	8.28	32.25	32.10	43.08	51.51	54.00	-2.49	Average



Unless otherwise agreed in writing, this document is issued by the Company subject to its General Conditions of Service printed overleaf, available on request or accessible at <http://www.sgs.com/en/Terms-and-Conditions.aspx> and, for electronic format documents, subject to Terms and Conditions for Electronic Documents at <http://www.sgs.com/en/Terms-and-Conditions/Terms-e-Documents.aspx>. Attention is drawn to the limitation of liability, indemnification and jurisdiction issues defined therein. Any holder of this document is advised that information contained hereon reflects the Company's findings at the time of its intervention only and within the limits of Client's instructions, if any. The Company's sole responsibility is to its Client and this document does not exonerate parties to a transaction from exercising all their rights and obligations under the transaction documents. This document cannot be reproduced except in full, without prior written approval of the Company. Any unauthorized alteration, forgery or falsification of the content or appearance of this document is unlawful and offenders may be prosecuted to the fullest extent of the law. Unless otherwise stated the results shown in this test report refer only to the sample(s) tested and such sample(s) are retained for 30 days only.
Attention: To check the authenticity of testing /inspection report & certificate, please contact us at telephone: (86-755) 8307 1443, or email: CN.Doccheck@sgs.com

Fuyong lab, Xinlong TechnoPark, Fengtang Road, Fuyong Subdistrict, Bao'an, Shenzhen, China 518103 t (86-755) 88663988 f (86-755) 26710594 www.sgs.com.cn
 中国·深圳·宝安区福永街道凤塘大道鑫龙科技园福永实验室 邮编: 518103 t (86-755) 88663988 f (86-755) 26710594 sgs.china@sgs.com

Test Mode: 10; Polarity: Horizontal; Modulation:802.11ac; Bandwidth:80MHz; Channel:middle

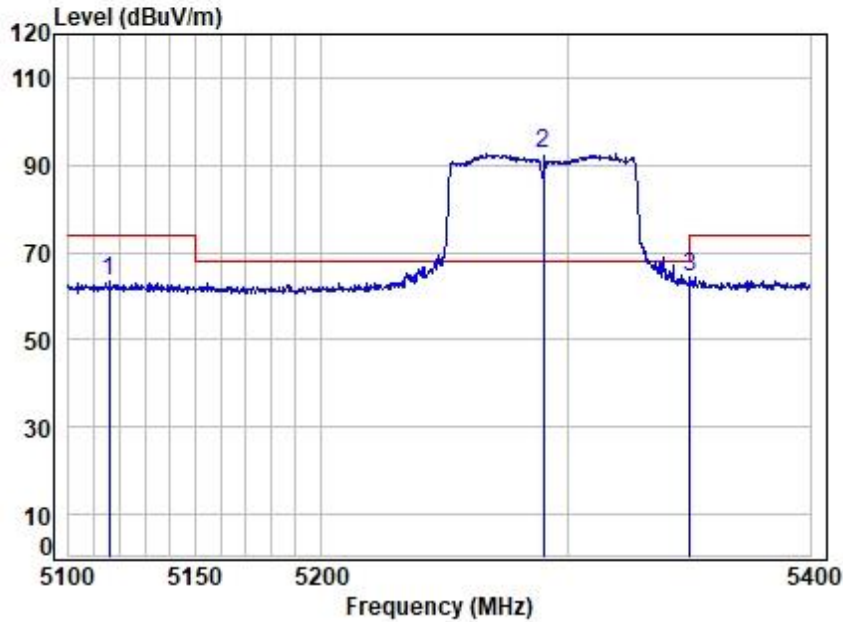

Site : chamber
 Condition: 3m HORIZONTAL
 Job No : 00466AT
 Mode : 5290 Band edge
 : 5G WIFI 11AC80

	Freq	Cable Loss	Ant Factor	Preamp Factor	Read Level	Limit Level	Over Limit	Remark
	MHz	dB	dB/m	dB	dBuV	dBuV/m	dBuV/m	dB
1	5116.058	8.29	31.69	31.77	55.01	63.22	74.00	-10.78 peak
2	5290.000	8.28	32.11	32.01	84.04	92.42	68.20	24.22 peak
3	5350.229	8.28	32.25	32.10	55.78	64.21	74.00	-9.79 peak



Unless otherwise agreed in writing, this document is issued by the Company subject to its General Conditions of Service printed overleaf, available on request or accessible at <http://www.sgs.com/en/Terms-and-Conditions.aspx> and, for electronic format documents, subject to Terms and Conditions for Electronic Documents at <http://www.sgs.com/en/Terms-and-Conditions/Terms-e-Documents.aspx>. Attention is drawn to the limitation of liability, indemnification and jurisdiction issues defined therein. Any holder of this document is advised that information contained hereon reflects the Company's findings at the time of its intervention only and within the limits of Client's instructions, if any. The Company's sole responsibility is to its Client and this document does not exonerate parties to a transaction from exercising all their rights and obligations under the transaction documents. This document cannot be reproduced except in full, without prior written approval of the Company. Any unauthorized alteration, forgery or falsification of the content or appearance of this document is unlawful and offenders may be prosecuted to the fullest extent of the law. Unless otherwise stated the results shown in this test report refer only to the sample(s) tested and such sample(s) are retained for 30 days only.
Attention: To check the authenticity of testing /inspection report & certificate, please contact us at telephone: (86-755) 8307 1443, or email: CN.Doccheck@sgs.com

Fuyong lab, Xinlong TechnoPark, Fengtang Road, Fuyong Subdistrict, Bao'an, Shenzhen, China 518103 t (86-755) 88663988 f (86-755) 26710594 www.sgsgroup.com.cn
 中国·深圳·宝安区福永街道凤塘大道鑫龙科技园福永实验室 邮编: 518103 t (86-755) 88663988 f (86-755) 26710594 sgs.china@sgs.com

Test Mode: 10; Polarity: Horizontal; Modulation:802.11ac; Bandwidth:80MHz; Channel:middle

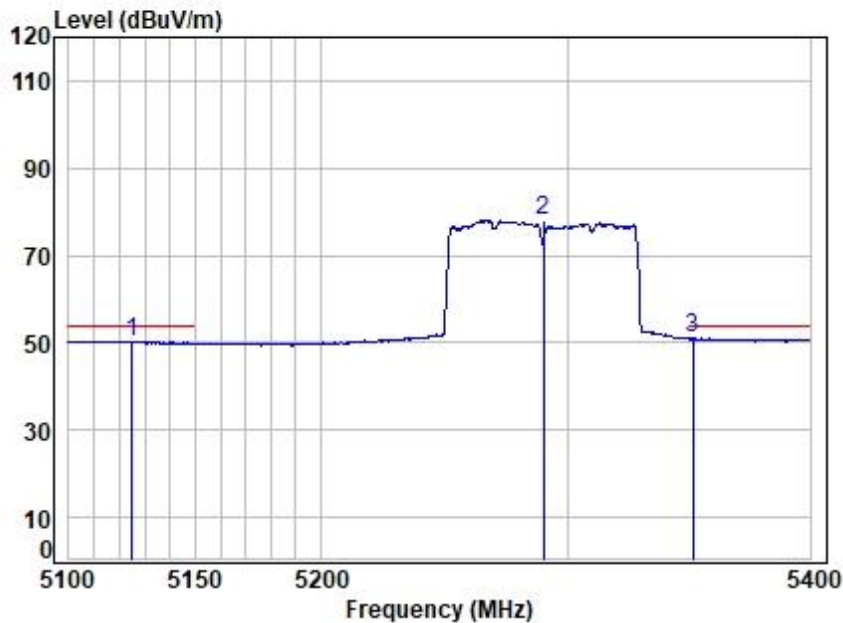

Site : chamber
 Condition: 3m HORIZONTAL
 Job No : 00466AT
 Mode : 5290 Band edge
 : 5G WIFI 11AC80

	Freq	Cable Loss	Ant Factor	Preamp Factor	Read Level	Level	Limit	Over	Remark
	MHz	dB	dB/m	dB	dBuV	dBuV/m	dBuV/m	dB	
1	5125.131	8.29	31.71	31.78	42.03	50.25	54.00	-3.75	Average
2	5290.000	8.28	32.11	32.01	69.79	78.17	-----	-----	Average
3	5351.452	8.28	32.26	32.10	42.51	50.95	54.00	-3.05	Average



Unless otherwise agreed in writing, this document is issued by the Company subject to its General Conditions of Service printed overleaf, available on request or accessible at <http://www.sgs.com/en/Terms-and-Conditions.aspx> and, for electronic format documents, subject to Terms and Conditions for Electronic Documents at <http://www.sgs.com/en/Terms-and-Conditions/Terms-e-Documents.aspx>. Attention is drawn to the limitation of liability, indemnification and jurisdiction issues defined therein. Any holder of this document is advised that information contained hereon reflects the Company's findings at the time of its intervention only and within the limits of Client's instructions, if any. The Company's sole responsibility is to its Client and this document does not exonerate parties to a transaction from exercising all their rights and obligations under the transaction documents. This document cannot be reproduced except in full, without prior written approval of the Company. Any unauthorized alteration, forgery or falsification of the content or appearance of this document is unlawful and offenders may be prosecuted to the fullest extent of the law. Unless otherwise stated the results shown in this test report refer only to the sample(s) tested and such sample(s) are retained for 30 days only.
Attention: To check the authenticity of testing /inspection report & certificate, please contact us at telephone: (86-755) 8307 1443, or email: CN.Doccheck@sgs.com

Fuyong lab, Xinlong TechnoPark, Fengtang Road, Fuyong Subdistrict, Bao'an, Shenzhen, China 518103 t (86-755) 88663988 f (86-755) 26710594 www.sgsgroup.com.cn
 中国·深圳·宝安区福永街道凤塘大道鑫龙科技园福永实验室 邮编: 518103 t (86-755) 88663988 f (86-755) 26710594 sgs.china@sgs.com

Test Mode: 10; Polarity: Vertical; Modulation:802.11ac; Bandwidth:80MHz; Channel:middle

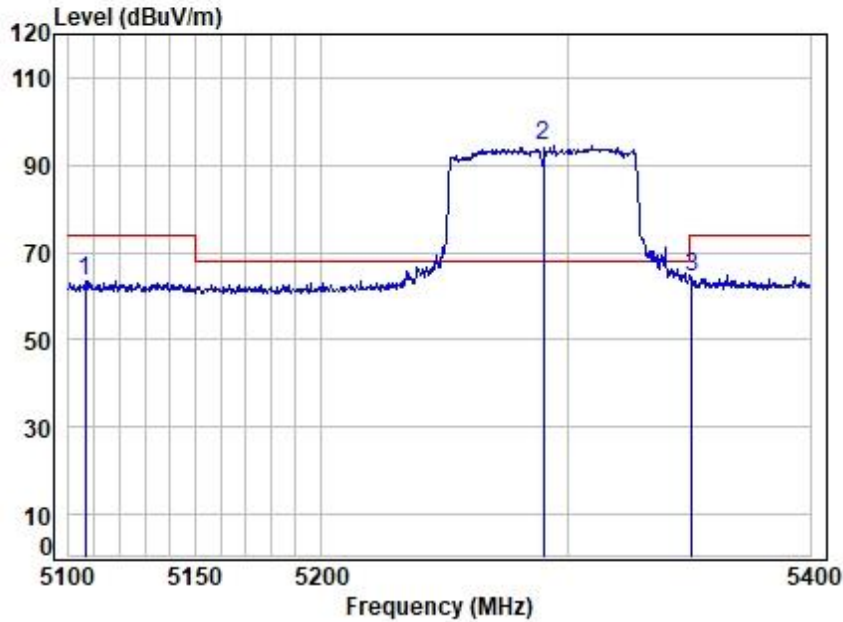

Site : chamber
 Condition: 3m VERTICAL
 Job No : 00466AT
 Mode : 5290 Band edge
 : 5G WIFI 11AC80

	Freq	Cable Loss	Ant Factor	Preamp Factor	Read Level	Limit Level	Over Limit	Remark
	MHz	dB	dB/m	dB	dBuV	dBuV/m	dBuV/m	dB
1	5106.417	8.29	31.67	31.75	55.17	63.38	74.00	-10.62 Peak
2	5290.000	8.28	32.11	32.01	86.17	94.55	68.20	26.35 Peak
3	5350.840	8.28	32.25	32.10	56.07	64.50	74.00	-9.50 Peak



Unless otherwise agreed in writing, this document is issued by the Company subject to its General Conditions of Service printed overleaf, available on request or accessible at <http://www.sgs.com/en/Terms-and-Conditions.aspx> and, for electronic format documents, subject to Terms and Conditions for Electronic Documents at <http://www.sgs.com/en/Terms-and-Conditions/Terms-e-Documents.aspx>. Attention is drawn to the limitation of liability, indemnification and jurisdiction issues defined therein. Any holder of this document is advised that information contained hereon reflects the Company's findings at the time of its intervention only and within the limits of Client's instructions, if any. The Company's sole responsibility is to its Client and this document does not exonerate parties to a transaction from exercising all their rights and obligations under the transaction documents. This document cannot be reproduced except in full, without prior written approval of the Company. Any unauthorized alteration, forgery or falsification of the content or appearance of this document is unlawful and offenders may be prosecuted to the fullest extent of the law. Unless otherwise stated the results shown in this test report refer only to the sample(s) tested and such sample(s) are retained for 30 days only.
Attention: To check the authenticity of testing /inspection report & certificate, please contact us at telephone: (86-755) 8307 1443, or email: CN.Doccheck@sgs.com

Fuyong lab, Xinlong TechnoPark, Fengtang Road, Fuyong Subdistrict, Bao'an, Shenzhen, China 518103 t (86-755) 88663988 f (86-755) 26710594 www.sgsgroup.com.cn
 中国·深圳·宝安区福永街道凤塘大道鑫龙科技园福永实验室 邮编: 518103 t (86-755) 88663988 f (86-755) 26710594 sgs.china@sgs.com

Compliance Certification Services (Kunshan) Inc. Shenzhen Branch

SZCCS-TRF-01 Rev. A/0 Aug01,2022

Report No.: FYCR221100046605

Page: 141 of 344

Test Mode: 10; Polarity: Vertical; Modulation:802.11ac; Bandwidth:80MHz; Channel:middle

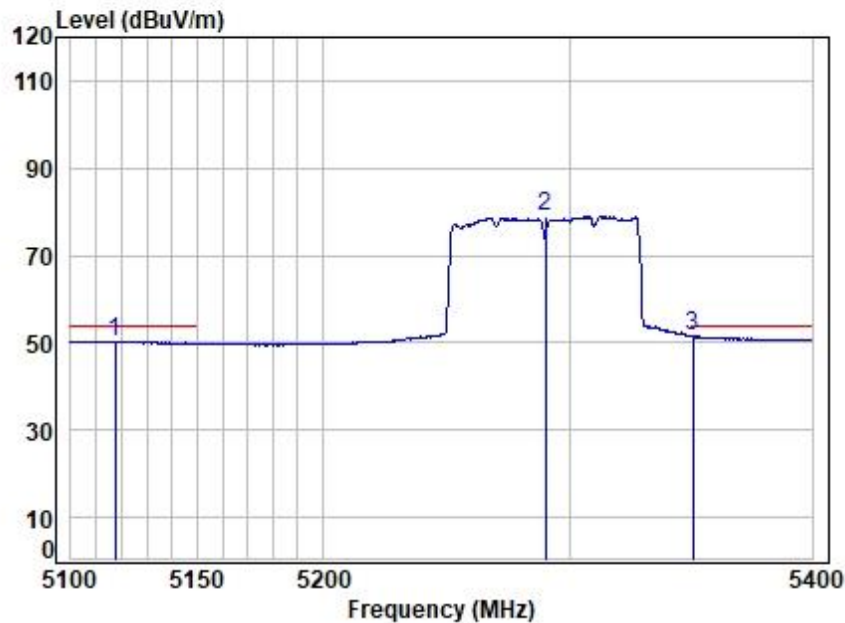

Site : chamber
 Condition: 3m VERTICAL
 Job No : 00466AT
 Mode : 5290 Band edge
 : 5G WIFI 11AC80

	Freq	Cable Loss	Ant Factor	Preamp Factor	Read Level	Limit	Over	Remark
	MHz	dB	dB/m	dB	dBuV	dBuV/m	dB	
1	5117.521	8.29	31.69	31.77	42.06	50.27	54.00	-3.73 Average
2	5290.000	8.28	32.11	32.01	70.56	78.94	-----	----- Average
3	5350.535	8.28	32.25	32.10	43.14	51.57	54.00	-2.43 Average



Unless otherwise agreed in writing, this document is issued by the Company subject to its General Conditions of Service printed overleaf, available on request or accessible at <http://www.sgs.com/en/Terms-and-Conditions.aspx> and, for electronic format documents, subject to Terms and Conditions for Electronic Documents at <http://www.sgs.com/en/Terms-and-Conditions/Terms-e-Documents.aspx>. Attention is drawn to the limitation of liability, indemnification and jurisdiction issues defined therein. Any holder of this document is advised that information contained hereon reflects the Company's findings at the time of its intervention only and within the limits of Client's instructions, if any. The Company's sole responsibility is to its Client and this document does not exonerate parties to a transaction from exercising all their rights and obligations under the transaction documents. This document cannot be reproduced except in full, without prior written approval of the Company. Any unauthorized alteration, forgery or falsification of the content or appearance of this document is unlawful and offenders may be prosecuted to the fullest extent of the law. Unless otherwise stated the results shown in this test report refer only to the sample(s) tested and such sample(s) are retained for 30 days only.
Attention: To check the authenticity of testing /inspection report & certificate, please contact us at telephone: (86-755) 8307 1443, or email: CN.Doccheck@sgs.com

Fuyong lab, Xinlong TechnoPark, Fengtang Road, Fuyong Subdistrict, Bao'an, Shenzhen, China 518103 t (86-755) 88663988 f (86-755) 26710594 www.sgsgroup.com.cn
 中国·深圳·宝安区福永街道凤塘大道鑫龙科技园福永实验室 邮编: 518103 t (86-755) 88663988 f (86-755) 26710594 sgs.china@sgs.com

Compliance Certification Services (Kunshan) Inc. Shenzhen Branch

SZCCS-TRF-01 Rev. A/0 Aug01,2022

Report No.: FYCR221100046605

Page: 142 of 344

Test Mode: 11; Polarity: Horizontal; Modulation:802.11a; Bandwidth:20MHz; Channel:Low

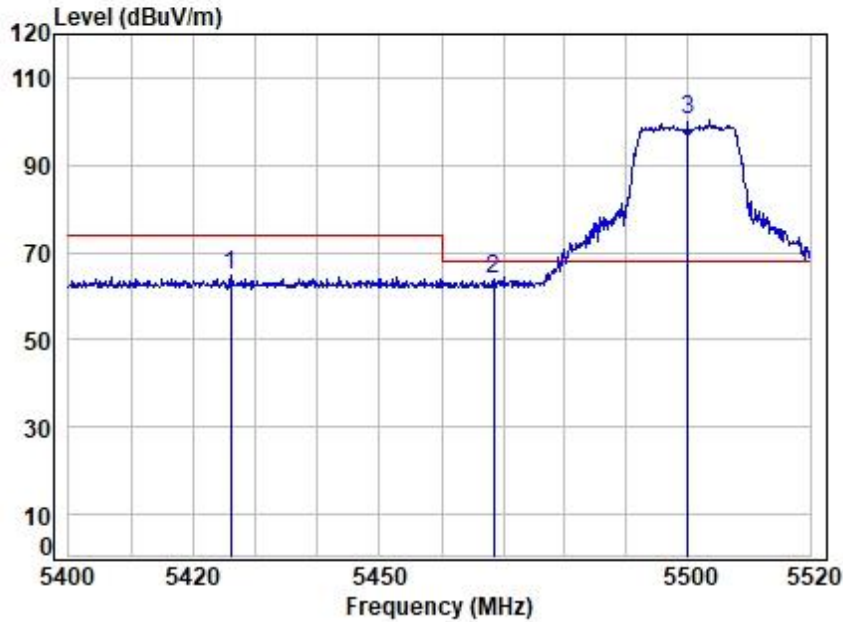

Site : chamber
 Condition: 3m HORIZONTAL
 Job No : 00466AT
 Mode : 5500 Band edge
 : 5G WIFI 11A

		Cable	Ant	Preamp	Read	Limit	Over	
	Freq	Loss	Factor	Factor	Level	Line	Limit	Remark
	MHz	dB	dB/m	dB	dBuV	dBuV/m	dBuV/m	dB
1	5425.936	8.27	32.43	32.20	56.17	64.67	74.00	-9.33 peak
2	5468.437	8.27	32.53	32.26	55.38	63.92	68.20	-4.28 peak
3	5500.000	8.27	32.60	32.30	91.63	100.20	68.20	32.00 peak



Unless otherwise agreed in writing, this document is issued by the Company subject to its General Conditions of Service printed overleaf, available on request or accessible at <http://www.sgs.com/en/Terms-and-Conditions.aspx> and, for electronic format documents, subject to Terms and Conditions for Electronic Documents at <http://www.sgs.com/en/Terms-and-Conditions/Terms-e-Documents.aspx>. Attention is drawn to the limitation of liability, indemnification and jurisdiction issues defined therein. Any holder of this document is advised that information contained hereon reflects the Company's findings at the time of its intervention only and within the limits of Client's instructions, if any. The Company's sole responsibility is to its Client and this document does not exonerate parties to a transaction from exercising all their rights and obligations under the transaction documents. This document cannot be reproduced except in full, without prior written approval of the Company. Any unauthorized alteration, forgery or falsification of the content or appearance of this document is unlawful and offenders may be prosecuted to the fullest extent of the law. Unless otherwise stated the results shown in this test report refer only to the sample(s) tested and such sample(s) are retained for 30 days only.
Attention: To check the authenticity of testing /inspection report & certificate, please contact us at telephone: (86-755) 8307 1443, or email: CN.Doccheck@sgs.com

Fuyong lab, Xinlong TechnoPark, Fengtang Road, Fuyong Subdistrict, Bao'an, Shenzhen, China 518103 t (86-755) 88663988 f (86-755) 26710594 www.sgs.com.cn
 中国·深圳·宝安区福永街道凤塘大道鑫龙科技园福永实验室 邮编: 518103 t (86-755) 88663988 f (86-755) 26710594 sgs.china@sgs.com

Test Mode: 11; Polarity: Horizontal; Modulation:802.11a; Bandwidth:20MHz; Channel:Low

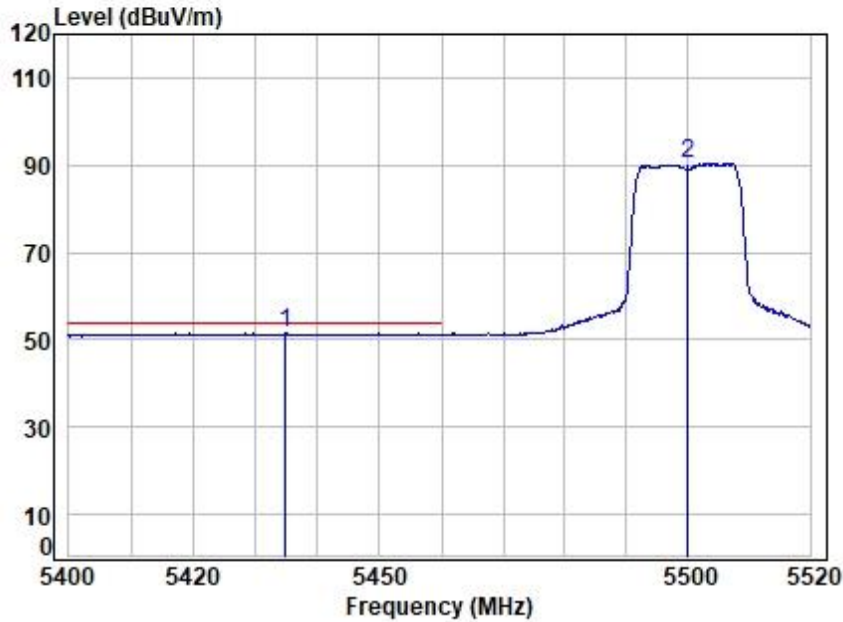

Site : chamber
 Condition: 3m HORIZONTAL
 Job No : 00466AT
 Mode : 5500 Band edge
 : 5G WIFI 11A

	Freq	Cable Loss	Ant Factor	Preamp Factor	Read Level	Level	Limit	Over	Remark
	MHz	dB	dB/m	dB	dBuV	dBuV/m	dBuV/m	dB	
1	5434.768	8.27	32.45	32.21	42.92	51.43	54.00	-2.57	Average
2	5500.000	8.27	32.60	32.30	81.88	90.45	-----	-----	Average



Unless otherwise agreed in writing, this document is issued by the Company subject to its General Conditions of Service printed overleaf, available on request or accessible at <http://www.sgs.com/en/Terms-and-Conditions.aspx> and, for electronic format documents, subject to Terms and Conditions for Electronic Documents at <http://www.sgs.com/en/Terms-and-Conditions/Terms-e-Documents.aspx>. Attention is drawn to the limitation of liability, indemnification and jurisdiction issues defined therein. Any holder of this document is advised that information contained hereon reflects the Company's findings at the time of its intervention only and within the limits of Client's instructions, if any. The Company's sole responsibility is to its Client and this document does not exonerate parties to a transaction from exercising all their rights and obligations under the transaction documents. This document cannot be reproduced except in full, without prior written approval of the Company. Any unauthorized alteration, forgery or falsification of the content or appearance of this document is unlawful and offenders may be prosecuted to the fullest extent of the law. Unless otherwise stated the results shown in this test report refer only to the sample(s) tested and such sample(s) are retained for 30 days only.
Attention: To check the authenticity of testing /inspection report & certificate, please contact us at telephone: (86-755) 8307 1443, or email: CN.Doccheck@sgs.com

Fuyong lab, Xinlong TechnoPark, Fengtang Road, Fuyong Subdistrict, Bao'an, Shenzhen, China 518103 t (86-755) 88663988 f (86-755) 26710594 www.sgs.com.cn
 中国·深圳·宝安区福永街道凤塘大道鑫龙科技园福永实验室 邮编: 518103 t (86-755) 88663988 f (86-755) 26710594 sgs.china@sgs.com

Compliance Certification Services (Kunshan) Inc. Shenzhen Branch

SZCCS-TRF-01 Rev. A/0 Aug01,2022

Report No.: FYCR221100046605

Page: 144 of 344

Test Mode: 11; Polarity: Vertical; Modulation:802.11a; Bandwidth:20MHz; Channel:Low

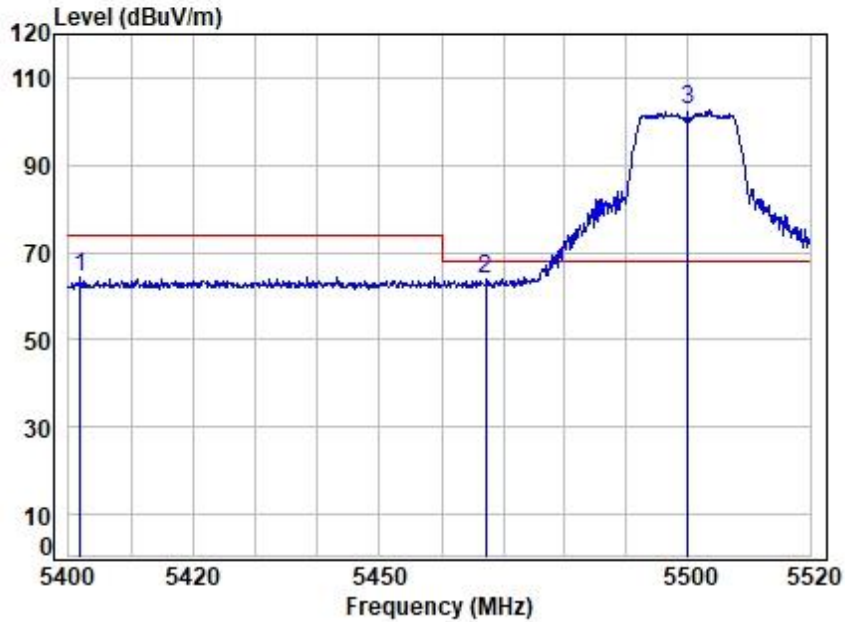

Site : chamber
 Condition: 3m VERTICAL
 Job No : 00466AT
 Mode : 5500 Band edge
 : 5G WIFI 11A

		Cable	Ant	Preamp	Read	Limit	Over	
	Freq	Loss	Factor	Factor	Level	Line	Limit	Remark
	MHz	dB	dB/m	dB	dBuV	dBuV/m	dBuV/m	dB
1	5401.899	8.28	32.37	32.17	55.97	64.45	74.00	-9.55 Peak
2	5467.235	8.27	32.52	32.26	55.43	63.96	68.20	-4.24 peak
3	5500.000	8.27	32.60	32.30	94.22	102.79	68.20	34.59 Peak



Unless otherwise agreed in writing, this document is issued by the Company subject to its General Conditions of Service printed overleaf, available on request or accessible at <http://www.sgs.com/en/Terms-and-Conditions.aspx> and, for electronic format documents, subject to Terms and Conditions for Electronic Documents at <http://www.sgs.com/en/Terms-and-Conditions/Terms-e-Documents.aspx>. Attention is drawn to the limitation of liability, indemnification and jurisdiction issues defined therein. Any holder of this document is advised that information contained hereon reflects the Company's findings at the time of its intervention only and within the limits of Client's instructions, if any. The Company's sole responsibility is to its Client and this document does not exonerate parties to a transaction from exercising all their rights and obligations under the transaction documents. This document cannot be reproduced except in full, without prior written approval of the Company. Any unauthorized alteration, forgery or falsification of the content or appearance of this document is unlawful and offenders may be prosecuted to the fullest extent of the law. Unless otherwise stated the results shown in this test report refer only to the sample(s) tested and such sample(s) are retained for 30 days only.
Attention: To check the authenticity of testing /inspection report & certificate, please contact us at telephone: (86-755) 8307 1443, or email: CN.Doccheck@sgs.com

Fuyong lab, Xinlong TechnoPark, Fengtang Road, Fuyong Subdistrict, Bao'an, Shenzhen, China 518103 t (86-755) 88663988 f (86-755) 26710594 www.sgsgroup.com.cn
 中国·深圳·宝安区福永街道凤塘大道鑫龙科技园福永实验室 邮编: 518103 t (86-755) 88663988 f (86-755) 26710594 sgs.china@sgs.com

Test Mode: 11; Polarity: Vertical; Modulation:802.11a; Bandwidth:20MHz; Channel:Low

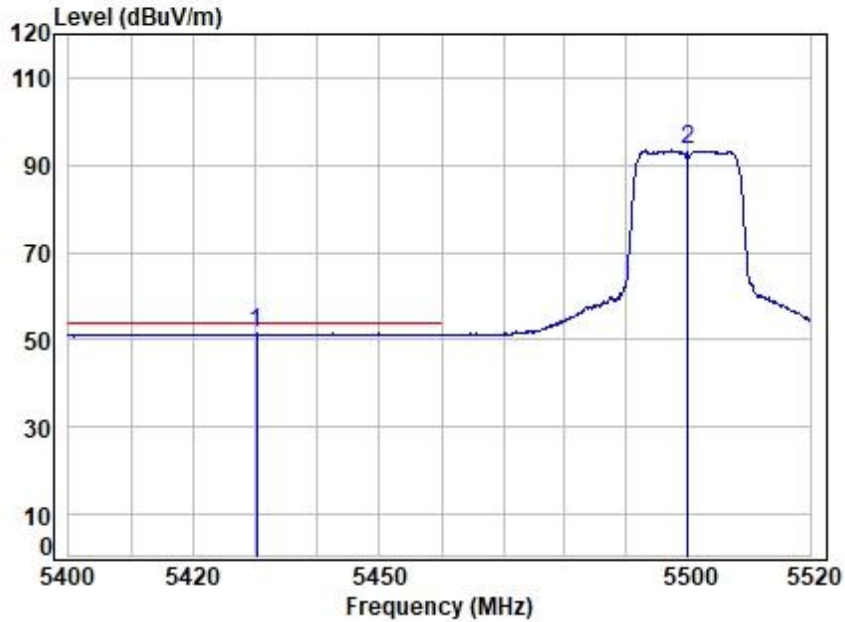

Site : chamber
 Condition: 3m VERTICAL
 Job No : 00466AT
 Mode : 5500 Band edge
 : 5G WIFI 11A

	Freq	Cable Loss	Ant Factor	Preamp Factor	Read Level	Level	Limit	Over	Remark
	MHz	dB	dB/m	dB	dBuV	dBuV/m	dBuV/m	dB	
1	5430.230	8.27	32.44	32.21	42.90	51.40	54.00	-2.60	Average
2	5500.000	8.27	32.60	32.30	84.89	93.46	-----	-----	Average



Unless otherwise agreed in writing, this document is issued by the Company subject to its General Conditions of Service printed overleaf, available on request or accessible at <http://www.sgs.com/en/Terms-and-Conditions.aspx> and, for electronic format documents, subject to Terms and Conditions for Electronic Documents at <http://www.sgs.com/en/Terms-and-Conditions/Terms-e-Documents.aspx>. Attention is drawn to the limitation of liability, indemnification and jurisdiction issues defined therein. Any holder of this document is advised that information contained hereon reflects the Company's findings at the time of its intervention only and within the limits of Client's instructions, if any. The Company's sole responsibility is to its Client and this document does not exonerate parties to a transaction from exercising all their rights and obligations under the transaction documents. This document cannot be reproduced except in full, without prior written approval of the Company. Any unauthorized alteration, forgery or falsification of the content or appearance of this document is unlawful and offenders may be prosecuted to the fullest extent of the law. Unless otherwise stated the results shown in this test report refer only to the sample(s) tested and such sample(s) are retained for 30 days only.
Attention: To check the authenticity of testing /inspection report & certificate, please contact us at telephone: (86-755) 8307 1443, or email: CN.Doccheck@sgs.com

Fuyong lab, Xinlong TechnoPark, Fengtang Road, Fuyong Subdistrict, Bao'an, Shenzhen, China 518103 t (86-755) 88663988 f (86-755) 26710594 www.sgs.com.cn
 中国·深圳·宝安区福永街道凤塘大道鑫龙科技园福永实验室 邮编: 518103 t (86-755) 88663988 f (86-755) 26710594 sgs.china@sgs.com

Test Mode: 11; Polarity: Horizontal; Modulation:802.11a; Bandwidth:20MHz; Channel:High

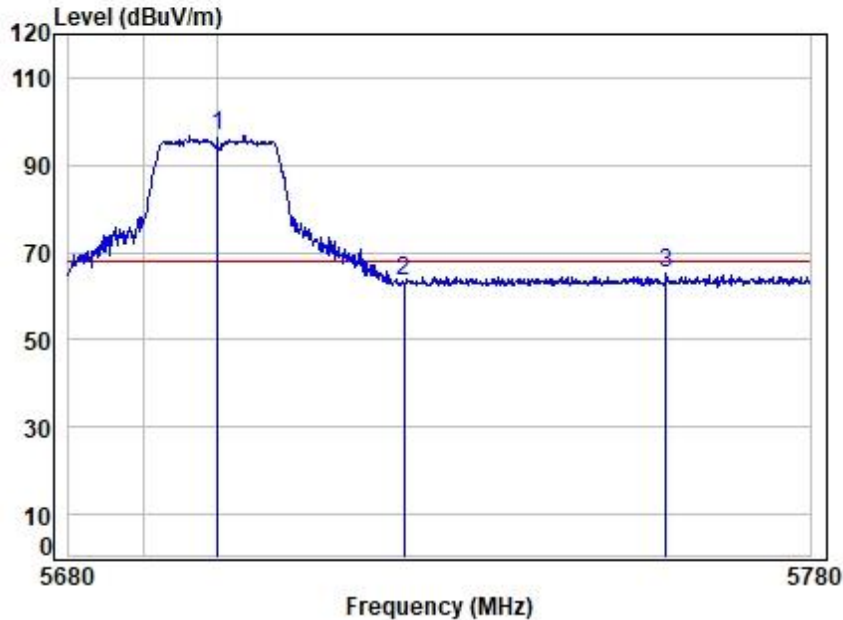

Site : chamber
 Condition: 3m HORIZONTAL
 Job No : 00466AT
 Mode : 5700 Band edge
 : 5G WIFI 11A

	Cable	Ant	Preamp	Read	Limit	Over		
Freq	Loss	Factor	Factor	Level	Level	Line	Limit	Remark
MHz	dB	dB/m	dB	dBuV	dBuV/m	dBuV/m	dB	
1 . 5700.000	8.01	32.52	32.22	88.57	96.88	68.20	28.68	peak
2 5725.000	7.98	32.51	32.21	55.18	63.46	68.20	-4.74	peak
3 5760.463	7.93	32.49	32.19	57.12	65.35	68.20	-2.85	peak



Unless otherwise agreed in writing, this document is issued by the Company subject to its General Conditions of Service printed overleaf, available on request or accessible at <http://www.sgs.com/en/Terms-and-Conditions.aspx> and, for electronic format documents, subject to Terms and Conditions for Electronic Documents at <http://www.sgs.com/en/Terms-and-Conditions/Terms-e-Documents.aspx>. Attention is drawn to the limitation of liability, indemnification and jurisdiction issues defined therein. Any holder of this document is advised that information contained hereon reflects the Company's findings at the time of its intervention only and within the limits of Client's instructions, if any. The Company's sole responsibility is to its Client and this document does not exonerate parties to a transaction from exercising all their rights and obligations under the transaction documents. This document cannot be reproduced except in full, without prior written approval of the Company. Any unauthorized alteration, forgery or falsification of the content or appearance of this document is unlawful and offenders may be prosecuted to the fullest extent of the law. Unless otherwise stated the results shown in this test report refer only to the sample(s) tested and such sample(s) are retained for 30 days only.
Attention: To check the authenticity of testing /inspection report & certificate, please contact us at telephone: (86-755) 8307 1443, or email: CN.Doccheck@sgs.com

Fuyong lab, Xinlong TechnoPark, Fengtang Road, Fuyong Subdistrict, Bao'an, Shenzhen, China 518103 t (86-755) 88663988 f (86-755) 26710594 www.sgs.com.cn
 中国·深圳·宝安区福永街道凤塘大道鑫龙科技园福永实验室 邮编: 518103 t (86-755) 88663988 f (86-755) 26710594 sgs.china@sgs.com

Test Mode: 11; Polarity: Vertical; Modulation:802.11a; Bandwidth:20MHz; Channel:High

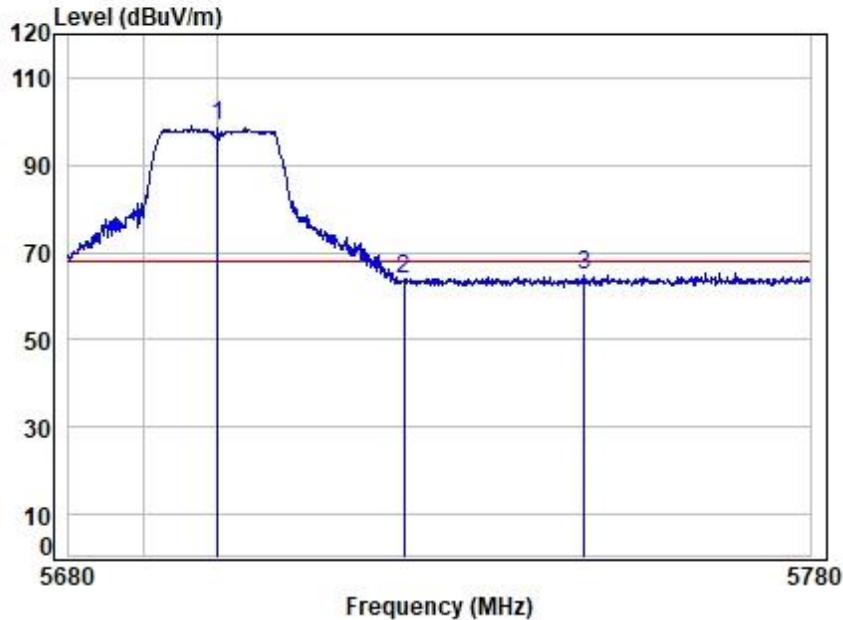

Site : chamber
 Condition: 3m VERTICAL
 Job No : 00466AT
 Mode : 5700 Band edge
 : 5G WIFI 11A

	Cable	Ant	Preamp	Read	Limit	Over	
Freq	Loss	Factor	Factor	Level	Level	Line	Limit
MHz	dB	dB/m	dB	dBuV	dBuV/m	dBuV/m	dB
1 . 5700.000	8.01	32.52	32.22	90.84	99.15	68.20	30.95 Peak
2 5725.000	7.98	32.51	32.21	55.41	63.69	68.20	-4.51 Peak
3 5749.315	7.95	32.50	32.20	56.60	64.85	68.20	-3.35 Peak



Unless otherwise agreed in writing, this document is issued by the Company subject to its General Conditions of Service printed overleaf, available on request or accessible at <http://www.sgs.com/en/Terms-and-Conditions.aspx> and, for electronic format documents, subject to Terms and Conditions for Electronic Documents at <http://www.sgs.com/en/Terms-and-Conditions/Terms-e-Documents.aspx>. Attention is drawn to the limitation of liability, indemnification and jurisdiction issues defined therein. Any holder of this document is advised that information contained hereon reflects the Company's findings at the time of its intervention only and within the limits of Client's instructions, if any. The Company's sole responsibility is to its Client and this document does not exonerate parties to a transaction from exercising all their rights and obligations under the transaction documents. This document cannot be reproduced except in full, without prior written approval of the Company. Any unauthorized alteration, forgery or falsification of the content or appearance of this document is unlawful and offenders may be prosecuted to the fullest extent of the law. Unless otherwise stated the results shown in this test report refer only to the sample(s) tested and such sample(s) are retained for 30 days only.
Attention: To check the authenticity of testing /inspection report & certificate, please contact us at telephone: (86-755) 8307 1443, or email: CN.Doccheck@sgs.com

Fuyong lab, Xinlong TechnoPark, Fengtang Road, Fuyong Subdistrict, Bao'an, Shenzhen, China 518103 t (86-755) 88663988 f (86-755) 26710594 www.sgsgroup.com.cn
 中国·深圳·宝安区福永街道凤塘大道鑫龙科技园福永实验室 邮编: 518103 t (86-755) 88663988 f (86-755) 26710594 sgs.china@sgs.com

Test Mode: 11; Polarity: Horizontal; Modulation:802.11n; Bandwidth:20MHz; Channel:Low

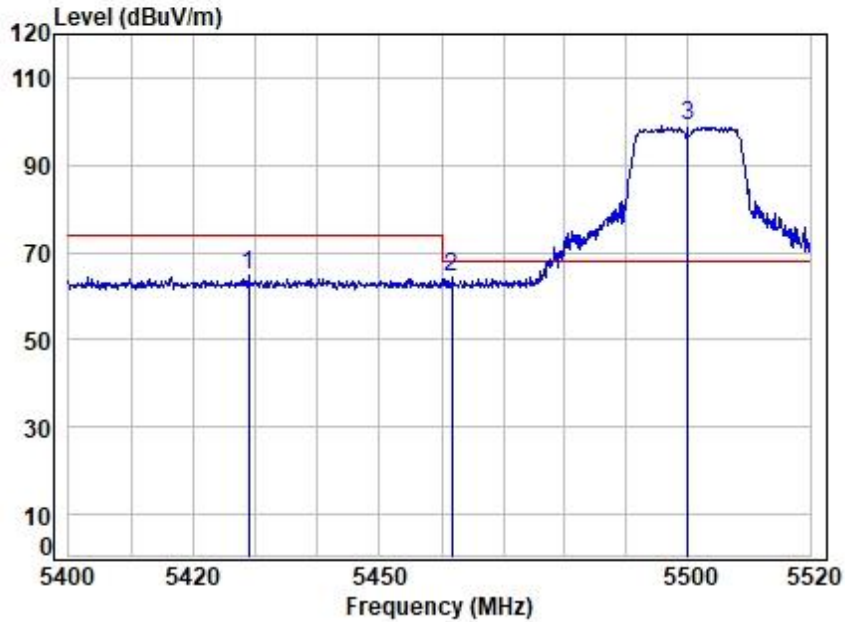

Site : chamber
 Condition: 3m HORIZONTAL
 Job No : 00466AT
 Mode : 5500 Band edge
 : 5G WIFI 11N20

	Freq	Cable Loss	Ant Factor	Preamp Factor	Read Level	Level	Limit	Over	Remark
	MHz	dB	dB/m	dB	dBuV	dBuV/m	dBuV/m	dB	
1	5428.918	8.27	32.44	32.20	56.22	64.73	74.00	-9.27	peak
2	5461.710	8.27	32.51	32.25	55.65	64.18	68.20	-4.02	peak
3	5500.000	8.27	32.60	32.30	90.54	99.11	68.20	30.91	peak



Unless otherwise agreed in writing, this document is issued by the Company subject to its General Conditions of Service printed overleaf, available on request or accessible at <http://www.sgs.com/en/Terms-and-Conditions.aspx> and, for electronic format documents, subject to Terms and Conditions for Electronic Documents at <http://www.sgs.com/en/Terms-and-Conditions/Terms-e-Documents.aspx>. Attention is drawn to the limitation of liability, indemnification and jurisdiction issues defined therein. Any holder of this document is advised that information contained hereon reflects the Company's findings at the time of its intervention only and within the limits of Client's instructions, if any. The Company's sole responsibility is to its Client and this document does not exonerate parties to a transaction from exercising all their rights and obligations under the transaction documents. This document cannot be reproduced except in full, without prior written approval of the Company. Any unauthorized alteration, forgery or falsification of the content or appearance of this document is unlawful and offenders may be prosecuted to the fullest extent of the law. Unless otherwise stated the results shown in this test report refer only to the sample(s) tested and such sample(s) are retained for 30 days only.
Attention: To check the authenticity of testing /inspection report & certificate, please contact us at telephone: (86-755) 8307 1443, or email: CN.Doccheck@sgs.com

Fuyong lab, Xinlong TechnoPark, Fengtang Road, Fuyong Subdistrict, Bao'an, Shenzhen, China 518103 t (86-755) 88663988 f (86-755) 26710594 www.sgs.com.cn
 中国·深圳·宝安区福永街道凤塘大道鑫龙科技园福永实验室 邮编: 518103 t (86-755) 88663988 f (86-755) 26710594 sgs.china@sgs.com

Compliance Certification Services (Kunshan) Inc. Shenzhen Branch

SZCCS-TRF-01 Rev. A/0 Aug01,2022

Report No.: FYCR221100046605

Page: 149 of 344

Test Mode: 11; Polarity: Horizontal; Modulation:802.11n; Bandwidth:20MHz; Channel:Low

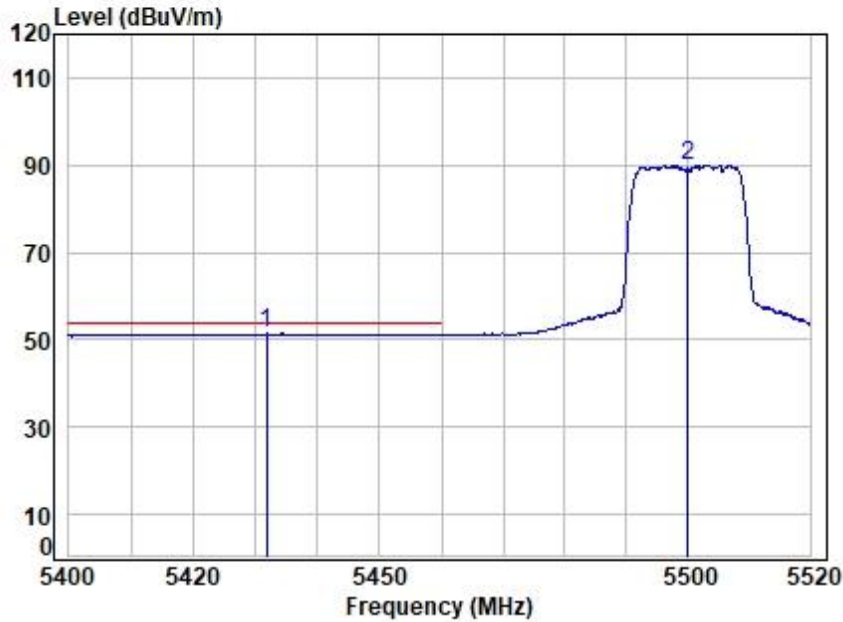

Site : chamber
 Condition: 3m HORIZONTAL
 Job No : 00466AT
 Mode : 5500 Band edge
 : 5G WIFI 11N20

	Freq	Cable Loss	Ant Factor	Preamp Factor	Read Level	Level	Limit	Over	Remark
	MHz	dB	dB/m	dB	dBuV	dBuV/m	dBuV/m	dB	
1	5431.782	8.27	32.44	32.21	42.86	51.36	54.00	-2.64	Average
2	5500.000	8.27	32.60	32.30	81.53	90.10	-----	-----	Average



Unless otherwise agreed in writing, this document is issued by the Company subject to its General Conditions of Service printed overleaf, available on request or accessible at <http://www.sgs.com/en/Terms-and-Conditions.aspx> and, for electronic format documents, subject to Terms and Conditions for Electronic Documents at <http://www.sgs.com/en/Terms-and-Conditions/Terms-e-Documents.aspx>. Attention is drawn to the limitation of liability, indemnification and jurisdiction issues defined therein. Any holder of this document is advised that information contained hereon reflects the Company's findings at the time of its intervention only and within the limits of Client's instructions, if any. The Company's sole responsibility is to its Client and this document does not exonerate parties to a transaction from exercising all their rights and obligations under the transaction documents. This document cannot be reproduced except in full, without prior written approval of the Company. Any unauthorized alteration, forgery or falsification of the content or appearance of this document is unlawful and offenders may be prosecuted to the fullest extent of the law. Unless otherwise stated the results shown in this test report refer only to the sample(s) tested and such sample(s) are retained for 30 days only.
Attention: To check the authenticity of testing /inspection report & certificate, please contact us at telephone: (86-755) 8307 1443, or email: CN.Doccheck@sgs.com

Fuyong lab, Xinlong TechnoPark, Fengtang Road, Fuyong Subdistrict, Bao'an, Shenzhen, China 518103 t (86-755) 88663988 f (86-755) 26710594 www.sgs.com.cn
 中国·深圳·宝安区福永街道凤塘大道鑫龙科技园福永实验室 邮编: 518103 t (86-755) 88663988 f (86-755) 26710594 sgs.china@sgs.com

Test Mode: 11; Polarity: Vertical; Modulation:802.11n; Bandwidth:20MHz; Channel:Low

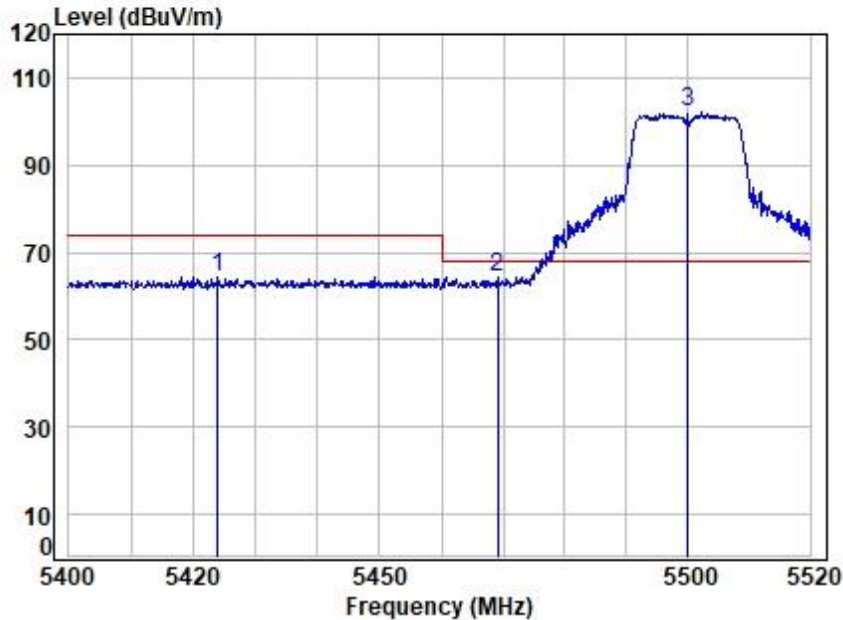

Site : chamber
 Condition: 3m VERTICAL
 Job No : 00466AT
 Mode : 5500 Band edge
 : 5G WIFI 11N20

		Cable	Ant	Preamp	Read	Limit	Over	
	Freq	Loss	Factor	Factor	Level	Line	Limit	Remark
	MHz	dB	dB/m	dB	dBuV	dBuV/m	dBuV/m	dB
1	5423.909	8.27	32.42	32.20	55.93	64.42	74.00	-9.58 Peak
2	5469.038	8.27	32.53	32.26	55.81	64.35	68.20	-3.85 peak
3	5500.000	8.27	32.60	32.30	93.45	102.02	68.20	33.82 Peak



Unless otherwise agreed in writing, this document is issued by the Company subject to its General Conditions of Service printed overleaf, available on request or accessible at <http://www.sgs.com/en/Terms-and-Conditions.aspx> and, for electronic format documents, subject to Terms and Conditions for Electronic Documents at <http://www.sgs.com/en/Terms-and-Conditions/Terms-e-Documents.aspx>. Attention is drawn to the limitation of liability, indemnification and jurisdiction issues defined therein. Any holder of this document is advised that information contained hereon reflects the Company's findings at the time of its intervention only and within the limits of Client's instructions, if any. The Company's sole responsibility is to its Client and this document does not exonerate parties to a transaction from exercising all their rights and obligations under the transaction documents. This document cannot be reproduced except in full, without prior written approval of the Company. Any unauthorized alteration, forgery or falsification of the content or appearance of this document is unlawful and offenders may be prosecuted to the fullest extent of the law. Unless otherwise stated the results shown in this test report refer only to the sample(s) tested and such sample(s) are retained for 30 days only.
Attention: To check the authenticity of testing /inspection report & certificate, please contact us at telephone: (86-755) 8307 1443, or email: CN.Doccheck@sgs.com

Fuyong lab, Xinlong TechnoPark, Fengtang Road, Fuyong Subdistrict, Bao'an, Shenzhen, China 518103 t (86-755) 88663988 f (86-755) 26710594 www.sgsgroup.com.cn
 中国·深圳·宝安区福永街道凤塘大道鑫龙科技园福永实验室 邮编: 518103 t (86-755) 88663988 f (86-755) 26710594 sgs.china@sgs.com

Test Mode: 11; Polarity: Vertical; Modulation:802.11n; Bandwidth:20MHz; Channel:Low

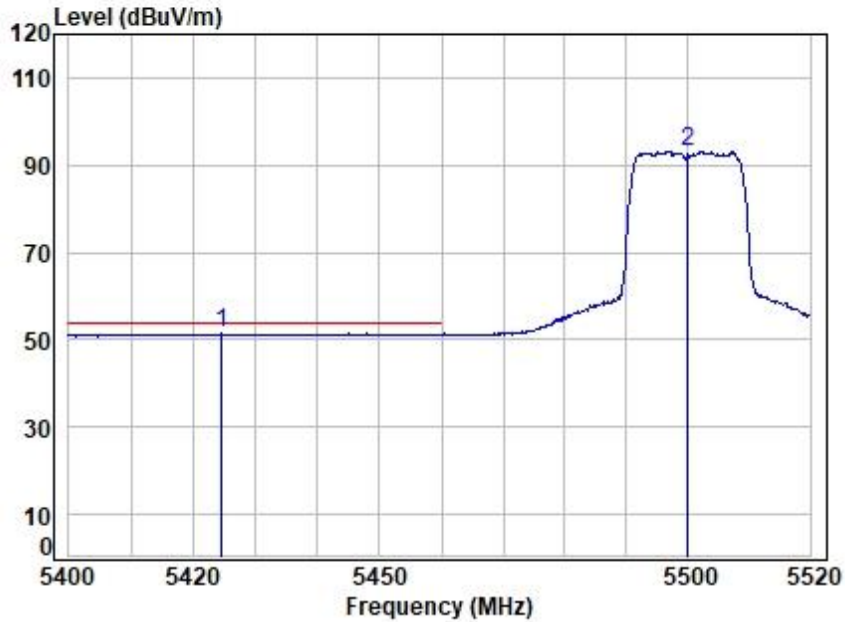

Site : chamber
 Condition: 3m VERTICAL
 Job No : 00466AT
 Mode : 5500 Band edge
 : 5G WIFI 11N20

	Freq	Cable Loss	Ant Factor	Preamp Factor	Read Level	Level	Limit	Over	Remark
	MHz	dB	dB/m	dB	dBuV	dBuV/m	dBuV/m	dB	
1	5424.624	8.27	32.43	32.20	42.90	51.40	54.00	-2.60	Average
2	5500.000	8.27	32.60	32.30	84.52	93.09	-----	-----	Average



Unless otherwise agreed in writing, this document is issued by the Company subject to its General Conditions of Service printed overleaf, available on request or accessible at <http://www.sgs.com/en/Terms-and-Conditions.aspx> and, for electronic format documents, subject to Terms and Conditions for Electronic Documents at <http://www.sgs.com/en/Terms-and-Conditions/Terms-e-Documents.aspx>. Attention is drawn to the limitation of liability, indemnification and jurisdiction issues defined therein. Any holder of this document is advised that information contained hereon reflects the Company's findings at the time of its intervention only and within the limits of Client's instructions, if any. The Company's sole responsibility is to its Client and this document does not exonerate parties to a transaction from exercising all their rights and obligations under the transaction documents. This document cannot be reproduced except in full, without prior written approval of the Company. Any unauthorized alteration, forgery or falsification of the content or appearance of this document is unlawful and offenders may be prosecuted to the fullest extent of the law. Unless otherwise stated the results shown in this test report refer only to the sample(s) tested and such sample(s) are retained for 30 days only.
Attention: To check the authenticity of testing /inspection report & certificate, please contact us at telephone: (86-755) 8307 1443, or email: CN.Doccheck@sgs.com

Fuyong lab, Xinlong TechnoPark, Fengtang Road, Fuyong Subdistrict, Bao'an, Shenzhen, China 518103 t (86-755) 88663988 f (86-755) 26710594 www.sgs.com.cn
 中国·深圳·宝安区福永街道凤塘大道鑫龙科技园福永实验室 邮编: 518103 t (86-755) 88663988 f (86-755) 26710594 sgs.china@sgs.com

Test Mode: 11; Polarity: Horizontal; Modulation:802.11n; Bandwidth:20MHz; Channel:High

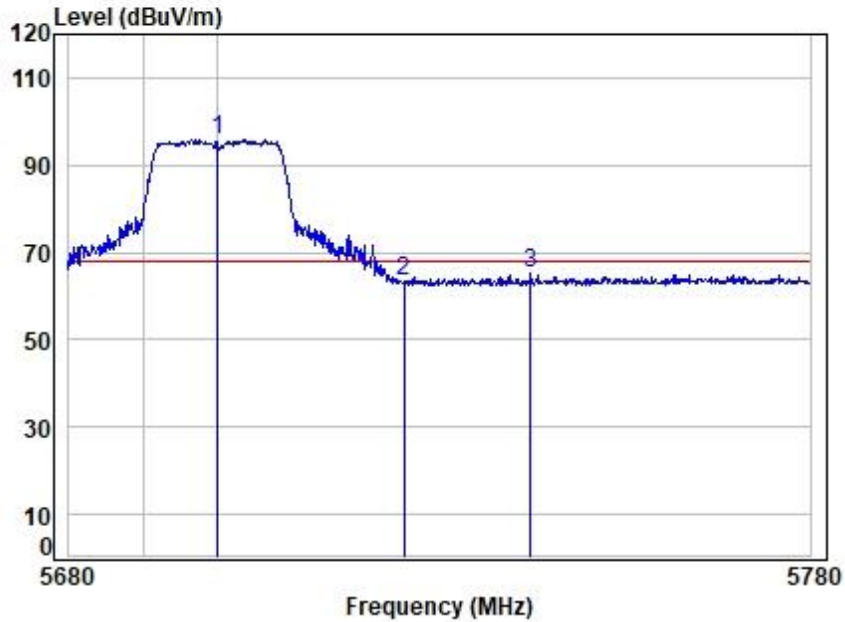

Site : chamber
 Condition: 3m HORIZONTAL
 Job No : 00466AT
 Mode : 5700 Band edge
 : 5G WIFI 11N20

	Cable	Ant	Preamp	Read	Limit	Over		
Freq	Loss	Factor	Factor	Level	Level	Line	Limit	Remark
MHz	dB	dB/m	dB	dBuV	dBuV/m	dBuV/m	dB	
1 . 5700.000	8.01	32.52	32.22	87.58	95.89	68.20	27.69	peak
2 5725.000	7.98	32.51	32.21	55.16	63.44	68.20	-4.76	peak
3 5742.095	7.96	32.50	32.20	56.85	65.11	68.20	-3.09	peak



Unless otherwise agreed in writing, this document is issued by the Company subject to its General Conditions of Service printed overleaf, available on request or accessible at <http://www.sgs.com/en/Terms-and-Conditions.aspx> and, for electronic format documents, subject to Terms and Conditions for Electronic Documents at <http://www.sgs.com/en/Terms-and-Conditions/Terms-e-Documents.aspx>. Attention is drawn to the limitation of liability, indemnification and jurisdiction issues defined therein. Any holder of this document is advised that information contained hereon reflects the Company's findings at the time of its intervention only and within the limits of Client's instructions, if any. The Company's sole responsibility is to its Client and this document does not exonerate parties to a transaction from exercising all their rights and obligations under the transaction documents. This document cannot be reproduced except in full, without prior written approval of the Company. Any unauthorized alteration, forgery or falsification of the content or appearance of this document is unlawful and offenders may be prosecuted to the fullest extent of the law. Unless otherwise stated the results shown in this test report refer only to the sample(s) tested and such sample(s) are retained for 30 days only.
Attention: To check the authenticity of testing /inspection report & certificate, please contact us at telephone: (86-755) 8307 1443, or email: CN.Doccheck@sgs.com

Fuyong lab, Xinlong TechnoPark, Fengtang Road, Fuyong Subdistrict, Bao'an, Shenzhen, China 518103 t (86-755) 88663988 f (86-755) 26710594 www.sgsgroup.com.cn
 中国·深圳·宝安区福永街道凤塘大道鑫龙科技园福永实验室 邮编: 518103 t (86-755) 88663988 f (86-755) 26710594 sgs.china@sgs.com

Test Mode: 11; Polarity: Vertical; Modulation:802.11n; Bandwidth:20MHz; Channel:High

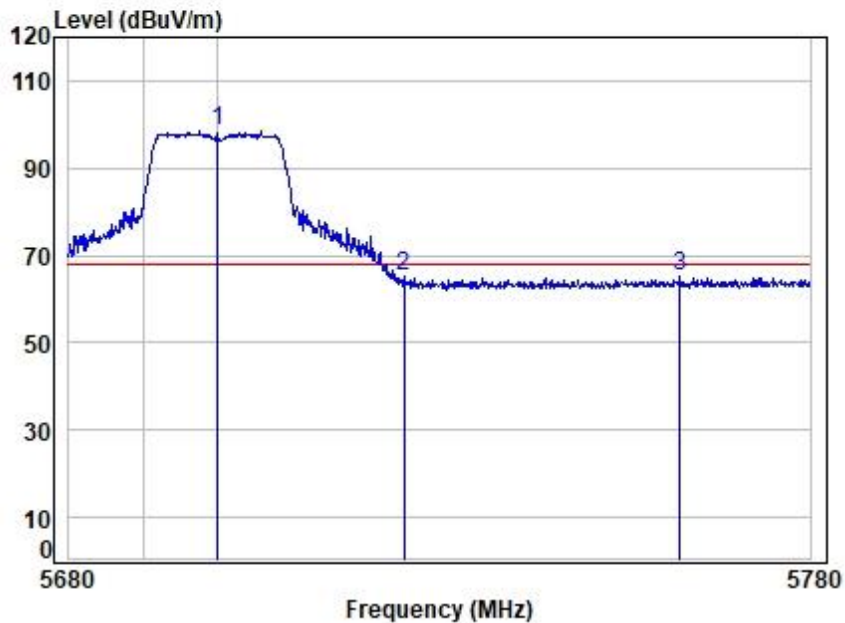

Site : chamber
 Condition: 3m VERTICAL
 Job No : 00466AT
 Mode : 5700 Band edge
 : 5G WIFI 11N20

	Cable	Ant	Preamp	Read	Limit	Over		
Freq	Loss	Factor	Factor	Level	Level	Line	Limit	Remark
MHz	dB	dB/m	dB	dBuV	dBuV/m	dBuV/m	dB	
1 . 5700.000	8.01	32.52	32.22	90.43	98.74	68.20	30.54	Peak
2 5725.000	7.98	32.51	32.21	56.91	65.19	68.20	-3.01	Peak
3 5762.273	7.93	32.49	32.19	57.04	65.27	68.20	-2.93	Peak



Unless otherwise agreed in writing, this document is issued by the Company subject to its General Conditions of Service printed overleaf, available on request or accessible at <http://www.sgs.com/en/Terms-and-Conditions.aspx> and, for electronic format documents, subject to Terms and Conditions for Electronic Documents at <http://www.sgs.com/en/Terms-and-Conditions/Terms-e-Document.aspx>. Attention is drawn to the limitation of liability, indemnification and jurisdiction issues defined therein. Any holder of this document is advised that information contained hereon reflects the Company's findings at the time of its intervention only and within the limits of Client's instructions, if any. The Company's sole responsibility is to its Client and this document does not exonerate parties to a transaction from exercising all their rights and obligations under the transaction documents. This document cannot be reproduced except in full, without prior written approval of the Company. Any unauthorized alteration, forgery or falsification of the content or appearance of this document is unlawful and offenders may be prosecuted to the fullest extent of the law. Unless otherwise stated the results shown in this test report refer only to the sample(s) tested and such sample(s) are retained for 30 days only.
Attention: To check the authenticity of testing /inspection report & certificate, please contact us at telephone: (86-755) 8307 1443, or email: CN.Doccheck@sgs.com

Fuyong lab, Xinlong TechnoPark, Fengtang Road, Fuyong Subdistrict, Bao'an, Shenzhen, China 518103 t (86-755) 88663988 f (86-755) 26710594 www.sgsgroup.com.cn
 中国·深圳·宝安区福永街道凤塘大道鑫龙科技园福永实验室 邮编: 518103 t (86-755) 88663988 f (86-755) 26710594 sgs.china@sgs.com

Compliance Certification Services (Kunshan) Inc. Shenzhen Branch

SZCCS-TRF-01 Rev. A/0 Aug01,2022

Report No.: FYCR221100046605

Page: 154 of 344

Test Mode: 11; Polarity: Horizontal; Modulation:802.11n; Bandwidth:40MHz; Channel:Low

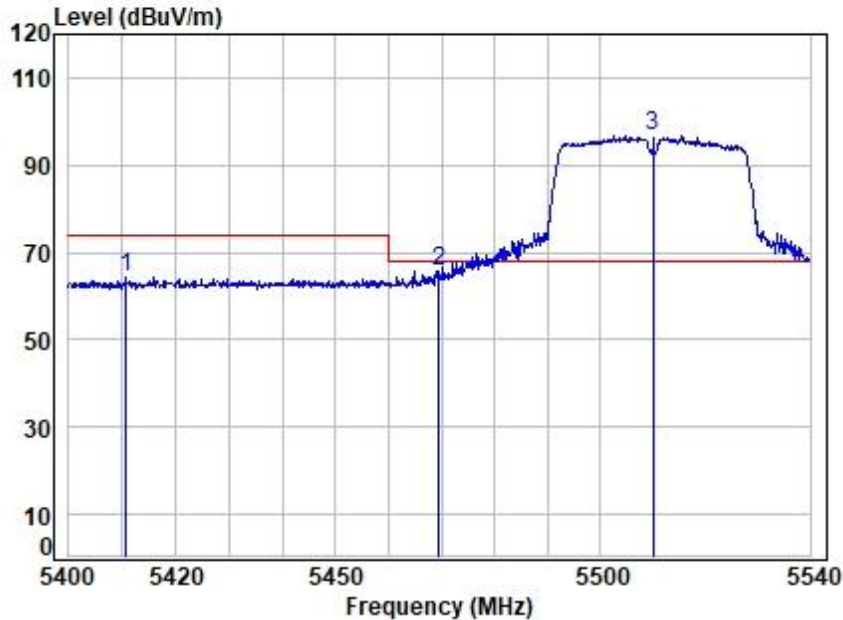

Site : chamber
 Condition: 3m HORIZONTAL
 Job No : 00466AT
 Mode : 5510 Band edge
 : 5G WIFI 11N40

	Freq	Cable Loss	Ant Factor	Preamp Factor	Read Level	Limit	Over	Remark
	MHz	dB	dB/m	dB	dBuV	dBuV/m	dB	
1	5410.653	8.28	32.39	32.18	55.89	74.00	-9.62	peak
2	5469.552	8.27	32.53	32.26	57.30	68.20	-2.36	peak
3	5510.000	8.26	32.60	32.30	88.33	68.20	28.69	peak



Unless otherwise agreed in writing, this document is issued by the Company subject to its General Conditions of Service printed overleaf, available on request or accessible at <http://www.sgs.com/en/Terms-and-Conditions.aspx> and, for electronic format documents, subject to Terms and Conditions for Electronic Documents at <http://www.sgs.com/en/Terms-and-Conditions/Terms-e-Documents.aspx>. Attention is drawn to the limitation of liability, indemnification and jurisdiction issues defined therein. Any holder of this document is advised that information contained hereon reflects the Company's findings at the time of its intervention only and within the limits of Client's instructions, if any. The Company's sole responsibility is to its Client and this document does not exonerate parties to a transaction from exercising all their rights and obligations under the transaction documents. This document cannot be reproduced except in full, without prior written approval of the Company. Any unauthorized alteration, forgery or falsification of the content or appearance of this document is unlawful and offenders may be prosecuted to the fullest extent of the law. Unless otherwise stated the results shown in this test report refer only to the sample(s) tested and such sample(s) are retained for 30 days only.
Attention: To check the authenticity of testing /inspection report & certificate, please contact us at telephone: (86-755) 8307 1443, or email: CN.Doccheck@sgs.com

Fuyong lab, Xinlong TechnoPark, Fengtang Road, Fuyong Subdistrict, Bao'an, Shenzhen, China 518103 t (86-755) 88663988 f (86-755) 26710594 www.sgsgroup.com.cn
 中国·深圳·宝安区福永街道凤塘大道鑫龙科技园福永实验室 邮编: 518103 t (86-755) 88663988 f (86-755) 26710594 sgs.china@sgs.com

Test Mode: 11; Polarity: Horizontal; Modulation:802.11n; Bandwidth:40MHz; Channel:Low

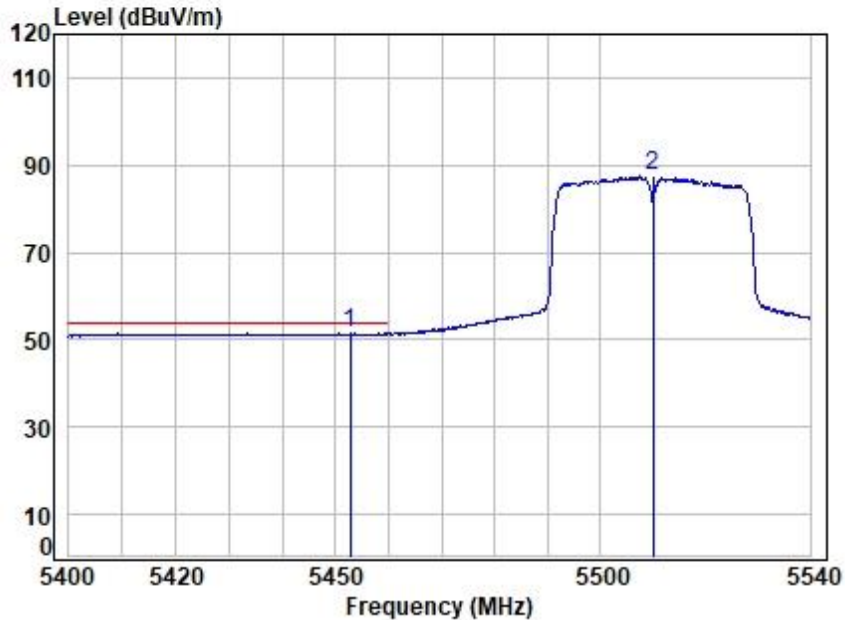

Site : chamber
 Condition: 3m HORIZONTAL
 Job No : 00466AT
 Mode : 5510 Band edge
 : 5G WIFI 11N40

	Freq	Cable Loss	Ant Factor	Preamp Factor	Read Level	Level	Limit	Over	Remark
	MHz	dB	dB/m	dB	dBuV	dBuV/m	dBuV/m	dB	
1	5452.778	8.27	32.49	32.24	42.98	51.50	54.00	-2.50	Average
2	5510.000	8.26	32.60	32.30	78.84	87.40	-----	-----	Average



Unless otherwise agreed in writing, this document is issued by the Company subject to its General Conditions of Service printed overleaf, available on request or accessible at <http://www.sgs.com/en/Terms-and-Conditions.aspx> and, for electronic format documents, subject to Terms and Conditions for Electronic Documents at <http://www.sgs.com/en/Terms-and-Conditions/Terms-e-Documents.aspx>. Attention is drawn to the limitation of liability, indemnification and jurisdiction issues defined therein. Any holder of this document is advised that information contained hereon reflects the Company's findings at the time of its intervention only and within the limits of Client's instructions, if any. The Company's sole responsibility is to its Client and this document does not exonerate parties to a transaction from exercising all their rights and obligations under the transaction documents. This document cannot be reproduced except in full, without prior written approval of the Company. Any unauthorized alteration, forgery or falsification of the content or appearance of this document is unlawful and offenders may be prosecuted to the fullest extent of the law. Unless otherwise stated the results shown in this test report refer only to the sample(s) tested and such sample(s) are retained for 30 days only.
Attention: To check the authenticity of testing /inspection report & certificate, please contact us at telephone: (86-755) 8307 1443, or email: CN.Doccheck@sgs.com

Fuyong lab, Xinlong TechnoPark, Fengtang Road, Fuyong Subdistrict, Bao'an, Shenzhen, China 518103 t (86-755) 88663988 f (86-755) 26710594 www.sgsgroup.com.cn
 中国·深圳·宝安区福永街道凤塘大道鑫龙科技园福永实验室 邮编: 518103 t (86-755) 88663988 f (86-755) 26710594 sgs.china@sgs.com

Test Mode: 11; Polarity: Vertical; Modulation:802.11n; Bandwidth:40MHz; Channel:Low

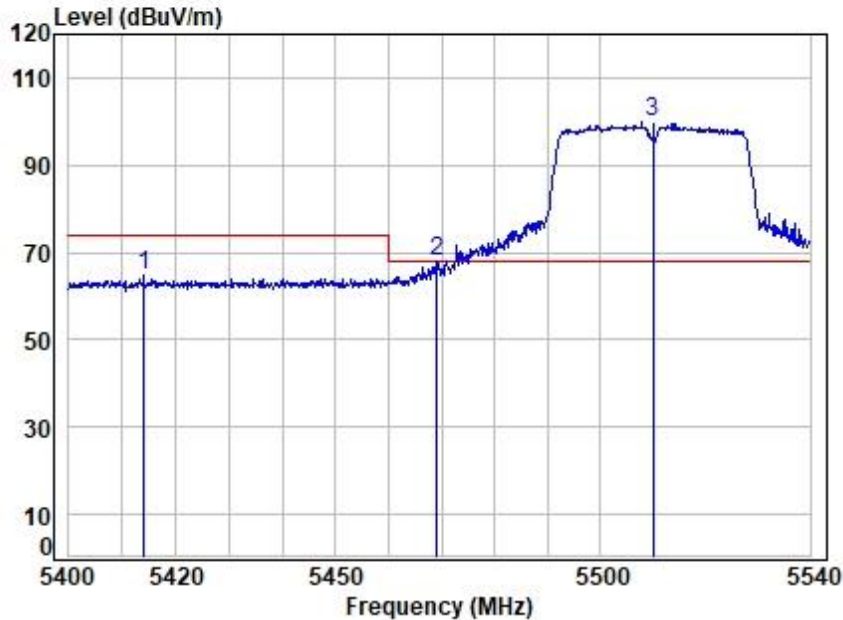

Site : chamber
 Condition: 3m VERTICAL
 Job No : 00466AT
 Mode : 5510 Band edge
 : 5G WIFI 11N40

	Freq	Cable Loss	Ant Factor	Preamp Factor	Read Level	Limit Level	Over Limit	Remark
	MHz	dB	dB/m	dB	dBuV	dBuV/m	dB	
1	5413.978	8.27	32.40	32.18	56.42	74.00	-9.09	Peak
2	5469.132	8.27	32.53	32.26	59.44	68.20	-0.22	peak
3	5510.000	8.26	32.60	32.30	91.50	68.20	31.86	Peak



Unless otherwise agreed in writing, this document is issued by the Company subject to its General Conditions of Service printed overleaf, available on request or accessible at <http://www.sgs.com/en/Terms-and-Conditions.aspx> and, for electronic format documents, subject to Terms and Conditions for Electronic Documents at <http://www.sgs.com/en/Terms-and-Conditions/Terms-e-Documents.aspx>. Attention is drawn to the limitation of liability, indemnification and jurisdiction issues defined therein. Any holder of this document is advised that information contained hereon reflects the Company's findings at the time of its intervention only and within the limits of Client's instructions, if any. The Company's sole responsibility is to its Client and this document does not exonerate parties to a transaction from exercising all their rights and obligations under the transaction documents. This document cannot be reproduced except in full, without prior written approval of the Company. Any unauthorized alteration, forgery or falsification of the content or appearance of this document is unlawful and offenders may be prosecuted to the fullest extent of the law. Unless otherwise stated the results shown in this test report refer only to the sample(s) tested and such sample(s) are retained for 30 days only.
Attention: To check the authenticity of testing /inspection report & certificate, please contact us at telephone: (86-755) 8307 1443, or email: CN.Doccheck@sgs.com

Fuyong lab, Xinlong TechnoPark, Fengtang Road, Fuyong Subdistrict, Bao'an, Shenzhen, China 518103 t (86-755) 88663988 f (86-755) 26710594 www.sgsgroup.com.cn
 中国·深圳·宝安区福永街道凤塘大道鑫龙科技园福永实验室 邮编: 518103 t (86-755) 88663988 f (86-755) 26710594 sgs.china@sgs.com

Test Mode: 11; Polarity: Vertical; Modulation:802.11n; Bandwidth:40MHz; Channel:Low

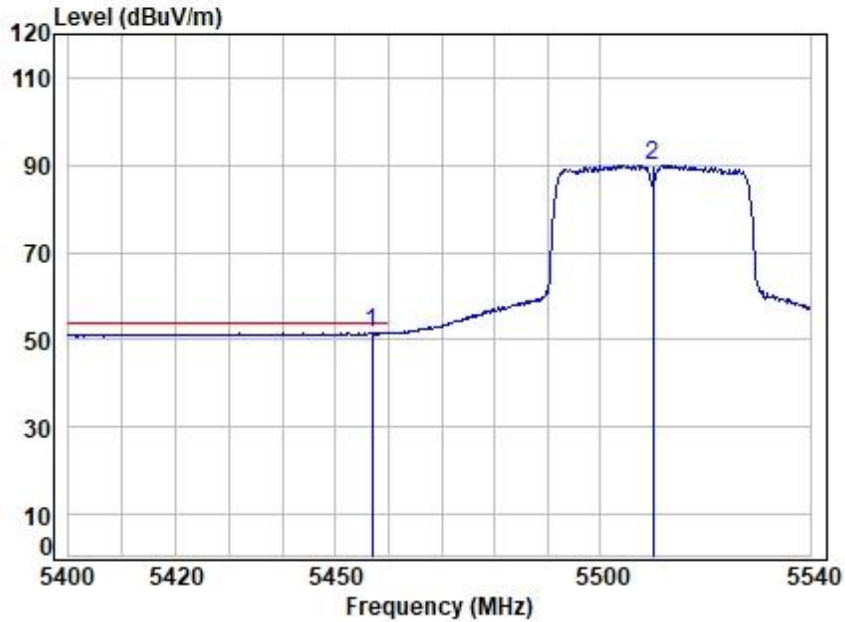

Site : chamber
 Condition: 3m VERTICAL
 Job No : 00466AT
 Mode : 5510 Band edge
 : 5G WIFI 11N40

	Freq	Cable Loss	Ant Factor	Preamp Factor	Read Level	Level	Limit	Over	Remark
	MHz	dB	dB/m	dB	dBuV	dBuV/m	dBuV/m	dB	
1	5456.827	8.27	32.50	32.24	43.23	51.76	54.00	-2.24	Average
2	5510.000	8.26	32.60	32.30	81.54	90.10	-----	-----	Average



Unless otherwise agreed in writing, this document is issued by the Company subject to its General Conditions of Service printed overleaf, available on request or accessible at <http://www.sgs.com/en/Terms-and-Conditions.aspx> and, for electronic format documents, subject to Terms and Conditions for Electronic Documents at <http://www.sgs.com/en/Terms-and-Conditions/Terms-e-Documents.aspx>. Attention is drawn to the limitation of liability, indemnification and jurisdiction issues defined therein. Any holder of this document is advised that information contained hereon reflects the Company's findings at the time of its intervention only and within the limits of Client's instructions, if any. The Company's sole responsibility is to its Client and this document does not exonerate parties to a transaction from exercising all their rights and obligations under the transaction documents. This document cannot be reproduced except in full, without prior written approval of the Company. Any unauthorized alteration, forgery or falsification of the content or appearance of this document is unlawful and offenders may be prosecuted to the fullest extent of the law. Unless otherwise stated the results shown in this test report refer only to the sample(s) tested and such sample(s) are retained for 30 days only.
Attention: To check the authenticity of testing /inspection report & certificate, please contact us at telephone: (86-755) 8307 1443, or email: CN.Doccheck@sgs.com

Fuyong lab, Xinlong TechnoPark, Fengtang Road, Fuyong Subdistrict, Bao'an, Shenzhen, China 518103 t (86-755) 88663988 f (86-755) 26710594 www.sgs.com.cn
 中国·深圳·宝安区福永街道凤塘大道鑫龙科技园福永实验室 邮编: 518103 t (86-755) 88663988 f (86-755) 26710594 sgs.china@sgs.com

Test Mode: 11; Polarity: Horizontal; Modulation:802.11n; Bandwidth:40MHz; Channel:High

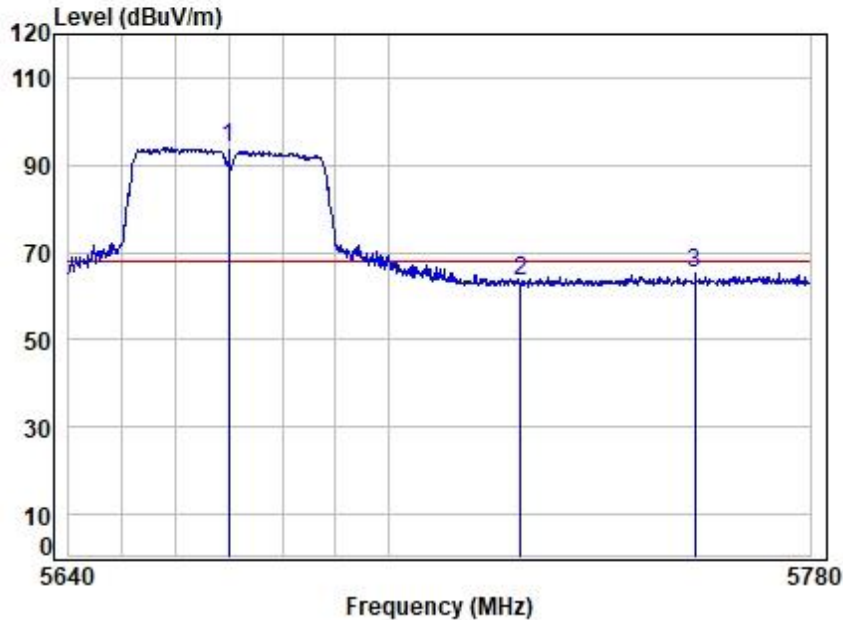

Site : chamber
 Condition: 3m HORIZONTAL
 Job No : 00466AT
 Mode : 5670 Band edge
 : 5G WIFI 11N40

	Freq	Cable Loss	Ant Factor	Preamp Factor	Read Level	Level	Limit	Over	Remark
	MHz	dB	dB/m	dB	dBuV	dBuV/m	dBuV/m	dB	
1	5670.000	8.05	32.53	32.23	85.75	94.10	68.20	25.90	peak
2	5725.000	7.98	32.51	32.21	54.96	63.24	68.20	-4.96	peak
3	5758.075	7.94	32.49	32.19	56.99	65.23	68.20	-2.97	peak



Unless otherwise agreed in writing, this document is issued by the Company subject to its General Conditions of Service printed overleaf, available on request or accessible at <http://www.sgs.com/en/Terms-and-Conditions.aspx> and, for electronic format documents, subject to Terms and Conditions for Electronic Documents at <http://www.sgs.com/en/Terms-and-Conditions/Terms-e-Documents.aspx>. Attention is drawn to the limitation of liability, indemnification and jurisdiction issues defined therein. Any holder of this document is advised that information contained hereon reflects the Company's findings at the time of its intervention only and within the limits of Client's instructions, if any. The Company's sole responsibility is to its Client and this document does not exonerate parties to a transaction from exercising all their rights and obligations under the transaction documents. This document cannot be reproduced except in full, without prior written approval of the Company. Any unauthorized alteration, forgery or falsification of the content or appearance of this document is unlawful and offenders may be prosecuted to the fullest extent of the law. Unless otherwise stated the results shown in this test report refer only to the sample(s) tested and such sample(s) are retained for 30 days only.
Attention: To check the authenticity of testing /inspection report & certificate, please contact us at telephone: (86-755) 8307 1443, or email: CN.Doccheck@sgs.com

Fuyong lab, Xinlong TechnoPark, Fengtang Road, Fuyong Subdistrict, Bao'an, Shenzhen, China 518103 t (86-755) 88663988 f (86-755) 26710594 www.sgsgroup.com.cn
 中国·深圳·宝安区福永街道凤塘大道鑫龙科技园福永实验室 邮编: 518103 t (86-755) 88663988 f (86-755) 26710594 sgs.china@sgs.com

Test Mode: 11; Polarity: Vertical; Modulation:802.11n; Bandwidth:40MHz; Channel:High

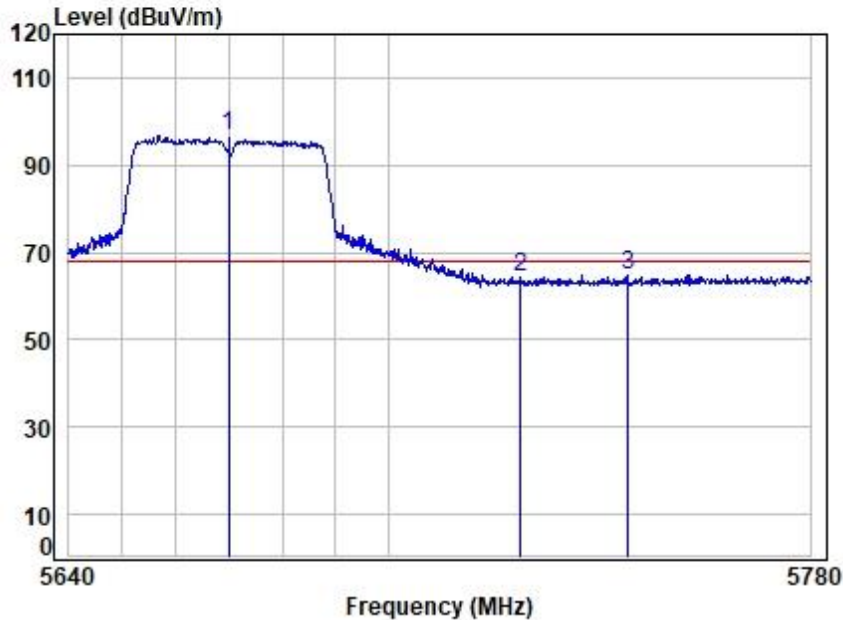

Site : chamber
 Condition: 3m VERTICAL
 Job No : 00466AT
 Mode : 5670 Band edge
 : 5G WIFI 11N40

	Cable	Ant	Preamp	Read	Limit	Over	
Freq	Loss	Factor	Factor	Level	Level	Line	Limit
MHz	dB	dB/m	dB	dBuV	dBuV/m	dBuV/m	dB
1 . 5670.000	8.05	32.53	32.23	88.57	96.92	68.20	28.72 Peak
2 5725.000	7.98	32.51	32.21	55.90	64.18	68.20	-4.02 Peak
3 5745.241	7.95	32.50	32.20	56.71	64.96	68.20	-3.24 Peak



Unless otherwise agreed in writing, this document is issued by the Company subject to its General Conditions of Service printed overleaf, available on request or accessible at <http://www.sgs.com/en/Terms-and-Conditions.aspx> and, for electronic format documents, subject to Terms and Conditions for Electronic Documents at <http://www.sgs.com/en/Terms-and-Conditions/Terms-e-Documents.aspx>. Attention is drawn to the limitation of liability, indemnification and jurisdiction issues defined therein. Any holder of this document is advised that information contained hereon reflects the Company's findings at the time of its intervention only and within the limits of Client's instructions, if any. The Company's sole responsibility is to its Client and this document does not exonerate parties to a transaction from exercising all their rights and obligations under the transaction documents. This document cannot be reproduced except in full, without prior written approval of the Company. Any unauthorized alteration, forgery or falsification of the content or appearance of this document is unlawful and offenders may be prosecuted to the fullest extent of the law. Unless otherwise stated the results shown in this test report refer only to the sample(s) tested and such sample(s) are retained for 30 days only.
Attention: To check the authenticity of testing /inspection report & certificate, please contact us at telephone: (86-755) 8307 1443, or email: CN.Doccheck@sgs.com

Fuyong lab, Xinlong TechnoPark, Fengtang Road, Fuyong Subdistrict, Bao'an, Shenzhen, China 518103 t (86-755) 88663988 f (86-755) 26710594 www.sgsgroup.com.cn
 中国·深圳·宝安区福永街道凤塘大道鑫龙科技园福永实验室 邮编: 518103 t (86-755) 88663988 f (86-755) 26710594 sgs.china@sgs.com

Compliance Certification Services (Kunshan) Inc. Shenzhen Branch

SZCCS-TRF-01 Rev. A/0 Aug01,2022

Report No.: FYCR221100046605

Page: 160 of 344

Test Mode: 11; Polarity: Horizontal; Modulation:802.11ac; Bandwidth:80MHz; Channel:Low

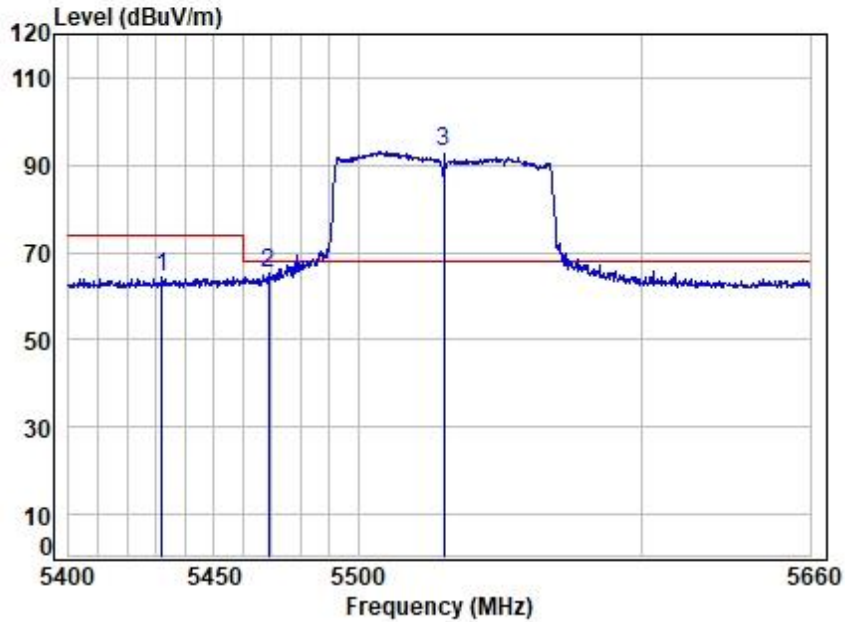

Site : chamber
 Condition: 3m HORIZONTAL
 Job No : 00466AT
 Mode : 5530 Band edge
 : 5G WIFI 11AC80

		Cable	Ant	Preamp	Read	Limit	Over	
	Freq	Loss	Factor	Factor	Level	Line	Limit	Remark
	MHz	dB	dB/m	dB	dBuV	dBuV/m	dBuV/m	dB
1	5432.091	8.27	32.44	32.21	55.84	64.34	74.00	-9.66 peak
2	5468.742	8.27	32.53	32.26	56.63	65.17	68.20	-3.03 peak
3	5530.000	8.23	32.59	32.29	84.62	93.15	68.20	24.95 peak



Unless otherwise agreed in writing, this document is issued by the Company subject to its General Conditions of Service printed overleaf, available on request or accessible at <http://www.sgs.com/en/Terms-and-Conditions.aspx> and, for electronic format documents, subject to Terms and Conditions for Electronic Documents at <http://www.sgs.com/en/Terms-and-Conditions/Terms-e-Documents.aspx>. Attention is drawn to the limitation of liability, indemnification and jurisdiction issues defined therein. Any holder of this document is advised that information contained hereon reflects the Company's findings at the time of its intervention only and within the limits of Client's instructions, if any. The Company's sole responsibility is to its Client and this document does not exonerate parties to a transaction from exercising all their rights and obligations under the transaction documents. This document cannot be reproduced except in full, without prior written approval of the Company. Any unauthorized alteration, forgery or falsification of the content or appearance of this document is unlawful and offenders may be prosecuted to the fullest extent of the law. Unless otherwise stated the results shown in this test report refer only to the sample(s) tested and such sample(s) are retained for 30 days only.
Attention: To check the authenticity of testing /inspection report & certificate, please contact us at telephone: (86-755) 8307 1443, or email: CN.Doccheck@sgs.com

Fuyong lab, Xinlong TechnoPark, Fengtang Road, Fuyong Subdistrict, Bao'an, Shenzhen, China 518103 t (86-755) 88663988 f (86-755) 26710594 www.sgsgroup.com.cn
 中国·深圳·宝安区福永街道凤塘大道鑫龙科技园福永实验室 邮编: 518103 t (86-755) 88663988 f (86-755) 26710594 sgs.china@sgs.com

Test Mode: 11; Polarity: Horizontal; Modulation:802.11ac; Bandwidth:80MHz; Channel:Low

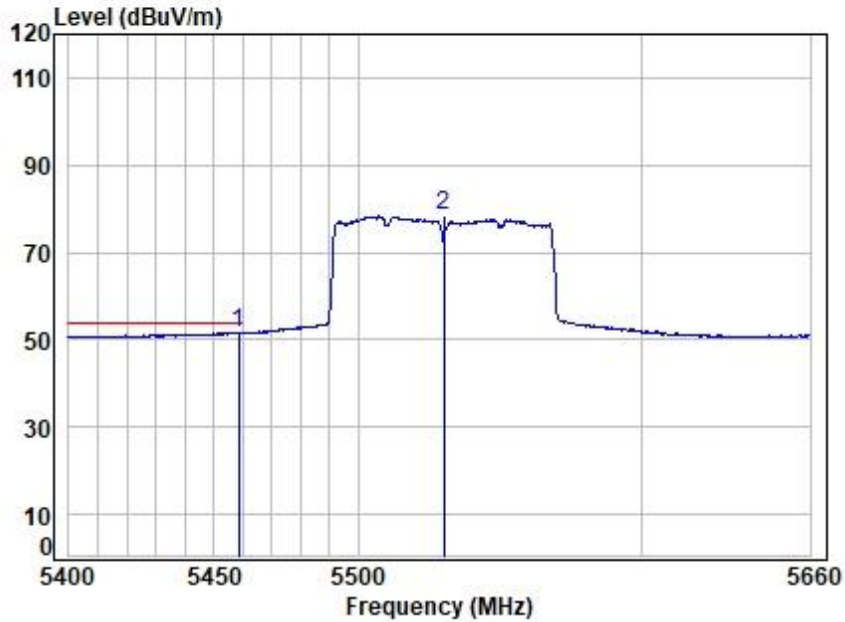

Site : chamber
 Condition: 3m HORIZONTAL
 Job No : 00466AT
 Mode : 5530 Band edge
 : 5G WIFI 11AC80

	Freq	Cable Loss	Ant Factor	Preamp Factor	Read Level	Level	Limit	Over	Remark
	MHz	dB	dB/m	dB	dBuV	dBuV/m	dBuV/m	dB	
1	5458.465	8.27	32.50	32.24	43.23	51.76	54.00	-2.24	Average
2	5530.000	8.23	32.59	32.29	69.77	78.30	-----	-----	Average



Unless otherwise agreed in writing, this document is issued by the Company subject to its General Conditions of Service printed overleaf, available on request or accessible at <http://www.sgs.com/en/Terms-and-Conditions.aspx> and, for electronic format documents, subject to Terms and Conditions for Electronic Documents at <http://www.sgs.com/en/Terms-and-Conditions/Terms-e-Documents.aspx>. Attention is drawn to the limitation of liability, indemnification and jurisdiction issues defined therein. Any holder of this document is advised that information contained hereon reflects the Company's findings at the time of its intervention only and within the limits of Client's instructions, if any. The Company's sole responsibility is to its Client and this document does not exonerate parties to a transaction from exercising all their rights and obligations under the transaction documents. This document cannot be reproduced except in full, without prior written approval of the Company. Any unauthorized alteration, forgery or falsification of the content or appearance of this document is unlawful and offenders may be prosecuted to the fullest extent of the law. Unless otherwise stated the results shown in this test report refer only to the sample(s) tested and such sample(s) are retained for 30 days only.
Attention: To check the authenticity of testing /inspection report & certificate, please contact us at telephone: (86-755) 8307 1443, or email: CN.Doccheck@sgs.com

Fuyong lab, Xinlong TechnoPark, Fengtang Road, Fuyong Subdistrict, Bao'an, Shenzhen, China 518103 t (86-755) 88663988 f (86-755) 26710594 www.sgsgroup.com.cn
 中国·深圳·宝安区福永街道凤塘大道鑫龙科技园福永实验室 邮编: 518103 t (86-755) 88663988 f (86-755) 26710594 sgs.china@sgs.com

Compliance Certification Services (Kunshan) Inc. Shenzhen Branch

SZCCS-TRF-01 Rev. A/0 Aug01,2022

Report No.: FYCR221100046605

Page: 162 of 344

Test Mode: 11; Polarity: Vertical; Modulation:802.11ac; Bandwidth:80MHz; Channel:Low

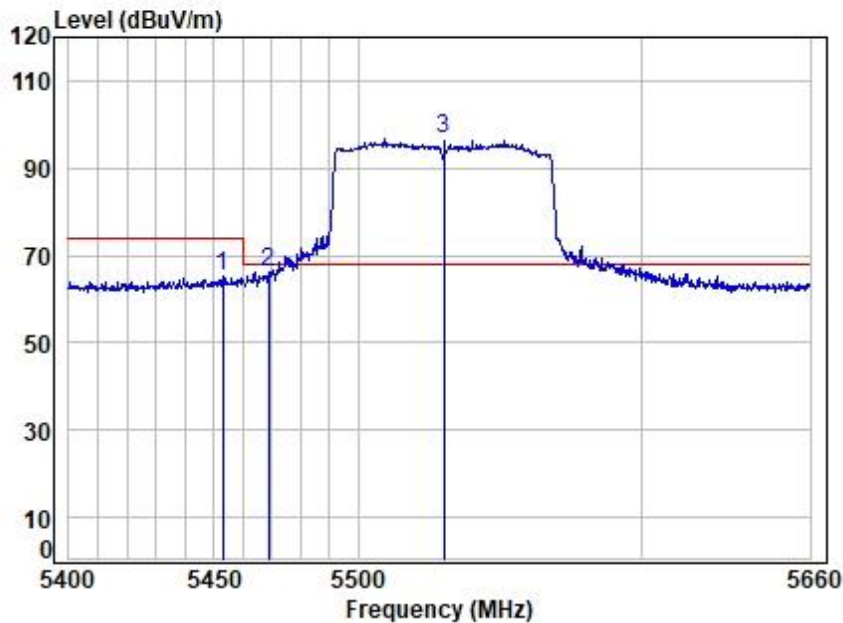

Site : chamber
 Condition: 3m VERTICAL
 Job No : 00466AT
 Mode : 5530 Band edge
 : 5G WIFI 11AC80

	Freq	Cable Loss	Ant Factor	Preamp Factor	Read Level	Level	Limit Line	Over Limit	Remark
	MHz	dB	dB/m	dB	dBuV	dBuV/m	dBuV/m	dB	
1	5453.078	8.27	32.49	32.24	56.89	65.41	74.00	-8.59	Peak
2	5469.000	8.27	32.53	32.26	57.54	66.08	68.20	-2.12	peak
3	5530.000	8.23	32.59	32.29	88.09	96.62	68.20	28.42	Peak



Unless otherwise agreed in writing, this document is issued by the Company subject to its General Conditions of Service printed overleaf, available on request or accessible at <http://www.sgs.com/en/Terms-and-Conditions.aspx> and, for electronic format documents, subject to Terms and Conditions for Electronic Documents at <http://www.sgs.com/en/Terms-and-Conditions/Terms-e-Documents.aspx>. Attention is drawn to the limitation of liability, indemnification and jurisdiction issues defined therein. Any holder of this document is advised that information contained hereon reflects the Company's findings at the time of its intervention only and within the limits of Client's instructions, if any. The Company's sole responsibility is to its Client and this document does not exonerate parties to a transaction from exercising all their rights and obligations under the transaction documents. This document cannot be reproduced except in full, without prior written approval of the Company. Any unauthorized alteration, forgery or falsification of the content or appearance of this document is unlawful and offenders may be prosecuted to the fullest extent of the law. Unless otherwise stated the results shown in this test report refer only to the sample(s) tested and such sample(s) are retained for 30 days only.
Attention: To check the authenticity of testing /inspection report & certificate, please contact us at telephone: (86-755) 8307 1443, or email: CN.Doccheck@sgs.com

Fuyong lab, Xinlong TechnoPark, Fengtang Road, Fuyong Subdistrict, Bao'an, Shenzhen, China 518103 t (86-755) 88663988 f (86-755) 26710594 www.sgsgroup.com.cn
 中国·深圳·宝安区福永街道凤塘大道鑫龙科技园福永实验室 邮编: 518103 t (86-755) 88663988 f (86-755) 26710594 sgs.china@sgs.com

Compliance Certification Services (Kunshan) Inc. Shenzhen Branch

SZCCS-TRF-01 Rev. A/0 Aug01,2022

Report No.: FYCR221100046605

Page: 163 of 344

Test Mode: 11; Polarity: Vertical; Modulation:802.11ac; Bandwidth:80MHz; Channel:Low

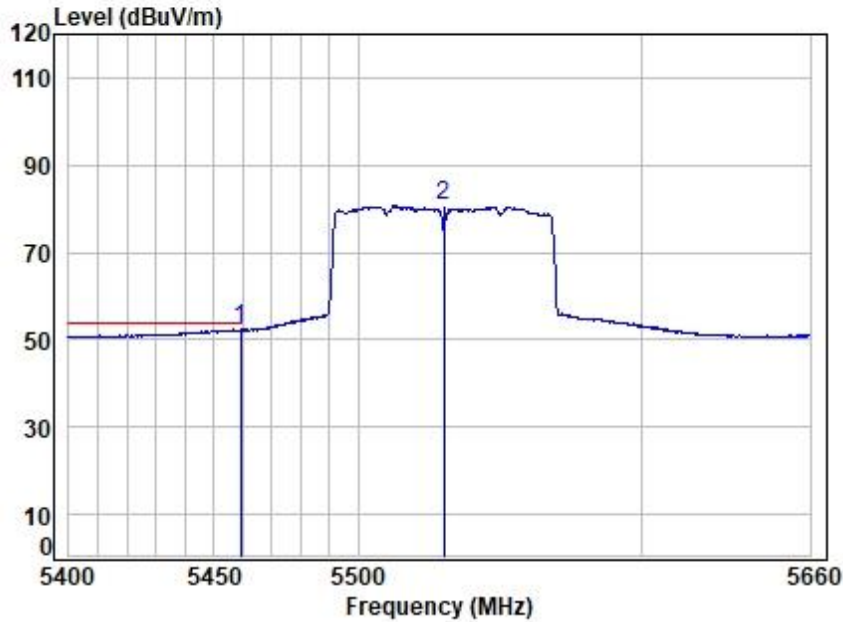

Site : chamber
 Condition: 3m VERTICAL
 Job No : 00466AT
 Mode : 5530 Band edge
 : 5G WIFI 11AC80

	Freq	Cable Loss	Ant Factor	Preamp Factor	Read Level	Level	Limit	Over	Remark
	MHz	dB	dB/m	dB	dBuV	dBuV/m	dBuV/m	dB	
1	5459.235	8.27	32.51	32.25	43.72	52.25	54.00	-1.75	Average
2	5530.000	8.23	32.59	32.29	72.15	80.68	-----	-----	Average



Unless otherwise agreed in writing, this document is issued by the Company subject to its General Conditions of Service printed overleaf, available on request or accessible at <http://www.sgs.com/en/Terms-and-Conditions.aspx> and, for electronic format documents, subject to Terms and Conditions for Electronic Documents at <http://www.sgs.com/en/Terms-and-Conditions/Terms-e-Documents.aspx>. Attention is drawn to the limitation of liability, indemnification and jurisdiction issues defined therein. Any holder of this document is advised that information contained hereon reflects the Company's findings at the time of its intervention only and within the limits of Client's instructions, if any. The Company's sole responsibility is to its Client and this document does not exonerate parties to a transaction from exercising all their rights and obligations under the transaction documents. This document cannot be reproduced except in full, without prior written approval of the Company. Any unauthorized alteration, forgery or falsification of the content or appearance of this document is unlawful and offenders may be prosecuted to the fullest extent of the law. Unless otherwise stated the results shown in this test report refer only to the sample(s) tested and such sample(s) are retained for 30 days only.
Attention: To check the authenticity of testing /inspection report & certificate, please contact us at telephone: (86-755) 8307 1443, or email: CN.Doccheck@sgs.com

Fuyong lab, Xinlong TechnoPark, Fengtang Road, Fuyong Subdistrict, Bao'an, Shenzhen, China 518103 t (86-755) 88663988 f (86-755) 26710594 www.sgs.com.cn
 中国·深圳·宝安区福永街道凤塘大道鑫龙科技园福永实验室 邮编: 518103 t (86-755) 88663988 f (86-755) 26710594 sgs.china@sgs.com

Test Mode: 11; Polarity: Horizontal; Modulation:802.11ac; Bandwidth:80MHz; Channel:High

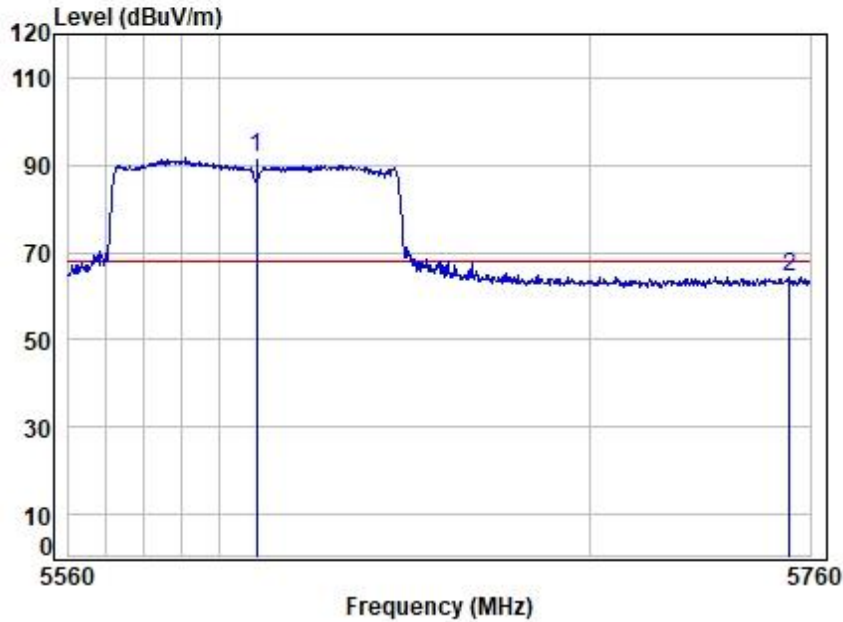

Site : chamber
 Condition: 3m HORIZONTAL
 Job No : 00466AT
 Mode : 5610 Band edge
 : 5G WIFI 11AC80

	Cable	Ant	Preamp	Read	Limit	Over	
Freq	Loss	Factor	Factor	Level	Level	Line	Limit
MHz	dB	dB/m	dB	dBuV	dBuV/m	dBuV/m	dB
1 . 5610.000	8.13	32.55	32.25	83.17	91.60	68.20	23.40 peak
2 5754.303	7.94	32.50	32.20	56.23	64.47	68.20	-3.73 peak



Unless otherwise agreed in writing, this document is issued by the Company subject to its General Conditions of Service printed overleaf, available on request or accessible at <http://www.sgs.com/en/Terms-and-Conditions.aspx> and, for electronic format documents, subject to Terms and Conditions for Electronic Documents at <http://www.sgs.com/en/Terms-and-Conditions/Terms-e-Documents.aspx>. Attention is drawn to the limitation of liability, indemnification and jurisdiction issues defined therein. Any holder of this document is advised that information contained hereon reflects the Company's findings at the time of its intervention only and within the limits of Client's instructions, if any. The Company's sole responsibility is to its Client and this document does not exonerate parties to a transaction from exercising all their rights and obligations under the transaction documents. This document cannot be reproduced except in full, without prior written approval of the Company. Any unauthorized alteration, forgery or falsification of the content or appearance of this document is unlawful and offenders may be prosecuted to the fullest extent of the law. Unless otherwise stated the results shown in this test report refer only to the sample(s) tested and such sample(s) are retained for 30 days only.
Attention: To check the authenticity of testing /inspection report & certificate, please contact us at telephone: (86-755) 8307 1443, or email: CN.Doccheck@sgs.com

Fuyong lab, Xinlong TechnoPark, Fengtang Road, Fuyong Subdistrict, Bao'an, Shenzhen, China 518103 t (86-755) 88663988 f (86-755) 26710594 www.sgsgroup.com.cn
 中国·深圳·宝安区福永街道凤塘大道鑫龙科技园福永实验室 邮编: 518103 t (86-755) 88663988 f (86-755) 26710594 sgs.china@sgs.com

Test Mode: 11; Polarity: Vertical; Modulation:802.11ac; Bandwidth:80MHz; Channel:High

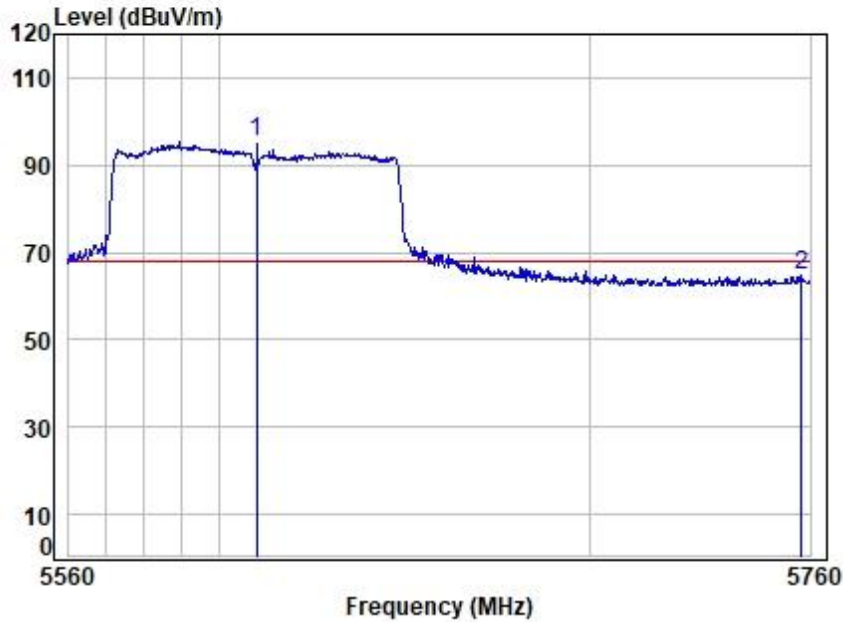

Site : chamber
 Condition: 3m VERTICAL
 Job No : 00466AT
 Mode : 5610 Band edge
 : 5G WIFI 11AC80

		Cable	Ant	Preamp	Read	Limit	Over	
	Freq	Loss	Factor	Factor	Level	Line	Limit	Remark
	MHz	dB	dB/m	dB	dBuV	dBuV/m	dBuV/m	dB
1	5610.000	8.13	32.55	32.25	86.71	95.14	68.20	26.94 Peak
2	5757.558	7.94	32.49	32.19	56.38	64.62	68.20	-3.58 Peak



Unless otherwise agreed in writing, this document is issued by the Company subject to its General Conditions of Service printed overleaf, available on request or accessible at <http://www.sgs.com/en/Terms-and-Conditions.aspx> and, for electronic format documents, subject to Terms and Conditions for Electronic Documents at <http://www.sgs.com/en/Terms-and-Conditions/Terms-e-Documents.aspx>. Attention is drawn to the limitation of liability, indemnification and jurisdiction issues defined therein. Any holder of this document is advised that information contained hereon reflects the Company's findings at the time of its intervention only and within the limits of Client's instructions, if any. The Company's sole responsibility is to its Client and this document does not exonerate parties to a transaction from exercising all their rights and obligations under the transaction documents. This document cannot be reproduced except in full, without prior written approval of the Company. Any unauthorized alteration, forgery or falsification of the content or appearance of this document is unlawful and offenders may be prosecuted to the fullest extent of the law. Unless otherwise stated the results shown in this test report refer only to the sample(s) tested and such sample(s) are retained for 30 days only.
Attention: To check the authenticity of testing /inspection report & certificate, please contact us at telephone: (86-755) 8307 1443, or email: CN.Doccheck@sgs.com

Fuyong lab, Xinlong TechnoPark, Fengtang Road, Fuyong Subdistrict, Bao'an, Shenzhen, China 518103 t (86-755) 88663988 f (86-755) 26710594 www.sgsgroup.com.cn
 中国·深圳·宝安区福永街道凤塘大道鑫龙科技园福永实验室 邮编: 518103 t (86-755) 88663988 f (86-755) 26710594 sgs.china@sgs.com

Compliance Certification Services (Kunshan) Inc. Shenzhen Branch

SZCCS-TRF-01 Rev. A/0 Aug01,2022

Report No.: FYCR221100046605

Page: 166 of 344

Test Mode: 12; Polarity: Horizontal; Modulation:802.11a; Bandwidth:20MHz; Channel:Low

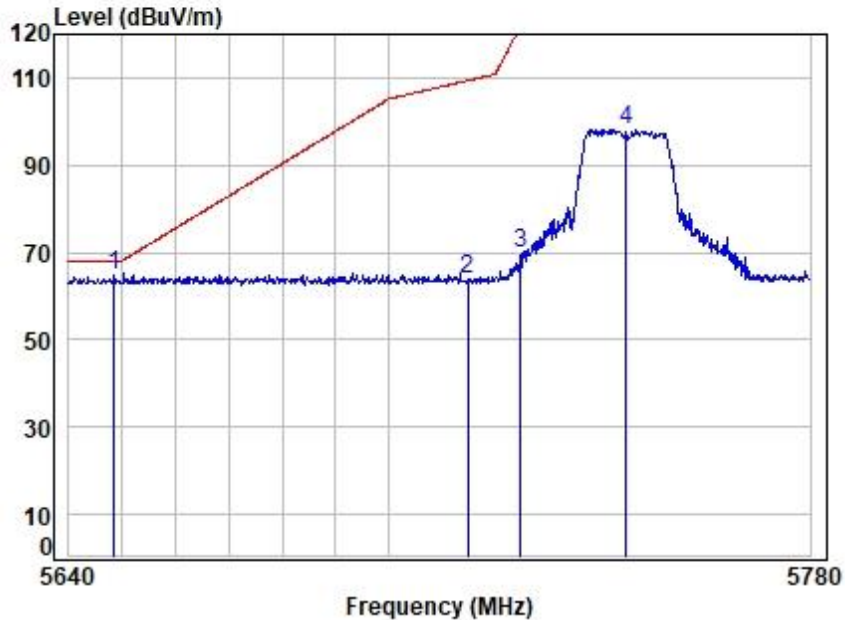

Site : chamber
 Condition: 3m HORIZONTAL
 Job No : 00466AT
 Mode : 5745 Band edge
 : 5G WIFI 11A

	Freq	Cable Loss	Ant Factor	Preamp Factor	Read Level	Level	Limit	Over	Remark
	MHz	dB	dB/m	dB	dBuV	dBuV/m	dBuV/m	dB	
1	5648.442	8.08	32.54	32.24	56.26	64.64	68.20	-3.56	peak
2	5715.000	7.99	32.51	32.21	55.42	63.71	109.40	-45.69	peak
3	5725.000	7.98	32.51	32.21	61.58	69.86	122.20	-52.34	peak
4	5745.000	7.95	32.50	32.20	89.84	98.09	-----	-----	peak



Unless otherwise agreed in writing, this document is issued by the Company subject to its General Conditions of Service printed overleaf, available on request or accessible at <http://www.sgs.com/en/Terms-and-Conditions.aspx> and, for electronic format documents, subject to Terms and Conditions for Electronic Documents at <http://www.sgs.com/en/Terms-and-Conditions/Terms-e-Documents.aspx>. Attention is drawn to the limitation of liability, indemnification and jurisdiction issues defined therein. Any holder of this document is advised that information contained hereon reflects the Company's findings at the time of its intervention only and within the limits of Client's instructions, if any. The Company's sole responsibility is to its Client and this document does not exonerate parties to a transaction from exercising all their rights and obligations under the transaction documents. This document cannot be reproduced except in full, without prior written approval of the Company. Any unauthorized alteration, forgery or falsification of the content or appearance of this document is unlawful and offenders may be prosecuted to the fullest extent of the law. Unless otherwise stated the results shown in this test report refer only to the sample(s) tested and such sample(s) are retained for 30 days only.
Attention: To check the authenticity of testing /inspection report & certificate, please contact us at telephone: (86-755) 8307 1443, or email: CN.Doccheck@sgs.com

Fuyong lab, Xinlong TechnoPark, Fengtang Road, Fuyong Subdistrict, Bao'an, Shenzhen, China 518103 t (86-755) 88663988 f (86-755) 26710594 www.sgs.com.cn
 中国·深圳·宝安区福永街道凤塘大道鑫龙科技园福永实验室 邮编: 518103 t (86-755) 88663988 f (86-755) 26710594 sgs.china@sgs.com

Compliance Certification Services (Kunshan) Inc. Shenzhen Branch

SZCCS-TRF-01 Rev. A/0 Aug01,2022

Report No.: FYCR221100046605

Page: 167 of 344

Test Mode: 12; Polarity: Vertical; Modulation:802.11a; Bandwidth:20MHz; Channel:Low

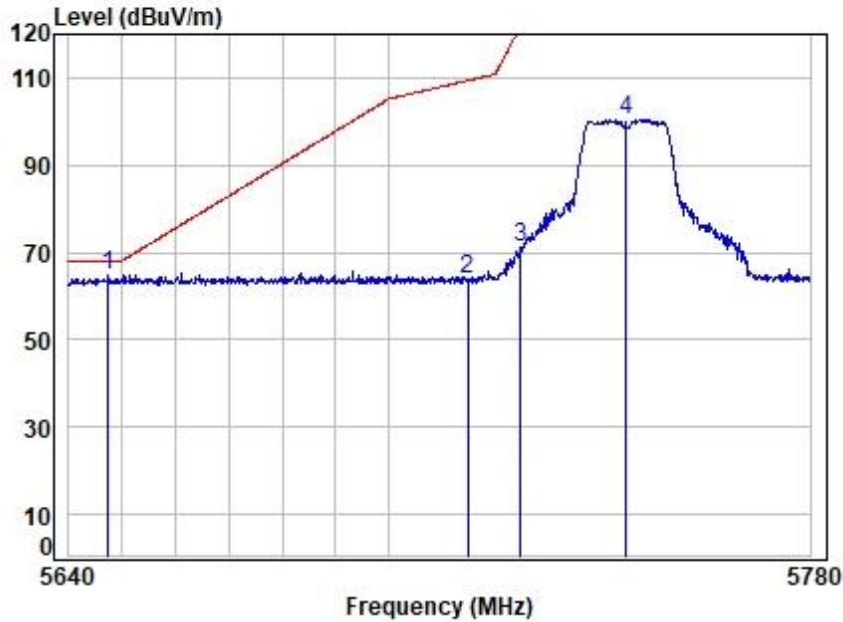

Site : chamber
 Condition: 3m VERTICAL
 Job No : 00466AT
 Mode : 5745 Band edge
 : 5G WIFI 11A

	Freq	Cable Loss	Ant Factor	Preamp Factor	Read Level	Level	Limit	Over	Remark
	MHz	dB	dB/m	dB	dBuV	dBuV/m	dBuV/m	dB	
1	5647.334	8.08	32.54	32.24	56.29	64.67	68.20	-3.53	peak
2	5715.000	7.99	32.51	32.21	55.46	63.75	109.40	-45.65	peak
3	5725.000	7.98	32.51	32.21	63.04	71.32	122.20	-50.88	peak
4	5745.000	7.95	32.50	32.20	92.32	100.57	-----	-----	peak



Unless otherwise agreed in writing, this document is issued by the Company subject to its General Conditions of Service printed overleaf, available on request or accessible at <http://www.sgs.com/en/Terms-and-Conditions.aspx> and, for electronic format documents, subject to Terms and Conditions for Electronic Documents at <http://www.sgs.com/en/Terms-and-Conditions/Terms-e-Documents.aspx>. Attention is drawn to the limitation of liability, indemnification and jurisdiction issues defined therein. Any holder of this document is advised that information contained hereon reflects the Company's findings at the time of its intervention only and within the limits of Client's instructions, if any. The Company's sole responsibility is to its Client and this document does not exonerate parties to a transaction from exercising all their rights and obligations under the transaction documents. This document cannot be reproduced except in full, without prior written approval of the Company. Any unauthorized alteration, forgery or falsification of the content or appearance of this document is unlawful and offenders may be prosecuted to the fullest extent of the law. Unless otherwise stated the results shown in this test report refer only to the sample(s) tested and such sample(s) are retained for 30 days only.
Attention: To check the authenticity of testing /inspection report & certificate, please contact us at telephone: (86-755) 8307 1443, or email: CN.Doccheck@sgs.com

Fuyong lab, Xinlong TechnoPark, Fengtang Road, Fuyong Subdistrict, Bao'an, Shenzhen, China 518103 t (86-755) 88663988 f (86-755) 26710594 www.sgsgroup.com.cn
 中国·深圳·宝安区福永街道凤塘大道鑫龙科技园福永实验室 邮编: 518103 t (86-755) 88663988 f (86-755) 26710594 sgs.china@sgs.com

Compliance Certification Services (Kunshan) Inc. Shenzhen Branch

SZCCS-TRF-01 Rev. A/0 Aug01,2022

Report No.: FYCR221100046605

Page: 168 of 344

Test Mode: 12; Polarity: Horizontal; Modulation:802.11a; Bandwidth:20MHz; Channel:High

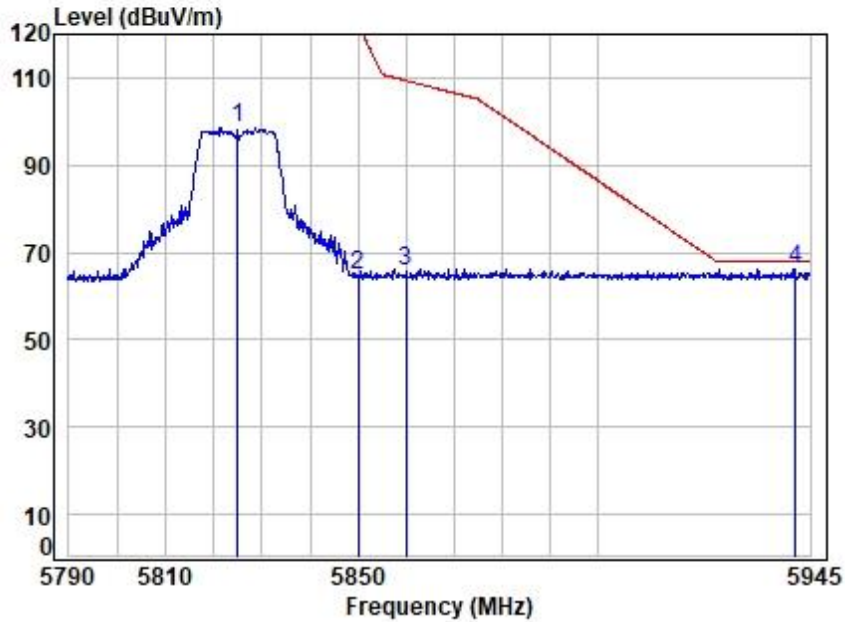

Site : chamber
 Condition: 3m HORIZONTAL
 Job No : 00466AT
 Mode : 5825 Band edge
 : 5G WIFI 11A

	Freq	Cable Loss	Ant Factor	Preamp Factor	Read Level	Level	Limit	Over	Remark
	MHz	dB	dB/m	dB	dBuV	dBuV/m	dBuV/m	dB	
1	5825.000	7.85	32.47	32.17	90.40	98.55	-----	-----	peak
2	5850.000	7.82	32.46	32.16	56.58	64.70	122.20	-57.50	peak
3	5860.000	7.81	32.45	32.15	57.44	65.55	109.40	-43.85	peak
4	5941.860	7.71	32.42	32.12	58.16	66.17	68.20	-2.03	peak



Unless otherwise agreed in writing, this document is issued by the Company subject to its General Conditions of Service printed overleaf, available on request or accessible at <http://www.sgs.com/en/Terms-and-Conditions.aspx> and, for electronic format documents, subject to Terms and Conditions for Electronic Documents at <http://www.sgs.com/en/Terms-and-Conditions/Terms-e-Documents.aspx>. Attention is drawn to the limitation of liability, indemnification and jurisdiction issues defined therein. Any holder of this document is advised that information contained hereon reflects the Company's findings at the time of its intervention only and within the limits of Client's instructions, if any. The Company's sole responsibility is to its Client and this document does not exonerate parties to a transaction from exercising all their rights and obligations under the transaction documents. This document cannot be reproduced except in full, without prior written approval of the Company. Any unauthorized alteration, forgery or falsification of the content or appearance of this document is unlawful and offenders may be prosecuted to the fullest extent of the law. Unless otherwise stated the results shown in this test report refer only to the sample(s) tested and such sample(s) are retained for 30 days only.
Attention: To check the authenticity of testing /inspection report & certificate, please contact us at telephone: (86-755) 8307 1443, or email: CN.Doccheck@sgs.com

Fuyong lab, Xinlong TechnoPark, Fengtang Road, Fuyong Subdistrict, Bao'an, Shenzhen, China 518103 t (86-755) 88663988 f (86-755) 26710594 www.sgsgroup.com.cn
 中国·深圳·宝安区福永街道凤塘大道鑫龙科技园福永实验室 邮编: 518103 t (86-755) 88663988 f (86-755) 26710594 sgs.china@sgs.com

Compliance Certification Services (Kunshan) Inc. Shenzhen Branch

SZCCS-TRF-01 Rev. A/0 Aug01,2022

Report No.: FYCR221100046605

Page: 169 of 344

Test Mode: 12; Polarity: Vertical; Modulation:802.11a; Bandwidth:20MHz; Channel:High

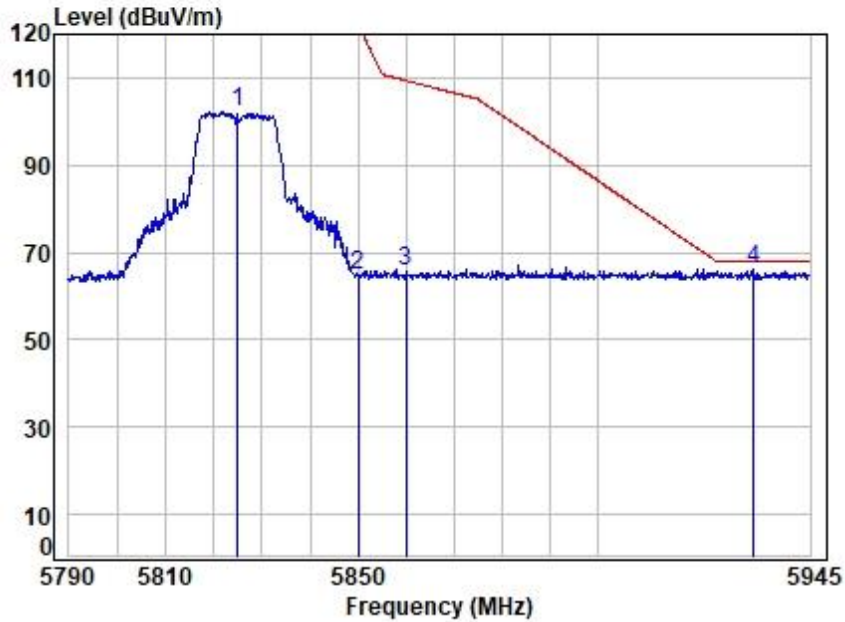

Site : chamber
 Condition: 3m VERTICAL
 Job No : 00466AT
 Mode : 5825 Band edge
 : 5G WIFI 11A

	Freq	Cable Loss	Ant Factor	Preamp Factor	Read Level	Limit Level	Over Limit	Remark
	MHz	dB	dB/m	dB	dBuV	dBuV/m	dBuV/m	dB
1	5825.000	7.85	32.47	32.17	94.00	102.15	-----	peak
2	5850.000	7.82	32.46	32.16	56.67	64.79	122.20	-57.41 peak
3	5860.000	7.81	32.45	32.15	57.43	65.54	109.40	-43.86 peak
4	5933.076	7.72	32.43	32.13	57.95	65.97	68.20	-2.23 peak



Unless otherwise agreed in writing, this document is issued by the Company subject to its General Conditions of Service printed overleaf, available on request or accessible at <http://www.sgs.com/en/Terms-and-Conditions.aspx> and, for electronic format documents, subject to Terms and Conditions for Electronic Documents at <http://www.sgs.com/en/Terms-and-Conditions/Terms-e-Documents.aspx>. Attention is drawn to the limitation of liability, indemnification and jurisdiction issues defined therein. Any holder of this document is advised that information contained hereon reflects the Company's findings at the time of its intervention only and within the limits of Client's instructions, if any. The Company's sole responsibility is to its Client and this document does not exonerate parties to a transaction from exercising all their rights and obligations under the transaction documents. This document cannot be reproduced except in full, without prior written approval of the Company. Any unauthorized alteration, forgery or falsification of the content or appearance of this document is unlawful and offenders may be prosecuted to the fullest extent of the law. Unless otherwise stated the results shown in this test report refer only to the sample(s) tested and such sample(s) are retained for 30 days only.
Attention: To check the authenticity of testing /inspection report & certificate, please contact us at telephone: (86-755) 8307 1443, or email: CN.Doccheck@sgs.com

Fuyong lab, Xinlong TechnoPark, Fengtang Road, Fuyong Subdistrict, Bao'an, Shenzhen, China 518103 t (86-755) 88663988 f (86-755) 26710594 www.sgsgroup.com.cn
 中国·深圳·宝安区福永街道凤塘大道鑫龙科技园福永实验室 邮编: 518103 t (86-755) 88663988 f (86-755) 26710594 sgs.china@sgs.com

Compliance Certification Services (Kunshan) Inc. Shenzhen Branch

SZCCS-TRF-01 Rev. A/0 Aug01,2022

Report No.: FYCR221100046605

Page: 170 of 344

Test Mode: 12; Polarity: Horizontal; Modulation:802.11n; Bandwidth:20MHz; Channel:Low

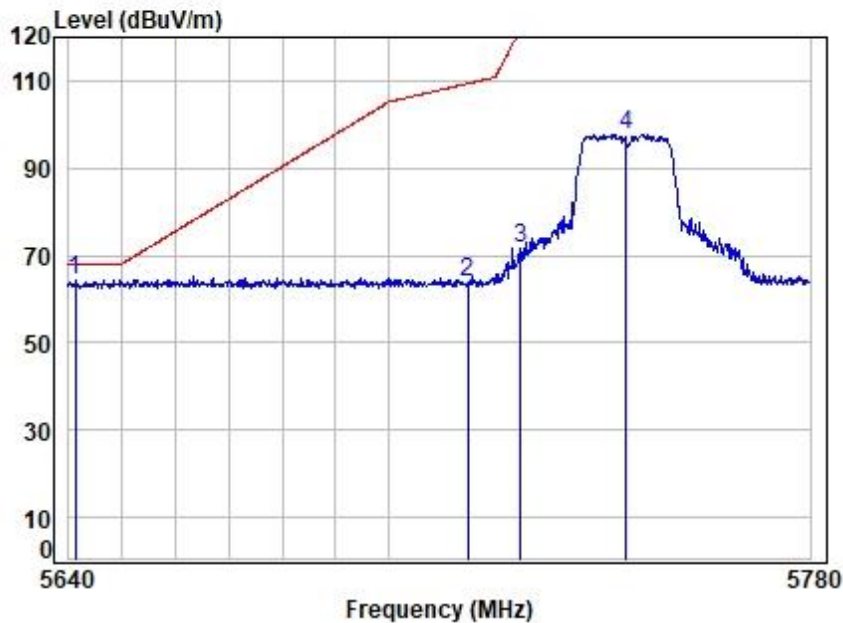

Site : chamber
 Condition: 3m HORIZONTAL
 Job No : 00466AT
 Mode : 5745 Band edge
 : 5G WIFI 11N20

	Freq	Cable Loss	Ant Factor	Preamp Factor	Read Level	Level	Limit	Over	Remark
	MHz	dB	dB/m	dB	dBuV	dBuV/m	dBuV/m	dB	
1	5641.245	8.09	32.54	32.24	56.14	64.53	68.20	-3.67	peak
2	5715.000	7.99	32.51	32.21	55.53	63.82	109.40	-45.58	peak
3	5725.000	7.98	32.51	32.21	63.23	71.51	122.20	-50.69	peak
4	5745.000	7.95	32.50	32.20	89.57	97.82	-----	-----	peak



Unless otherwise agreed in writing, this document is issued by the Company subject to its General Conditions of Service printed overleaf, available on request or accessible at <http://www.sgs.com/en/Terms-and-Conditions.aspx> and, for electronic format documents, subject to Terms and Conditions for Electronic Documents at <http://www.sgs.com/en/Terms-and-Conditions/Terms-e-Documents.aspx>. Attention is drawn to the limitation of liability, indemnification and jurisdiction issues defined therein. Any holder of this document is advised that information contained hereon reflects the Company's findings at the time of its intervention only and within the limits of Client's instructions, if any. The Company's sole responsibility is to its Client and this document does not exonerate parties to a transaction from exercising all their rights and obligations under the transaction documents. This document cannot be reproduced except in full, without prior written approval of the Company. Any unauthorized alteration, forgery or falsification of the content or appearance of this document is unlawful and offenders may be prosecuted to the fullest extent of the law. Unless otherwise stated the results shown in this test report refer only to the sample(s) tested and such sample(s) are retained for 30 days only.
Attention: To check the authenticity of testing /inspection report & certificate, please contact us at telephone: (86-755) 8307 1443, or email: CN.Doccheck@sgs.com

Fuyong lab, Xinlong TechnoPark, Fengtang Road, Fuyong Subdistrict, Bao'an, Shenzhen, China 518103 t (86-755) 88663988 f (86-755) 26710594 www.sgsgroup.com.cn
 中国·深圳·宝安区福永街道凤塘大道鑫龙科技园福永实验室 邮编: 518103 t (86-755) 88663988 f (86-755) 26710594 sgs.china@sgs.com

Compliance Certification Services (Kunshan) Inc. Shenzhen Branch

SZCCS-TRF-01 Rev. A/0 Aug01,2022

Report No.: FYCR221100046605

Page: 171 of 344

Test Mode: 12; Polarity: Vertical; Modulation:802.11n; Bandwidth:20MHz; Channel:Low

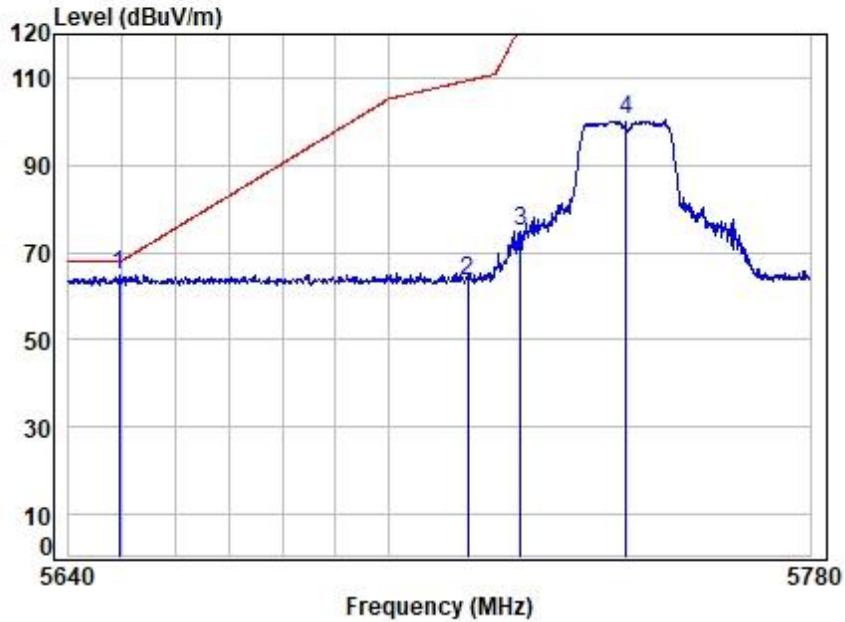

Site : chamber
 Condition: 3m VERTICAL
 Job No : 00466AT
 Mode : 5745 Band edge
 : 5G WIFI 11N20

	Freq	Cable Loss	Ant Factor	Preamp Factor	Read Level	Limit	Over	Remark
	MHz	dB	dB/m	dB	dBuV	dBuV/m	dB	
1	5649.412	8.08	32.54	32.24	56.51	68.20	-3.31	peak
2	5715.000	7.99	32.51	32.21	55.20	109.40	-45.91	peak
3	5725.000	7.98	32.51	32.21	66.37	122.20	-47.55	peak
4	5745.000	7.95	32.50	32.20	92.00	-----	-----	peak



Unless otherwise agreed in writing, this document is issued by the Company subject to its General Conditions of Service printed overleaf, available on request or accessible at <http://www.sgs.com/en/Terms-and-Conditions.aspx> and, for electronic format documents, subject to Terms and Conditions for Electronic Documents at <http://www.sgs.com/en/Terms-and-Conditions/Terms-e-Documents.aspx>. Attention is drawn to the limitation of liability, indemnification and jurisdiction issues defined therein. Any holder of this document is advised that information contained hereon reflects the Company's findings at the time of its intervention only and within the limits of Client's instructions, if any. The Company's sole responsibility is to its Client and this document does not exonerate parties to a transaction from exercising all their rights and obligations under the transaction documents. This document cannot be reproduced except in full, without prior written approval of the Company. Any unauthorized alteration, forgery or falsification of the content or appearance of this document is unlawful and offenders may be prosecuted to the fullest extent of the law. Unless otherwise stated the results shown in this test report refer only to the sample(s) tested and such sample(s) are retained for 30 days only.
Attention: To check the authenticity of testing /inspection report & certificate, please contact us at telephone: (86-755) 8307 1443, or email: CN.Doccheck@sgs.com

Fuyong lab, Xinlong TechnoPark, Fengtang Road, Fuyong Subdistrict, Bao'an, Shenzhen, China 518103 t (86-755) 88663988 f (86-755) 26710594 www.sgs.com.cn
 中国·深圳·宝安区福永街道凤塘大道鑫龙科技园福永实验室 邮编: 518103 t (86-755) 88663988 f (86-755) 26710594 sgs.china@sgs.com

Compliance Certification Services (Kunshan) Inc. Shenzhen Branch

SZCCS-TRF-01 Rev. A/0 Aug01,2022

Report No.: FYCR221100046605

Page: 172 of 344

Test Mode: 12; Polarity: Horizontal; Modulation:802.11n; Bandwidth:20MHz; Channel:High

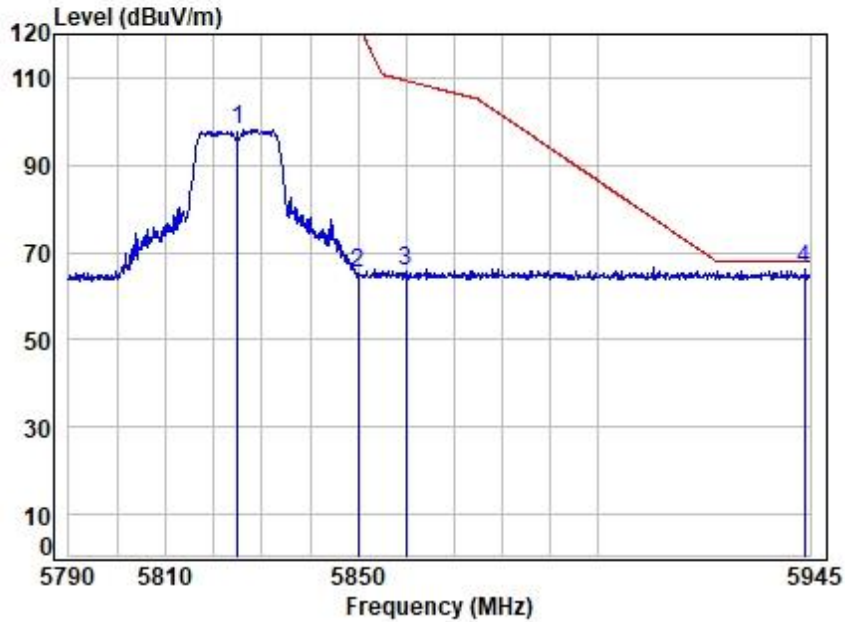

Site : chamber
 Condition: 3m HORIZONTAL
 Job No : 00466AT
 Mode : 5825 Band edge
 : 5G WIFI 11N20

	Freq	Cable Loss	Ant Factor	Preamp Factor	Read Level	Level	Limit	Over	Remark
	MHz	dB	dB/m	dB	dBuV	dBuV/m	dBuV/m	dB	
1	5825.000	7.85	32.47	32.17	90.11	98.26	-----	-----	peak
2	5850.000	7.82	32.46	32.16	57.21	65.33	122.20	-56.87	peak
3	5860.000	7.81	32.45	32.15	57.45	65.56	109.40	-43.84	peak
4	5943.901	7.71	32.42	32.12	57.97	65.98	68.20	-2.22	peak



Unless otherwise agreed in writing, this document is issued by the Company subject to its General Conditions of Service printed overleaf, available on request or accessible at <http://www.sgs.com/en/Terms-and-Conditions.aspx> and, for electronic format documents, subject to Terms and Conditions for Electronic Documents at <http://www.sgs.com/en/Terms-and-Conditions/Terms-e-Documents.aspx>. Attention is drawn to the limitation of liability, indemnification and jurisdiction issues defined therein. Any holder of this document is advised that information contained hereon reflects the Company's findings at the time of its intervention only and within the limits of Client's instructions, if any. The Company's sole responsibility is to its Client and this document does not exonerate parties to a transaction from exercising all their rights and obligations under the transaction documents. This document cannot be reproduced except in full, without prior written approval of the Company. Any unauthorized alteration, forgery or falsification of the content or appearance of this document is unlawful and offenders may be prosecuted to the fullest extent of the law. Unless otherwise stated the results shown in this test report refer only to the sample(s) tested and such sample(s) are retained for 30 days only.
Attention: To check the authenticity of testing /inspection report & certificate, please contact us at telephone: (86-755) 8307 1443, or email: CN.Doccheck@sgs.com

Fuyong lab, Xinlong TechnoPark, Fengtang Road, Fuyong Subdistrict, Bao'an, Shenzhen, China 518103 t (86-755) 88663988 f (86-755) 26710594 www.sgsgroup.com.cn
 中国·深圳·宝安区福永街道凤塘大道鑫龙科技园福永实验室 邮编: 518103 t (86-755) 88663988 f (86-755) 26710594 sgs.china@sgs.com

Compliance Certification Services (Kunshan) Inc. Shenzhen Branch

SZCCS-TRF-01 Rev. A/0 Aug01,2022

Report No.: FYCR221100046605

Page: 173 of 344

Test Mode: 12; Polarity: Vertical; Modulation:802.11n; Bandwidth:20MHz; Channel:High

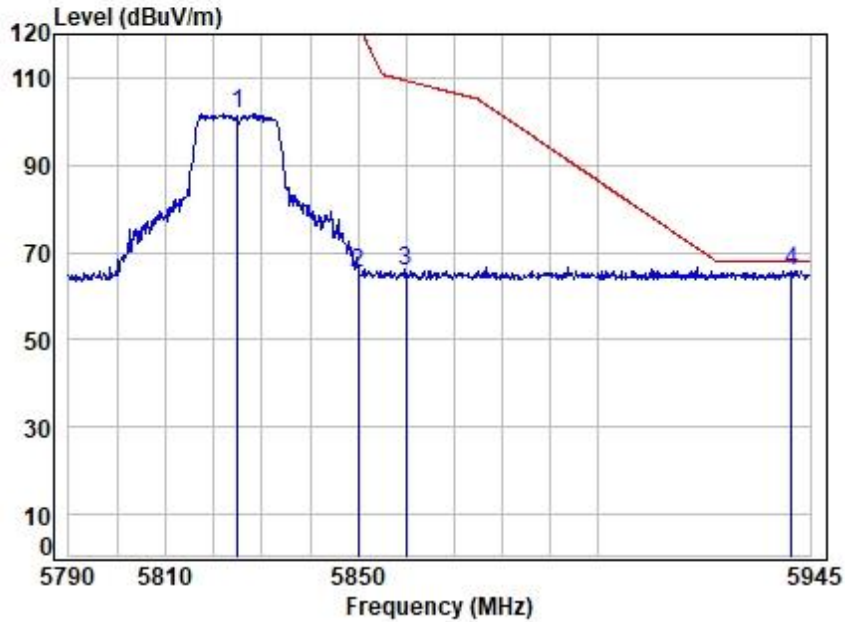

Site : chamber
 Condition: 3m VERTICAL
 Job No : 00466AT
 Mode : 5825 Band edge
 : 5G WIFI 11N20

		Cable	Ant	Preamp	Read	Limit	Over	
	Freq	Loss	Factor	Factor	Level	Line	Limit	Remark
	MHz	dB	dB/m	dB	dBuV	dBuV/m	dBuV/m	dB
1	5825.000	7.85	32.47	32.17	93.49	101.64	-----	----- peak
2	5850.000	7.82	32.46	32.16	57.35	65.47	122.20	-56.73 peak
3	5860.000	7.81	32.45	32.15	57.55	65.66	109.40	-43.74 peak
4	5941.075	7.71	32.42	32.12	57.89	65.90	68.20	-2.30 peak



Unless otherwise agreed in writing, this document is issued by the Company subject to its General Conditions of Service printed overleaf, available on request or accessible at <http://www.sgs.com/en/Terms-and-Conditions.aspx> and, for electronic format documents, subject to Terms and Conditions for Electronic Documents at <http://www.sgs.com/en/Terms-and-Conditions/Terms-e-Documents.aspx>. Attention is drawn to the limitation of liability, indemnification and jurisdiction issues defined therein. Any holder of this document is advised that information contained hereon reflects the Company's findings at the time of its intervention only and within the limits of Client's instructions, if any. The Company's sole responsibility is to its Client and this document does not exonerate parties to a transaction from exercising all their rights and obligations under the transaction documents. This document cannot be reproduced except in full, without prior written approval of the Company. Any unauthorized alteration, forgery or falsification of the content or appearance of this document is unlawful and offenders may be prosecuted to the fullest extent of the law. Unless otherwise stated the results shown in this test report refer only to the sample(s) tested and such sample(s) are retained for 30 days only.
Attention: To check the authenticity of testing /inspection report & certificate, please contact us at telephone: (86-755) 8307 1443, or email: CN.Doccheck@sgs.com

Fuyong lab, Xinlong TechnoPark, Fengtang Road, Fuyong Subdistrict, Bao'an, Shenzhen, China 518103 t (86-755) 88663988 f (86-755) 26710594 www.sgsgroup.com.cn
 中国·深圳·宝安区福永街道凤塘大道鑫龙科技园福永实验室 邮编: 518103 t (86-755) 88663988 f (86-755) 26710594 sgs.china@sgs.com

Compliance Certification Services (Kunshan) Inc. Shenzhen Branch

SZCCS-TRF-01 Rev. A/0 Aug01,2022

Report No.: FYCR221100046605

Page: 174 of 344

Test Mode: 12; Polarity: Horizontal; Modulation:802.11n; Bandwidth:40MHz; Channel:Low

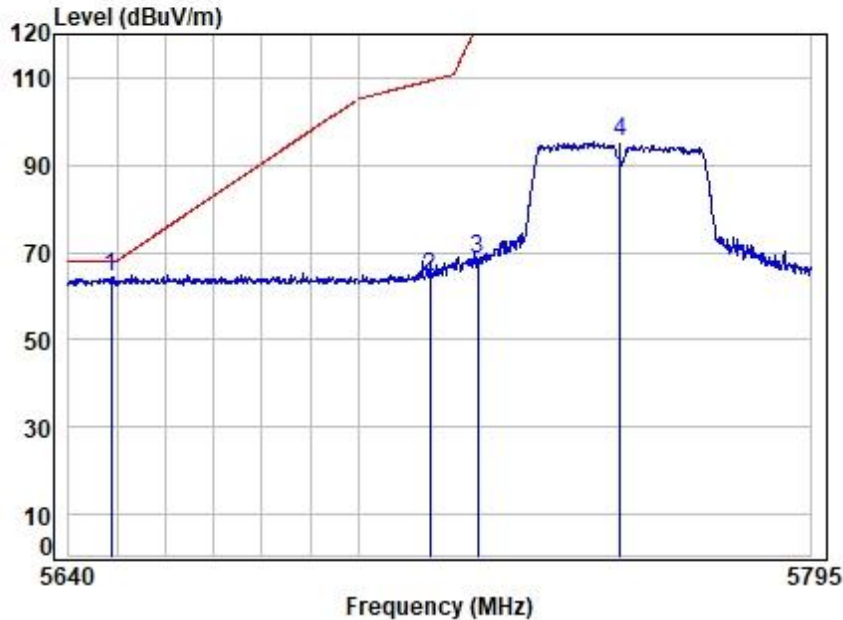

Site : chamber
 Condition: 3m HORIZONTAL
 Job No : 00466AT
 Mode : 5755 Band edge
 : 5G WIFI 11N40

	Freq	Cable Loss	Ant Factor	Preamp Factor	Read Level	Level	Limit	Over	Remark
	MHz	dB	dB/m	dB	dBuV	dBuV/m	dBuV/m	dB	
1	5648.723	8.08	32.54	32.24	55.87	64.25	68.20	-3.95	peak
2	5715.000	7.99	32.51	32.21	55.87	64.16	109.40	-45.24	peak
3	5725.000	7.98	32.51	32.21	60.16	68.44	122.20	-53.76	peak
4	5755.000	7.94	32.50	32.20	87.02	95.26	-----	-----	peak



Unless otherwise agreed in writing, this document is issued by the Company subject to its General Conditions of Service printed overleaf, available on request or accessible at <http://www.sgs.com/en/Terms-and-Conditions.aspx> and, for electronic format documents, subject to Terms and Conditions for Electronic Documents at <http://www.sgs.com/en/Terms-and-Conditions/Terms-e-Documents.aspx>. Attention is drawn to the limitation of liability, indemnification and jurisdiction issues defined therein. Any holder of this document is advised that information contained hereon reflects the Company's findings at the time of its intervention only and within the limits of Client's instructions, if any. The Company's sole responsibility is to its Client and this document does not exonerate parties to a transaction from exercising all their rights and obligations under the transaction documents. This document cannot be reproduced except in full, without prior written approval of the Company. Any unauthorized alteration, forgery or falsification of the content or appearance of this document is unlawful and offenders may be prosecuted to the fullest extent of the law. Unless otherwise stated the results shown in this test report refer only to the sample(s) tested and such sample(s) are retained for 30 days only.
Attention: To check the authenticity of testing /inspection report & certificate, please contact us at telephone: (86-755) 8307 1443, or email: CN.Doccheck@sgs.com

Fuyong lab, Xinlong TechnoPark, Fengtang Road, Fuyong Subdistrict, Bao'an, Shenzhen, China 518103 t (86-755) 88663988 f (86-755) 26710594 www.sgsgroup.com.cn
 中国·深圳·宝安区福永街道凤塘大道鑫龙科技园福永实验室 邮编: 518103 t (86-755) 88663988 f (86-755) 26710594 sgs.china@sgs.com

Compliance Certification Services (Kunshan) Inc. Shenzhen Branch

SZCCS-TRF-01 Rev. A/0 Aug01,2022

Report No.: FYCR221100046605

Page: 175 of 344

Test Mode: 12; Polarity: Vertical; Modulation:802.11n; Bandwidth:40MHz; Channel:Low

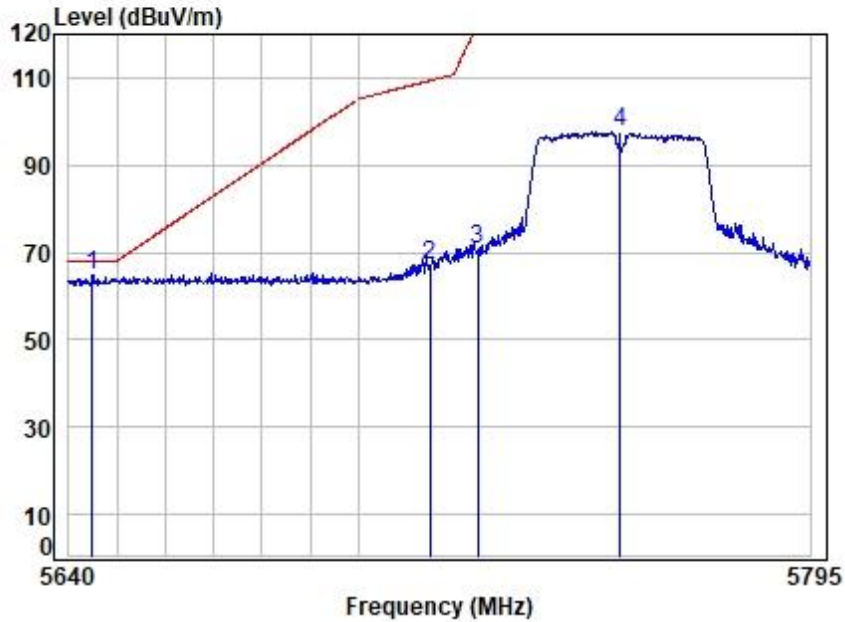

Site : chamber
 Condition: 3m VERTICAL
 Job No : 00466AT
 Mode : 5755 Band edge
 : 5G WIFI 11N40

	Freq	Cable Loss	Ant Factor	Preamp Factor	Read Level	Limit	Over	Remark
	MHz	dB	dB/m	dB	dBuV	dBuV/m	dB	
1	5644.895	8.08	32.54	32.24	56.39	64.77	68.20	-3.43 peak
2	5715.000	7.99	32.51	32.21	58.87	67.16	109.40	-42.24 peak
3	5725.000	7.98	32.51	32.21	62.23	70.51	122.20	-51.69 peak
4	5755.000	7.94	32.50	32.20	89.60	97.84	-----	----- peak



Unless otherwise agreed in writing, this document is issued by the Company subject to its General Conditions of Service printed overleaf, available on request or accessible at <http://www.sgs.com/en/Terms-and-Conditions.aspx> and, for electronic format documents, subject to Terms and Conditions for Electronic Documents at <http://www.sgs.com/en/Terms-and-Conditions/Terms-e-Documents.aspx>. Attention is drawn to the limitation of liability, indemnification and jurisdiction issues defined therein. Any holder of this document is advised that information contained hereon reflects the Company's findings at the time of its intervention only and within the limits of Client's instructions, if any. The Company's sole responsibility is to its Client and this document does not exonerate parties to a transaction from exercising all their rights and obligations under the transaction documents. This document cannot be reproduced except in full, without prior written approval of the Company. Any unauthorized alteration, forgery or falsification of the content or appearance of this document is unlawful and offenders may be prosecuted to the fullest extent of the law. Unless otherwise stated the results shown in this test report refer only to the sample(s) tested and such sample(s) are retained for 30 days only.
Attention: To check the authenticity of testing /inspection report & certificate, please contact us at telephone: (86-755) 8307 1443, or email: CN.Doccheck@sgs.com

Fuyong lab, Xinlong TechnoPark, Fengtang Road, Fuyong Subdistrict, Bao'an, Shenzhen, China 518103 t (86-755) 88663988 f (86-755) 26710594 www.sgsgroup.com.cn
 中国·深圳·宝安区福永街道凤塘大道鑫龙科技园福永实验室 邮编: 518103 t (86-755) 88663988 f (86-755) 26710594 sgs.china@sgs.com

Compliance Certification Services (Kunshan) Inc. Shenzhen Branch

SZCCS-TRF-01 Rev. A/0 Aug01,2022

Report No.: FYCR221100046605

Page: 176 of 344

Test Mode: 12; Polarity: Horizontal; Modulation:802.11n; Bandwidth:40MHz; Channel:High

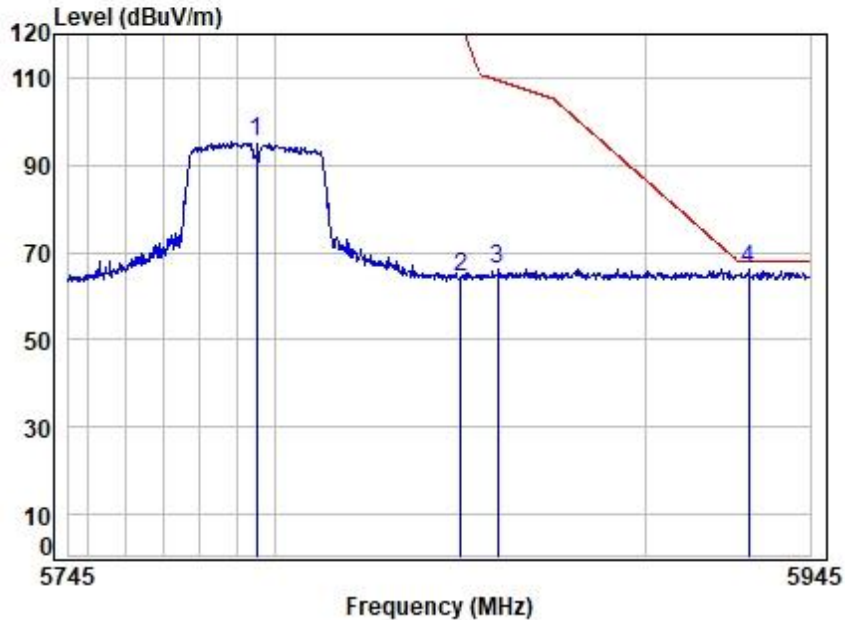

Site : chamber
 Condition: 3m HORIZONTAL
 Job No : 00466AT
 Mode : 5795 Band edge
 : 5G WIFI 11N40

	Freq	Cable Loss	Ant Factor	Preamp Factor	Read Level	Level	Limit	Over	Remark
	MHz	dB	dB/m	dB	dBuV	dBuV/m	dBuV/m	dB	
1	5795.000	7.89	32.48	32.18	86.97	95.16	-----	-----	peak
2	5850.000	7.82	32.46	32.16	56.21	64.33	122.20	-57.87	peak
3	5860.000	7.81	32.45	32.15	58.10	66.21	109.40	-43.19	peak
4	5928.138	7.73	32.43	32.13	57.99	66.02	68.20	-2.18	peak



Unless otherwise agreed in writing, this document is issued by the Company subject to its General Conditions of Service printed overleaf, available on request or accessible at <http://www.sgs.com/en/Terms-and-Conditions.aspx> and, for electronic format documents, subject to Terms and Conditions for Electronic Documents at <http://www.sgs.com/en/Terms-and-Conditions/Terms-e-Documents.aspx>. Attention is drawn to the limitation of liability, indemnification and jurisdiction issues defined therein. Any holder of this document is advised that information contained hereon reflects the Company's findings at the time of its intervention only and within the limits of Client's instructions, if any. The Company's sole responsibility is to its Client and this document does not exonerate parties to a transaction from exercising all their rights and obligations under the transaction documents. This document cannot be reproduced except in full, without prior written approval of the Company. Any unauthorized alteration, forgery or falsification of the content or appearance of this document is unlawful and offenders may be prosecuted to the fullest extent of the law. Unless otherwise stated the results shown in this test report refer only to the sample(s) tested and such sample(s) are retained for 30 days only.
Attention: To check the authenticity of testing /inspection report & certificate, please contact us at telephone: (86-755) 8307 1443, or email: CN.Doccheck@sgs.com

Fuyong lab, Xinlong TechnoPark, Fengtang Road, Fuyong Subdistrict, Bao'an, Shenzhen, China 518103 t (86-755) 88663988 f (86-755) 26710594 www.sgsgroup.com.cn
 中国·深圳·宝安区福永街道凤塘大道鑫龙科技园福永实验室 邮编: 518103 t (86-755) 88663988 f (86-755) 26710594 sgs.china@sgs.com

Compliance Certification Services (Kunshan) Inc. Shenzhen Branch

SZCCS-TRF-01 Rev. A/0 Aug01,2022

Report No.: FYCR221100046605

Page: 177 of 344

Test Mode: 12; Polarity: Vertical; Modulation:802.11n; Bandwidth:40MHz; Channel:High

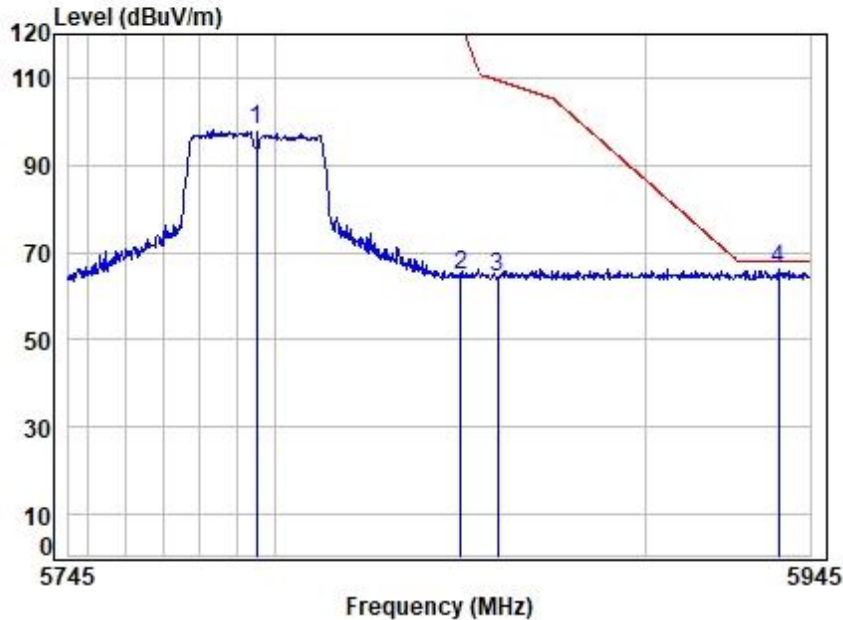

Site : chamber
 Condition: 3m VERTICAL
 Job No : 00466AT
 Mode : 5795 Band edge
 : 5G WIFI 11N40

	Freq	Cable Loss	Ant Factor	Preamp Factor	Read Level	Limit Level	Limit Line	Over Limit	Remark
	MHz	dB	dB/m	dB	dBuV	dBuV/m	dBuV/m	dB	
1	5795.000	7.89	32.48	32.18	89.79	97.98	-----	-----	peak
2	5850.000	7.82	32.46	32.16	56.66	64.78	122.20	-57.42	peak
3	5860.000	7.81	32.45	32.15	56.45	64.56	109.40	-44.84	peak
4	5936.258	7.72	32.42	32.12	58.03	66.05	68.20	-2.15	peak



Unless otherwise agreed in writing, this document is issued by the Company subject to its General Conditions of Service printed overleaf, available on request or accessible at <http://www.sgs.com/en/Terms-and-Conditions.aspx> and, for electronic format documents, subject to Terms and Conditions for Electronic Documents at <http://www.sgs.com/en/Terms-and-Conditions/Terms-e-Documents.aspx>. Attention is drawn to the limitation of liability, indemnification and jurisdiction issues defined therein. Any holder of this document is advised that information contained hereon reflects the Company's findings at the time of its intervention only and within the limits of Client's instructions, if any. The Company's sole responsibility is to its Client and this document does not exonerate parties to a transaction from exercising all their rights and obligations under the transaction documents. This document cannot be reproduced except in full, without prior written approval of the Company. Any unauthorized alteration, forgery or falsification of the content or appearance of this document is unlawful and offenders may be prosecuted to the fullest extent of the law. Unless otherwise stated the results shown in this test report refer only to the sample(s) tested and such sample(s) are retained for 30 days only.
Attention: To check the authenticity of testing /inspection report & certificate, please contact us at telephone: (86-755) 8307 1443, or email: CN.Doccheck@sgs.com

Fuyong lab, Xinlong TechnoPark, Fengtang Road, Fuyong Subdistrict, Bao'an, Shenzhen, China 518103 t (86-755) 88663988 f (86-755) 26710594 www.sgs.com.cn
 中国·深圳·宝安区福永街道凤塘大道鑫龙科技园福永实验室 邮编: 518103 t (86-755) 88663988 f (86-755) 26710594 sgs.china@sgs.com

Compliance Certification Services (Kunshan) Inc. Shenzhen Branch

SZCCS-TRF-01 Rev. A/0 Aug01,2022

Report No.: FYCR221100046605

Page: 178 of 344

Test Mode: 12; Polarity: Horizontal; Modulation:802.11ac; Bandwidth:80MHz; Channel:middle

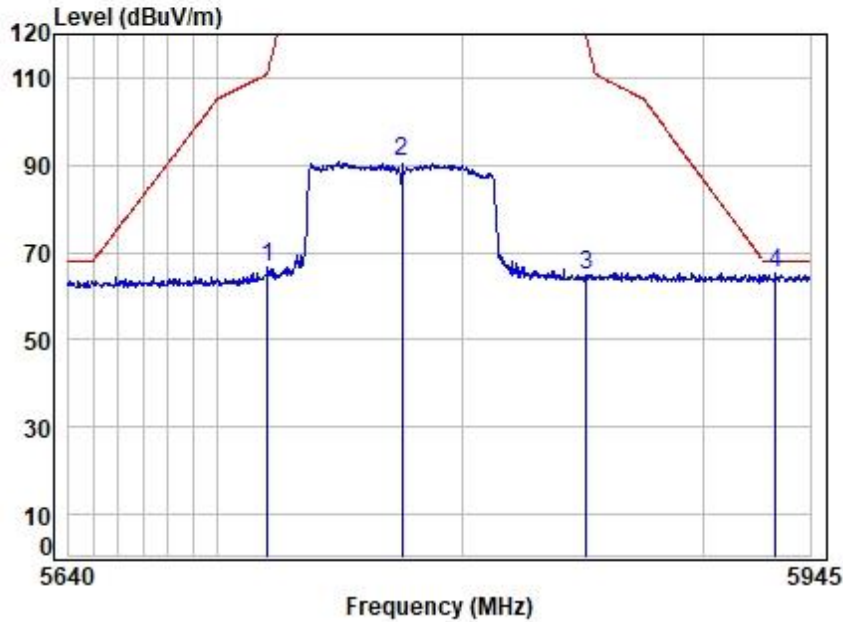

Site : chamber
 Condition: 3m HORIZONTAL
 Job No : 00466AT
 Mode : 5775 Band edge
 : 5G WIFI 11AC80

	Freq	Cable Loss	Ant Factor	Preamp Factor	Read Level	Level	Limit	Over	Remark
	MHz	dB	dB/m	dB	dBuV	dBuV/m	dBuV/m	dB	
1	5720.171	7.99	32.51	32.21	58.55	66.84	111.19	-44.35	peak
2	5775.000	7.92	32.49	32.19	82.40	90.62	-----	-----	peak
3	5851.191	7.82	32.46	32.16	56.88	65.00	119.48	-54.48	peak
4	5930.615	7.72	32.43	32.13	57.10	65.12	68.20	-3.08	peak



Unless otherwise agreed in writing, this document is issued by the Company subject to its General Conditions of Service printed overleaf, available on request or accessible at <http://www.sgs.com/en/Terms-and-Conditions.aspx> and, for electronic format documents, subject to Terms and Conditions for Electronic Documents at <http://www.sgs.com/en/Terms-and-Conditions/Terms-e-Documents.aspx>. Attention is drawn to the limitation of liability, indemnification and jurisdiction issues defined therein. Any holder of this document is advised that information contained hereon reflects the Company's findings at the time of its intervention only and within the limits of Client's instructions, if any. The Company's sole responsibility is to its Client and this document does not exonerate parties to a transaction from exercising all their rights and obligations under the transaction documents. This document cannot be reproduced except in full, without prior written approval of the Company. Any unauthorized alteration, forgery or falsification of the content or appearance of this document is unlawful and offenders may be prosecuted to the fullest extent of the law. Unless otherwise stated the results shown in this test report refer only to the sample(s) tested and such sample(s) are retained for 30 days only.
Attention: To check the authenticity of testing /inspection report & certificate, please contact us at telephone: (86-755) 8307 1443, or email: CN.Doccheck@sgs.com

Fuyong lab, Xinlong TechnoPark, Fengtang Road, Fuyong Subdistrict, Bao'an, Shenzhen, China 518103 t (86-755) 88663988 f (86-755) 26710594 www.sgsgroup.com.cn
 中国·深圳·宝安区福永街道凤塘大道鑫龙科技园福永实验室 邮编: 518103 t (86-755) 88663988 f (86-755) 26710594 sgs.china@sgs.com

Compliance Certification Services (Kunshan) Inc. Shenzhen Branch

SZCCS-TRF-01 Rev. A/0 Aug01,2022

Report No.: FYCR221100046605

Page: 179 of 344

Test Mode: 12; Polarity: Vertical; Modulation:802.11ac; Bandwidth:80MHz; Channel:middle

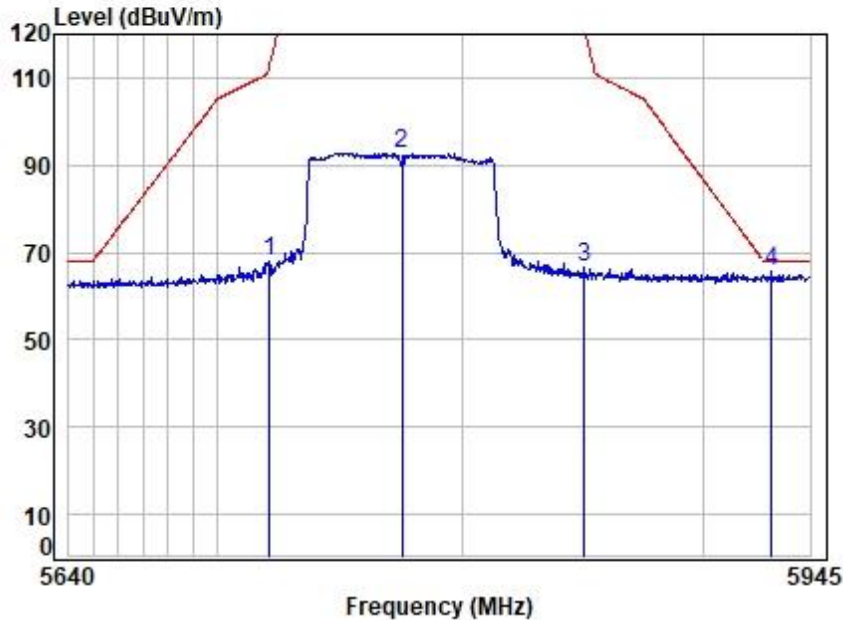

Site : chamber
 Condition: 3m VERTICAL
 Job No : 00466AT
 Mode : 5775 Band edge
 : 5G WIFI 11AC80

	Freq	Cable Loss	Ant Factor	Preamp Factor	Read Level	Limit Level	Limit Line	Over Limit	Remark
	MHz	dB	dB/m	dB	dBuV	dBuV/m	dBuV/m	dB	
1	5721.075	7.98	32.51	32.21	59.70	67.98	113.25	-45.27	peak
2	5775.000	7.92	32.49	32.19	84.63	92.85	-----	-----	peak
3	5850.575	7.82	32.46	32.16	58.30	66.42	120.89	-54.47	peak
4	5928.741	7.73	32.43	32.13	57.58	65.61	68.20	-2.59	peak



Unless otherwise agreed in writing, this document is issued by the Company subject to its General Conditions of Service printed overleaf, available on request or accessible at <http://www.sgs.com/en/Terms-and-Conditions.aspx> and, for electronic format documents, subject to Terms and Conditions for Electronic Documents at <http://www.sgs.com/en/Terms-and-Conditions/Terms-e-Documents.aspx>. Attention is drawn to the limitation of liability, indemnification and jurisdiction issues defined therein. Any holder of this document is advised that information contained hereon reflects the Company's findings at the time of its intervention only and within the limits of Client's instructions, if any. The Company's sole responsibility is to its Client and this document does not exonerate parties to a transaction from exercising all their rights and obligations under the transaction documents. This document cannot be reproduced except in full, without prior written approval of the Company. Any unauthorized alteration, forgery or falsification of the content or appearance of this document is unlawful and offenders may be prosecuted to the fullest extent of the law. Unless otherwise stated the results shown in this test report refer only to the sample(s) tested and such sample(s) are retained for 30 days only.
Attention: To check the authenticity of testing /inspection report & certificate, please contact us at telephone: (86-755) 8307 1443, or email: CN.Doccheck@sgs.com

Fuyong lab, Xinlong TechnoPark, Fengtang Road, Fuyong Subdistrict, Bao'an, Shenzhen, China 518103 t (86-755) 88663988 f (86-755) 26710594 www.sgs.com.cn
 中国·深圳·宝安区福永街道凤塘大道鑫龙科技园福永实验室 邮编: 518103 t (86-755) 88663988 f (86-755) 26710594 sgs.china@sgs.com

Compliance Certification Services (Kunshan) Inc. Shenzhen Branch

SZCCS-TRF-01 Rev. A/0 Aug01,2022

Report No.: FYCR221100046605

Page: 180 of 344

7.10 Frequency Stability

Test Requirement 47 CFR Part 15, Subpart E 15.407 (g)

Test Method: ANSI C63.10 (2013) Section 6.8

7.10.1 E.U.T. Operation

Operating Environment:

Temperature: 25.0 °C Humidity: 56.5 % RH Atmospheric Pressure: 1020 mbar

7.10.2 Test Mode Description

Pre-scan / Final test	Mode Code	Description
Final test	09	TX mode (U-NII-1)_Keep the EUT in continuously transmitting mode with all modulation types. All data rates for each modulation type have been tested and found the data rate @ 6Mbps is the worst case of IEEE 802.11a; data rate @ MCS0 is the worst case of IEEE 802.11n(HT20); data rate @ MCS0 is the worst case of IEEE 802.11n(HT40); data rate @ MCS0 is the worst case of IEEE 802.11ac(VHT20); data rate @ MCS0 is the worst case of IEEE 802.11ac(VHT40); data rate @ MCS0 is the worst case of IEEE 802.11ac(VHT80), final test modes are considering the modulation and worse data rates. Only the data of worst case is recorded in the report.
Final test	10	TX mode (U-NII-2A)_Keep the EUT in continuously transmitting mode with all modulation types. All data rates for each modulation type have been tested and found the data rate @ 6Mbps is the worst case of IEEE 802.11a; data rate @ MCS0 is the worst case of IEEE 802.11n(HT20); data rate @ MCS0 is the worst case of IEEE 802.11n(HT40); data rate @ MCS0 is the worst case of IEEE 802.11ac(VHT20); data rate @ MCS0 is the worst case of IEEE 802.11ac(VHT40); data rate @ MCS0 is the worst case of IEEE 802.11ac(VHT80), final test modes are considering the modulation and worse data rates. Only the data of worst case is recorded in the report.
Final test	11	TX mode (U-NII-2C)_Keep the EUT in continuously transmitting mode with all modulation types. All data rates for each modulation type have been tested and found the data rate @ 6Mbps is the worst case of IEEE 802.11a; data rate @ MCS0 is the worst case of IEEE 802.11n(HT20); data rate @ MCS0 is the worst case of IEEE 802.11n(HT40); data rate @ MCS0 is the worst case of IEEE 802.11ac(VHT20); data rate @ MCS0 is the worst case of IEEE 802.11ac(VHT40); data rate @ MCS0 is the worst case of IEEE 802.11ac(VHT80), final test modes are considering the modulation and worse data rates. Only the data of worst case is recorded in the report.
Final test	12	TX mode (U-NII-3)_Keep the EUT in continuously transmitting mode with all modulation types. All data rates for each modulation type have been tested and found the data rate @ 6Mbps is the worst case of IEEE 802.11a; data rate @ MCS0 is the worst case of IEEE 802.11n(HT20); data rate @ MCS0 is the worst case of IEEE 802.11n(HT40); data rate @ MCS0 is the worst case of IEEE 802.11ac(VHT20); data rate @ MCS0 is the worst case of IEEE 802.11ac(VHT40); data rate @ MCS0 is the worst case of IEEE 802.11ac(VHT80), final test modes are considering the modulation and worse data rates. Only the data of worst case is recorded in the report.



Unless otherwise agreed in writing, this document is issued by the Company subject to its General Conditions of Service printed overleaf, available on request or accessible at <http://www.sgs.com/en/Terms-and-Conditions.aspx> and, for electronic format documents, subject to Terms and Conditions for Electronic Documents at <http://www.sgs.com/en/Terms-and-Conditions/Terms-e-Documents.aspx>. Attention is drawn to the limitation of liability, indemnification and jurisdiction issues defined therein. Any holder of this document is advised that information contained hereon reflects the Company's findings at the time of its intervention only and within the limits of Client's instructions, if any. The Company's sole responsibility is to its Client and this document does not exonerate parties to a transaction from exercising all their rights and obligations under the transaction documents. This document cannot be reproduced except in full, without prior written approval of the Company. Any unauthorized alteration, forgery or falsification of the content or appearance of this document is unlawful and offenders may be prosecuted to the fullest extent of the law. Unless otherwise stated the results shown in this test report refer only to the sample(s) tested and such sample(s) are retained for 30 days only.
Attention: To check the authenticity of testing/inspection report & certificate, please contact us at telephone: (86-755) 8307 1443, or email: CN.Doccheck@sgs.com

Fuyong Lab, Xinlong TechnoPark, Fengtang Road, Fuyong Subdistrict, Bao'an, Shenzhen, China 518103 t (86-755) 88663988 f (86-755) 26710594 www.sgsgroup.com.cn
 中国·深圳·宝安区福永街道凤塘大道鑫龙科技园福永实验室 邮编: 518103 t (86-755) 88663988 f (86-755) 26710594 sgs.china@sgs.com

		recorded in the report.
--	--	-------------------------

7.10.3 Test Setup Diagram

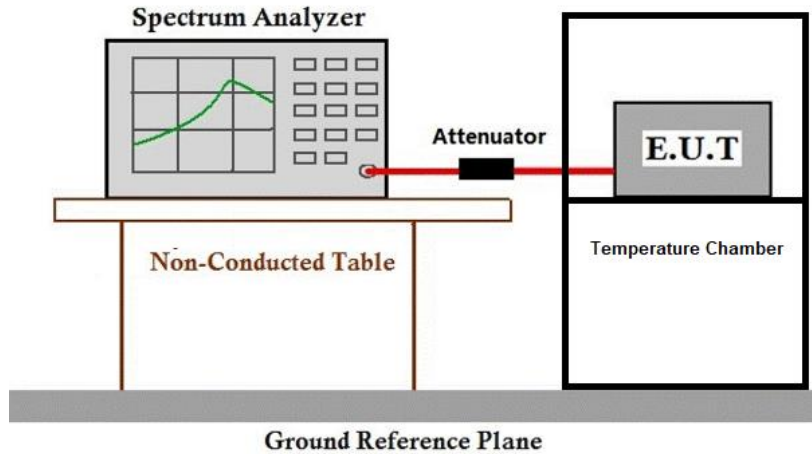

7.10.4 Measurement Procedure and Data

Please Refer to Appendix for Details



Unless otherwise agreed in writing, this document is issued by the Company subject to its General Conditions of Service printed overleaf, available on request or accessible at <http://www.sgs.com/en/Terms-and-Conditions.aspx> and, for electronic format documents, subject to Terms and Conditions for Electronic Documents at <http://www.sgs.com/en/Terms-and-Conditions/Terms-e-Documents.aspx>. Attention is drawn to the limitation of liability, indemnification and jurisdiction issues defined therein. Any holder of this document is advised that information contained hereon reflects the Company's findings at the time of its intervention only and within the limits of Client's instructions, if any. The Company's sole responsibility is to its Client and this document does not exonerate parties to a transaction from exercising all their rights and obligations under the transaction documents. This document cannot be reproduced except in full, without prior written approval of the Company. Any unauthorized alteration, forgery or falsification of the content or appearance of this document is unlawful and offenders may be prosecuted to the fullest extent of the law. Unless otherwise stated the results shown in this test report refer only to the sample(s) tested and such sample(s) are retained for 30 days only.
Attention: To check the authenticity of testing /inspection report & certificate, please contact us at telephone: (86-755) 8307 1443, or email: CN.Doccheck@sgs.com

Fuyong lab, Xinlong TechnoPark, Fengtang Road, Fuyong Subdistrict, Bao'an, Shenzhen, China 518103 t (86-755) 88663988 f (86-755) 26710594 www.sgs.com.cn
 中国·深圳·宝安区福永街道凤塘大道鑫龙科技园福永实验室 邮编: 518103 t (86-755) 88663988 f (86-755) 26710594 sgs.china@sgs.com

7.11 Channel Move Time

Test Requirement KDB 905462 D02 Section 5.1
 Test Method: KDB 905462 D02 Section 7.8.3
 Limit:

Test item	Limit	Applicability	
		Master Device or client with Radar Detection	Client without Radar Detection
Non-occupancy period	Minimum 30 minutes	Yes	Not required
Channel Availability Check Time	60 seconds	Yes	Not required
Channel Move Time	10 seconds See Note 1.	Yes	Yes
Channel Closing Transmission Time	200 milliseconds + an aggregate of 60 milliseconds over remaining 10 second period. See Notes 1 and 2.	Yes	Yes
U-NII Detection Bandwidth	Minimum 100% of the U-NII 99% transmission power bandwidth. See Note 3.	Yes	Not required

Note 1: Channel Move Time and the Channel Closing Transmission Time should be performed with Radar Type 0. The measurement timing begins at the end of the Radar Type 0 burst.
 Note 2: The Channel Closing Transmission Time is comprised of 200 milliseconds starting at the beginning of the Channel Move Time plus any additional intermittent control signals required to facilitate a Channel move (an aggregate of 60 milliseconds) during the remainder of the 10 second period. The aggregate duration of control signals will not count quiet periods in between transmissions.
 Note 3: During the U-NII Detection Bandwidth detection test, radar type 0 should be used. For each frequency step the minimum percentage of detection is 90 percent. Measurements are performed with no data traffic.

7.11.1 E.U.T. Operation

Operating Environment:
 Temperature: 21.5 °C Humidity: 44 % RH Atmospheric Pressure: 1020 mbar

7.11.2 Test Mode Description

Pre-scan / Final test	Mode Code	Description
Final test	13	Normal operating_Keep the EUT communication with the companion device.



Unless otherwise agreed in writing, this document is issued by the Company subject to its General Conditions of Service printed overleaf, available on request or accessible at <http://www.sgs.com/en/Terms-and-Conditions.aspx> and, for electronic format documents, subject to Terms and Conditions for Electronic Documents at <http://www.sgs.com/en/Terms-and-Conditions/Terms-e-Documents.aspx>. Attention is drawn to the limitation of liability, indemnification and jurisdiction issues defined therein. Any holder of this document is advised that information contained hereon reflects the Company's findings at the time of its intervention only and within the limits of Client's instructions, if any. The Company's sole responsibility is to its Client and this document does not exonerate parties to a transaction from exercising all their rights and obligations under the transaction documents. This document cannot be reproduced except in full, without prior written approval of the Company. Any unauthorized alteration, forgery or falsification of the content or appearance of this document is unlawful and offenders may be prosecuted to the fullest extent of the law. Unless otherwise stated the results shown in this test report refer only to the sample(s) tested and such sample(s) are retained for 30 days only.
Attention: To check the authenticity of testing /inspection report & certificate, please contact us at telephone: (86-755) 8307 1443, or email: CN.Doccheck@sgs.com
 Fuyong lab, Xinlong TechnoPark, Fengtang Road, Fuyong Subdistrict, Bao'an, Shenzhen, China 518103 t (86-755) 88663988 f (86-755) 26710594 www.sgsgroup.com.cn
 中国·深圳·宝安区福永街道凤塘大道鑫龙科技园福永实验室 邮编: 518103 t (86-755) 88663988 f (86-755) 26710594 sgs.china@sgs.com

7.11.3 Test Setup Diagram

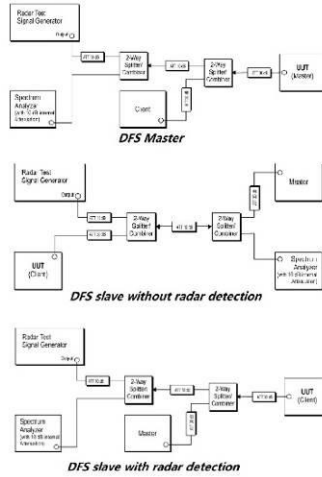

Unless otherwise agreed in writing, this document is issued by the Company subject to its General Conditions of Service printed overleaf, available on request or accessible at <http://www.sgs.com/en/Terms-and-Conditions.aspx> and, for electronic format documents, subject to Terms and Conditions for Electronic Documents at <http://www.sgs.com/en/Terms-and-Conditions/Terms-e-Documents.aspx>. Attention is drawn to the limitation of liability, indemnification and jurisdiction issues defined therein. Any holder of this document is advised that information contained hereon reflects the Company's findings at the time of its intervention only and within the limits of Client's instructions, if any. The Company's sole responsibility is to its Client and this document does not exonerate parties to a transaction from exercising all their rights and obligations under the transaction documents. This document cannot be reproduced except in full, without prior written approval of the Company. Any unauthorized alteration, forgery or falsification of the content or appearance of this document is unlawful and offenders may be prosecuted to the fullest extent of the law. Unless otherwise stated the results shown in this test report refer only to the sample(s) tested and such sample(s) are retained for 30 days only.
Attention: To check the authenticity of testing /inspection report & certificate, please contact us at telephone: (86-755) 8307 1443, or email: CN.Doccheck@sgs.com

Fuyong lab, Xinlong TechnoPark, Fengtang Road, Fuyong Subdistrict, Bao'an, Shenzhen, China 518103 t (86-755) 88663988 f (86-755) 26710594 www.sgsgroup.com.cn
 中国·深圳·宝安区福永街道凤塘大道鑫龙科技园福永实验室 邮编: 518103 t (86-755) 88663988 f (86-755) 26710594 sgs.china@sgs.com

7.11.4 Measurement Procedure and Data

- 1) The radar pulse generator is setup to provide a pulse at frequency that the master and client are operating. A type 0 radar pulse with a 1us pulse width and a 1428us PRI is used for the testing.
- 2) The vector signal generator is adjusted to provide the radar burst (18 pulses) at the level of approximately -61dBm at the antenna port of the master device.
- 3) A trigger is provided from the pulse generator to the DFS monitoring system in order to capture the traffic and the occurrence of the radar pulse.
- 4) EUT will associate with the master at channel. The file "iperf.exe" specified by the FCC is streamed from the PC 2 through the master and the client device to the PC 1 and played in full motion video using Media Player Classic Ver. 6.4.8.6 in order to properly load the network for the entire period of the test.
- 5) When radar burst with a level equal to the DFS Detection Threshold +1dB is generated on the operating channel of the U-NII device. At time T0 the radar waveform generator sends a burst of pulse of the radar waveform at Detection Threshold +1dB.
- 6) Observe the transmissions of the EUT at the end of the radar Burst on the Operating Channel. Measure and record the transmissions from the UUT during the observation time (Channel Move Time). One 15 seconds plot is reported for the Short Pulse Radar Type 0. The plot for the Short Pulse Radar Types start at the end of the radar burst. The Channel Move Time will be calculated based on the zoom in 600ms plot of the Short Pulse Radar Type.
- 7) Measurement of the aggregate duration of the Channel Closed Transmission Time method. With the spectrum analyzer set to zero span tuned to the center frequency of the EUT operating channel at the radar simulated frequency, peak detection, and max hold, the dwell time per bin is given by: $Dwell (0.3ms) = S (12000ms) / B (4000)$; where Dwell is the dwell time per spectrum analyzer sampling bin, S is sweep time and B is the number of spectrum analyzer sampling bins. An upper bound of the aggregate duration of the intermittent control signals of Channel Closing Transmission Time is calculated by: $C (ms) = N \times Dwell (0.3ms)$; where C is the Closing Time, N is the number of spectrum analyzer sampling bins (intermittent control signals) showing a U-NII transmission and Dwell is the dwell time per bin.
- 8) Measurement the EUT for more than 30 minutes following the channel move time to verify that no transmission or beacons occur on this channel.

Please Refer to Appendix for Details



Unless otherwise agreed in writing, this document is issued by the Company subject to its General Conditions of Service printed overleaf, available on request or accessible at <http://www.sgs.com/en/Terms-and-Conditions.aspx> and, for electronic format documents, subject to Terms and Conditions for Electronic Documents at <http://www.sgs.com/en/Terms-and-Conditions/Terms-e-Documents.aspx>. Attention is drawn to the limitation of liability, indemnification and jurisdiction issues defined therein. Any holder of this document is advised that information contained hereon reflects the Company's findings at the time of its intervention only and within the limits of Client's instructions, if any. The Company's sole responsibility is to its Client and this document does not exonerate parties to a transaction from exercising all their rights and obligations under the transaction documents. This document cannot be reproduced except in full, without prior written approval of the Company. Any unauthorized alteration, forgery or falsification of the content or appearance of this document is unlawful and offenders may be prosecuted to the fullest extent of the law. Unless otherwise stated the results shown in this test report refer only to the sample(s) tested and such sample(s) are retained for 30 days only.
Attention: To check the authenticity of testing /inspection report & certificate, please contact us at telephone: (86-755) 8307 1443, or email: CN.Doccheck@sgs.com

Fuyong Lab, Xinlong TechnoPark, Fengtang Road, Fuyong Subdistrict, Bao'an, Shenzhen, China 518103 t (86-755) 88663988 f (86-755) 26710594 www.sgsgroup.com.cn
 中国·深圳·宝安区福永街道凤塘大道鑫龙科技园福永实验室 邮编: 518103 t (86-755) 88663988 f (86-755) 26710594 sgs.china@sgs.com

7.12 Channel Closing Transmission Time

Test Requirement KDB 905462 D02 Section 5.1
 Test Method: KDB 905462 D02 Section 7.8.3

Limit:

Test item	Limit	Applicability	
		Master Device or client with Radar Detection	Client without Radar Detection
Non-occupancy period	Minimum 30 minutes	Yes	Not required
Channel Availability Check Time	60 seconds	Yes	Not required
Channel Move Time	10 seconds See Note 1.	Yes	Yes
Channel Closing Transmission Time	200 milliseconds + an aggregate of 60 milliseconds over remaining 10 second period. See Notes 1 and 2.	Yes	Yes
U-NII Detection Bandwidth	Minimum 100% of the U-NII 99% transmission power bandwidth. See Note 3.	Yes	Not required

Note 1: Channel Move Time and the Channel Closing Transmission Time should be performed with Radar Type 0. The measurement timing begins at the end of the Radar Type 0 burst.

Note 2: The Channel Closing Transmission Time is comprised of 200 milliseconds starting at the beginning of the Channel Move Time plus any additional intermittent control signals required to facilitate a Channel move (an aggregate of 60 milliseconds) during the remainder of the 10 second period. The aggregate duration of control signals will not count quiet periods in between transmissions.

Note 3: During the U-NII Detection Bandwidth detection test, radar type 0 should be used. For each frequency step the minimum percentage of detection is 90 percent. Measurements are performed with no data traffic.

7.12.1 E.U.T. Operation

Operating Environment:

Temperature: 21.5 °C Humidity: 44 % RH Atmospheric Pressure: 1020 mbar



Unless otherwise agreed in writing, this document is issued by the Company subject to its General Conditions of Service printed overleaf, available on request or accessible at <http://www.sgs.com/en/Terms-and-Conditions.aspx> and, for electronic format documents, subject to Terms and Conditions for Electronic Documents at <http://www.sgs.com/en/Terms-and-Conditions/Terms-e-Documents.aspx>. Attention is drawn to the limitation of liability, indemnification and jurisdiction issues defined therein. Any holder of this document is advised that information contained hereon reflects the Company's findings at the time of its intervention only and within the limits of Client's instructions, if any. The Company's sole responsibility is to its Client and this document does not exonerate parties to a transaction from exercising all their rights and obligations under the transaction documents. This document cannot be reproduced except in full, without prior written approval of the Company. Any unauthorized alteration, forgery or falsification of the content or appearance of this document is unlawful and offenders may be prosecuted to the fullest extent of the law. Unless otherwise stated the results shown in this test report refer only to the sample(s) tested and such sample(s) are retained for 30 days only.
Attention: To check the authenticity of testing /inspection report & certificate, please contact us at telephone: (86-755) 8307 1443, or email: CN.Doccheck@sgs.com

Fuyong lab, Xinlong TechnoPark, Fengtang Road, Fuyong Subdistrict, Bao'an, Shenzhen, China 518103 t (86-755) 88663988 f (86-755) 26710594 www.sgsgroup.com.cn
 中国·深圳·宝安区福永街道凤塘大道鑫龙科技园福永实验室 邮编: 518103 t (86-755) 88663988 f (86-755) 26710594 sgs.china@sgs.com

7.12.2 Test Mode Description

Pre-scan / Final test	Mode Code	Description
Final test	13	Normal operating_Keep the EUT communication with the companion device.

7.12.3 Test Setup Diagram

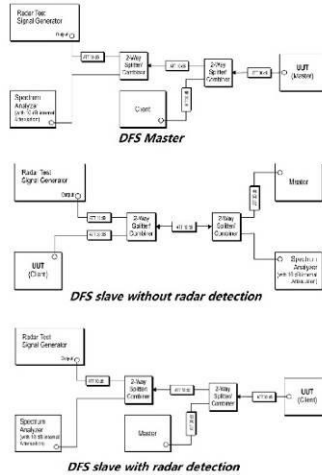

Unless otherwise agreed in writing, this document is issued by the Company subject to its General Conditions of Service printed overleaf, available on request or accessible at <http://www.sgs.com/en/Terms-and-Conditions.aspx> and, for electronic format documents, subject to Terms and Conditions for Electronic Documents at <http://www.sgs.com/en/Terms-and-Conditions/Terms-e-Document.aspx>. Attention is drawn to the limitation of liability, indemnification and jurisdiction issues defined therein. Any holder of this document is advised that information contained hereon reflects the Company's findings at the time of its intervention only and within the limits of Client's instructions, if any. The Company's sole responsibility is to its Client and this document does not exonerate parties to a transaction from exercising all their rights and obligations under the transaction documents. This document cannot be reproduced except in full, without prior written approval of the Company. Any unauthorized alteration, forgery or falsification of the content or appearance of this document is unlawful and offenders may be prosecuted to the fullest extent of the law. Unless otherwise stated the results shown in this test report refer only to the sample(s) tested and such sample(s) are retained for 30 days only.
Attention: To check the authenticity of testing /inspection report & certificate, please contact us at telephone: (86-755) 8307 1443, or email: CN.Doccheck@sgs.com

Fuyong lab, Xinlong TechnoPark, Fengtang Road, Fuyong Subdistrict, Bao'an, Shenzhen, China 518103 t (86-755) 88663988 f (86-755) 26710594 www.sgsgroup.com.cn
中国·深圳·宝安区福永街道凤塘大道鑫龙科技园福永实验室 邮编: 518103 t (86-755) 88663988 f (86-755) 26710594 sgs.china@sgs.com

7.12.4 Measurement Procedure and Data

- 1) The radar pulse generator is setup to provide a pulse at frequency that the master and client are operating. A type 0 radar pulse with a 1us pulse width and a 1428us PRI is used for the testing.
- 2) The vector signal generator is adjusted to provide the radar burst (18 pulses) at the level of approximately -61dBm at the antenna port of the master device.
- 3) A trigger is provided from the pulse generator to the DFS monitoring system in order to capture the traffic and the occurrence of the radar pulse.
- 4) EUT will associate with the master at channel. The file "iperf.exe" specified by the FCC is streamed from the PC 2 through the master and the client device to the PC 1 and played in full motion video using Media Player Classic Ver. 6.4.8.6 in order to properly load the network for the entire period of the test.
- 5) When radar burst with a level equal to the DFS Detection Threshold +1dB is generated on the operating channel of the U-NII device. At time T0 the radar waveform generator sends a burst of pulse of the radar waveform at Detection Threshold +1dB.
- 6) Observe the transmissions of the EUT at the end of the radar Burst on the Operating Channel. Measure and record the transmissions from the UUT during the observation time (Channel Move Time). One 15 seconds plot is reported for the Short Pulse Radar Type 0. The plot for the Short Pulse Radar Types start at the end of the radar burst. The Channel Move Time will be calculated based on the zoom in 600ms plot of the Short Pulse Radar Type.
- 7) Measurement of the aggregate duration of the Channel Closed Transmission Time method. With the spectrum analyzer set to zero span tuned to the center frequency of the EUT operating channel at the radar simulated frequency, peak detection, and max hold, the dwell time per bin is given by: $Dwell (0.3ms) = S (12000ms) / B (4000)$; where Dwell is the dwell time per spectrum analyzer sampling bin, S is sweep time and B is the number of spectrum analyzer sampling bins. An upper bound of the aggregate duration of the intermittent control signals of Channel Closing Transmission Time is calculated by: $C (ms) = N \times Dwell (0.3ms)$; where C is the Closing Time, N is the number of spectrum analyzer sampling bins (intermittent control signals) showing a U-NII transmission and Dwell is the dwell time per bin.
- 8) Measurement the EUT for more than 30 minutes following the channel move time to verify that no transmission or beacons occur on this channel.

Please Refer to Appendix for Details



Unless otherwise agreed in writing, this document is issued by the Company subject to its General Conditions of Service printed overleaf, available on request or accessible at <http://www.sgs.com/en/Terms-and-Conditions.aspx> and, for electronic format documents, subject to Terms and Conditions for Electronic Documents at <http://www.sgs.com/en/Terms-and-Conditions/Terms-e-Documents.aspx>. Attention is drawn to the limitation of liability, indemnification and jurisdiction issues defined therein. Any holder of this document is advised that information contained hereon reflects the Company's findings at the time of its intervention only and within the limits of Client's instructions, if any. The Company's sole responsibility is to its Client and this document does not exonerate parties to a transaction from exercising all their rights and obligations under the transaction documents. This document cannot be reproduced except in full, without prior written approval of the Company. Any unauthorized alteration, forgery or falsification of the content or appearance of this document is unlawful and offenders may be prosecuted to the fullest extent of the law. Unless otherwise stated the results shown in this test report refer only to the sample(s) tested and such sample(s) are retained for 30 days only.
Attention: To check the authenticity of testing /inspection report & certificate, please contact us at telephone: (86-755) 8307 1443, or email: CN.Doccheck@sgs.com

Fuyong lab, Xinlong TechnoPark, Fengtang Road, Fuyong Subdistrict, Bao'an, Shenzhen, China 518103 t (86-755) 88663988 f (86-755) 26710594 www.sgsgroup.com.cn
 中国·深圳·宝安区福永街道凤塘大道鑫龙科技园福永实验室 邮编: 518103 t (86-755) 88663988 f (86-755) 26710594 sgs.china@sgs.com

Compliance Certification Services (Kunshan) Inc. Shenzhen Branch

SZCCS-TRF-01 Rev. A/0 Aug01,2022

Report No.: FYCR221100046605

Page: 188 of 344

7.13 Radiated Emissions (Below 1GHz)

Test Requirement 47 CFR Part 15, Subpart C 15.209 & Subpart E 15.407(b)
 Test Method: ANSI C63.10 (2013) Section 6.4,6.5
 Measurement Distance: 3m

Limit:

Frequency(MHz)	Field strength(microvolts/meter)	Measurement distance(meters)
0.009-0.490	2400/F(kHz)	300
0.490-1.705	24000/F(kHz)	30
1.705-30.0	30	30
30-88	100	3
88-216	150	3
216-960	200	3
960-1000	500	3

7.13.1 E.U.T. Operation

Operating Environment:

Temperature: 22.3 °C Humidity: 52.9 % RH Atmospheric Pressure: 1020 mbar

7.13.2 Test Mode Description

Pre-scan / Final test	Mode Code	Description
Final test	09	TX mode (U-NII-1)_Keep the EUT in continuously transmitting mode with all modulation types. All data rates for each modulation type have been tested and found the data rate @ 6Mbps is the worst case of IEEE 802.11a; data rate @ MCS0 is the worst case of IEEE 802.11n(HT20); data rate @ MCS0 is the worst case of IEEE 802.11n(HT40); data rate @ MCS0 is the worst case of IEEE 802.11ac(VHT20); data rate @ MCS0 is the worst case of IEEE 802.11ac(VHT40); data rate @ MCS0 is the worst case of IEEE 802.11ac(VHT80), final test modes are considering the modulation and worse data rates. Only the data of worst case is recorded in the report.
Pre-scan	10	TX mode (U-NII-2A)_Keep the EUT in continuously transmitting mode with all modulation types. All data rates for each modulation type have been tested and found the data rate @ 6Mbps is the worst case of IEEE 802.11a; data rate @ MCS0 is the worst case of IEEE 802.11n(HT20); data rate @ MCS0 is the worst case of IEEE 802.11n(HT40); data rate @ MCS0 is the worst case of IEEE 802.11ac(VHT20); data rate @ MCS0 is the worst case of IEEE 802.11ac(VHT40); data rate @ MCS0 is the worst case of IEEE 802.11ac(VHT80), final test modes are considering the modulation and worse data rates. Only the data of worst case is recorded in the report.
Pre-scan	11	TX mode (U-NII-2C)_Keep the EUT in continuously transmitting mode with all modulation types. All data rates for each modulation type have been tested and



Unless otherwise agreed in writing, this document is issued by the Company subject to its General Conditions of Service printed overleaf, available on request or accessible at <http://www.sgs.com/en/Terms-and-Conditions.aspx> and, for electronic format documents, subject to Terms and Conditions for Electronic Documents at <http://www.sgs.com/en/Terms-and-Conditions/Terms-e-Documents.aspx>. Attention is drawn to the limitation of liability, indemnification and jurisdiction issues defined therein. Any holder of this document is advised that information contained hereon reflects the Company's findings at the time of its intervention only and within the limits of Client's instructions, if any. The Company's sole responsibility is to its Client and this document does not exonerate parties to a transaction from exercising all their rights and obligations under the transaction documents. This document cannot be reproduced except in full, without prior written approval of the Company. Any unauthorized alteration, forgery or falsification of the content or appearance of this document is unlawful and offenders may be prosecuted to the fullest extent of the law. Unless otherwise stated the results shown in this test report refer only to the sample(s) tested and such sample(s) are retained for 30 days only.
Attention: To check the authenticity of testing /inspection report & certificate, please contact us at telephone: (86-755) 8307 1443, or email: CN.Doccheck@sgs.com

Fuyong lab, Xinlong TechnoPark, Fengtang Road, Fuyong Subdistrict, Bao'an, Shenzhen, China 518103 t (86-755) 88663988 f (86-755) 26710594 www.sgsgroup.com.cn
 中国·深圳·宝安区福永街道凤塘大道鑫龙科技园福永实验室 邮编: 518103 t (86-755) 88663988 f (86-755) 26710594 sgs.china@sgs.com

		found the data rate @ 6Mbps is the worst case of IEEE 802.11a; data rate @ MCS0 is the worst case of IEEE 802.11n(HT20); data rate @ MCS0 is the worst case of IEEE 802.11n(HT40); data rate @ MCS0 is the worst case of IEEE 802.11ac(VHT20); data rate @ MCS0 is the worst case of IEEE 802.11ac(VHT40); data rate @ MCS0 is the worst case of IEEE 802.11ac(VHT80), final test modes are considering the modulation and worse data rates. Only the data of worst case is recorded in the report.
Pre-scan	12	TX mode (U-NII-3)_Keep the EUT in continuously transmitting mode with all modulation types. All data rates for each modulation type have been tested and found the data rate @ 6Mbps is the worst case of IEEE 802.11a; data rate @ MCS0 is the worst case of IEEE 802.11n(HT20); data rate @ MCS0 is the worst case of IEEE 802.11n(HT40); data rate @ MCS0 is the worst case of IEEE 802.11ac(VHT20); data rate @ MCS0 is the worst case of IEEE 802.11ac(VHT40); data rate @ MCS0 is the worst case of IEEE 802.11ac(VHT80), final test modes are considering the modulation and worse data rates. Only the data of worst case is recorded in the report.

7.13.3 Test Setup Diagram

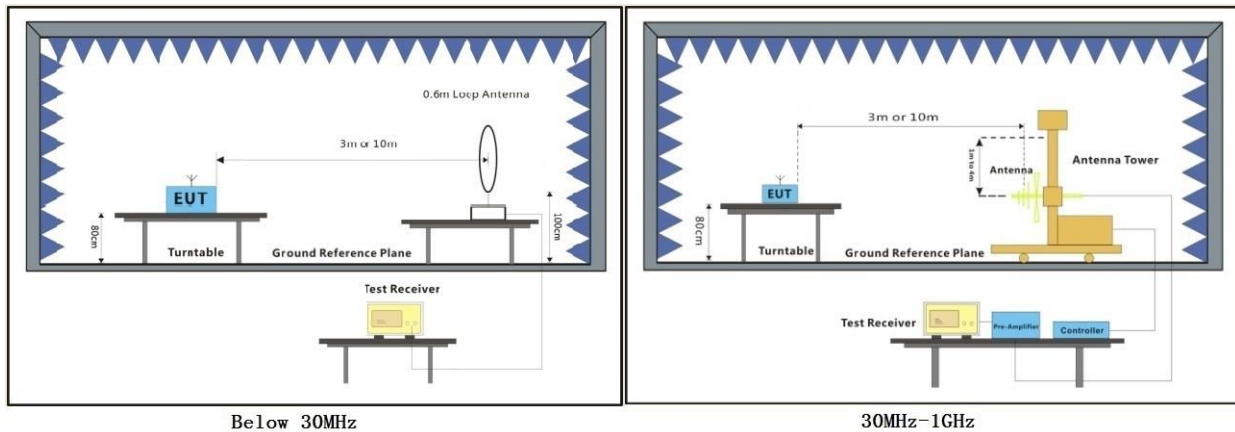

Unless otherwise agreed in writing, this document is issued by the Company subject to its General Conditions of Service printed overleaf, available on request or accessible at <http://www.sgs.com/en/Terms-and-Conditions.aspx> and, for electronic format documents, subject to Terms and Conditions for Electronic Documents at <http://www.sgs.com/en/Terms-and-Conditions/Terms-e-Documents.aspx>. Attention is drawn to the limitation of liability, indemnification and jurisdiction issues defined therein. Any holder of this document is advised that information contained hereon reflects the Company's findings at the time of its intervention only and within the limits of Client's instructions, if any. The Company's sole responsibility is to its Client and this document does not exonerate parties to a transaction from exercising all their rights and obligations under the transaction documents. This document cannot be reproduced except in full, without prior written approval of the Company. Any unauthorized alteration, forgery or falsification of the content or appearance of this document is unlawful and offenders may be prosecuted to the fullest extent of the law. Unless otherwise stated the results shown in this test report refer only to the sample(s) tested and such sample(s) are retained for 30 days only.
Attention: To check the authenticity of testing /inspection report & certificate, please contact us at telephone: (86-755) 8307 1443, or email: CN.Doccheck@sgs.com

Fuyong lab, Xinlong TechnoPark, Fengtang Road, Fuyong Subdistrict, Bao'an, Shenzhen, China 518103 t (86-755) 88663988 f (86-755) 26710594 www.sgsgroup.com.cn
 中国·深圳·宝安区福永街道凤塘大道鑫龙科技园福永实验室 邮编: 518103 t (86-755) 88663988 f (86-755) 26710594 sgs.china@sgs.com

7.13.4 Measurement Procedure and Data

- a. For below 1GHz, the EUT was placed on the top of a rotating table 0.8 meters above the ground at a 3 meter semi-anechoic chamber. The table was rotated 360 degrees to determine the position of the highest radiation.
- b. The EUT was set 3 or 10 meters away from the interference-receiving antenna, which was mounted on the top of a variable-height antenna tower.
- c. The antenna height is varied from one meter to four meters above the ground to determine the maximum value of the field strength. Both horizontal and vertical polarizations of the antenna are set to make the measurement.
- d. For each suspected emission, the EUT was arranged to its worst case and then the antenna was tuned to heights from 1 meter to 4 meters (for the test frequency of below 30MHz, the antenna was tuned to heights 1 meter) and the rotatable table was turned from 0 degrees to 360 degrees to find the maximum reading.
- e. The test-receiver system was set to Peak Detect Function and Specified Bandwidth with Maximum Hold Mode.
- f. If the emission level of the EUT in peak mode was 10dB lower than the limit specified, then testing could be stopped and the peak values of the EUT would be reported. Otherwise the emissions that did not have 10dB margin would be re-tested one by one using quasi-peak method as specified and then reported in a data sheet.
- g. Test the EUT in the lowest channel, the middle channel, the Highest channel.
- h. The radiation measurements are performed in X, Y, Z axis positioning for Transmitting mode, and found the X axis positioning which it is the worst case.
- i. Repeat above procedures until all frequencies measured was complete.

Remark:

- 1. Level= Read Level+ Cable Loss+ Antenna Factor- Preamp Factor
- 2. For emission below 1GHz, through the pre-scan found the worst case is the lowest channel of 802.11a. Only the worst case is recorded in the report.
- 3. Scan from 9kHz to 30MHz, the disturbance below 30MHz was very low. The points marked on above plots are the highest emissions could be found when testing, so only above points had been displayed. The amplitude of spurious emissions from the radiator which are attenuated more than 20dB below the limit need not be reported.



Unless otherwise agreed in writing, this document is issued by the Company subject to its General Conditions of Service printed overleaf, available on request or accessible at <http://www.sgs.com/en/Terms-and-Conditions.aspx> and, for electronic format documents, subject to Terms and Conditions for Electronic Documents at <http://www.sgs.com/en/Terms-and-Conditions/Terms-e-Documents.aspx>. Attention is drawn to the limitation of liability, indemnification and jurisdiction issues defined therein. Any holder of this document is advised that information contained hereon reflects the Company's findings at the time of its intervention only and within the limits of Client's instructions, if any. The Company's sole responsibility is to its Client and this document does not exonerate parties to a transaction from exercising all their rights and obligations under the transaction documents. This document cannot be reproduced except in full, without prior written approval of the Company. Any unauthorized alteration, forgery or falsification of the content or appearance of this document is unlawful and offenders may be prosecuted to the fullest extent of the law. Unless otherwise stated the results shown in this test report refer only to the sample(s) tested and such sample(s) are retained for 30 days only.
Attention: To check the authenticity of testing /inspection report & certificate, please contact us at telephone: (86-755) 8307 1443, or email: CN.Doccheck@sgs.com

Fuyong lab, Xinlong TechnoPark, Fengtang Road, Fuyong Subdistrict, Bao'an, Shenzhen, China 518103 t (86-755) 88663988 f (86-755) 26710594 www.sgsgroup.com.cn
 中国·深圳·宝安区福永街道凤塘大道鑫龙科技园福永实验室 邮编: 518103 t (86-755) 88663988 f (86-755) 26710594 sgs.china@sgs.com

Compliance Certification Services (Kunshan) Inc. Shenzhen Branch

SZCCS-TRF-01 Rev. A/0 Aug01,2022

Report No.: FYCR221100046605

Page: 191 of 344

Test Mode: 09; Polarity: Horizontal

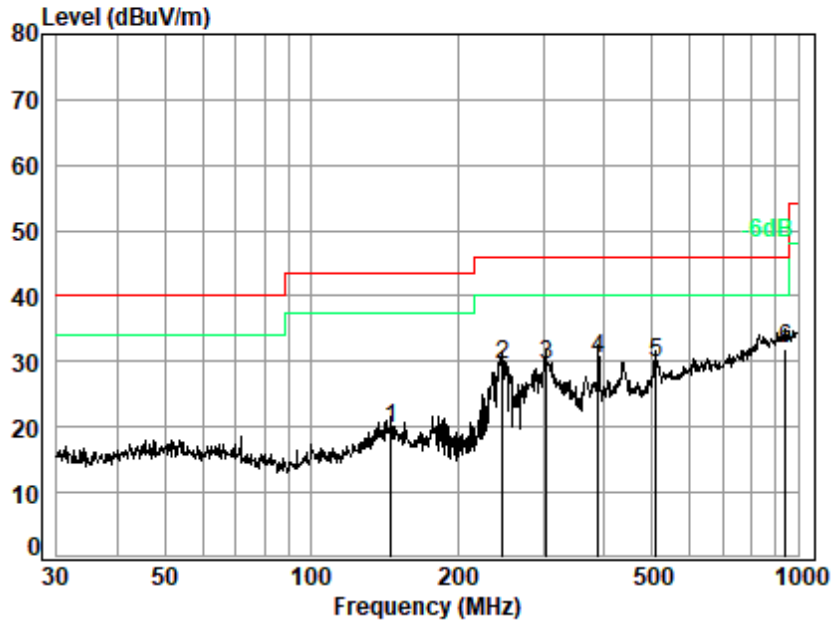

Site : chamber
 Condition: 3m HORIZONTAL
 Job No : 00466AT
 Mode : 09

	Freq	Cable Loss	Ant Factor	Preamp Factor	Read Level	Limit Level	Limit Line	Over Limit	Remark
	MHz	dB	dB/m	dB	dBuV	dBuV/m	dBuV/m	dB	
1	145.861	0.93	17.43	25.53	26.88	19.71	43.50	-23.79	QP
2	246.815	0.84	16.68	25.44	37.33	29.41	46.00	-16.59	QP
3	303.544	1.05	18.48	25.40	35.48	29.61	46.00	-16.39	QP
4	389.355	1.65	20.56	25.45	33.72	30.48	46.00	-15.52	QP
5	511.835	1.51	23.23	25.44	30.47	29.77	46.00	-16.23	QP
6	942.131	2.21	29.32	24.05	24.60	32.08	46.00	-13.92	QP



Unless otherwise agreed in writing, this document is issued by the Company subject to its General Conditions of Service printed overleaf, available on request or accessible at <http://www.sgs.com/en/Terms-and-Conditions.aspx> and, for electronic format documents, subject to Terms and Conditions for Electronic Documents at <http://www.sgs.com/en/Terms-and-Conditions/Terms-e-Documents.aspx>. Attention is drawn to the limitation of liability, indemnification and jurisdiction issues defined therein. Any holder of this document is advised that information contained hereon reflects the Company's findings at the time of its intervention only and within the limits of Client's instructions, if any. The Company's sole responsibility is to its Client and this document does not exonerate parties to a transaction from exercising all their rights and obligations under the transaction documents. This document cannot be reproduced except in full, without prior written approval of the Company. Any unauthorized alteration, forgery or falsification of the content or appearance of this document is unlawful and offenders may be prosecuted to the fullest extent of the law. Unless otherwise stated the results shown in this test report refer only to the sample(s) tested and such sample(s) are retained for 30 days only.
Attention: To check the authenticity of testing /inspection report & certificate, please contact us at telephone: (86-755) 8307 1443, or email: CN.Doccheck@sgs.com

Fuyong lab, Xinlong TechnoPark, Fengtang Road, Fuyong Subdistrict, Bao'an, Shenzhen, China 518103 t (86-755) 88663988 f (86-755) 26710594 www.sgsgroup.com.cn
 中国·深圳·宝安区福永街道凤塘大道鑫龙科技园福永实验室 邮编: 518103 t (86-755) 88663988 f (86-755) 26710594 sgs.china@sgs.com

Compliance Certification Services (Kunshan) Inc. Shenzhen Branch

SZCCS-TRF-01 Rev. A/0 Aug01,2022

Report No.: FYCR221100046605

Page: 192 of 344

Test Mode: 09; Polarity: Vertical

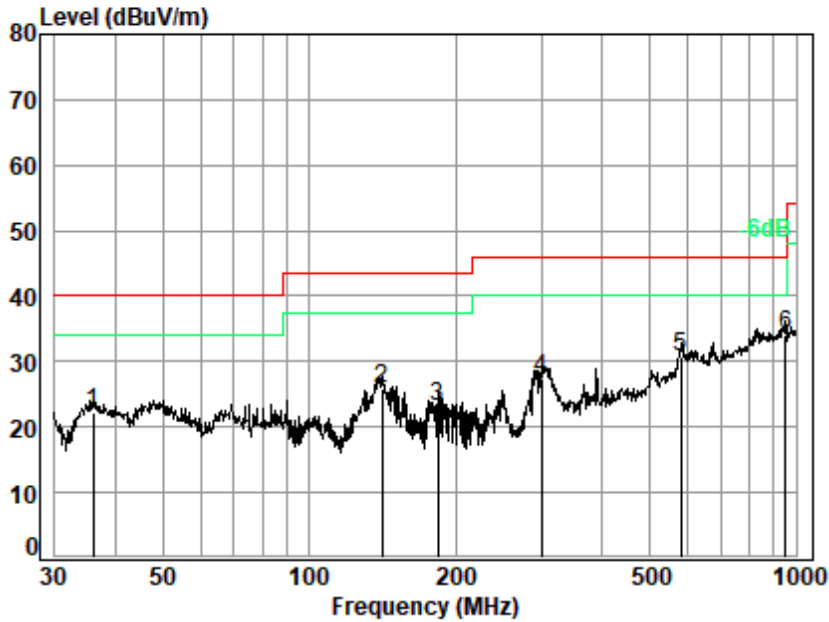

Site : chamber
 Condition: 3m VERTICAL
 Job No : 00466AT
 Mode : 09

	Freq	Cable Loss	Ant Factor	Preamp Factor	Read Level	Limit Level	Over Line	Over Limit	Remark
	MHz	dB	dB/m	dB	dBuV	dBuV/m	dBuV/m	dB	
1	36.001	0.19	15.88	26.02	32.11	22.16	40.00	-17.84	QP
2	140.835	0.96	17.44	25.54	32.93	25.79	43.50	-17.71	QP
3	183.844	0.67	15.91	25.49	32.09	23.18	43.50	-20.32	QP
4	300.367	1.01	18.34	25.40	33.47	27.42	46.00	-18.58	QP
5	578.670	2.10	23.94	25.10	29.92	30.86	46.00	-15.14	QP
6	952.094	2.21	29.27	24.04	26.75	34.19	46.00	-11.81	QP



Unless otherwise agreed in writing, this document is issued by the Company subject to its General Conditions of Service printed overleaf, available on request or accessible at <http://www.sgs.com/en/Terms-and-Conditions.aspx> and, for electronic format documents, subject to Terms and Conditions for Electronic Documents at <http://www.sgs.com/en/Terms-and-Conditions/Terms-e-Documents.aspx>. Attention is drawn to the limitation of liability, indemnification and jurisdiction issues defined therein. Any holder of this document is advised that information contained hereon reflects the Company's findings at the time of its intervention only and within the limits of Client's instructions, if any. The Company's sole responsibility is to its Client and this document does not exonerate parties to a transaction from exercising all their rights and obligations under the transaction documents. This document cannot be reproduced except in full, without prior written approval of the Company. Any unauthorized alteration, forgery or falsification of the content or appearance of this document is unlawful and offenders may be prosecuted to the fullest extent of the law. Unless otherwise stated the results shown in this test report refer only to the sample(s) tested and such sample(s) are retained for 30 days only.
Attention: To check the authenticity of testing /inspection report & certificate, please contact us at telephone: (86-755) 8307 1443, or email: CN.Doccheck@sgs.com

Fuyong lab, Xinlong TechnoPark, Fengtang Road, Fuyong Subdistrict, Bao'an, Shenzhen, China 518103 t (86-755) 88663988 f (86-755) 26710594 www.sgsgroup.com.cn
 中国·深圳·宝安区福永街道凤塘大道鑫龙科技园福永实验室 邮编: 518103 t (86-755) 88663988 f (86-755) 26710594 sgs.china@sgs.com

8 Test Setup Photo

Refer to Appendix - Test Setup Photo for FYCR2211000466AT

9 EUT Constructional Details (EUT Photos)

Refer to Appendix – External and Internal Photos for FYCR2211000466AT



Unless otherwise agreed in writing, this document is issued by the Company subject to its General Conditions of Service printed overleaf, available on request or accessible at <http://www.sgs.com/en/Terms-and-Conditions.aspx> and, for electronic format documents, subject to Terms and Conditions for Electronic Documents at <http://www.sgs.com/en/Terms-and-Conditions/Terms-e-Documents.aspx>. Attention is drawn to the limitation of liability, indemnification and jurisdiction issues defined therein. Any holder of this document is advised that information contained hereon reflects the Company's findings at the time of its intervention only and within the limits of Client's instructions, if any. The Company's sole responsibility is to its Client and this document does not exonerate parties to a transaction from exercising all their rights and obligations under the transaction documents. This document cannot be reproduced except in full, without prior written approval of the Company. Any unauthorized alteration, forgery or falsification of the content or appearance of this document is unlawful and offenders may be prosecuted to the fullest extent of the law. Unless otherwise stated the results shown in this test report refer only to the sample(s) tested and such sample(s) are retained for 30 days only.
Attention: To check the authenticity of testing /inspection report & certificate, please contact us at telephone: (86-755) 8307 1443, or email: CN.Doccheck@sgs.com

10 Appendix

1. Duty Cycle

1.1 Ant1

1.1.1 Test Result

Ant1							
Mode	TX Type	Frequency (MHz)	T_on (ms)	Period (ms)	Duty Cycle (%)	Duty Cycle Correction Factor (dB)	Max. DC Variation (%)
802.11a	SISO	5180	1.397	1.495	93.44	0.29	0.03
		5200	1.397	1.495	93.44	0.29	0.03
		5240	1.396	1.494	93.44	0.29	0.03
		5260	1.396	1.495	93.38	0.30	0.03
		5300	1.397	1.495	93.44	0.29	0.03
		5320	1.397	1.496	93.38	0.30	0.06
		5500	1.396	1.495	93.38	0.30	0.04
		5580	1.396	1.495	93.38	0.30	0.03
		5700	1.396	1.494	93.44	0.29	0.00
		5745	1.398	1.496	93.45	0.29	0.03
		5785	1.397	1.496	93.38	0.30	0.03
5825	1.397	1.495	93.44	0.29	0.03		
802.11n (HT20)	SISO	5180	1.309	1.407	93.03	0.31	0.03
		5200	1.309	1.407	93.03	0.31	0.00
		5240	1.309	1.407	93.03	0.31	0.03
		5260	1.308	1.407	92.96	0.32	0.03
		5300	1.308	1.407	92.96	0.32	0.00
		5320	1.309	1.407	93.03	0.31	0.03
		5500	1.309	1.407	93.03	0.31	0.00
		5580	1.309	1.407	93.03	0.31	0.00
		5700	1.309	1.407	93.03	0.31	0.03
		5745	1.308	1.407	92.96	0.32	0.03
		5785	1.308	1.407	92.96	0.32	0.03
5825	1.309	1.407	93.03	0.31	0.00		
802.11n (HT40)	SISO	5190	0.649	0.747	86.88	0.61	0.04
		5230	0.648	0.746	86.86	0.61	0.00
		5270	0.648	0.747	86.75	0.62	0.07



Unless otherwise agreed in writing, this document is issued by the Company subject to its General Conditions of Service printed overleaf, available on request or accessible at <http://www.sgs.com/en/Terms-and-Conditions.aspx> and, for electronic format documents, subject to Terms and Conditions for Electronic Documents at <http://www.sgs.com/en/Terms-and-Conditions/Terms-e-Documents.aspx>. Attention is drawn to the limitation of liability, indemnification and jurisdiction issues defined therein. Any holder of this document is advised that information contained hereon reflects the Company's findings at the time of its intervention only and within the limits of Client's instructions, if any. The Company's sole responsibility is to its Client and this document does not exonerate parties to a transaction from exercising all their rights and obligations under the transaction documents. This document cannot be reproduced except in full, without prior written approval of the Company. Any unauthorized alteration, forgery or falsification of the content or appearance of this document is unlawful and offenders may be prosecuted to the fullest extent of the law. Unless otherwise stated the results shown in this test report refer only to the sample(s) tested and such sample(s) are retained for 30 days only.
Attention: To check the authenticity of testing /inspection report & certificate, please contact us at telephone: (86-755) 8307 1443, or email: CN.Doccheck@sgs.com

Fuyong lab, Xinlong TechnoPark, Fengtang Road, Fuyong Subdistrict, Bao'an, Shenzhen, China 518103 t (86-755) 88663988 f (86-755) 26710594 www.sgs.com.cn
 中国·深圳·宝安区福永街道凤塘大道鑫龙科技园福永实验室 邮编: 518103 t (86-755) 88663988 f (86-755) 26710594 sgs.china@sgs.com

Compliance Certification Services (Kunshan) Inc. Shenzhen Branch

SZCCS-TRF-01 Rev. A/0 Aug01,2022

Report No.: FYCR221100046605

Page: 195 of 344

		5310	0.649	0.747	86.88	0.61	0.04
		5510	0.648	0.747	86.75	0.62	0.04
		5550	0.648	0.747	86.75	0.62	0.04
		5670	0.648	0.747	86.75	0.62	0.04
		5755	0.649	0.747	86.88	0.61	0.04
		5795	0.649	0.747	86.88	0.61	0.04
802.11ac (VHT20)	SISO	5180	1.317	1.415	93.07	0.31	0.00
		5200	1.316	1.415	93.00	0.32	0.03
		5240	1.317	1.415	93.07	0.31	0.03
		5260	1.316	1.414	93.07	0.31	0.03
		5300	1.317	1.415	93.07	0.31	0.03
		5320	1.317	1.415	93.07	0.31	0.00
		5500	1.317	1.415	93.07	0.31	0.03
		5580	1.316	1.415	93.00	0.32	0.03
		5700	1.317	1.415	93.07	0.31	0.03
		5745	1.317	1.415	93.07	0.31	0.00
		5785	1.316	1.415	93.00	0.32	0.04
5825	1.316	1.415	93.00	0.32	0.04		
802.11ac (VHT40)	SISO	5190	0.657	0.755	87.02	0.60	0.04
		5230	0.656	0.754	87.00	0.60	0.04
		5270	0.657	0.755	87.02	0.60	0.04
		5310	0.656	0.755	86.89	0.61	0.04
		5510	0.657	0.755	87.02	0.60	0.04
		5550	0.656	0.755	86.89	0.61	0.04
		5670	0.657	0.755	87.02	0.60	0.04
		5755	0.657	0.755	87.02	0.60	0.04
5795	0.657	0.780	84.23	0.75	2.80		
802.11ac (VHT80)	SISO	5210	0.324	0.422	76.78	1.15	0.03
		5290	0.324	0.422	76.78	1.15	0.03
		5530	0.325	0.422	77.01	1.13	0.06
		5610	0.325	0.422	77.01	1.13	0.02
		5775	0.325	0.422	77.01	1.13	0.04



Unless otherwise agreed in writing, this document is issued by the Company subject to its General Conditions of Service printed overleaf, available on request or accessible at <http://www.sgs.com/en/Terms-and-Conditions.aspx> and, for electronic format documents, subject to Terms and Conditions for Electronic Documents at <http://www.sgs.com/en/Terms-and-Conditions/Terms-e-Documents.aspx>. Attention is drawn to the limitation of liability, indemnification and jurisdiction issues defined therein. Any holder of this document is advised that information contained hereon reflects the Company's findings at the time of its intervention only and within the limits of Client's instructions, if any. The Company's sole responsibility is to its Client and this document does not exonerate parties to a transaction from exercising all their rights and obligations under the transaction documents. This document cannot be reproduced except in full, without prior written approval of the Company. Any unauthorized alteration, forgery or falsification of the content or appearance of this document is unlawful and offenders may be prosecuted to the fullest extent of the law. Unless otherwise stated the results shown in this test report refer only to the sample(s) tested and such sample(s) are retained for 30 days only.
Attention: To check the authenticity of testing/inspection report & certificate, please contact us at telephone: (86-755) 8307 1443, or email: CN.Doccheck@sgs.com

Fuyong lab, Xinlong TechnoPark, Fengtang Road, Fuyong Subdistrict, Bao'an, Shenzhen, China 518103 t (86-755) 88663988 f (86-755) 26710594 www.sgs.com.cn
 中国·深圳·宝安区福永街道凤塘大道鑫龙科技园福永实验室 邮编: 518103 t (86-755) 88663988 f (86-755) 26710594 sgs.china@sgs.com

1.1.2 Test Graph

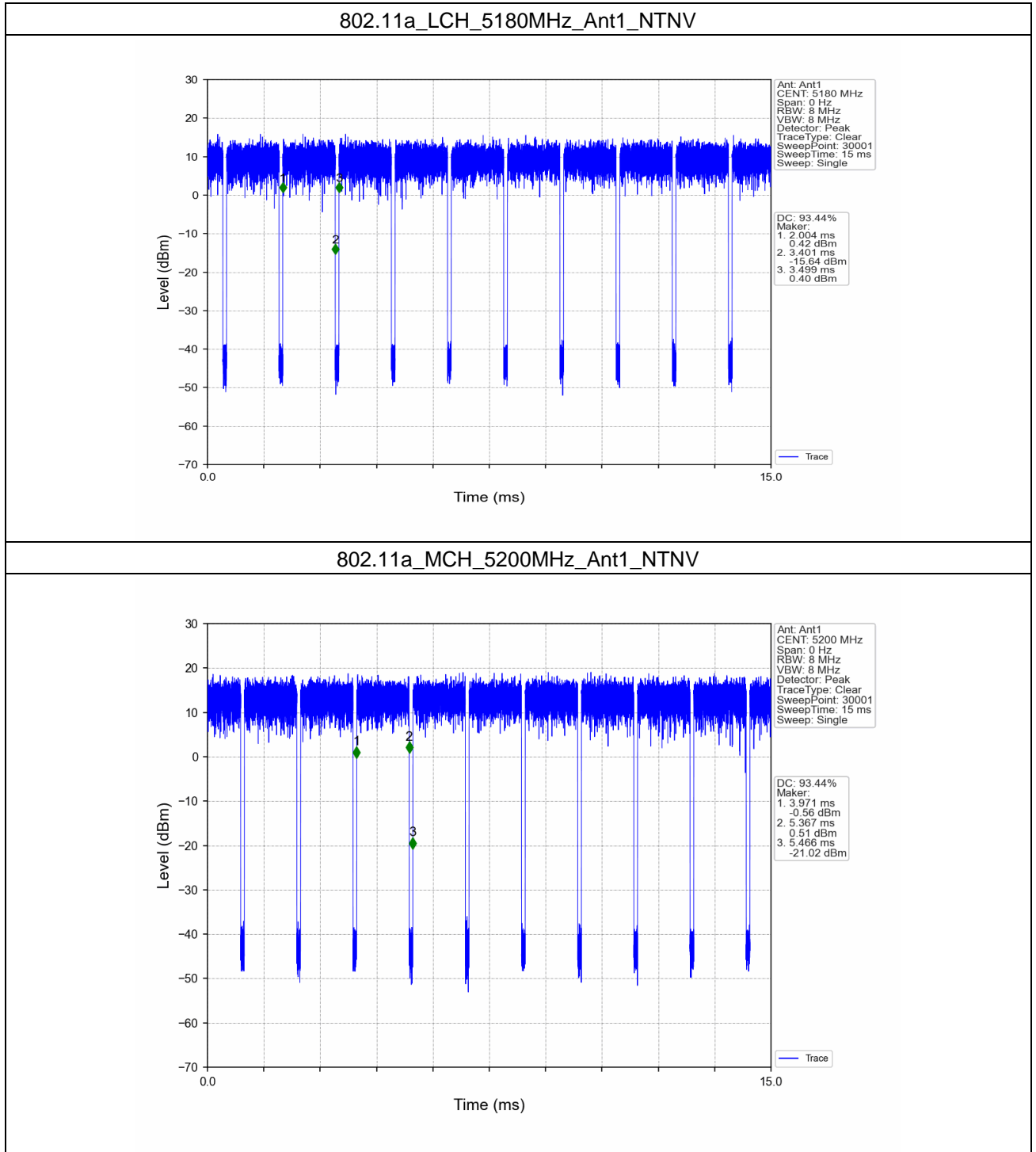

Unless otherwise agreed in writing, this document is issued by the Company subject to its General Conditions of Service printed overleaf, available on request or accessible at <http://www.sgs.com/en/Terms-and-Conditions.aspx> and, for electronic format documents, subject to Terms and Conditions for Electronic Documents at <http://www.sgs.com/en/Terms-and-Conditions/Terms-e-Documents.aspx>. Attention is drawn to the limitation of liability, indemnification and jurisdiction issues defined therein. Any holder of this document is advised that information contained hereon reflects the Company's findings at the time of its intervention only and within the limits of Client's instructions, if any. The Company's sole responsibility is to its Client and this document does not exonerate parties to a transaction from exercising all their rights and obligations under the transaction documents. This document cannot be reproduced except in full, without prior written approval of the Company. Any unauthorized alteration, forgery or falsification of the content or appearance of this document is unlawful and offenders may be prosecuted to the fullest extent of the law. Unless otherwise stated the results shown in this test report refer only to the sample(s) tested and such sample(s) are retained for 30 days only.

Attention: To check the authenticity of testing /inspection report & certificate, please contact us at telephone: (86-755) 8307 1443, or email: CN.Doccheck@sgs.com

Fuyong lab, Xinlong TechnoPark, Fengtang Road, Fuyong Subdistrict, Bao'an, Shenzhen, China 518103 t (86-755) 88663988 f (86-755) 26710594 www.sgs.com.cn
 中国·深圳·宝安区福永街道凤塘大道鑫龙科技园福永实验室 邮编: 518103 t (86-755) 88663988 f (86-755) 26710594 sgs.china@sgs.com