



SAR EVALUATION REPORT

For

Vanstone Electronic (Beijing) Co.,Ltd.

Room 4-18, No.25, Landianchang South Road, Haidian, Beijing, 100097, China

FCC ID: OWLA90

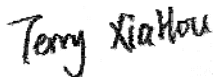
Report Type: Original Report	Product Type: Smart POS Terminal
Report Number: <u>RGMA181217002-SA</u>	
Report Date: <u>2019-03-21</u>	
Reviewed By: <u>SAR Engineer</u> Terry XiaHou 	
Prepared By: Bay Area Compliance Laboratories Corp. (Shenzhen) 6/F., West Wing, Third Phase of Wanli Industrial Building, Shihua Road, Futian Free Trade Zone, Shenzhen, Guangdong, China Tel: +86-755-33320018 Fax: +86-755-33320008 www.baclcorp.com.cn	

Note: This report must not be used by the customer to claim product certification, approval, or endorsement by A2LA* or any agency of the Federal Government. * This report may contain data that are not covered by the A2LA accreditation and are marked with an asterisk “*”.

Attestation of Test Results				
EUT Information		EUT Description	Smart POS Terminal	
		Tested Model	A90	
		FCC ID	OWLA90	
		Serial Number	18121700201	
		Test Date	2019/03/05 to 2019/03/07	
MODE			Max. SAR Level(s) Reported(W/kg)	Limit (W/kg)
Body Supported	WCDMA Band 2	1g Body SAR	0.90	1.6
	WCDMA Band 4	1g Body SAR	0.96	
	WCDMA Band 5	1g Body SAR	0.27	
	LTE Band 2	1g Body SAR	0.79	
	LTE Band 4	1g Body SAR	0.80	
	LTE Band 5	1g Body SAR	0.46	
	LTE Band 7	1g Body SAR	1.38	
	LTE Band 12	1g Body SAR	0.27	
	LTE Band 13	1g Body SAR	0.33	
	LTE Band 17	1g Body SAR	0.30	
	Buletooth	1g Body SAR	0.18	
	2.4G WLAN	1g Body SAR	0.14	
	Simultaneous	1g Body SAR	1.56	

Handheld	WCDMA Band 2	10g SAR	0.07	4.0
	WCDMA Band 4	10g SAR	0.09	
	WCDMA Band 5	10g SAR	0.08	
	LTE Band 2	10g SAR	0.10	
	LTE Band 4	10g SAR	0.17	
	LTE Band 5	10g SAR	0.19	
	LTE Band 7	10g SAR	0.08	
	LTE Band 12	10g SAR	0.17	
	LTE Band 13	10g SAR	0.28	
	LTE Band 17	10g SAR	0.15	
Simultaneous	10g SAR	0.45		

Applicable Standards	FCC 47 CFR part 2.1093 Radiofrequency radiation exposure evaluation: portable devices
	IEEE1528:2013 IEEE Recommended Practice for Determining the Peak Spatial-Average Specific Absorption Rate (SAR) in the Human Head from Wireless Communications Devices: Measurement Techniques
	ANSI / IEEE C95.1 : 2005 IEEE Standard for Safety Levels with Respect to Human Exposure to Radio Frequency Electromagnetic Fields,3 kHz to 300 GHz.
	ANSI / IEEE C95.3 : 2002 IEEE Recommended Practice for Measurements and Computations of Radio Frequency Electromagnetic Fields With Respect to Human Exposure to Such Fields,100 kHz—300 GHz.
	IEC 62209-2:2010 Human exposure to radio frequency fields from hand-held and body-mounted wireless communication devices-Human models, instrumentation, and procedures-Part 2: Procedure to determine the specific absorption rate (SAR) for wireless communication devices used in close proximity to the human body (frequency range of 30 MHz to 6 GHz)
	KDB procedures KDB 447498 D01 General RF Exposure Guidance v06 KDB 648474 D04 Handset SAR v01r03 KDB 865664 D01 SAR Measurement 100 MHz to 6 GHz v01r04 KDB 865664 D02 RF Exposure Reporting v01r02 KDB 941225 D01 3G SAR Procedures v03r01 KDB 941225 D05 SAR for LTE Devices v02r05 KDB 941225 D06 Hotspot Mode v02r01
Note: This wireless device has been shown to be capable of compliance for localized specific absorption rate (SAR) for General Population/Uncontrolled Exposure limits specified in FCC 47 CFR part 2.1093 and has been tested in accordance with the measurement procedures specified in IEEE 1528-2013 and RF exposure KDB procedures. The results and statements contained in this report pertain only to the device(s) evaluated.	

TABLE OF CONTENTS

DOCUMENT REVISION HISTORY	5
EUT DESCRIPTION	6
TECHNICAL SPECIFICATION.....	6
REFERENCE, STANDARDS, AND GUIDELINES	7
SAR LIMITS	8
FACILITIES	9
DESCRIPTION OF TEST SYSTEM	10
EQUIPMENT LIST AND CALIBRATION	16
EQUIPMENTS LIST & CALIBRATION INFORMATION	16
SAR MEASUREMENT SYSTEM VERIFICATION	17
LIQUID VERIFICATION.....	17
SYSTEM ACCURACY VERIFICATION	19
SAR SYSTEM VALIDATION DATA	20
EUT TEST STRATEGY AND METHODOLOGY	26
TEST POSITIONS FOR BODY-WORN AND OTHER CONFIGURATIONS	26
TEST DISTANCE FOR SAR EVALUATION	27
SAR EVALUATION PROCEDURE	28
CONDUCTED OUTPUT POWER MEASUREMENT	29
PROVISION APPLICABLE.....	29
TEST PROCEDURE.....	29
RADIO CONFIGURATION.....	29
MAXIMUM TARGET OUTPUT POWER.....	33
TEST RESULTS:.....	34
STANDALONE SAR TEST EXCLUSION CONSIDERATIONS	51
ANTENNA DISTANCE TO EDGE.....	51
SAR TEST EXCLUSION FOR THE EUT EDGE CONSIDERATIONS RESULT.....	52
SAR MEASUREMENT RESULTS	53
SAR TEST DATA	53
SAR MEASUREMENT VARIABILITY	64
SAR SIMULTANEOUS TRANSMISSION DESCRIPTION	65
SAR PLOTS	68
APPENDIX A MEASUREMENT UNCERTAINTY	69
APPENDIX B EUT TEST POSITION PHOTOS	71
APPENDIX C PROBE CALIBRATION CERTIFICATES	72
APPENDIX D DIPOLE CALIBRATION CERTIFICATES	73

DOCUMENT REVISION HISTORY

Revision Number	Report Number	Description of Revision	Date of Revision
1.0	RGMA181217002-SA	Original Report	2019-03-21

EUT DESCRIPTION

This report has been prepared on behalf of **Vanstone Electronic (Beijing) Co.,Ltd.** and their product **Smart POS Terminal**, Model: **A90**, FCC ID: **OWLA90** or the EUT (Equipment under Test) as referred to in the rest of this report.

**All measurement and test data in this report was gathered from production sample serial number: 18121700201 (Assigned by BACL, Shenzhen).The EUT supplied by the applicant was received on 2018-12-17.*

Technical Specification

Device Type:	Portable
Exposure Category:	Population / Uncontrolled
Antenna Type(s):	Internal Antenna
Proximity sensor for SAR reduction:	None
Body-Worn Accessories:	Headset
Face-Head Accessories:	None
Operation Mode :	WCDMA(R99 (Data), HSDPA/HSUPA), FDD-LTE, WLAN, Bluetooth
Frequency Band:	WCDMA Band 2: 1850-1910 MHz(TX); 1930-1990 MHz(RX) WCDMA Band 4: 1710-1755 MHz(TX) ; 2110-2155 MHz(RX) WCDMA Band 5: 824-849 MHz(TX); 869-894 MHz(RX) LTE Band 2: 1850-1910 MHz(TX); 1930-1990 MHz(RX) LTE Band 4: 1710-1755 MHz(TX) ; 2110-2155 MHz(RX) LTE Band 5: 824-849 MHz(TX); 869-894 MHz(RX) LTE Band 7: 2500-2570 MHz(TX); 2620-2690 MHz(RX) LTE Band 12: 699-716 MHz(TX) ; 729-746 MHz(RX) LTE Band 13: 777-787 MHz(TX); 746-756z(RX) LTE Band 17: 704-716 MHz(TX) ; 734-746 MHz(RX) WLAN: 2412 -2462 MHz Bluetooth : 2402 -2480 MHz
Conducted RF Power:	WCDMA Band 2: 22.40 dBm WCDMA Band 4: 22.37 dBm WCDMA Band 5: 22.41 dBm LTE Band 2: 23.04 dBm LTE Band 4: 22.87 dBm LTE Band 5: 22.95 dBm LTE Band 7 23.96 dBm LTE Band 12: 23.30 dBm LTE Band 13 23.20 dBm LTE Band 17: 23.11 dBm WLAN: 9.66 dBm Bluetooth(BDR/EDR): 8.06 dBm BLE: -0.92 dBm
Power Source:	3.8 V _{DC} Rechargeable Battery
Normal Operation:	Body Supported and Hand-held

REFERENCE, STANDARDS, AND GUIDELINES

FCC:

The Report and Order requires routine SAR evaluation prior to equipment authorization of portable transmitter devices, including portable telephones. For consumer products, the applicable limit is 1.6 mW/g as recommended by the ANSI/IEEE standard C95.1-1992 [6] for an uncontrolled environment (Paragraph 65). According to the Supplement C of OET Bulletin 65 "Evaluating Compliance with FCC Guide-lines for Human Exposure to Radio frequency Electromagnetic Fields", released on Jun 29, 2001 by the FCC, the device should be evaluated at maximum output power (radiated from the antenna) under "worst-case" conditions for normal or intended use, incorporating normal antenna operating positions, device peak performance frequencies and positions for maximum RF energy coupling.

This report describes the methodology and results of experiments performed on wireless data terminal. The objective was to determine if there is RF radiation and if radiation is found, what is the extent of radiation with respect to safety limits. SAR (Specific Absorption Rate) is the measure of RF exposure determined by the amount of RF energy absorbed by human body (or its parts) – to determine how the RF energy couples to the body or head which is a primary health concern for body worn devices. The limit below which the exposure to RF is considered safe by regulatory bodies in North America is 1.6 mW/g average over 1 gram of tissue mass.

CE:

The order requires routine SAR evaluation prior to equipment authorization of portable transmitter devices, including portable telephones. For consumer products, the applicable limit is 2 mW/g as recommended by EN62209-1 for an uncontrolled environment. According to the Standard, the device should be evaluated at maximum output power (radiated from the antenna) under "worst-case" conditions for normal or intended use, incorporating normal antenna operating positions, device peak performance frequencies and positions for maximum RF energy coupling.

This report describes the methodology and results of experiments performed on wireless data terminal. The objective was to determine if there is RF radiation and if radiation is found, what is the extent of radiation with respect to safety limits. SAR (Specific Absorption Rate) is the measure of RF exposure determined by the amount of RF energy absorbed by human body (or its parts) – to determine how the RF energy couples to the body or head which is a primary health concern for body worn devices. The limit below which the exposure to RF is considered safe by regulatory bodies in Europe is 2 mW/g average over 10 gram of tissue mass.

The test configurations were laid out on a specially designed test fixture to ensure the reproducibility of measurements. Each configuration was scanned for SAR. Analysis of each scan was carried out to characterize the above effects in the device.

SAR Limits

FCC Limit

EXPOSURE LIMITS	SAR (W/kg)	
	(General Population / Uncontrolled Exposure Environment)	(Occupational / Controlled Exposure Environment)
Spatial Average (averaged over the whole body)	0.08	0.4
Spatial Peak (averaged over any 1 g of tissue)	1.60	8.0
Spatial Peak (hands/wrists/feet/ankles averaged over 10 g)	4.0	20.0

CE Limit

EXPOSURE LIMITS	SAR (W/kg)	
	(General Population / Uncontrolled Exposure Environment)	(Occupational / Controlled Exposure Environment)
Spatial Average (averaged over the whole body)	0.08	0.4
Spatial Peak (averaged over any 10 g of tissue)	2.0	10
Spatial Peak (hands/wrists/feet/ankles averaged over 10 g)	4.0	20.0

Population/Uncontrolled Environments are defined as locations where there is the exposure of individual who have no knowledge or control of their exposure.

Occupational/Controlled Environments are defined as locations where there is exposure that may be incurred by people who are aware of the potential for exposure (i.e. as a result of employment or occupation).

General Population/Uncontrolled environments Spatial Peak limit 1.6W/kg (FCC) & 2 W/kg (CE) applied to the EUT.

FACILITIES

The test site used by Bay Area Compliance Laboratories Corp. (Shenzhen) to collect data is located at 6/F., West Wing, Third Phase of Wanli Industrial Building, Shihua Road, Futian Free Trade Zone, Shenzhen, Guangdong, China.

The test site has been approved by the FCC under the KDB 974614 D01 and is listed in the FCC Public Access Link (PAL) database, FCC Registration No.: 342867, the FCC Designation No.: CN1221.

The test site has been registered with ISED Canada under ISED Canada Registration Number 3062B.

DESCRIPTION OF TEST SYSTEM

These measurements were performed with the automated near-field scanning system DASY6 from Schmid & Partner Engineering AG (SPEAG) which is the Fifth generation of the system shown in the figure hereinafter:

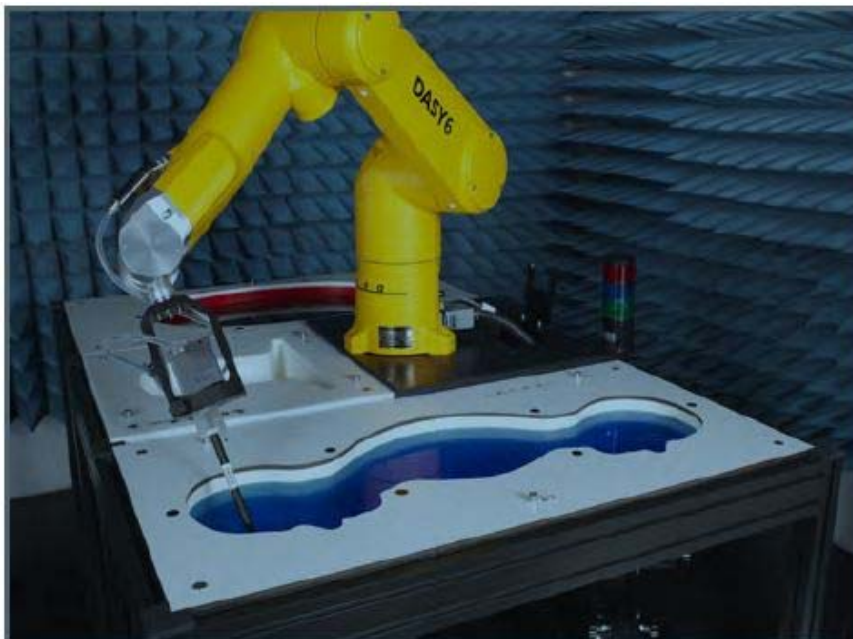

DASY6 System Description

The DASY6 system for performing compliance tests consists of the following items:

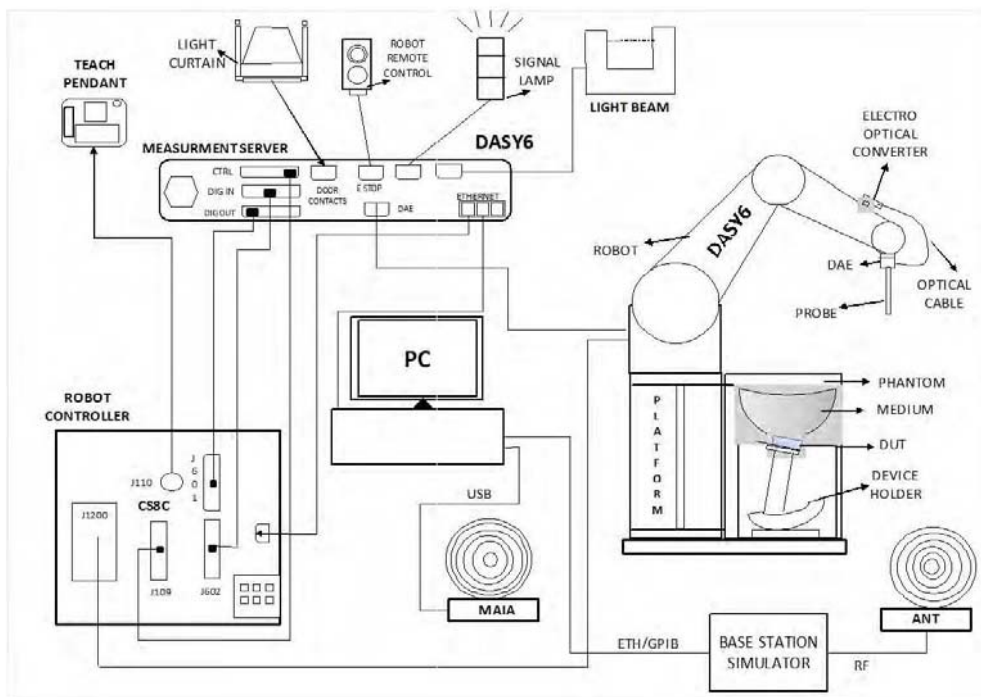

- A standard high precision 6-axis robot (Staubli TX=RX family) with controller, teach pendant and software. An arm extension for accommodating the data acquisition electronics (DAE).
- An isotropic field probe optimized and calibrated for the targeted measurement.
- A data acquisition electronics (DAE) which performs the signal application, signal multiplexing, AD-conversion, offset measurements, mechanical surface detection, collision detection, etc. The unit is battery powered with standard or rechargeable batteries. The signal is optically transmitted to the EOC.
- The Electro-optical converter (EOC) performs the conversion from optical to electrical signals for the digital communication to the DAE. To use optical surface detection, a special version of the EOC is required. The EOC signal is transmitted to the measurement server.
- The function of the measurement server is to perform the time critical tasks such as signal filtering, control of the robot operation and fast movement interrupts.
- The Light Beam used is for probe alignment. This improves the (absolute) accuracy of the probe positioning.
- A computer running Win7 professional operating system and the DASY52 software.
- Remote control and teach pendant as well as additional circuitry for robot safety such as warning lamps, etc.
- The phantom, the device holder and other accessories according to the targeted measurement.

DASY6 Measurement Server

The DASY6 measurement server is based on a PC/104 CPU board with a 400 MHz Intel ULV Celeron, 128 MB chip-disk and 128 MB RAM. The necessary circuits for communication with the DAE4 (or DAE3) electronics box, as well as the 16-bit AD converter system for optical detection and digital I/O interface are contained on the DASY6 I/O board, which is directly connected to the PC/104 bus of the CPU board.



The measurement server performs all real-time data evaluations of field measurements and surface detection, controls robot movements, and handles safety operations. The PC operating system cannot interfere with these time-critical processes. All connections are supervised by a watchdog, and disconnection of any of the cables to the measurement server will automatically disarm the robot and disable all program-controlled robot movements. Furthermore, the measurement server is equipped with an expansion port, which is reserved for future applications. Please note that this expansion port does not have a standardized pinout, and therefore only devices provided by SPEAG can be connected. Connection of devices from any other supplier could seriously damage the measurement server.

Data Acquisition Electronics

The data acquisition electronics (DAE4) consist of a highly sensitive electrometer-grade preamplifier with auto-zeroing, a channel and gain-switching multiplexer, a fast 16 bit AD-converter and a command decoder with a control logic unit. Transmission to the measurement server is accomplished through an optical downlink for data and status information, as well as an optical uplink for commands and the clock.

The mechanical probe mounting device includes two different sensor systems for frontal and sideways probe contacts. They are used for mechanical surface detection and probe collision detection.

The input impedance of both the DAE4 as well as of the DAE3 box is 200M Ω ; the inputs are symmetrical and floating. Common mode rejection is above 80 dB.

EX3DV4 E-Field Probes

Frequency	10 MHz to > 6 GHz Linearity: ± 0.2 dB (30 MHz to 6 GHz)
Directivity	± 0.3 dB in TSL (rotation around probe axis) ± 0.5 dB in TSL (rotation normal to probe axis)
Dynamic Range	10 µW/g to > 100 mW/g Linearity: ± 0.2 dB (noise: typically < 1 µW/g)
Dimensions	Overall length: 337 mm (Tip: 20 mm) Tip diameter: 2.5 mm (Body: 12 mm) Typical distance from probe tip to dipole centers: 1 mm
Application	High precision dosimetric measurements in any exposure scenario (e.g., very strong gradient fields); the only probe that enables compliance testing for frequencies up to 6 GHz with precision of better 30%.
Compatibility	DASY3, DASY4, DASY52 SAR and higher, EASY4/MRI

SAM Twin Phantom

The SAM Twin Phantom (shown in front of DASY6) is a fiberglass shell phantom with shell thickness 2 mm, except in the ear region where the thickness is increased to 6 mm. The phantom has three measurement areas: 1) Left Head, 2) Right Head, and 3) Flat Section. For larger devices, the use of the ELI-Phantom (shown behind DASY6) is required. For devices such as glasses with a wireless link, the Face Down Phantom is the most suitable (between the SAM Twin and ELI phantoms).

When the phantom is mounted inside allocated slot of the DASY6 platform, phantom reference points can be taught directly in the DASY5 V5.2 software. When the DASY6 platform is used to mount the

Phantom, some of the phantom teaching points cannot be reached by the robot in DASY5 V5.2. A special tool called P1a-P2aX-Former is provided to transform two of the three points, P1 and P2, to reachable locations. To use these new teaching points, a revised phantom configuration file is required.

In addition to our standard broadband liquids, the phantom can be used with the following tissue simulating liquids:

Sugar-water-based liquids can be left permanently in the phantom. Always cover the liquid when the system is not in use to prevent changes in liquid parameters due to water evaporation.

DGBE-based liquids should be used with care. As DGBE is a softener for most plastics, the liquid should be taken out of the phantom, and the phantom should be dried when the system is not in use (desirable at least once a week).

Do not use other organic solvents without previously testing the solvent resistivity of the phantom. Approximately 25 liters of liquid is required to fill the SAM Twin phantom.

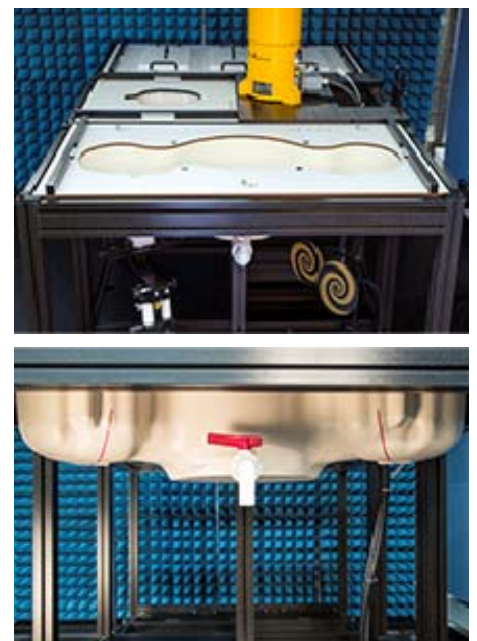

ELI Phantom

The ELI phantom is intended for compliance testing of handheld and body-mounted wireless devices in the frequency range of 30MHz to 6 GHz. ELI is fully compatible with the latest draft of the standard IEC 62209-2 and the use of all known tissue simulating liquids. ELI has been optimized for performance and can be integrated into a SPEAG standard phantom table. A cover is provided to prevent evaporation of water and changes in liquid parameters. Reference markings on the phantom allow installation of the complete setup, including all predefined phantom positions and measurement grids, by teaching three points.

The phantom can be used with the following tissue simulating liquids:

- Sugar-water-based liquids can be left permanently in the phantom. Always cover the liquid when the system is not in use to prevent changes in liquid parameters due to water evaporation.
- DGBE-based liquids should be used with care. As DGBE is a softener for most plastics, the liquid should be taken out of the phantom, and the phantom should be dried when the system is not in use (desirable at least once a week).
- Do not use other organic solvents without previously testing the solvent resistivity of the phantom.

Approximately 25 liters of liquid is required to fill the ELI phantom.

Robots

The DASY6 system uses the high-precision industrial robots TX60L, TX90XL, and RX160L from Staubli SA (France). The TX robot family - the successor of the well-known RX robot family - continues to offer the features important for DASY6 applications:

- High precision (repeatability 0.02mm)
- High reliability (industrial design)
- Low maintenance costs (virtually maintenance free due to direct drive gears; no belt drives)
- Jerk-free straight movements (brushless synchrony motors; no stepper motors)
- Low ELF interference (motor control fields shielded via the closed metallic construction shields)

The robots are controlled by the Staubli CS8c robot controllers. All information regarding the use and maintenance of the robot arm and the robot controller is provided

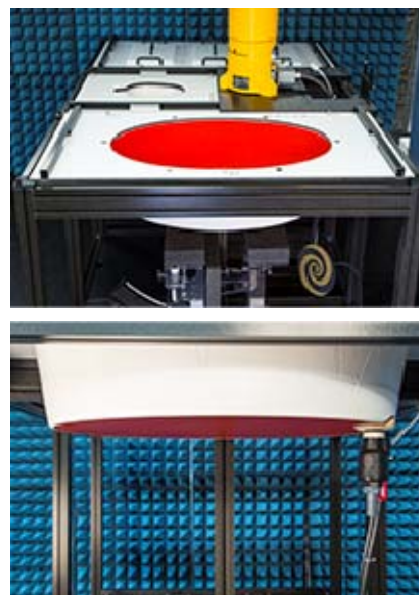

Calibration Frequency Points for EX3DV4 E-Field Probes SN: 7522 Calibrated: 2018/11/02

Calibration Frequency Point(MHz)	Frequency Range(MHz)		Conversion Factor		
	From	To	X	Y	Z
750 Head	650	800	9.78	9.78	9.78
750 Body	650	800	9.8	9.8	9.8
850 Head	800	950	9.46	9.46	9.46
850 Body	800	950	9.54	9.54	9.54
1750 Head	1650	1810	8.2	8.2	8.2
1750 Body	1650	1810	7.88	7.88	7.88
1900 Head	1810	1920	7.91	7.91	7.91
1900 Body	1810	1920	7.48	7.48	7.48
2000 Head	1920	2100	7.78	7.78	7.78
2000 Body	1920	2100	7.36	7.36	7.36
2300 Head	2200	2399	7.35	7.35	7.35
2300 Body	2200	2399	7.27	7.27	7.27
2450 Head	2399	2500	6.97	6.97	6.97
2450 Body	2399	2500	7.05	7.05	7.05
2600 Head	2500	2700	6.79	6.79	6.79
2600 Body	2500	2700	6.95	6.95	6.95
5250 Head	5140	5360	5.05	5.05	5.05
5250 Body	5140	5360	4.77	4.77	4.77
5600 Head	5490	5700	4.48	4.48	4.48
5600 Body	5490	5700	4.27	4.27	4.27
5800 Head	5700	5910	4.76	4.76	4.76
5800 Body	5700	5910	4.31	4.31	4.31

Area Scans

Area scans are defined prior to the measurement process being executed with a user defined variable spacing between each measurement point (integral) allowing low uncertainty measurements to be conducted. Scans defined for FCC applications utilize a 15mm 2 step integral, with 1.5mm interpolation used to locate the peak SAR area used for zoom scan assessments.

Where the system identifies multiple SAR peaks (which are within 25% of peak value) the system will provide the user with the option of assessing each peak location individually for zoom scan averaging.

Zoom Scan (Cube Scan Averaging)

The averaging zoom scan volume utilized in the DASY5 software is in the shape of a cube and the side dimension of a 1 g or 10 g mass is dependent on the density of the liquid representing the simulated tissue. A density of 1000 kg/m^3 is used to represent the head and body tissue density and not the phantom liquid density, in order to be consistent with the definition of the liquid dielectric properties, i.e. the side length of the 1g cube is 10mm, with the side length of the 10g cube is 21.5mm.

When the cube intersects with the surface of the phantom, it is oriented so that 3 vertices touch the surface of the shell or the center of a face is tangent to the surface. The face of the cube closest to the surface is modified in order to conform to the tangent surface.

The zoom scan integer steps can be user defined so as to reduce uncertainty, but normal practice for typical test applications (including FCC) utilize a physical step of $7 \times 7 \times 7$ (5mmx5mmx5mm) providing a volume of 30 mm in the X & Y & Z axis.

Tissue Dielectric Parameters for Head and Body Phantoms

The head tissue dielectric parameters recommended by the IEEE SCC-34/SC-2 in P1528 have been incorporated in the following table. These head parameters are derived from planar layer models simulating the highest expected SAR for the dielectric properties and tissue thickness variations in a human head. Other head and body tissue parameters that have not been specified in P1528 are derived from the tissue dielectric parameters computed from the 4-Cole-Cole equations described in Reference [12] and extrapolated according to the head parameters specified in P1528.

Recommended Tissue Dielectric Parameters for Head and Body

Frequency (MHz)	Head Tissue		Body Tissue	
	ϵ_r	σ (S/m)	ϵ_r	σ (S/m)
150	52.3	0.76	61.9	0.80
300	45.3	0.87	58.2	0.92
450	43.5	0.87	56.7	0.94
835	41.5	0.90	55.2	0.97
900	41.5	0.97	55.0	1.05
915	41.5	0.98	55.0	1.06
1450	40.5	1.20	54.0	1.30
1610	40.3	1.29	53.8	1.40
1800-2000	40.0	1.40	53.3	1.52
2450	39.2	1.80	52.7	1.95
3000	38.5	2.40	52.0	2.73
5800	35.3	5.27	48.2	6.00

EQUIPMENT LIST AND CALIBRATION

Equipments List & Calibration Information

Equipment	Model	S/N	Calibration Date	Calibration Due Date
DASY5 Test Software	DASY52 52.10.2	N/A	NCR	NCR
DASY6 Measurement Server	DASY6 6.0.31	N/A	NCR	NCR
Data Acquisition Electronics	DAE4	1562	2018/11/6	2019/11/6
E-Field Probe	EX3DV4	7522	2018/11/2	2019/11/2
Mounting Device	MD4HHTV5	SD 000 H01 KA	NCR	NCR
SAM Twin Phantom	SAM-Twin V8.0	1962	NCR	NCR
ELI Phantom	ELI V8.0	2092	NCR	NCR
Dipole, 750MHz	ALS-D-750-S-2	177-00505	2016/10/26	2019/10/26
Dipole, 835MHz	D835V2	445	2016/10/26	2019/10/26
Dipole, 1750MHz	ALS-D-1750-S-2	198-00304	2016/10/04	2019/10/04
Dipole, 1900MHz	ALS-D-1900-S-2	210-00710	2017/09/20	2020/09/20
Dipole, 2450MHz	D2450V2	751	2017/10/12	2020/10/12
Dipole, 2600MHz	D2600V2	1073	2016/12/19	2019/12/19
Simulated Tissue Liquid Head	HBBL600-10000V6	180622-2	Each Time	
Simulated Tissue Liquid Body	MBBL600-6000V6	180611-1	Each Time	
Network Analyzer	8753D	3410A08288	2018/04/25	2019/04/25
Dielectric Assessment Kit	DAK-3.5	1248	NCR	NCR
Anritsu Signal Generator	68369B	4114	2018/12/29	2019/12/29
Power Meter	E4419B	GB39511341	2018/06/23	2019/06/23
Power Amplifier	5S1G4	71377	NCR	NCR
Directional Coupler	4242-10	3307	NCR	NCR
Attenuator	3dB	5402	NCR	NCR
Attenuator	10dB	AU 3842	NCR	NCR
R&S, universal Radio Communication Tester	CMU200	115500	2018/06/23	2019/06/23
WIDEBAND RADIO COMMUNICATION TESTER	CMW500	1201.002K50-146520-wh	2018/04/24	2019/04/24
Wireless communication tester	8960	MY50266471	2018/04/25	2019/04/25

SAR MEASUREMENT SYSTEM VERIFICATION

Liquid Verification

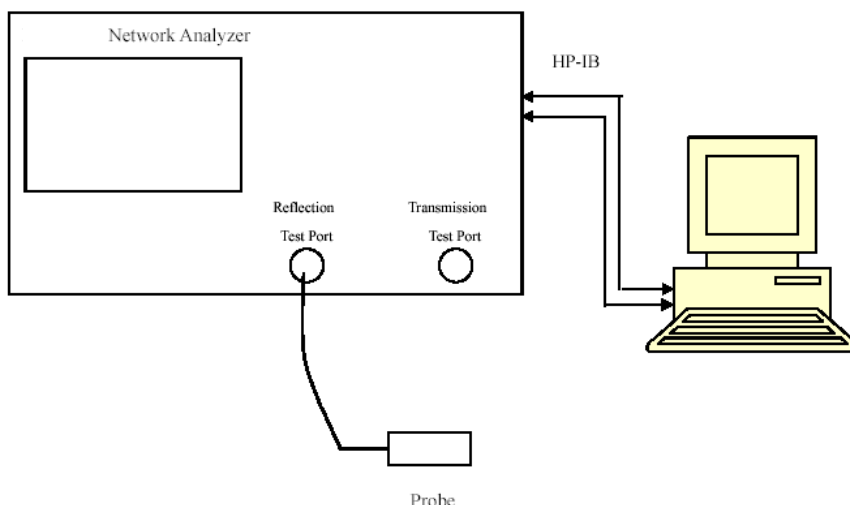

Liquid Verification Setup Block Diagram

Liquid Verification Results

Frequency (MHz)	Liquid Type	Liquid Parameter		Target Value		Delta (%)		Tolerance (%)
		ϵ_r	σ (S/m)	ϵ_r	σ (S/m)	$\Delta\epsilon_r$	$\Delta\sigma$	
703	Simulated Tissue Liquid Body	57.959	0.931	55.69	0.96	4.07	-3.02	± 5
707	Simulated Tissue Liquid Body	57.745	0.941	55.69	0.96	3.69	-1.98	± 5
707.5	Simulated Tissue Liquid Body	57.564	0.943	55.69	0.96	3.37	-1.77	± 5
709	Simulated Tissue Liquid Body	57.777	0.947	55.69	0.96	3.75	-1.35	± 5
710	Simulated Tissue Liquid Body	57.408	0.947	55.69	0.96	3.08	-1.35	± 5
711	Simulated Tissue Liquid Body	57.365	0.949	55.68	0.96	3.03	-1.15	± 5
750	Simulated Tissue Liquid Body	57.47	0.952	55.53	0.96	3.49	-0.83	± 5
782	Simulated Tissue Liquid Body	57.342	0.955	55.50	0.97	3.32	-1.55	± 5

*Liquid Verification above was performed on 2019/03/05.

Frequency (MHz)	Liquid Type	Liquid Parameter		Target Value		Delta (%)		Tolerance (%)
		ϵ_r	σ (S/m)	ϵ_r	σ (S/m)	$\Delta\epsilon_r$	$\Delta\sigma$	
826.4	Simulated Tissue Liquid Body	57.102	0.944	55.22	0.97	3.41	-2.68	± 5
829	Simulated Tissue Liquid Body	57.039	0.947	55.22	0.97	3.29	-2.37	± 5
835	Simulated Tissue Liquid Body	56.992	0.953	55.2	0.97	3.25	-1.75	± 5
836.5	Simulated Tissue Liquid Body	56.896	0.958	55.2	0.97	3.07	-1.24	± 5
836.6	Simulated Tissue Liquid Body	56.896	0.958	52.2	0.97	9	-1.24	± 5
844	Simulated Tissue Liquid Body	56.554	0.963	55.18	0.99	2.49	-2.73	± 5
846.6	Simulated Tissue Liquid Body	56.797	0.966	55.18	0.99	2.93	-2.42	± 5

*Liquid Verification above was performed on 2019/03/06.

Frequency (MHz)	Liquid Type	Liquid Parameter		Target Value		Delta (%)		Tolerance (%)
		ϵ_r	σ (S/m)	ϵ_r	σ (S/m)	$\Delta\epsilon_r$	$\Delta\sigma$	
1712.4	Simulated Tissue Liquid Body	54.66	1.449	53.45	1.48	2.26	-2.09	±5
1720	Simulated Tissue Liquid Body	54.859	1.458	53.44	1.49	2.66	-2.15	±5
1732.5	Simulated Tissue Liquid Body	54.775	1.461	53.42	1.49	2.54	-1.95	±5
1732.6	Simulated Tissue Liquid Body	54.775	1.461	53.42	1.49	2.54	-1.95	±5
1740	Simulated Tissue Liquid Body	54.737	1.466	53.40	1.50	2.5	-2.27	±5
1745	Simulated Tissue Liquid Body	54.7	1.475	53.39	1.50	2.45	-1.67	±5
1750	Simulated Tissue Liquid Body	54.38	1.491	53.39	1.50	1.85	-0.6	±5
1752.6	Simulated Tissue Liquid Body	54.493	1.505	53.38	1.50	2.09	0.33	±5

*Liquid Verification above was performed on 2019/03/06.

Frequency (MHz)	Liquid Type	Liquid Parameter		Target Value		Delta (%)		Tolerance (%)
		ϵ_r	σ (S/m)	ϵ_r	σ (S/m)	$\Delta\epsilon_r$	$\Delta\sigma$	
1852.4	Simulated Tissue Liquid Body	54.368	1.544	53.3	1.52	2	1.58	±5
1860	Simulated Tissue Liquid Body	54.304	1.549	53.3	1.52	1.88	1.91	±5
1880	Simulated Tissue Liquid Body	53.940	1.557	53.3	1.52	1.2	2.43	±5
1900	Simulated Tissue Liquid Body	53.793	1.575	53.3	1.52	0.92	3.62	±5
1907.6	Simulated Tissue Liquid Body	53.654	1.581	53.3	1.52	0.66	4.01	±5

*Liquid Verification above was performed on 2019/03/07.

Frequency (MHz)	Liquid Type	Liquid Parameter		Target Value		Delta (%)		Tolerance (%)
		ϵ_r	σ (S/m)	ϵ_r	σ (S/m)	$\Delta\epsilon_r$	$\Delta\sigma$	
2437	Simulated Tissue Liquid Body	52.906	1.951	52.72	1.94	0.35	0.57	±5
2441	Simulated Tissue Liquid Body	52.891	1.956	52.71	1.94	0.34	0.82	±5
2450	Simulated Tissue Liquid Body	52.87	1.965	52.70	1.95	0.32	0.77	±5
2510	Simulated Tissue Liquid Body	52.176	2.087	52.62	2.04	-0.84	2.3	±5
2535	Simulated Tissue Liquid Body	52.103	2.105	52.59	2.07	-0.93	1.69	±5
2560	Simulated Tissue Liquid Body	52.485	2.135	52.56	2.11	-0.14	1.18	±5
2600	Simulated Tissue Liquid Body	52.037	2.197	52.51	2.16	-2.02	2.18	±5

*Liquid Verification above was performed on 2019/03/07.

System Accuracy Verification

Prior to the assessment, the system validation kit was used to test whether the system was operating within its specifications of $\pm 10\%$. The validation results are tabulated below. And also the corresponding SAR plot is attached as well in the SAR plots files.

The spacing distances in the **System Verification Setup Block Diagram** is given by the following:

- a) $s = 15 \text{ mm} \pm 0,2 \text{ mm}$ for $300 \text{ MHz} \leq f \leq 1\,000 \text{ MHz}$;
- b) $s = 10 \text{ mm} \pm 0,2 \text{ mm}$ for $1\,000 \text{ MHz} < f \leq 3\,000 \text{ MHz}$;
- c) $s = 10 \text{ mm} \pm 0,2 \text{ mm}$ for $3\,000 \text{ MHz} < f \leq 6\,000 \text{ MHz}$.

System Verification Setup Block Diagram

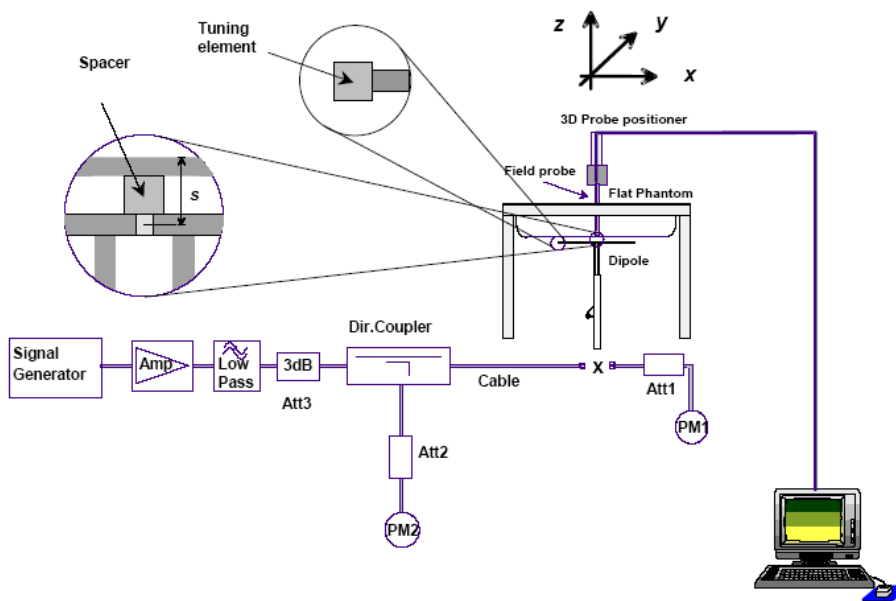

System Accuracy Check Results

Date	Frequency Band (MHz)	Liquid Type	Input Power (mW)	Measured SAR (W/kg)	Normalized to 1W (W/kg)	Target Value (W/Kg)	Delta (%)	Tolerance (%)
2019/03/05	750	Body	100	1g 0.854	8.54	8.33	2.521	± 10
2019/03/05	750	Body	100	10g 0.552	5.52	5.47	0.914	± 10
2019/03/06	835	Body	100	1g 0.959	9.59	9.60	-0.104	± 10
2019/03/06	835	Body	100	10g 0.626	6.26	6.44	-2.795	± 10
2019/03/06	1750	Body	100	1g 3.58	35.8	35.78	0.056	± 10
2019/03/06	1750	Body	100	10g 2.04	20.4	19.28	5.809	± 10
2019/03/07	1900	Body	100	1g 4.22	42.2	42.11	0.214	± 10
2019/03/07	1900	Body	100	10g 2.35	23.5	22.12	6.239	± 10
2019/03/07	2450	Body	100	1g 5.07	50.7	51.7	-1.934	± 10
2019/03/07	2450	Body	100	10g 2.50	25	24.2	3.306	± 10
2019/03/07	2600	Body	100	1g 5.57	55.7	54.7	1.828	± 10
2019/03/07	2600	Body	100	10g 2.62	26.2	24.3	7.819	± 10

*The SAR values above are normalized to 1 Watt forward power.

SAR SYSTEM VALIDATION DATA

System Performance 750 MHz Body

DUT: Dipole 750MHz; Type: ALS-D-750-S-2; Serial: 177-00505

Communication System: CW; Frequency: 750 MHz; Duty Cycle: 1:1
 Medium parameters used: $f = 750 \text{ MHz}$; $\sigma = 0.952 \text{ S/m}$; $\epsilon_r = 57.47$; $\rho = 1000 \text{ kg/m}^3$
 Phantom section: Flat Section

DASY5 Configuration:

- Probe: EX3DV4 - SN7522; ConvF(9.8, 9.8, 9.8) @ 750 MHz; Calibrated: 11/2/2018
- Sensor-Surface: 4mm (Mechanical Surface Detection)
- Electronics: DAE4 Sn1562; Calibrated: 11/6/2018
- Phantom: ELI V8.0 P1aP2a; Type: QD OVA 004 AA; Serial: 2092
- Measurement SW: DASY52, Version 52.10 (2);

Body 750MHz Pin=100mW/Area Scan (101x141x1): Interpolated grid: $dx=1.000 \text{ mm}$, $dy=1.000 \text{ mm}$
 Maximum value of SAR (interpolated) = 0.884 W/kg

Body 750MHz Pin=100mW/Zoom Scan (7x7x7)/Cube 0: Measurement grid: $dx=5\text{mm}$, $dy=5\text{mm}$, $dz=5\text{mm}$
 Reference Value = 34.41 V/m ; Power Drift = -0.017 dB

Peak SAR (extrapolated) = 1.14 W/kg

SAR(1 g) = 0.854 W/kg; SAR(10 g) = 0.552W/kg

Maximum value of SAR (measured) = 0.874 W/kg

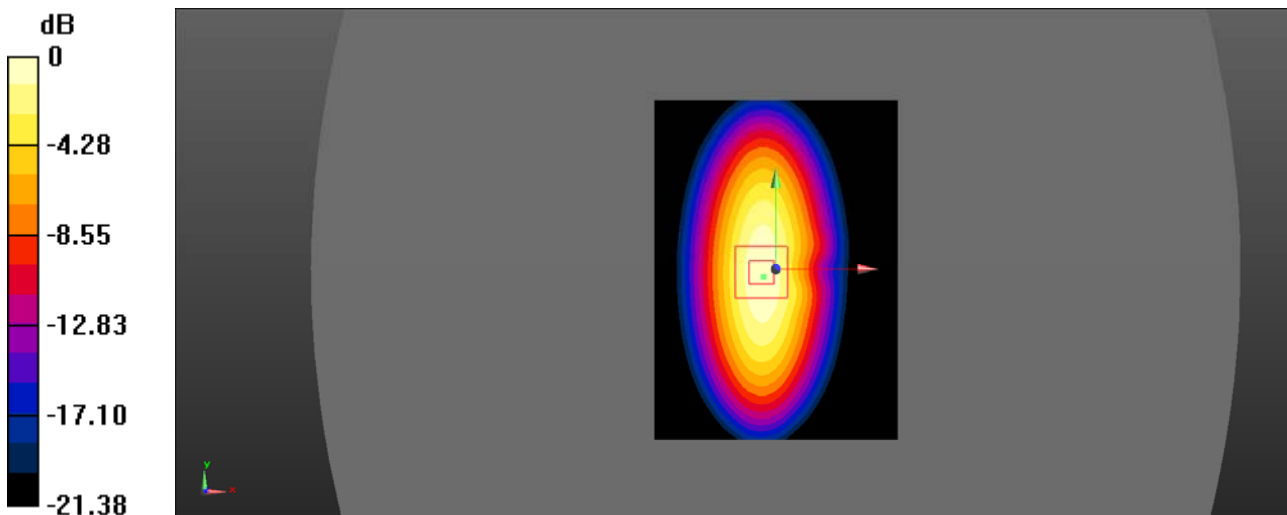

0 dB = 0.874 W/kg = -0.58 dBW/kg

System Performance 835 MHz Body

DUT: Dipole 835MHz; Type: D835V2; Serial: 445

Communication System: CW; Frequency: 835 MHz; Duty Cycle: 1:1

Medium parameters used: $f = 835 \text{ MHz}$; $\sigma = 0.953 \text{ S/m}$; $\epsilon_r = 56.992$; $\rho = 1000 \text{ kg/m}^3$

Phantom section: Flat Section

DASY5 Configuration:

- Probe: EX3DV4 - SN7522; ConvF(9.54, 9.54, 9.54) @ 835 MHz; Calibrated: 11/2/2018
- Sensor-Surface: 4mm (Mechanical Surface Detection)
- Electronics: DAE4 Sn1562; Calibrated: 11/6/2018
- Phantom: ELI V8.0 P1aP2a; Type: QD OVA 004 AA; Serial: 2092
- Measurement SW: DASY52, Version 52.10 (2);

Body 835MHz Pin=100mW/Area Scan (101x141x1): Interpolated grid: $dx=1.000 \text{ mm}$, $dy=1.000 \text{ mm}$

Maximum value of SAR (interpolated) = 1.05 W/kg

Body 835MHz Pin=100mW/Zoom Scan (7x7x7)/Cube 0: Measurement grid: $dx=5\text{mm}$, $dy=5\text{mm}$, $dz=5\text{mm}$

Reference Value = 33.10 V/m; Power Drift = -0.017 dB

Peak SAR (extrapolated) = 1.47 W/kg

SAR(1 g) = 0.959 W/kg; SAR(10 g) = 0.626 W/kg

Maximum value of SAR (measured) = 1.04 W/kg

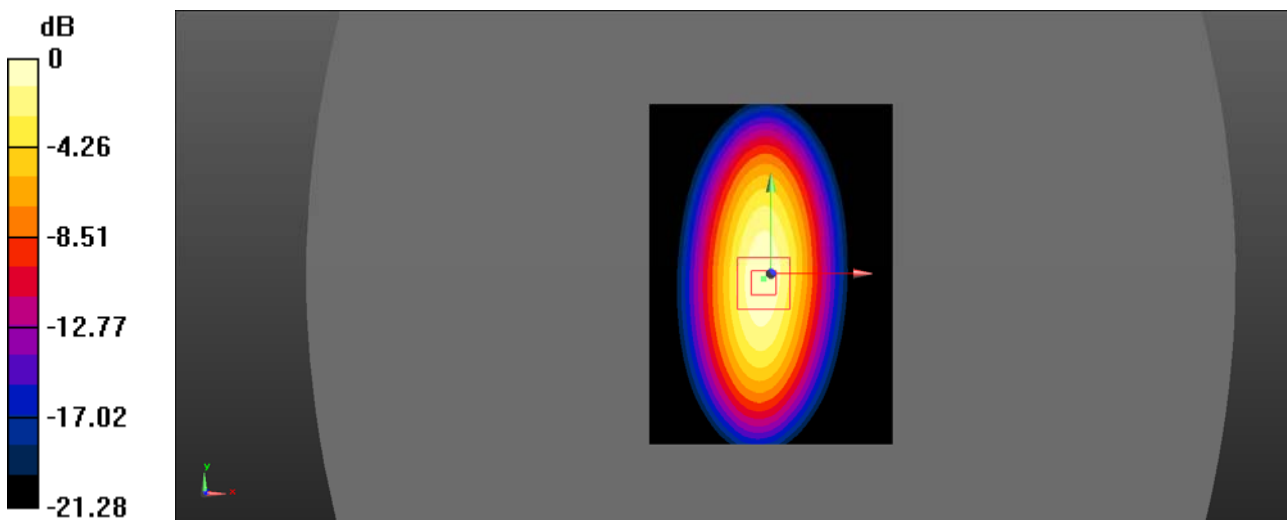

0 dB = 1.04 W/kg = 0.17 dBW/kg

System Performance 1750 MHz Body

DUT: Dipole 1750 MHz; Type: ALS-D-1750-S-2; Serial: 198-00304

Communication System: UID 0, CW (0); Frequency: 1750 MHz; Duty Cycle: 1:1

Medium parameters used: $f = 1750 \text{ MHz}$; $\sigma = 1.491 \text{ S/m}$; $\epsilon_r = 54.38$; $\rho = 1000 \text{ kg/m}^3$

Phantom section: Flat Section

DASY Configuration:

- Probe: EX3DV4 - SN7522; ConvF(7.88, 7.88, 7.88) @ 1750 MHz; Calibrated: 11/2/2018
- Sensor-Surface: 4mm (Mechanical Surface Detection)
- Electronics: DAE4 Sn1562; Calibrated: 11/6/2018
- Phantom: ELI V8.0 P1aP2a; Type: QD OVA 004 AA; Serial: 2092
- Measurement SW: DASY52, Version 52.10 (2);

Body 1750MHz Pin=100mW/Area Scan (81x121x1): Interpolated grid: $dx=1.000 \text{ mm}$, $dy=1.000 \text{ mm}$

Maximum value of SAR (interpolated) = 3.95 W/kg

Body 1750MHz Pin=100mW/Zoom Scan (7x7x7)/Cube 0: Measurement grid: $dx=5\text{mm}$, $dy=5\text{mm}$, $dz=5\text{mm}$

Reference Value = 52.22 V/m; Power Drift = 0.09 dB

Peak SAR (extrapolated) = 6.46 W/kg

SAR(1 g) = 3.58 W/kg; SAR(10 g) = 2.04 W/kg

Maximum value of SAR (measured) = 3.96 W/kg

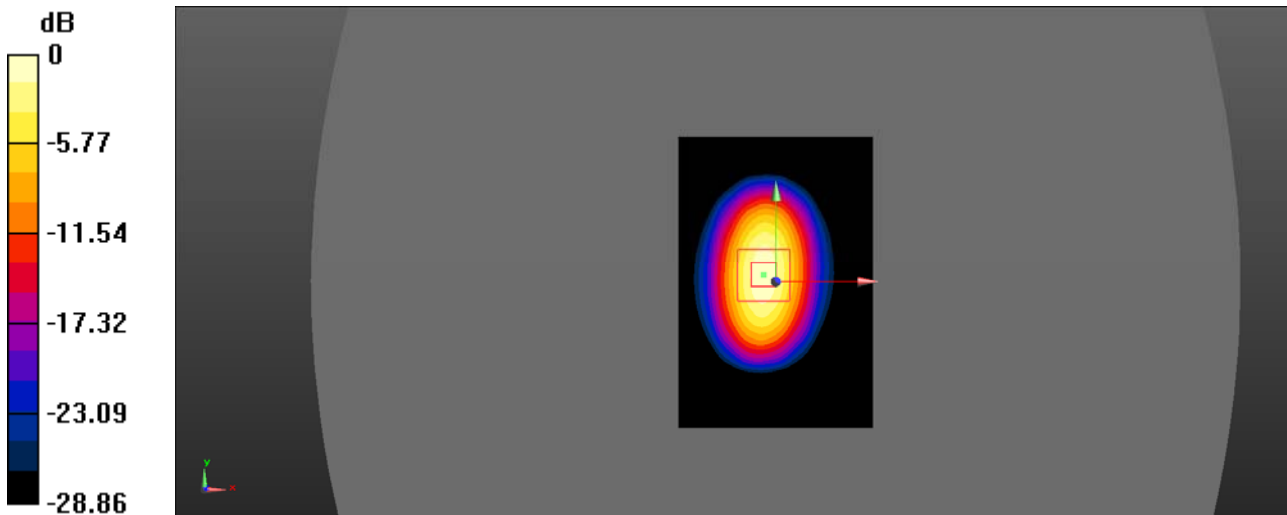

0 dB = 3.96 W/kg = 5.98 dBW/kg

System Performance 1900 MHz Body

DUT: Dipole 1900MHz; Type: ALS-D-1900-S-2; Serial: 210-00710

Communication System: CW; Frequency: 1900 MHz; Duty Cycle: 1:1

Medium parameters used: $f = 1900 \text{ MHz}$; $\sigma = 1.575 \text{ S/m}$; $\epsilon_r = 53.793$; $\rho = 1000 \text{ kg/m}^3$

Phantom section: Flat Section

DASY5 Configuration:

- Probe: EX3DV4 - SN7522; ConvF(7.48, 7.48, 7.48) @ 1900 MHz; Calibrated: 11/2/2018
- Sensor-Surface: 4mm (Mechanical Surface Detection)
- Electronics: DAE4 Sn1562; Calibrated: 11/6/2018
- Phantom: ELI V8.0 P1aP2a; Type: QD OVA 004 AA; Serial: 2092
- Measurement SW: DASY52, Version 52.10 (2);

Body 1900MHz Pin=100mW/Area Scan (81x121x1): Interpolated grid: $dx=1.000 \text{ mm}$, $dy=1.000 \text{ mm}$

Maximum value of SAR (interpolated) = 4.83 W/kg

Body 1900MHz Pin=100mW/Zoom Scan (7x7x7)/Cube 0: Measurement grid: $dx=5\text{mm}$, $dy=5\text{mm}$, $dz=5\text{mm}$

Reference Value = 57.34V/m; Power Drift = 0.015 dB

Peak SAR (extrapolated) = 7.55 W/kg

SAR(1 g) = 4.22 W/kg; SAR(10 g) = 2.35 W/kg

Maximum value of SAR (measured) = 4.85 W/kg

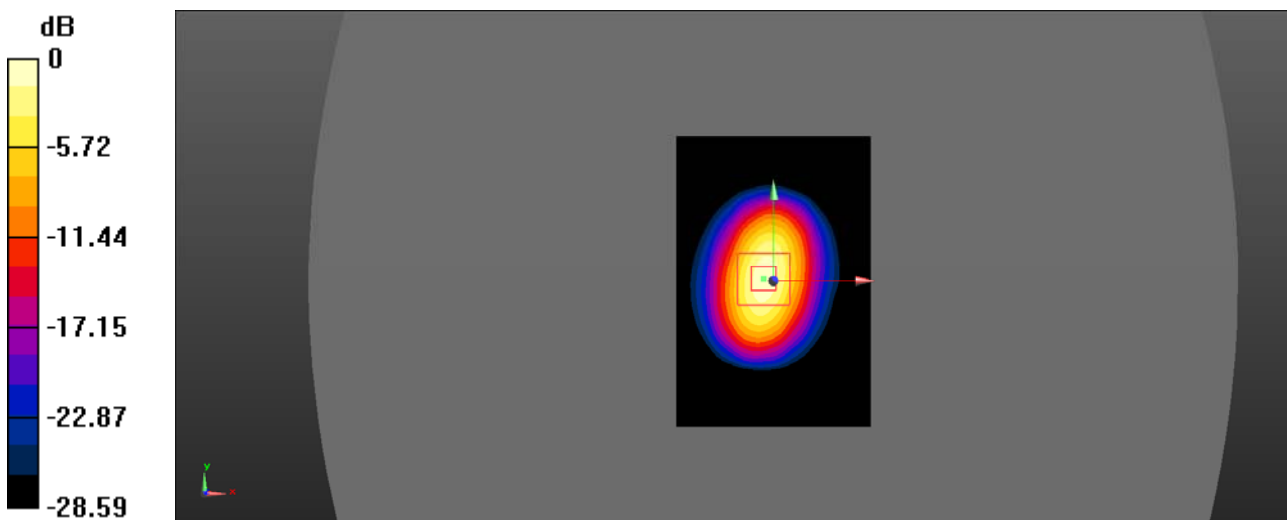

$0 \text{ dB} = 4.85 \text{ W/kg} = 6.86 \text{ dBW/kg}$

System Performance 2450 MHz Body

DUT: Dipole 2450MHz; Type: D2450V2; Serial: 751

Communication System: UID 0, CW (0); Frequency: 2450 MHz; Duty Cycle: 1:1
 Medium parameters used: $f = 2450 \text{ MHz}$; $\sigma = 1.956 \text{ S/m}$; $\epsilon_r = 52.271$; $\rho = 1000 \text{ kg/m}^3$
 Phantom section: Flat Section

DASY Configuration:

- Probe: EX3DV4 - SN7522; ConvF(7.05, 7.05, 7.05) @ 2450 MHz; Calibrated: 11/2/2018
- Sensor-Surface: 4mm (Mechanical Surface Detection)
- Electronics: DAE4 Sn1562; Calibrated: 11/6/2018
- Phantom: ELI V8.0 P1aP2a; Type: QD OVA 004 AA; Serial: 2092
- Measurement SW: DASY52, Version 52.10 (2);

Body 2450MHz Pin=100mW/Area Scan (81x121x1): Interpolated grid: $dx=1.000 \text{ mm}$, $dy=1.000 \text{ mm}$
 Maximum value of SAR (interpolated) = 5.66 W/kg

Body 2450MHz Pin=100mW/Zoom Scan (7x7x7)/Cube 0: Measurement grid: $dx=5\text{mm}$, $dy=5\text{mm}$, $dz=5\text{mm}$
 Reference Value = 51.98 V/m; Power Drift = -0.14 dB
 Peak SAR (extrapolated) = 10.9 W/kg
SAR(1 g) = 5.07 W/kg; SAR(10 g) = 2.50 W/kg
 Maximum value of SAR (measured) = 5.77 W/kg

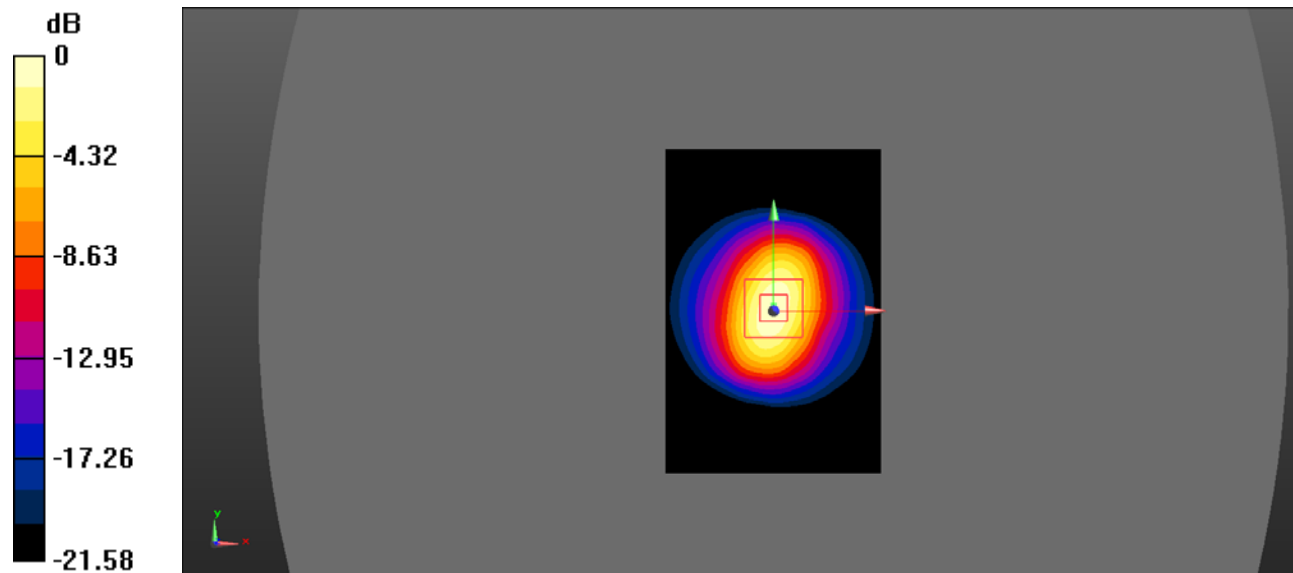

0 dB = 5.77 W/kg = 7.61 dBW/kg

System Performance 2600 MHz Body

DUT: Dipole 2600 MHz; Type: D2600V2; Serial: 1073

Communication System: UID 0, CW (0); Frequency: 2600 MHz; Duty Cycle: 1:1
 Medium parameters used: $f = 2600 \text{ MHz}$; $\sigma = 2.197 \text{ S/m}$; $\epsilon_r = 52.037$; $\rho = 1000 \text{ kg/m}^3$
 Phantom section: Flat Section

DASY Configuration:

- Probe: EX3DV4 - SN7522; ConvF(6.95, 6.95, 6.95) @ 2600 MHz; Calibrated: 11/2/2018
- Sensor-Surface: 4mm (Mechanical Surface Detection)
- Electronics: DAE4 Sn1562; Calibrated: 11/6/2018
- Phantom: ELI V8.0 P1aP2a; Type: QD OVA 004 AA; Serial: 2092
- Measurement SW: DASY52, Version 52.10 (2);

Body 2600MHz Pin=100mW/Area Scan (81x121x1): Interpolated grid: $dx=1.000 \text{ mm}$, $dy=1.000 \text{ mm}$
 Maximum value of SAR (interpolated) = 5.85 W/kg

Body 2600MHz Pin=100mW/Zoom Scan (7x7x7)/Cube 0: Measurement grid: $dx=5\text{mm}$, $dy=5\text{mm}$, $dz=5\text{mm}$
 Reference Value = 55.36 V/m; Power Drift = 0.12 dB
 Peak SAR (extrapolated) = 11.7 W/kg
SAR(1 g) = 5.57 W/kg; SAR(10 g) = 2.62 W/kg
 Maximum value of SAR (measured) = 6.20 W/kg

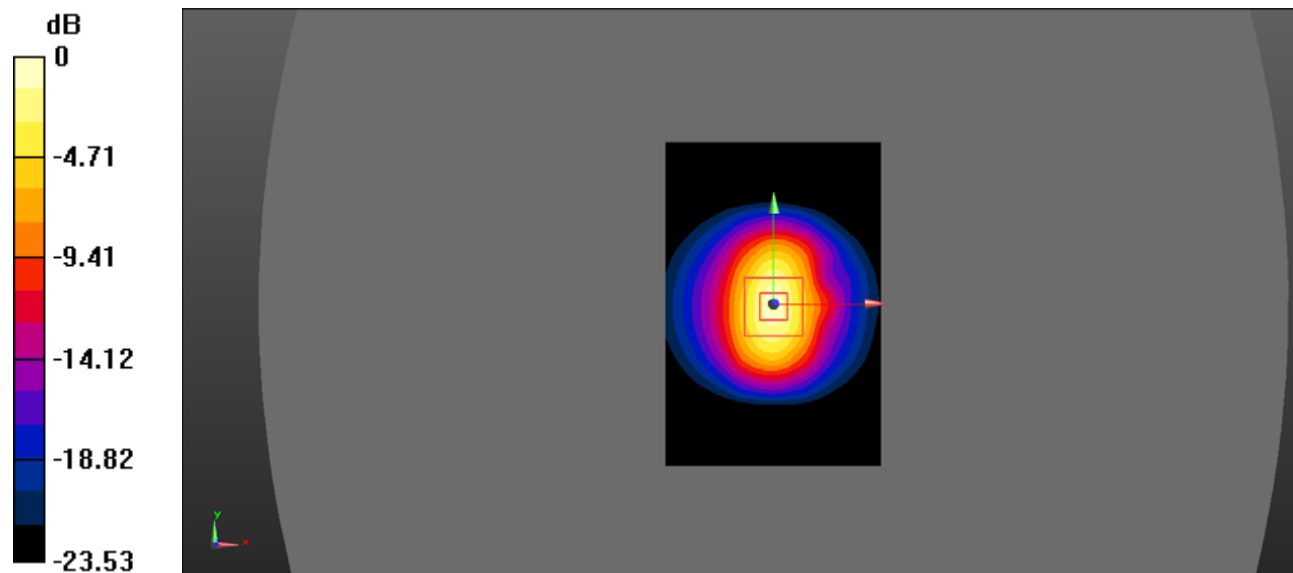

0 dB = 6.20 W/kg = 7.92 dBW/kg

EUT TEST STRATEGY AND METHODOLOGY

Test positions for body-worn and other configurations

Body-worn operating configurations should be tested with the belt-clips and holsters attached to the device and positioned against a flat phantom in normal use configurations. Devices with a headset output should be tested with a headset connected to the device. When multiple accessories that do not contain metallic components are supplied with the device, the device may be tested with only the accessory that dictates the closest spacing to the body. When multiple accessories that contain metallic components are supplied with the device, the device must be tested with each accessory that contains a unique metallic component. If multiple accessories share an identical metallic component (e.g., the same metallic belt-clip used with different holsters with no other metallic components), only the accessory that dictates the closest spacing to the body must be tested.

Body-worn accessories may not always be supplied or available as options for some devices that are intended to be authorized for body-worn use. A separation distance of 1.5 cm between the back of the device and a flat phantom is recommended for testing body-worn SAR compliance under such circumstances. Other separation distances may be used, but they should not exceed 2.5 cm. In these cases, the device may use body-worn accessories that provide a separation distance greater than that tested for the device provided however that the accessory contains no metallic components.

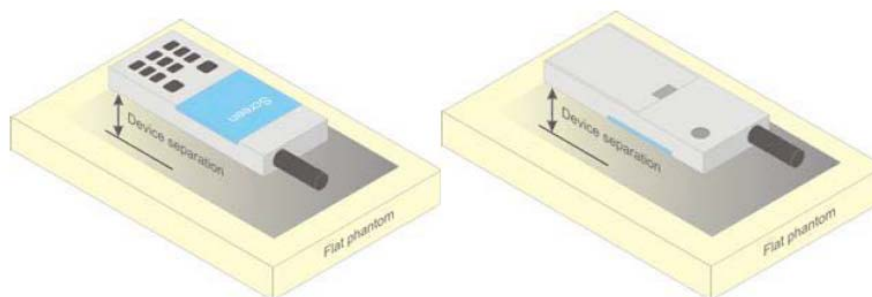

Figure 5 – Test positions for body-worn devices

Test positions for Body-supported device

A typical example of a body supported device is a wireless enabled laptop device that among other orientations may be supported on the thighs of a sitting user. To represent this orientation, the device shall be positioned with its base against the flat phantom. Other orientations may be specified by the manufacturer in the user instructions. If the intended use is not specified, the device shall be tested directly against the flat phantom in all usable orientations.

The screen portion of the device shall be in an open position at a 90° angle as seen in Figure below (left side), or at an operating angle specified for intended use by the manufacturer in the operating instructions. Where a body supported device has an integral screen required for normal operation, then the screen-side will not need to be tested if it ordinarily remains 200 mm from the body. Where a screen mounted antenna is present, this position shall be repeated with the screen against the flat phantom as shown in Figure below (right side), if this is consistent with the intended use.

Other devices that fall into this category include tablet type portable computers and credit card transaction authorisation terminals, point-of-sale and/or inventory terminals. Where these devices may be torso or limb-supported, the same principles for body-supported devices are applied.

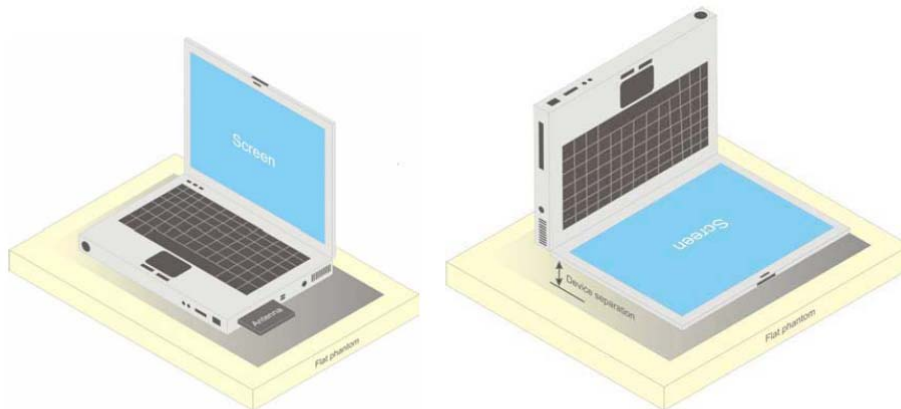

a) Portable computer with external antenna plug-in-radio-card (left side) or with internal antenna located in screen section (right side)

Test positions for Hand-held device

Hand-held device means a portable device which is located in a user’s hand during its intended use. Hand-held usage of the device, not at the head or torso. The device shall be placed directly against the flat phantom as shown in Figure J.1, for those sides of the device that are in contact with the hand during intended use.

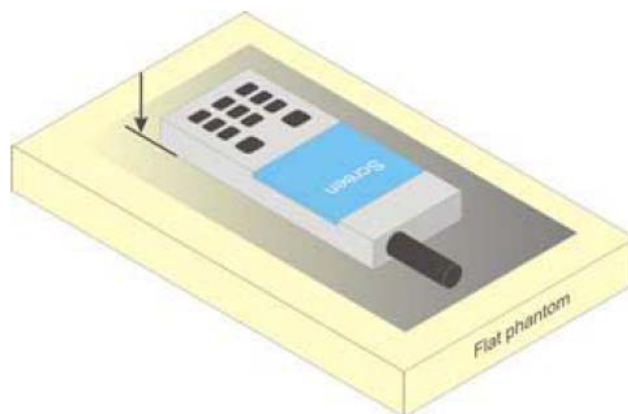

Figure J.1 – Test position for hand-held devices, not used at the head or torso

Test Distance for SAR Evaluation

For this case the EUT(Equipment Under Test) is set 0mm away from the phantom, the test distance is 0mm.

SAR Evaluation Procedure

The evaluation was performed with the following procedure:

Step 1: Measurement of the SAR value at a fixed location above the ear point or central position was used as a reference value for assessing the power drop. The SAR at this point is measured at the start of the test and then again at the end of the testing.

Step 2: The SAR distribution at the exposed side of the head was measured at a distance of 4 mm from the inner surface of the shell. The area covered the entire dimension of the head or radiating structures of the EUT, the horizontal grid spacing was 15 mm x 15 mm, and the SAR distribution was determined by integrated grid of 1.5mm x 1.5mm. Based on these data, the area of the maximum absorption was determined by spline interpolation. The first Area Scan covers the entire dimension of the EUT to ensure that the hotspot was correctly identified.

Step 3: Around this point, a volume of 30 mm x 30 mm x 30 mm was assessed by measuring 7x 7 x 7 points. On the basis of this data set, the spatial peak SAR value was evaluated under the following procedure:

1) The data at the surface were extrapolated, since the center of the dipoles is 1.2 mm away from the tip of the probe and the distance between the surface and the lowest measuring point is 1.3 mm. The extrapolation was based on a least square algorithm. A polynomial of the fourth order was calculated through the points in z-axes. This polynomial was then used to evaluate the points between the surface and the probe tip.

2) The maximum interpolated value was searched with a straightforward algorithm. Around this maximum the SAR values averaged over the spatial volumes (1 g or 10 g) were computed by the 3D-Spline interpolation algorithm. The 3D-Spline is composed of three one dimensional splines with the "Not a knot"-condition (in x, y and z-directions). The volume was integrated with the trapezoidal-algorithm. One thousand points (10 x 10 x 10) were interpolated to calculate the averages.

All neighboring volumes were evaluated until no neighboring volume with a higher average value was found.

Step 4: Re-measurement of the SAR value at the same location as in Step 1. If the value changed by more than 5%, the evaluation was repeated.

CONDUCTED OUTPUT POWER MEASUREMENT

Provision Applicable

The measured peak output power should be greater and within 5% than EMI measurement.

Test Procedure

The RF output of the transmitter was connected to the input of the EMI Test Receiver through Connector.

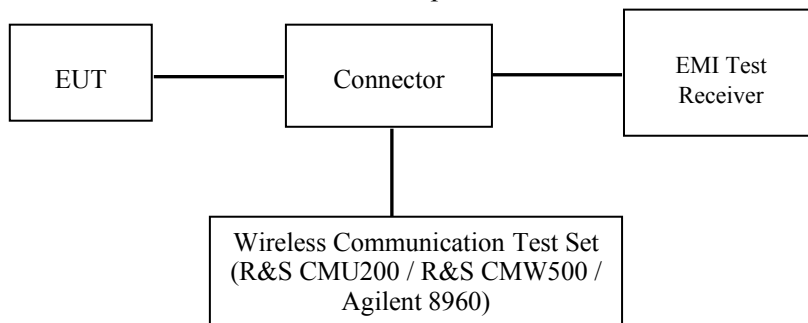

WCDMA/LTE

Radio Configuration

The power measurement was configured by the Wireless Communication Test Set.

GSM/GPRS/EGPRS

Function: Menu select > GSM Mobile Station > GSM 850/1900

Press Connection control to choose the different menus

Press RESET > choose all the reset all settings

Connection Press Signal Off to turn off the signal and change settings

Network Support > GSM + GPRS or GSM + EGSM

Main Service > Packet Data

Service selection > Test Mode A – Auto Slot Config. off

MS Signal Press Slot Config Bottom on the right twice to select and change the number of time slots and power setting

> Slot configuration > Uplink/Gamma

> 33 dBm for GPRS 850

> 30 dBm for GPRS 1900

> 27 dBm for EGPRS 850

> 26 dBm for EGPRS 1900

BS Signal Enter the same channel number for TCH channel (test channel) and BCCH channel

Frequency Offset > + 0 Hz

Mode > BCCH and TCH

BCCH Level > -85 dBm (May need to adjust if link is not stable)

BCCH Channel > choose desired test channel [Enter the same channel number for TCH channel (test channel) and BCCH channel]

Channel Type > Off

P0 > 4 dB

Slot Config > Unchanged (if already set under MS signal)

TCH > choose desired test channel

Hopping > Off

Main Timeslot > 3

Network Coding Scheme > CS4 (GPRS) and MCS5 (EGPRS)

Bit Stream > 2E9-1 PSR Bit Stream

AF/RF Enter appropriate offsets for Ext. Att. Output and Ext. Att. Input

Connection Press Signal on to turn on the signal and change settings

WCDMA Release 99

The following tests were conducted according to the test requirements outlines in section 5.2 of the 3GPP TS34.121-1 specification. The EUT has a nominal maximum output power of 24dBm (+1.7/-3.7).

WCDMA General Settings	Loopback Mode	Test Mode 1
	Rel99 RMC	12.2kbps RMC
	Power Control Algorithm	Algorithm2
	β_c/β_d	8/15

HSDPA

The following tests were conducted according to the test requirements outlines in section 5.2 of the 3GPP TS34.121-1 specification.

	Mode	HSDPA	HSDPA	HSDPA	HSDPA
	Subset	1	2	3	4
WCDMA General Settings	Loopback Mode	Test Mode 1			
	Rel99 RMC	12.2kbps RMC			
	HSDPA FRC	H-Set1			
	Power Control Algorithm	Algorithm2			
	β_c	2/15	12/15	15/15	15/15
	β_d	15/15	15/15	8/15	4/15
	$\beta_d(SF)$	64			
	β_c/β_d	2/15	12/15	15/8	15/4
	β_{hs}	4/15	24/15	30/15	30/15
MPR(dB)	0	0	0.5	0.5	
HSDPA Specific Settings	DACK	8			
	DNAK	8			
	DCQI	8			
	Ack-Nack repetition factor	3			
	CQI Feedback	4ms			
	CQI Repetition Factor	2			
	$A_{hs}=\beta_{hs}/\beta_c$	30/15			

HSUPA

The following tests were conducted according to the test requirements outlines in section 5.2 of the 3GPP TS34.121-1 specification.

	Mode	HSUPA	HSUPA	HSUPA	HSUPA	HSUPA
	Subset	1	2	3	4	5
WCDMA General Settings	Loopback Mode	Test Mode 1				
	Rel99 RMC	12.2kbps RMC				
	HSDPA FRC	H-Set1				
	HSUPA Test	HSUPA Loopback				
	Power Control Algorithm	Algorithm2				
	β_c	11/15	6/15	15/15	2/15	15/15
	β_d	15/15	15/15	9/15	15/15	0
	β_{cc}	209/225	12/15	30/15	2/15	5/15
	β_c / β_d	11/15	6/15	15/9	2/15	-
	β_{hs}	22/15	12/15	30/15	4/15	5/15
	CM(dB)	1.0	3.0	2.0	3.0	1.0
MPR(dB)	0	2	1	2	0	
HSDPA Specific Settings	DACK	8				
	DNAK	8				
	DCQI	8				
	Ack-Nack repetition factor	3				
	CQI Feedback	4ms				
	CQI Repetition Factor	2				
	$A_{hs} = \beta_{hs} / \beta_c$	30/15				
HSUPA Specific Settings	DE-DPCCH	6	8	8	5	7
	DHARQ	0	0	0	0	0
	AG Index	20	12	15	17	21
	ETFCI	75	67	92	71	81
	Associated Max UL Data Rate kbps	242.1	174.9	482.8	205.8	308.9
	Reference E_FCIs	E-TFCI 11 E-TFCI PO 4 E-TFCI 67 E-TFCI PO 18 E-TFCI 71 E-TFCI PO23 E-TFCI 75 E-TFCI PO26 E-TFCI 81 E-TFCI PO 27	E-TFCI 11 E-TFCI PO4 E-TFCI 92 E-TFCI PO 18	E-TFCI 11 E-TFCI PO4 E-TFCI 92 E-TFCI PO 18	E-TFCI 11 E-TFCI PO 4 E-TFCI 67 E-TFCI PO 18 E-TFCI 71 E-TFCI PO23 E-TFCI 75 E-TFCI PO26 E-TFCI 81 E-TFCI PO 27	E-TFCI 11 E-TFCI PO 4 E-TFCI 67 E-TFCI PO 18 E-TFCI 71 E-TFCI PO23 E-TFCI 75 E-TFCI PO26 E-TFCI 81 E-TFCI PO 27

FDD-LTE

For UE Power Class 1 and 3, the allowed Maximum Power Reduction (MPR) for the maximum output power in Table 6.2.2-1 due to higher order modulation and transmit bandwidth configuration (resource blocks) is specified in Table 6.2.3-1.

Table 6.2.3-1: Maximum Power Reduction (MPR) for Power Class 1 and 3

Modulation	Channel bandwidth / Transmission bandwidth (N_{RB})						MPR (dB)
	1.4 MHz	3.0 MHz	5 MHz	10 MHz	15 MHz	20 MHz	
QPSK	> 5	> 4	> 8	> 12	> 16	> 18	≤ 1
16 QAM	≤ 5	≤ 4	≤ 8	≤ 12	≤ 16	≤ 18	≤ 1
16 QAM	> 5	> 4	> 8	> 12	> 16	> 18	≤ 2

For UE Power Class 1 and 3 the specific requirements and identified sub clauses are specified in Table 6.2.4-1 along with the allowed A-MPR values that may be used to meet these requirements. The allowed A-MPR values specified below in Table 6.2.4.-1 to 6.2.4-15 are in addition to the allowed MPR requirements specified in sub clause 6.2.3.

Table 6.2.4-1: Additional Maximum Power Reduction (A-MPR)

Network Signalling value	Requirements (subclause)	E-UTRA Band	Channel bandwidth (MHz)	Resources Blocks (N_{RB})	A-MPR (dB)
NS_01	6.6.2.1.1	Table 5.5-1	1.4, 3, 5, 10, 15, 20	Table 5.6-1	N/A
NS_03	6.6.2.2.1	2, 4, 10, 23, 25, 35, 36	3	>5	≤ 1
			5	>6	≤ 1
			10	>6	≤ 1
			15	>8	≤ 1
			20	>10	≤ 1
NS_04	6.6.2.2.2	41	5	>6	≤ 1
			10, 15, 20	Table 6.2.4-4	
NS_05	6.6.3.3.1	1	10, 15, 20	≥ 50	≤ 1
NS_06	6.6.2.2.3	12, 13, 14, 17	1.4, 3, 5, 10	Table 5.6-1	N/A
NS_07	6.6.2.2.3 6.6.3.3.2	13	10	Table 6.2.4-2	
NS_08	6.6.3.3.3	19	10, 15	> 44	≤ 3
NS_09	6.6.3.3.4	21	10, 15	> 40	≤ 1
				> 55	≤ 2
				Table 6.2.4-3	
NS_11	6.6.2.2.1	23	1.4, 3, 5, 10, 15, 20	Table 6.2.4-5	
NS_12	6.6.3.3.5	26	1.4, 3, 5	Table 6.2.4-6	
NS_13	6.6.3.3.6	26	5	Table 6.2.4-7	
NS_14	6.6.3.3.7	26	10, 15	Table 6.2.4-8	
NS_15	6.6.3.3.8	26	1.4, 3, 5, 10, 15	Table 6.2.4-9 Table 6.2.4-10	
NS_16	6.6.3.3.9	27	3, 5, 10	Table 6.2.4-11, Table 6.2.4-12, Table 6.2.4-13	
NS_17	6.6.3.3.10	28	5, 10	Table 5.6-1	N/A
NS_18	6.6.3.3.11	28	5	≥ 2	≤ 1
			10, 15, 20	≥ 1	≤ 4
NS_19	6.6.3.3.12	44	10, 15, 20	Table 6.2.4-14	
NS_20	6.2.2 6.6.2.2.1 6.6.3.2	23	5, 10, 15, 20	Table 6.2.4-15	
...					
NS_32	-	-	-	-	-

Maximum Target Output Power

Max Target Power for Production Unit (dBm)			
Mode/Band	Channel		
	Low	Middle	High
WCDMA Band 2	22.5	22.5	22.5
HSDPA	21.5	21.5	21.5
HSUPA	21.5	21.5	21.5
WCDMA Band 4	22.4	22.4	22.4
HSDPA	20.7	20.7	20.7
HSUPA	20.6	20.6	20.6
WCDMA Band 5	22.6	22.6	22.6
HSDPA	22.1	22.1	22.1
HSUPA	22.1	22.1	22.1
LTE Band 2	23.2	23.2	23.2
LTE Band 4	23.0	23.0	23.0
LTE Band 5	23.1	23.1	23.1
LTE Band 7	24.0	24.0	24.0
LTE Band 12	23.5	23.5	23.5
LTE Band 13	23.3	23.3	23.3
LTE Band 17	23.3	23.3	23.3
Bluetooth	8.5	8.5	8.5
BLE	0	0	0
WLAN 2.4G	10.0	10.0	10.0

Test Results:

WCDMA Band 2:

Test Condition	Test Mode	3GPP Sub Test	Averaged Mean Power (dBm)		
			Low Frequency	Mid Frequency	High Frequency
Normal	RMC12.2k		22.25	22.40	22.18
	HSDPA	1	21.28	21.45	21.38
		2	20.44	20.26	20.33
		3	20.44	20.44	20.57
		4	20.28	20.38	20.38
	HSUPA	1	21.31	21.40	21.40
		2	20.40	20.34	20.28
		3	20.49	20.33	20.47
		4	20.24	20.44	20.35
		5	20.42	20.45	20.42

WCDMA Band 4:

Test Condition	Test Mode	3GPP Sub Test	Averaged Mean Power (dBm)		
			Low Frequency	Mid Frequency	High Frequency
Normal	RMC12.2k		22.15	22.37	22.23
	HSDPA	1	20.58	20.55	20.51
		2	20.38	20.39	20.35
		3	20.35	20.46	20.53
		4	20.29	20.34	20.33
	HSUPA	1	20.33	20.50	20.38
		2	20.28	20.32	20.26
		3	20.60	20.24	20.45
		4	20.39	20.31	20.27
		5	20.48	20.49	20.35

WCDMA Band 5:

Test Condition	Test Mode	3GPP Sub Test	Averaged Mean Power (dBm)		
			Low Frequency	Mid Frequency	High Frequency
Normal	RMC12.2k		22.30	22.41	21.86
	HSDPA	1	21.58	21.17	21.04
		2	21.81	21.97	21.33
		3	21.89	22.13	21.46
		4	21.73	22.03	21.27
	HSUPA	1	21.53	21.27	21.10
		2	21.77	21.98	21.20
		3	21.85	22.15	21.41
		4	21.63	21.99	21.21
		5	21.78	22.02	21.45

Note:

1. The default test configuration is to measure SAR with an established radio link between the EUT and a communication test set using a 12.2 kbps RMC (reference measurement Channel) Configured in Test Loop Model 1.
2. KDB 941225 D01-Body SAR is not required for HSDPA/HSUPA when the maximum average output of each RF channel is less than ¼ dB higher than measured 12.2kbps RMC or the maximum SAR for 12.2kbps RMC is < 75% of SAR limit.

LTE Band 2:

BW (MHz)	Modulation	Resource Block Size & Resource Block Offset	Target MPR	Meas MPR	Ave Tx Power (dBm)		
					Low Channel	Mid Channel	High Channel
					1850.7MHz	1880MHz	1909.3MHz
1.4	QPSK	RB Size=1, RB Offset=0	0	0	22.81	22.76	22.74
		RB Size=1, RB Offset=2	0	0	22.58	22.63	22.61
		RB Size=1, RB Offset=5	0	0	22.38	22.77	22.67
		RB Size=3, RB Offset=0	1	1	22.42	22.41	22.24
		RB Size=3, RB Offset=1	1	1	22.22	22.44	22.13
		RB Size=3, RB Offset=2	1	1	22.29	22.11	22.19
	16QAM	RB Size=6, RB Offset=0	1	1	22.36	21.99	22.05
		RB Size=1, RB Offset=0	1	1	22.24	22.06	22.30
		RB Size=1, RB Offset=2	1	1	22.14	22.05	22.10
		RB Size=1, RB Offset=5	1	1	22.15	21.99	23.04
		RB Size=3, RB Offset=0	2	2	21.80	21.72	22.89
		RB Size=3, RB Offset=1	2	2	21.80	21.83	21.82
		RB Size=3, RB Offset=2	2	2	21.86	21.99	21.76
		RB Size=6, RB Offset=0	2	2	21.80	21.65	21.62
BW (MHz)	Modulation	Resource Block Size & Resource Block Offset	Target MPR	Meas MPR	Ave Tx Power (dBm)		
					Low Channel	Mid Channel	High Channel
					1851.5MHz	1880MHz	1908.5MHz
3	QPSK	RB Size=1, RB Offset=0	0	0	22.91	22.82	22.93
		RB Size=1, RB Offset=7	0	0	22.65	22.66	22.79
		RB Size=1, RB Offset=14	0	0	22.65	22.66	22.89
		RB Size=8, RB Offset=0	1	1	21.97	21.76	22.10
		RB Size=8, RB Offset=4	1	1	21.72	21.71	21.80
		RB Size=8, RB Offset=7	1	1	21.66	21.57	21.76
		RB Size=15, RB Offset=0	1	1	21.67	21.82	21.85
	16QAM	RB Size=1, RB Offset=0	1	1	22.11	22.21	21.97
		RB Size=1, RB Offset=7	1	1	22.16	22.06	22.06
		RB Size=1, RB Offset=14	1	1	22.21	21.91	21.94
		RB Size=8, RB Offset=0	2	2	20.78	20.76	20.94
		RB Size=8, RB Offset=4	2	2	20.76	20.78	20.89
		RB Size=8, RB Offset=7	2	2	20.41	20.69	20.89
		RB Size=15, RB Offset=0	2	2	20.70	20.84	20.75

BW (MHz)	Modulation	Resource Block Size & Resource Block Offset	Target MPR	Meas MPR	Ave Tx Power (dBm)		
					Low Channel	Mid Channel	High Channel
					1852.5MHz	1880MHz	1907.5MHz
5	QPSK	RB Size=1, RB Offset=0	0	0	22.83	22.81	22.87
		RB Size=1, RB Offset=12	0	0	22.80	22.75	22.56
		RB Size=1, RB Offset=24	0	0	22.67	22.73	22.37
		RB Size=12, RB Offset=0	1	1	21.91	21.80	21.84
		RB Size=12, RB Offset=6	1	1	21.70	21.82	21.74
		RB Size=12, RB Offset=11	1	1	21.75	21.57	21.57
	16QAM	RB Size=25, RB Offset=0	1	1	21.88	21.64	21.66
		RB Size=1, RB Offset=0	1	1	22.03	21.72	21.60
		RB Size=1, RB Offset=12	1	1	22.00	21.39	21.60
		RB Size=1, RB Offset=24	1	1	21.83	21.32	21.56
		RB Size=12, RB Offset=0	2	2	20.74	20.69	20.81
		RB Size=12, RB Offset=6	2	2	20.98	20.71	20.51
		RB Size=12, RB Offset=11	2	2	20.67	20.51	20.53
RB Size=25, RB Offset=0	2	2	20.81	20.84	20.76		
BW (MHz)	Modulation	Resource Block Size & Resource Block Offset	Target MPR	Meas MPR	Ave Tx Power (dBm)		
					Low Channel	Mid Channel	High Channel
					1855MHz	1880MHz	1905MHz
10	QPSK	RB Size=1, RB Offset=0	0	0	22.89	22.81	22.61
		RB Size=1, RB Offset=24	0	0	22.77	22.78	22.69
		RB Size=1, RB Offset=49	0	0	22.58	22.65	22.71
		RB Size=25, RB Offset=0	1	1	21.74	21.62	21.83
		RB Size=25, RB Offset=12	1	1	21.71	21.75	21.74
		RB Size=25, RB Offset=24	1	1	21.78	21.67	21.65
	16QAM	RB Size=50, RB Offset=0	1	1	21.53	21.56	21.56
		RB Size=1, RB Offset=0	1	1	21.74	21.77	21.67
		RB Size=1, RB Offset=24	1	1	21.65	21.44	21.66
		RB Size=1, RB Offset=49	1	1	21.40	21.47	21.77
		RB Size=25, RB Offset=0	2	2	22.69	20.67	20.72
		RB Size=25, RB Offset=12	2	2	22.40	20.60	20.59
		RB Size=25, RB Offset=24	2	2	22.54	20.32	20.26
RB Size=50, RB Offset=0	2	2	20.45	20.50	20.56		

BW (MHz)	Modulation	Resource Block Size & Resource Block Offset	Target MPR	Meas MPR	Ave Tx Power (dBm)		
					Low Channel	Mid Channel	High Channel
					1857.5MHz	1880MHz	1902.5MHz
15	QPSK	RB Size=1, RB Offset=0	0	0	22.10	22.16	22.29
		RB Size=1, RB Offset=37	0	0	21.90	21.97	22.19
		RB Size=1, RB Offset=74	0	0	22.07	21.98	22.24
		RB Size=36, RB Offset=0	1	1	22.02	21.95	22.11
		RB Size=36, RB Offset=18	1	1	22.09	22.00	21.94
		RB Size=36, RB Offset=37	1	1	22.21	21.79	21.64
	16QAM	RB Size=75, RB Offset=0	1	1	21.95	21.92	22.02
		RB Size=1, RB Offset=0	1	1	21.98	21.80	21.73
		RB Size=1, RB Offset=37	1	1	21.83	21.84	21.49
		RB Size=1, RB Offset=74	1	1	21.70	21.81	21.44
		RB Size=36, RB Offset=0	2	2	21.85	21.80	22.11
		RB Size=36, RB Offset=18	2	2	21.87	21.86	21.99
		RB Size=36, RB Offset=37	2	2	21.54	21.72	21.92
RB Size=75, RB Offset=0	2	2	21.19	21.09	20.86		
BW (MHz)	Modulation	Resource Block Size & Resource Block Offset	Target MPR	Meas MPR	Ave Tx Power (dBm)		
					Low Channel	Mid Channel	High Channel
					1860MHz	1880MHz	1900MHz
20	QPSK	RB Size=1, RB Offset=0	0	0	22.95	22.96	23.02
		RB Size=1, RB Offset=49	0	0	22.99	22.75	23.00
		RB Size=1, RB Offset=99	0	0	23.00	22.94	22.86
		RB Size=50, RB Offset=0	1	1	22.58	22.69	22.78
		RB Size=50, RB Offset=24	1	1	22.63	22.48	22.67
		RB Size=50, RB Offset=49	1	1	22.50	22.45	22.38
	16QAM	RB Size=100, RB Offset=0	1	1	21.86	21.74	21.78
		RB Size=1, RB Offset=0	1	1	21.96	21.95	22.24
		RB Size=1, RB Offset=49	1	1	22.15	21.79	21.98
		RB Size=1, RB Offset=99	1	1	21.87	21.78	22.01
		RB Size=50, RB Offset=0	2	2	20.98	20.92	21.16
		RB Size=50, RB Offset=24	2	2	20.81	20.99	21.05
		RB Size=50, RB Offset=49	2	2	20.48	20.80	20.85
RB Size=100, RB Offset=0	2	2	20.94	20.83	20.95		

LTE Band 4:

BW (MHz)	Modulation	Resource Block Size & Resource Block Offset	Target MPR	Meas MPR	Ave Tx Power (dBm)		
					Low Channel	Mid Channel	High Channel
					1710.7MHz	1732.5MHz	1754.3MHz
1.4	QPSK	RB Size=1, RB Offset=0	0	0	22.52	22.44	22.49
		RB Size=1, RB Offset=2	0	0	22.62	22.31	22.45
		RB Size=1, RB Offset=5	0	0	22.41	21.97	22.53
		RB Size=3, RB Offset=0	1	1	22.75	22.85	22.71
		RB Size=3, RB Offset=1	1	1	22.48	22.61	22.87
		RB Size=3, RB Offset=2	1	1	22.55	22.64	22.48
	16QAM	RB Size=6, RB Offset=0	1	1	21.50	21.57	21.34
		RB Size=1, RB Offset=0	1	1	21.80	21.84	22.02
		RB Size=1, RB Offset=2	1	1	21.88	21.80	21.65
		RB Size=1, RB Offset=5	1	1	21.78	21.93	21.91
		RB Size=3, RB Offset=0	2	2	22.79	21.79	21.89
		RB Size=3, RB Offset=1	2	2	22.80	21.82	21.77
		RB Size=3, RB Offset=2	2	2	22.76	21.67	21.67
		RB Size=6, RB Offset=0	2	2	20.62	20.74	20.72
BW (MHz)	Modulation	Resource Block Size & Resource Block Offset	Target MPR	Meas MPR	Ave Tx Power (dBm)		
					Low Channel	Mid Channel	High Channel
					1711.5MHz	1732.5MHz	1753.5MHz
3	QPSK	RB Size=1, RB Offset=0	0	0	22.69	22.53	22.47
		RB Size=1, RB Offset=7	0	0	22.38	22.41	22.21
		RB Size=1, RB Offset=14	0	0	22.39	22.17	22.35
		RB Size=8, RB Offset=0	1	1	21.50	21.62	21.61
		RB Size=8, RB Offset=4	1	1	21.42	21.51	21.69
		RB Size=8, RB Offset=7	1	1	21.34	21.32	21.62
		RB Size=15, RB Offset=0	1	1	21.57	21.66	21.74
	16QAM	RB Size=1, RB Offset=0	1	1	21.55	21.60	21.66
		RB Size=1, RB Offset=7	1	1	21.72	21.63	21.43
		RB Size=1, RB Offset=14	1	1	21.61	21.47	21.34
		RB Size=8, RB Offset=0	2	2	20.72	20.68	20.73
		RB Size=8, RB Offset=4	2	2	20.67	20.53	20.85
		RB Size=8, RB Offset=7	2	2	20.70	20.87	20.71
		RB Size=15, RB Offset=0	2	2	20.57	20.93	20.84

BW (MHz)	Modulation	Resource Block Size & Resource Block Offset	Target MPR	Meas MPR	Ave Tx Power (dBm)		
					Low Channel	Mid Channel	High Channel
					1712.5MHz	1732.5MHz	1752.5MHz
5	QPSK	RB Size=1, RB Offset=0	0	0	22.67	22.60	22.75
		RB Size=1, RB Offset=12	0	0	22.64	22.53	22.74
		RB Size=1, RB Offset=24	0	0	22.50	22.42	22.60
		RB Size=12, RB Offset=0	1	1	21.79	21.55	21.68
		RB Size=12, RB Offset=6	1	1	21.81	21.68	21.62
		RB Size=12, RB Offset=11	1	1	21.47	21.79	21.50
	16QAM	RB Size=25, RB Offset=0	1	1	21.78	21.75	21.60
		RB Size=1, RB Offset=0	1	1	22.06	21.77	21.97
		RB Size=1, RB Offset=12	1	1	21.75	21.74	21.83
		RB Size=1, RB Offset=24	1	1	21.73	21.72	21.54
		RB Size=12, RB Offset=0	2	2	20.94	20.88	21.03
		RB Size=12, RB Offset=6	2	2	20.99	21.03	20.90
		RB Size=12, RB Offset=11	2	2	20.84	20.76	20.87
RB Size=25, RB Offset=0	2	2	20.87	20.58	20.68		
BW (MHz)	Modulation	Resource Block Size & Resource Block Offset	Target MPR	Meas MPR	Ave Tx Power (dBm)		
					Low Channel	Mid Channel	High Channel
					1715MHz	1732.5MHz	1750MHz
10	QPSK	RB Size=1, RB Offset=0	0	0	22.79	22.67	22.71
		RB Size=1, RB Offset=24	0	0	22.68	22.50	22.61
		RB Size=1, RB Offset=49	0	0	22.60	22.84	22.75
		RB Size=25, RB Offset=0	1	1	21.78	21.85	21.73
		RB Size=25, RB Offset=12	1	1	21.49	21.87	21.84
		RB Size=25, RB Offset=24	1	1	21.68	21.55	21.80
	16QAM	RB Size=50, RB Offset=0	1	1	21.84	21.86	21.65
		RB Size=1, RB Offset=0	1	1	22.12	22.20	22.29
		RB Size=1, RB Offset=24	1	1	21.99	22.07	22.21
		RB Size=1, RB Offset=49	1	1	22.03	22.23	22.22
		RB Size=25, RB Offset=0	2	2	20.87	20.80	20.90
		RB Size=25, RB Offset=12	2	2	20.80	20.56	21.01
		RB Size=25, RB Offset=24	2	2	20.71	20.75	20.67
RB Size=50, RB Offset=0	2	2	20.97	20.91	20.79		

BW (MHz)	Modulation	Resource Block Size & Resource Block Offset	Target MPR	Meas MPR	Ave Tx Power (dBm)		
					Low Channel	Mid Channel	High Channel
					1717.5MHz	1732.5MHz	1747.5MHz
15	QPSK	RB Size=1, RB Offset=0	0	0	22.61	22.53	22.59
		RB Size=1, RB Offset=37	0	0	22.69	22.46	22.36
		RB Size=1, RB Offset=74	0	0	22.52	22.50	22.55
		RB Size=36, RB Offset=0	1	1	21.98	21.90	21.98
		RB Size=36, RB Offset=18	1	1	21.90	21.70	21.77
		RB Size=36, RB Offset=37	1	1	22.13	21.70	21.74
		RB Size=75, RB Offset=0	1	1	21.62	21.59	21.61
	16QAM	RB Size=1, RB Offset=0	1	1	21.66	21.53	21.68
		RB Size=1, RB Offset=37	1	1	21.69	21.57	21.62
		RB Size=1, RB Offset=74	1	1	21.46	21.53	21.42
		RB Size=36, RB Offset=0	2	2	20.82	20.72	20.77
		RB Size=36, RB Offset=18	2	2	20.91	20.63	20.70
		RB Size=36, RB Offset=37	2	2	20.50	20.47	20.57
		RB Size=75, RB Offset=0	2	2	20.82	20.74	20.98
BW (MHz)	Modulation	Resource Block Size & Resource Block Offset	Target MPR	Meas MPR	Ave Tx Power (dBm)		
					Low Channel	Mid Channel	High Channel
					1720MHz	1732.5MHz	1745MHz
20	QPSK	RB Size=1, RB Offset=0	0	0	22.43	22.81	22.57
		RB Size=1, RB Offset=49	0	0	22.38	22.43	22.36
		RB Size=1, RB Offset=99	0	0	22.51	22.48	22.44
		RB Size=50, RB Offset=0	1	1	22.02	22.21	21.92
		RB Size=50, RB Offset=24	1	1	21.87	21.75	21.80
		RB Size=50, RB Offset=49	1	1	21.95	21.61	21.83
		RB Size=100, RB Offset=0	1	1	21.75	21.55	21.56
	16QAM	RB Size=1, RB Offset=0	1	1	21.70	21.54	21.64
		RB Size=1, RB Offset=49	1	1	21.82	21.50	21.70
		RB Size=1, RB Offset=99	1	1	21.55	21.52	21.51
		RB Size=50, RB Offset=0	2	2	20.81	20.68	20.62
		RB Size=50, RB Offset=24	2	2	20.92	20.53	20.61
		RB Size=50, RB Offset=49	2	2	20.58	20.47	20.50
		RB Size=100, RB Offset=0	2	2	20.67	20.74	20.93

LTE Band 5:

BW (MHz)	Modulation	Resource Block Size & Resource Block Offset	Target MPR	Meas MPR	Ave Tx Power (dBm)		
					Low Channel	Mid Channel	High Channel
					824.7MHz	836.5MHz	848.3MHz
1.4	QPSK	RB Size=1, RB Offset=0	0	0	22.75	22.72	22.66
		RB Size=1, RB Offset=2	0	0	22.74	22.66	22.52
		RB Size=1, RB Offset=5	0	0	22.35	22.59	22.54
		RB Size=3, RB Offset=0	1	1	22.34	22.35	22.28
		RB Size=3, RB Offset=1	1	1	22.17	22.33	22.26
		RB Size=3, RB Offset=2	1	1	22.32	22.31	22.22
		RB Size=6, RB Offset=0	1	1	22.08	22.23	22.25
	16QAM	RB Size=1, RB Offset=0	1	1	22.17	22.10	22.15
		RB Size=1, RB Offset=2	1	1	22.13	22.00	21.94
		RB Size=1, RB Offset=5	1	1	22.06	22.06	22.90
		RB Size=3, RB Offset=0	2	2	21.88	21.68	22.86
		RB Size=3, RB Offset=1	2	2	21.80	21.84	21.84
		RB Size=3, RB Offset=2	2	2	22.01	21.74	21.88
		RB Size=6, RB Offset=0	2	2	21.69	21.72	21.83
BW (MHz)	Modulation	Resource Block Size & Resource Block Offset	Target MPR	Meas MPR	Ave Tx Power (dBm)		
					Low Channel	Mid Channel	High Channel
					825.5MHz	836.5MHz	847.5MHz
3	QPSK	RB Size=1, RB Offset=0	0	0	22.84	22.74	22.95
		RB Size=1, RB Offset=7	0	0	22.73	22.77	22.90
		RB Size=1, RB Offset=14	0	0	22.59	22.73	22.86
		RB Size=8, RB Offset=0	1	1	22.06	21.97	21.84
		RB Size=8, RB Offset=4	1	1	21.78	21.67	21.74
		RB Size=8, RB Offset=7	1	1	21.60	21.62	21.72
		RB Size=15, RB Offset=0	1	1	21.87	21.77	21.90
	16QAM	RB Size=1, RB Offset=0	1	1	22.03	22.20	22.07
		RB Size=1, RB Offset=7	1	1	22.12	22.03	22.11
		RB Size=1, RB Offset=14	1	1	22.35	21.83	22.00
		RB Size=8, RB Offset=0	2	2	20.94	20.79	20.96
		RB Size=8, RB Offset=4	2	2	20.60	20.81	20.93
		RB Size=8, RB Offset=7	2	2	20.52	20.59	20.80
		RB Size=15, RB Offset=0	2	2	20.85	20.73	20.76

BW (MHz)	Modulation	Resource Block Size & Resource Block Offset	Target MPR	Meas MPR	Ave Tx Power (dBm)		
					Low Channel	Mid Channel	High Channel
					826.5MHz	836.5MHz	846.5MHz
5	QPSK	RB Size=1, RB Offset=0	0	0	22.91	22.64	22.75
		RB Size=1, RB Offset=12	0	0	22.59	22.58	22.68
		RB Size=1, RB Offset=24	0	0	22.63	22.42	22.69
		RB Size=12, RB Offset=0	1	1	21.67	21.69	21.59
		RB Size=12, RB Offset=6	1	1	21.78	21.73	21.78
		RB Size=12, RB Offset=11	1	1	21.51	21.69	21.73
	16QAM	RB Size=25, RB Offset=0	1	1	21.73	21.73	21.64
		RB Size=1, RB Offset=0	1	1	21.95	21.94	21.93
		RB Size=1, RB Offset=12	1	1	21.82	21.69	21.61
		RB Size=1, RB Offset=24	1	1	21.72	21.82	21.80
		RB Size=12, RB Offset=0	2	2	20.94	21.10	20.95
		RB Size=12, RB Offset=6	2	2	20.79	20.97	20.96
		RB Size=12, RB Offset=11	2	2	20.82	20.79	20.94
		RB Size=25, RB Offset=0	2	2	20.98	20.81	20.60
BW (MHz)	Modulation	Resource Block Size & Resource Block Offset	Target MPR	Meas MPR	Ave Tx Power (dBm)		
					Low Channel	Mid Channel	High Channel
					829MHz	836.5MHz	844MHz
10	QPSK	RB Size=1, RB Offset=0	0	0	22.72	22.80	22.80
		RB Size=1, RB Offset=24	0	0	22.70	22.82	22.86
		RB Size=1, RB Offset=49	0	0	22.67	22.77	22.67
		RB Size=25, RB Offset=0	1	1	21.71	21.95	21.71
		RB Size=25, RB Offset=12	1	1	21.87	21.78	21.68
		RB Size=25, RB Offset=24	1	1	21.85	21.49	21.38
	16QAM	RB Size=50, RB Offset=0	1	1	21.61	21.54	21.62
		RB Size=1, RB Offset=0	1	1	21.71	21.76	21.59
		RB Size=1, RB Offset=24	1	1	21.75	21.47	21.52
		RB Size=1, RB Offset=49	1	1	21.45	21.44	21.77
		RB Size=25, RB Offset=0	2	2	22.58	20.87	20.84
		RB Size=25, RB Offset=12	2	2	22.51	20.55	20.62
		RB Size=25, RB Offset=24	2	2	22.62	20.38	20.40
		RB Size=50, RB Offset=0	2	2	20.62	20.38	20.44

LTE Band 7:

BW (MHz)	Modulation	Resource Block Size & Resource Block Offset	Target MPR	Meas MPR	Ave Tx Power (dBm)		
					Low Channel	Mid Channel	High Channel
					2510MHz	2535MHz	2560MHz
5	QPSK	RB Size=1, RB Offset=0	0	0	23.23	22.89	22.64
		RB Size=1, RB Offset=12	0	0	22.69	22.50	22.20
		RB Size=1, RB Offset=24	0	0	23.35	22.97	22.81
		RB Size=12, RB Offset=0	1	1	21.98	21.58	21.26
		RB Size=12, RB Offset=6	1	1	21.94	21.54	21.53
		RB Size=12, RB Offset=11	1	1	22.22	21.59	21.44
		RB Size=25, RB Offset=0	1	1	22.13	21.56	22.18
	16QAM	RB Size=1, RB Offset=0	1	1	22.49	21.93	22.05
		RB Size=1, RB Offset=12	1	1	22.52	21.86	22.03
		RB Size=1, RB Offset=24	1	1	22.59	21.91	22.27
		RB Size=12, RB Offset=0	2	2	21.78	21.11	21.38
		RB Size=12, RB Offset=6	2	2	21.70	21.20	21.23
		RB Size=12, RB Offset=11	2	2	21.60	20.98	21.44
		RB Size=25, RB Offset=0	2	2	21.07	20.70	20.57
BW (MHz)	Modulation	Resource Block Size & Resource Block Offset	Target MPR	Meas MPR	Ave Tx Power (dBm)		
					Low Channel	Mid Channel	High Channel
					2510MHz	2535MHz	2560MHz
10	QPSK	RB Size=1, RB Offset=0	0	0	22.70	22.32	22.79
		RB Size=1, RB Offset=24	0	0	22.60	22.48	22.82
		RB Size=1, RB Offset=49	0	0	22.59	22.17	22.79
		RB Size=25, RB Offset=0	1	1	21.82	21.57	22.02
		RB Size=25, RB Offset=12	1	1	21.95	21.87	21.99
		RB Size=25, RB Offset=24	1	1	21.82	21.82	22.11
		RB Size=50, RB Offset=0	1	1	21.98	21.36	21.62
	16QAM	RB Size=1, RB Offset=0	1	1	21.79	22.12	21.79
		RB Size=1, RB Offset=24	1	1	21.57	22.11	21.86
		RB Size=1, RB Offset=49	1	1	21.71	22.32	22.09
		RB Size=25, RB Offset=0	2	2	20.95	21.25	21.20
		RB Size=25, RB Offset=12	2	2	21.28	21.22	21.13
		RB Size=25, RB Offset=24	2	2	20.91	21.39	21.31
		RB Size=50, RB Offset=0	2	2	21.08	20.54	20.75

BW (MHz)	Modulation	Resource Block Size & Resource Block Offset	Target MPR	Meas MPR	Ave Tx Power (dBm)		
					Low Channel	Mid Channel	High Channel
					2510MHz	2535MHz	2560MHz
15	QPSK	RB Size=1, RB Offset=0	0	0	22.82	22.69	23.96
		RB Size=1, RB Offset=37	0	0	22.57	22.59	23.63
		RB Size=1, RB Offset=74	0	0	22.76	22.66	23.90
		RB Size=36, RB Offset=0	1	1	21.99	22.03	22.98
		RB Size=36, RB Offset=18	1	1	21.88	21.64	23.19
		RB Size=36, RB Offset=37	1	1	21.99	21.91	23.00
		RB Size=75, RB Offset=0	1	1	22.01	21.43	22.14
	16QAM	RB Size=1, RB Offset=0	1	1	22.11	21.83	22.53
		RB Size=1, RB Offset=37	1	1	21.89	21.44	22.60
		RB Size=1, RB Offset=74	1	1	22.15	21.72	22.81
		RB Size=36, RB Offset=0	2	2	21.29	21.06	21.93
		RB Size=36, RB Offset=18	2	2	21.27	21.05	21.76
		RB Size=36, RB Offset=37	2	2	21.19	21.10	21.85
		RB Size=75, RB Offset=0	2	2	20.79	20.56	21.51
BW (MHz)	Modulation	Resource Block Size & Resource Block Offset	Target MPR	Meas MPR	Ave Tx Power (dBm)		
					Low Channel	Mid Channel	High Channel
					2510MHz	2535MHz	2560MHz
20	QPSK	RB Size=1, RB Offset=0	0	0	23.58	23.81	23.68
		RB Size=1, RB Offset=49	0	0	22.65	23.47	23.33
		RB Size=1, RB Offset=99	0	0	22.99	23.04	23.77
		RB Size=50, RB Offset=0	1	1	23.28	23.69	23.55
		RB Size=50, RB Offset=24	1	1	23.01	23.07	23.57
		RB Size=50, RB Offset=49	1	1	22.87	22.87	23.71
		RB Size=100, RB Offset=0	1	1	23.26	23.48	23.27
	16QAM	RB Size=1, RB Offset=0	1	1	22.10	22.40	22.76
		RB Size=1, RB Offset=49	1	1	21.98	22.35	22.72
		RB Size=1, RB Offset=99	1	1	22.12	22.12	23.07
		RB Size=50, RB Offset=0	2	2	21.37	21.45	22.03
		RB Size=50, RB Offset=24	2	2	21.45	21.57	22.18
		RB Size=50, RB Offset=49	2	2	21.34	21.45	21.98
		RB Size=100, RB Offset=0	2	2	21.35	20.88	21.47

LTE Band 12:

BW	Modulation	Resource Block Size& Resource Block Offset	Target MPR	Meas MPR	Ave Tx Power (dBm)		
					Low Channel	Mid Channel	High Channel
					699.7MHz	707.5MHz	715.3MHz
1.4M	QPSK	RB Size=1, RB Offset=0	0	0	23.02	23.04	22.98
		RB Size=1, RB Offset=2	0	0	22.91	23.07	23.06
		RB Size=1, RB Offset=5	0	0	22.91	22.92	22.87
		RB Size=3, RB Offset=0	1	1	22.85	23.02	22.99
		RB Size=3, RB Offset=1	1	1	22.94	23.14	23.10
		RB Size=3, RB Offset=2	1	1	22.72	22.89	22.98
		RB Size=6, RB Offset=0	1	1	22.02	22.02	21.94
	16QAM	RB Size=1, RB Offset=0	1	1	21.98	21.91	22.12
		RB Size=1, RB Offset=2	1	1	21.93	21.84	21.84
		RB Size=1, RB Offset=5	1	1	22.00	21.72	21.71
		RB Size=3, RB Offset=0	2	2	22.06	22.27	22.33
		RB Size=3, RB Offset=1	2	2	22.23	22.11	22.18
		RB Size=3, RB Offset=2	2	2	21.89	22.14	22.11
		RB Size=6, RB Offset=0	2	2	20.82	21.07	20.87
BW	Modulation	Resource Block Size& Resource Block Offset	Target MPR	Meas MPR	Ave Tx Power (dBm)		
					Low Channel	Mid Channel	High Channel
					700.5MHz	707.5MHz	714.5MHz
3M	QPSK	RB Size=1, RB Offset=0	0	0	22.93	22.94	23.07
		RB Size=1, RB Offset=7	0	0	22.71	23.01	23.08
		RB Size=1, RB Offset=14	0	0	22.60	22.85	22.83
		RB Size=8, RB Offset=0	1	1	22.05	21.89	21.98
		RB Size=8, RB Offset=4	1	1	21.90	22.06	22.04
		RB Size=8, RB Offset=7	1	1	22.11	21.87	21.75
		RB Size=15, RB Offset=0	1	1	22.00	22.06	22.05
	16QAM	RB Size=1, RB Offset=0	1	1	22.44	22.47	22.54
		RB Size=1, RB Offset=7	1	1	22.42	22.46	22.44
		RB Size=1, RB Offset=14	1	1	22.14	22.08	22.32
		RB Size=8, RB Offset=0	2	2	21.12	21.12	21.33
		RB Size=8, RB Offset=4	2	2	21.16	21.08	21.20
		RB Size=8, RB Offset=7	2	2	21.00	21.04	21.24
		RB Size=15, RB Offset=0	2	2	21.08	21.00	21.12

BW	Modulation	Resource Block Size& Resource Block Offset	Target MPR	Meas MPR	Ave Tx Power (dBm)		
					Low Channel	Mid Channel	High Channel
					701.5MHz	707.5MHz	713.5MHz
5M	QPSK	RB Size=1, RB Offset=0	0	0	21.94	21.98	22.22
		RB Size=1, RB Offset=12	0	0	21.89	21.93	21.71
		RB Size=1, RB Offset=24	0	0	21.94	21.93	21.65
		RB Size=12, RB Offset=0	1	1	21.21	21.23	21.26
		RB Size=12, RB Offset=6	1	1	20.87	21.22	21.01
		RB Size=12, RB Offset=11	1	1	20.78	21.15	21.05
	16QAM	RB Size=25, RB Offset=0	1	1	21.96	22.08	21.94
		RB Size=1, RB Offset=0	1	1	21.96	21.96	22.06
		RB Size=1, RB Offset=12	1	1	21.82	21.83	21.86
		RB Size=1, RB Offset=24	1	1	21.91	21.71	21.85
		RB Size=12, RB Offset=0	2	2	21.41	21.05	21.12
		RB Size=12, RB Offset=6	2	2	21.07	21.07	21.12
		RB Size=12, RB Offset=11	2	2	20.98	21.07	21.09
		RB Size=25, RB Offset=0	2	2	21.07	20.99	21.03
BW	Modulation	Resource Block Size& Resource Block Offset	Target MPR	Meas MPR	Ave Tx Power (dBm)		
					Low Channel	Mid Channel	High Channel
					704MHz	707.5MHz	711MHz
10M	QPSK	RB Size=1, RB Offset=0	0	0	23.01	23.14	23.01
		RB Size=1, RB Offset=24	0	0	23.14	22.92	23.00
		RB Size=1, RB Offset=49	0	0	22.87	23.30	22.82
		RB Size=25, RB Offset=0	1	1	21.98	22.04	22.16
		RB Size=25, RB Offset=12	1	1	22.05	22.17	22.20
		RB Size=25, RB Offset=24	1	1	21.73	21.90	21.80
	16QAM	RB Size=50, RB Offset=0	1	1	22.21	23.06	22.01
		RB Size=1, RB Offset=0	1	1	22.49	22.62	22.65
		RB Size=1, RB Offset=24	1	1	22.65	22.30	22.40
		RB Size=1, RB Offset=49	1	1	22.51	22.23	22.18
		RB Size=25, RB Offset=0	2	2	21.18	21.12	21.27
		RB Size=25, RB Offset=12	2	2	21.01	21.27	21.03
		RB Size=25, RB Offset=24	2	2	21.01	21.14	21.04
		RB Size=50, RB Offset=0	2	2	21.22	21.06	21.15

LTE Band 13:

BW	Modulation	Resource Block Size& Resource Block Offset	Target MPR	Meas MPR	Ave Tx Power (dBm)		
					Low Channel	Mid Channel	High Channel
					779.5 MHz	782 MHz	784.5 MHz
5M	QPSK	RB Size=1, RB Offset=0	0	0	22.03	22.13	22.00
		RB Size=1, RB Offset=12	0	0	21.88	21.92	21.81
		RB Size=1, RB Offset=24	0	0	22.03	21.82	21.71
		RB Size=12, RB Offset=0	1	1	21.23	21.19	21.11
		RB Size=12, RB Offset=6	1	1	20.88	21.11	21.04
		RB Size=12, RB Offset=11	1	1	20.64	21.22	21.12
	16QAM	RB Size=25, RB Offset=0	1	1	22.11	21.95	22.11
		RB Size=1, RB Offset=0	1	1	21.93	22.09	21.94
		RB Size=1, RB Offset=12	1	1	21.89	21.74	21.92
		RB Size=1, RB Offset=24	1	1	21.91	21.66	21.98
		RB Size=12, RB Offset=0	2	2	21.27	21.11	21.23
		RB Size=12, RB Offset=6	2	2	21.04	21.19	21.05
		RB Size=12, RB Offset=11	2	2	20.88	20.91	21.14
		RB Size=25, RB Offset=0	2	2	21.18	21.05	21.00
BW	Modulation	Resource Block Size& Resource Block Offset	Target MPR	Meas MPR	Ave Tx Power (dBm)		
					Low Channel	Mid Channel	High Channel
					/	782 MHz	/
10M	QPSK	RB Size=1, RB Offset=0	0	0	/	23.20	/
		RB Size=1, RB Offset=24	0	0	/	22.97	/
		RB Size=1, RB Offset=49	0	0	/	23.16	/
		RB Size=25, RB Offset=0	1	1	/	22.53	/
		RB Size=25, RB Offset=12	1	1	/	22.40	/
		RB Size=25, RB Offset=24	1	1	/	22.02	/
	16QAM	RB Size=50, RB Offset=0	1	1	/	22.04	/
		RB Size=1, RB Offset=0	1	1	/	22.72	/
		RB Size=1, RB Offset=24	1	1	/	22.41	/
		RB Size=1, RB Offset=49	1	1	/	22.13	/
		RB Size=25, RB Offset=0	2	2	/	21.14	/
		RB Size=25, RB Offset=12	2	2	/	21.22	/
		RB Size=25, RB Offset=24	2	2	/	21.29	/
		RB Size=50, RB Offset=0	2	2	/	21.09	/

LTE Band 17:

BW	Modulation	Resource Block Size & Resource Block Offset	Target MPR	Meas MPR	Ave Tx Power (dBm)		
					Low Channel	Mid Channel	High Channel
					706.5 MHz	710 MHz	713.5 MHz
5M	QPSK	RB Size=1, RB Offset=0	0	0	22.06	22.05	22.08
		RB Size=1, RB Offset=12	0	0	22.01	21.89	21.87
		RB Size=1, RB Offset=24	0	0	21.85	21.77	21.77
		RB Size=12, RB Offset=0	1	1	21.32	21.18	21.18
		RB Size=12, RB Offset=6	1	1	20.99	21.13	21.15
		RB Size=12, RB Offset=11	1	1	20.87	21.21	20.84
	16QAM	RB Size=25, RB Offset=0	1	1	22.01	21.99	21.89
		RB Size=1, RB Offset=0	1	1	22.05	21.94	22.18
		RB Size=1, RB Offset=12	1	1	21.94	21.78	22.09
		RB Size=1, RB Offset=24	1	1	22.08	21.77	21.96
		RB Size=12, RB Offset=0	2	2	21.31	21.35	21.21
		RB Size=12, RB Offset=6	2	2	21.07	20.96	21.21
		RB Size=12, RB Offset=11	2	2	20.92	20.94	21.08
		RB Size=25, RB Offset=0	2	2	21.10	21.10	21.16
BW	Modulation	Resource Block Size & Resource Block Offset	Target MPR	Meas MPR	Ave Tx Power (dBm)		
					Low Channel	Mid Channel	High Channel
					709 MHz	710 MHz	711 MHz
10M	QPSK	RB Size=1, RB Offset=0	0	0	23.06	23.01	23.11
		RB Size=1, RB Offset=24	0	0	22.83	22.88	22.87
		RB Size=1, RB Offset=49	0	0	23.08	23.11	22.88
		RB Size=25, RB Offset=0	1	1	22.14	22.04	22.02
		RB Size=25, RB Offset=12	1	1	22.05	21.88	22.11
		RB Size=25, RB Offset=24	1	1	21.67	22.36	21.96
		RB Size=50, RB Offset=0	1	1	22.12	22.15	22.09
	16QAM	RB Size=1, RB Offset=0	1	1	22.60	22.75	22.65
		RB Size=1, RB Offset=24	1	1	22.70	22.51	22.44
		RB Size=1, RB Offset=49	1	1	22.41	22.22	22.32
		RB Size=25, RB Offset=0	2	2	21.33	21.13	21.10
		RB Size=25, RB Offset=12	2	2	20.97	21.10	20.97
		RB Size=25, RB Offset=24	2	2	21.12	21.28	21.06
		RB Size=50, RB Offset=0	2	2	21.16	21.25	21.05

Note:

1. SAR for LTE band exposure configurations is measured according to the procedures of KDB 941225 D05 SAR for LTE Devices v02.
2. The CMW500 Wideband Radio Communication tester is used for LTE output power measurements and SAR testing. Closed loop power control is used to keep the radio transmitters the max output power during the test.

WLAN 2.4G:

Mode	Channel frequency (MHz)	Data Rate	RF Output Power(dBm)
802.11b	2412	1Mbps	9.55
	2437		9.66
	2462		8.15
802.11g	2412	6Mbps	8.32
	2437		8.23
	2462		7.25
802.11n HT20	2412	MCS0	8.41
	2437		8.42
	2462		7.18

Bluetooth:

Mode	Channel frequency (MHz)	RF Output Power (dBm)
BDR(GFSK)	2402	8.06
	2441	7.85
	2480	7.64
EDR($\pi/4$ -DQPSK)	2402	6.61
	2441	6.47
	2480	5.98
EDR(8-DPSK)	2402	6.77
	2441	6.55
	2480	6.31
Bluetooth LE	2402	-3.13
	2440	-0.92
	2480	-1.52

Standalone SAR test exclusion considerations

Antennas Location:

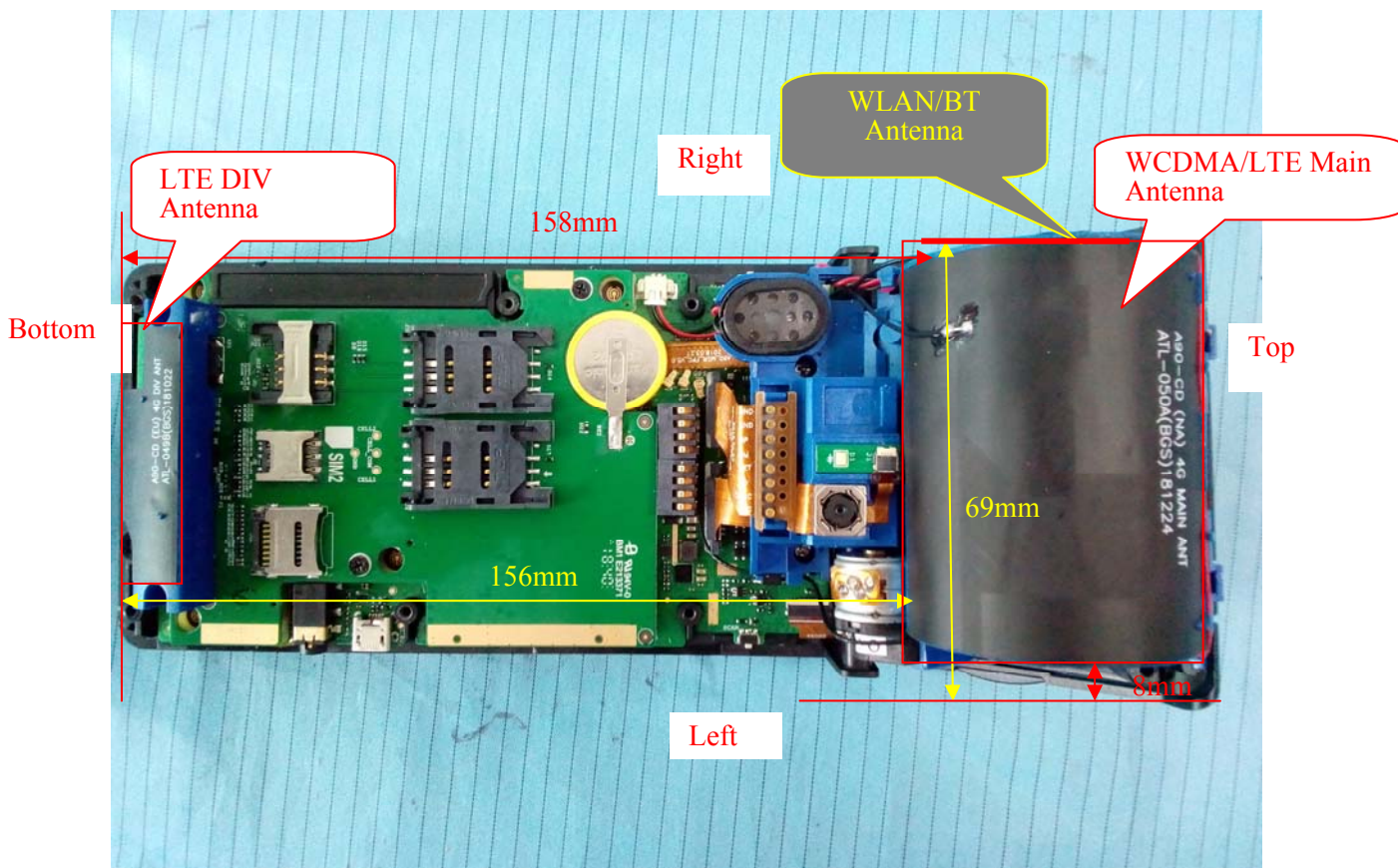

Antenna Distance To Edge

Antenna Distance To Edge(mm)					
Antenna	Back	Left	Right	Top	Bottom
WWAN(GSM/WCDMA/LTE)	< 5	8	< 5	< 5	156
WLAN/BT Antenna	< 5	69	< 5	< 5	158

Standalone SAR test exclusion considerations

Mode	EUT Position	Frequency (MHz)	P _{avg} (dBm)	P _{avg} (mW)	Distance (mm)	Calculated value	Threshold (10-g)	SAR Test Exclusion
WLAN	Handheld	2462	10.0	10.00	0	3.1	7.5	YES
Bluetooth	Handheld	2480	8.5	7.08	0	2.2	7.5	YES

NOTE:

The 1-g and 10-g SAR test exclusion thresholds for 100 MHz to 6 GHz at test separation distances ≤ 50 mm are determined by:

$$[(\text{max. power of channel, including tune-up tolerance, mW}) / (\text{min. test separation distance, mm})] \cdot [\sqrt{f(\text{GHz})}] \leq 3.0 \text{ for 1-g SAR and } \leq 7.5 \text{ for 10-g extremity SAR, where}$$

1. f(GHz) is the RF channel transmit frequency in GHz.
2. Power and distance are rounded to the nearest mW and mm before calculation.
3. The result is rounded to one decimal place for comparison.
4. When the minimum test separation distance is < 5 mm, a distance of 5 mm is applied to determine SAR test Exclusion.

SAR test exclusion for the EUT edge considerations Result

Exclusion Result					
Mode	Back	Left	Right	Top	Bottom
BT	Required	Exclusion*	Exclusion*	Exclusion*	Exclusion*
WLAN	Required	Exclusion*	Exclusion*	Exclusion*	Exclusion*
WWAN(WCDMA/LTE)	Required	Required	Required	Required	Exclusion*

Note:

- Required:** The distance to Edge is less than 25mm, testing is required.
- Exclusion*:** SAR test exclusion evaluation has been done above.
- Exclusion:** The distance to Edge is more than 25 mm, testing is not required.

Standalone SAR estimation:

Mode	Position	Max tune-up power		Distance (mm)	Estimated _{10-g} (W/kg)
		(dBm)	(mW)		
Bluetooth	Handheld	8.5	7.08	0	0.12
WLAN	Handheld	10.0	10.00	0	0.17

When standalone SAR test exclusion applies to an antenna that transmits simultaneously with other antennas, the standalone SAR must be estimated according to following to determine simultaneous transmission SAR test exclusion:

$$[(\text{max. power of channel, including tune-up tolerance, mW})/(\text{min. test separation distance, mm})] \cdot [\sqrt{f(\text{GHz})}/x]$$

W/kg for test separation distances ≤ 50 mm;

where $x = 7.5$ for 1-g SAR and $x = 18.75$ for 10-g SAR.

When the minimum test separation distance is < 5 mm, a distance of 5 mm is applied to determine SAR test Exclusion

SAR MEASUREMENT RESULTS

This page summarizes the results of the performed dosimetric evaluation.

SAR Test Data

Environmental Conditions

Temperature:	21.3-22.6 °C	21.5-22.9 °C	21.6-23.3 °C
Relative Humidity:	53 %	57%	56 %
ATM Pressure:	101.6 kPa	101.1 kPa	102.2 kPa
Test Date:	2019/03/05	2019/03/06	2019/03/07

Testing was performed by Huan Li, Gavin Guo

WCDMA Band 2:

EUT Position	Frequency (MHz)	Test Mode	Max. Meas. Power (dBm)	Max. Rated Power (dBm)	1g SAR (W/Kg)			
					Scaled Factor	Meas. SAR	Scaled SAR	Plot
Body Back (0mm)	1852.4	RMC	22.25	22.5	1.059	0.734	0.78	1#
	1880	RMC	22.40	22.5	1.023	0.884	0.90	2#
	1907.6	RMC	22.18	22.5	1.076	0.725	0.78	3#

EUT Position	Frequency (MHz)	Test Mode	Max. Meas. Power (dBm)	Max. Rated Power (dBm)	10g SAR (W/Kg)			
					Scaled Factor	Meas. SAR	Scaled SAR	Plot
Handheld Left (0mm)	1852.4	RMC	/	/	/	/	/	/
	1880	RMC	22.40	22.5	1.023	0.033	0.03	4#
	1907.6	RMC	/	/	/	/	/	/
Handheld Right (0mm)	1852.4	RMC	/	/	/	/	/	/
	1880	RMC	22.40	22.5	1.023	0.047	0.05	5#
	1907.6	RMC	/	/	/	/	/	/
Handheld Top (0mm)	1852.4	RMC	/	/	/	/	/	/
	1880	RMC	22.40	22.5	1.023	0.070	0.07	6#
	1907.6	RMC	/	/	/	/	/	/

WCDMA Band 4:

EUT Position	Frequency (MHz)	Test Mode	Max. Meas. Power (dBm)	Max. Rated Power (dBm)	1g SAR (W/Kg)			
					Scaled Factor	Meas. SAR	Scaled SAR	Plot
Body Back (0mm)	1712.4	RMC	22.15	22.4	1.059	0.905	0.96	7#
	1732.6	RMC	22.37	22.4	1.007	0.886	0.89	8#
	1752.6	RMC	22.23	22.4	1.040	0.806	0.84	9#

EUT Position	Frequency (MHz)	Test Mode	Max. Meas. Power (dBm)	Max. Rated Power (dBm)	10g SAR (W/Kg)			
					Scaled Factor	Meas. SAR	Scaled SAR	Plot
Handheld Left (0mm)	1712.4	RMC	/	/	/	/	/	/
	1732.6	RMC	22.37	22.4	1.007	0.059	0.06	10#
	1752.6	RMC	/	/	/	/	/	/
Handheld Right (0mm)	1712.4	RMC	/	/	/	/	/	/
	1732.6	RMC	22.37	22.4	1.007	0.054	0.05	11#
	1752.6	RMC	/	/	/	/	/	/
Handheld Top (0mm)	1712.4	RMC	/	/	/	/	/	/
	1732.6	RMC	22.37	22.4	1.007	0.086	0.09	12#
	1752.6	RMC	/	/	/	/	/	/

WCDMA Band 5:

EUT Position	Frequency (MHz)	Test Mode	Max. Meas. Power (dBm)	Max. Rated Power (dBm)	1g SAR (W/Kg)			
					Scaled Factor	Meas. SAR	Scaled SAR	Plot
Body Back (0mm)	826.4	RMC	/	/	/	/	/	/
	836.6	RMC	22.41	22.6	1.045	0.262	0.27	13#
	846.6	RMC	/	/	/	/	/	/

EUT Position	Frequency (MHz)	Test Mode	Max. Meas. Power (dBm)	Max. Rated Power (dBm)	10g SAR (W/Kg)			
					Scaled Factor	Meas. SAR	Scaled SAR	Plot
Handheld Left (0mm)	826.4	RMC	/	/	/	/	/	/
	836.6	RMC	22.41	22.6	1.045	0.052	0.05	14#
	846.6	RMC	/	/	/	/	/	/
Handheld Right (0mm)	826.4	RMC	/	/	/	/	/	/
	836.6	RMC	22.41	22.6	1.045	0.020	0.02	15#
	846.6	RMC	/	/	/	/	/	/
Handheld Top (0mm)	826.4	RMC	/	/	/	/	/	/
	836.6	RMC	22.41	22.6	1.045	0.073	0.08	16#
	846.6	RMC	/	/	/	/	/	/

Note:

1. For Body-worn mode, when the 1-g SAR is $\leq 0.8\text{W/Kg}$, testing for other channels are optional.
2. For Handheld mode, when the 10-g SAR is $\leq 2.0\text{W/Kg}$, testing for other channels are optional.
3. The EUT transmit and receive through the same antenna while testing SAR.
4. The default test configuration is to measure SAR with an established radio link between the EUT and a communication test set using a 12.2 kbps RMC (reference measurement Channel) Configured in Test Loop Model.
5. When the maximum output power variation across the required test channels is $> \frac{1}{2}$ dB, instead of the middle channel, the highest output power channel must be used.
6. KDB 941225 D01-Body SAR is not required for HSDPA when the maximum average output of each RF channel is less than $\frac{1}{4}$ dB higher than measured 12.2kbps RMC or the maximum SAR for 12.2kbps RMC is $< 75\%$ of SAR limit.
7. When SAR or MPE is not measured at the maximum power level allowed for production units, the results must be scaled to the maximum tune-up tolerance limit according to the power applied to the individual channels tested to determine compliance.

LTE Band 2:

EUT Position	Frequency (MHz)	Bandwidth (MHz)	Test Mode	Max. Meas. Power (dBm)	Max. Rated Power (dBm)	1g SAR (W/Kg)			
						Scaled Factor	Meas. SAR	Scaled SAR	Plot
Body Back (0mm)	1860	20	1RB	/	/	/	/	/	/
	1880	20	1RB	22.96	23.2	1.057	0.745	0.79	17#
	1900	20	1RB	/	/	/	/	/	/
	1880	20	50%RB	22.69	23.2	1.125	0.578	0.65	18#

EUT Position	Frequency (MHz)	Bandwidth (MHz)	Test Mode	Max. Meas. Power (dBm)	Max. Rated Power (dBm)	10g SAR (W/Kg)			
						Scaled Factor	Meas. SAR	Scaled SAR	Plot
Handheld Left (0mm)	1860	20	1RB	/	/	/	/	/	/
	1880	20	1RB	22.96	23.2	1.057	0.029	0.03	19#
	1900	20	1RB	/	/	/	/	/	/
	1880	20	50%RB	22.69	23.2	1.125	0.029	0.03	20#
Handheld Right (0mm)	1860	20	1RB	/	/	/	/	/	/
	1880	20	1RB	22.96	23.2	1.057	0.047	0.05	21#
	1880	20	1RB	/	/	/	/	/	/
	1900	20	50%RB	22.69	23.2	1.125	0.020	0.02	22#
Handheld Top (0mm)	1860	20	1RB	/	/	/	/	/	/
	1880	20	1RB	22.96	23.2	1.057	0.092	0.10	23#
	1900	20	1RB	/	/	/	/	/	/
	1880	20	50%RB	22.69	23.2	1.125	0.075	0.08	24#

LTE Band 4:

EUT Position	Frequency (MHz)	Bandwidth (MHz)	Test Mode	Max. Meas. Power (dBm)	Max. Rated Power (dBm)	1g SAR (W/Kg)			
						Scaled Factor	Meas. SAR	Scaled SAR	Plot
Body Back (0mm)	1720	20	1RB	/	/	/	/	/	/
	1732.5	20	1RB	22.81	23.0	1.045	0.764	0.80	25#
	1745	20	1RB	/	/	/	/	/	/
	1732.5	20	50%RB	22.21	23.0	1.199	0.593	0.71	26#

EUT Position	Frequency (MHz)	Bandwidth (MHz)	Test Mode	Max. Meas. Power (dBm)	Max. Rated Power (dBm)	10g SAR (W/Kg)			
						Scaled Factor	Meas. SAR	Scaled SAR	Plot
Handheld Left (0mm)	1720	20	1RB	/	/	/	/	/	/
	1732.5	20	1RB	22.81	23.0	1.045	0.027	0.03	27#
	1745	20	1RB	/	/	/	/	/	/
	1732.5	20	50%RB	22.21	23.0	1.199	0.026	0.03	28#
Handheld Right (0mm)	1720	20	1RB	/	/	/	/	/	/
	1732.5	20	1RB	22.81	23.0	1.045	0.046	0.05	29#
	1745	20	1RB	/	/	/	/	/	/
	1732.5	20	50%RB	22.21	23.0	1.199	0.040	0.05	30#
Handheld Top (0mm)	1720	20	1RB	/	/	/	/	/	/
	1732.5	20	1RB	22.81	23.0	1.045	0.161	0.17	31#
	1745	20	1RB	/	/	/	/	/	/
	1732.5	20	50%RB	22.21	23.0	1.199	0.145	0.17	32#

LTE Band 5:

EUT Position	Frequency (MHz)	Bandwidth (MHz)	Test Mode	Max. Meas. Power (dBm)	Max. Rated Power (dBm)	1g SAR (W/Kg)			
						Scaled Factor	Meas. SAR	Scaled SAR	Plot
Body Back (0mm)	829	10	1RB	/	/	/	/	/	/
	836.5	10	1RB	22.82	23.1	1.067	0.412	0.44	33#
	844	10	1RB	/	/	/	/	/	/
	836.5	10	50%RB	21.95	23.1	1.303	0.350	0.46	34#

EUT Position	Frequency (MHz)	Bandwidth (MHz)	Test Mode	Max. Meas. Power (dBm)	Max. Rated Power (dBm)	10g SAR (W/Kg)			
						Scaled Factor	Meas. SAR	Scaled SAR	Plot
Handheld Left (0mm)	829	10	1RB	/	/	/	/	/	/
	836.5	10	1RB	22.82	23.1	1.067	0.175	0.19	35#
	844	10	1RB	/	/	/	/	/	/
	836.5	10	50%RB	21.95	23.1	1.303	0.143	0.19	36#
Handheld Right (0mm)	829	10	1RB	/	/	/	/	/	/
	836.5	10	1RB	22.82	23.1	1.067	0.159	0.17	37#
	844	10	1RB	/	/	/	/	/	/
	836.5	10	50%RB	21.95	23.1	1.303	0.130	0.17	38#
Handheld Top (0mm)	829	10	1RB	/	/	/	/	/	/
	836.5	10	1RB	22.82	23.1	1.067	0.101	0.11	39#
	844	10	1RB	/	/	/	/	/	/
	836.5	10	50%RB	21.95	23.1	1.303	0.087	0.11	40#

LTE Band 7:

EUT Position	Frequency (MHz)	Bandwidth (MHz)	Test Mode	Max. Meas. Power (dBm)	Max. Rated Power (dBm)	1g SAR (W/Kg)			
						Scaled Factor	Meas. SAR	Scaled SAR	Plot
Body Back (0mm)	2510	20	1RB	23.58	24.0	1.102	1.04	1.15	41#
	2535	20	1RB	23.81	24.0	1.045	1.29	1.35	42#
	2560	20	1RB	23.68	24.0	1.076	1.28	1.38	43#
	2510	20	50%RB	23.28	24.0	1.180	1.1	1.30	44#
	2535	20	50%RB	23.69	24.0	1.074	1.04	1.12	45#
	2560	20	50%RB	23.55	24.0	1.109	1.01	1.12	46#
	2510	20	100%RB	23.26	24.0	1.186	1.09	1.29	47#
	2535	20	100%RB	23.48	24.0	1.127	1.1	1.24	48#
	2560	20	100%RB	23.27	24.0	1.183	0.587	0.69	49#

EUT Position	Frequency (MHz)	Bandwidth (MHz)	Test Mode	Max. Meas. Power (dBm)	Max. Rated Power (dBm)	10g SAR (W/Kg)			
						Scaled Factor	Meas. SAR	Scaled SAR	Plot
Handheld Left (0mm)	2510	20	1RB	/	/	/	/	/	/
	2535	20	1RB	23.81	24.0	1.045	0.043	0.04	50#
	2560	20	1RB	/	/	/	/	/	/
	2535	20	50%RB	23.69	24.0	1.074	0.040	0.04	51#
Handheld Right (0mm)	2510	20	1RB	/	/	/	/	/	/
	2535	20	1RB	23.81	24.0	1.045	0.042	0.04	52#
	2560	20	1RB	/	/	/	/	/	/
	2535	20	50%RB	23.69	24.0	1.074	0.042	0.05	53#
Handheld Top (0mm)	2510	20	1RB	/	/	/	/	/	/
	2535	20	1RB	23.81	24.0	1.045	0.072	0.08	54#
	2560	20	1RB	/	/	/	/	/	/
	2535	20	50%RB	23.69	24.0	1.074	0.064	0.07	55#

LTE Band 12:

EUT Position	Frequency (MHz)	Bandwidth (MHz)	Test Mode	Max. Meas. Power (dBm)	Max. Rated Power (dBm)	1g SAR (W/Kg)			
						Scaled Factor	Meas. SAR	Scaled SAR	Plot
Body Back (0mm)	704	10	1RB	/	/	/	/	/	/
	707.5	10	1RB	23.3	23.5	1.047	0.249	0.26	56#
	711	10	1RB	/	/	/	/	/	/
	707.5	10	50%RB	22.17	23.5	1.358	0.197	0.27	57#

EUT Position	Frequency (MHz)	Bandwidth (MHz)	Test Mode	Max. Meas. Power (dBm)	Max. Rated Power (dBm)	10g SAR (W/Kg)			
						Scaled Factor	Meas. SAR	Scaled SAR	Plot
Handheld Left (0mm)	704	10	1RB	/	/	/	/	/	/
	707.5	10	1RB	23.3	23.5	1.047	0.155	0.16	58#
	711	10	1RB	/	/	/	/	/	/
	707.5	10	50%RB	22.17	23.5	1.358	0.116	0.16	59#
Handheld Right (0mm)	704	10	1RB	/	/	/	/	/	/
	707.5	10	1RB	23.3	23.5	1.047	0.146	0.15	60#
	711	10	1RB	/	/	/	/	/	/
	707.5	10	50%RB	22.17	23.5	1.358	0.110	0.15	61#
Handheld Top (0mm)	704	10	1RB	/	/	/	/	/	/
	707.5	10	1RB	23.3	23.5	1.047	0.159	0.17	62#
	711	10	1RB	/	/	/	/	/	/
	707.5	10	50%RB	22.17	23.5	1.358	0.121	0.16	63#

LTE Band 13:

EUT Position	Frequency (MHz)	Bandwidth (MHz)	Test Mode	Max. Meas. Power (dBm)	Max. Rated Power (dBm)	1g SAR (W/Kg)			
						Scaled Factor	Meas. SAR	Scaled SAR	Plot
Body Back (0mm)	782	10	1RB	23.2	23.3	1.023	0.326	0.33	64#
	782	10	50%RB	22.53	23.3	1.194	0.266	0.32	65#

EUT Position	Frequency (MHz)	Bandwidth (MHz)	Test Mode	Max. Meas. Power (dBm)	Max. Rated Power (dBm)	10g SAR (W/Kg)			
						Scaled Factor	Meas. SAR	Scaled SAR	Plot
Handheld Left (0mm)	782	10	1RB	23.2	23.3	1.023	0.275	0.28	66#
	782	10	50%RB	22.53	23.3	1.194	0.216	0.26	67#
Handheld Right (0mm)	782	10	1RB	23.2	23.3	1.023	0.159	0.16	68#
	782	10	50%RB	22.53	23.3	1.194	0.158	0.19	69#
Handheld Top (0mm)	782	10	1RB	23.2	23.3	1.023	0.015	0.02	70#
	782	10	50%RB	22.53	23.3	1.194	0.015	0.02	71#

LTE Band 17:

EUT Position	Frequency (MHz)	Bandwidth (MHz)	Test Mode	Max. Meas. Power (dBm)	Max. Rated Power (dBm)	1g SAR (W/Kg)			
						Scaled Factor	Meas. SAR	Scaled SAR	Plot
Body Back (0mm)	709	10	1RB	/	/	/	/	/	/
	710	10	1RB	23.11	23.3	1.045	0.287	0.30	72#
	711	10	1RB	/	/	/	/	/	/
	710	10	50%RB	22.36	23.3	1.242	0.233	0.29	73#

EUT Position	Frequency (MHz)	Bandwidth (MHz)	Test Mode	Max. Meas. Power (dBm)	Max. Rated Power (dBm)	10g SAR (W/Kg)			
						Scaled Factor	Meas. SAR	Scaled SAR	Plot
Handheld Left (0mm)	709	10	1RB	/	/	/	/	/	/
	710	10	1RB	23.11	23.3	1.045	0.145	0.15	74#
	711	10	1RB	/	/	/	/	/	/
	710	10	50%RB	22.36	23.3	1.242	0.113	0.14	75#
Handheld Right (0mm)	709	10	1RB	/	/	/	/	/	/
	710	10	1RB	23.11	23.3	1.045	0.139	0.15	76#
	711	10	1RB	/	/	/	/	/	/
	710	10	50%RB	22.36	23.3	1.242	0.109	0.14	77#
Handheld Top (0mm)	709	10	1RB	/	/	/	/	/	/
	710	10	1RB	23.11	23.3	1.045	0.014	0.01	78#
	711	10	1RB	/	/	/	/	/	/
	710	10	50%RB	22.36	23.3	1.242	0.013	0.02	79#

Note:

- SAR for LTE band exposure configurations is measured according to the procedures of KDB 941225 D05 SAR for LTE Devices v02.
- KDB941225D05- Start with the largest channel bandwidth and measure SAR for QPSK with 1 RB allocation, using the RB offset and required test channel combination with the highest maximum output power among RB offset the upper edge, middle and lower edge of each required test channel.
- When the 1-g SAR is ≤ 0.8 W/kg, testing for other channels are optional.
- The procedures required for 1 RB allocation are applied to measure the SAR for QPSK with 50% RB allocation.
- KDB941225D05- For QPSK with 100% RB allocation, SAR is not required when the highest maximum output power for 100 % RB allocation is less than the highest maximum output power in 50% and 1 RB allocations and the highest reported SAR for 1 RB and 50% RB allocation are ≤ 0.8 W/kg.
- KDB941225D05-For QPSK with 100% RB allocation, when the reported SAR measured for the Highest output power channel is < 1.45 W/kg, tests for the remaining required test channels are optional.
- KDB941225D05- other channel bandwidths SAR test is required when the highest maximum output power of a configuration requiring testing in the smaller channel bandwidth is $> \frac{1}{2}$ dB higher than the equivalent channel configurations in the largest channel bandwidth configuration or the reported SAR of a configuration for the largest channel bandwidth is > 1.45 W/kg.
- KDB941225D05-SAR for higher order modulation is required only when the highest maximum output power for the configuration in the higher order modulation is $> \frac{1}{2}$ dB higher than the same configuration in QPSK or when the reported SAR for the QPSK configuration is > 1.45 W/kg
- KDB 648474 D04-When the peak SAR located in regions that probe is unable to access, a flat phantom is used for SAR measurement.

Bluetooth

EUT Position	Frequency (MHz)	Test Mode	Meas. Avg. Power (dBm)	Max. Rated Avg. Power (dBm)	1 g SAR Value (W/Kg)			
					Scaled Factor	Meas. SAR	Scaled SAR	Plot
Body Back (0mm)	2402	GFSK	/	/	/	/	/	/
	2441	GFSK	7.85	8.5	1.161	0.152	0.18	80#
	2480	GFSK	/	/	/	/	/	/

Note:

1. When the 1-g SAR is ≤ 0.8W/Kg, testing for other channels are optional.
2. Since BDR(GFSK) mode power is the largest mode of Bluetooth, BDR(GFSK) mode is selected to test.
3. When SAR or MPE is not measured at the maximum power level allowed for production units, the results must be scaled to the maximum tune-up tolerance limit according to the power applied to the individual channels tested to determine compliance.

2.4G WLAN

EUT Position	Frequency (MHz)	Test Mode	Meas. Avg. Power (dBm)	Max. Rated Avg. Power (dBm)	1 g SAR Value (W/Kg)			
					Scaled Factor	Meas. SAR	Scaled SAR	Plot
Body Back (0mm)	2412	802.11b	/	/	/	/	/	/
	2437	802.11b	9.66	10.0	1.081	0.131	0.14	81#
	2462	802.11b	/	/	/	/	/	/

Note:

1. When the 1-g SAR is ≤ 0.8W/Kg, testing for other channels are optional.
2. When the highest reported SAR for DSSS is adjusted by the ratio of OFDM to DSSS specified maximum output power and the adjusted SAR is ≤ 1.2 W/kg, OFDM SAR is not required.
3. When SAR or MPE is not measured at the maximum power level allowed for production units, the results must be scaled to the maximum tune-up tolerance limit according to the power applied to the individual channels tested to determine compliance.

2.4 GHz 802.11g/n OFDM SAR Test Exclusion Consideration:

Modulation Mode	Pavg (dBm)	Pavg (mW)	Reported SAR(W/kg)	Adjusted SAR(W/kg)	Limit(W/kg)	SAR Test Exclusion
802.11b(DSSS)	10.0	10.00	0.14	/	/	/
802.11g(OFDM)	10.0	10.00	/	0.14	1.2	Yes
802.11n HT20(OFDM)	10.0	10.00	/	0.14	1.2	Yes

Note:

KDB 248227 D01-When SAR measurement is required for 2.4 GHz 802.11g/n OFDM configurations, the measurement and test reduction procedures for OFDM are applied. SAR is not required for the following 2.4 GHz OFDM conditions.

- a) When KDB Publication 447498 D01 SAR test exclusion applies to the OFDM configuration.
- b) When the highest reported SAR for DSSS is adjusted by the ratio of OFDM to DSSS specified maximum output power and the adjusted SAR is ≤ 1.2 W/kg.

SAR Measurement Variability

In accordance with published RF Exposure KDB procedure 865664 D01 SAR measurement 100 MHz to 6 GHz v01. These additional measurements are repeated after the completion of all measurements requiring the same head or body tissue-equivalent medium in a frequency band. The test device should be returned to ambient conditions (normal room temperature) with the battery fully charged before it is re-mounted on the device holder for the repeated measurement(s) to minimize any unexpected variations in the repeated results

- 1) Repeated measurement is not required when the original highest measured SAR is < 0.80 W/kg; steps 2) through 4) do not apply.
- 2) When the original highest measured SAR is ≥ 0.80 W/kg, repeat that measurement once.
- 3) Perform a second repeated measurement only if the ratio of largest to smallest SAR for the original and first repeated measurements is > 1.20 or when the original or repeated measurement is ≥ 1.45 W/kg (~ 10% from the 1-g SAR limit).
- 4) Perform a third repeated measurement only if the original, first or second repeated measurement is ≥ 1.5 W/kg and the ratio of largest to smallest SAR for the original, first and second repeated measurements is > 1.20.

Note: The same procedures should be adapted for measurements according to extremity and occupational exposure limits by applying a factor of 2.5 for extremity exposure and a factor of 5 for occupational exposure to the corresponding SAR thresholds.

The Highest Measured SAR Configuration in Each Frequency Band

Head

SAR probe calibration point	Frequency Band	Freq.(MHz)	EUT Position	Meas. SAR (W/kg)		Largest to Smallest SAR Ratio
				Original	Repeated	
/	/	/	/	/	/	/

Body

SAR probe calibration point	Frequency Band	Freq.(MHz)	EUT Position	Meas. SAR (W/kg)		Largest to Smallest SAR Ratio
				Original	Repeated	
1900MHz (1810-1920MHz)	WCDMA Band 2	1880	Body Back	0.884	0.878	1.01
1750MHz (1650-1810MHz)	WCDMA Band 4	1712.4	Body Back	0.905	0.864	1.05
2450MHz (2399-2500MHz)	LTE Band 7 1RB	2535	Body Back	1.29	1.12	1.15

Note:

1. Second Repeated Measurement is not required since the ratio of the largest to smallest SAR for the original and first repeated measurement is not > 1.20.
2. The measured SAR results **do not** have to be scaled to the maximum tune-up tolerance to determine if repeated measurements are required.
3. SAR measurement variability must be assessed for each frequency band, which is determined by the **SAR probe calibration point and tissue-equivalent medium** used for the device measurements..

SAR SIMULTANEOUS TRANSMISSION DESCRIPTION

Simultaneous Transmission:

Description of Simultaneous Transmit Capabilities		
Transmitter Combination	Simultaneous?	Hotspot?
WWAN(WCDMA/LTE) + Bluetooth	√	×
WWAN(WCDMA/LTE) + WLAN	√	×

Simultaneous SAR test exclusion considerations:

Mode(SAR1+SAR2)	Position	Reported 1-g SAR(W/kg)		Σ1-g SAR < 1.6W/kg
		SAR1	SAR2	
WCDMA Band 2 + Bluetooth	Body Back	0.90	0.18	1.08
WCDMA Band 4 + Bluetooth	Body Back	0.96	0.18	1.14
WCDMA Band 5 + Bluetooth	Body Back	0.27	0.18	0.45
LTE Band 2 + Bluetooth	Body Back	0.79	0.18	0.97
LTE Band 4 + Bluetooth	Body Back	0.80	0.18	0.98
LTE Band 5 + Bluetooth	Body Back	0.46	0.18	0.64
LTE Band 7 + Bluetooth	Body Back	1.38	0.18	1.56
LTE Band 12 + Bluetooth	Body Back	0.27	0.18	0.45
LTE Band 13 + Bluetooth	Body Back	0.33	0.18	0.51
LTE Band 17 + Bluetooth	Body Back	0.30	0.18	0.48

Mode(SAR1+SAR2)	Position	Reported 1-g SAR(W/kg)		Σ1-g SAR < 1.6W/kg
		SAR1	SAR2	
WCDMA Band 2 + WLAN	Body Back	0.90	0.14	1.04
WCDMA Band 4 + WLAN	Body Back	0.96	0.14	1.10
WCDMA Band 5 + WLAN	Body Back	0.27	0.14	0.41
LTE Band 2 + WLAN	Body Back	0.79	0.14	0.93
LTE Band 4 + WLAN	Body Back	0.80	0.14	0.94
LTE Band 5 + WLAN	Body Back	0.46	0.14	0.60
LTE Band 7 + WLAN	Body Back	1.38	0.14	1.52
LTE Band 12 + WLAN	Body Back	0.27	0.14	0.41
LTE Band 13 + WLAN	Body Back	0.33	0.14	0.47
LTE Band 17 + WLAN	Body Back	0.30	0.14	0.44

Note:

Σ1-g SAR is lower than 1.6W/kg, test for simultaneous mode is not required.

Mode(SAR1+SAR2)	Position	Reported 10-g SAR(W/kg)		Σ10-g SAR < 4.0W/kg
		SAR1	SAR2	
WCDMA Band 2 + Bluetooth	Handheld Left	0.03	0.12	0.15
	Handheld Right	0.05	0.12	0.17
	Handheld Top	0.07	0.12	0.19
WCDMA Band 4 + Bluetooth	Handheld Left	0.06	0.12	0.18
	Handheld Right	0.05	0.12	0.17
	Handheld Top	0.09	0.12	0.21
WCDMA Band 5 + Bluetooth	Handheld Left	0.05	0.12	0.17
	Handheld Right	0.02	0.12	0.14
	Handheld Top	0.08	0.12	0.20
LTE Band 2 + Bluetooth	Handheld Left	0.03	0.12	0.15
	Handheld Right	0.05	0.12	0.17
	Handheld Top	0.10	0.12	0.22
LTE Band 4 + Bluetooth	Handheld Left	0.03	0.12	0.15
	Handheld Right	0.05	0.12	0.17
	Handheld Top	0.17	0.12	0.29
LTE Band 5 + Bluetooth	Handheld Left	0.19	0.12	0.31
	Handheld Right	0.17	0.12	0.29
	Handheld Top	0.11	0.12	0.23
LTE Band 7 + Bluetooth	Handheld Left	0.04	0.12	0.16
	Handheld Right	0.05	0.12	0.17
	Handheld Top	0.08	0.12	0.20
LTE Band 12 + Bluetooth	Handheld Left	0.16	0.12	0.28
	Handheld Right	0.15	0.12	0.27
	Handheld Top	0.17	0.12	0.29
LTE Band 13 + Bluetooth	Handheld Left	0.28	0.12	0.40
	Handheld Right	0.19	0.12	0.31
	Handheld Top	0.02	0.12	0.14
LTE Band 17 + Bluetooth	Handheld Left	0.15	0.12	0.27
	Handheld Right	0.15	0.12	0.27
	Handheld Top	0.02	0.12	0.14

Mode(SAR1+SAR2)	Position	Reported 10-g SAR(W/kg)		Σ10-g SAR < 4.0W/kg
		SAR1	SAR2	
WCDMA Band 2 + WLAN	Handheld Left	0.03	0.17	0.20
	Handheld Right	0.05	0.17	0.22
	Handheld Top	0.07	0.17	0.24
WCDMA Band 4 + WLAN	Handheld Left	0.06	0.17	0.23
	Handheld Right	0.05	0.17	0.22
	Handheld Top	0.09	0.17	0.26
WCDMA Band 5 + WLAN	Handheld Left	0.05	0.17	0.22
	Handheld Right	0.02	0.17	0.19
	Handheld Top	0.08	0.17	0.25
LTE Band 2 + WLAN	Handheld Left	0.03	0.17	0.20
	Handheld Right	0.05	0.17	0.22
	Handheld Top	0.10	0.17	0.27
LTE Band 4 + WLAN	Handheld Left	0.03	0.17	0.20
	Handheld Right	0.05	0.17	0.22
	Handheld Top	0.17	0.17	0.34
LTE Band 5 + WLAN	Handheld Left	0.19	0.17	0.36
	Handheld Right	0.17	0.17	0.34
	Handheld Top	0.11	0.17	0.28
LTE Band 7 + WLAN	Handheld Left	0.04	0.17	0.21
	Handheld Right	0.05	0.17	0.22
	Handheld Top	0.08	0.17	0.25
LTE Band 12 + WLAN	Handheld Left	0.16	0.17	0.33
	Handheld Right	0.15	0.17	0.32
	Handheld Top	0.17	0.17	0.34
LTE Band 13 + WLAN	Handheld Left	0.28	0.17	0.45
	Handheld Right	0.19	0.17	0.36
	Handheld Top	0.02	0.17	0.19
LTE Band 17 + WLAN	Handheld Left	0.15	0.17	0.32
	Handheld Right	0.15	0.17	0.32
	Handheld Top	0.02	0.17	0.19

Note:

Σ10-g SAR is lower than 4.0W/kg, test for simultaneous mode is not required.

SAR Plots

Please Refer to the Attachment.

APPENDIX A MEASUREMENT UNCERTAINTY

The uncertainty budget has been determined for the measurement system and is given in the following Table.
Measurement uncertainty evaluation for IEEE1528-2013 SAR test

Source of uncertainty	Tolerance/ uncertainty ± %	Probability distribution	Divisor	ci (1 g)	ci (10 g)	Standard uncertainty ± %, (1 g)	Standard uncertainty ± %, (10 g)
Measurement system							
Probe calibration	6.55	N	1	1	1	6.6	6.6
Axial Isotropy	4.7	R	$\sqrt{3}$	1	1	2.7	2.7
Hemispherical Isotropy	9.6	R	$\sqrt{3}$	0	0	0.0	0.0
Boundary effect	1.0	R	$\sqrt{3}$	1	1	0.6	0.6
Linearity	4.7	R	$\sqrt{3}$	1	1	2.7	2.7
Detection limits	1.0	R	$\sqrt{3}$	1	1	0.6	0.6
Readout electronics	0.3	N	1	1	1	0.3	0.3
Response time	0.0	R	$\sqrt{3}$	1	1	0.0	0.0
Integration time	0.0	R	$\sqrt{3}$	1	1	0.0	0.0
RF ambient conditions – noise	1.0	R	$\sqrt{3}$	1	1	0.6	0.6
RF ambient conditions–reflections	1.0	R	$\sqrt{3}$	1	1	0.6	0.6
Probe positioner mech. Restrictions	0.8	R	$\sqrt{3}$	1	1	0.5	0.5
Probe positioning with respect to phantom shell	6.7	R	$\sqrt{3}$	1	1	3.9	3.9
Post-processing	2.0	R	$\sqrt{3}$	1	1	1.2	1.2
Test sample related							
Test sample positioning	2.8	N	1	1	1	2.8	2.8
Device holder uncertainty	6.3	N	1	1	1	6.3	6.3
Drift of output power	5.0	R	$\sqrt{3}$	1	1	2.9	2.9
Phantom and set-up							
Phantom uncertainty (shape and thickness tolerances)	4.0	R	$\sqrt{3}$	1	1	2.3	2.3
Liquid conductivity target)	5.0	R	$\sqrt{3}$	0.64	0.43	1.8	1.2
Liquid conductivity meas.)	2.5	N	1	0.64	0.43	1.6	1.1
Liquid permittivity target)	5.0	R	$\sqrt{3}$	0.6	0.49	1.7	1.4
Liquid permittivity meas.)	2.5	N	1	0.6	0.49	1.5	1.2
Combined standard uncertainty		RSS				12.2	12.0
Expanded uncertainty 95 % confidence interval)						24.3	23.9

Measurement uncertainty evaluation for IEC62209-2 SAR test

Source of uncertainty	Tolerance/uncertainty ± %	Probability distribution	Divisor	ci (1 g)	ci (10 g)	Standard uncertainty ± %, (1 g)	Standard uncertainty ± %, (10 g)
Measurement system							
Probe calibration	6.55	N	1	1	1	6.6	6.6
Axial Isotropy	4.7	R	√3	1	1	2.7	2.7
Hemispherical Isotropy	9.6	R	√3	0	0	0.0	0.0
Linearity	4.7	R	√3	1	1	2.7	2.7
Modulation Response	0.0	R	√3	1	1	0.0	0.0
Detection limits	1.0	R	√3	1	1	0.6	0.6
Boundary effect	1.0	R	√3	1	1	0.6	0.6
Readout electronics	0.3	N	1	1	1	0.3	0.3
Response time	0.0	R	√3	1	1	0.0	0.0
Integration time	0.0	R	√3	1	1	0.0	0.0
RF ambient conditions – noise	1.0	R	√3	1	1	0.6	0.6
RF ambient conditions–reflections	1.0	R	√3	1	1	0.6	0.6
Probe positioner mech. Restrictions	0.8	R	√3	1	1	0.5	0.5
Probe positioning with respect to phantom shell	6.7	R	√3	1	1	3.9	3.9
Post-processing	2.0	R	√3	1	1	1.2	1.2
Test sample related							
Device holder Uncertainty	6.3	N	1	1	1	6.3	6.3
Test sample positioning	2.8	N	1	1	1	2.8	2.8
Power scaling	4.5	R	√3	1	1	2.6	2.6
Drift of output power	5.0	R	√3	1	1	2.9	2.9
Phantom and set-up							
Phantom uncertainty (shape and thickness tolerances)	4.0	R	√3	1	1	2.3	2.3
Algorithm for correcting SAR for deviations in permittivity and conductivity	1.9	N	1	1	0.84	1.1	0.9
Liquid conductivity (meas.)	2.5	N	1	0.64	0.43	1.6	1.1
Liquid permittivity (meas.)	2.5	N	1	0.6	0.49	1.5	1.2
Temp. unc. - Conductivity	1.7	R	√3	0.78	0.71	0.8	0.7
Temp. unc. - Permittivity	0.3	R	√3	0.23	0.26	0.0	0.0
Combined standard uncertainty		RSS				12.2	12.1
Expanded uncertainty 95 % confidence interval)						24.5	24.2

APPENDIX B EUT TEST POSITION PHOTOS

Please Refer to the Attachment.

APPENDIX C PROBE CALIBRATION CERTIFICATES

Please Refer to the Attachment.

APPENDIX D DIPOLE CALIBRATION CERTIFICATES

Please Refer to the Attachment.

******* END OF REPORT *******