



Engineering Solutions & Electromagnetic Compatibility Services

**Certification Application Report  
FCC Part 15.247 & ISED RSS-247**

<b>Test Lab:</b> Rhein Tech Laboratories, Inc. Phone: 703-689 0368 360 Herndon Parkway www.rheintech.com Suite 1400 Herndon, VA 20160 E-Mail: atcbinfo@rheintech.com		<b>Applicant:</b> L3Harris Corporation 221 Jefferson Ridge Parkway Lynchburg, VA 24501 USA	
<b>FCC ID / IC</b>	OWDTR-0171-E / 3636B-0171	<b>Test Report Date</b>	April 2, 2024
<b>Platform</b>	N/A	<b>RTL Work Order #</b>	2023034
<b>Model / HVIN</b>	XL-CH2 / XLCU-CH2	<b>RTL Quote Number</b>	QRTL23-034A
<b>American National Standard Institute</b>	ANSI C63.10-2020: American National Standard of Procedures for Compliance Testing of Unlicensed Wireless Devices		
<b>FCC Classification</b>	DSS – Part 15 Spread Spectrum Transmitter		
<b>FCC Rule Part(s)</b>	FCC Rules Part 15.247: Operation within the bands 902-928 MHz, 2400-2483.5 MHz, and 5725-5850 MHz (10-01-21)		
<b>ISED Standards</b>	RSS-247 Issue 3: Digital Transmission Systems (DTSS), Frequency Hopping Systems (FHSs) and Licence-Exempt Local Area Network (LE-LAN) Devices RSS-Gen Issue 5: General Requirements for Compliance of Radio Apparatus		
<b>Frequency Range (MHz)</b>	<b>Output Power (W) Peak Conducted</b>	<b>Frequency Tolerance</b>	<b>Emission Designator</b>
2402-2480	0.007	N/A	1M01FXD

I, the undersigned, hereby declare that the equipment tested and referenced in this report conforms to the identified standard(s) as described in this test report. No modifications were made to the equipment during testing in order to achieve compliance with these standards. Furthermore, there was no deviation from, additions to, or exclusions from, the applicable parts of FCC Part 2, FCC Part 15, ANSI C63.10, ISED RSS-247, and RSS-Gen.

Signature: 

Date: April 2, 2024

Typed/Printed Name: Desmond A. Fraser

Position: President

*These tests are accredited and meet the requirements of ISO/IEC 17025, as verified by ANAB. Refer to certificate and scope of accreditation AT-1445. This report replaces R1.0.*

*This report may not be reproduced, except in full, without the written approval of Rhein Tech Laboratories, Inc. and L3Harris Corporation. The test results relate only to the item(s) tested.*

## Table of Contents

1	General Information .....	5
1.1	Scope .....	5
1.2	Description of EUT .....	5
1.3	Test Facility .....	5
1.4	Related Submittal(s)/Grant(s) .....	5
1.5	Modifications .....	5
2	Test Information .....	6
2.1	Description of Test Modes .....	6
2.2	Exercising the EUT .....	6
2.3	Test Result Summary .....	6
2.4	Tested System Details .....	7
2.5	Configuration of Tested System.....	7
3	Peak Output Power – FCC 15.247(b)(1); RSS-247 5.4(b), RSS-Gen 6.12.....	8
3.1	Power Output Test Procedure.....	8
3.2	Power Output Test Results .....	8
4	Compliance with the Band Edge – FCC 15.247(d); RSS-247 5.5.....	12
4.1	Band Edge Test Procedure.....	12
4.2	Restricted Band Edge Test Results .....	12
4.3	Band Edge Plots .....	13
5	Antenna Conducted Spurious Emissions – FCC 15.247(d); RSS-247 5.5, RSS-Gen 6.13.....	17
5.1	Antenna Conducted Spurious Emissions Test Procedures.....	17
5.2	Antenna Conducted Spurious Emissions Test Results .....	17
6	Bandwidths – FCC 15.247(a)(1); RSS-247 5.1(a); RSS-Gen 6.7 .....	18
6.1	Bandwidth Test Procedure.....	18
6.2	Modulated Bandwidth Test Results .....	18
7	Carrier Frequency Separation – FCC 15.247(a)(1); RSS-247 5.1(b).....	22
7.1	Carrier Frequency Separation Test Procedure .....	22
7.2	Carrier Frequency Separation Test Data .....	22
8	Hopping Characteristics – FCC 15.247(a)(1)(iii); RSS-247 5.1(d).....	24
8.1	Hopping Characteristics Test Procedure .....	24
8.2	Hopping Test Results.....	24
9	Average Time of Occupancy – FCC 15.247(a)(1)(iii); RSS-247 5.1(d).....	26
9.1	Average Time of Occupancy Test Procedure .....	26
9.2	Average Time of Occupancy Test Results.....	26
10	AC Conducted Emissions – FCC 15.207; RSS-Gen 8.8.....	29
11	Radiated Emissions – FCC 15.209; RSS-247 5.5; RSS-Gen 8.9, 8.10 .....	29
11.1	Limits of Radiated Emissions Measurement.....	29
11.2	Radiated Emissions Measurement Test Procedure.....	29
11.3	Radiated Emissions Test Results .....	30
12	Conclusion .....	32

**Figure Index**

---

Figure 2-1:	Configuration of Tested System.....	7
-------------	-------------------------------------	---

**Table Index**

---

Table 2-1:	Test Frequencies.....	6
Table 2-2:	Test Result Summary – FCC Part 15, Subpart C (Section 15.247); RSS-247, RSS-Gen .....	6
Table 2-3:	Equipment Under Test (EUT).....	7
Table 2-4:	Auxiliary Equipment .....	7
Table 3-1:	Power Output Test Equipment.....	8
Table 3-2:	Environmental Conditions .....	8
Table 3-3:	Power Output Test Data.....	8
Table 4-1:	Band Edge Test Equipment.....	12
Table 4-2:	Environmental Conditions .....	12
Table 4-3:	Lower Band Edge Average – GFSK .....	13
Table 4-4:	Lower Band Edge Peak .....	14
Table 4-5:	Upper Band Edge Average .....	15
Table 4-6:	Upper Band Edge Peak .....	16
Table 5-1:	Environmental Conditions .....	17
Table 5-2:	Antenna Conducted Spurious Emissions Test Equipment .....	17
Table 6-1:	Bandwidth Test Equipment .....	18
Table 6-2:	Environmental Conditions .....	18
Table 6-3:	Modulated Bandwidth Test Data.....	18
Table 7-1:	Carrier Frequency Separation Test Equipment .....	22
Table 7-2:	Environmental Conditions .....	22
Table 8-1:	Hopping Characteristics Test Equipment.....	24
Table 8-2:	Environmental Conditions .....	24
Table 9-1:	Average Time of Occupancy Test Equipment .....	26
Table 9-2:	Environmental Conditions .....	26
Table 11-1:	Radiated Emissions Test Equipment.....	30
Table 11-2:	Environmental Conditions .....	30
Table 11-3:	Radiated Emissions Harmonics/Spurious – GFSK - 2402 MHz, Peak Detector .....	30
Table 11-4:	Radiated Emissions Harmonics/Spurious – GFSK - 2402 MHz, Average Detector .....	30
Table 11-5:	Radiated Emissions Harmonics/Spurious – GFSK - 2440 MHz, Peak Detector .....	31
Table 11-6:	Radiated Emissions Harmonics/Spurious – GFSK - 2440 MHz, Average Detector .....	31
Table 11-7:	Radiated Emissions Harmonics/Spurious – GFSK - 2480 MHz, Peak Detector .....	31
Table 11-8:	Radiated Emissions Harmonics/Spurious – GFSK - 2480 MHz, Average Detector .....	31
Table 11-9:	Unintentional Emissions Test Data .....	32

---

### Plot Index

---

Plot 3-1:	Peak Power; 2402 MHz .....	9
Plot 3-2:	Peak Power; 2440 MHz .....	10
Plot 3-3:	Peak Power; 2480 MHz .....	11
Plot 4-1:	Lower Band Edge – Average .....	13
Plot 4-2:	Lower Band Edge – Peak .....	14
Plot 4-3:	Upper Band Edge – Average .....	15
Plot 4-4:	Upper Band Edge – Peak – GFSK.....	16
Plot 6-1:	99% Bandwidth – 2402 MHz – GFSK.....	19
Plot 6-2:	99% Bandwidth – 2440 MHz – GFSK.....	20
Plot 6-3:	99% Bandwidth – 2480 MHz – GFSK.....	21
Plot 7-1:	Carrier Frequency Separation.....	23
Plot 8-1:	Number of Hopping Frequencies .....	24
Plot 9-1:	Time of Occupancy (Dwell Time).....	27
Plot 9-2:	Time of Occupancy (Dwell Time 31.6 Second Sweep).....	28

---

### Appendix Index

---

Appendix A:	Test Photographs .....	33
-------------	------------------------	----

---

### Photograph Index

---

Photograph 1:	Radiated Emissions (Spurious/Harmonics) (<1 GHz) - Front View .....	33
Photograph 2:	Radiated Emissions (Spurious/Harmonics) (<1 GHz) – Back View .....	34
Photograph 3:	Radiated Emissions (Spurious/Harmonics) (>1 GHz) – Front View .....	35
Photograph 4:	Radiated Emissions (Spurious/Harmonics) (>1 GHz) – Back View .....	36
Photograph 5:	Conducted Emissions Testing.....	37

## 1 General Information

### 1.1 Scope

#### Applicable Standards

- FCC Part 15.247: Frequency Hopping, Direct Spread Spectrum and Hybrid Systems that are in operation within the bands of 902-928 MHz, 2400-2483.5 MHz and 5725-5850 MHz
- ISED RSS-247: Digital Transmission Systems (DTSSs), Frequency Hopping Systems (FHSs) and License-Exempt Local Area Network (LE-LAN) Devices
- ISED RSS-Gen Issue 5: General Requirements for Compliance of Radio Apparatus

### 1.2 Description of EUT

<b>Equipment Under Test</b>	Control Head
<b>Model / HVIN</b>	XL-CH2 / XLCU-CH2
<b>Power Supply</b>	13.8 VDC
<b>Modulation Type</b>	FHSS, BT (LE)
<b>Frequency Range</b>	2402–2480 MHz

### 1.3 Test Facility

The open area test site and conducted measurement facility used to collect the radiated data is located at 360 Herndon Parkway, Suite 1400, Herndon, Virginia 20160.

CAB ID: US0079

### 1.4 Related Submittal(s)/Grant(s)

This is an original certification application for L3Harris Corporation Model XL-CH2 Control Head, FCC ID: OWDTR-0171-E, IC: 3636B-0171.

### 1.5 Modifications

No modifications were required for compliance.

## 2 Test Information

### 2.1 Description of Test Modes

In accordance with FCC 15.31(m), and because the EUT utilizes an operating band greater than 10 MHz, the following frequencies were tested:

**Table 2-1: Test Frequencies**

Channel (#)	FHSS Frequency (MHz)
0	2402
39	2440
78	2480

### 2.2 Exercising the EUT

The EUT was tested in all three orthogonal planes in order to determine worst-case emissions. The EUT was provided with commands using a serial connection to continuously transmit during testing. The carrier was also checked to verify that information was being transmitted, and all modes were investigated, and the worst-case mode was used for final testing. There were no deviations from the test standard(s) and/or methods. The test results reported relate only to the item tested.

### 2.3 Test Result Summary

**Table 2-2: Test Result Summary – FCC Part 15, Subpart C (Section 15.247); RSS-247, RSS-Gen**

FCC	ISED	Test	Result
FCC 15.207	RSS-Gen 8.8	AC Conducted Emissions	N/A
FCC 15.209	RSS-247 5.5; RSS-Gen 8.9, 8.10	Radiated Emissions	Pass
FCC 15.247(a)(1)	RSS-247 5.1(a)	20 dB Bandwidth	Pass
FCC 15.247(a)(1)	RSS-247 5.1(b)	Carrier Frequency Separation	Pass
FCC 15.247(a)(1)(iii)	RSS-247 5.1(d)	Hopping Characteristics	Pass
FCC 15.247(a)(1)(iii)	RSS-247 5.1(d)	Average Time of Occupancy	Pass
FCC 15.247(b)(1)	RSS-247 5.4(b); RSS-Gen 6.12	Maximum Peak Power Output	Pass
FCC 15.247(d)	RSS-247 5.5; RSS-Gen 6.13	Antenna Conducted Spurious Emissions	Pass
FCC 15.247(d)	RSS-247 5.5	Band Edge Measurement	Pass
N/A	RSS-Gen 6.7	99% Bandwidth	Pass

## 2.4 Tested System Details

The test sample was received on January 22, 2024. Listed below are the identifiers and descriptions of all equipment, cables, and internal devices used with the EUT for this test, as applicable. The device was programmed for multiple modes of operation and modulation types.

**Table 2-3: Equipment Under Test (EUT)**

Part	Manufacturer	Model / HVIN	PN/SN	FCC ID	RTL Bar Code
Control Head	L3Harris Corporation	XL-CH2 / XLCU-CH2	N/A	OWDTR-0171-E	24398
Control Head	L3Harris Corporation	XL-CH2 / XLCU-CH2	N/A	OWDTR-0171-E	24397

**Table 2-4: Auxiliary Equipment**

Part	Manufacturer	Model	PN/SN	FCC ID	RTL Bar Code
USB Mobile Mic	L3Harris Corporation	USB Mobile Mic	14050-6010-01	N/A	24401

## 2.5 Configuration of Tested System

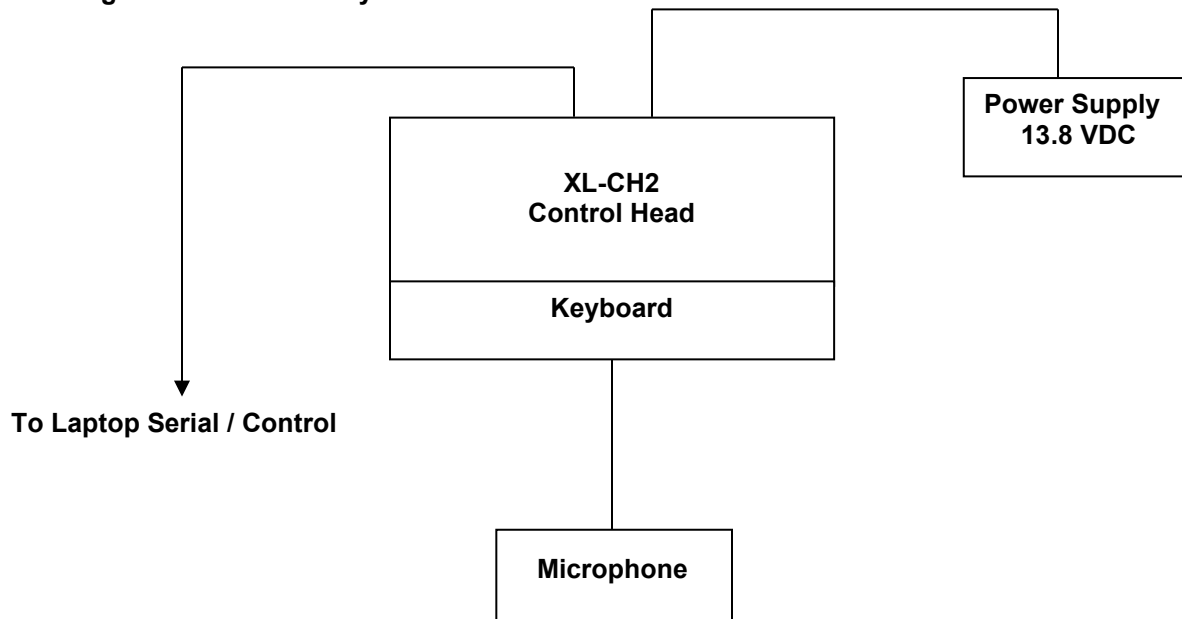

**Figure 2-1: Configuration of Tested System**

### 3 Peak Output Power – FCC 15.247(b)(1); RSS-247 5.4(b), RSS-Gen 6.12

#### 3.1 Power Output Test Procedure

A conducted power measurement of the EUT was taken using an Agilent Analyzer. The following settings were used:

- 1) Span: Approximately five times the 20 dB bandwidth, centered on a hopping channel (5 MHz used)
- 2) RBW >20 dB bandwidth of the emission being measured (2 MHz used)
- 3) VBW ≥RBW (3 MHz used)
- 4) Sweep: Auto
- 5) Detector function: Peak
- 6) Trace: Max hold. The trace was allowed to stabilize, and the marker-to-peak function was used to set the marker to the peak of the emission.

**Table 3-1: Power Output Test Equipment**

RTL Asset #	Manufacturer	Model	Part Type	Serial Number	Calibration Due Date
901672	Rohde & Schwarz	FSEM30	Spectrum Analyzer	FSEM30	04/25/2024

#### 3.2 Power Output Test Results

**Table 3-2: Environmental Conditions**

Date	Temperature (°C)	Humidity (%)	Pressure (kPa)
February 8, 2024	13	38	101.4

**Table 3-3: Power Output Test Data**

Channel Number	Frequency (MHz)	Conducted Peak Power (dBm)	Limit (dBm)	Margin (dB)
0	2402	8.3	30.0	-21.7
39	2440	8.1	30.0	-21.9
78	2480	7.6	30.0	-22.4



Plot 3-1: Peak Power; 2402 MHz

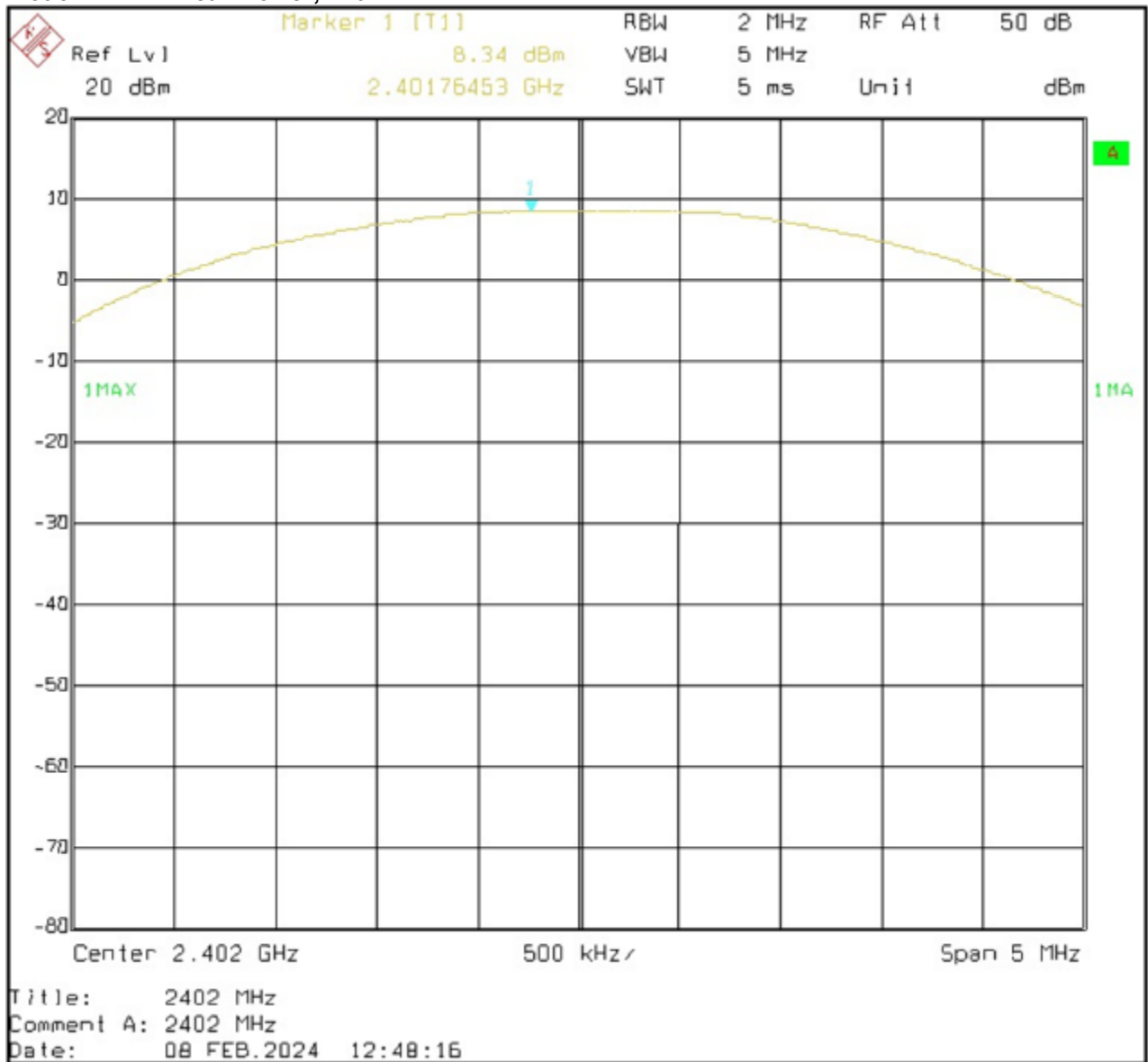

**Plot 3-2: Peak Power; 2440 MHz**

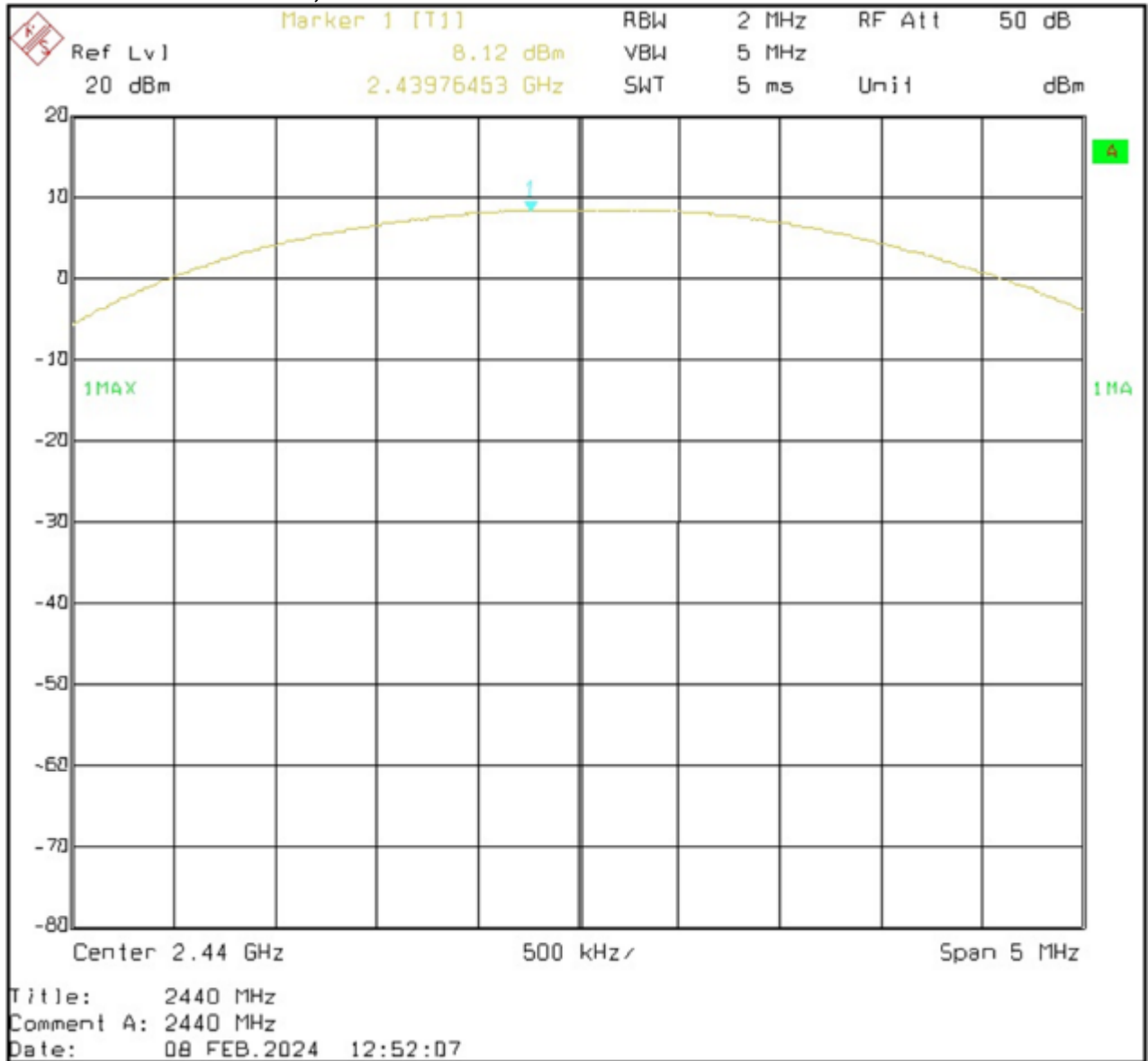

**Plot 3-3: Peak Power; 2480 MHz**

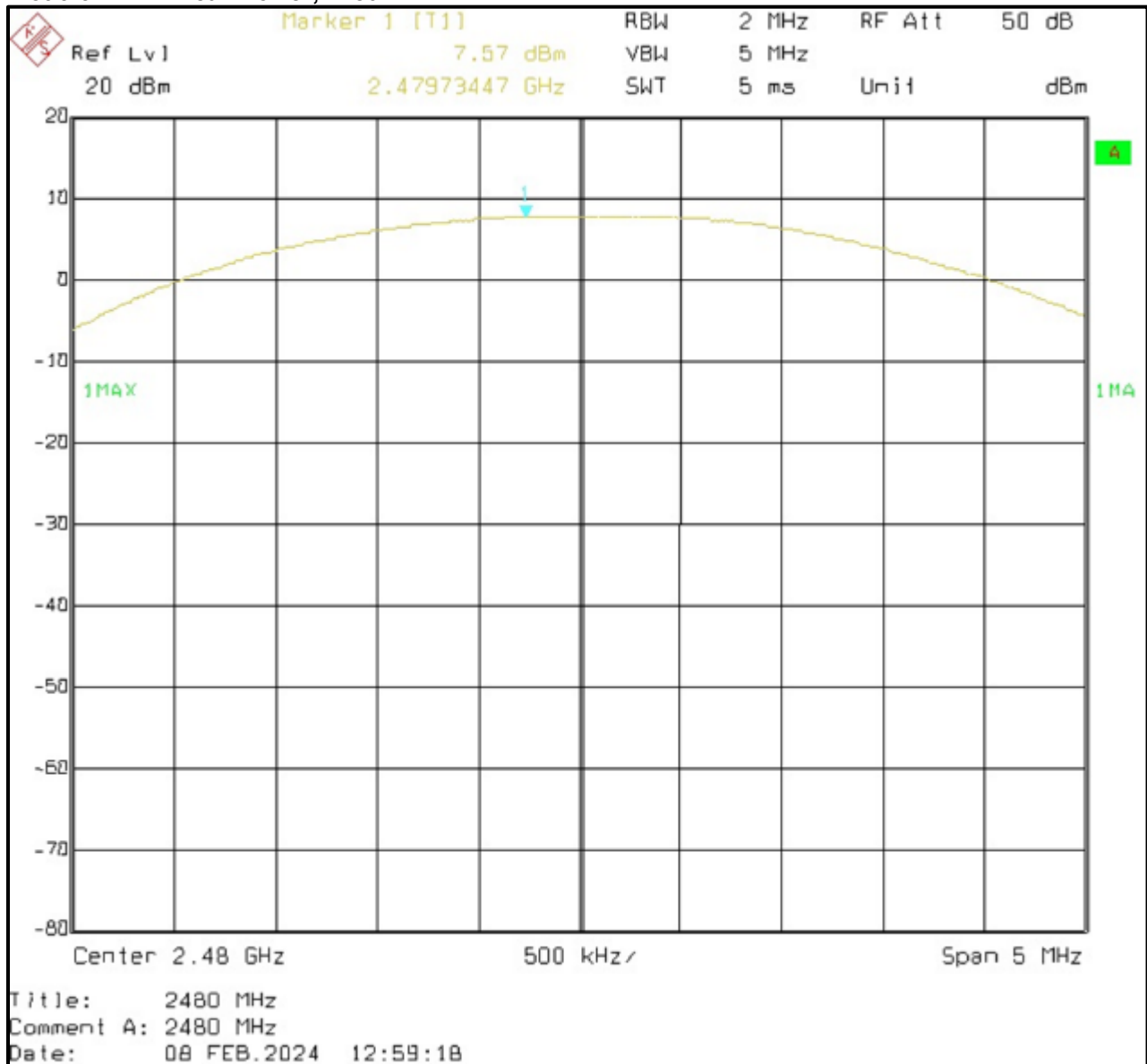

Measurement uncertainty:  $\pm 0.5$  dB. This measurement uncertainty is an expanded uncertainty for 95% confidence level received with a coverage factor  $k=2$ .

**Results: Pass**

**Test Personnel:**

Daniel W. Baltzell  
 Test Engineer

Signature

February 8, 2024  
 Date of Test

#### 4 Compliance with the Band Edge – FCC 15.247(d); RSS-247 5.5

##### 4.1 Band Edge Test Procedure

The transmitter output was connected to the spectrum analyzer. Peak and average detector conducted plots were taken with a suitable span to encompass the peak of the fundamental. The measurement was performed from the highest peak in the restricted band (within 2 MHz), and the result was compared to the restricted band limit (54 dBµV/m).

**Table 4-1: Band Edge Test Equipment**

RTL Asset #	Manufacturer	Model	Part Type	Serial Number	Calibration Due Date
901581	Rohde & Schwarz	FSU	Spectrum Analyzer	1166.1660.50	12/01/2024

##### 4.2 Restricted Band Edge Test Results

**Table 4-2: Environmental Conditions**

Date	Temperature (°C)	Humidity (%)	Pressure (kPa)
February 8, 2024	13	41	101.4

Note: EUT was programmed to TX with GFSK modulation, PN15 test pattern and 7 dBm power level for all three test frequencies.

Conversion of dBm to dBµV/m at 3 m.

$$\text{dB}\mu\text{V/m} = \text{dBm} + 104.7 - (20 * \text{LOG}(3\text{m})) = \text{dBm} + 95.2$$

### 4.3 Band Edge Plots

Plot 4-1: Lower Band Edge – Average

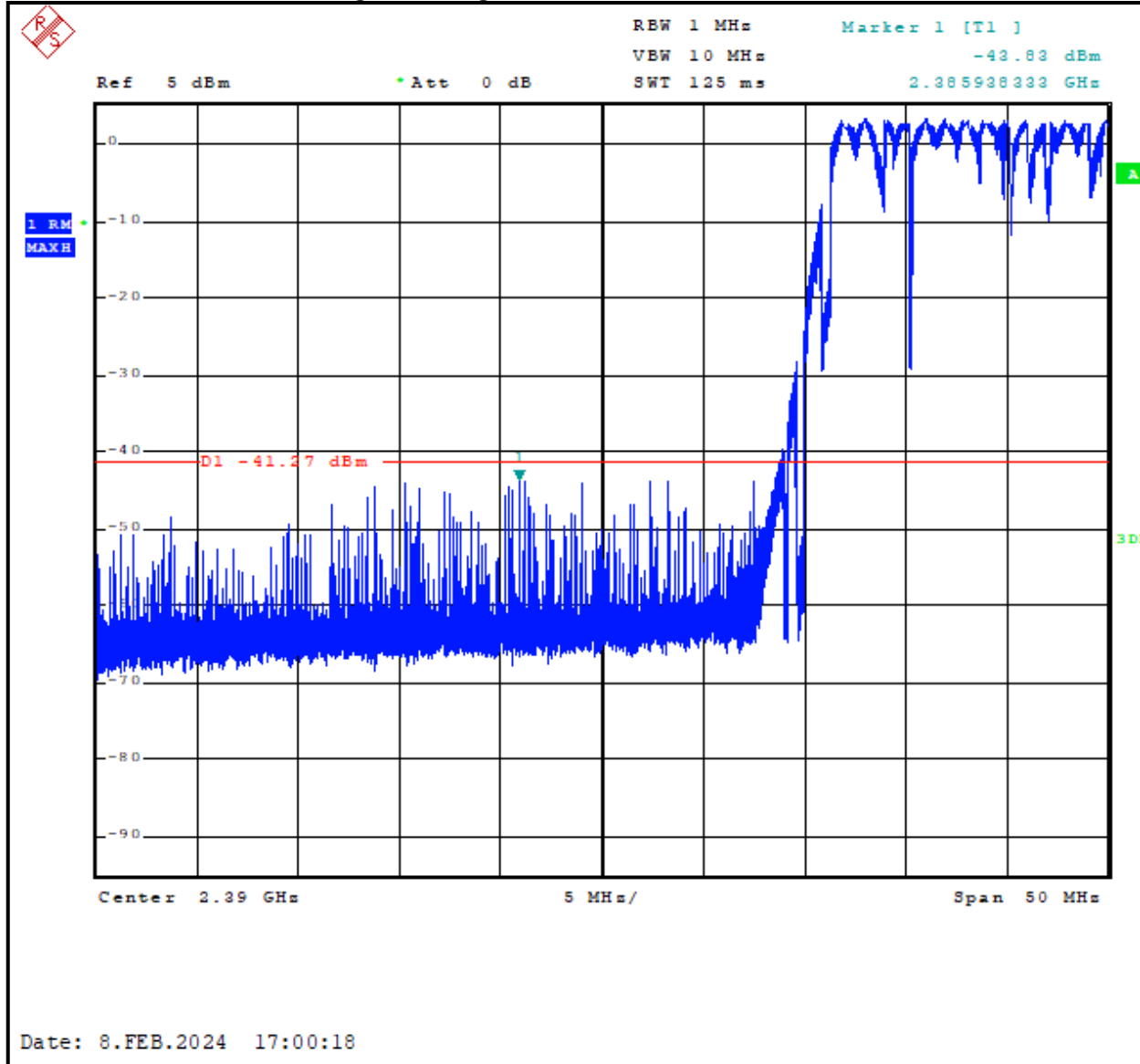
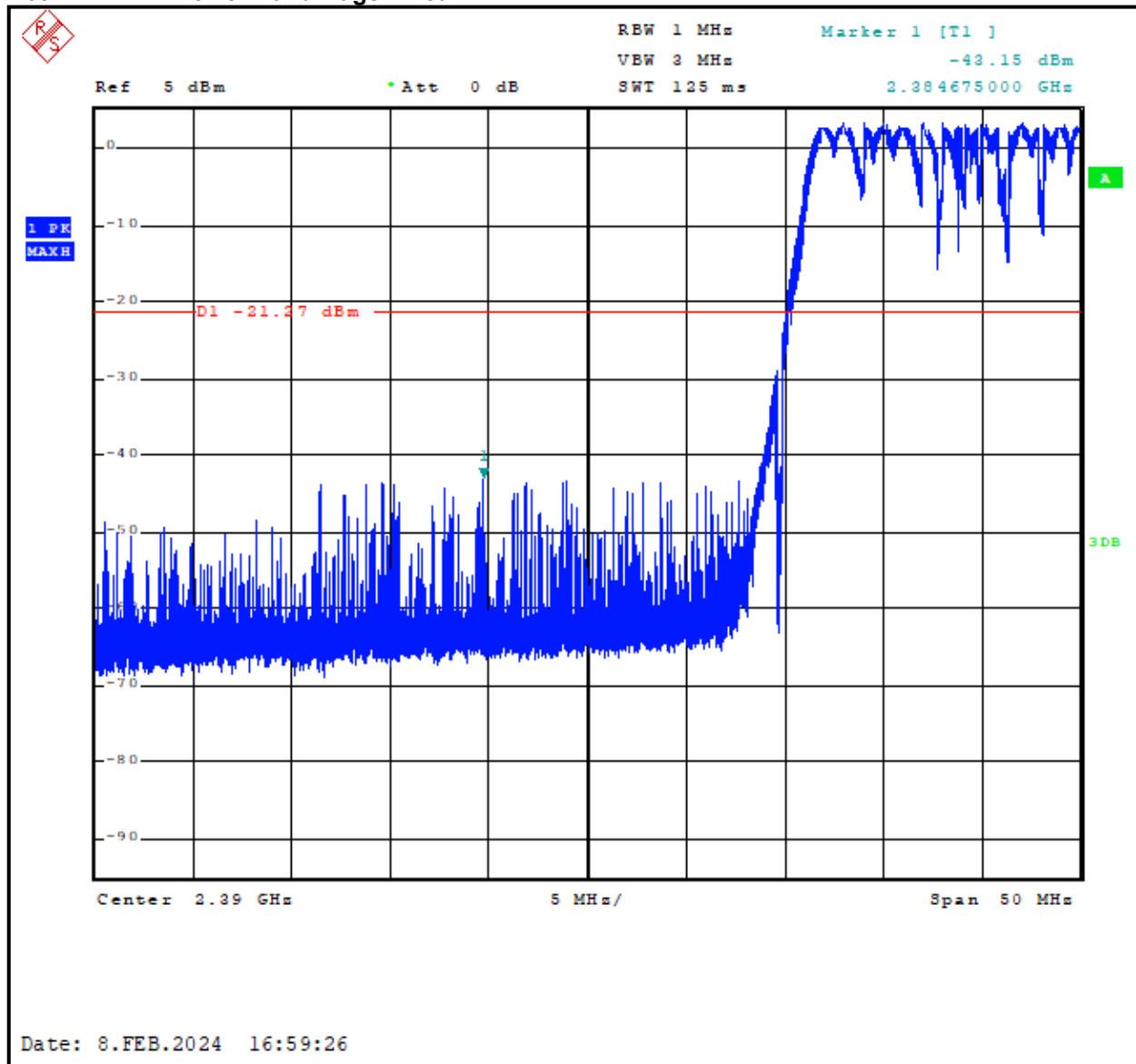

Table 4-3: Lower Band Edge Average – GFSK

Frequency (MHz)	Measured Average Level (dBm)	Field Strength Conversion (dBμV/m)	Average Limit (dBμV/m)	Margin (dB)
2385.928	-43.8	51.5	54.0	-2.5

**Plot 4-2: Lower Band Edge – Peak**



**Table 4-4: Lower Band Edge Peak**

Frequency (MHz)	Measured Peak Level (dBm)	Field Strength Conversion (dBμV/m)	Peak Limit (dBμV/m)	Margin (dB)
2384.675	-43.2	52.1	74.0	-21.9

**Plot 4-3: Upper Band Edge – Average**

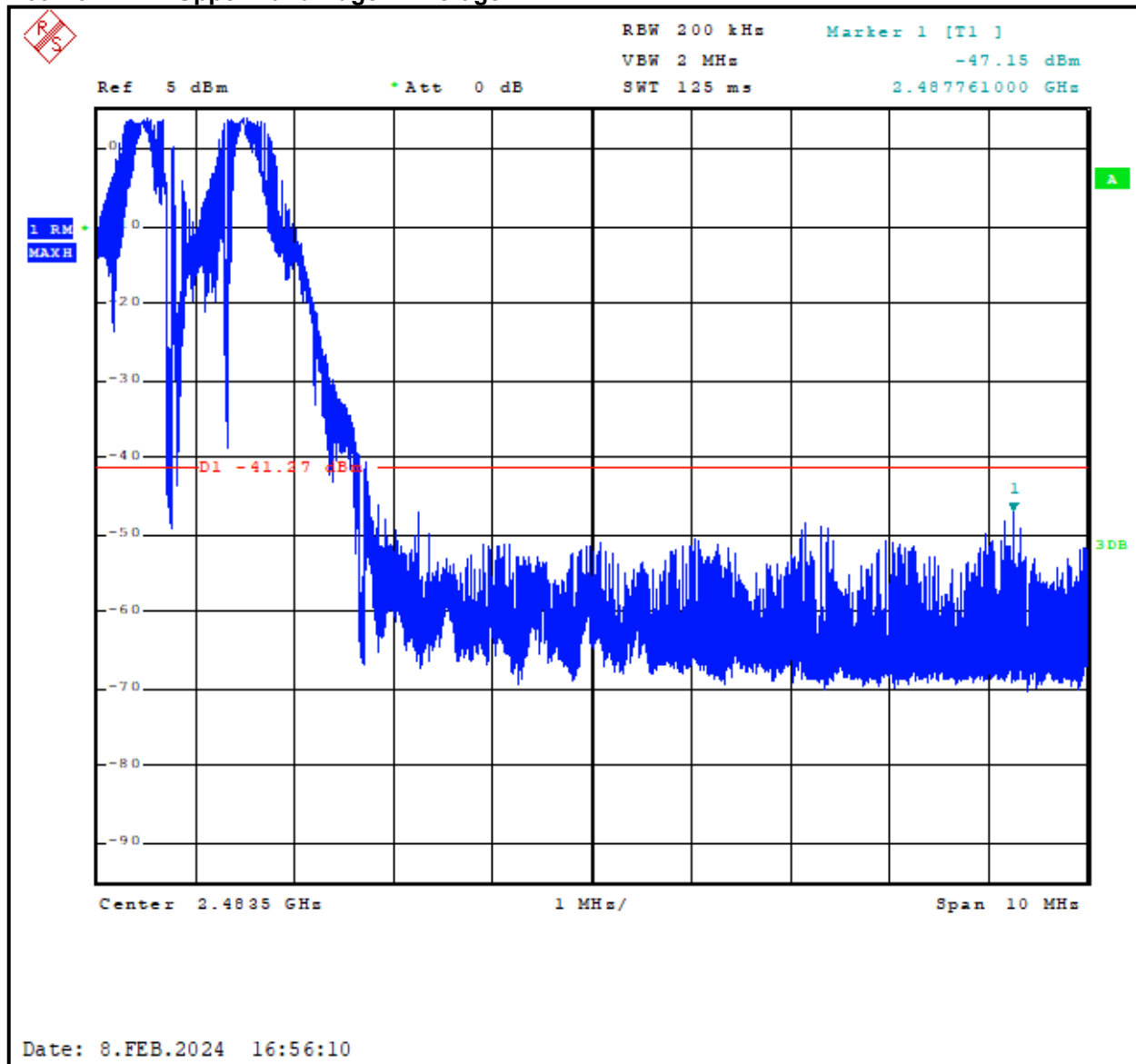

**Table 4-5: Upper Band Edge Average**

Frequency (MHz)	Measured Average Level (dBm)	Field Strength Conversion (dBμV/m)	Average Limit (dBμV/m)	Margin (dB)
2487.761	-47.2	48.1	54.0	-5.9

**Plot 4-4: Upper Band Edge – Peak – GFSK**

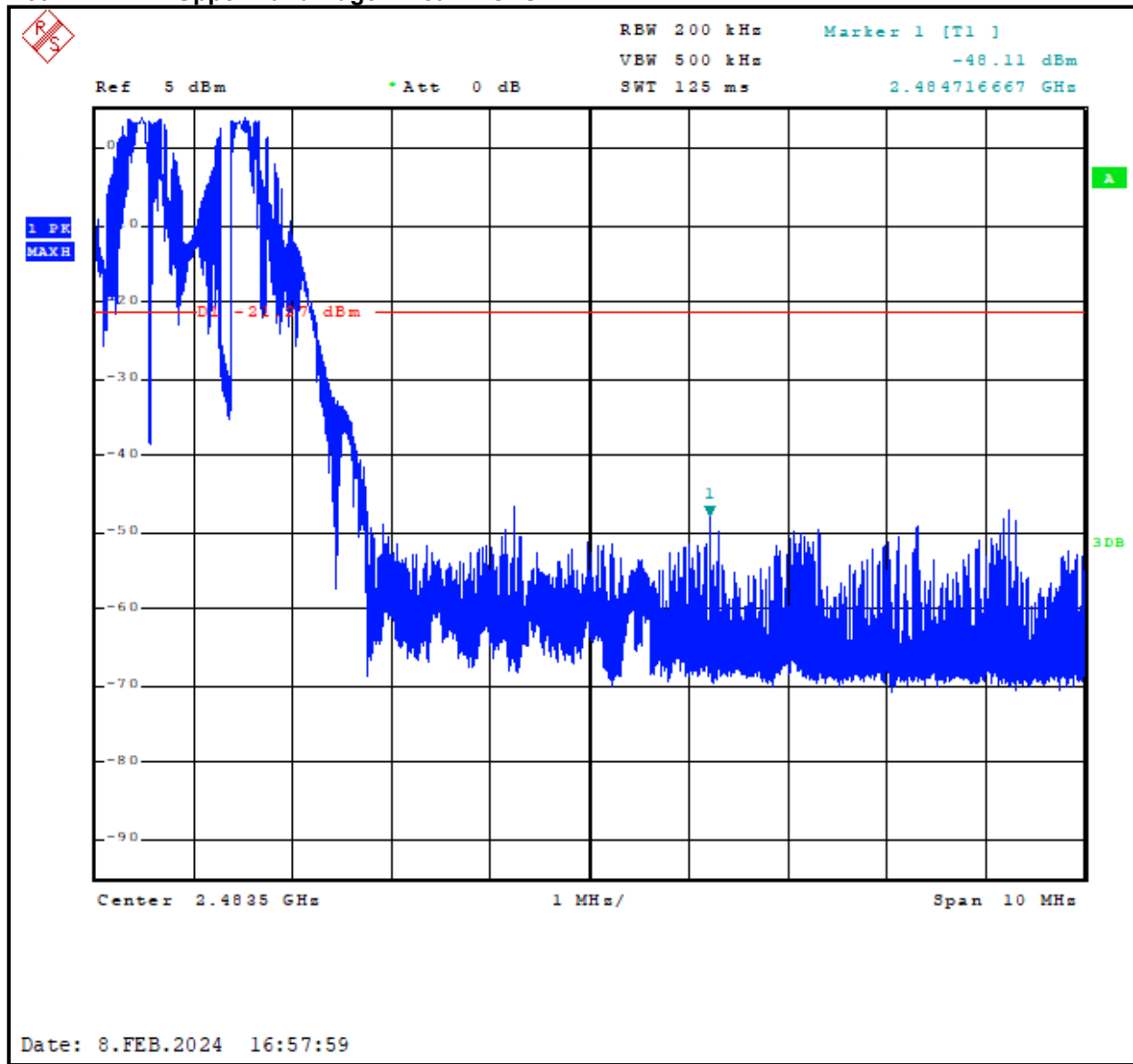

**Table 4-6: Upper Band Edge Peak**

Frequency (MHz)	Measured Peak Level (dBm)	Field Strength Conversion (dBμV/m)	Peak Limit (dBμV/m)	Margin (dB)
2484.717	-48.1	47.2	74.0	-26.8

Measurement uncertainty: ±0.5 dB. This measurement uncertainty is an expanded uncertainty for 95% confidence level received with a coverage factor k=2.

**Results: Pass**



**Test Personnel:**

		
Daniel W. Baltzell Test Engineer	Signature	February 8, 2024 Date of Test

**5 Antenna Conducted Spurious Emissions – FCC 15.247(d); RSS-247 5.5, RSS-Gen 6.13**

**5.1 Antenna Conducted Spurious Emissions Test Procedures**

Antenna spurious emissions per FCC 15.247(d) were measured from the EUT antenna port using a 50-ohm spectrum analyzer with the resolution bandwidth set at 100 kHz, and the video bandwidth set at 100 kHz. The modulated carrier was identified at the following frequencies: 2402 MHz, 2440 MHz and 2480 MHz.

**5.2 Antenna Conducted Spurious Emissions Test Results**

**Table 5-1: Environmental Conditions**

Date	Temperature (°C)	Humidity (%)	Pressure (kPa)
February 8, 2024	13	38	101.4

No harmonics or spurs were found within 20 dB (note that we are reporting power as peak) of the carrier level from the carrier to the 10<sup>th</sup> harmonic of the carrier frequency.

**Table 5-2: Antenna Conducted Spurious Emissions Test Equipment**

RTL Asset #	Manufacturer	Model	Part Type	Serial Number	Calibration Due Date
901581	Rohde & Schwarz	FSU	Spectrum Analyzer	1166.1660.50	12/1/2024

Measurement uncertainty: ±0.5 dB. This measurement uncertainty is an expanded uncertainty for 95% confidence level received with a coverage factor k=2.

**Results: Pass**

**Test Personnel:**

		
Daniel W. Baltzell Test Engineer	Signature	February 8, 2024 Date of Test

## 6 Bandwidths – FCC 15.247(a)(1); RSS-247 5.1(a); RSS-Gen 6.7

### 6.1 Bandwidth Test Procedure

ANSI C63.10 6.9.3

The 20 dB and 99% bandwidths per FCC 15.247(a)(1), RSS-247 5.1 and RSS-Gen 6.7 were measured using a 50-ohm spectrum analyzer.

The following conditions shall be observed for measuring the occupied bandwidth and x dB bandwidth:

- The transmitter shall be operated at its maximum carrier power measured under normal test conditions.
- The span of the spectrum analyzer shall be set large enough to capture all products of the modulation process, including the emission skirts, around the carrier frequency, but small enough to avoid having other emissions (e.g. on adjacent channels) within the span.
- The detector of the spectrum analyzer shall be set to “Sample”. However, a peak, or peak hold, may be used in place of the sampling detector since this usually produces a wider bandwidth than the actual bandwidth (worst-case measurement). Use of a peak hold (or “Max Hold”) may be necessary to determine the occupied/x dB bandwidth if the device is not transmitting continuously.
- The resolution bandwidth (RBW) shall be in the range of 1% to 5% of the actual occupied/x dB bandwidth and the video bandwidth (VBW) shall not be smaller than three times the RBW value. Video averaging is not permitted.

**Table 6-1: Bandwidth Test Equipment**

RTL Asset #	Manufacturer	Model	Part Type	Serial Number	Calibration Due Date
901581	Rohde & Schwarz	FSU	Spectrum Analyzer	1166.1660.50	12/1/2024

### 6.2 Modulated Bandwidth Test Results

**Table 6-2: Environmental Conditions**

Date	Temperature (°C)	Humidity (%)	Pressure (kPa)
February 8, 2024	13	41	101.4

**Table 6-3: Modulated Bandwidth Test Data**

Frequency (MHz)	20 dB Bandwidth (MHz)	99% Bandwidth (MHz)
2402	1.07	1.01
2440	1.07	1.01
2480	1.07	1.01

**Plot 6-1: 99% Bandwidth – 2402 MHz – GFSK**

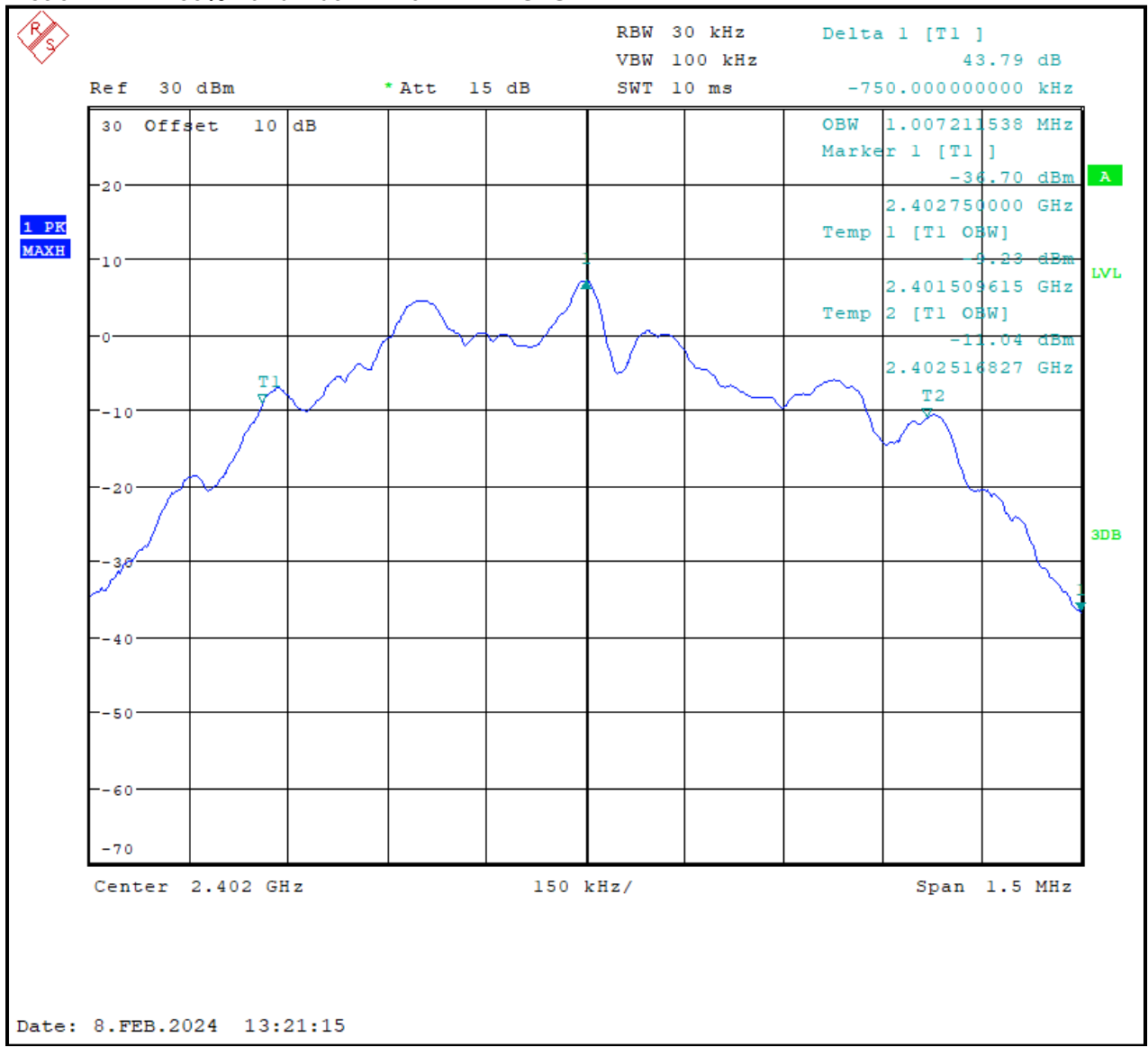

**Plot 6-2: 99% Bandwidth – 2440 MHz – GFSK**

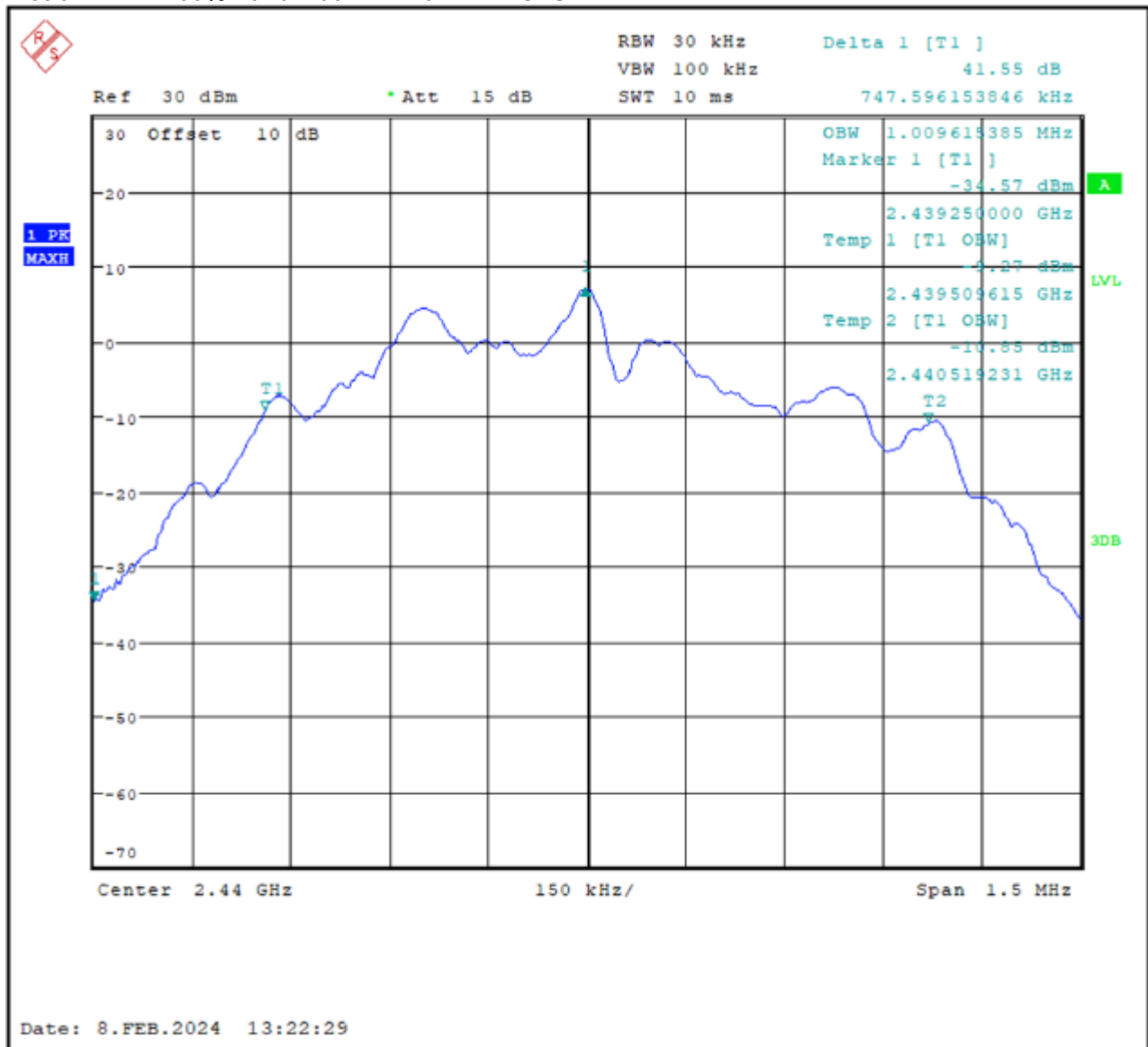

**Plot 6-3: 99% Bandwidth – 2480 MHz – GFSK**

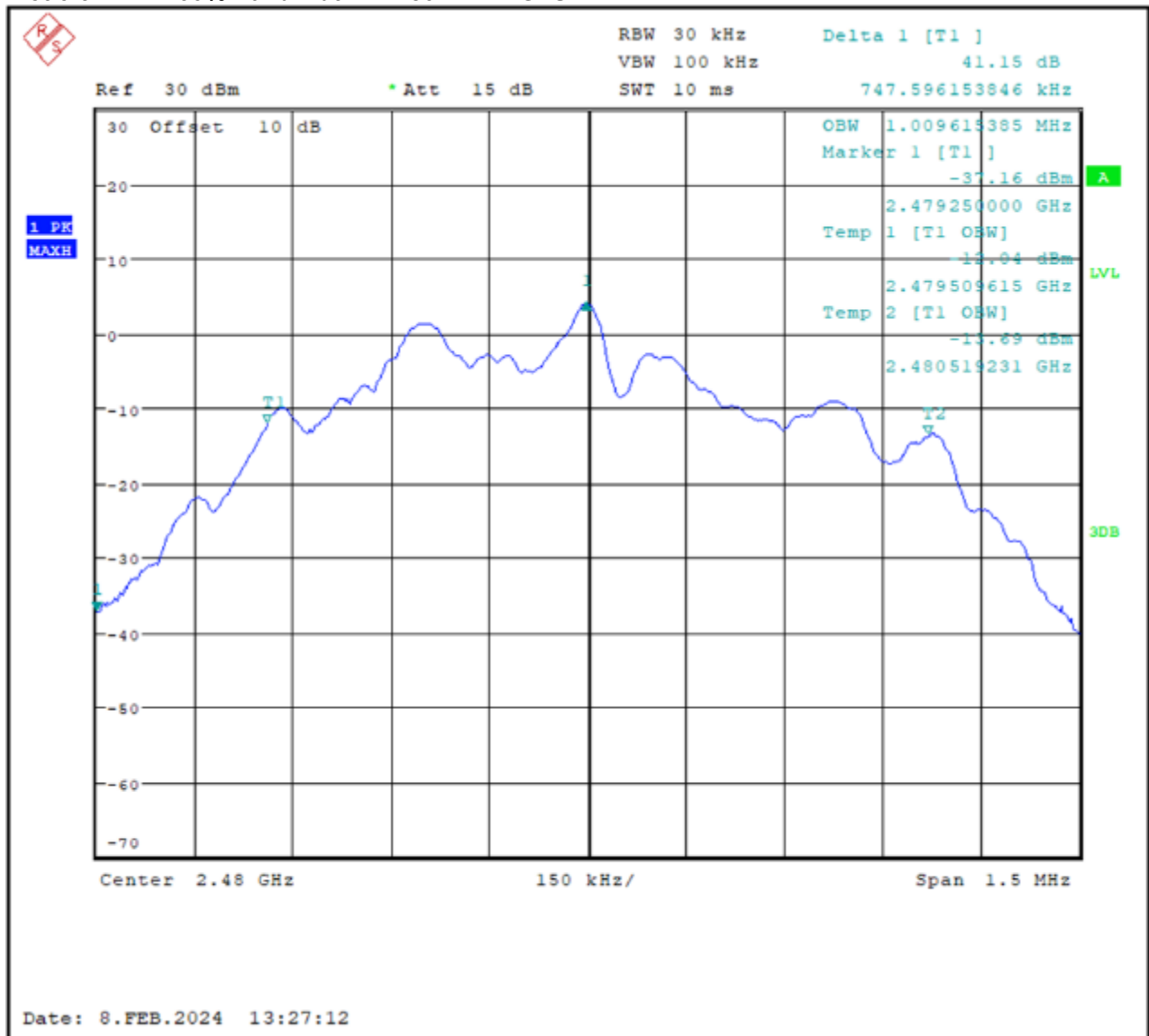

Measurement uncertainty:  $\pm 1 \times 10^{-6}$  Hz. This measurement uncertainty is an expanded uncertainty for 95% confidence level received with a coverage factor k=2.

**Test Personnel:**

Daniel W. Baltzell Test Engineer	 Signature	February 8, 2024 Date of Test
-------------------------------------	---	----------------------------------

**7 Carrier Frequency Separation – FCC 15.247(a)(1); RSS-247 5.1(b)**

**7.1 Carrier Frequency Separation Test Procedure**

Frequency hopping systems shall have hopping channel carrier frequencies separated by a minimum of 25 kHz or the 20 dB bandwidth of the hopping channel, whichever is greater.

Measured frequency separation = 1.00 MHz

**Table 7-1: Carrier Frequency Separation Test Equipment**

RTL Asset #	Manufacturer	Model	Part Type	Serial Number	Calibration Due Date
901581	Rohde & Schwarz	FSU	Spectrum Analyzer	1166.1660.50	12/1/2024

**7.2 Carrier Frequency Separation Test Data**

**Table 7-2: Environmental Conditions**

Date	Temperature (°C)	Humidity (%)	Pressure (kPa)
February 8, 2024	13	41	101.4

**Plot 7-1: Carrier Frequency Separation**

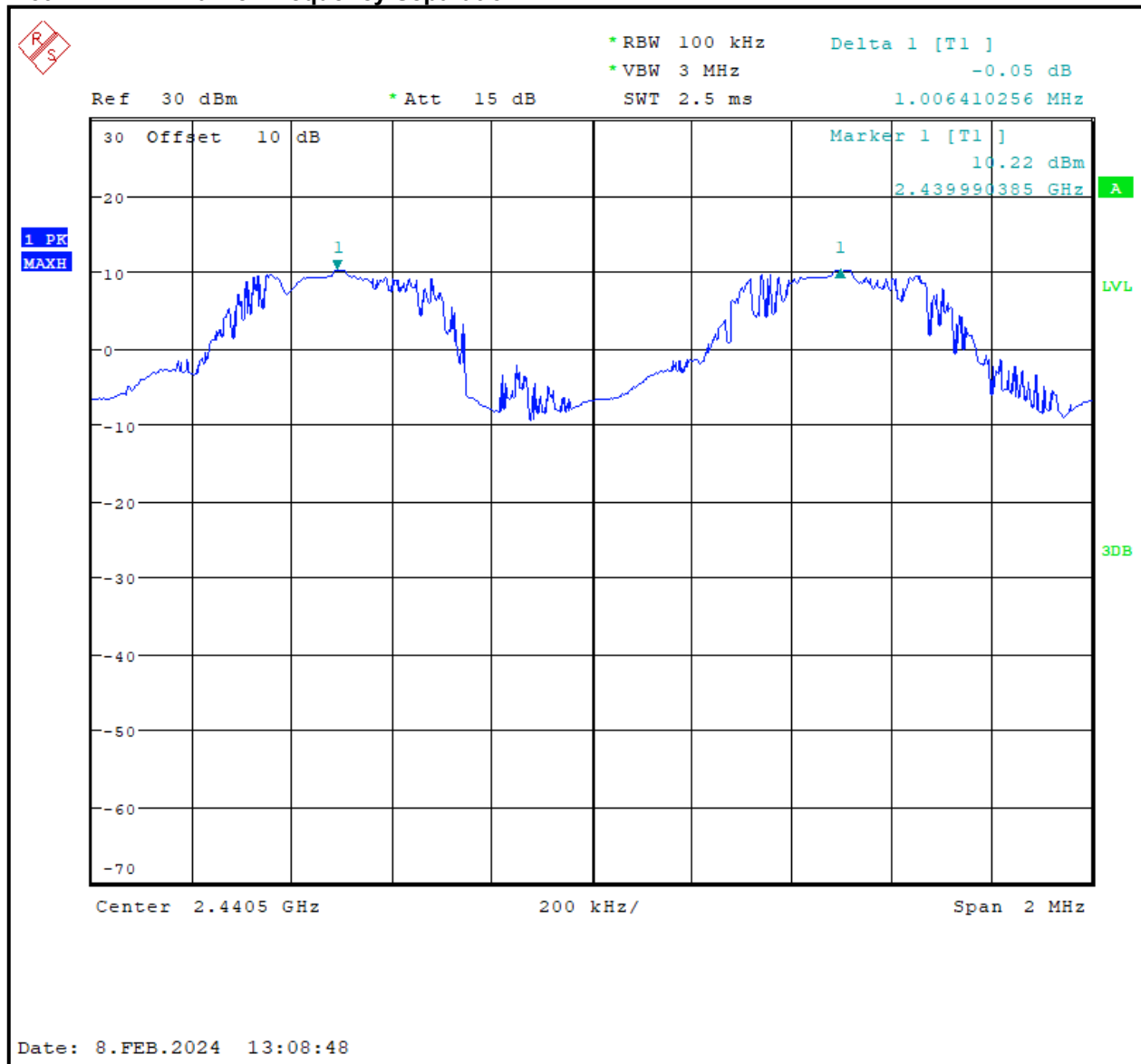

Measurement uncertainty:  $\pm 1 \times 10^{-6}$  Hz. This measurement uncertainty is an expanded uncertainty for 95% confidence level received with a coverage factor k=2.

**Test Personnel:**

Daniel W. Baltzell  
 Test Engineer

Signature

February 8, 2024  
 Date of Test

## 8 Hopping Characteristics – FCC 15.247(a)(1)(iii); RSS-247 5.1(d)

### 8.1 Hopping Characteristics Test Procedure

Frequency hopping systems in the 2400–2483.5 MHz band shall use at least 15 channels. The average time of occupancy on any channel shall not be greater than 0.4 seconds within a period of 0.4 seconds multiplied by the number of hopping channels employed. Frequency hopping systems may avoid or suppress transmissions on a particular hopping frequency provided that a minimum of 15 channels is used.

**Table 8-1: Hopping Characteristics Test Equipment**

RTL Asset #	Manufacturer	Model	Part Type	Serial Number	Calibration Due Date
901581	Rohde & Schwarz	FSU	Spectrum Analyzer	1166.1660.50	12/1/2024

### 8.2 Hopping Test Results

**Table 8-2: Environmental Conditions**

Date	Temperature (°C)	Humidity (%)	Pressure (kPa)
February 7, 2024	14	41	101.5

**Plot 8-1: Number of Hopping Frequencies**

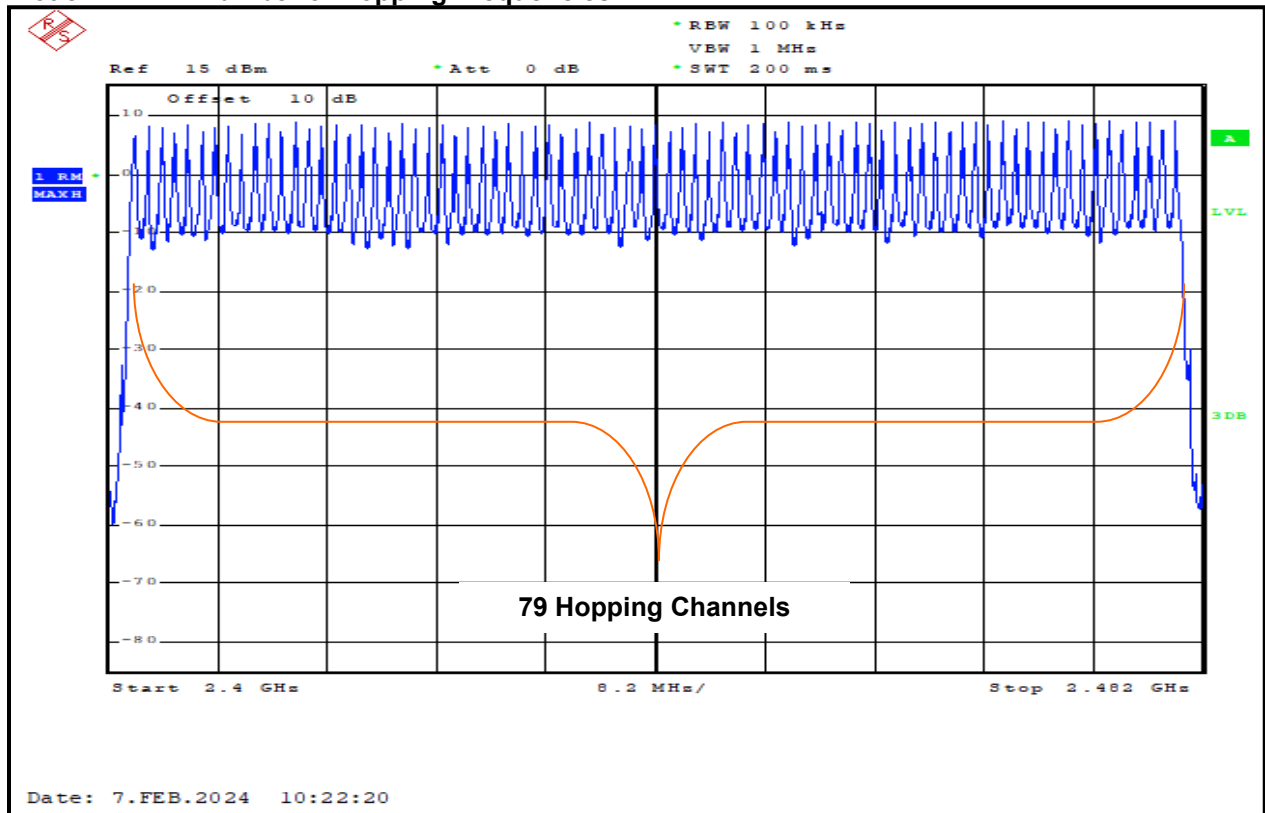

Measurement uncertainty:  $\pm 1 \times 10^{-6}$  Hz. This measurement uncertainty is an expanded uncertainty for 95% confidence level received with a coverage factor  $k=2$ .

**Test Personnel:**



Rhein Tech Laboratories, Inc.  
360 Herndon Parkway  
Suite 1400  
Herndon, VA 20170  
<http://www.rheintech.com>

Client: L3Harris Corporation  
Model / HVIN: XL-CH2 / XLCU-CH2  
Standards: FCC 15.247 & ISED RSS-247  
ID's: OWDTR-0171-E/3636B-0171  
Report #: 2023034DSS



---

Daniel W. Baltzell  
Test Engineer

Signature

February 7, 2024  
Date of Test

**9 Average Time of Occupancy – FCC 15.247(a)(1)(iii); RSS-247 5.1(d)**

**9.1 Average Time of Occupancy Test Procedure**

The spectrum analyzer gate function was used to determine the pulse width using the gate start and stop times, with a zero span to capture a pulse from the device under test. The delta response was used to measure the dwell time for this pulse. The sweep was then set to single sweep for 31.6 s.

The number of pulses in 31.6 s was 213.

The average time of occupancy in the above period (31.6 s) is equal to 213 pulses x 1.652 ms = 352 ms, which meets the limit as defined by 15.247(a)(iii) of 0.4 seconds.

**Table 9-1: Average Time of Occupancy Test Equipment**

RTL Asset #	Manufacturer	Model	Part Type	Serial Number	Calibration Due Date
901581	Rohde & Schwarz	FSU	Spectrum Analyzer	1166.1660.50	12/1/2024

**9.2 Average Time of Occupancy Test Results**

**Table 9-2: Environmental Conditions**

Date	Temperature (°C)	Humidity (%)	Pressure (kPa)
February 8, 2024	13	41	101.4

Plot 9-1: Time of Occupancy (Dwell Time)

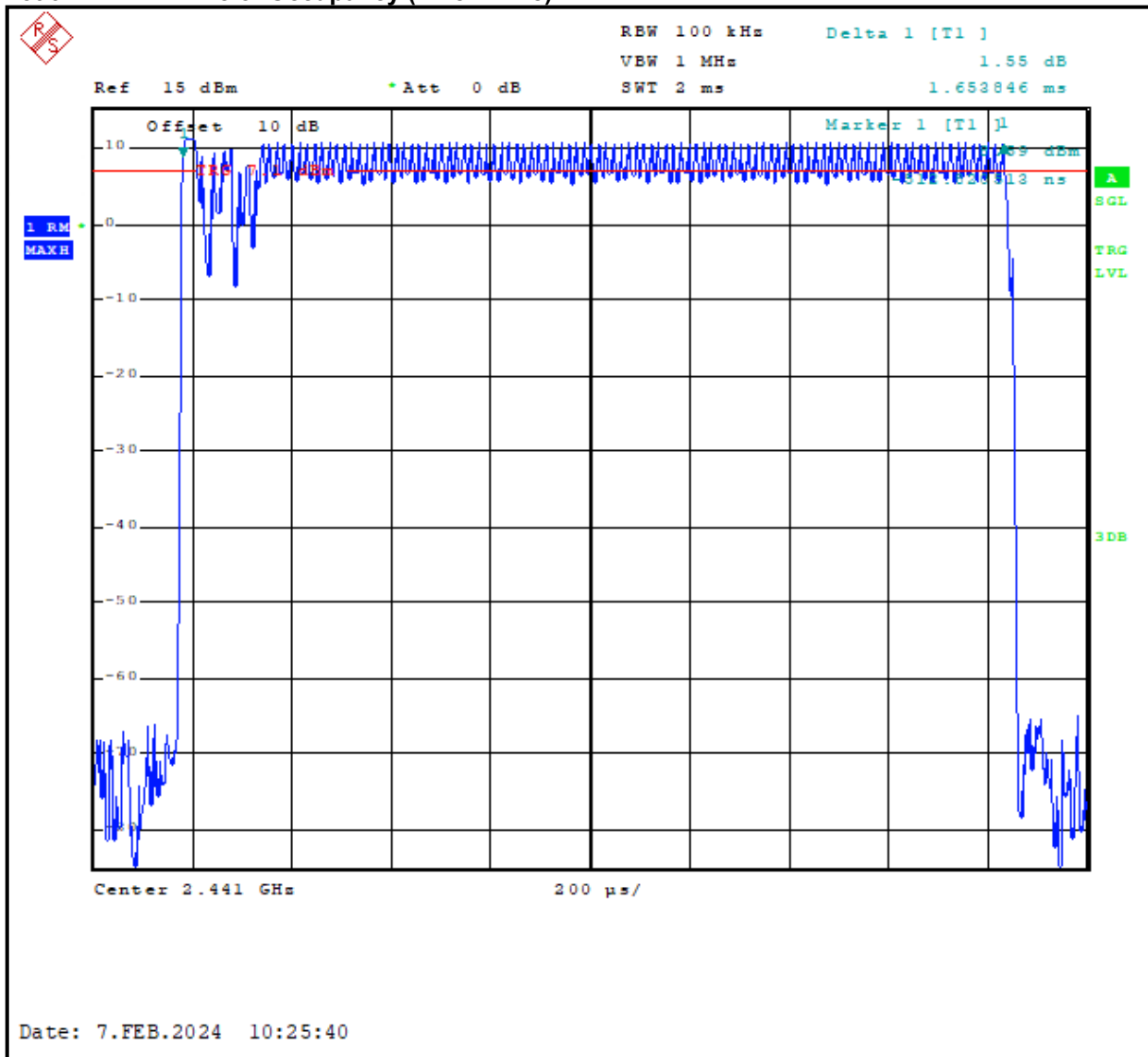

**Plot 9-2: Time of Occupancy (Dwell Time 31.6 Second Sweep)**

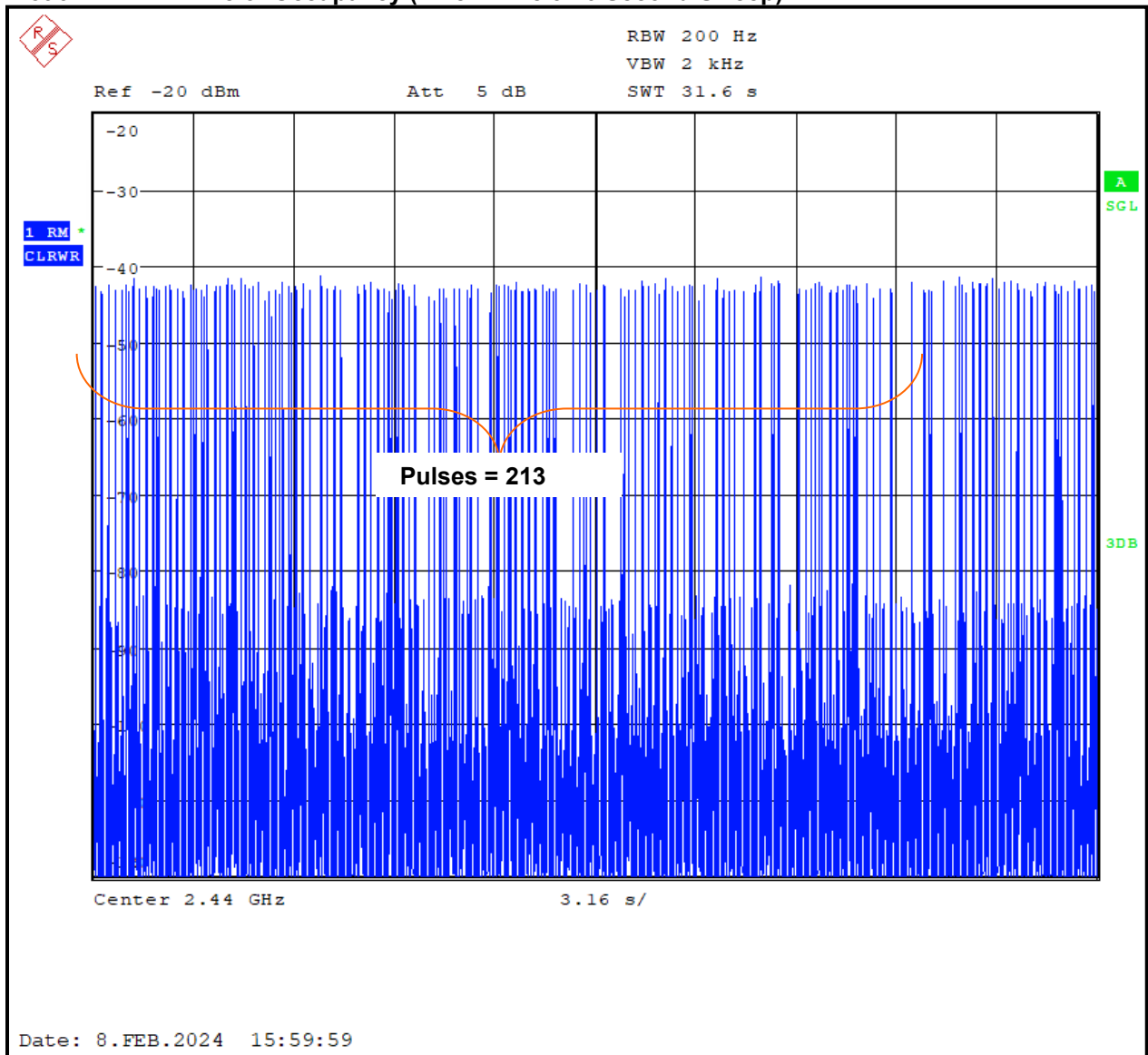

Number of pulses in 31.6 seconds: 213

The pulse width of 1.654 ms x 213 = 352 ms; less than the limit of 400 ms.

**Results: Pass**

Measurement uncertainty:  $\pm 1 \times 10^{-6}$  Hz. This measurement uncertainty is an expanded uncertainty for 95% confidence level received with a coverage factor k=2.

**Test Personnel:**

Daniel W. Baltzell  
Test Engineer

Signature

February 7-8, 2024  
Dates of Test

## 10 AC Conducted Emissions – FCC 15.207; RSS-Gen 8.8

The device is a mobile 13.8 VDC equipment; AC line conducted emissions measurements are not required.

## 11 Radiated Emissions – FCC 15.209; RSS-247 5.5; RSS-Gen 8.9, 8.10

### 11.1 Limits of Radiated Emissions Measurement

Frequency (MHz)	Field Strength ( $\mu\text{V/m}$ )	Measurement Distance (m)
0.009-0.490	2400/f (kHz)	300
0.490-1.705	2400/f (kHz)	30
1.705-30.0	30	30
30-88	100	3
88-216	150	3
216-960	200	3
Above 960	500	3

As shown in 15.35(b), for frequencies above 1000 MHz, the field strength limits are based on average detector, however, the peak field strength of any emission shall not exceed the maximum permitted average limits, specified above by more than 20 dB under any circumstances of modulation.

### 11.2 Radiated Emissions Measurement Test Procedure

Before final measurements of radiated emissions were made on the open-field three/ten meter range, the EUT was scanned indoors at one and three meter distances. This was done in order to determine its emissions spectrum signature. The physical arrangement of the test system and associated cabling was varied in order to determine the effect on the EUT's emissions in amplitude, direction and frequency. This process was repeated during final radiated emissions measurements on the open-field range, at each frequency, in order to ensure that maximum emission amplitudes were attained.

Final radiated emissions measurements were made on the three/ten-meter, open-field test site. The EUT was placed on a nonconductive turntable 0.8 meters above the ground plane. The spectrum was examined from 9 kHz to the 10<sup>th</sup> harmonic of the highest fundamental transmitter frequency (24.8 GHz).

At each frequency, the EUT was rotated 360°, and the antenna was raised and lowered from 1 to 4 meters in order to determine the emission's maximum level. Measurements were taken using both horizontal and vertical antenna polarizations. For frequencies between 30 and 1000 MHz, the spectrum analyzer's 6 dB bandwidth was set to 120 kHz, and the analyzer was operated in the CISPR quasi-peak detection mode. For emissions above 1000 MHz, emissions are measured using the average detector function with a minimum resolution bandwidth of 1 MHz. No video filter less than 10 times the resolution bandwidth was used. The highest emission amplitudes relative to the appropriate limit were measured and recorded in this report.

**Table 11-1: Radiated Emissions Test Equipment**

RTL Asset #	Manufacturer	Model	Part Type	Serial Number	Calibration Due Date
900772	EMCO	3161-02	Horn Antenna (2.0–4.0 GHz)	9804-1044	08/05/2024
900321	EMCO	3161-03	Horn Antennas (4.0–8.2 GHz)	9508-1020	08/05/2024
900323	EMCO	3160-7	Horn Antennas (8.2–12.4 GHz)	9605-1054	08/05/2024
900356	EMCO	3160-08	Horn Antenna (12.4–18.0 GHz)	9607-1044	08/05/2024
901218	EMCO	3160-09	Horn Antenna (18.0–26.5 GHz)	960281-003	08/05/2024
901669	ETS-Lindgren	3142E	Biconilog Antenna (30 MHz–6000 MHz)	00166065	07/11/2025
900932	Hewlett Packard	8449B OPT H02	Preamplifier (1-26.5 GHz)	3008A00505	1/30/2025
901729	Insulated Wire Inc.	KPS-1503-3150-KPR	SMK RF Cables 20'	NA	12/29/2024
901477	Micro-Coax	UFA210A-0-0360-300300	RF cable 0.04 - 18 GHz	212349-002	09/01/2024
900905	Rhein Tech Labs	PR-1040	OATS 1 Preamplifier 40dB (30 MHz – 2 GHz)	1006	01/30/2025
901672	Rohde & Schwarz	FSEM30	Spectrum Analyzer	FSEM30	04/25/2024

**11.3 Radiated Emissions Test Results**

**Table 11-2: Environmental Conditions**

Date	Temperature (°C)	Humidity (%)	Pressure (kPa)
February 14, 2024	10	38	101.1

**Table 11-3: Radiated Emissions Harmonics/Spurious – GFSK - 2402 MHz, Peak Detector**

Frequency (MHz)	Peak Analyzer (dBµV/m)	Site Correction Factor (dB/m)	Peak Corrected (dBµV/m)	Peak Limit (dBµV/m)	Peak Margin (dB)
4804.0	61.3	-9.1	52.2	74.0	-21.8
12010.0	47.7	9.9	57.6	74.0	-16.4
19216.0	37.6	19.8	57.4	74.0	-16.6

**Table 11-4: Radiated Emissions Harmonics/Spurious – GFSK - 2402 MHz, Average Detector**

Frequency (MHz)	Average Analyzer (dBµV/m)	Site Correction Factor (dB/m)	Average Corrected (dBµV/m)	Average Limit (dBµV/m)	Average Margin (dB)
4804.0	60.7	-9.1	51.6	54.0	-2.4
12010.0	34.8	9.9	44.7	54.0	-9.3
19216.0	25.2	19.8	45.0	54.0	-9.0

**Table 11-5: Radiated Emissions Harmonics/Spurious – GFSK - 2440 MHz, Peak Detector**

Frequency (MHz)	Peak Analyzer (dBµV/m)	Site Correction Factor (dB/m)	Peak Corrected (dBµV/m)	Peak Limit (dBµV/m)	Peak Margin (dB)
4880.0	54.6	0.5	55.1	74.0	-18.9
7320.0	45.7	2.5	48.2	74.0	-25.8
12200.0	46.6	10.0	56.6	74.0	-17.4
19520.0	38.7	20.1	58.8	74.0	-15.2

**Table 11-6: Radiated Emissions Harmonics/Spurious – GFSK - 2440 MHz, Average Detector**

Frequency (MHz)	Average Analyzer (dBµV/m)	Site Correction Factor (dB/m)	Average Corrected (dBµV/m)	Average Limit (dBµV/m)	Average Margin (dB)
4880.0	52.6	0.5	53.1	54.0	-0.9
7320.0	33.2	2.5	35.7	54.0	-18.3
12200.0	33.9	10.0	43.9	54.0	-10.1
19520.0	25.6	20.1	45.7	54.0	-8.3

**Table 11-7: Radiated Emissions Harmonics/Spurious – GFSK - 2480 MHz, Peak Detector**

Frequency (MHz)	Peak Analyzer (dBµV/m)	Site Correction Factor (dB/m)	Peak Corrected (dBµV/m)	Peak Limit (dBµV/m)	Peak Margin (dB)
4960.0	47.1	0.5	47.6	74.0	-26.4
7440.0	36.1	2.5	38.6	74.0	-35.4
12400.0	35.7	13.8	49.5	74.0	-24.5
19840.0	36.3	20.5	56.8	74.0	-17.2
22320.0	36.2	22.3	58.5	74.0	-15.5

**Table 11-8: Radiated Emissions Harmonics/Spurious – GFSK - 2480 MHz, Average Detector**

Frequency (MHz)	Average Analyzer (dBµV/m)	Site Correction Factor (dB/m)	Average Corrected (dBµV/m)	Average Limit (dBµV/m)	Average Margin (dB)
4960.0	45.8	0.5	46.3	54.0	-7.7
7440.0	29.0	2.5	31.5	54.0	-22.5
12400.0	27.1	13.8	40.9	54.0	-13.1
19840.0	28.3	20.5	48.8	54.0	-5.2
22320.0	28.4	22.3	50.7	54.0	-3.3

**Table 11-9: Unintentional Emissions Test Data**

Temperature: 43.0°F Humidity: 48% Barometric Pressure: 30.16"Hg										
Emission Frequency (MHz)	Test Detector	Antenna Polarity (H/V)	Turntable Azimuth (°)	Antenna Height (m)	Analyzer Reading (dBμV)	Site Correction Factor (dB/m)	Emission Level (dBμV/m)	Limit (dBμV/m)	Margin (dB)	Pass/Fail
30.400	QP	V	260	1.0	47.1	-19.4	27.7	40.0	-12.3	Pass
32.886	QP	H	40	1.0	46.2	-15.2	31.0	40.0	-9.0	Pass
35.411	QP	V	220	1.0	43.3	-16.6	26.7	40.0	-13.3	Pass
37.996	QP	V	80	1.0	48.8	-18.0	30.8	40.0	-9.2	Pass
50.024	QP	V	190	1.0	52.8	-22.8	30.0	40.0	-10.0	Pass
81.062	QP	H	120	1.5	45.6	-28.5	17.1	40.0	-22.9	Pass
144.483	QP	V	230	1.0	51.9	-26.3	25.6	43.5	-17.9	Pass
147.000	QP	V	140	1.0	50.3	-26.0	24.3	43.5	-19.2	Pass
149.543	QP	V	30	1.0	46.5	-25.5	21.0	43.5	-22.5	Pass
240.053	QP	H	70	1.4	57.1	-20.1	37.0	46.0	-9.0	Pass
250.013	QP	V	80	1.0	55.8	-19.5	36.3	46.0	-9.7	Pass
400.000	QP	H	125	1.5	50.1	-17.4	32.7	46.0	-13.3	Pass
681.200	QP	H	320	1.4	34.5	-11.4	23.2	46.0	-22.8	Pass
994.000	QP	V	325	1.0	33.5	-8.0	25.5	54.0	-28.5	Pass
1042.084	AV	H	90	1.5	42.7	-7.3	35.4	54.0	-18.6	Pass
1050.013	AV	H	330	1.1	35.2	-7.0	28.2	54.0	-25.8	Pass
1114.228	AV	H	339	1.0	32.8	-7.2	25.6	54.0	-28.4	Pass

Measurement uncertainty: ±4.7 dB. This measurement uncertainty is an expanded uncertainty for 95% confidence level received with a coverage factor k=2.

**Results: Pass**

**Test Personnel:**

Daniel W. Baltzell Test Engineer	 Signature	February 14, 2024 Date of Test
-------------------------------------	---	-----------------------------------

**12 Conclusion**

The data in this DSS measurement report shows that the EUT as tested, L3Harris Corporation Model XL-CH2, FCC ID: OWDTR-0171-E, IC: 3636B-0171, complies with the applicable requirements of FCC Parts 2 and 15 and ISSED RSS-247 and RSS-Gen.