



Engineering Solutions & Electromagnetic Compatibility Services

**Certification Application Report
FCC Part 15.247 & ISED RSS-247**

Test Lab: Rhein Tech Laboratories, Inc. Phone: 703-689 0368 360 Herndon Parkway www.rheintech.com Suite 1400 Herndon, VA 20160 E-Mail: atcbinfo@rheintech.com		Applicant: L3Harris Corporation 221 Jefferson Ridge Parkway Lynchburg, VA 24501 USA	
FCC ID / IC	OWDTR-0171-E / 3636B-0171	Test Report Date	April 22, 2024
Platform	N/A	RTL Work Order #	2023034
Model / HVIN	XL-CH2 / XLCU-CH2	RTL Quote Number	QRTL23-034B
American National Standard Institute	ANSI C63.10-2020 American National Standard of Procedures for Compliance Testing of Unlicensed Wireless Devices		
FCC Classification	DTS – Part 15 Digital Transmission System (Wi-Fi)		
FCC Rule Part(s)	FCC Rules Part 15.247: Operation within the bands 902-928 MHz, 2400-2483.5 MHz and 5725-5850 MHz (10-01-21)		
ISED Standards	RSS-247 Issue 3: Digital Transmission Systems (DTSSs), Frequency Hopping Systems (FHSs) and Licence-Exempt Local Area Network (LE-LAN) Devices RSS-Gen Issue 5: General Requirements for Compliance of Radio Apparatus		
Frequency Range (MHz)	Output Power (W) Peak Conducted	Frequency Tolerance	Emission Designator
2402 – 2480	0.005	N/A	759KFXD

I, the undersigned, hereby declare that the equipment tested and referenced in this report conforms to the identified standard(s) as described in this test report. No modifications were made to the equipment during testing in order to achieve compliance with these standards. Furthermore, there was no deviation from, additions to, or exclusions from, the applicable parts of FCC Part 2, FCC Part 15, ANSI C63.10, and ISED RSS-247 and RSS-Gen.

Signature: 

Date: April 22, 2024

Typed/Printed Name: Desmond A. Fraser

Position: President

These tests are accredited and meet the requirements of ISO/IEC 17025 as verified by ANAB. Refer to certificate and scope of accreditation AT-1445. This report replaces R1.0.

This report may not be reproduced, except in full, without the written approval of Rhein Tech Laboratories, Inc. and L3Harris Corporation. The test results relate only to the item(s) tested.

Table of Contents

1	General Information	5
1.1	Scope	5
1.2	Description of EUT	5
1.3	Test Facility	5
1.4	Related Submittal(s)/Grant(s)	5
1.5	Modifications	5
2	Test Information	6
2.1	Description of Test Modes	6
2.2	Exercising the EUT	6
2.3	Test Result Summary	6
2.4	Tested System Details	6
2.5	Configuration of Tested System	7
3	Peak Output Power – FCC 15.247(b)(3); RSS-247 5.4(b), RSS-Gen 6.12	8
3.1	Power Output Test Procedure	8
3.2	Power Output Test Results	8
4	Compliance with the Band Edge – FCC 15.247(d); RSS-247 5.5	12
4.1	Band Edge Test Procedure	12
4.2	Restricted Band Edge Test Results	12
4.3	Band Edge Plots	13
5	Antenna Conducted Spurious Emissions – FCC 15.247(d); RSS-247 5.5, RSS-Gen 6.13	17
5.1	Antenna Conducted Spurious Emissions Test Procedures	17
5.2	Antenna Conducted Spurious Emissions Test Results	17
6	Bandwidths – FCC 15.247(a)(1); RSS-247 5.2(a); RSS-Gen 6.7	18
6.1	Bandwidth Test Procedure	18
6.2	Modulated Bandwidth Test Results	18
7	Power Spectral Density – FCC 15.247(e); RSS-247 5.2(b)	25
7.1	Power Spectral Density Test Procedure	25
7.2	Power Spectral Density Test Results	25
7.3	Power Spectral Density Plots	26
8	AC Conducted Emissions – FCC 15.207; RSS-Gen 8.8	28
9	Radiated Emissions – FCC 15.209; RSS-247 5.5; RSS-Gen 8.9, 8.10	29
9.1	Limits of Radiated Emissions Measurement	29
9.2	Radiated Emissions Measurement Test Procedure	29
9.3	Radiated Emissions Test Results	30
10	Conclusion	33

Figure Index

Figure 2-1:	Configuration of Tested System.....	7
-------------	-------------------------------------	---

Table Index

Table 2-1:	Channels Tested.....	6
Table 2-2:	Test Summary – FCC Part 15, Subpart C (Section 15.247); ISED RSS-247, RSS-Gen.....	6
Table 2-3:	Equipment Under Test (EUT).....	6
Table 2-4:	Auxiliary Equipment.....	7
Table 3-1:	Power Output Test Equipment.....	8
Table 3-2:	Environmental Conditions.....	8
Table 3-3:	Power Output Test Data.....	8
Table 4-1:	Band Edge Test Equipment.....	12
Table 4-2:	Environmental Conditions.....	12
Table 4-3:	Lower Band Edge - Average.....	13
Table 4-4:	Lower Band Edge - Peak.....	14
Table 4-5:	Upper Band Edge - Average.....	15
Table 4-6:	Upper Band Edge - Peak.....	16
Table 5-1:	Antenna Conducted Spurious Emissions Test Equipment.....	17
Table 5-2:	Environmental Conditions.....	17
Table 6-1:	Bandwidth Test Equipment.....	18
Table 6-2:	Environmental Conditions.....	18
Table 6-3:	Modulated Bandwidth Test Data.....	18
Table 7-1:	Bandwidth Test Equipment.....	25
Table 7-2:	Environmental Conditions.....	25
Table 7-3:	Power Spectral Density Test Data.....	25
Table 9-1:	Radiated Emissions Test Equipment.....	30
Table 9-2:	Radiated Emissions Environmental Conditions.....	30
Table 9-3:	Radiated Emissions Harmonics/Spurious – 2402 MHz, Peak Detector.....	30
Table 9-4:	Radiated Emissions Harmonics/Spurious – 2402 MHz, Average Detector.....	31
Table 9-5:	Radiated Emissions Harmonics/Spurious – 2440 MHz, Peak Detector.....	31
Table 9-6:	Radiated Emissions Harmonics/Spurious – 2440 MHz, Average Detector.....	31
Table 9-7:	Radiated Emissions Harmonics/Spurious – 2480 MHz, Peak Detector.....	31
Table 9-8:	Radiated Emissions Harmonics/Spurious – 2480 MHz, Average Detector.....	32
Table 9-9:	Unintentional Emissions Test Data.....	32

Plot Index

Plot 3-1:	Peak Power – 2402 MHz.....	9
Plot 3-2:	Peak Power – 2440 MHz.....	10
Plot 3-3:	Peak Power – 2480 MHz.....	11
Plot 4-1:	Lower Band Edge – Average.....	13
Plot 4-2:	Lower Band Edge – Peak.....	14
Plot 4-3:	Upper Band Edge – Average.....	15
Plot 4-4:	Upper Band Edge – Peak.....	16
Plot 6-1:	6 dB Bandwidth – 2402 MHz.....	19
Plot 6-2:	6 dB Bandwidth – 2440 MHz.....	20
Plot 6-3:	6 dB Bandwidth – 2480 MHz.....	21
Plot 6-4:	99% Bandwidth – 2402 MHz.....	22
Plot 6-5:	99% Bandwidth – 2440 MHz.....	23
Plot 6-6:	99% Bandwidth – 2480 MHz.....	24
Plot 7-1:	Power Spectral Density – 2402 MHz.....	26
Plot 7-2:	Power Spectral Density – 2440 MHz.....	27
Plot 7-3:	Power Spectral Density – 2480 MHz.....	28

Appendix Index

Appendix A: Test Photographs..... 34

Photograph Index

Photograph 1:Radiated Emissions (Spurious/Harmonics) (<1 GHz) - Front View 34
Photograph 2:Radiated Emissions (Spurious/Harmonics) (<1 GHz) – Back View..... 35
Photograph 3:Radiated Emissions (Spurious/Harmonics) (>1 GHz) – Front View..... 36
Photograph 4:Radiated Emissions (Spurious/Harmonics) (>1 GHz) – Back View..... 37
Photograph 5:Conducted Testing 38

1 General Information

1.1 Scope

Applicable Standards

- FCC Part 15.247: Frequency Hopping, Direct Spread Spectrum and Hybrid Systems that are in operation within the bands of 902-928 MHz, 2400-2483.5 MHz and 5725-5850 MHz
- ISED RSS-247: Digital Transmission Systems (DTSS), Frequency Hopping Systems (FHSs) and Licence-Exempt Local Area Network (LE-LAN) Devices
- ISED RSS-Gen Issue 5: General Requirements for Compliance of Radio Apparatus

1.2 Description of EUT

Equipment Under Test	Control Head
Model / HVIN	XL-CH2 / XLCU-CH2
Power Supply	13.8 VDC
Frequency Range	2402–2480 MHz

1.3 Test Facility

The open area test site and conducted measurement facility used to collect the radiated data is located at 360 Herndon Parkway, Suite 1400, Herndon, Virginia 20171.

CAB ID: US0079

1.4 Related Submittal(s)/Grant(s)

This is an original certification application for Harris Corporation Model XL-CH2 Control Head, FCC ID: OWDTR-0171-E, IC: 3636B-0171.

1.5 Modifications

No modifications were required for compliance.

2 Test Information

2.1 Description of Test Modes

The following frequencies were tested in accordance with FCC 15.31(m) because the EUT utilizes an operating band greater than 10 MHz.

Table 2-1: Channels Tested

Channel (#)	Frequency (MHz)
0	2402
19	2440
39	2480

2.2 Exercising the EUT

The EUT was tested in all three orthogonal planes to determine worst-case emissions. The EUT was provided with software to continuously transmit during testing. The carrier was also checked to verify that information was being transmitted, all modes were investigated, and the worst-case mode was used for final testing. There were no deviations from the test standard(s) and/or methods. The test results reported relate only to the item tested.

2.3 Test Result Summary

Table 2-2: Test Summary – FCC Part 15, Subpart C (Section 15.247); ISED RSS-247, RSS-Gen

FCC	ISED	Test	Result
FCC 15.207	RSS-Gen 8.8	AC Conducted Emissions	N/A
FCC 15.209	RSS-247 5.5; RSS-Gen 8.9, 8.10	Radiated Emissions	Pass
FCC 15.247(a)(2)	RSS-247 5.2(a)	6 dB Bandwidth	Pass
FCC 15.247(b)(3)	RSS-247 5.4(b); RSS-Gen 6.12	Maximum Peak Power Output	Pass
FCC 15.247(d)	RSS-247 5.5; RSS-Gen 6.13	Antenna Conducted Spurious Emissions	Pass
FCC 15.247(d)	RSS-247 5.5	Band Edge Measurement	Pass
FCC 15.247(e)	RSS-247 5.2(b)	Power Spectral Density	Pass
N/A	RSS-Gen 6.7	99% Bandwidth	Pass

2.4 Tested System Details

The test sample was received on January 22, 2024. Listed below are the identifiers and descriptions of all equipment, cables, and internal devices used with the EUT for this test, as applicable.

The device was programmed for multiple modes of operation and modulation types.

Table 2-3: Equipment Under Test (EUT)

Part	Manufacturer	Model / HVIN	PN/SN	FCC ID	RTL Bar Code
Control Head	L3Harris Corporation	XL-CH2 / XLCU-CH2	N/A	OWDTR-0171-E	24398
Control Head	L3Harris Corporation	XL-CH2 / XLCU-CH2	N/A	OWDTR-0171-E	24397

Table 2-4: Auxiliary Equipment

Part	Manufacturer	Model	PN/SN	FCC ID	RTL Bar Code
USB Mobile Mic	L3Harris Corporation	USB Mobile Mic	14050-6010-01	N/A	24401

2.5 Configuration of Tested System

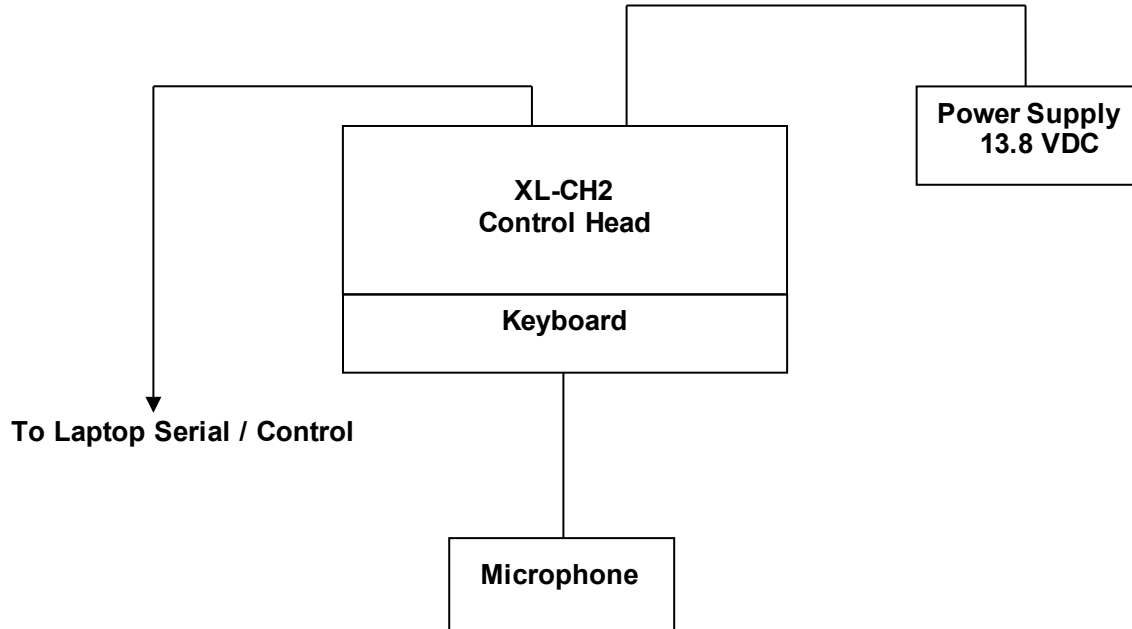

Figure 2-1: Configuration of Tested System

3 Peak Output Power – FCC 15.247(b)(3); RSS-247 5.4(b), RSS-Gen 6.12

3.1 Power Output Test Procedure

A conducted power measurement of the EUT was taken with an analyzer. The following settings were used:

- 1) Span: > the bandwidth, centered on a channel
- 2) RBW > bandwidth of the emission being measured (1 MHz used)
- 3) VBW ≥ RBW (3 MHz used)
- 4) Sweep: Auto
- 5) Detector function: Peak
- 6) Trace: Max hold. The trace was allowed to stabilize, and the marker-to-peak function was used to set the marker to the peak of the emission.

Table 3-1: Power Output Test Equipment

RTL Asset #	Manufacturer	Model	Part Type	Serial Number	Calibration Due Date
901773	Rohde & Schwarz	FSW	Spectrum Analyzer	101021	02/02/2025

3.2 Power Output Test Results

Table 3-2: Environmental Conditions

Date	Temperature (°C)	Humidity (%)	Pressure (kPa)
April 4, 2024	22.7	26	100.6

Table 3-3: Power Output Test Data

Channel (#)	Frequency (MHz)	Conducted Peak Power (dBm)	Limit (dBm)	Margin (dB)
0	2402	7.1	30.0	-22.9
19	2440	6.8	30.0	-23.2
39	2480	6.4	30.0	-23.6

Plot 3-1: Peak Power – 2402 MHz

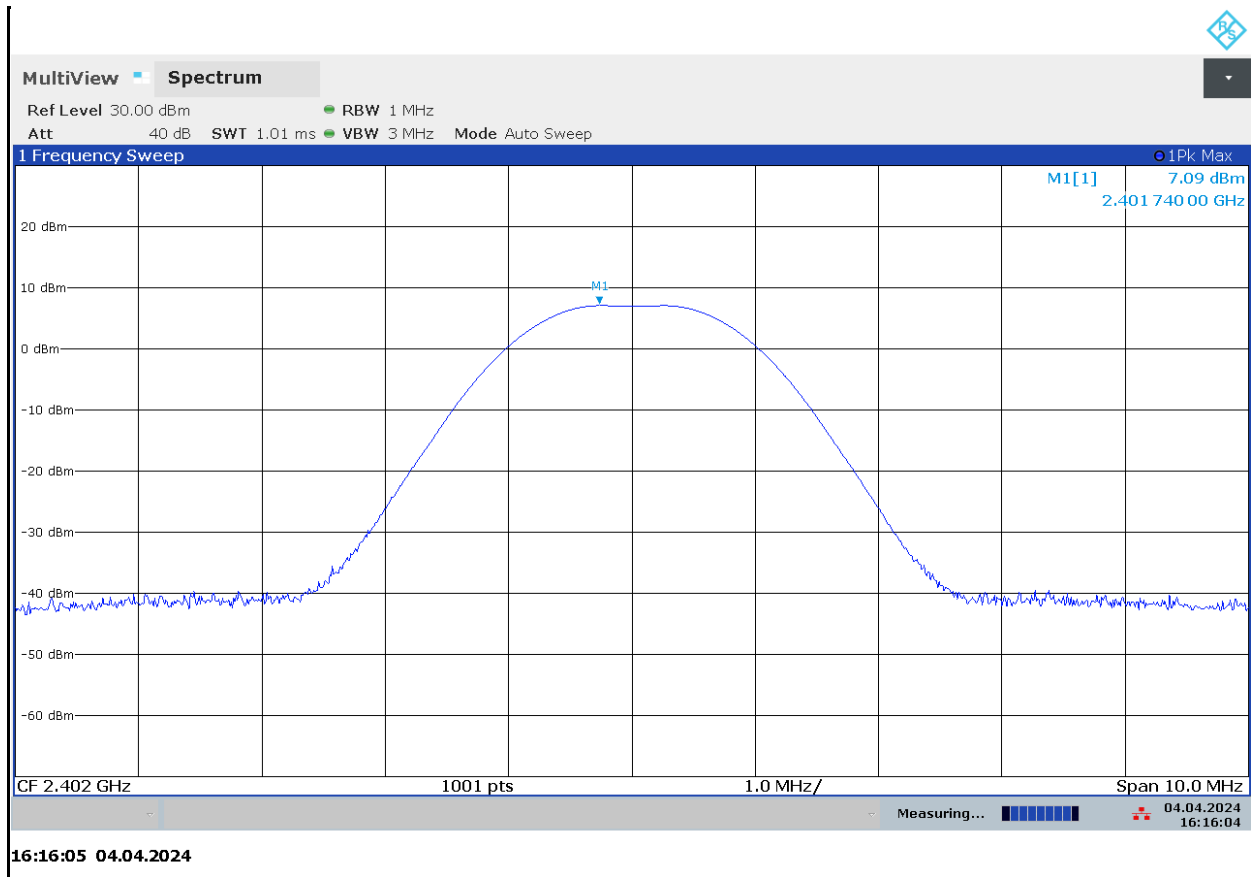

Plot 3-2: Peak Power – 2440 MHz

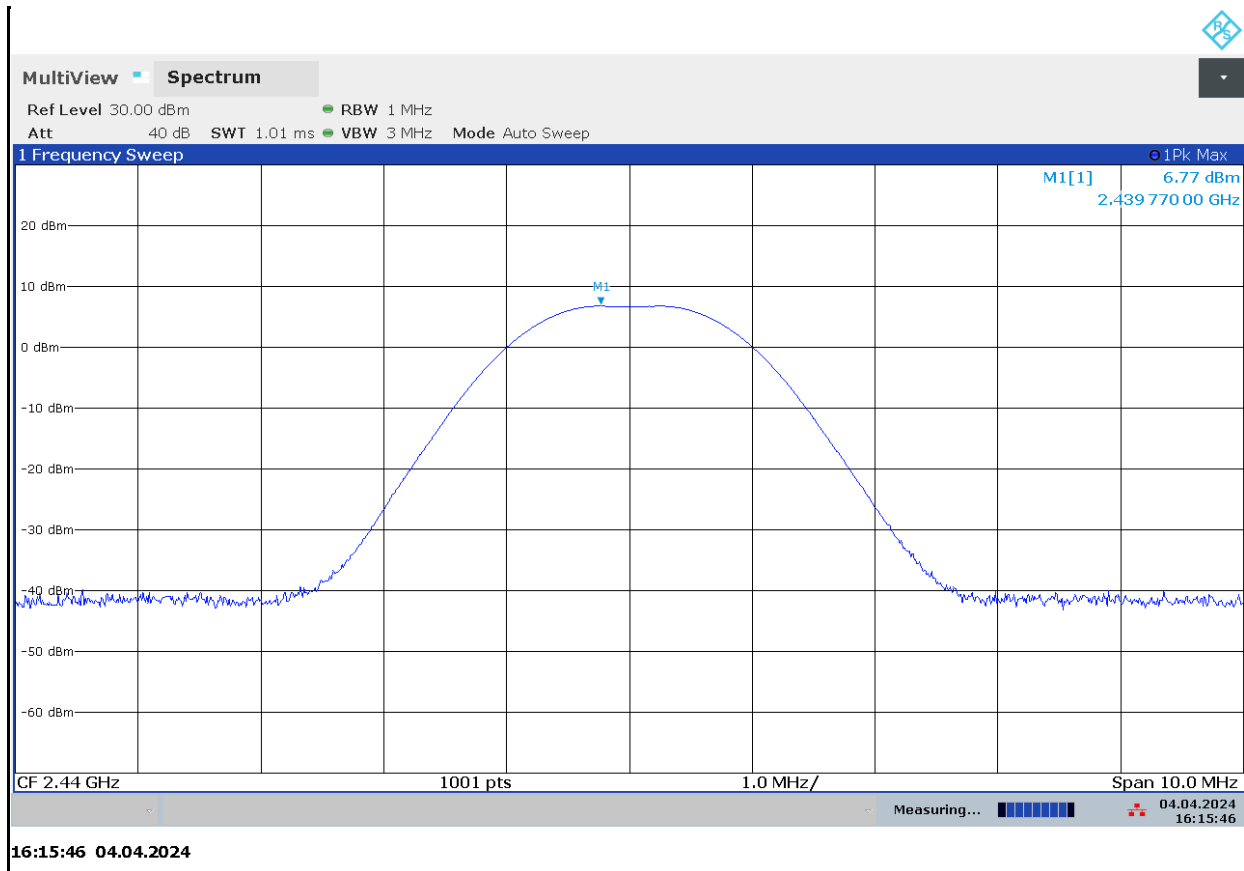

4 Compliance with the Band Edge – FCC 15.247(d); RSS-247 5.5

4.1 Band Edge Test Procedure

The transmitter output was connected to its appropriate antenna. 1 MHz integrated peak (100 kHz RBW/ 300 kHz VBW) and 1 MHz integrated average (100 MHz RBW/300 kHz VBW) corrected measurements were taken within the restricted band to show compliance.

Table 4-1: Band Edge Test Equipment

RTL Asset #	Manufacturer	Model	Part Type	Serial Number	Calibration Due Date
901773	Rohde & Schwarz	FSW	Spectrum Analyzer	101021	02/02/2025

4.2 Restricted Band Edge Test Results

Table 4-2: Environmental Conditions

Date	Temperature (°C)	Humidity (%)	Pressure (kPa)
April 5, 2024	22.2	23	100.8

Conversion of dBm to dBµV/m at 3 m:

$$\text{dB}\mu\text{V}/\text{m} = \text{dBm} + 104.7 - (20 * \text{LOG}(3\text{m})) = \text{dBm} + 95.2$$

4.3 Band Edge Plots

Plot 4-1: Lower Band Edge – Average

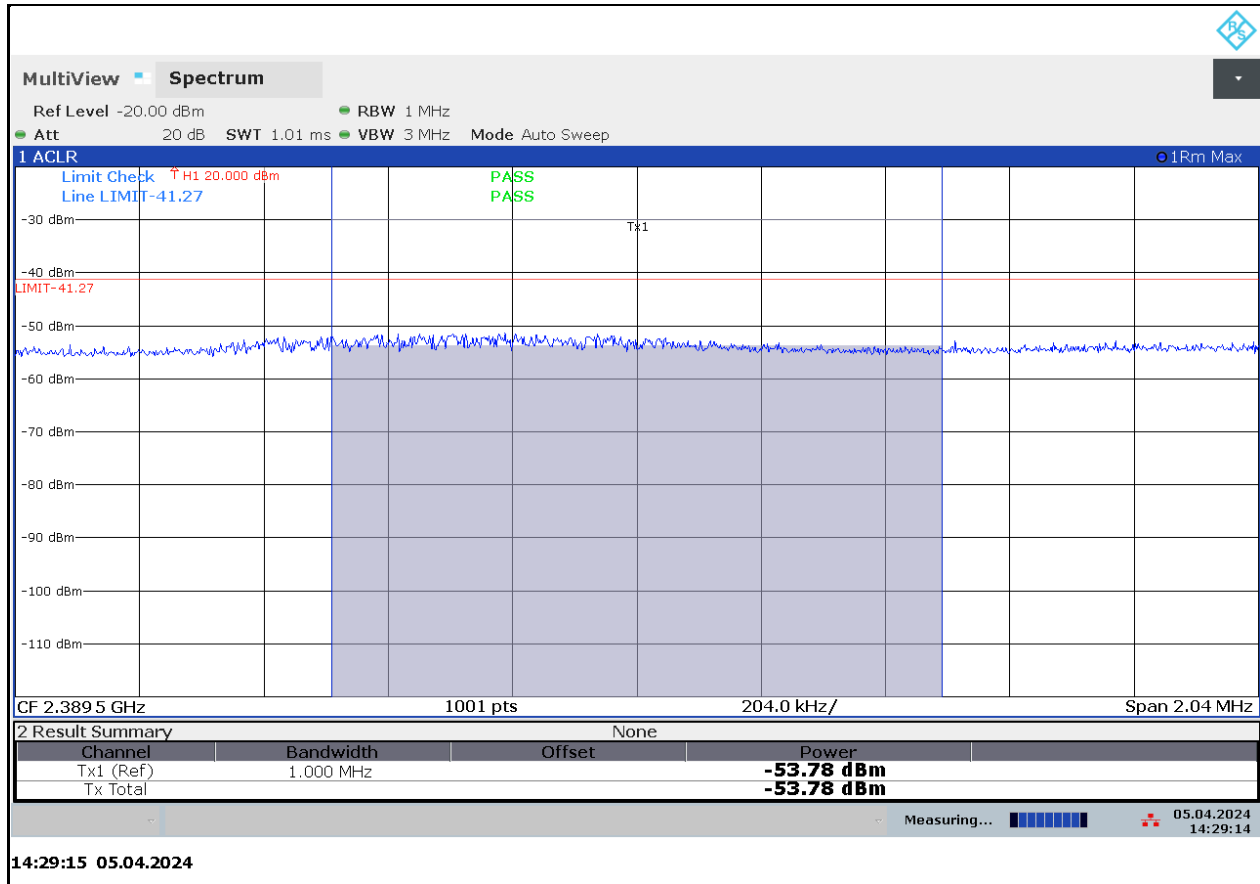

Table 4-3: Lower Band Edge - Average

Frequency (MHz)	Measured Average Level (dBm)	Field Strength Conversion (dBμV/m)	Average Limit (dBμV/m)	Margin (dB)
2389.5	-53.8	41.4	54.0	-12.6

Plot 4-2: Lower Band Edge – Peak

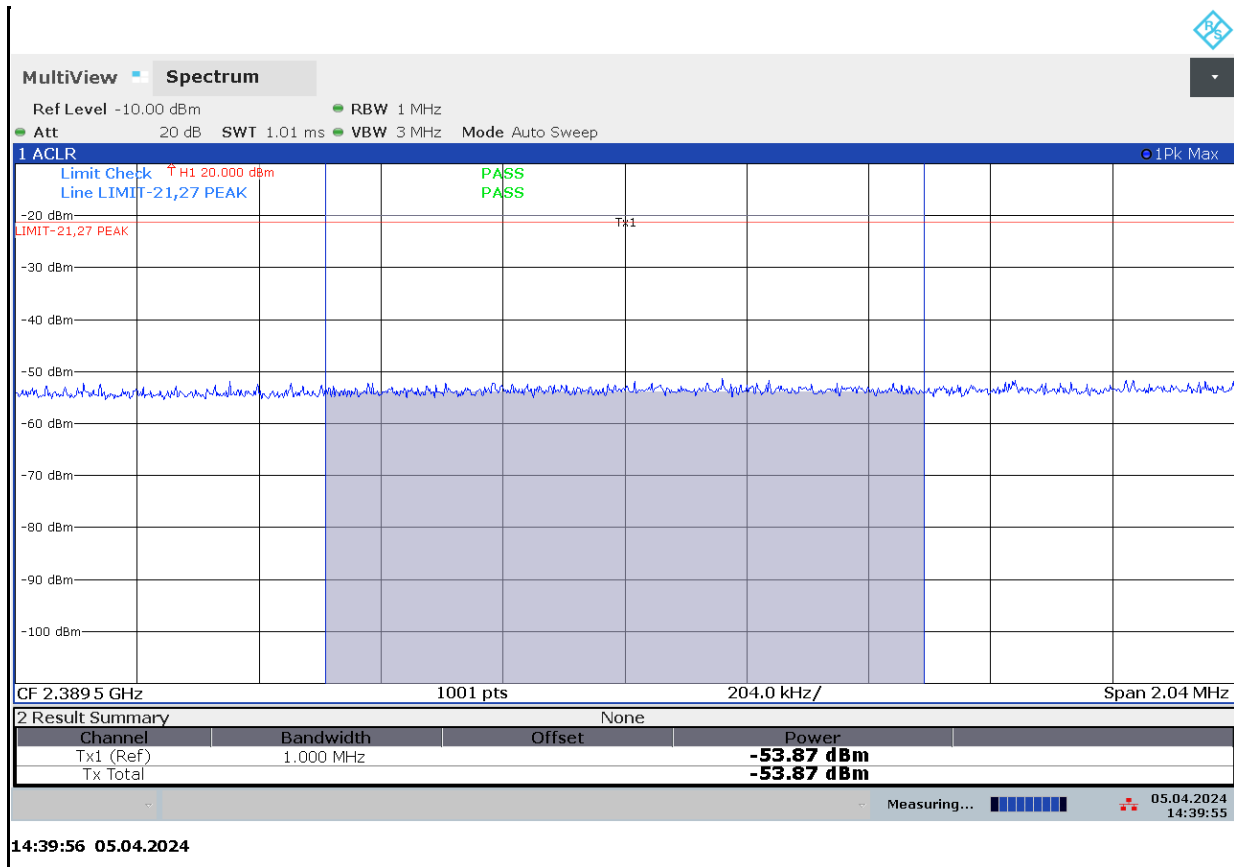

Table 4-4: Lower Band Edge - Peak

Frequency (MHz)	Measured Peak Level (dBm)	Field Strength Conversion (dB μ V/m)	Peak Limit (dB μ V/m)	Margin (dB)
2389.5	-53.9	41.3	74.0	-32.7

Plot 4-3: Upper Band Edge – Average

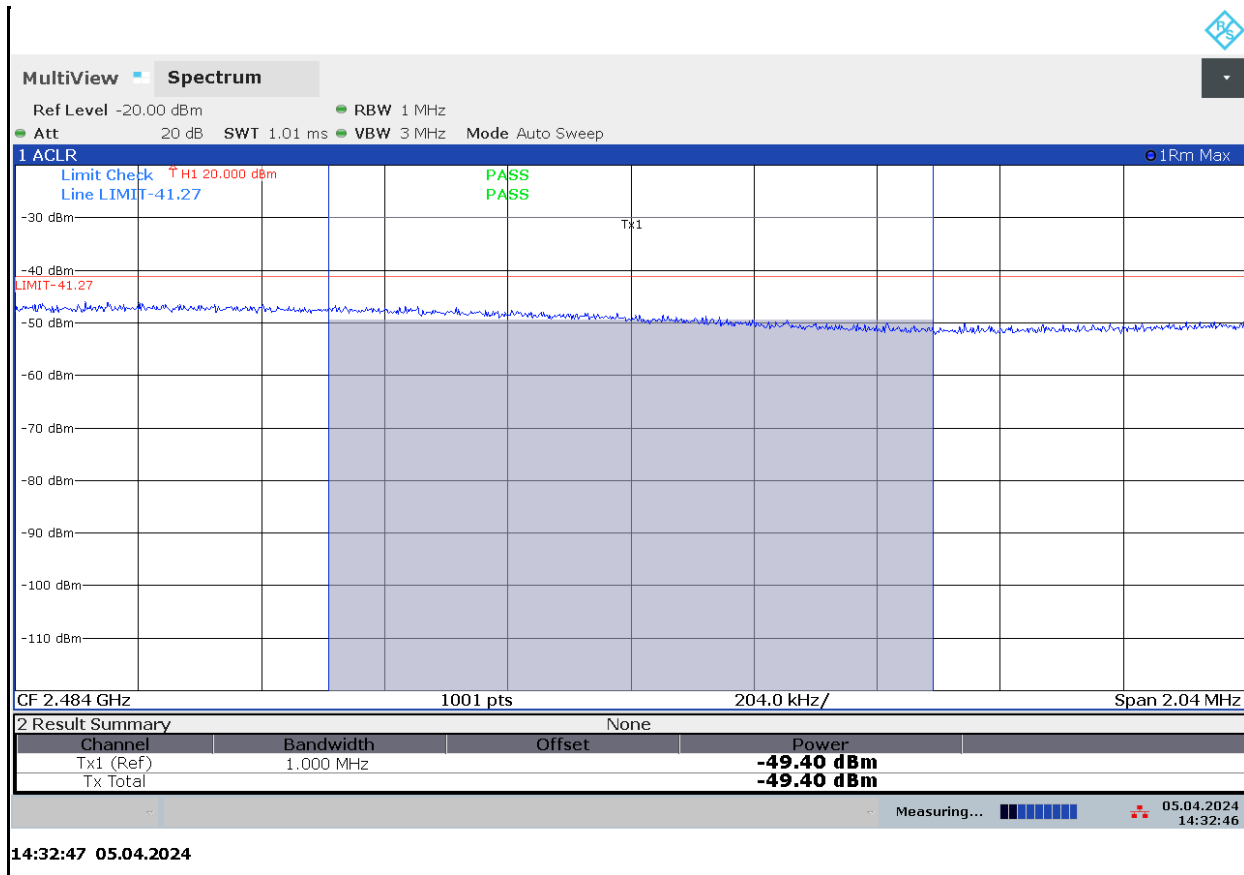

Table 4-5: Upper Band Edge - Average

Frequency (MHz)	Measured Average Level (dBm)	Field Strength Conversion (dBμV/m)	Average Limit (dBμV/m)	Margin (dB)
2484.0	-49.4	45.8	54.0	-8.2

Plot 4-4: Upper Band Edge – Peak

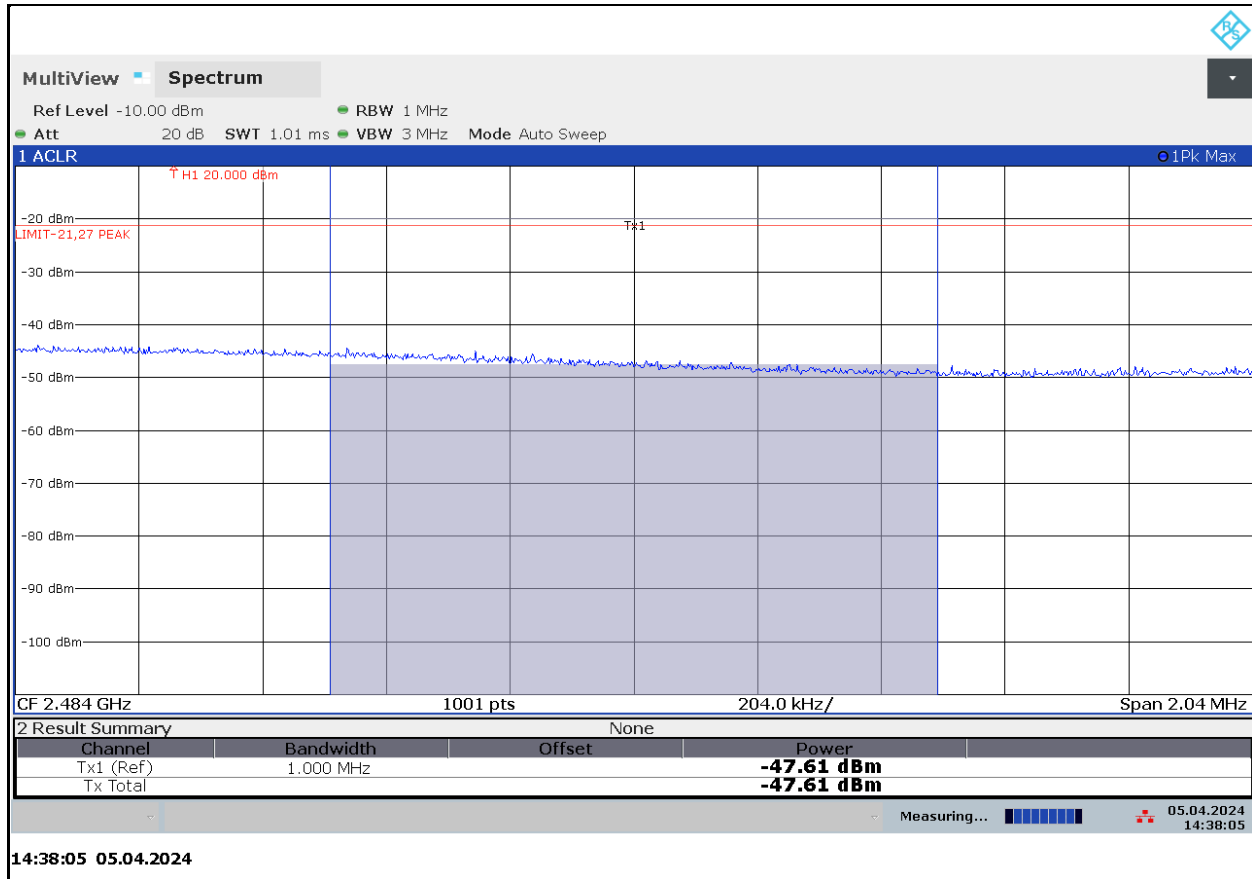

Table 4-6: Upper Band Edge - Peak

Frequency (MHz)	Measured Peak Level (dBm)	Field Strength Conversion (dBµV/m)	Peak Limit (dBµV/m)	Margin (dB)
2484.0	-47.6	47.6	74.0	-26.4

Measurement uncertainty: ±0.5 dB. This measurement uncertainty is an expanded uncertainty for 95% confidence level received with a coverage factor k=2.

Results: Pass

Test Personnel:

Daniel W. Baltzell		April 5, 2024
Test Engineer	Signature	Date of Test

5 Antenna Conducted Spurious Emissions – FCC 15.247(d); RSS-247 5.5, RSS-Gen 6.13

5.1 Antenna Conducted Spurious Emissions Test Procedures

Antenna spurious emissions per FCC 15.247(d) were measured from the EUT antenna port using a 50-ohm spectrum analyzer with the resolution bandwidth set at 100 kHz, and the video bandwidth set at 300 kHz for less than 1 GHz and 1 MHz resolution bandwidth and 3 MHz resolution bandwidth over 1 GHz. The modulated carrier was identified at the following frequencies: 2402 MHz, 2440 MHz and 2480 MHz.

Table 5-1: Antenna Conducted Spurious Emissions Test Equipment

RTL Asset #	Manufacturer	Model	Part Type	Serial Number	Calibration Due Date
901773	Rohde & Schwarz	FSW	Spectrum Analyzer	101021	02/02/2025

5.2 Antenna Conducted Spurious Emissions Test Results

Table 5-2: Environmental Conditions

Date	Temperature (°C)	Humidity (%)	Pressure (kPa)
April 5, 2024	22.2	23	100.8

No harmonics or spurs were found within 20 dB (note that we are reporting power as peak) of the carrier level from the carrier to the 10th harmonic of the carrier frequency.

Measurement uncertainty: ±0.5 dB. This measurement uncertainty is an expanded uncertainty for 95% confidence level received with a coverage factor k=2.

Results: Pass

Test Personnel:

		
Daniel W. Baltzell	Signature	April 5, 2024
Test Engineer		Date of Test

6 Bandwidths – FCC 15.247(a)(1); RSS-247 5.2(a); RSS-Gen 6.7

6.1 Bandwidth Test Procedure

The minimum 6 dB and 99% bandwidths per FCC 15.247(a)(1), RSS-247 5.2(a) and RSS-Gen 6.7 were measured using a 50-ohm spectrum analyzer with the resolution bandwidth set at 100 kHz, and the video bandwidth set at $\geq 3 \times$ RBW. The device was modulated, (VBW) shall not be smaller than three times the RBW value. Video averaging is not permitted.

The maximum 6 dB bandwidth shall be 500 kHz.

Table 6-1: Bandwidth Test Equipment

RTL Asset #	Manufacturer	Model	Part Type	Serial Number	Calibration Due Date
901773	Rohde & Schwarz	FSW	Spectrum Analyzer	101021	02/02/2025

6.2 Modulated Bandwidth Test Results

Table 6-2: Environmental Conditions

Date	Temperature (°C)	Humidity (%)	Pressure (kPa)
April 4, 2024	22.0	33	98.5

Table 6-3: Modulated Bandwidth Test Data

Frequency (MHz)	6 dB Bandwidth (kHz)	99% Bandwidth (MHz)
2402	709	1.055
2440	719	1.046
2480	759	1.053

Plot 6-1: 6 dB Bandwidth – 2402 MHz

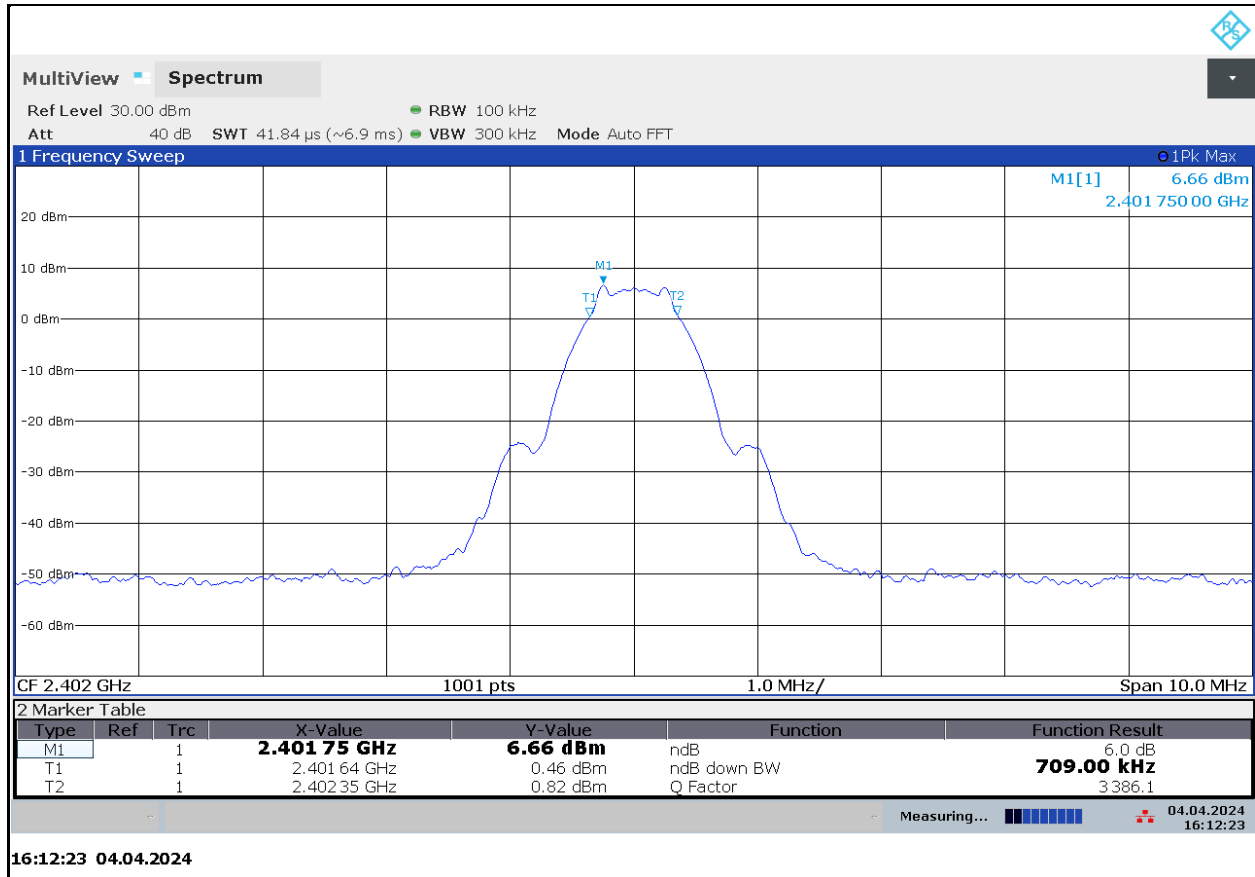

Plot 6-2: 6 dB Bandwidth – 2440 MHz

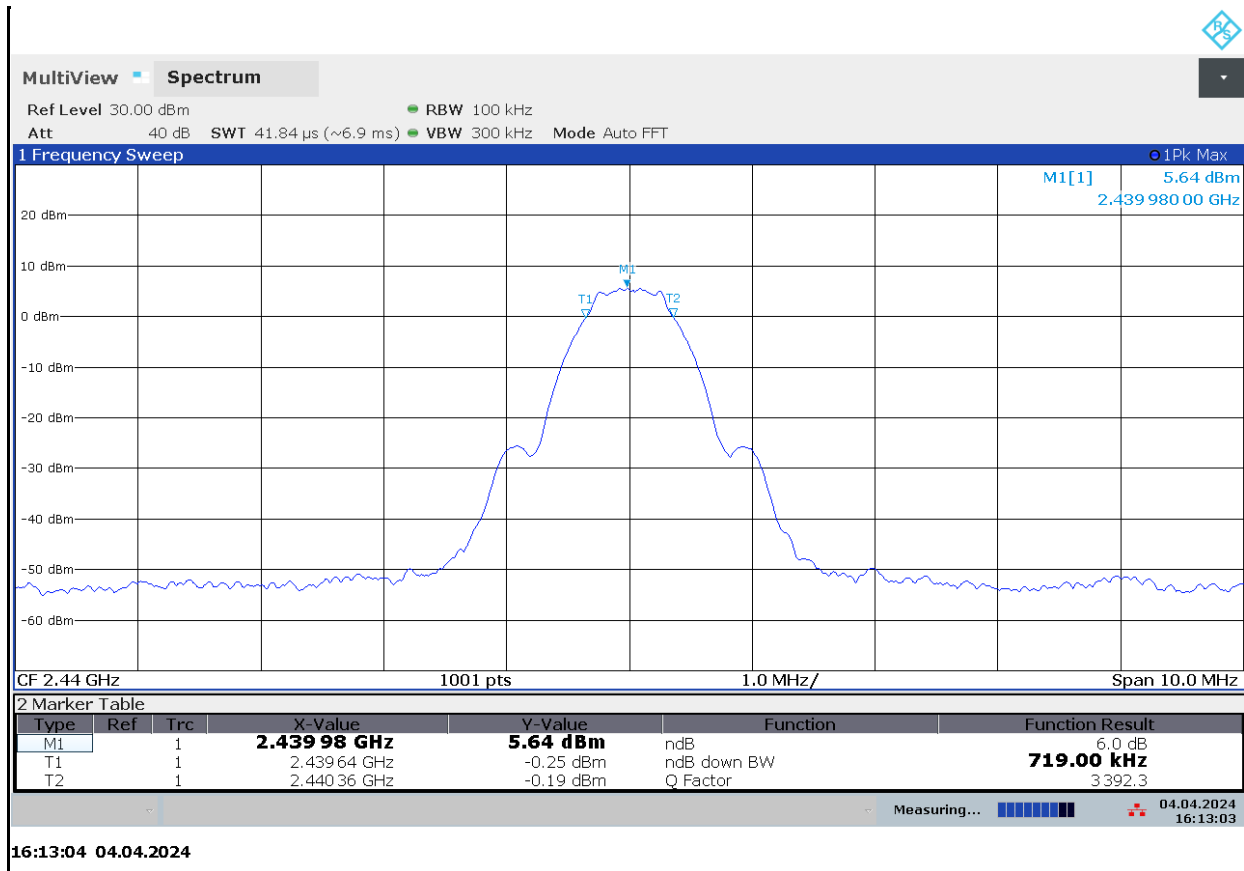

Plot 6-3: 6 dB Bandwidth – 2480 MHz

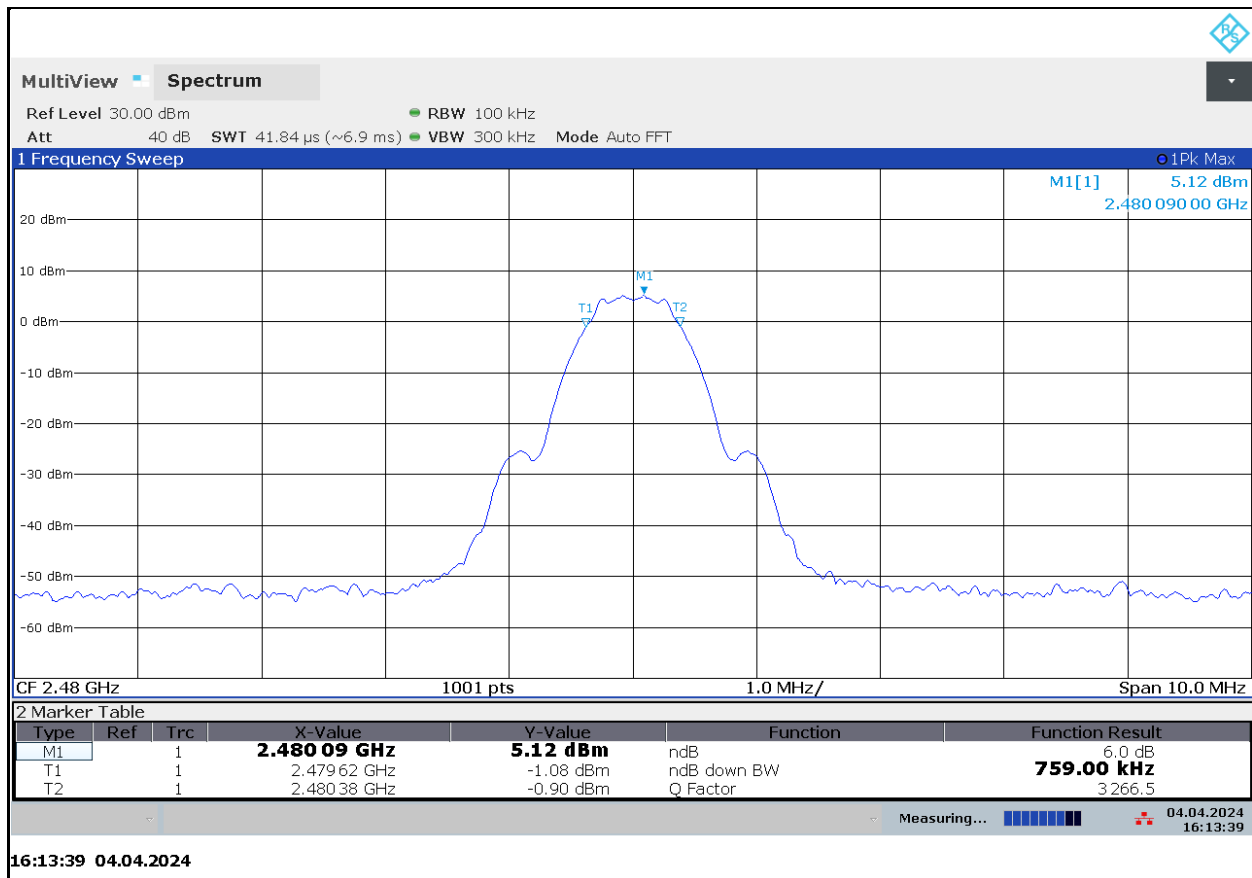

Plot 6-4: 99% Bandwidth – 2402 MHz

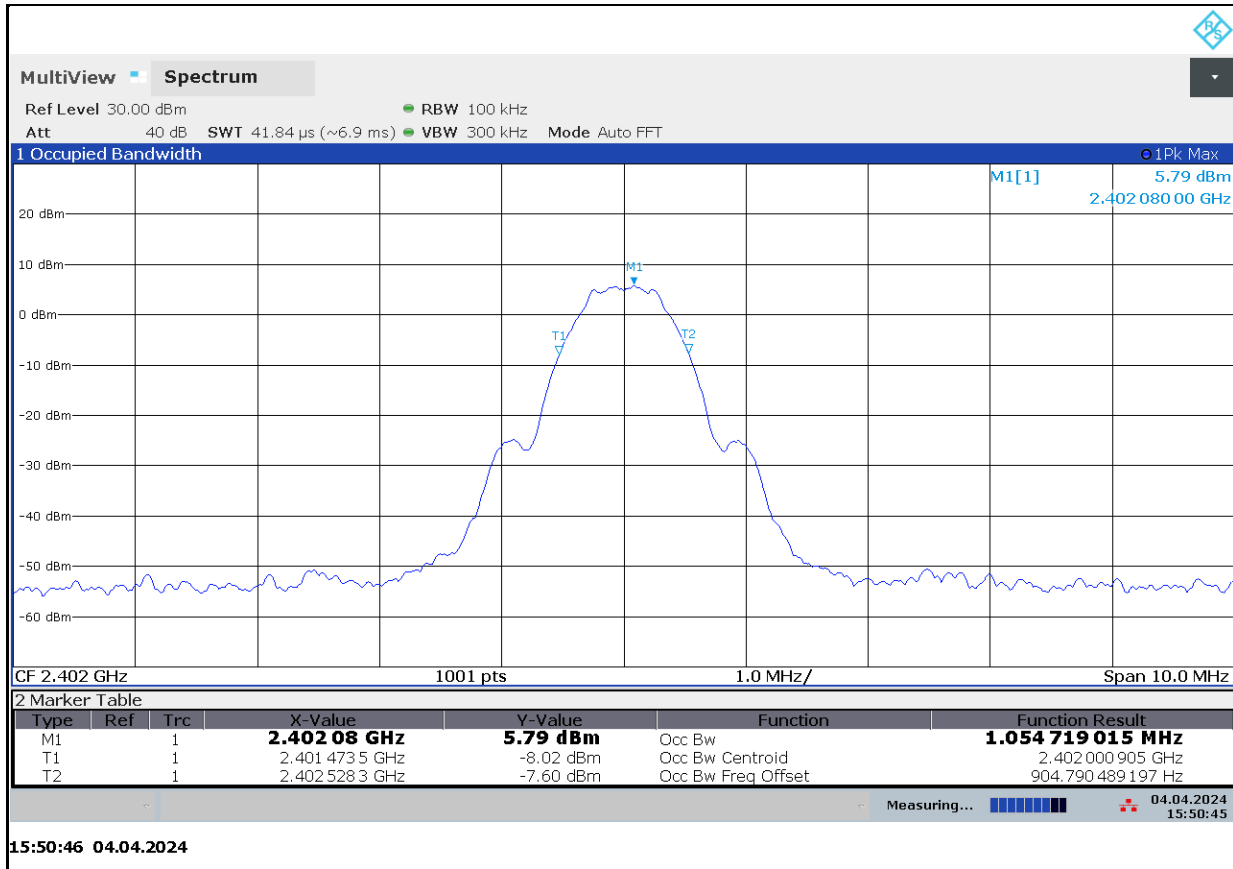

Plot 6-5: 99% Bandwidth – 2440 MHz

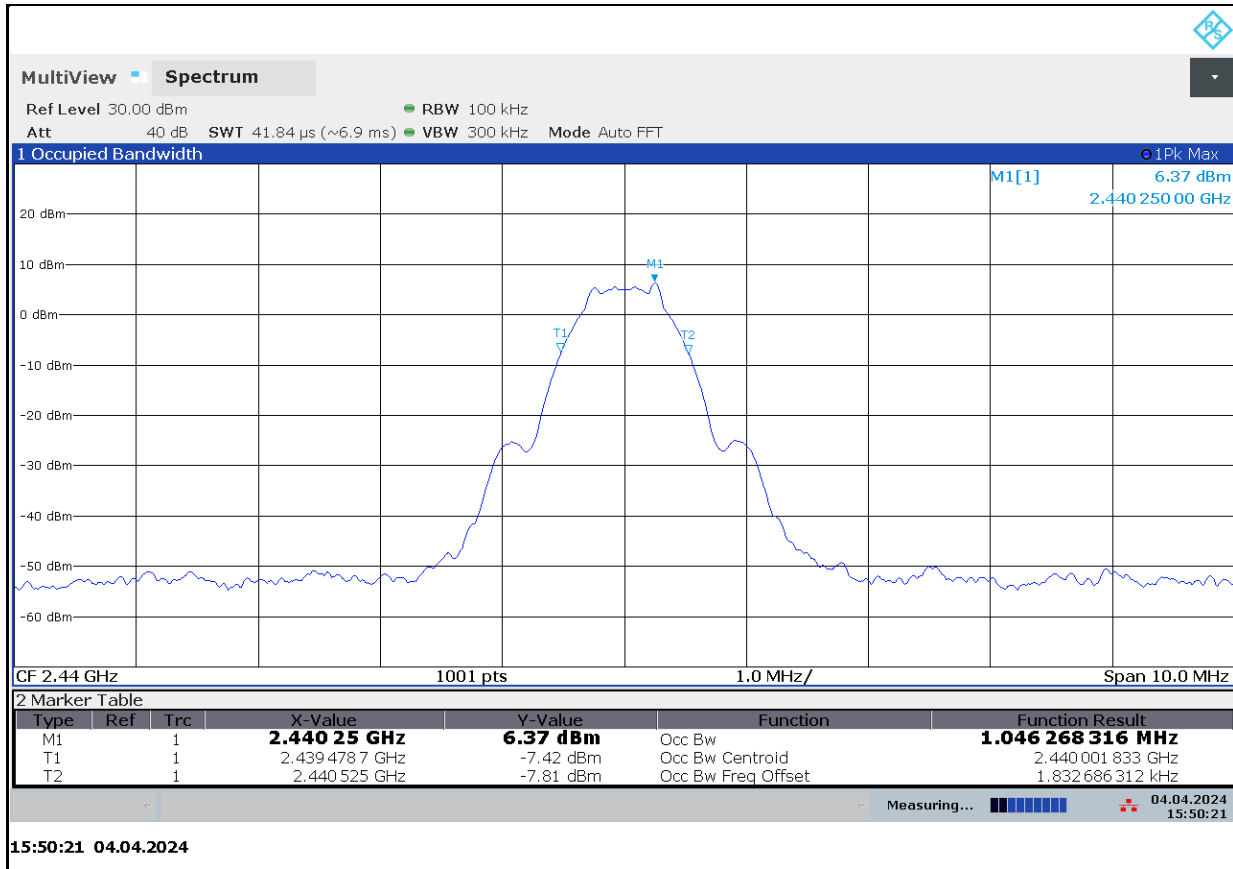

Plot 6-6: 99% Bandwidth – 2480 MHz

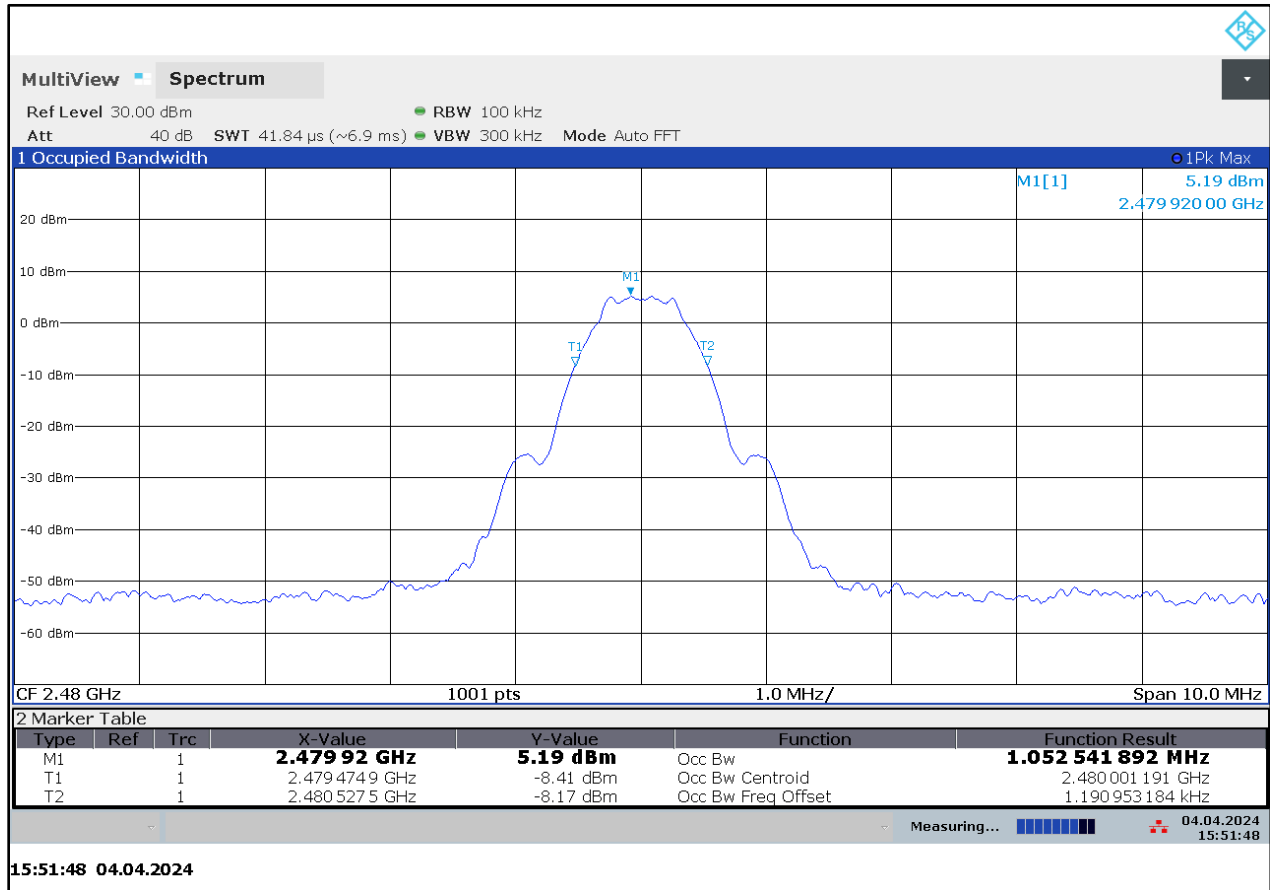

Measurement uncertainty: $\pm 1 \times 10^{-6}$ Hz. This measurement uncertainty is an expanded uncertainty for 95% confidence level received with a coverage factor k=2.

Results: Pass

Test Personnel:

Daniel W. Baltzell
 Test Engineer

Signature

April 4, 2024
 Date of Test

7 Power Spectral Density – FCC 15.247(e); RSS-247 5.2(b)

7.1 Power Spectral Density Test Procedure

The power spectral density per FCC 15.247(e) was measured using a 50-ohm spectrum analyzer with the resolution bandwidth set at 3 kHz, the video bandwidth set at 30 kHz, and the auto sweep time. The spectral lines were resolved for the modulated carriers at 2402 MHz, 2440 MHz, and 2480 MHz. These levels are below the +8 dBm limit.

Table 7-1: Bandwidth Test Equipment

RTL Asset #	Manufacturer	Model	Part Type	Serial Number	Calibration Due Date
901773	Rohde & Schwarz	FSW	Spectrum Analyzer	101021	02/02/2025

7.2 Power Spectral Density Test Results

Table 7-2: Environmental Conditions

Date	Temperature (°C)	Humidity (%)	Pressure (kPa)
April 4, 2024	22.0	33	98.5

Table 7-3: Power Spectral Density Test Data

Frequency (MHz)	PSD (dBm)	Limit (dBm)	Margin (dB)	Result (Pass / Fail)
2402	-2.9	8.0	10.9	Pass
2440	-3.3	8.0	11.3	Pass
2480	-3.6	8.0	11.6	Pass

7.3 Power Spectral Density Plots

Plot 7-1: Power Spectral Density – 2402 MHz

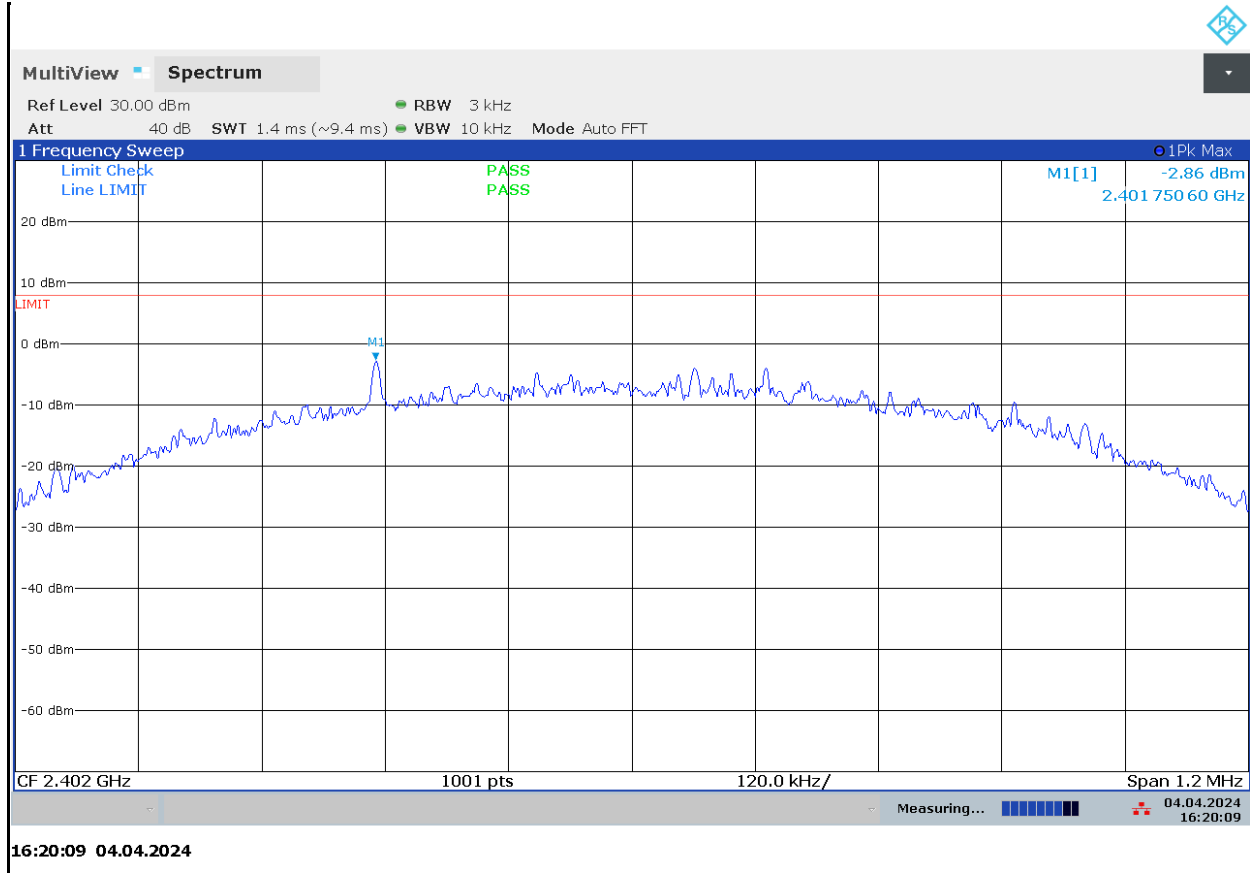

Plot 7-2: Power Spectral Density – 2440 MHz

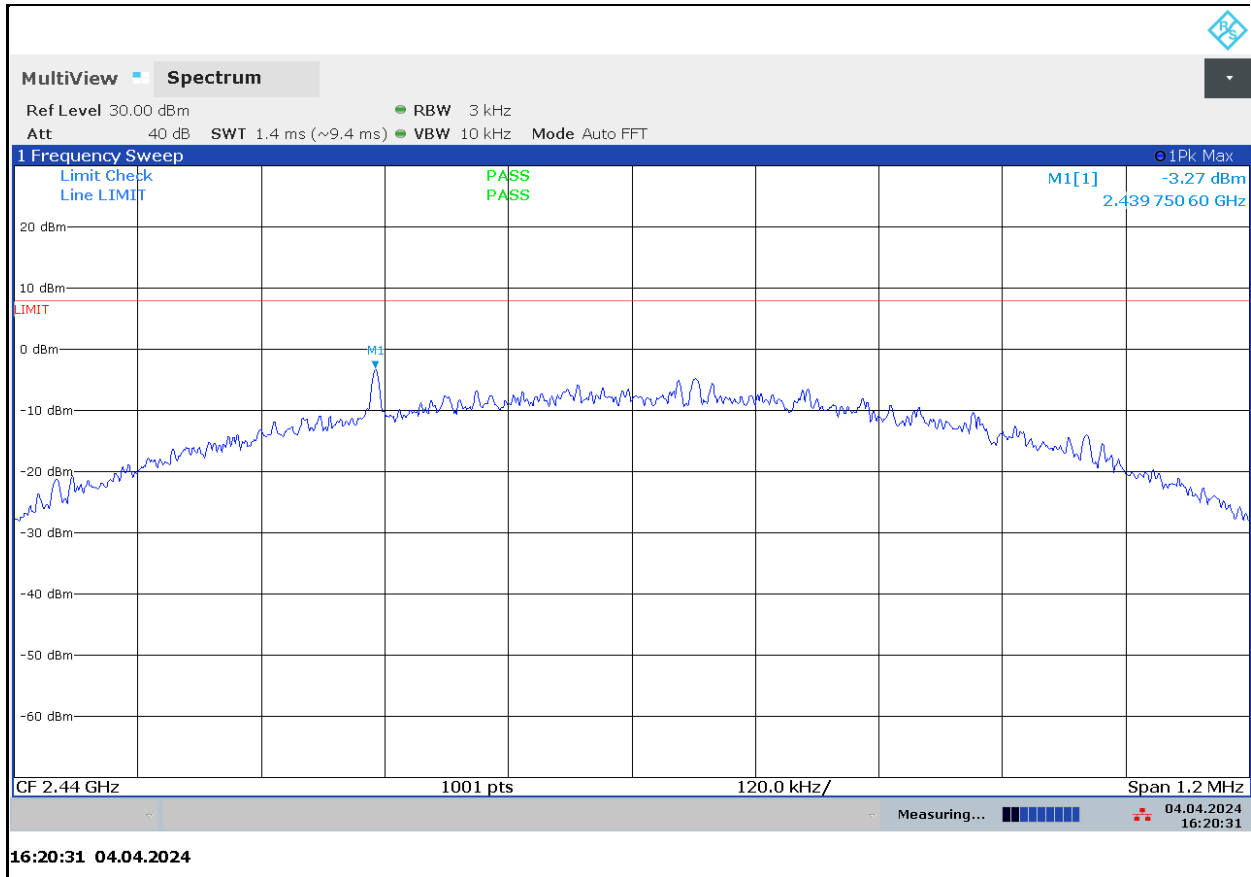

Plot 7-3: Power Spectral Density – 2480 MHz

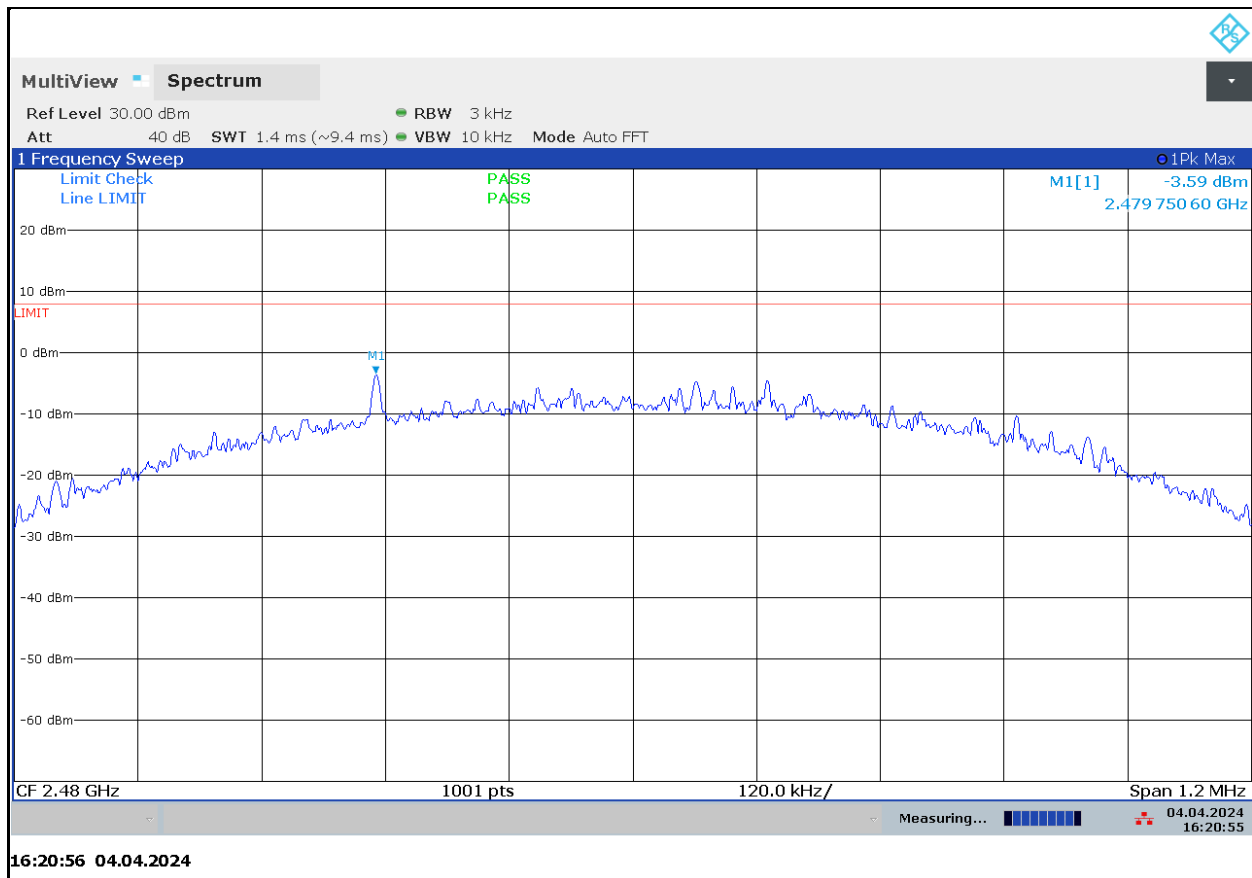

Measurement uncertainty: ± 0.5 dB. This measurement uncertainty is an expanded uncertainty for 95% confidence level received with a coverage factor $k=2$.

Results: Pass

Test Personnel:

Daniel W. Baltzell		April 4, 2024
Test Engineer	Signature	Date of Test

8 AC Conducted Emissions – FCC 15.207; RSS-Gen 8.8

The device is a mobile 13.8 VDC equipment. AC line conducted emissions measurements are not required.

9 Radiated Emissions – FCC 15.209; RSS-247 5.5; RSS-Gen 8.9, 8.10

9.1 Limits of Radiated Emissions Measurement

Frequency (MHz)	Field Strength ($\mu\text{V}/\text{m}$)	Measurement Distance (m)
0.009-0.490	2400/f (kHz)	300
0.490-1.705	2400/f (kHz)	30
1.705-30.0	30	30
30-88	100	3
88-216	150	3
216-960	200	3
Above 960	500	3

As shown in 15.35(b), for frequencies above 1000 MHz, the field strength limits are based on average detector, however, the peak field strength of any emission shall not exceed the maximum permitted average limits, specified above by more than 20 dB under any circumstances of modulation.

9.2 Radiated Emissions Measurement Test Procedure

Before final measurements of radiated emissions were made on the open-field three/ten meter range, the EUT was scanned indoors at one and three meter distances. This was done in order to determine its emissions spectrum signature. The physical arrangement of the test system and associated cabling was varied in order to determine the effect on the EUT's emissions in amplitude, direction and frequency. This process was repeated during final radiated emissions measurements on the open-field range, at each frequency, in order to ensure that maximum emission amplitudes were attained.

Final radiated emissions measurements were made on the three/ten-meter, open-field test site. The EUT was placed on a nonconductive turntable 0.8 meters above the ground plane. The spectrum was examined from 9 kHz to the 10th harmonic of the highest fundamental transmitter frequency (24.8 GHz).

At each frequency, the EUT was rotated 360°, and the antenna was raised and lowered from 1 to 4 meters in order to determine the emission's maximum level. Measurements were taken using both horizontal and vertical antenna polarizations. For frequencies between 30 and 1000 MHz, the spectrum analyzer's 6 dB bandwidth was set to 120 kHz, and the analyzer was operated in the CISPR quasi-peak detection mode. For emissions above 1000 MHz, emissions are measured using the average detector function with a minimum resolution bandwidth of 1 MHz. No video filter less than 10 times the resolution bandwidth was used. The highest emission amplitudes relative to the appropriate limit were measured and recorded in this report.

Table 9-1: Radiated Emissions Test Equipment

RTL Asset Number	Manufacturer	Model	Part Type	Serial Number	Calibration Due Date
900772	EMCO	3161-02	Horn Antenna (2.0–4.0 GHz)	9804-1044	08/05/2024
900321	EMCO	3161-03	Horn Antennas (4.0–8.2 GHz)	9508-1020	08/05/2024
900323	EMCO	3160-7	Horn Antennas (8.2–12.4 GHz)	9605-1054	08/05/2024
900356	EMCO	3160-08	Horn Antenna (12.4–18.0 GHz)	9607-1044	08/05/2024
901218	EMCO	3160-09	Horn Antenna (18.0–26.5 GHz)	960281-003	08/05/2024
901669	ETS-Lindgren	3142E	Biconilog Antenna (30 MHz–6000 MHz)	00166065	07/11/2025
900932	Hewlett Packard	8449B OPT H02	Preamplifier (1-26.5 GHz)	3008A00505	01/30/2025
901729	Insulated Wire Inc.	KPS-1503-3150-KPR	SMK RF Cables 20'	NA	12/29/2024
901477	Micro-Coax	UFA210A-0-0360-300300	RF cable 0.04-18 GHz	212349-002	09/01/2024
900905	Rhein Tech Laboratories	PR-1040	OATS 1 Preamplifier 40dB (30 MHz–2 GHz)	1006	01/30/2025
901672	Rohde & Schwarz	FSEM30	Spectrum Analyzer	FSEM30	03/29/2025
901773	Rohde & Schwarz	FSW	Spectrum Analyzer	101021	02/02/2025

9.3 Radiated Emissions Test Results

Table 9-2: Radiated Emissions Environmental Conditions

Date	Temperature (°C)	Humidity (%)	Pressure (kPa)
February 13, 2024	15	38	101.3
April 7, 2024	16.7	37	1019

Table 9-3: Radiated Emissions Harmonics/Spurious – 2402 MHz, Peak Detector

Frequency (MHz)	Peak Analyzer (dBµV/m)	Site Correction Factor (dB/m)	Peak Corrected (dBµV/m)	Peak Limit (dBµV/m)	Peak Margin (dB)
4804.0	59.7	-3.4	56.3	74.0	-17.7
12010.0	44.1	2.1	46.2	74.0	-27.8
19216.0	39.0	10.4	49.4	74.0	-24.6

Table 9-4: Radiated Emissions Harmonics/Spurious – 2402 MHz, Average Detector

Frequency (MHz)	Average Analyzer (dBµV/m)	Site Correction Factor (dB/m)	Average Corrected (dBµV/m)	Average Limit (dBµV/m)	Average Margin (dB)
4804.0	56.8	-3.4	53.4	54.0	-0.6
12010.0	33.9	2.1	36.0	54.0	-18.0
19216.0	31.1	10.4	41.5	54.0	-12.5

Table 9-5: Radiated Emissions Harmonics/Spurious – 2440 MHz, Peak Detector

Frequency (MHz)	Peak Analyzer (dBµV/m)	Site Correction Factor (dB/m)	Peak Corrected (dBµV/m)	Peak Limit (dBµV/m)	Peak Margin (dB)
4880.0	59.4	-3.2	56.2	74.0	-17.8
7320.0	42.1	0.5	42.6	74.0	-31.4
12200.0	42.2	2.4	44.6	74.0	-29.4
19520.0	40.2	9.9	50.1	74.0	-23.9

Table 9-6: Radiated Emissions Harmonics/Spurious – 2440 MHz, Average Detector

Frequency (MHz)	Average Analyzer (dBµV/m)	Site Correction Factor (dB/m)	Average Corrected (dBµV/m)	Average Limit (dBµV/m)	Average Margin (dB)
4880.0	56.7	-3.2	53.5	54.0	-0.5
7320.0	33.8	0.5	34.3	54.0	-19.7
12200.0	32.6	2.4	35.0	54.0	-19.0
19520.0	31.8	9.9	41.7	54.0	-12.3

Table 9-7: Radiated Emissions Harmonics/Spurious – 2480 MHz, Peak Detector

Frequency (MHz)	Peak Analyzer (dBµV/m)	Site Correction Factor (dB/m)	Peak Corrected (dBµV/m)	Peak Limit (dBµV/m)	Peak Margin (dB)
4960.0	56.3	-2.2	54.1	74.0	-19.9
7440.0	42.4	0.3	42.7	74.0	-31.3
12400.0	41.8	6.0	47.8	74.0	-26.2
19840.0	39.8	10.1	49.9	74.0	-24.1
22320.0	39.7	10.1	49.8	74.0	-24.2

Table 9-8: Radiated Emissions Harmonics/Spurious – 2480 MHz, Average Detector

Frequency (MHz)	Average Analyzer (dBµV/m)	Site Correction Factor (dB/m)	Average Corrected (dBµV/m)	Average Limit (dBµV/m)	Average Margin (dB)
4960.0	53.6	-2.2	51.4	54.0	-2.6
7440.0	33.2	0.3	33.5	54.0	-20.5
12400.0	32.0	6.0	38.0	54.0	-16.0
19840.0	32.4	10.1	42.5	54.0	-11.5
22320.0	31.2	10.1	41.3	54.0	-12.7

Table 9-9: Unintentional Emissions Test Data

Temperature: 43.0°F Humidity: 48% Barometric Pressure: 30.16"Hg										
Emission Frequency (MHz)	Test Detector	Antenna Polarity (H/V)	Turntable Azimuth (°)	Antenna Height (m)	Analyzer Reading (dBµV)	Site Correction Factor (dB/m)	Emission Level (dBµV/m)	Limit (dBµV/m)	Margin (dB)	Pass/Fail
30.400	QP	V	260	1.0	47.1	-19.4	27.7	40.0	-12.3	Pass
32.886	QP	H	40	1.0	46.2	-15.2	31.0	40.0	-9.0	Pass
35.411	QP	V	220	1.0	43.3	-16.6	26.7	40.0	-13.3	Pass
37.996	QP	V	80	1.0	48.8	-18.0	30.8	40.0	-9.2	Pass
50.024	QP	V	190	1.0	52.8	-22.8	30.0	40.0	-10.0	Pass
81.062	QP	H	120	1.5	45.6	-28.5	17.1	40.0	-22.9	Pass
144.483	QP	V	230	1.0	51.9	-26.3	25.6	43.5	-17.9	Pass
147.000	QP	V	140	1.0	50.3	-26.0	24.3	43.5	-19.2	Pass
149.543	QP	V	30	1.0	46.5	-25.5	21.0	43.5	-22.5	Pass
240.053	QP	H	70	1.4	57.1	-20.1	37.0	46.0	-9.0	Pass
250.013	QP	V	80	1.0	55.8	-19.5	36.3	46.0	-9.7	Pass
400.000	QP	H	125	1.5	50.1	-17.4	32.7	46.0	-13.3	Pass
681.200	QP	H	320	1.4	34.5	-11.4	23.1	46.0	-22.9	Pass
994.000	QP	V	325	1.0	33.5	-8.0	25.5	54.0	-28.5	Pass
1042.084	AV	H	90	1.5	42.7	-7.3	35.4	54.0	-18.6	Pass
1050.013	AV	H	330	1.1	35.2	-7.0	28.2	54.0	-25.8	Pass
1114.228	AV	H	339	1.0	32.8	-7.2	25.6	54.0	-28.4	Pass

Measurement uncertainty: ±4.7 dB. This measurement uncertainty is an expanded uncertainty for 95% confidence level received with a coverage factor k=2.

Results: Pass

Rhein Tech Laboratories, Inc.
360 Herndon Parkway
Suite 1400
Herndon, VA 20170
<http://www.rheintech.com>

Client: L3Harris Corporation
Model / HVIN: XL-CH2 / XLCU-CH2
Standards: FCC 15.247 & ISED RSS-247
ID's: OWDTR-0171-E/3636B-0171
Report #: 2023034DTSBLE

Test Personnel:

Daniel W. Baltzell Test Engineer	 Signature	February 13, 2024 & April 7, 2024 Dates of Test
-------------------------------------	---	---

10 Conclusion

The data in this measurement report shows that the EUT as tested, L3Harris Corporation XL-CH2 Control Head, FCC ID: OWDTR-0171-E, IC: 3636B-0171, complies with the applicable requirements of FCC Parts 2 and 15 and ISED RSS-247 and RSS-Gen.