



Engineering Solutions & Electromagnetic Compatibility Services

**FCC Part 15.247 & Industry Canada RSS-247 Test Report**

<b>Test Lab:</b> Rhein Tech Laboratories, Inc.      Tel: 703-689-0368 360 Herndon Parkway              Fax: 703-689-2056 Suite 1400                              www.rheintech.com Herndon, VA 20170 E-Mail: <a href="mailto:atcbinfo@rheintech.com">atcbinfo@rheintech.com</a>		<b>Applicant:</b> Harris Corporation 221 Jefferson Ridge Parkway Lynchburg, VA 24501 Tel: 434-455-9290	
<b>FCC ID/IC</b>	OWDTR-0153-E 3636B-0153	<b>Test Report Date:</b>	March 1, 2017
<b>Platform</b>	N/A	<b>RTL Work Order #</b>	2017075
<b>Model</b>	XL-185P	<b>RTL Quote #</b>	QRTL17-069B
<b>American National Standard Institute</b>	ANSI C63.10-2013: American National Standard of Procedures for Compliance Testing of Unlicensed Wireless Devices		
<b>FCC Classification</b>	DTS – Part 15 Digital Transmission System		
<b>FCC Rule Part(s)/Guidance</b>	FCC Rules Part 15.247: Operation within the bands 902-928 MHz, 2400-2483.5 MHz and 5725-5850 MHz Direct Sequence System (10/01/2015)		
<b>Industry Canada</b>	RSS-247 Issue 2 Digital Transmission Systems (DTSs), Frequency Hopping Systems (FHSs) and Licence-Exempt Local Area Network (LE-LAN) Devices		
<b>Digital Interface Information</b>	Digital Interface was found to be compliant		
<b>Frequency Range (MHz)</b>	<b>Output Power (W)*</b>	<b>Frequency Tolerance</b>	<b>Emission Designator</b>
2402 – 2480	0.05	N/A	1M46FXD

\* power is conducted

I, the undersigned, hereby declare that the equipment tested and referenced in this report conforms to the identified standard(s) as described in this test report. No modifications were made to the equipment during testing in order to achieve compliance with these standards. Furthermore, there was no deviation from, additions to, or exclusions from, the applicable parts of FCC Part 2, FCC Part 15, Industry Canada RSS-247, RSS-Gen, and ANSI C63.10.

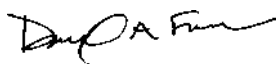
Signature: 

Date: March 1, 2017

Typed/Printed Name: Desmond A. Fraser

Position: President

*This report may not be reproduced, except in full, without the full written approval of Rhein Tech Laboratories, Inc. and Harris Corporation. Test results relate only to the item(s) tested.*

*These test(s) are accredited under Rhein Tech Laboratories, Inc. ISO/IEC 17025 accreditation issued by ANAB. Refer to certificate and scope of accreditation AT-1445.*

## Table of Contents

---

1	General Information.....	5
1.1	Scope .....	5
1.2	Description of EUT.....	5
1.3	Test Facility.....	5
1.4	Related Submittal(s)/Grant(s).....	5
1.5	Modifications.....	5
2	Test Information .....	6
2.1	Description of Test Modes.....	6
2.2	Exercising the EUT .....	6
2.3	Test Result Summary.....	6
2.4	Tested System Details .....	7
3	Peak Output Power – FCC 15.247(b)(1), RSS-247 5.4(2), RSS-Gen 6.12.....	8
3.1	Power Output Test Procedure .....	8
3.2	Power Output Test Data.....	8
4	Duty Cycle Correction.....	9
5	Antenna Conducted Spurious Emissions – FCC 15.247(d), RSS-247 5.5.....	11
6	Band-Edge Compliance of RF Conducted Emissions – FCC 15.247(d), RSS-247 5.5 .....	11
6.1	Band Edge Test Procedure .....	11
6.2	Test Results.....	12
6.3	Radiated Band Edge Emissions .....	16
7	20 dB Bandwidth – FCC 15.247(a)(1), RSS-247 5.1(1).....	17
7.1	20 dB Bandwidth Test Procedure .....	17
7.2	20 dB Modulated Bandwidth Test Data.....	17
7.3	20 dB Bandwidth Plots .....	18
8	Carrier Frequency Separation - 15.247(a)(1), RSS-247 5.1(2).....	27
8.1	Carrier Frequency Separation Test Procedure.....	27
8.2	Carrier Frequency Separation Test Data .....	28
9	Hopping Characteristics – FCC 15.247(a)(1)(iii), RSS-247 5.1(4).....	29
9.1	Hopping Characteristics Test Procedure .....	29
9.2	Number of Hopping Frequencies.....	29
9.3	Average Time of Occupancy .....	30
10	Radiated Emissions Test Results - FCC Rules and Regulations Part 15.247(d), RSS-247 2.2.....	32
10.1	Limits of Radiated Emissions Measurement .....	32
10.2	Radiated Emissions Measurement Test Procedure .....	32
10.2.1	Radiated Emissions Harmonics/Spurious Test Data.....	33
11	Conclusion .....	36

## Figure Index

---

Figure 2-1: Configuration of Tested System.....	7
---	---

## Table Index

---

Table 2-1: Channels Tested .....	6
Table 2-2: Test Result Summary – FCC Part 15, Subpart C (Section 15.247).....	6
Table 2-3: Equipment Under Test (EUT).....	7
Table 2-4: Accessory Test Equipment .....	7
Table 3-1: Power Output Test Data .....	8
Table 3-2: Power Output Test Equipment.....	8
Table 4-1: Duty Cycle Test Equipment .....	11
Table 6-1: Band-Edge Compliance of RF Conducted Emissions Test Equipment.....	15
Table 6-2: Radiated Band Edge Emissions Test Data.....	16
Table 6-3: Radiated Band Edge Test Equipment .....	16
Table 7-1: 20 dB Modulated Bandwidth Test Data.....	17
Table 7-2: 20 dB Bandwidth Test Equipment.....	27
Table 9-1: Hopping Characteristics Test Equipment .....	31
Table 10-1: Radiated Emissions Harmonics/Spurious - 2402 MHz - Average.....	33
Table 10-2: Radiated Emissions Harmonics/Spurious - 2402 MHz - Peak.....	33
Table 10-3: Radiated Emissions Harmonics/Spurious - 2441 MHz - Average.....	33
Table 10-4: Radiated Emissions Harmonics/Spurious – 2441 MHz - Peak.....	34
Table 10-5: Radiated Emissions Harmonics/Spurious - 2480 MHz - Average.....	34
Table 10-6: Radiated Emissions Harmonics/Spurious – 2480 MHz - Peak.....	34
Table 10-7: Radiated Emissions Harmonics/Spurious – Hopping Mode .....	35
Table 10-8: Radiated Emissions Test Equipment .....	36

## Plot Index

---

Plot 4-1: Pulse Width - 417us .....	9
Plot 4-2: Single Pulse per 100ms.....	10
Plot 6-1: Lower Band Edge TX Frequency - 2402 MHz .....	12
Plot 6-2: Lower Band Edge TX Frequency - 2402 MHz (Hopping).....	13
Plot 6-3: Upper Band Edge TX Frequency - 2480 MHz .....	14
Plot 6-4: Upper Band Edge TX Frequency - 2480 MHz (Hopping).....	15
Plot 7-1: 20 dB Bandwidth - 2402 MHz; GFSK.....	18
Plot 7-2: 20 dB Bandwidth - 2402 MHz; 2-EDR.....	19
Plot 7-3: 20 dB Bandwidth - 2402 MHz; 3-EDR.....	20
Plot 7-4: 20 dB Bandwidth - 2441 MHz; GFSK.....	21
Plot 7-5: 20 dB Bandwidth - 2441 MHz; 2-EDR.....	22
Plot 7-6: 20 dB Bandwidth - 2441 MHz; 3-EDR.....	23
Plot 7-7: 20 dB Bandwidth - 2480 MHz; GFSK.....	24
Plot 7-8: 20 dB Bandwidth - 2480 MHz; 2-EDR.....	25
Plot 7-9: 20 dB Bandwidth - 2480 MHz; 3-EDR.....	26
Plot 8-1: Carrier Frequency Separation.....	28
Plot 9-1: Number of Hopping Frequencies (2402 - 2480 MHz) .....	29
Plot 9-2: Time of Occupancy (Dwell Time).....	30
Plot 9-3: Number of Pulses in 3.16 Second Sweep .....	31

---

**Appendix Index**

---

Appendix A: Test Photographs ..... 37

---

**Photograph Index**

---

Photograph 1: Radiated Emissions – Front View ..... 37  
Photograph 2: Radiated Emissions – Back View ..... 38

## 1 General Information

### 1.1 Scope

This is an original FCC and Industry Canada certification application report.

Applicable Standards:

- FCC Rules Part 15.247: Frequency Hopping, Direct Spread Spectrum and Hybrid Systems that are in operation within the bands of 902-928 MHz, 2400-2483.5 MHz and 5725-5850 MHz.
- RSS-247 Issue 2: Digital Transmission Systems (DTSs), Frequency Hopping Systems (FHSs) and Licence-Exempt Local Area Network (LE-LAN) Devices

### 1.2 Description of EUT

<b>Equipment Under Test</b>	XL-185P Portable Radio
<b>Model</b>	XL-185P
<b>Power Supply</b>	Internal radio battery operated
<b>Modulation Type</b>	FHSS
<b>Frequency Range</b>	2402 – 2480 MHz
<b>Antenna Connector Type</b>	N/A
<b>Antenna Type</b>	Internal chip

### 1.3 Test Facility

The open area test site and conducted measurement facility used to collect the radiated data is located at 360 Herndon Parkway, Suite 1400, Herndon, Virginia 20170. This site has been fully described in a report and approved by the Federal Communications Commission to perform AC line conducted and radiated emissions testing.

### 1.4 Related Submittal(s)/Grant(s)

This report supports a certification application for Harris Corporation Model XL-185P, FCC ID: OWDTR-0153-E, IC: 3636B-0153.

### 1.5 Modifications

None.

## 2 Test Information

### 2.1 Description of Test Modes

In accordance with FCC 15.31(m), and because the EUT utilizes an operating band greater than 10 MHz, the following frequencies were tested:

**Table 2-1: Channels Tested**

Channel	Frequency
Low	2402
Middle	2441
High	2480

### 2.2 Exercising the EUT

The EUT was supplied with test software to select various transmit/receive modes (for example, high, mid, and low channel, hopping on/off, etc.) for testing, and to continuously transmit during testing. The carrier was also checked to verify that information was being transmitted. There were no deviations from the test standard(s) and/or methods. The test results reported relate only to the item tested.

GFSK, 2-EDR and 3-EDR modes were investigated. Where pertinent, data is presented for the three modes; otherwise, worst-case data is presented. GFSK was found to be worst case for radiated measurements, data for it is presented.

### 2.3 Test Result Summary

**Table 2-2: Test Result Summary – FCC Part 15, Subpart C (Section 15.247)**

Test	FCC Reference	IC Reference	Pass/Fail or N/A
AC Power Conducted Emissions	FCC 15.207	RSS-Gen 8.8	Pass
Radiated Emissions	FCC 15.209	RSS-247 5.5 RSS-Gen 6.13/7.1	Pass
Maximum Peak Power Output	FCC 15.247(b)(1)	RSS-247 5.4 RSS-Gen 6.12	Pass
Antenna Conducted Spurious Emissions	FCC 15.247(d)	RSS-247 5.5 RSS-Gen 6.13	Pass
Band Edge Measurement	FCC 15.247(d)	RSS-247 5.5	Pass
Carrier Frequency Separation	FCC 15.247(a)(1)	RSS-247 5.1(b)	Pass
20 dB Bandwidth	FCC 15.247(a)(1)(ii)	RSS-247 5.1(a)	Pass
Hopping Characteristics	FCC 15.247(a)(1)(iii)	RSS-247 5.1(d)	Pass

## 2.4 Tested System Details

The test sample was received on December 16, 2014. Listed below are the identifiers and descriptions of all equipment, cables, and internal devices used with the EUT for this test, as applicable.

**Table 2-3: Equipment Under Test (EUT)**

Part	Manufacturer	Model	Serial #	FCC ID	RTL Bar Code
Bluetooth Radio	Harris Corporation	XL-185P	E00236	OWDTR-0153-E	21612
Conducted Port Bluetooth Radio	Harris Corporation	XL-185P	OWXD-E00239	OWDTR-0153-E	21614
Radio	Harris Corporation	XL-185P (System)	14035-1000-01/ 0WXD-E00234	OWDTR-0153-E	21564

**Table 2-4: Accessory Test Equipment**

Part	Manufacturer	Model	Serial #	FCC ID	RTL Bar Code
Battery Eliminator	Harris Corporation	14035-4300-01	N/A	N/A	21553
Breakout Box	Harris Corporation	12082-7980-01	N/A	N/A	20599
Battery	Harris Corporation	BAT-L-CASE-R-HR003	Engineering Sample #73	N/A	21552
Laptop	Samsung	NP300E5A-A01UB	HJVF93EB903201D	N/A	901550

**Figure 2-1: Configuration of Tested System**

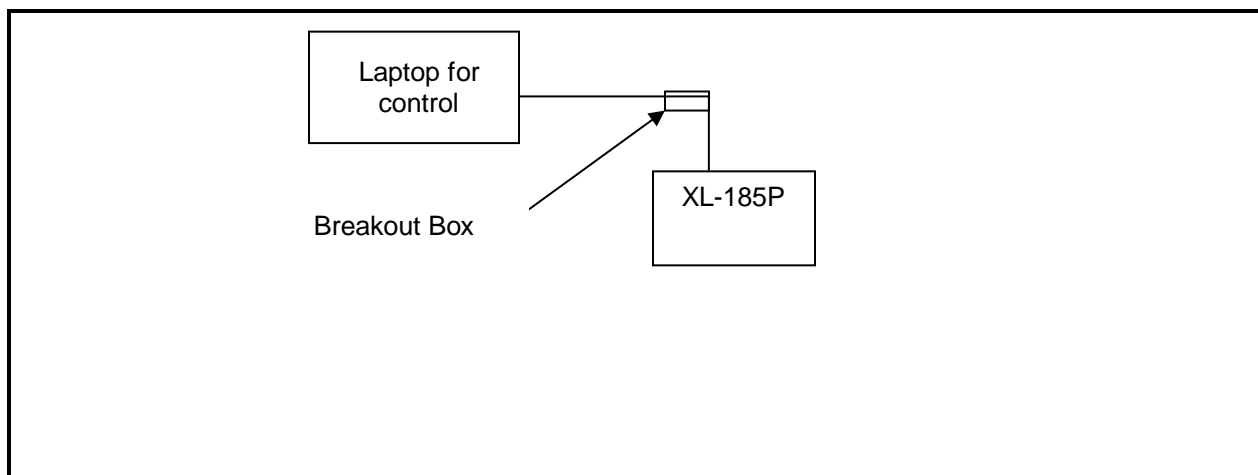

### 3 Peak Output Power – FCC 15.247(b)(1), RSS-247 5.4(b), RSS-Gen 6.12

#### 3.1 Power Output Test Procedure

Procedure: C63.10-2013

#### 3.2 Power Output Test Data

Table 3-1: Power Output Test Data

Frequency (MHz)	Peak Power (dBm)	Peak Power (mW)
2402	17.0	50.1
2441	17.0	50.1
2480	16.7	46.8

Table 3-2: Power Output Test Equipment

RTL Asset #	Manufacturer	Model	Part Type	Serial Number	Calibration Due Date
901581	Rohde & Schwarz	FSU	Spectrum Analyzer	1166.1660.50	11/13/15

#### Test Personnel:

Daniel W. Baltzell  
EMC Test Engineer



Signature

February 24, 2015  
Date of Tests



#### 4 Duty Cycle Correction

Plot 4-1: Pulse Width - 417us

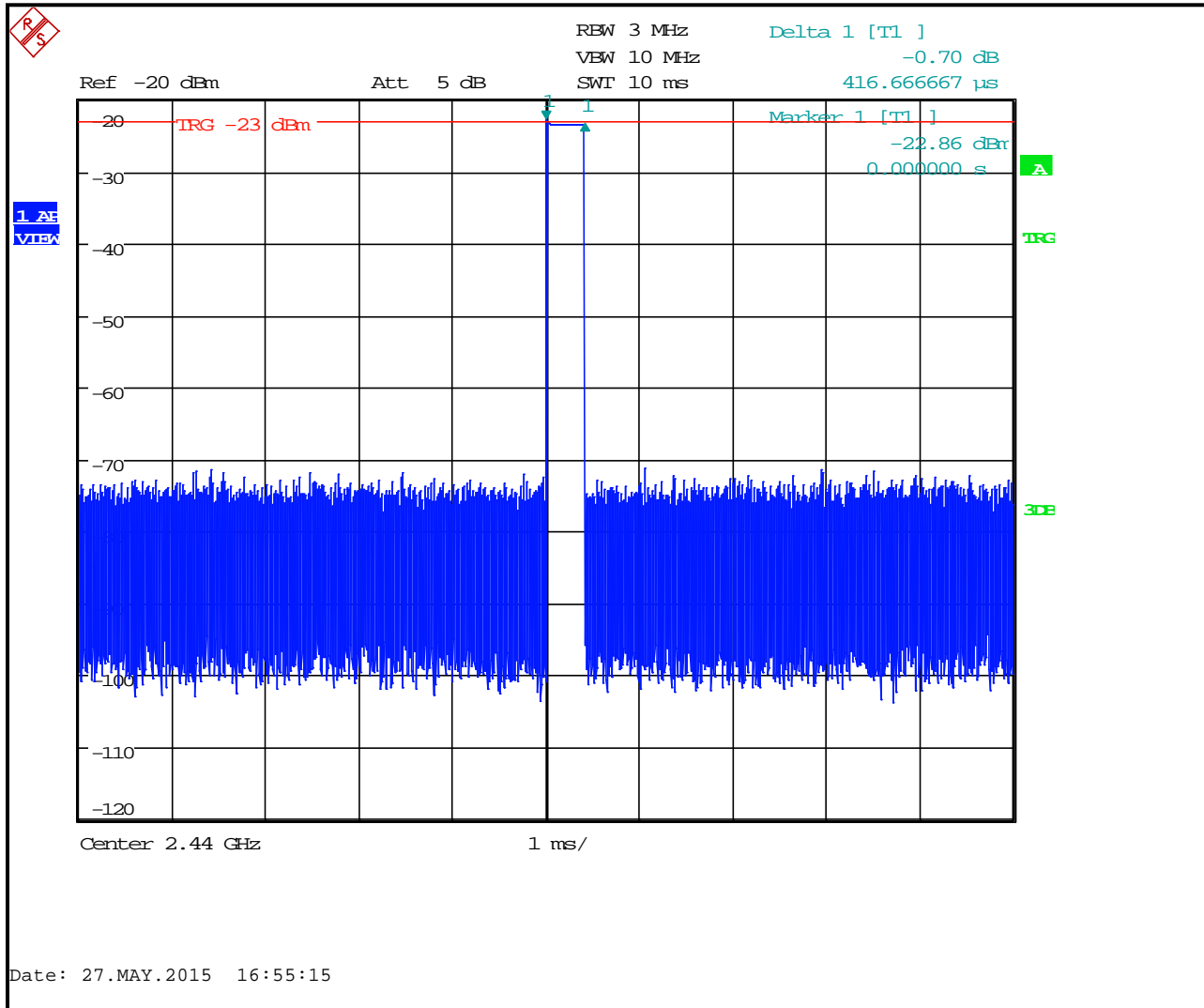

**Plot 4-2: Single Pulse per 100ms**

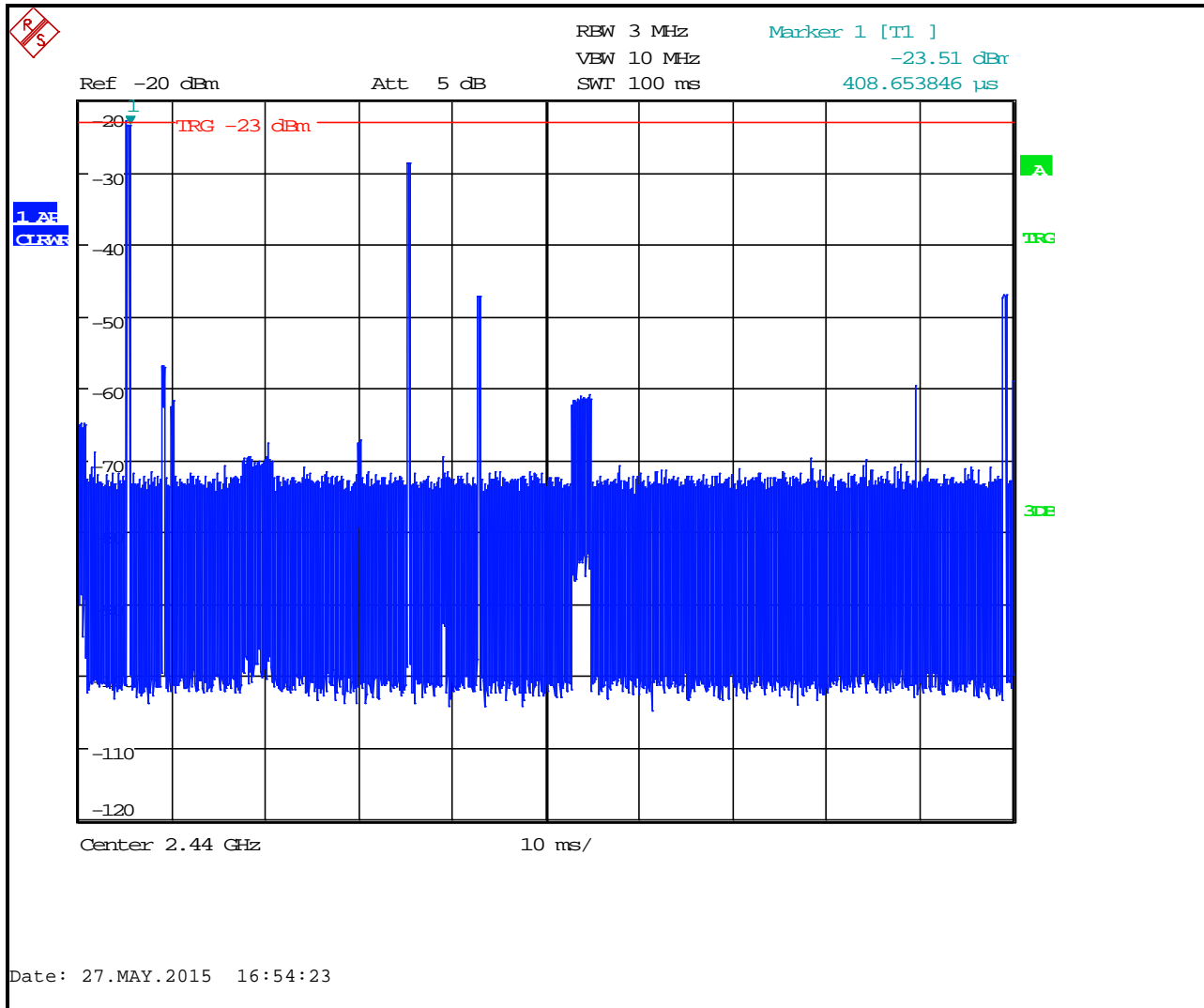

**Duty Cycle Calculation:**

**20 Log (0.417/100) = -47.6 dB correction**

**Table 4-1: Duty Cycle Test Equipment**

RTL Asset #	Manufacturer	Model	Part Type	Serial Number	Calibration Due Date
901581	Rohde & Schwarz	FSU	Spectrum Analyzer	1166.1660.50	11/13/15

**Test Personnel:**

Daniel W. Baltzell EMC Test Engineer	 Signature	May 27, 2015 Date of Test
---	--	------------------------------

**5 Antenna Conducted Spurious Emissions – FCC 15.247(d), RSS-247 5.5**

Procedure: C63.10-2013 6.7

No conducted antenna port is available so no conducted data is reported.

**Test Personnel:**

Daniel W. Baltzell EMC Test Engineer	 Signature	February 24, 2015 Date of Test
---	---	-----------------------------------

**6 Band-Edge Compliance of RF Conducted Emissions – FCC 15.247(d), RSS-247 5.5**

**6.1 Band Edge Test Procedure**

Procedure: C63.10-2013 6.10

The EUT was connected to the spectrum analyzer through suitable attenuation. The span was set wide enough to capture the peak level of the emission operating on the channel closest to the band edge, as well as any modulation products which fall outside of the authorized band of operation. The spectrum analyzer was set to the following:

- RBW > = 1 % of span
- VBW > = RBW
- Sweep = auto
- Detector function = peak
- Trace = max hold

The trace was allowed to stabilize. The marker was set on the emission at the band edge. The marker-delta was used to show the delta between the maximum in-band emission and the emission at the band edge, and was compared to the 20 dBc requirement of 15.247(d) (when using peak emissions). This measurement was taken in both fixed frequency and hopping modes.

## 6.2 Test Results

Plot 6-1: Lower Band Edge TX Frequency - 2402 MHz

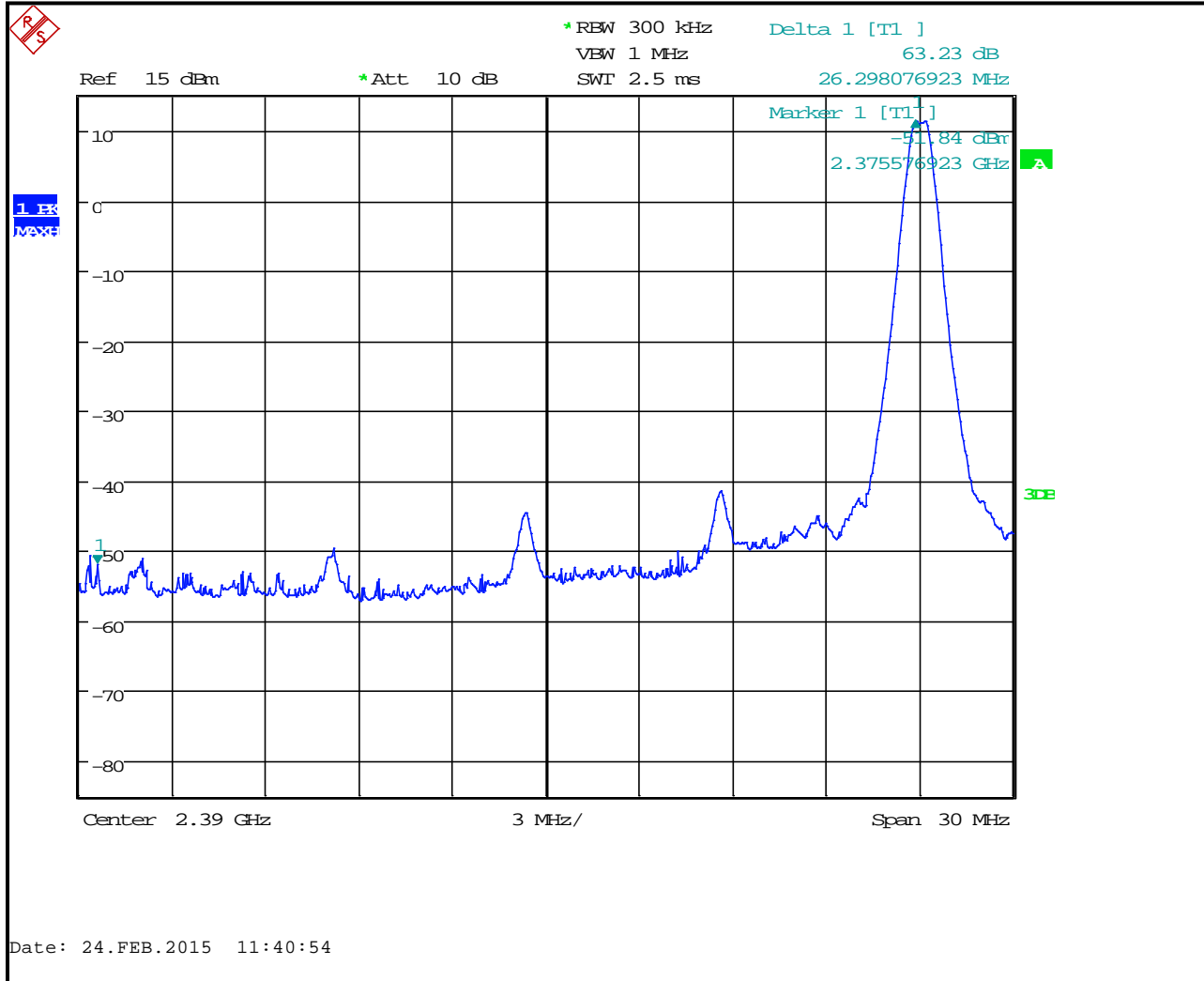

### Plot 6-2: Lower Band Edge TX Frequency - 2402 MHz (Hopping)

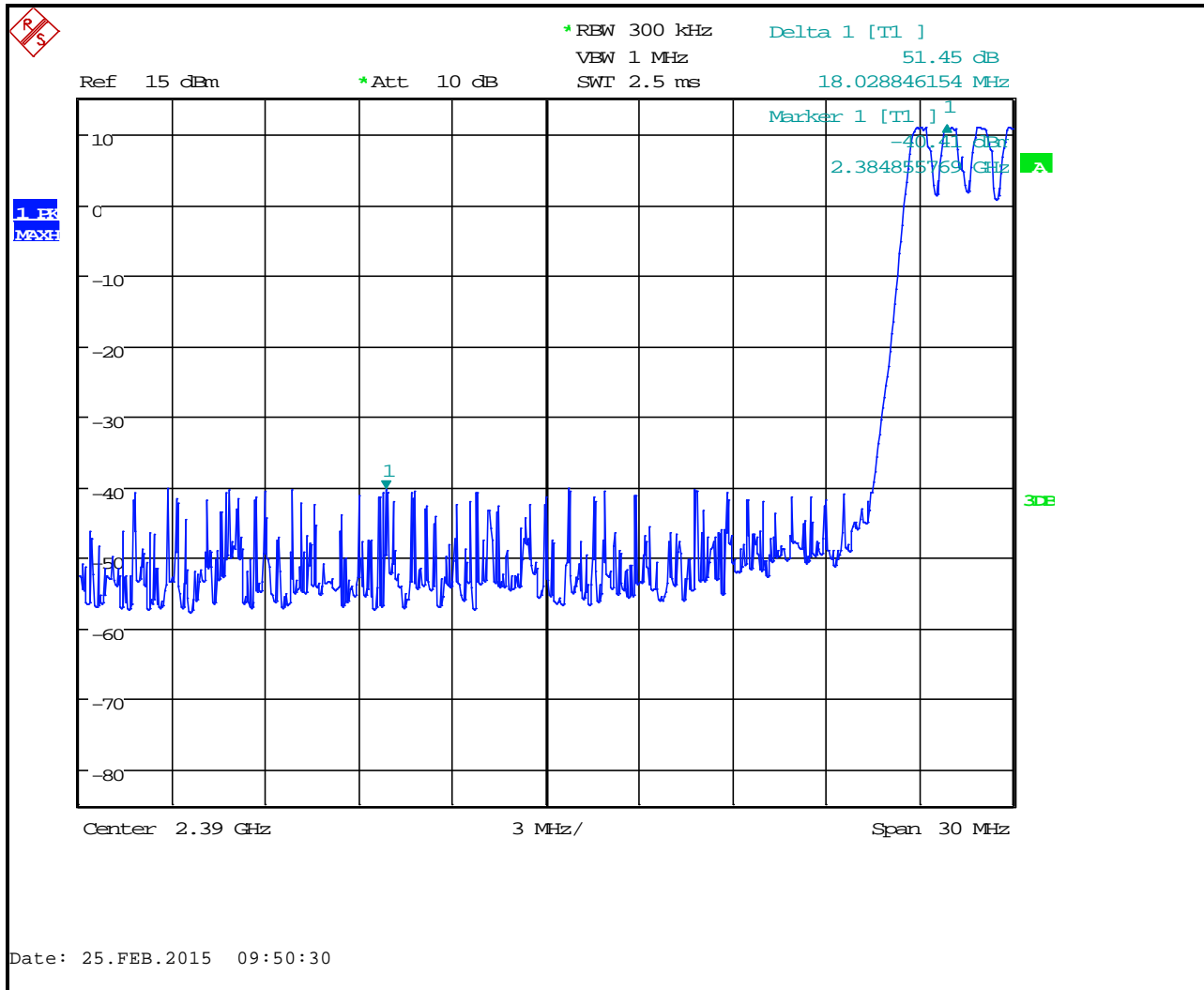

**Plot 6-3: Upper Band Edge TX Frequency - 2480 MHz**

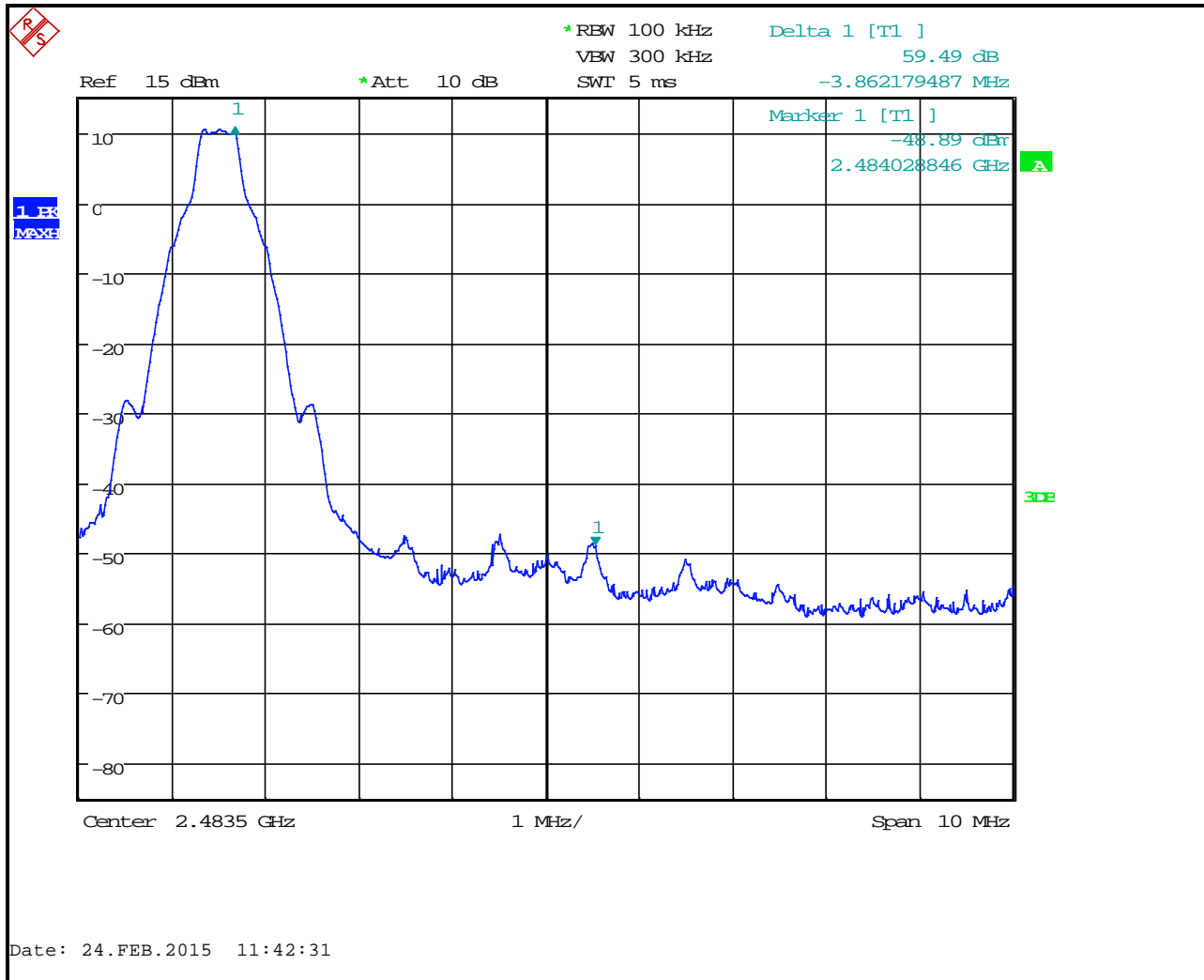

**Plot 6-4: Upper Band Edge TX Frequency - 2480 MHz (Hopping)**

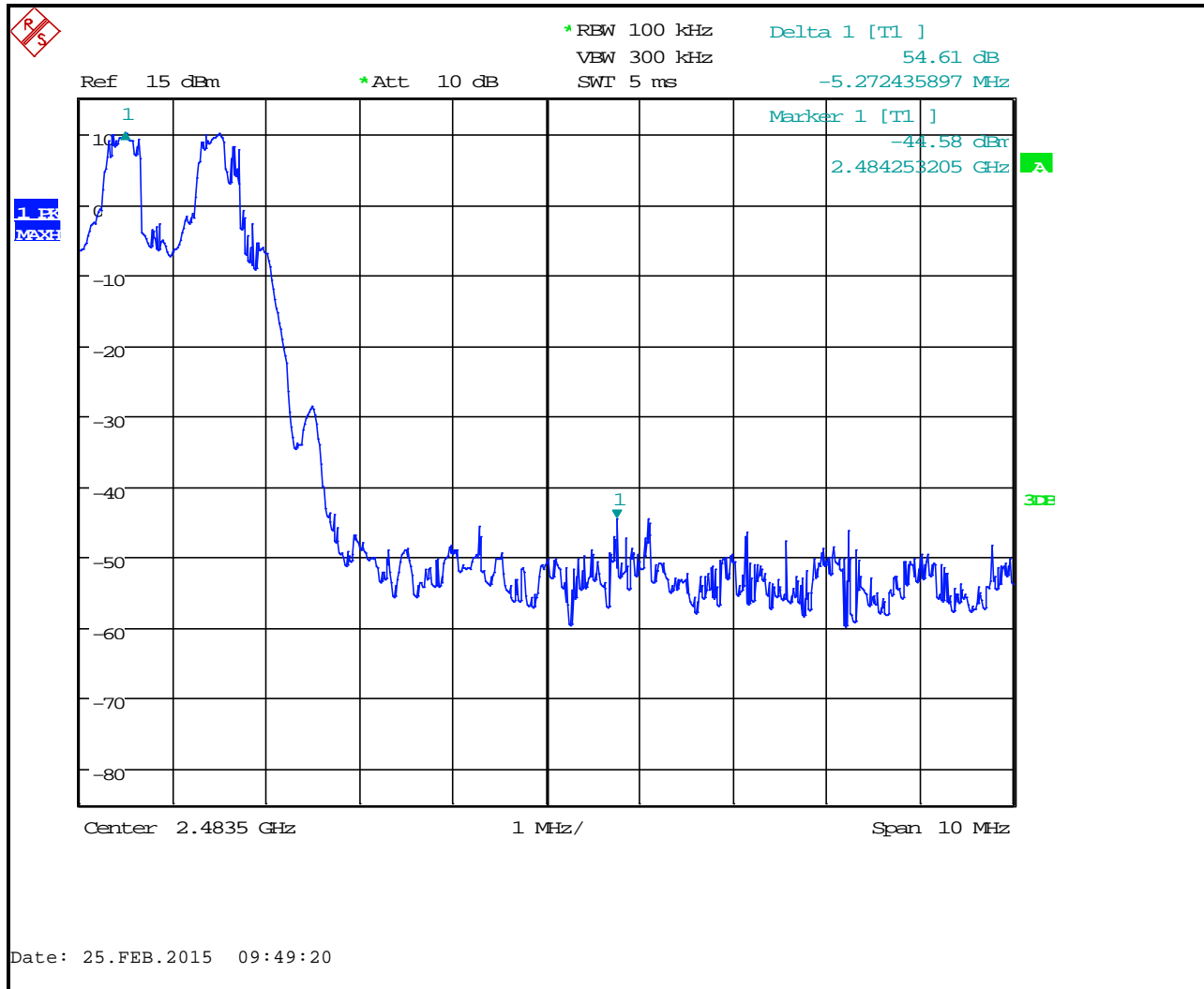

**Table 6-1: Band-Edge Compliance of RF Conducted Emissions Test Equipment**

RTL Asset #	Manufacturer	Model	Part Type	Serial Number	Calibration Due Date
901581	Rohde & Schwarz	FSU	Spectrum Analyzer	1166.1660.50	11/13/15

**Test Personnel:**

Daniel W. Baltzell EMC Test Engineer	 Signature	February 24 & 25, 2015 Dates of Test
---	--	---

### 6.3 Radiated Band Edge Emissions

**Table 6-2: Radiated Band Edge Emissions Test Data**

Frequency (MHz)	Peak Spectrum Analyzer Level (1 MHz RBW/ 3 MHz VBW) (dBuV)	Average Analyzer Detector (1 MHz RBW/ 3 MHz VBW) (dBuV)	Site Correction Factor (dB/m) with duty cycle correction -47.6 dB	Corrected Average Level (dBuV/m)	Delta Measurement from Plots (dB)	Average Limit (dBuV/m)	Margin (dB)
2402.0	56.6	56.2	-16.6	39.6	51.5	54.0	-65.9
2480.0	59.8	59.7	-15.4	44.3	54.6	54.0	-64.3

**Table 6-3: Radiated Band Edge Test Equipment**

RTL Asset #	Manufacturer	Model	Part Type	Serial Number	Calibration Due Date
901592	Insulated Wire Inc.	KPS-1503-3600-KPR	SMK RF Cables 20'	NA	9/3/15
901581	Rohde & Schwarz	FSU	Spectrum Analyzer	1166.1660.50	11/13/15
900772	EMCO	3161-02	Horn Antenna (2 - 4 GHz)	9804-1044	4/09/18
900886	EMI Shop	WRT000-0003	Turntable OATS	N/A	Not Required

**Test Personnel:**

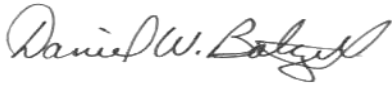
Daniel W. Baltzell EMC Test Engineer	 Signature	February 24-April 4, 2015 Dates of Test
---	--	--



**7 20 dB Bandwidth – FCC 15.247(a)(1), RSS-247 5.1(a)**

**7.1 20 dB Bandwidth Test Procedure**

Procedure: C63.10-2013 6.9

**7.2 20 dB Modulated Bandwidth Test Data**

**Table 7-1: 20 dB Modulated Bandwidth Test Data**

<b>Frequency (MHz)</b>	<b>20 dB Bandwidth (MHz)</b>
2402	1.46
2441	1.46
2480	1.46

### 7.3 20 dB Bandwidth Plots

Plot 7-1: 20 dB Bandwidth - 2402 MHz; GFSK

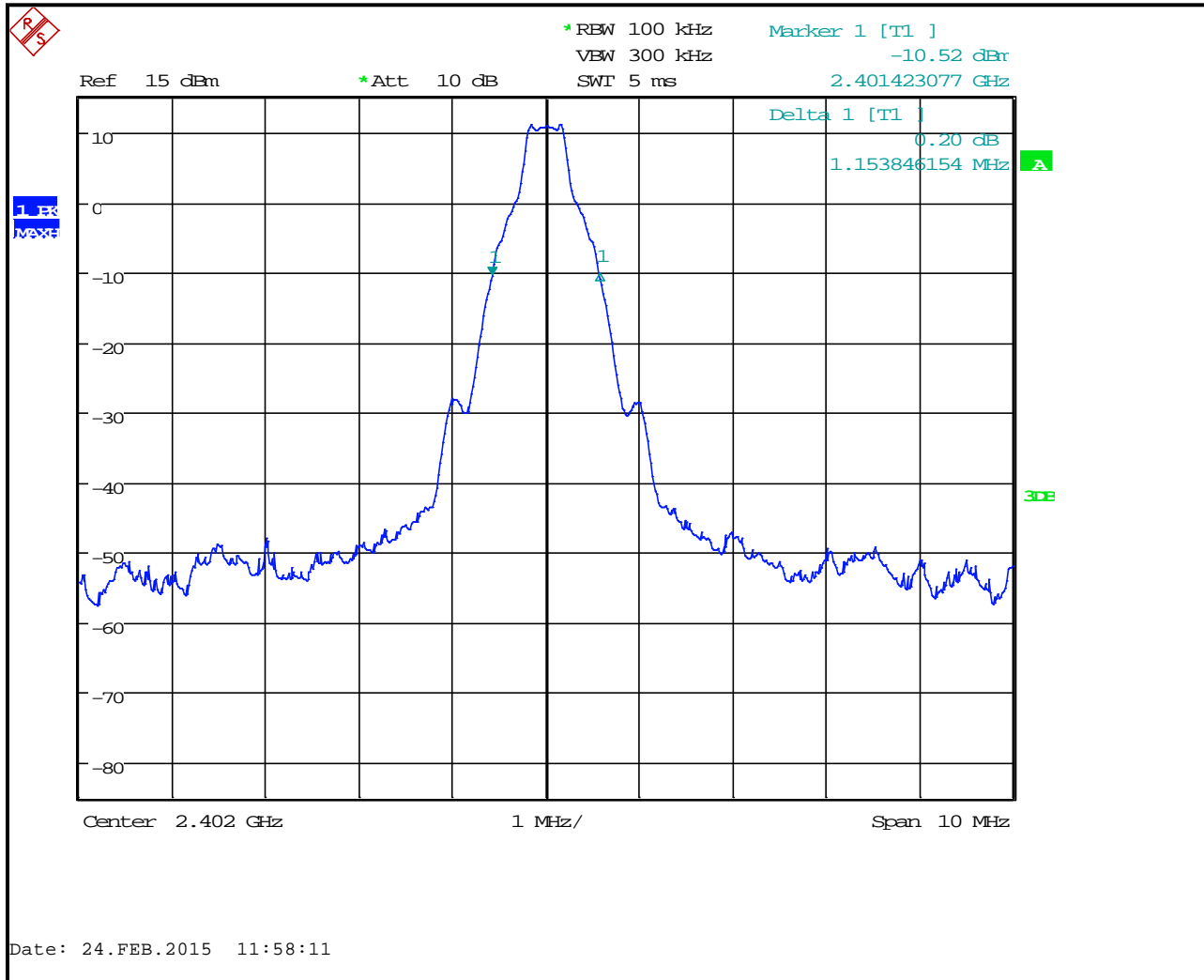

**Plot 7-2: 20 dB Bandwidth - 2402 MHz; 2-EDR**

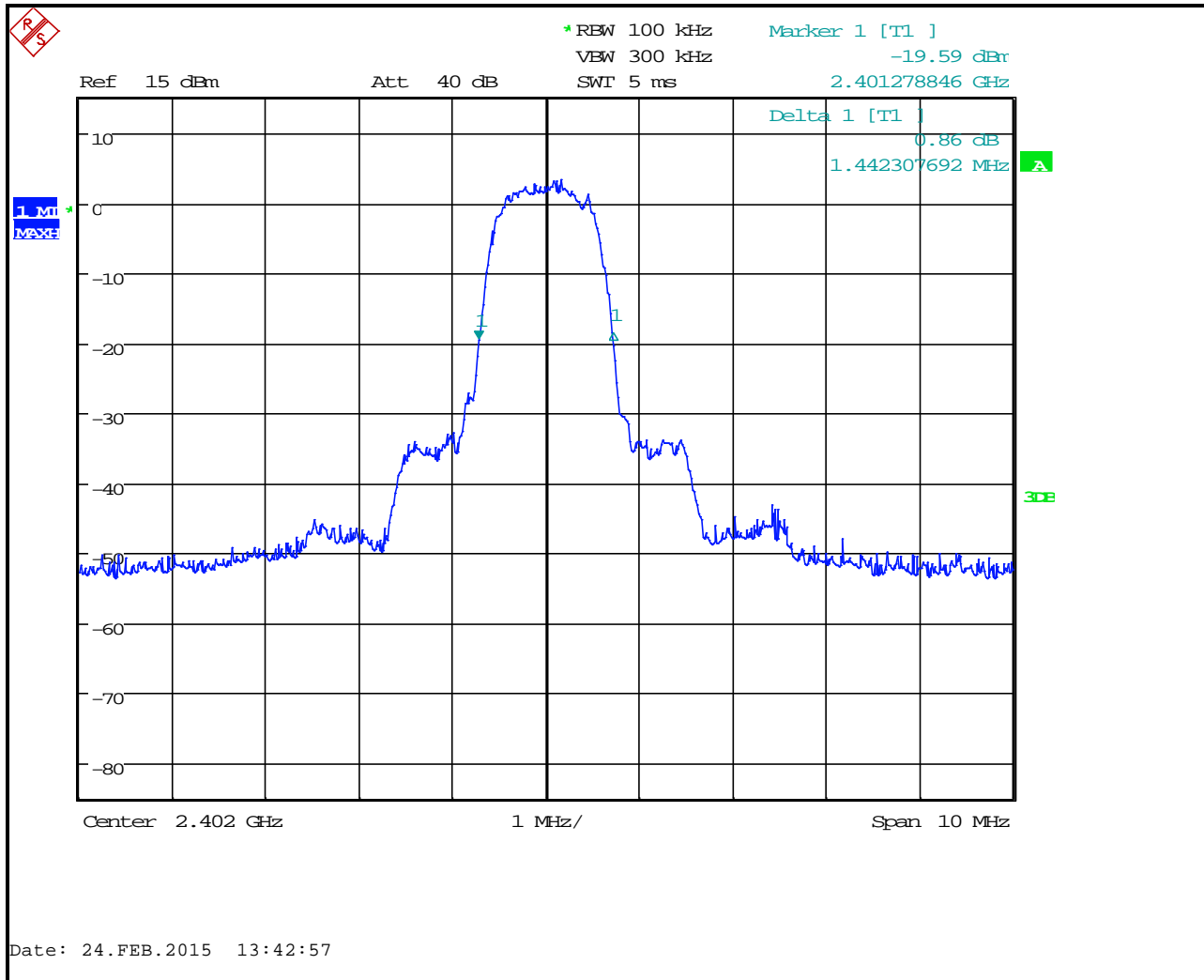

**Plot 7-3: 20 dB Bandwidth - 2402 MHz; 3-EDR**

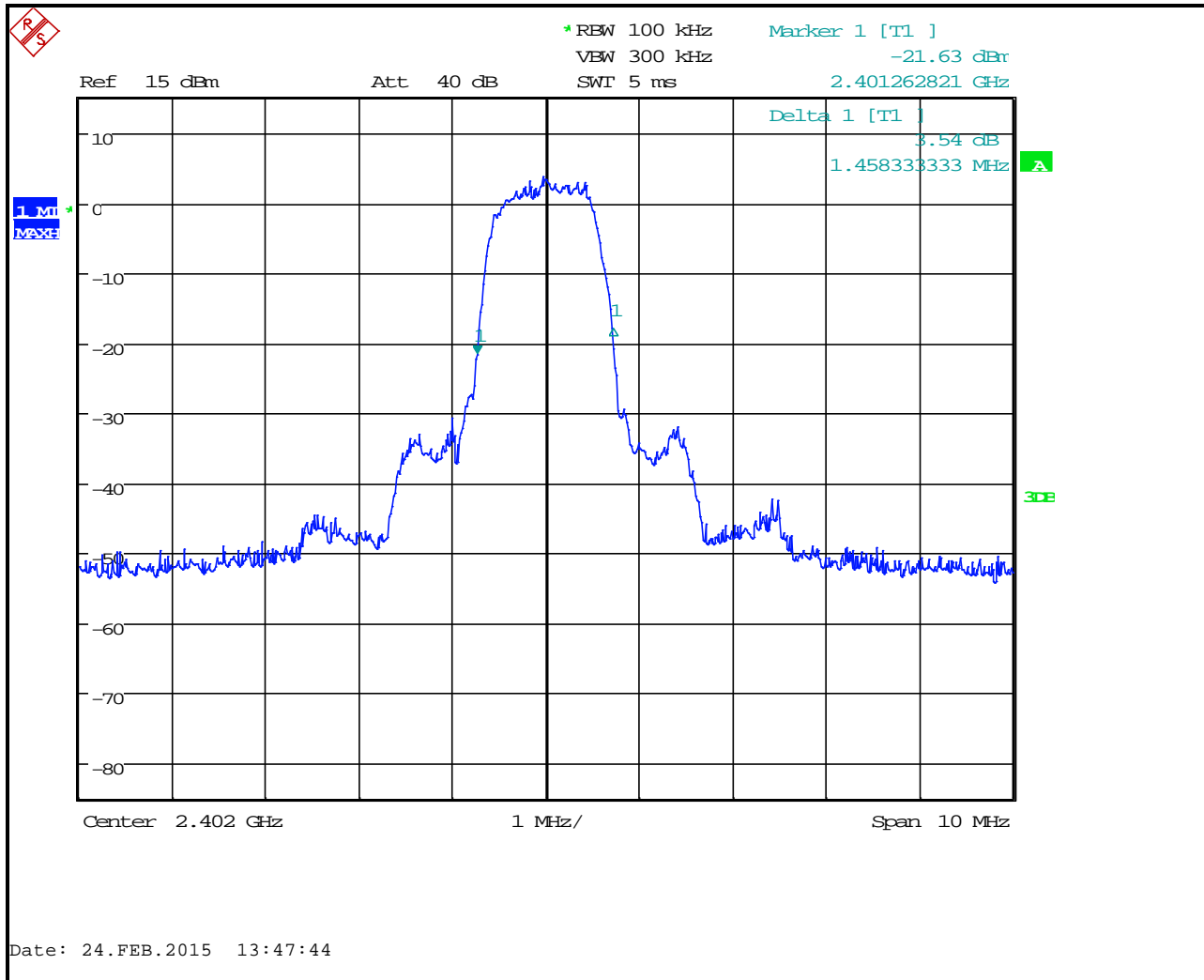

**Plot 7-4: 20 dB Bandwidth - 2441 MHz; GFSK**

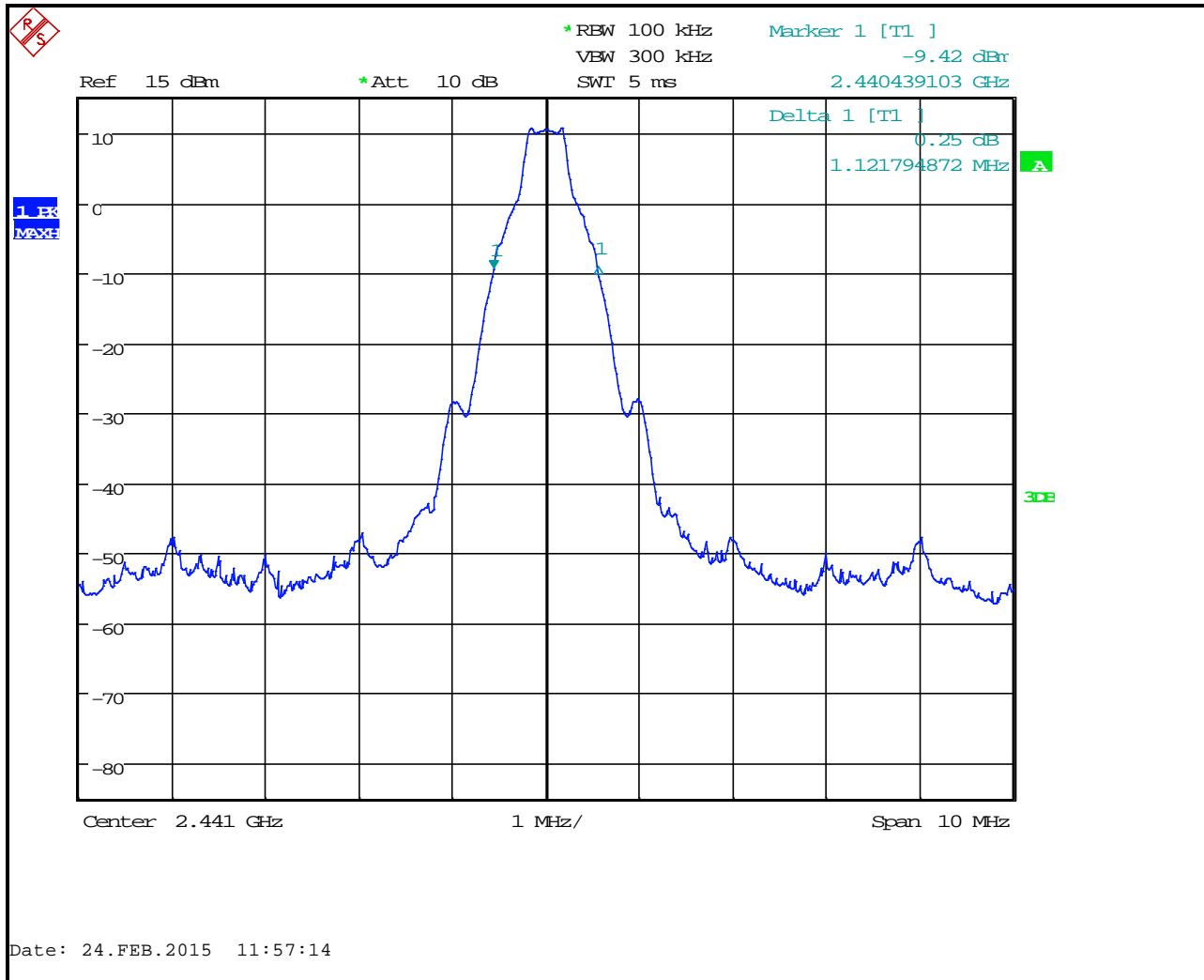

**Plot 7-5: 20 dB Bandwidth - 2441 MHz; 2-EDR**

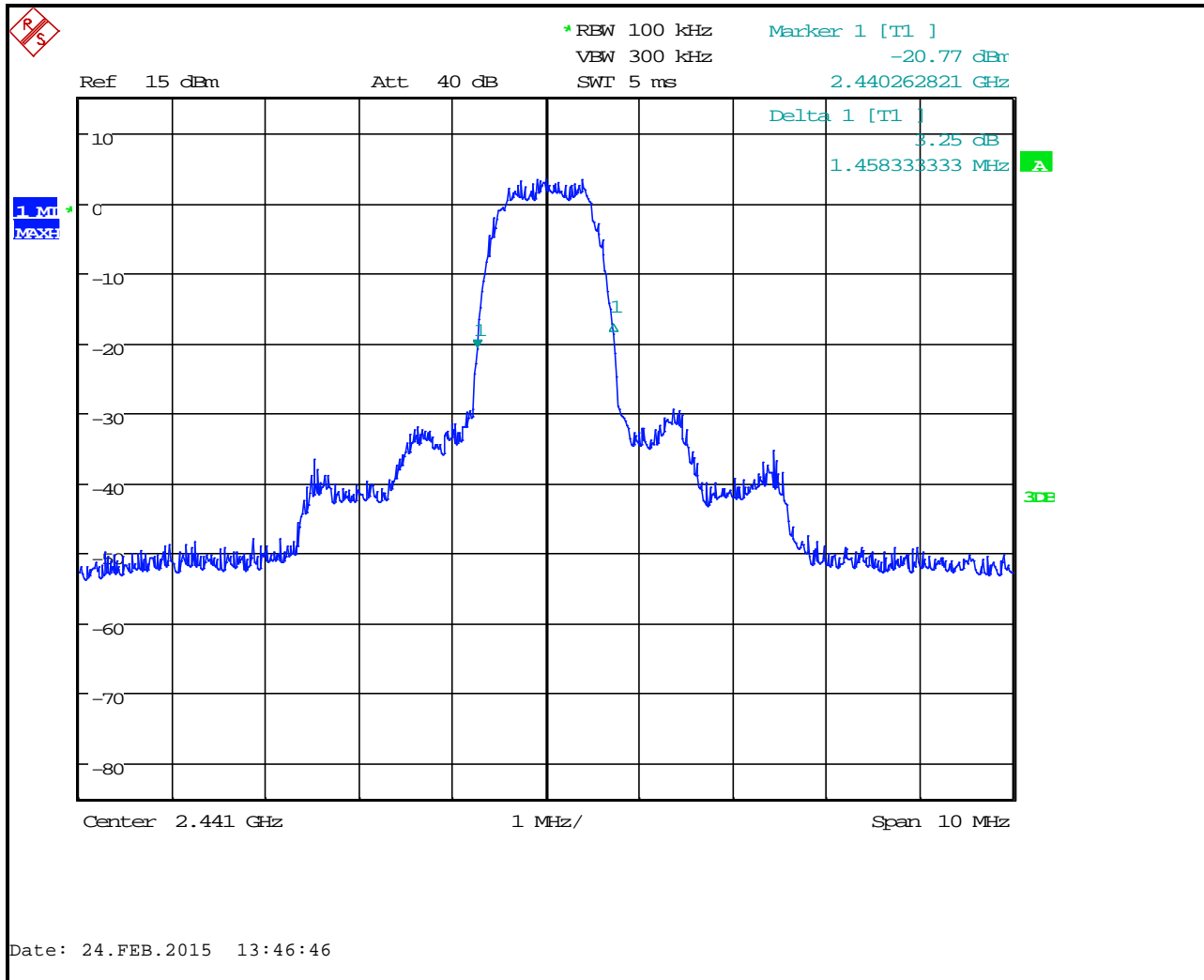

**Plot 7-6: 20 dB Bandwidth - 2441 MHz; 3-EDR**

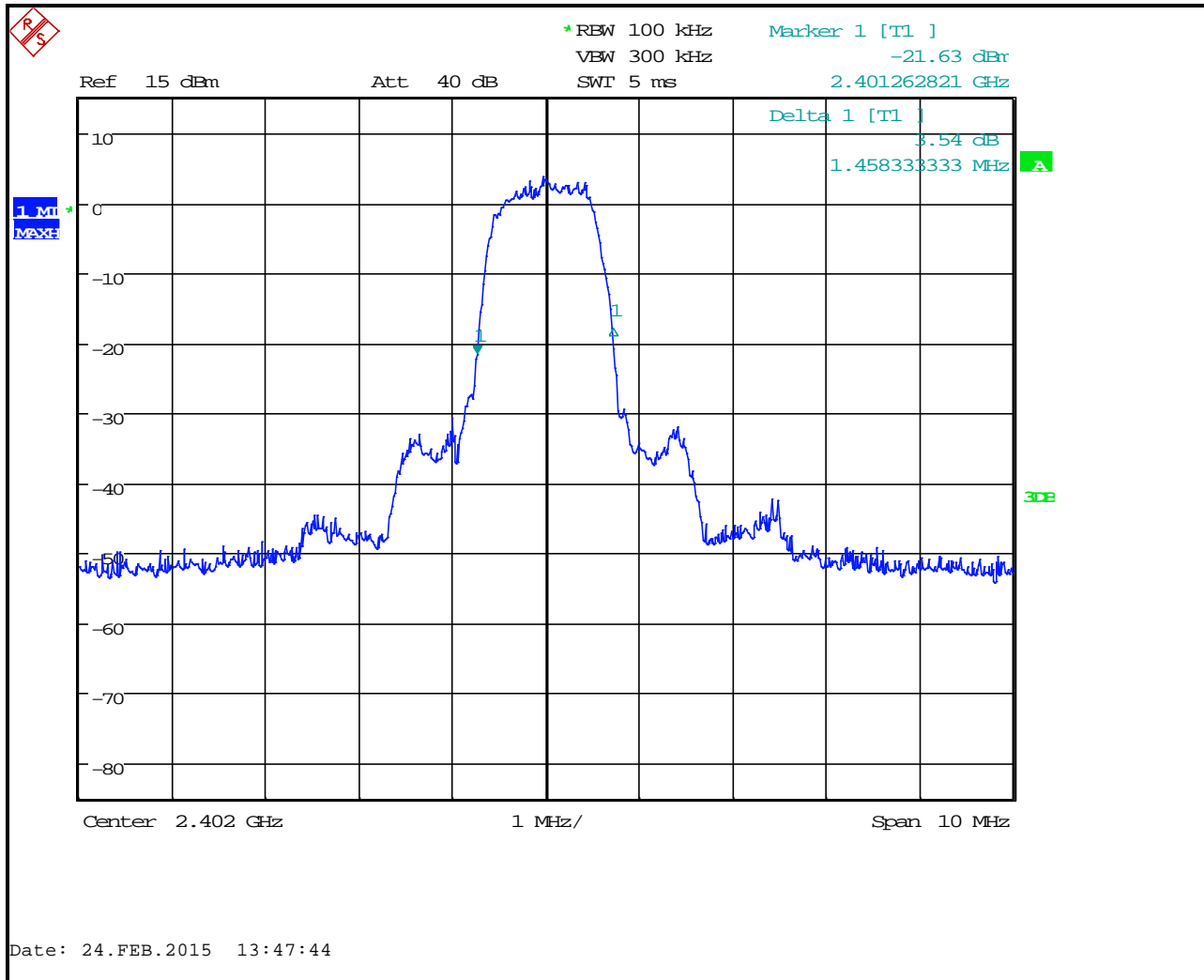

**Plot 7-7: 20 dB Bandwidth - 2480 MHz; GFSK**

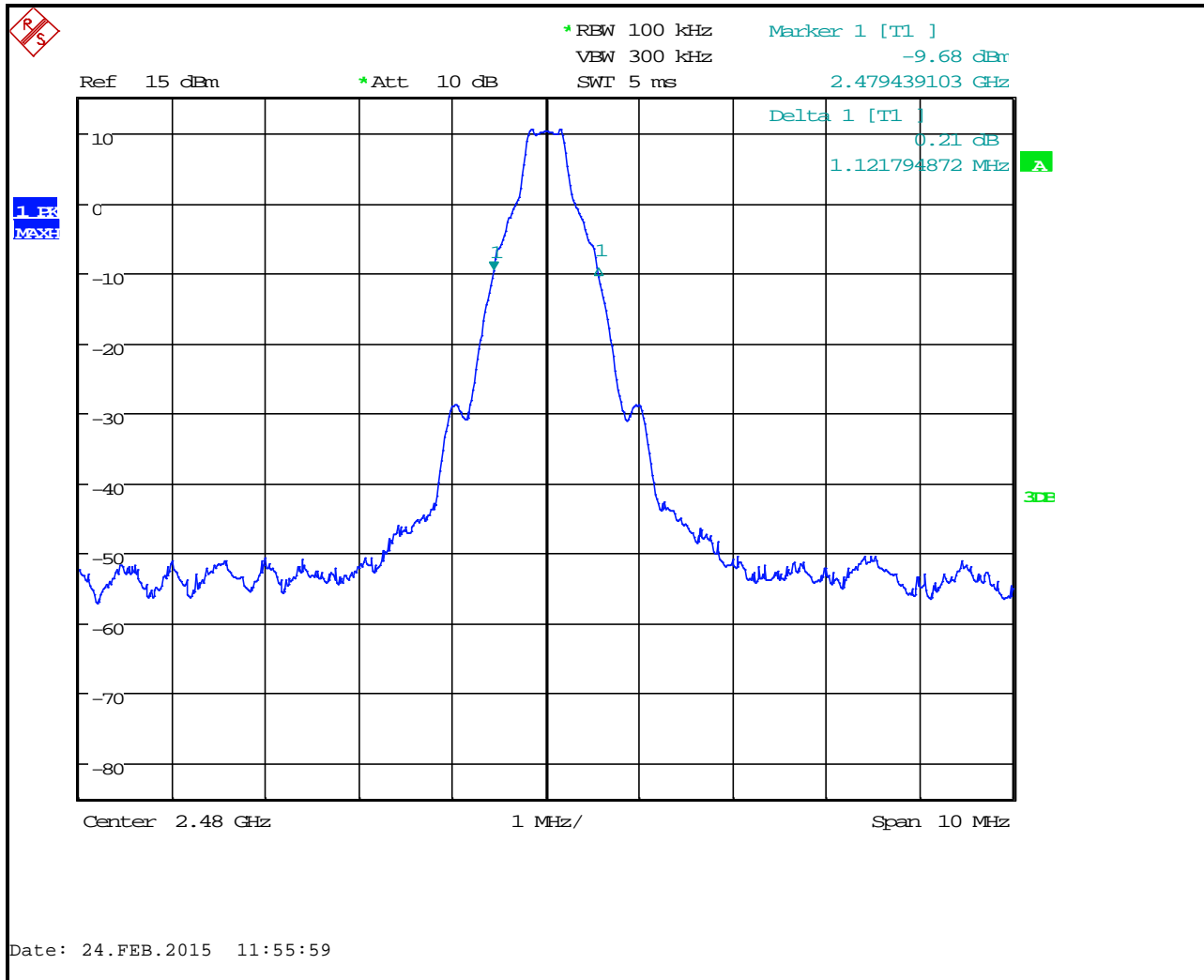



**Plot 7-8: 20 dB Bandwidth - 2480 MHz; 2-EDR**

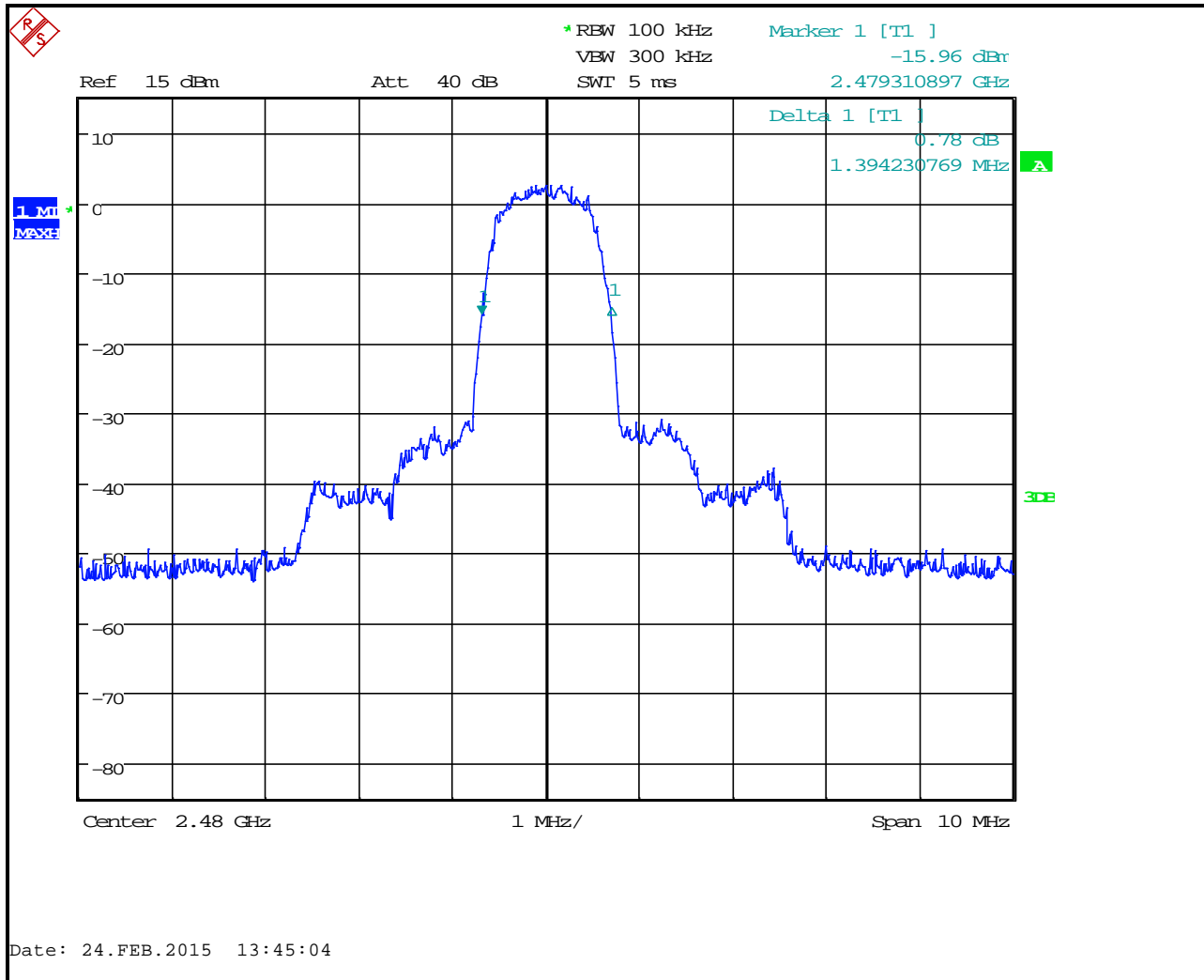

**Plot 7-9: 20 dB Bandwidth - 2480 MHz; 3-EDR**

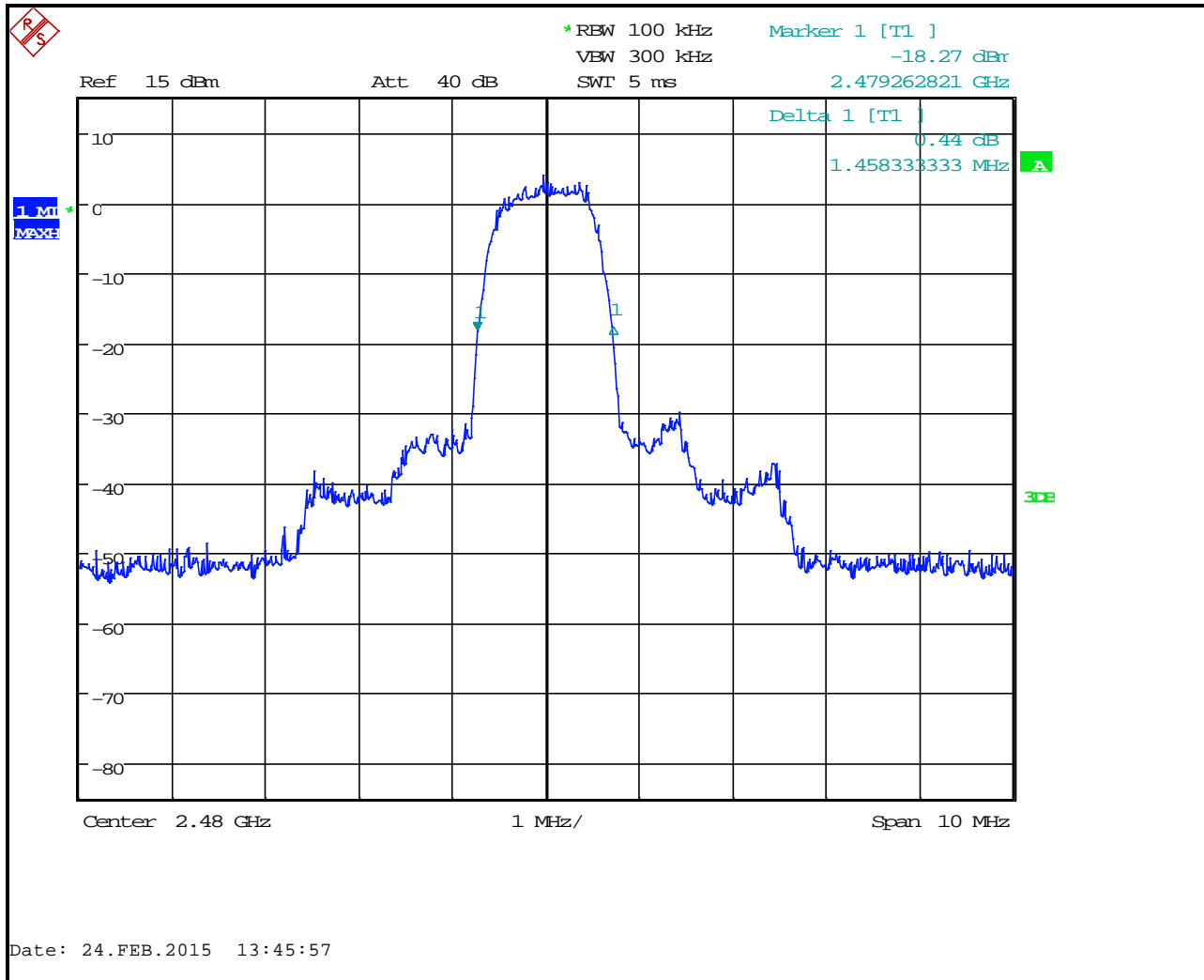

**Table 7-2: 20 dB Bandwidth Test Equipment**

RTL Asset #	Manufacturer	Model	Part Type	Serial Number	Calibration Due Date
901581	Rohde & Schwarz	FSU	Spectrum Analyzer	1166.1660.50	11/13/15

**Test Personnel:**

Daniel W. Baltzell		February 24, 2015
EMC Test Engineer	Signature	Date of Test

**8 Carrier Frequency Separation - 15.247(a)(1), RSS-247 5.1(b)**

**8.1 Carrier Frequency Separation Test Procedure**

Procedure: C63.10-2013 7.8.2

Frequency hopping systems shall have hopping channel carrier frequencies separated by a minimum of 25 kHz, or the 20 dB bandwidth of the hopping channel, whichever is greater. Alternatively, frequency hopping systems operating in the 2400–2483.5 MHz band may have hopping channel carrier frequencies that are separated by 25 kHz or two-thirds of the 20 dB bandwidth of greater, provided the systems operate with an output power no greater than 125 mW.

Measured frequency separation = 1.0 MHz

## 8.2 Carrier Frequency Separation Test Data

Plot 8-1: Carrier Frequency Separation

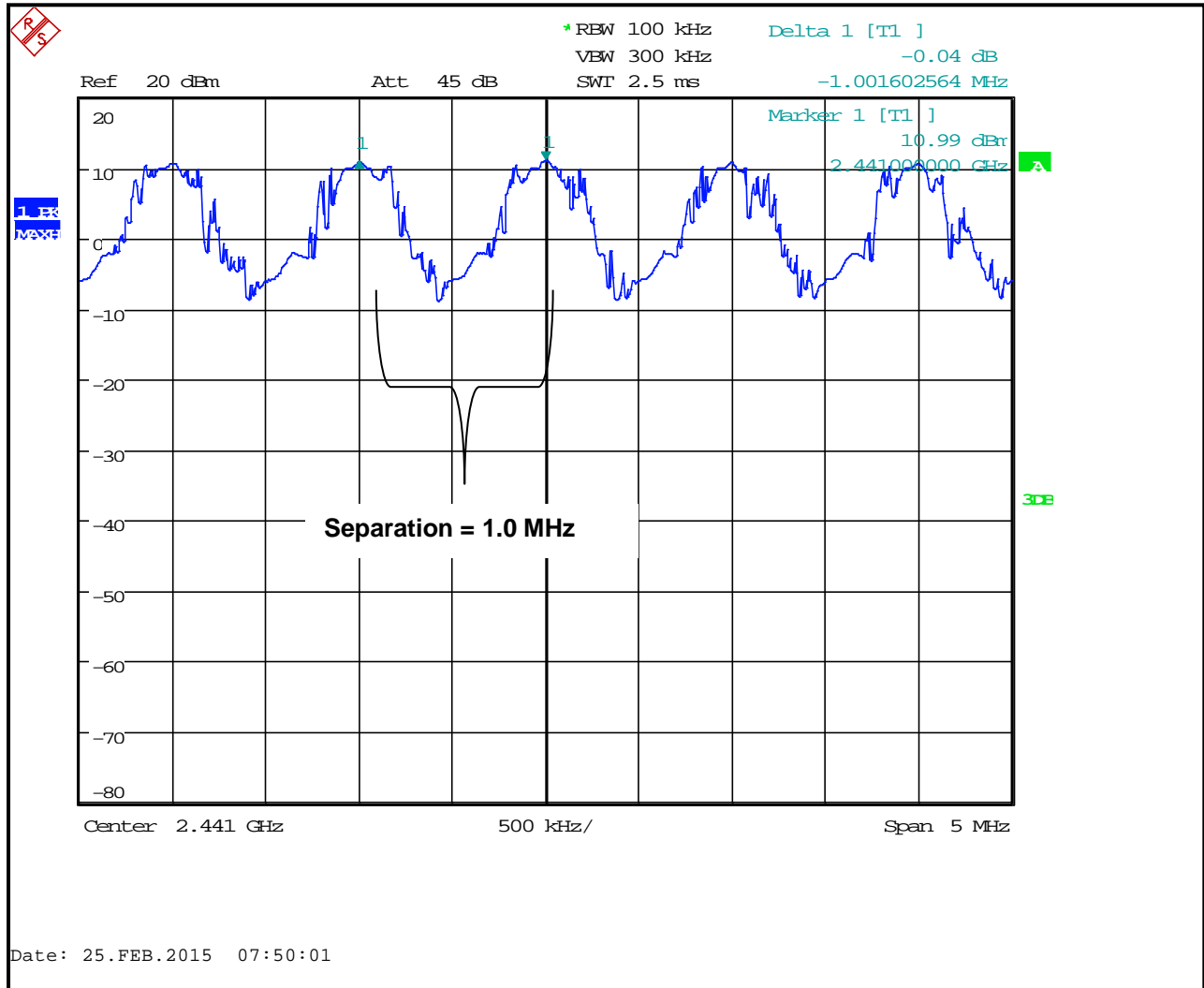

## 9 Hopping Characteristics – FCC 15.247(a)(1)(iii), RSS-247 5.1(d)

### 9.1 Hopping Characteristics Test Procedure

Procedure: C63.10-2013 7.8.3

Frequency hopping systems in the 2400–2483.5 MHz band shall use at least 15 channels. The average time of occupancy on any channel shall not be greater than 0.4 seconds within a period of 0.4 seconds multiplied by the number of hopping channels employed. Frequency hopping systems may avoid or suppress transmissions on a particular hopping frequency provided that a minimum of 15 channels are used.

### 9.2 Number of Hopping Frequencies

Measured number of hopping frequencies = 79

Plot 9-1: Number of Hopping Frequencies (2402 - 2480 MHz)

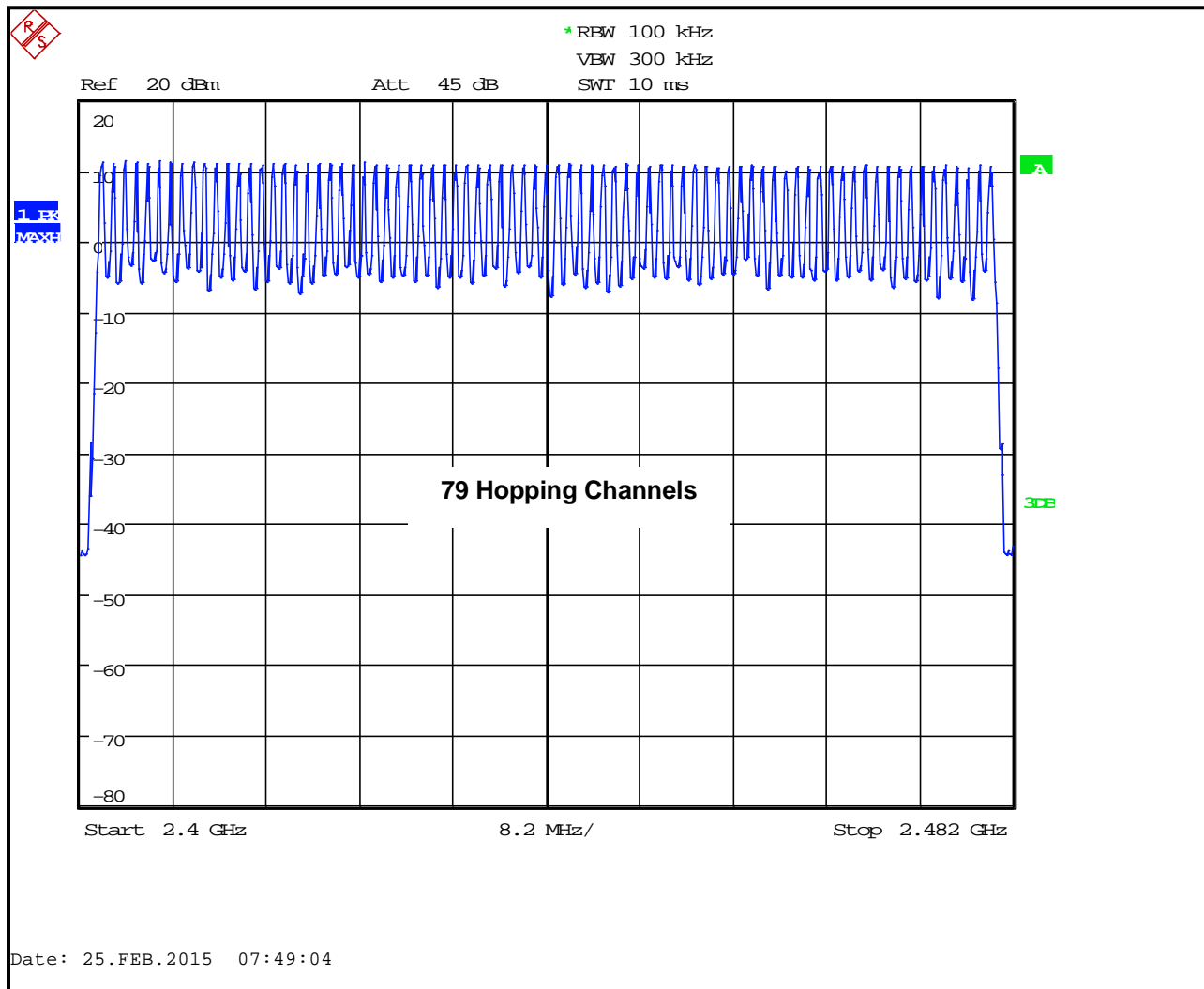

### 9.3 Average Time of Occupancy

Procedure: C63.10-2013 7.8.4

The average time of occupancy on any channel shall not be greater than 0.4 seconds within a period of 0.4 seconds multiplied by the number of hopping channels employed.

Allowed period = 0.4 s X 79 channels = 31.6 s

Pulse width = 0.405 ms

Number of pulses within a 31.6 s sweep = 32 x 10 = 320

Average time of occupancy in 31.6 s = 0.405 ms X 320 pulses = 0.13 s, which meets the limit of 0.4 s

**Plot 9-2: Time of Occupancy (Dwell Time)**

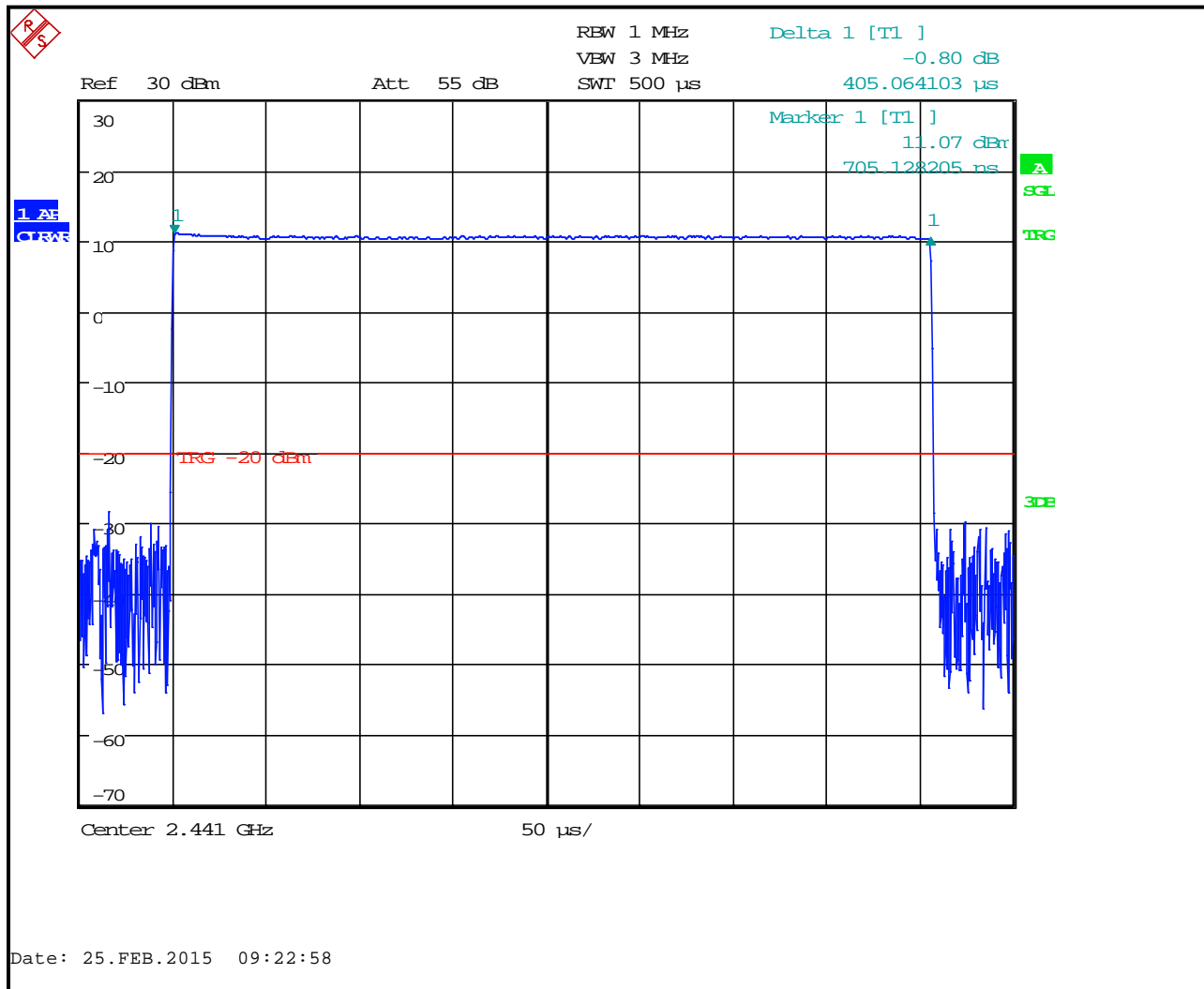

Date: 25.FEB.2015 09:22:58

**Plot 9-3: Number of Pulses in 3.16 Second Sweep**

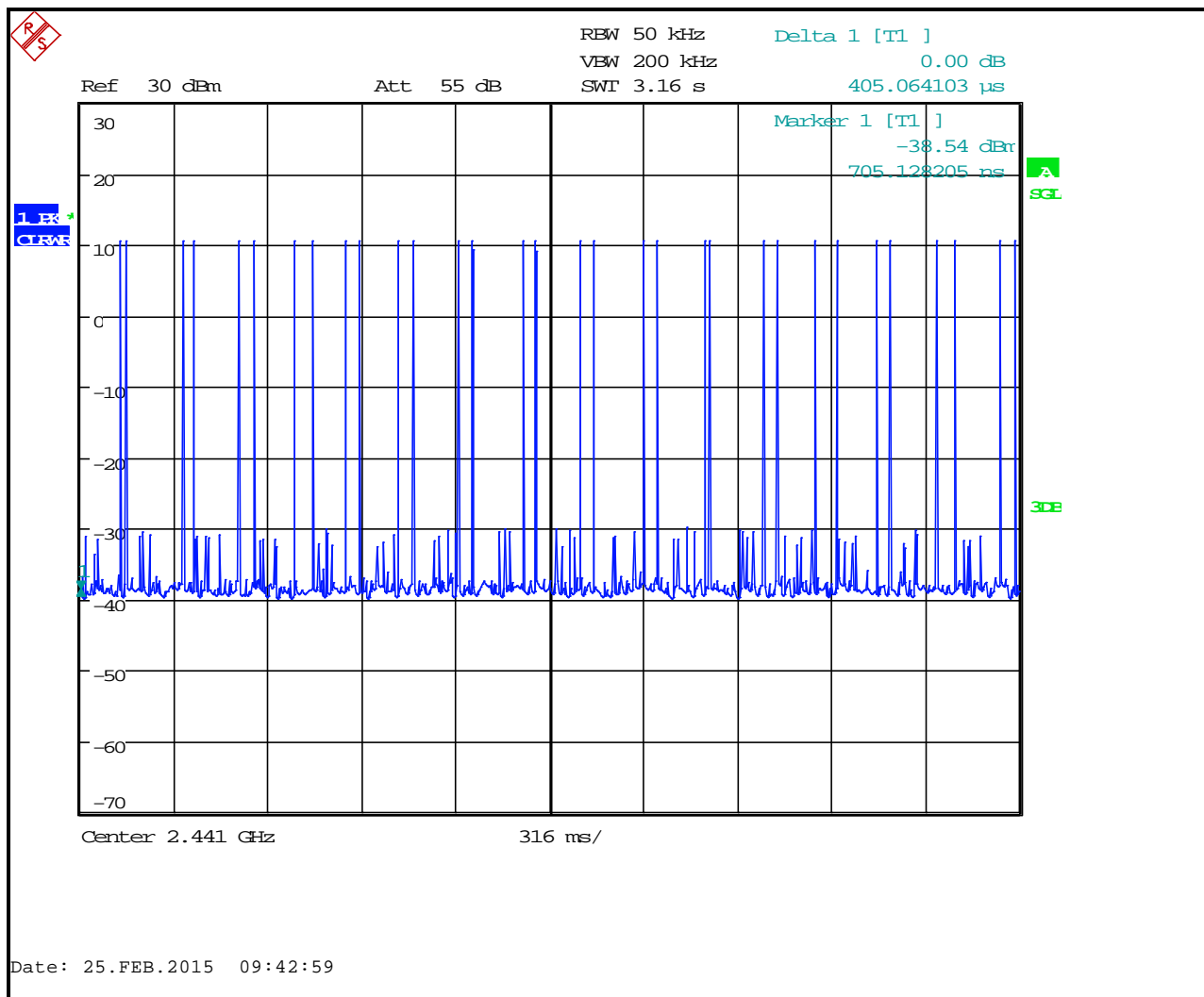

**Table 9-1: Hopping Characteristics Test Equipment**

RTL Asset #	Manufacturer	Model	Part Type	Serial Number	Calibration Due Date
901581	Rohde & Schwarz	FSU	Spectrum Analyzer	1166.1660.50	11/13/15

**Test Personnel:**

Daniel W. Baltzell EMC Test Engineer	 Signature	February 25, 2015 Date of Test
---	--	-----------------------------------

## 10 Radiated Emissions Test Results - FCC Rules and Regulations Part 15.247(d), RSS-247 5.5

### 10.1 Limits of Radiated Emissions Measurement

Frequency (MHz)	Field Strength (uV/m)	Measurement Distance (m)
0.009-0.490	2400/f (kHz)	300
0.490-1.705	2400/f (kHz)	30
1.705-30.0	30	30
30-88	100	3
88-216	150	3
216-960	200	3
Above 960	500	3

As shown in 15.35(b), for frequencies above 1000 MHz, the field strength limits are based on average detector, however, the peak field strength of any emission shall not exceed the maximum permitted average limits, specified above by more than 20 dB under any circumstances of modulation.

### 10.2 Radiated Emissions Measurement Test Procedure

Before final measurements of radiated emissions were made on the open-field three/ten meter range, the EUT was scanned indoors at one and three meter distances. This was done in order to determine its emissions spectrum signature. The physical arrangement of the test system and associated cabling was varied in order to determine the effect on the EUT's emissions in amplitude, direction and frequency. This process was repeated during final radiated emissions measurements on the open-field range, at each frequency, in order to ensure that maximum emission amplitudes were attained.

Final radiated emissions measurements were made on the three/ten-meter, open-field test site. The EUT was placed on a nonconductive turntable 0.8 meters above the ground plane. The spectrum was examined from 9 kHz to the 10<sup>th</sup> harmonic of the highest fundamental transmitter frequency.

At each frequency, the EUT was rotated 360°, and the antenna was raised and lowered from 1 to 4 meters in order to determine the emission's maximum level. Measurements were taken using both horizontal and vertical antenna polarizations. For frequencies between 30 and 1000 MHz, the spectrum analyzer's 6 dB bandwidth was set to 120 kHz, and the analyzer was operated in the CISPR quasi-peak detection mode. For emissions above 1000 MHz, emissions are measured using the average detector function with a minimum resolution bandwidth of 1 MHz. No video filter less than 10 times the resolution bandwidth was used. The highest emission amplitudes relative to the appropriate limit were measured and recorded in this report.



### 10.2.1 Radiated Emissions Harmonics/Spurious Test Data

**Table 10-1: Radiated Emissions Harmonics/Spurious - 2402 MHz - Average**

Emission Frequency (MHz)	Calculated Average (dBuV) Peak – 47.6 duty cycle correction	Site Correction Factor (dB/m)	Average Emission Level (dBuV/m)	Average Limit (dBuV/m)	Average Margin (dB)
4804.0	-24.4	38.5	14.1	54.0	-39.9
12012.0	-33.7	49.0	15.3	54.0	-38.7
19218.0	-34.0	48.5	14.5	54.0	-39.5

**Table 10-2: Radiated Emissions Harmonics/Spurious - 2402 MHz - Peak**

Emission Frequency (MHz)	Peak Analyzer Reading (dBuV) (1 MHz RBW/VBW)	Site Correction Factor (dB/m)	Peak Emission Level (dBuV/m)	Peak Limit (dBuV/m)	Peak Margin (dB)
4804.0	23.2	38.5	61.7	74.0	-12.3
12012.0	13.9	49.0	62.9	74.0	-11.1
19218.0	13.6	48.5	62.1	74.0	-11.9

**Table 10-3: Radiated Emissions Harmonics/Spurious - 2441 MHz - Average**

Emission Frequency (MHz)	Calculated Average (dBuV) Peak – 47.6 duty cycle correction	Site Correction Factor (dB/m)	Average Emission Level (dBuV/m)	Average Limit (dBuV/m)	Average Margin (dB)
4882.0	-28.5	38.7	10.2	54.0	-43.8
7323.0	-34.7	44.0	9.3	54.0	-44.7
12205.0	-34.8	48.8	14.0	54.0	-40.0
19528.0	-34.5	47.7	13.2	54.0	-40.8

**Table 10-4: Radiated Emissions Harmonics/Spurious – 2441 MHz - Peak**

Emission Frequency (MHz)	Peak Analyzer Reading (dBuV) (1 MHz RBW/VBW)	Site Correction Factor (dB/m) – 47.6 duty cycle correction	Peak Emission Level (dBuV/m)	Peak Limit (dBuV/m)	Peak Margin (dB)
4882.0	19.1	38.7	57.8	74.0	-16.2
7323.0	12.9	44.0	56.9	74.0	-17.1
12205.0	12.8	48.8	61.6	74.0	-12.4
19528.0	13.1	47.7	60.8	74.0	-13.2

**Table 10-5: Radiated Emissions Harmonics/Spurious - 2480 MHz - Average**

Emission Frequency (MHz)	Calculated Average (dBuV) Peak – 47.6 duty cycle correction	Site Correction Factor (dB/m)	Average Emission Level (dBuV/m)	Average Limit (dBuV/m)	Average Margin (dB)
4960.0	-28.4	38.9	10.5	54.0	-43.5
7440.1	-34.4	44.1	9.7	54.0	-44.3
12400.0	-34.7	48.7	14.0	54.0	-40.0
19840.0	-34.0	49.0	15.0	54.0	-39.0
22320.0	-33.6	51.0	17.4	54.0	-36.6

**Table 10-6: Radiated Emissions Harmonics/Spurious – 2480 MHz - Peak**

Emission Frequency (MHz)	Peak Analyzer Reading (dBuV) (1 MHz RBW/VBW)	Site Correction Factor (dB/m) – 47.6 duty cycle correction	Peak Emission Level (dBuV/m)	Peak Limit (dBuV/m)	Peak Margin (dB)
4960.0	19.2	38.9	58.1	74.0	-15.9
7440.1	13.2	44.1	57.3	74.0	-16.7
12400.0	12.9	48.7	61.6	74.0	-12.4
19840.0	13.6	49.0	62.6	74.0	-11.4
22320.0	14.0	51.0	65.0	74.0	-9.0

**Table 10-7: Radiated Emissions Harmonics/Spurious – Hopping Mode**

<b>Emission Frequency (MHz)</b>	<b>Peak Analyzer Level (dBuV) (1 MHz RBW/VBW)</b>	<b>Average Analyzer Reading (dBuV) Peak – 47.6 duty cycle correction</b>	<b>Site Correction Factor (dB/m)</b>	<b>Average Emission Level (dBuV/m)</b>	<b>Average Limit (dBuV/m)</b>	<b>Average Margin (dB)</b>
4824.0	23.0	-24.6	28.5	3.9	54.0	-50.1
4826.0	19.2	-28.4	28.5	0.1	54.0	-53.9
4828.0	20.8	-26.8	28.5	1.7	54.0	-52.3
4890.0	19.6	-28.0	29.8	1.8	54.0	-52.2
4892.0	19.2	-28.4	29.8	1.4	54.0	-52.6
4958.0	19.2	-28.4	29.8	1.4	54.0	-52.6

**Table 10-8: Radiated Emissions Test Equipment**

RTL Asset #	Manufacturer	Model	Part Type	Serial Number	Calibration Due Date
900151	Rohde and Schwarz	HFH2-Z2	Loop Antenna (9 kHz - 30 MHz)	827525/019	3/4/16
900932	Hewlett Packard	8449B OPT H02	Preamplifier (1 - 26.5 GHz)	3008A00505	9/5/15
900878	Rhein Tech Laboratories	AM3-1197-0005	3 meter antenna mast, polarizing	OATS1	N/A
901592	Insulated Wire Inc.	KPS-1503-360-KPR	SMK RF Cables 20'	NA	9/3/15
901593	Insulated Wire Inc.	KPS-1503-360-KPR	SMK RF Cables 36"	NA	9/3/15
901594	Insulated Wire Inc.	KPS-1503-360-KPR	SMK RF Cables 36"	NA	9/3/15
901242	Rhein Tech Laboratories	WRT-000-0003	Wood rotating table	N/A	N/A
901581	Rohde & Schwarz	FSU	Spectrum Analyzer	1166.1660.50	11/13/15
900791	Chase	CBL6111B	Bilog Antenna (30 MHz – 2000 MHz)	N/A	6/11/17
900321	EMCO	3161-03	Horn Antennas (4 – 8 GHz)	9508-1020	4/09/18
900323	EMCO	3160-07	Horn Antennas (8.2 – 12 GHz)	9605-1054	4/09/18
900356	EMCO	3160-08	Horn Antennas (12.4 – 18 GHz)	9607-1044	4/09/18
901218	EMCO	3160-09	Horn Antenna (18 - 26 GHz)	960281-003	4/14/18
900772	EMCO	3161-02	Horn Antenna (2 - 4 GHz)	9804-1044	4/09/18

**Test Personnel:**

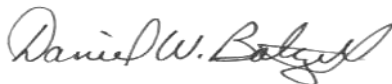
Daniel W. Baltzell EMC Test Engineer	 Signature	April 4, 2015 Date of Test
---	--	-------------------------------

**11 Conclusion**

The data in this measurement report shows that the **Harris Corporation Model XL-185P, FCC ID: OWDTR-0153-E, IC: 3636B-0153**, complies with the applicable requirements of FCC Part 15 and Part 2, and IC RSS-247.