



Engineering Solutions & Electromagnetic Compatibility Services

FCC Part 15.247 & Industry Canada RSS-247 Test Report

Test Lab: Rhein Tech Laboratories, Inc. Tel: 703-689-0368 360 Herndon Parkway Fax: 703-689-2056 Suite 1400 www.rheintech.com Herndon, VA 20170 E-Mail: atcbinfo@rheintech.com		Applicant: Harris Corporation 221 Jefferson Ridge Parkway Lynchburg, VA 24501 Tel: 434-455-9290	
FCC ID/ IC	OWDTR-0147-E 3636B-0147	Test Report Date:	March 1, 2017
Platform	N/A	RTL Work Order #	2017069
Model	XL-185P	RTL Quote #	QRTL17-069B
American National Standard Institute	ANSI C63.10-2013: American National Standard of Procedures for Compliance Testing of Unlicensed Wireless Devices		
FCC Classification	DTS – Part 15 Digital Transmission System		
FCC Rule Part(s)/Guidance	FCC Rules Part 15.247: Operation within the bands 902-928 MHz, 2400-2483.5 MHz and 5725-5850 MHz Direct Sequence System (10/01/2015)		
Industry Canada	RSS-247 Issue 2 Digital Transmission Systems (DTSs), Frequency Hopping Systems (FHSs) and Licence-Exempt Local Area Network (LE-LAN) Devices		
Digital Interface Information	Digital Interface was found to be compliant		
Frequency Range (MHz)	Output Power (W)*	Frequency Tolerance	Emission Designator
2412 – 2462	0.234	N/A	14M7FXD

* power is conducted

I, the undersigned, hereby declare that the equipment tested and referenced in this report conforms to the identified standard(s) as described in this test report. No modifications were made to the equipment during testing in order to achieve compliance with these standards. Furthermore, there was no deviation from, additions to, or exclusions from, the applicable parts of FCC Part 2, FCC Part 15, Industry Canada RSS-247, RSS-Gen, and ANSI C63.10.

Signature: 

Date: March 1, 2017

Typed/Printed Name: Desmond A. Fraser

Position: President

This report may not be reproduced, except in full, without the full written approval of Rhein Tech Laboratories, Inc. and Harris Corporation. Test results relate only to the item(s) tested.

These test(s) are accredited under Rhein Tech Laboratories, Inc. ISO/IEC 17025 accreditation issued by ANAB. Refer to certificate and scope of accreditation AT-1445.

Table of Contents

1	General Information.....	5
1.1	Scope	5
1.2	Description of EUT.....	5
1.3	Test Facility.....	5
1.4	Related Submittal(s)/Grant(s).....	5
1.5	Modifications.....	5
2	Test Information	6
2.1	Description of Test Modes.....	6
2.2	Exercising the EUT	6
2.3	Test Result Summary.....	6
2.4	Test System Details.....	7
3	Peak Output Power – FCC 15.247(b)(1); RSS-247 5.4(4)	9
3.1	Power Output Test Procedure	9
3.2	Power Output Test Data.....	9
4	Compliance with the Band Edge – FCC 15.247(d); RSS-247 5.5	10
4.1	Band Edge Test Procedure	10
4.1.1	Lower Band Edge – 802.11b	11
4.1.2	Upper Band Edge – 802.11b	12
4.1.3	Lower Band Edge – 802.11g	13
4.1.4	Upper Band Edge – 802.11g	14
4.1.5	Lower Band Edge – 802.11n	15
4.1.6	Upper Band Edge – 802.11n	16
4.1.7	Lower Band Edge – 802.11n (40 MHz BW).....	17
4.1.8	Upper Band Edge – 802.11n (40 MHz BW).....	18
5	Antenna Conducted Spurious Emissions – FCC 15.247(d); RSS-247 5.5.....	19
5.1	Antenna Conducted Spurious Emissions Test Procedures	19
5.2	Antenna Conducted Spurious Emissions Test Results.....	19
6	Bandwidth – FCC 15.247(a)(2); RSS-247 5.2(1)	20
6.1	6 dB Bandwidth Test Procedure	20
6.2	6 dB Bandwidth Test Results	20
7	Power Spectral Density – FCC 15.247(e); RSS-247 5.2(2).....	31
7.1	Power Spectral Density Test Procedure	31
7.2	Power Spectral Density Test Data – DSSS WLAN.....	31
8	Radiated Emissions – FCC 15.209; RSS-247 2.2 and RSS-Gen.....	42
8.1	Limits of Radiated Emissions Measurement	42
8.2	Radiated Emissions Measurement Test Procedure	42
8.3	Radiated Emissions Test Results	44
8.3.1	Radiated Emissions Harmonics/Spurious.....	44
9	Conclusion	50

Table Index

Table 2-1:	Channels Tested for DSSS – 802.11b (2 Mbps); 802.11g (12 Mbps).....	6
Table 2-2:	Test Result Summary – FCC Part 15, Subpart C (Section 15.247), IC RSS-247/RSS-Gen 6	
Table 2-3:	Equipment Under Test.....	7
Table 2-4:	Accessory Test Equipment.....	7
Table 3-1:	Power Output Test Equipment.....	9
Table 3-2:	Power Output Test Data – 802.11b.....	9
Table 3-3:	Power Output Test Data – 802.11g.....	9
Table 3-4:	Power Output Test Data – 802.11n.....	9
Table 4-1:	Band Edge Test Equipment.....	10
Table 5-1:	Antenna Conducted Spurious Test Equipment.....	19
Table 6-1:	6 dB Bandwidth Test Equipment.....	20
Table 6-2:	6 dB Bandwidth Test Data – 802.11b (2 Mbps).....	20
Table 6-3:	6 dB Bandwidth Test Data – 802.11g (18 Mbps).....	20
Table 6-4:	6 dB Bandwidth Test Data – 802.11n (6.5 Mbps-20 MHz BW).....	20
Table 6-5:	6 dB Bandwidth Test Data – 802.11n (40 MHz BW).....	20
Table 7-1:	Power Spectral Density Test Equipment.....	31
Table 7-2:	Power Spectral Density Test Data – 802.11b (2 Mbps).....	31
Table 7-3:	Power Spectral Density Test Data – 802.11g (18 Mbps).....	31
Table 7-4:	Power Spectral Density Test Data – 802.11n (13 Mbps-20MHz BW).....	31
Table 7-5:	Power Spectral Density Test Data – 802.11n (40 MHz BW).....	31
Table 8-1:	Radiated Emissions Test Equipment.....	43
Table 8-2:	2412 MHz; 802.11b; 2 Mbps; Channel 1; Average Mode.....	44
Table 8-3:	2437 MHz; 802.11b; 2 Mbps; Channel 6; Average Mode.....	44
Table 8-4:	2462 MHz; 802.11b; 2 Mbps; Channel 11; Average Mode.....	44
Table 8-5:	2412 MHz; 802.11g; 11 Mbps; Channel 1; Average Mode.....	45
Table 8-6:	2437 MHz; 802.11g; 11 Mbps; Channel 6; Average Mode.....	45
Table 8-7:	2462 MHz; 802.11g; 11 Mbps; Channel 11; Average Mode.....	45
Table 8-8:	2412 MHz; 802.11n; 65 Mbps; Channel 1; Average Mode.....	46
Table 8-9:	2437 MHz; 802.11n; 65 Mbps; Channel 6; Average Mode.....	46
Table 8-10:	2462 MHz; 802.11n; 65 Mbps; Channel 11; Average Mode.....	46
Table 8-11:	2412 MHz; 802.11b; 2 Mbps; Channel 1; Peak Mode.....	47
Table 8-12:	2437 MHz; 802.11b; 2 Mbps; Channel 6; Peak Mode.....	47
Table 8-13:	2462 MHz; 802.11b; 2 Mbps; Channel 11; Peak Mode.....	47
Table 8-14:	2412 MHz; 802.11g; 11 Mbps; Channel 1; Peak Mode.....	48
Table 8-15:	2437 MHz; 802.11g; 11 Mbps; Channel 6; Peak Mode.....	48
Table 8-16:	2462 MHz; 802.11g; 11 Mbps; Channel 11; Peak Mode.....	48
Table 8-17:	2412 MHz; 802.11n; 65 Mbps; Channel 1; Peak Mode.....	49
Table 8-18:	2437 MHz; 802.11n; 65 Mbps; Channel 6; Peak Mode.....	49
Table 8-19:	2462 MHz; 802.11n; 65 Mbps; Channel 11; Peak Mode.....	49

Plot Index

Plot 4-1:	In Band Emissions - Channel 1 (2412 MHz); 802.11b (2 Mbps).....	11
Plot 4-2:	In Band Emissions - Channel 11 (2462 MHz); 802.11b (2 Mbps).....	12
Plot 4-3:	In Band Emissions - Channel 1 (2412 MHz); 802.11g (12 Mbps).....	13
Plot 4-4:	In Band Emissions - Channel 11 (2462 MHz); 802.11g (12 Mbps).....	14
Plot 4-5:	In Band Emissions - Channel 1 (2412 MHz); 802.11n (65 Mbps).....	15
Plot 4-6:	In Band Emissions - Channel 11 (2462 MHz); 802.11n (65 Mbps).....	16
Plot 4-7:	In Band Emissions - Channel 5 (2422 MHz); 802.11n (65 Mbps).....	17
Plot 4-8:	In Band Emissions - Channel 7 (2432 MHz); 802.11n (40 MHz).....	18
Plot 6-1:	6 dB Bandwidth Channel 1 (TX Frequency 2412 MHz) - 802.11b.....	21
Plot 6-2:	6 dB Bandwidth Channel 6 (TX Frequency 2437 MHz) - 802.11b.....	22
Plot 6-3:	6 dB Bandwidth Channel 11 (TX Frequency 2462 MHz) - 802.11b.....	23
Plot 6-4:	6 dB Bandwidth Channel 1 (TX Frequency 2412 MHz) - 802.11g.....	24
Plot 6-5:	6 dB Bandwidth Channel 6 (TX Frequency 2437 MHz) - 802.11g.....	25
Plot 6-6:	6 dB Bandwidth Channel 11 (TX Frequency 2462 MHz) - 802.11g.....	26
Plot 6-7:	6 dB Bandwidth Channel 1 (TX Frequency 2412 MHz-20 MHz BW) - 802.11n.....	27
Plot 6-8:	6 dB Bandwidth Channel 6 (TX Frequency 2437 MHz-20 MHz BW) - 802.11n.....	28
Plot 6-9:	6 dB Bandwidth Channel 11 (TX Frequency 2462 MHz-20 MHz BW) - 802.11n.....	29
Plot 6-10:	6 dB Bandwidth Channel 8 (TX Frequency 2437 MHz-40 MHz BW) - 802.11n.....	30
Plot 7-1:	Power Spectral Density: Channel 1 (2412 MHz); 802.11b (2 Mbps).....	32
Plot 7-2:	Power Spectral Density: Channel 6 (2437 MHz); 802.11b (2 Mbps).....	33
Plot 7-3:	Power Spectral Density: Channel 11 (2462 MHz); 802.11b (2 Mbps).....	34
Plot 7-4:	Power Spectral Density: Channel 1 (2412 MHz); 802.11g (18 Mbps).....	35
Plot 7-5:	Power Spectral Density: Channel 6 (2437 MHz); 802.11g (18 Mbps).....	36
Plot 7-6:	Power Spectral Density: Channel 11 (2462 MHz); 802.11g (18 Mbps).....	37
Plot 7-7:	Power Spectral Density: Channel 1 (2412 MHz); 802.11n (13 Mbps).....	38
Plot 7-8:	Power Spectral Density: Channel 6 (2437 MHz); 802.11n (13 Mbps).....	39
Plot 7-9:	Power Spectral Density: Channel 11 (2462 MHz); 802.11n (13 Mbps).....	40
Plot 7-10:	Power Spectral Density: Channel 5 (2442 MHz); 802.11n (40MHz BW).....	41

Appendix Index

Appendix A: Test Photographs	51
------------------------------------	----

Photograph Index

Photograph 1: Radiated Testing – Front View	51
Photograph 2: Radiated Testing – Back View	52

1 General Information

1.1 Scope

This is an original FCC and Industry Canada certification application report.

Applicable Standards:

- FCC Rules Part 15.247: Frequency Hopping, Direct Spread Spectrum and Hybrid Systems that are in operation within the bands of 902-928 MHz, 2400-2483.5 MHz and 5725-5850 MHz
- RSS-247 Issue 2 Digital Transmission Systems (DTSs), Frequency Hopping Systems (FHSs) and Licence-Exempt Local Area Network (LE-LAN) Devices
- RSS-Gen Issue 4: General Requirements and Information for the Certification of Radio Apparatus

This test report addresses the intentional radiated emissions requirements per FCC 15.247, which are the harmonic/spurious radiated emissions occurring in the restricted bands per FCC 15.205 (against the FCC 15.209 limits).

1.2 Description of EUT

Equipment Under Test	XL-185P
Power Supply	7.4 VDC Li-Ion Battery
Modulation Type	DSSS
Frequency Range	2412 – 2462 MHz
Antenna Connector Type	N/A
Antenna Type	Internal chip

1.3 Test Facility

The open area test site and conducted measurement facility used to collect the radiated data is located at 360 Herndon Parkway, Suite 1400, Herndon, Virginia 20170. This site has been fully described in a report and approved by the Federal Communications Commission to perform AC line conducted and radiated emissions testing.

1.4 Related Submittal(s)/Grant(s)

This report supports a certification application for Harris Corporation Model XL-185P, FCC ID: OWDTR-0147-E, IC: 3636B-0147.

1.5 Modifications

No physical modifications were required for compliance.

2 Test Information

2.1 Description of Test Modes

In accordance with FCC 15.31(m), and because the EUT utilizes an operating band greater than 10 MHz, the following frequencies were tested.

Table 2-1: Channels Tested for DSSS – 802.11b (2 Mbps); 802.11g (12 Mbps)

Channel	Frequency (MHz)
1	2412
6	2437
11	2462

2.2 Exercising the EUT

The EUT was tested in all three orthogonal planes in order to determine worst-case emissions. The EUT was provided with software to continuously transmit during testing. The carrier was also checked to verify that information was being transmitted. There were no deviations from the test standard(s) and/or methods. The test results reported relate only to the item tested.

2.3 Test Result Summary

Table 2-2: Test Result Summary – FCC Part 15, Subpart C (Section 15.247), IC RSS-247/RSS-Gen

FCC Reference	IC Reference	C63.10 Procedure	Test	Pass/Fail or N/A
FCC 15.209	RSS-247 2.2 RSS-Gen 6.5, A2.9	6.5, 6.6	Radiated Emissions	Pass
FCC 15.247(a)(2)	RSS-247 5.2	11.8	6 dB Bandwidth	Pass
FCC 15.247(b)	RSS-247 5.4 RSS-Gen 6.12	11.9	Maximum Peak Power Output	Pass
FCC 15.247(d)	RSS-247 5.5 RSS-Gen 6.13	11.12.2	Antenna Conducted Spurious Emissions	Pass
FCC 15.247(e)	RSS-247 5.2	11.10	Power Spectral Density	Pass
FCC 15.247(d)	RSS-247 5.5	11.13	Band Edge Measurement	Pass

2.4 Test System Details

The test samples were received on February 27, 2014. The FCC identifiers for all applicable equipment, plus descriptions of all cables used in the tested system, are identified in the following tables.

Table 2-3: Equipment Under Test

Part	Manufacturer	Model	Serial Number	FCC ID	RTL Bar Code
Radio	Harris Corporation	XL-185P (System)	14035-1000-01/E00236	OWDTR-0147-E	21612
Radio (conducted connection)	Harris Corporation	XL-185P (System)	14035-1000-01/0WXD-E00239	OWDTR-0147-E	21614

Table 2-4: Accessory Test Equipment

Part	Manufacturer	Model	Serial Number	FCC ID	RTL Bar Code
Battery Eliminator	Harris Corporation	14035-4300-01	N/A	N/A	21553
Breakout Box	Harris Corporation	12082-7980-01	N/A	N/A	20599
Battery	Harris Corporation	BAT-L-CASE-R-HR003	Engineering Sample #73	N/A	21552
Laptop	Samsung	NP300E5A-A01UB	HJVVF93EB903201D	N/A	901550

Figure 2-1: Configuration of Tested System

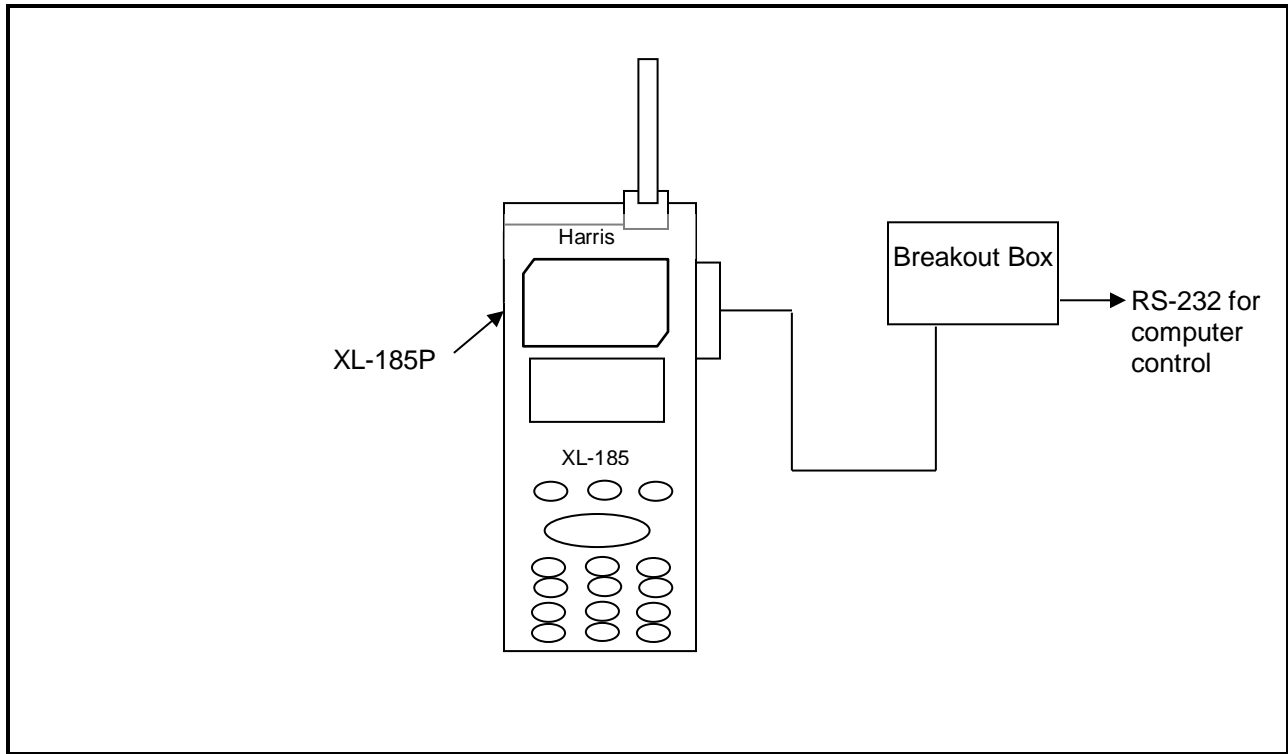

3 Peak Output Power – FCC 15.247(b)(1); RSS-247 5.4(d)

3.1 Power Output Test Procedure

A conducted power measurement of the EUT was taken using a Rohde & Schwarz Spectrum Analyzer.

Table 3-1: Power Output Test Equipment

RTL Asset #	Manufacturer	Model	Part Type	Serial Number	Calibration Due Date
901581	Rohde & Schwarz	FSU	Spectrum Analyzer	1166.1660.50	11/13/15

3.2 Power Output Test Data

Table 3-2: Power Output Test Data – 802.11b

Channel	Frequency (MHz)	Peak Power (dBm)
1	2412	20.3
6	2437	20.7
11	2462	20.0

Table 3-3: Power Output Test Data – 802.11g

Channel	Frequency (MHz)	Peak Power (dBm)
1	2412	20.9
6	2437	23.7
11	2462	20.8

Table 3-4: Power Output Test Data – 802.11n

Channel	Frequency (MHz)	Peak Power (dBm)
1	2412	21.6
6	2437	23.4
11	2462	21.3

Test Personnel:

Daniel W. Baltzell
 Test Engineer

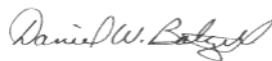

Signature

March 14, 2013
 Date of Test

4 Compliance with the Band Edge – FCC 15.247(d); RSS-247 5.5

4.1 Band Edge Test Procedure

The transmitter output was connected to its appropriate antenna. Peak (1 MHz RBW/3 MHz VBW) and average (1 MHz RBW/10 Hz VBW) corrected radiated measurements were taken within the restricted band to show compliance.

Table 4-1: Band Edge Test Equipment

RTL Asset #	Manufacturer	Model	Part Type	Serial Number	Calibration Due Date
900878	Rhein Tech Laboratories, Inc.	AM3-1197-0005	3 meter antenna mast, polarizing	Outdoor Range 1	Not Required
901592	Insulated Wire Inc.	KPS-1503-3600-KPR	SMK RF Cables 20'	NA	9/3/15
901242	Rhein Tech Laboratories, Inc.	WRT-000-0003	Wood rotating table	N/A	Not Required
900772	EMCO	3161-02	Horn Antenna (2 - 4 GHz)	9804-1044	4/09/18
901581	Rohde & Schwarz	FSU	Spectrum Analyzer	1166.1660.50	11/13/15

4.1.1 Lower Band Edge – 802.11b

94.6 dBuV/m is the average field strength measurement, from which the delta measurement of 51.7 dB is subtracted (reference plots), resulting in a level 42.9 dB. This level has a margin of 11.1 dB below the limit of 54 dBuV/m.

Calculation: $94.6 \text{ dBuV/m} - 51.7 \text{ dB} - 54 \text{ dBuV/m} = -11.1 \text{ dB}$

Peak Field Strength of Lower Band Edge (1 MHz RBW/3 MHz VBW) = 99.8 dBuV/m
 Average Field Strength of Lower Band Edge (1 MHz RBW/10 Hz VBW) = 94.6 dBuV/m
 Delta measurement = 51.7 dB

Plot 4-1: In Band Emissions - Channel 1 (2412 MHz); 802.11b (2 Mbps)

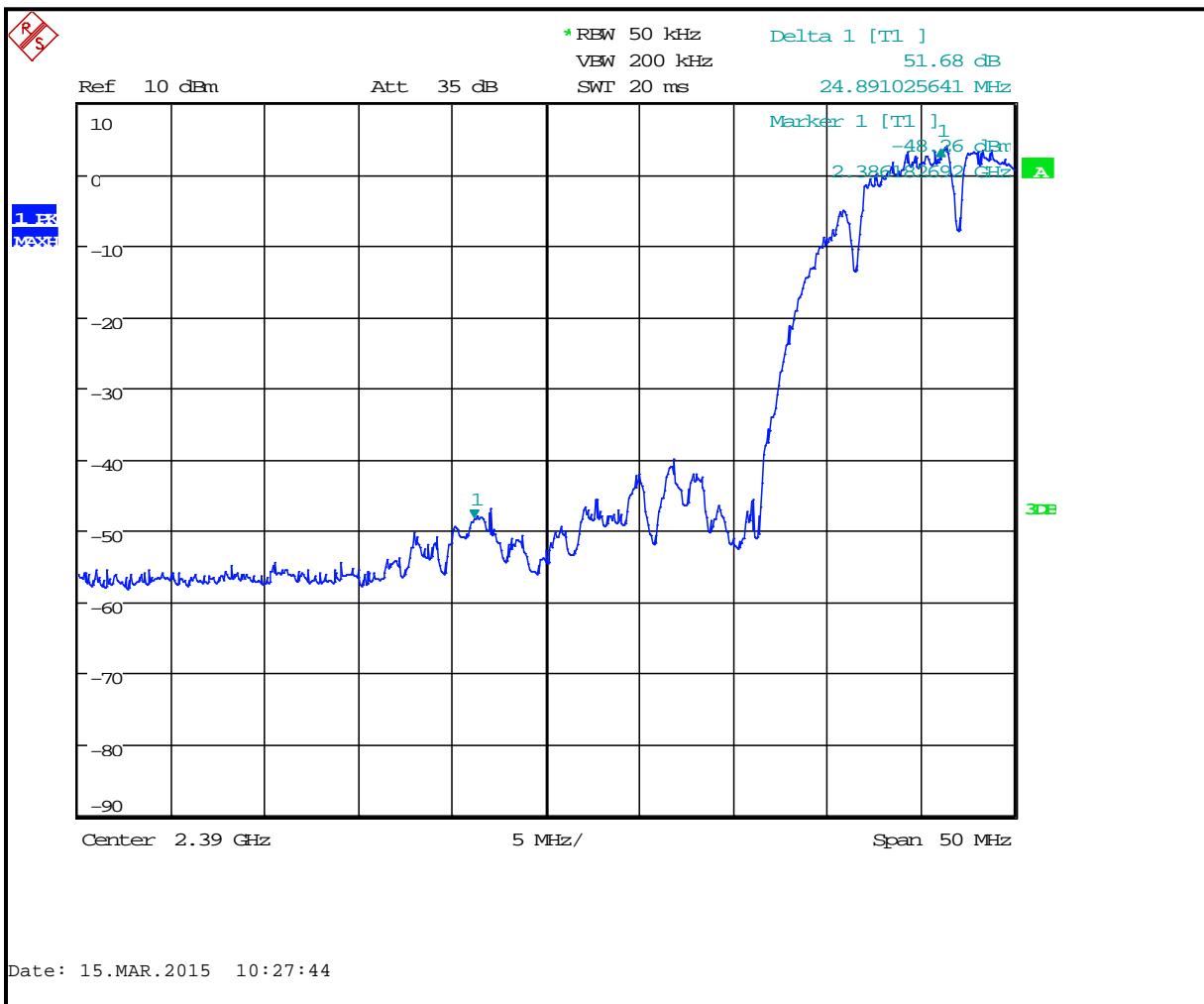

4.1.2 Upper Band Edge – 802.11b

94.8 dBuV/m is the average field strength measurement, from which the delta measurement of 47.6 dB is subtracted (reference plots), resulting in a level 47.2 dB. This level has a margin of 6.8 dB below the limit of 54 dBuV/m.

Calculation: $94.8 \text{ dBuV/m} - 47.6 \text{ dB} - 54 \text{ dBuV/m} = -6.8 \text{ dB}$

Peak Field Strength of Upper Band Edge (1 MHz RBW/1 MHz VBW) = 100.0 dBuV/m
Average Field Strength of Upper Band Edge (1 MHz RBW/10 Hz VBW) = 94.8 dBuV/m
Delta measurement = 47.6 dB

Plot 4-2: In Band Emissions - Channel 11 (2462 MHz); 802.11b (2 Mbps)

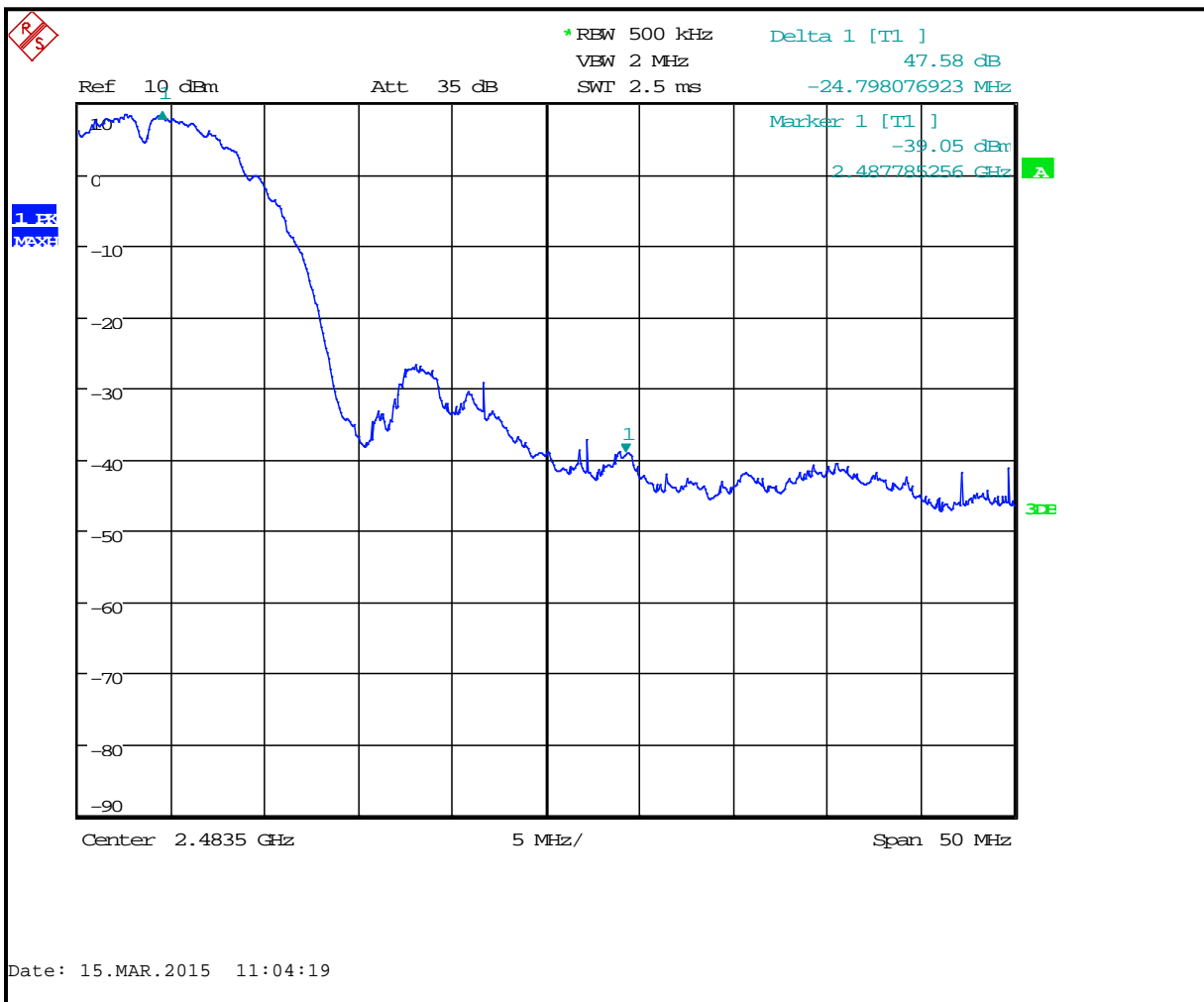

4.1.3 Lower Band Edge – 802.11g

89.1 dBuV/m is the average field strength measurement, from which the delta measurement of 35.6 dB is subtracted (reference plots), resulting in a level 53.5 dB. This level has a margin of 0.5 dB below the limit of 54 dBuV/m.

Calculation: $89.1 \text{ dBuV/m} - 35.6 \text{ dB} - 54 \text{ dBuV/m} = -0.5 \text{ dB}$

Peak Field Strength of Lower Band Edge (1 MHz RBW/3 MHz VBW) = 100.3 dBuV/m
 Average Field Strength of Lower Band Edge (1 MHz RBW/10 Hz VBW) = 89.1 dBuV/m
 Delta measurement = 35.6 dB

Plot 4-3: In Band Emissions - Channel 1 (2412 MHz); 802.11g (12 Mbps)

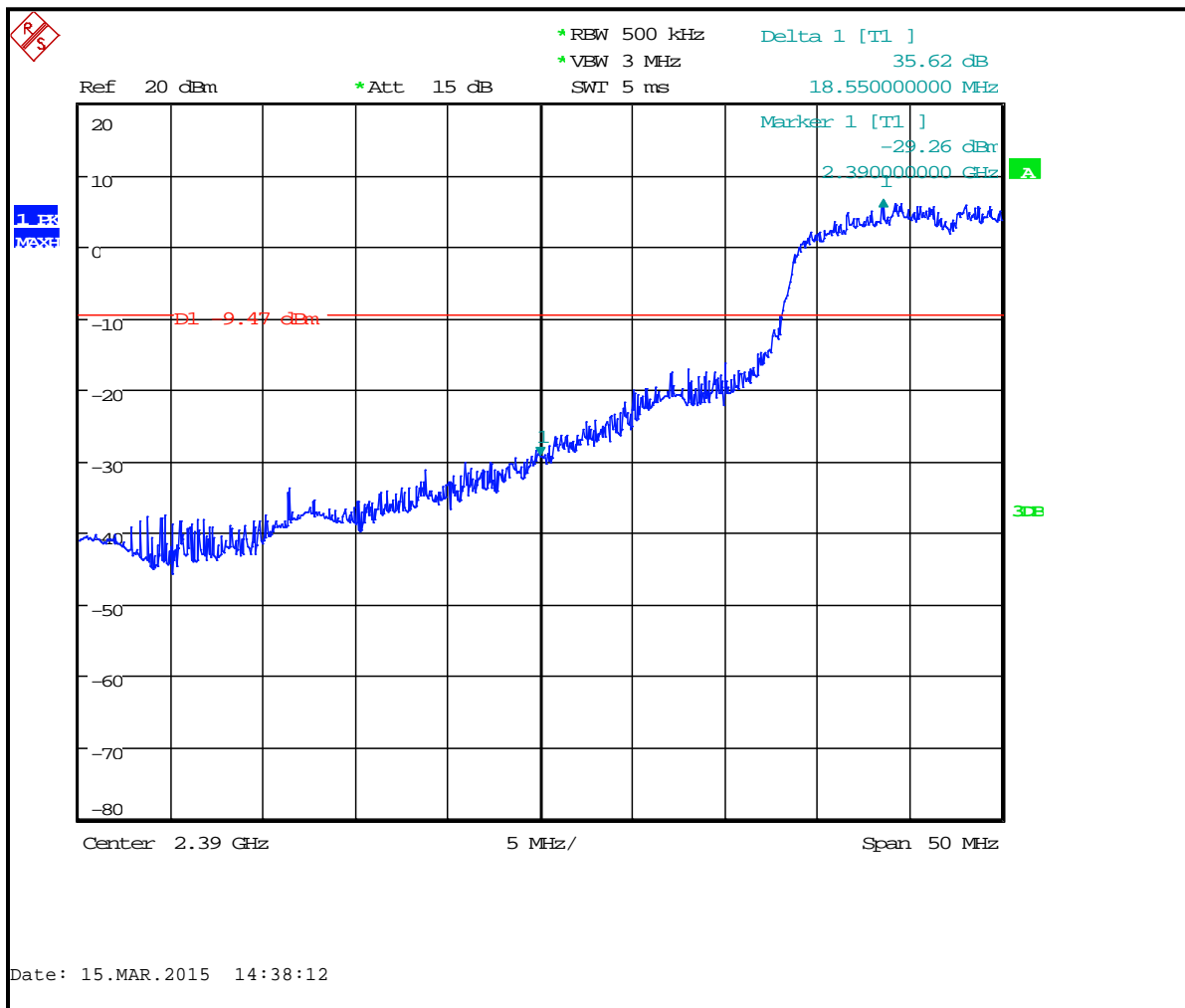

4.1.4 Upper Band Edge – 802.11g

90.9 dBuV/m is the average field strength measurement, from which the delta measurement of 39 dB is subtracted (reference plots), resulting in a level 51.9 dB. This level has a margin of 2.1 dB below the limit of 54 dBuV/m.

Calculation: $90.9 \text{ dBuV/m} - 39.0 \text{ dB} - 54 \text{ dBuV/m} = -2.1 \text{ dB}$

Peak Field Strength of Upper Band Edge (1 MHz RBW/1 MHz VBW) = 101.6 dBuV/m
Average Field Strength of Upper Band Edge (1 MHz RBW/10 Hz VBW) = 90.9 dBuV/m
Delta measurement = 39.0 dB

Plot 4-4: In Band Emissions - Channel 11 (2462 MHz); 802.11g (12 Mbps)

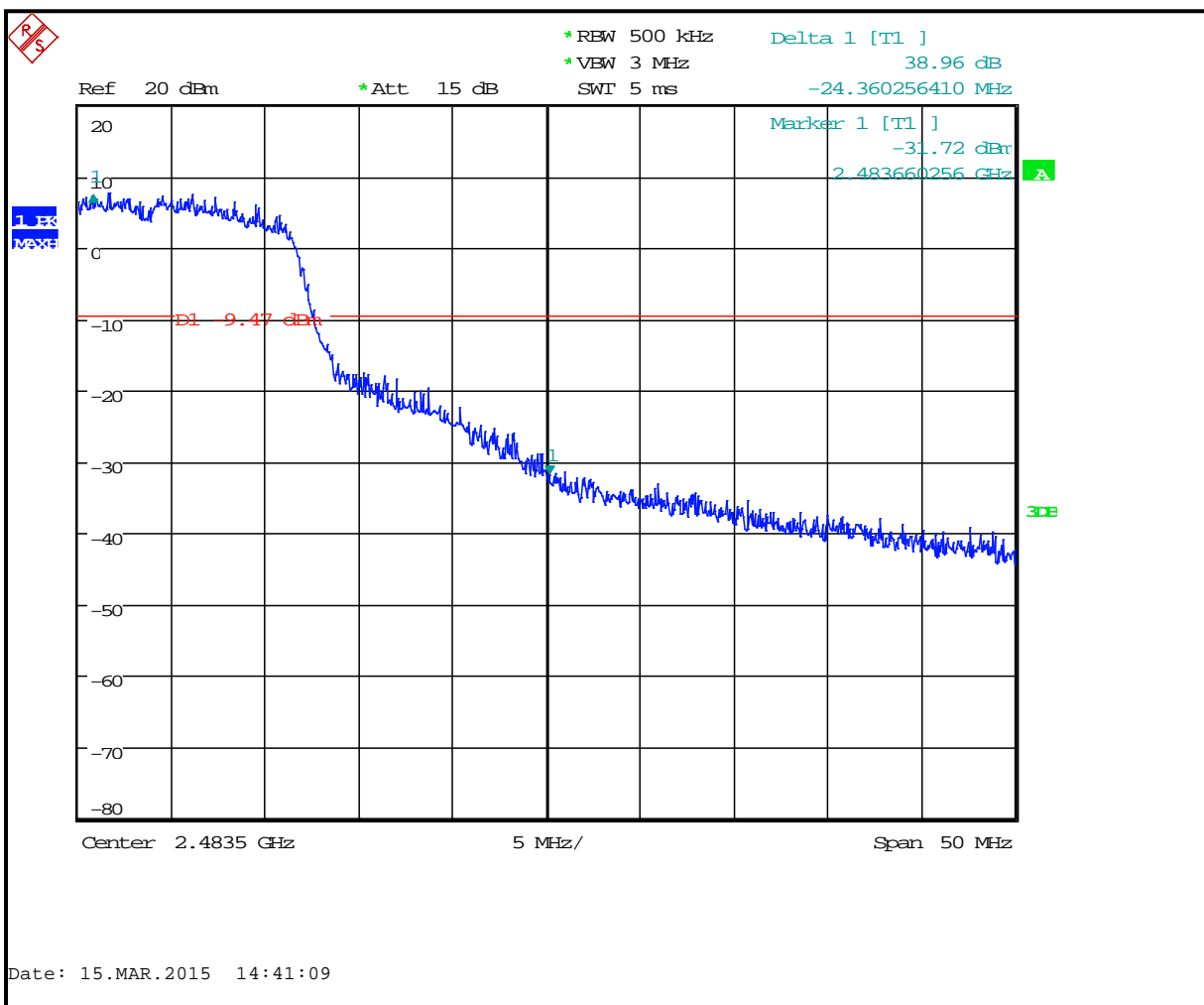

4.1.5 Lower Band Edge – 802.11n

75.4 dBuV/m is the average field strength measurement, from which the delta measurement of 40 dB is subtracted (reference plots), resulting in a level 35.4 dB. This level has a margin of 18.6 dB below the limit of 54 dBuV/m.

Calculation: $75.4 \text{ dBuV/m} - 40 \text{ dB} - 54 \text{ dBuV/m} = -18.6 \text{ dB}$

Peak Field Strength of Lower Band Edge (1 MHz RBW/3 MHz VBW) = 93.9 dBuV/m
 Average Field Strength of Lower Band Edge (1 MHz RBW/10 Hz VBW) = 75.4 dBuV/m
 Delta measurement = 40 dB

Plot 4-5: In Band Emissions - Channel 1 (2412 MHz); 802.11n (65 Mbps)

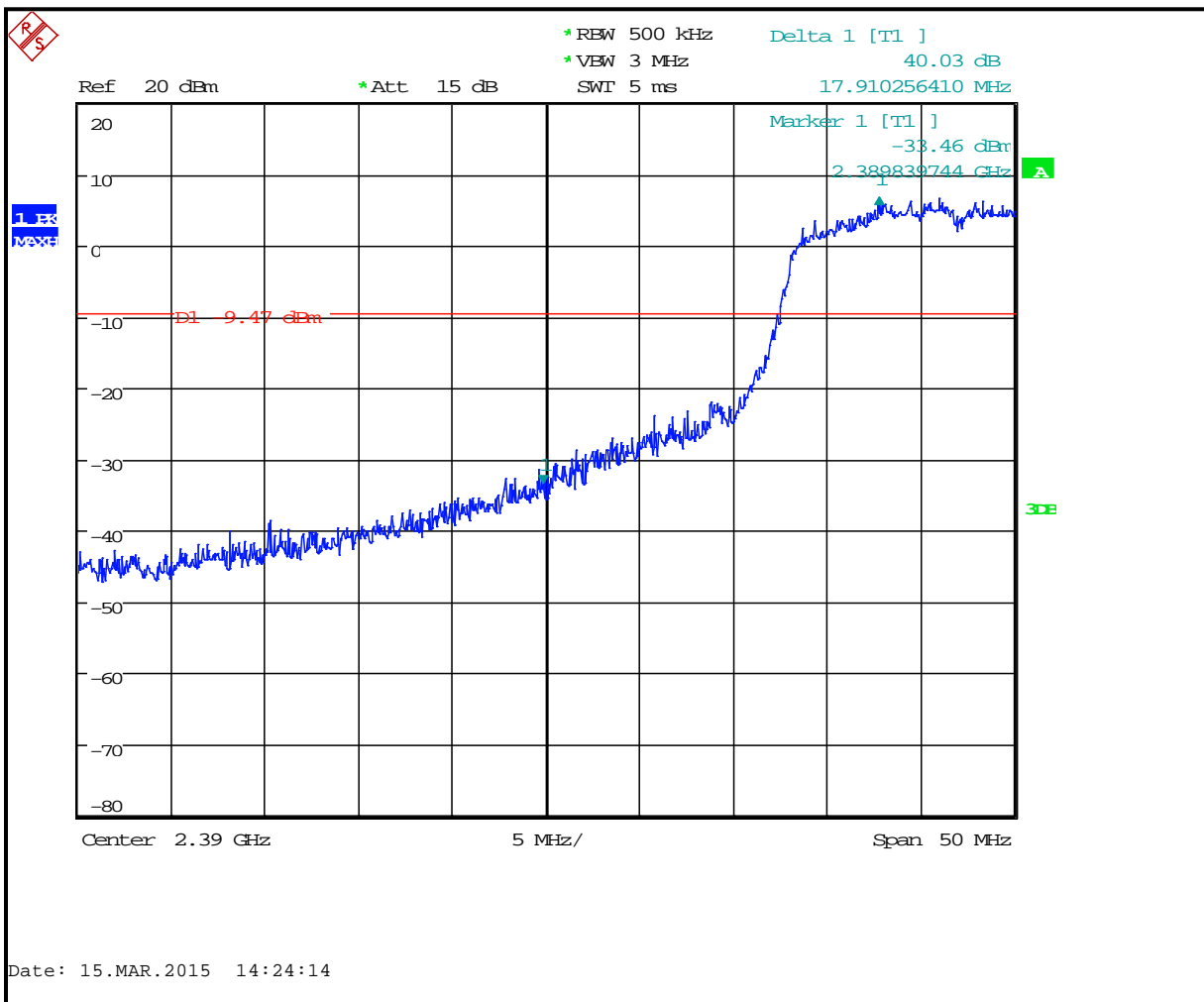

4.1.6 Upper Band Edge – 802.11n

80.5 dBuV/m is the average field strength measurement, from which the delta measurement of 40.7 dB is subtracted (reference plots), resulting in a level 39.8 dB. This level has a margin of 14.2 dB below the limit of 54 dBuV/m.

Calculation: $80.5 \text{ dBuV/m} - 40.7 \text{ dB} - 54 \text{ dBuV/m} = -14.2 \text{ dB}$

Peak Field Strength of Upper Band Edge (1 MHz RBW/1 MHz VBW) = 94.7 dBuV/m
 Average Field Strength of Upper Band Edge (1 MHz RBW/10 Hz VBW) = 80.5 dBuV/m
 Delta measurement = 40.7 dB

Plot 4-6: In Band Emissions - Channel 11 (2462 MHz); 802.11n (65 Mbps)

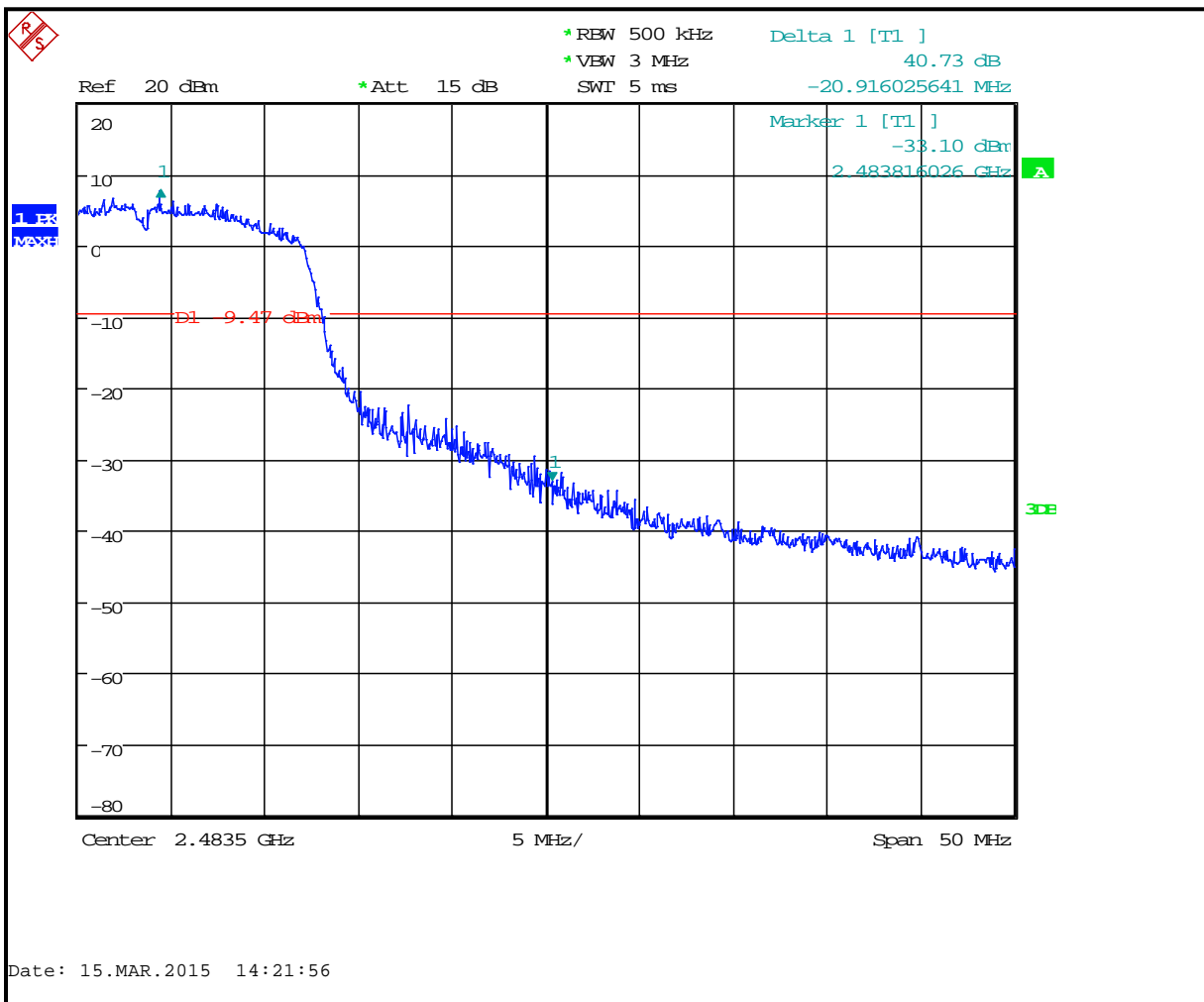

4.1.7 Lower Band Edge – 802.11n (40 MHz BW)

88.2 dBuV/m is the average field strength measurement, from which the delta measurement of 39.3 dB is subtracted (reference plots), resulting in a level 48.9 dB. This level has a margin of 5.1 dB below the limit of 54 dBuV/m.

Calculation: $88.2 \text{ dBuV/m} - 39.3 \text{ dB} - 54 \text{ dBuV/m} = -5.1 \text{ dB}$

Peak Field Strength of Lower Band Edge (1 MHz RBW/3 MHz VBW) = 94.7 dBuV/m
 Average Field Strength of Lower Band Edge (1 MHz RBW/10 Hz VBW) = 88.2 dBuV/m
 Delta measurement = 39.3 dB

Plot 4-7: In Band Emissions - Channel 5 (2422 MHz); 802.11n (65 Mbps)

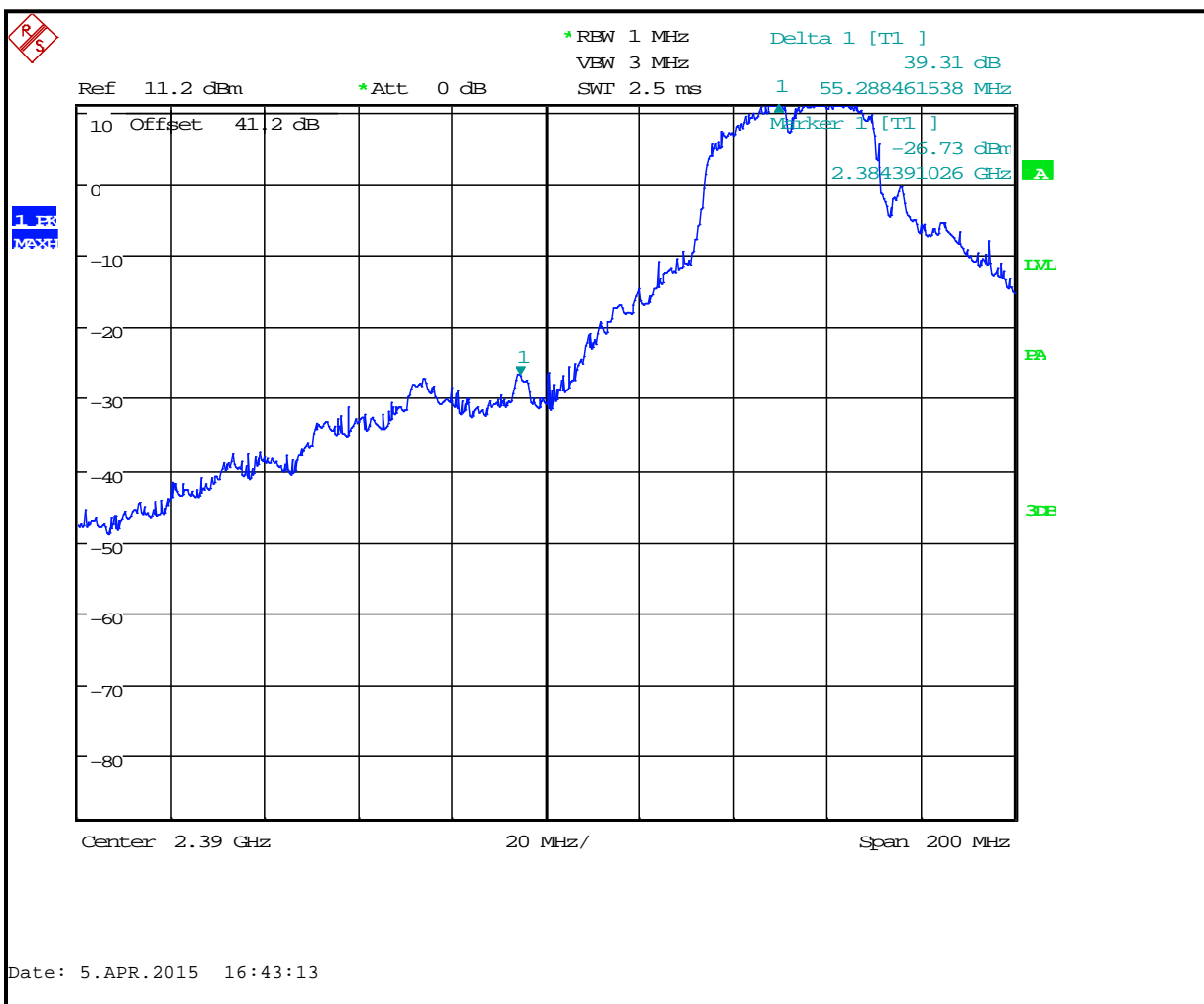

4.1.8 Upper Band Edge – 802.11n (40 MHz BW)

88.2 dBuV/m is the average field strength measurement, from which the delta measurement of 35.8 dB is subtracted (reference plots), resulting in a level 52.4 dB. This level has a margin of 1.6 dB below the limit of 54 dBuV/m.

Calculation: $88.2 \text{ dBuV/m} - 35.8 \text{ dB} - 54 \text{ dBuV/m} = -1.6 \text{ dB}$

Peak Field Strength of Lower Band Edge (1 MHz RBW/3 MHz VBW) = 94.7 dBuV/m
 Average Field Strength of Lower Band Edge (1 MHz RBW/10 Hz VBW) = 88.2 dBuV/m
 Delta measurement = 35.8 dB 23.1 @ch9=

Plot 4-8: In Band Emissions - Channel 7 (2432 MHz); 802.11n (40 MHz)

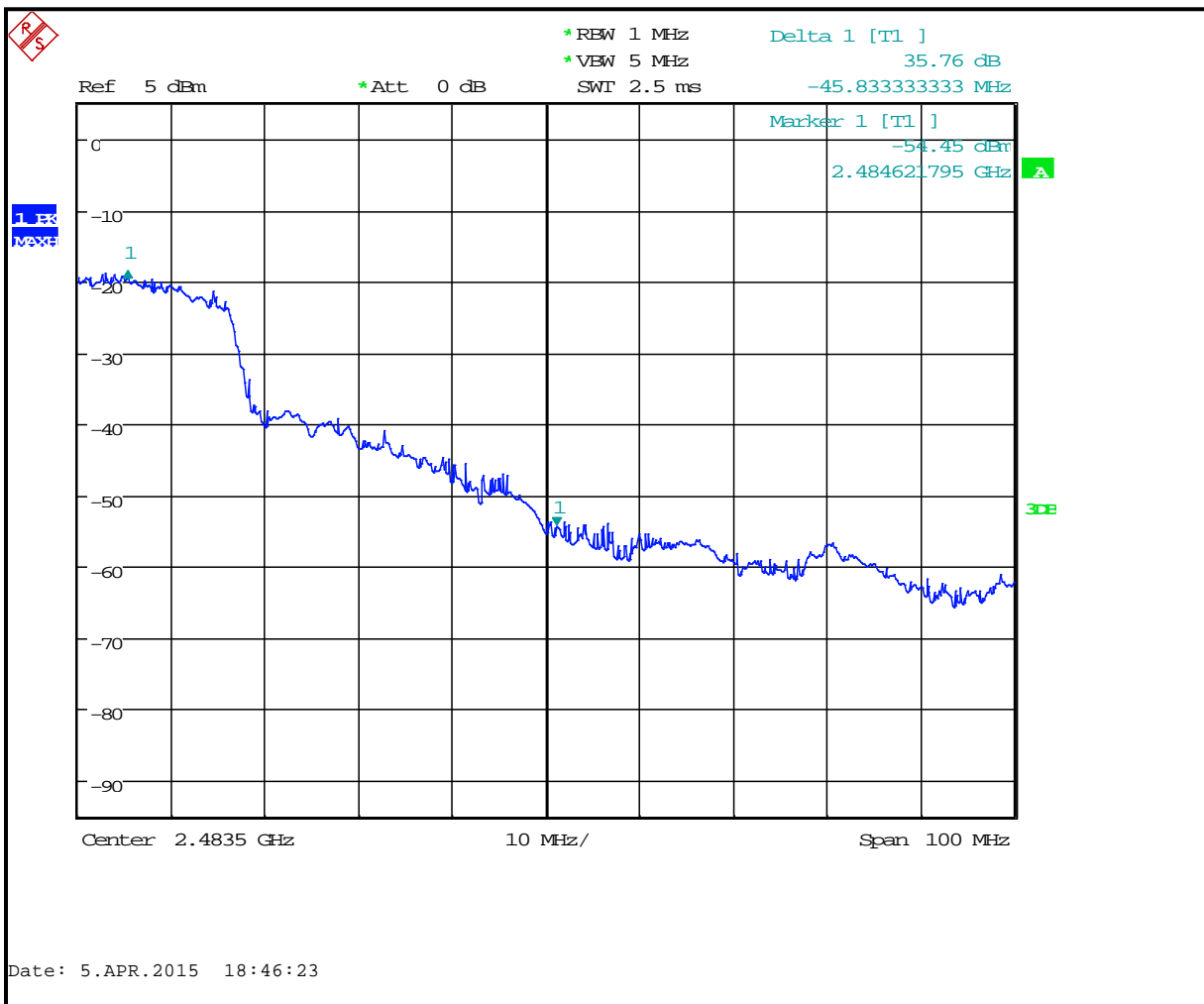

Test Personnel:

Daniel W. Baltzell
 Test Engineer

Signature

March 15 & April 5, 2015
 Dates of Test

5 Antenna Conducted Spurious Emissions – FCC 15.247(d); RSS-247 5.5

5.1 Antenna Conducted Spurious Emissions Test Procedures

Antenna spurious emissions per FCC 15.247(d) were measured from the EUT antenna port using a 50-ohm spectrum analyzer with the resolution bandwidth set at 100 kHz, and the video bandwidth set at 300 kHz. The modulated carrier was identified at the following frequencies: 2412 MHz, 2437 MHz and 2462 MHz.

5.2 Antenna Conducted Spurious Emissions Test Results

No harmonics or spurs were found within 20 dB (note that we are reporting power as peak) of the carrier level from the carrier to the 10th harmonic of the carrier frequency. Per FCC 15.31(o), no data is being reported.

Table 5-1: Antenna Conducted Spurious Test Equipment

RTL Asset #	Manufacturer	Model	Part Type	Serial Number	Calibration Due Date
901581	Rohde & Schwarz	FSU	Spectrum Analyzer	1166.1660.50	11/13/15

Test Personnel:

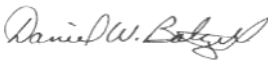
Daniel W. Baltzell Test Engineer	 Signature	March 15, 2015 Date of Test
-------------------------------------	---	--------------------------------

6 Bandwidth – FCC 15.247(a)(2); RSS-247 5.2(a)

6.1 6 dB Bandwidth Test Procedure

The minimum 6 dB bandwidths per FCC 15.247(a)(2) were measured using a 50-ohm spectrum analyzer with the resolution bandwidth set at 100 kHz, and the video bandwidth set at $\geq 3 \times \text{RBW}$. The device was modulated. The minimum 6 dB bandwidths are presented below.

Table 6-1: 6 dB Bandwidth Test Equipment

RTL Asset #	Manufacturer	Model	Part Type	Serial Number	Calibration Due Date
901581	Rohde & Schwarz	FSU	Spectrum Analyzer	1166.1660.50	11/13/15

6.2 6 dB Bandwidth Test Results

Table 6-2: 6 dB Bandwidth Test Data – 802.11b (2 Mbps)

Channel	Frequency (MHz)	6 dB Bandwidth (MHz)	Minimum Limit (MHz)	Pass/Fail
1	2412	10.1	0.5	Pass
6	2437	10.3	0.5	Pass
11	2462	10.1	0.5	Pass

Table 6-3: 6 dB Bandwidth Test Data – 802.11g (18 Mbps)

Channel	Frequency (MHz)	6 dB Bandwidth (MHz)	Minimum Limit (MHz)	Pass/Fail
1	2412	14.7	0.5	Pass
6	2437	14.6	0.5	Pass
11	2462	14.4	0.5	Pass

Table 6-4: 6 dB Bandwidth Test Data – 802.11n (6.5 Mbps-20 MHz BW)

Channel	Frequency (MHz)	6 dB Bandwidth (MHz)	Minimum Limit (MHz)	Pass/Fail
1	2412	14.7	0.5	Pass
6	2437	14.6	0.5	Pass
11	2462	14.6	0.5	Pass

Table 6-5: 6 dB Bandwidth Test Data – 802.11n (40 MHz BW)

Channel	Frequency (MHz)	6 dB Bandwidth (MHz)	Minimum Limit (MHz)	Pass/Fail
8	2437	35.9	0.5	Pass

Plot 6-1: 6 dB Bandwidth Channel 1 (TX Frequency 2412 MHz) - 802.11b

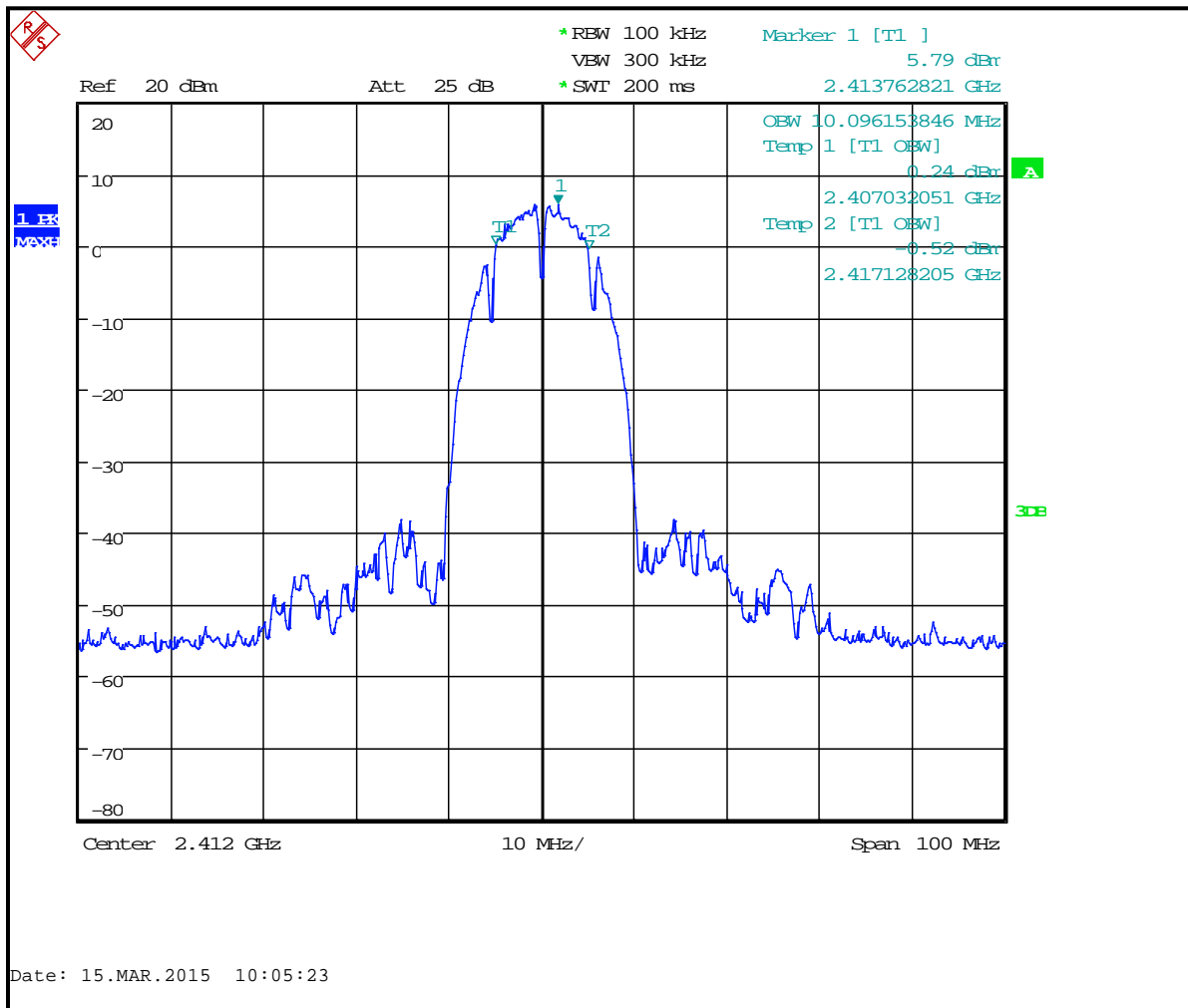

Plot 6-2: 6 dB Bandwidth Channel 6 (TX Frequency 2437 MHz) - 802.11b

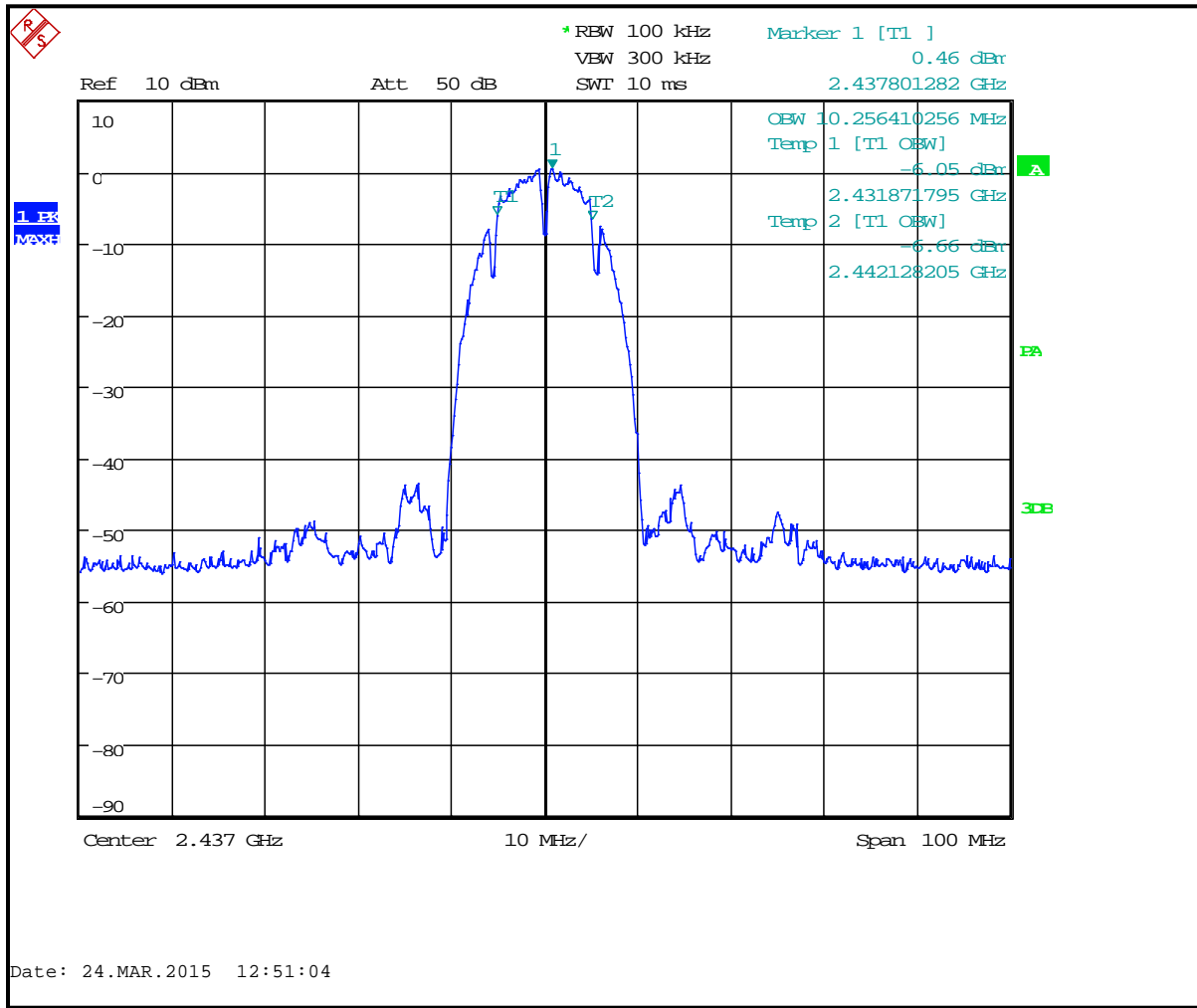

Plot 6-3: 6 dB Bandwidth Channel 11 (TX Frequency 2462 MHz) - 802.11b

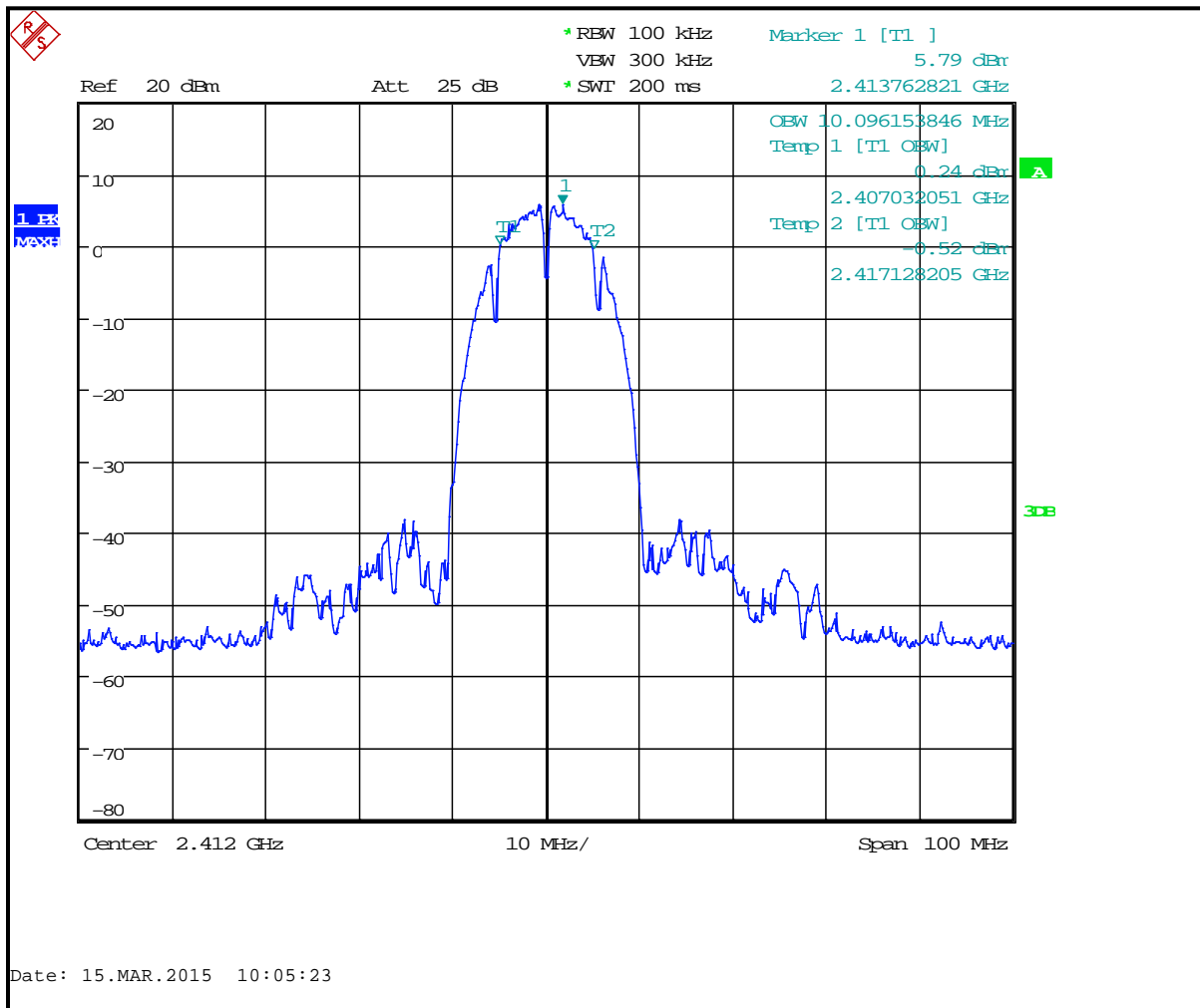

Plot 6-4: 6 dB Bandwidth Channel 1 (TX Frequency 2412 MHz) - 802.11g

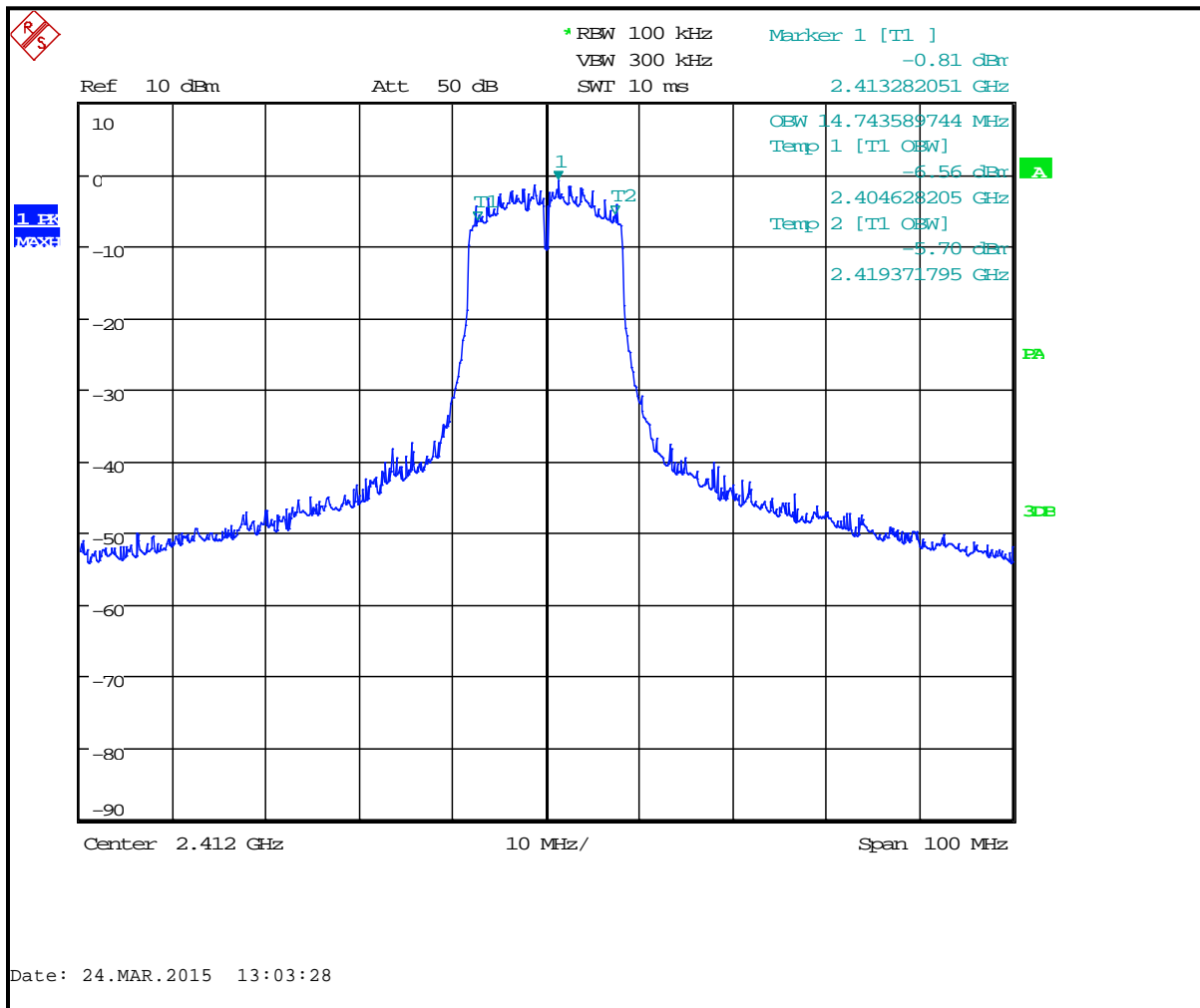

Plot 6-5: 6 dB Bandwidth Channel 6 (TX Frequency 2437 MHz) - 802.11g

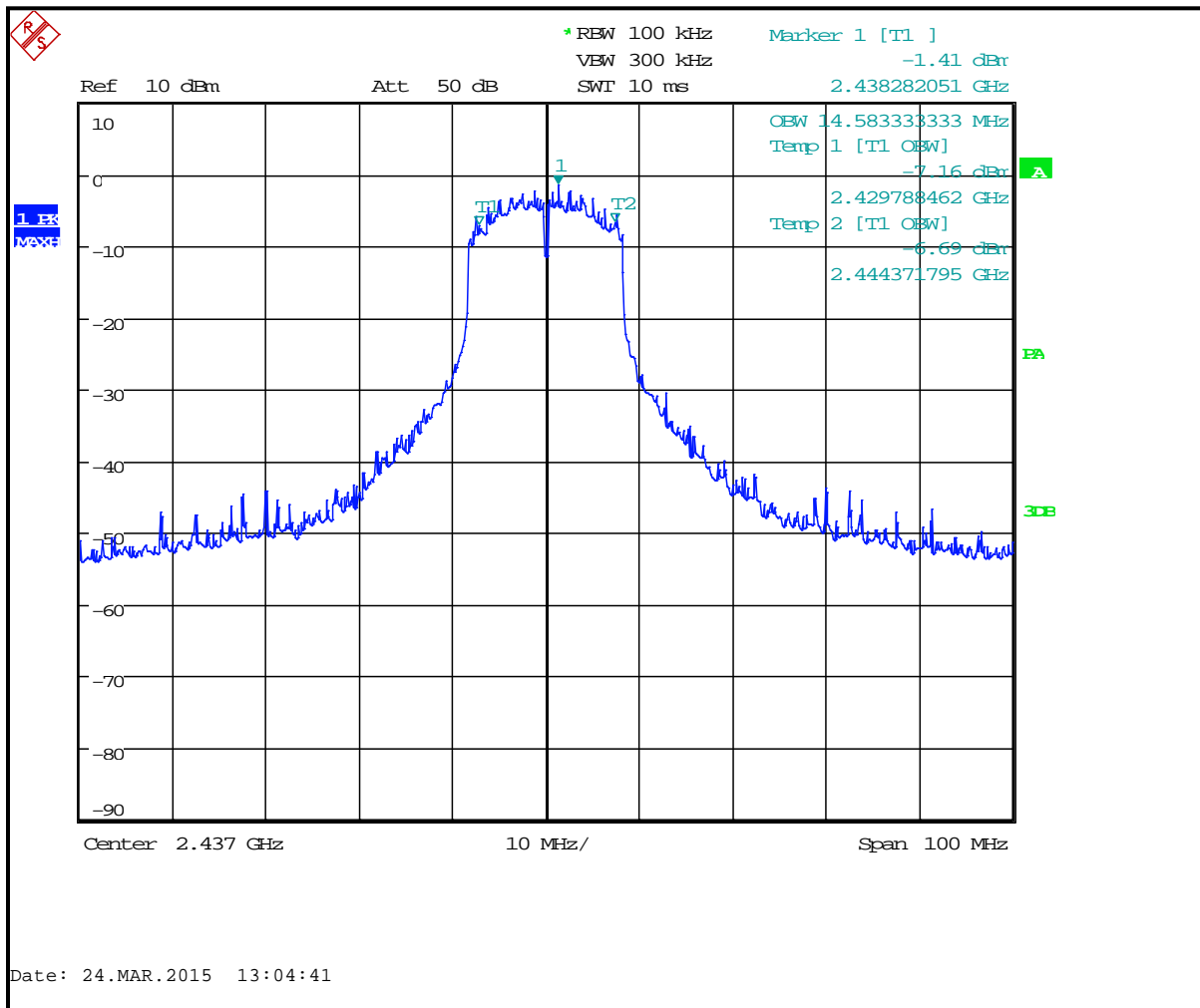

Plot 6-6: 6 dB Bandwidth Channel 11 (TX Frequency 2462 MHz) - 802.11g

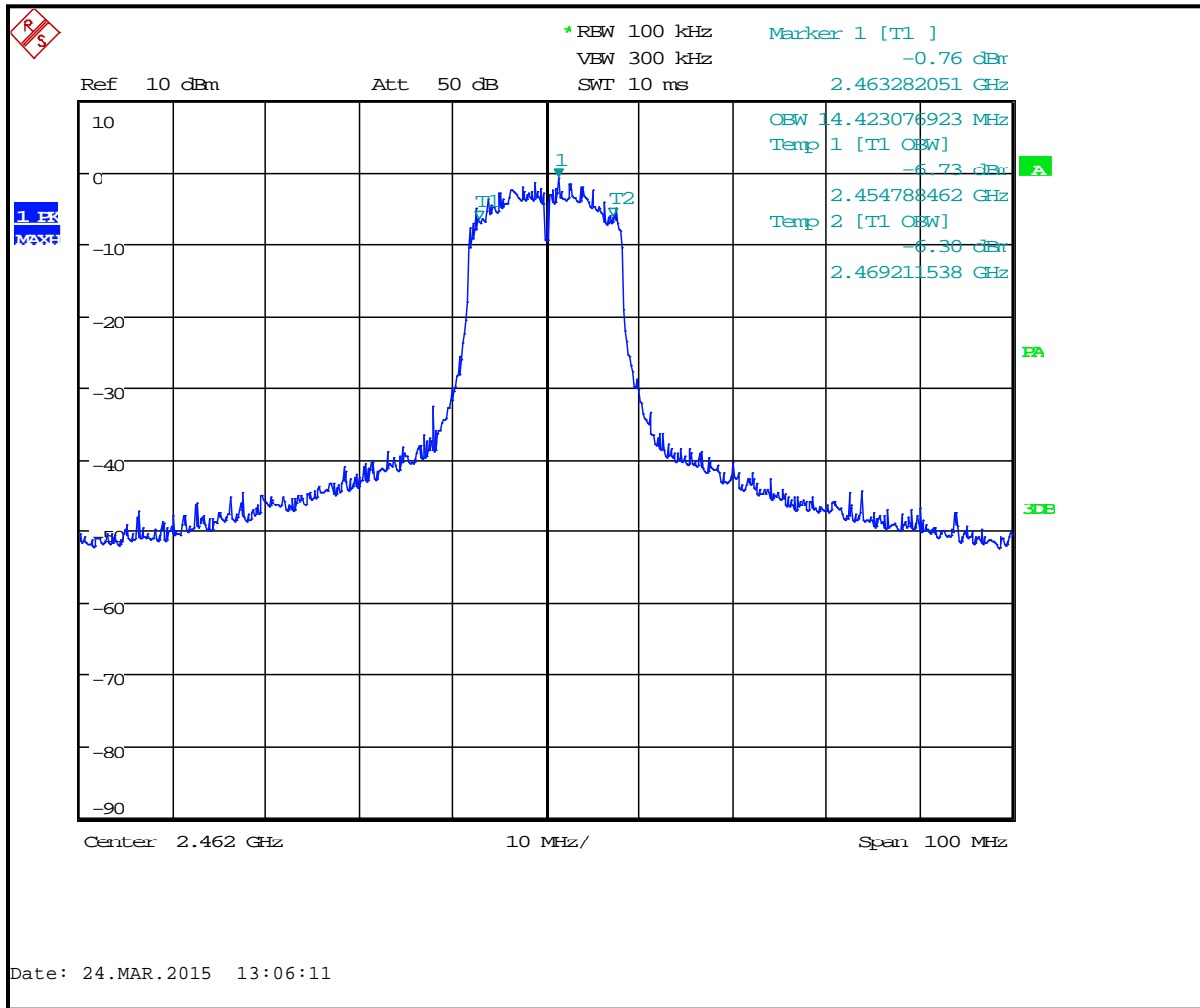

Plot 6-7: 6 dB Bandwidth Channel 1 (TX Frequency 2412 MHz-20 MHz BW) - 802.11n

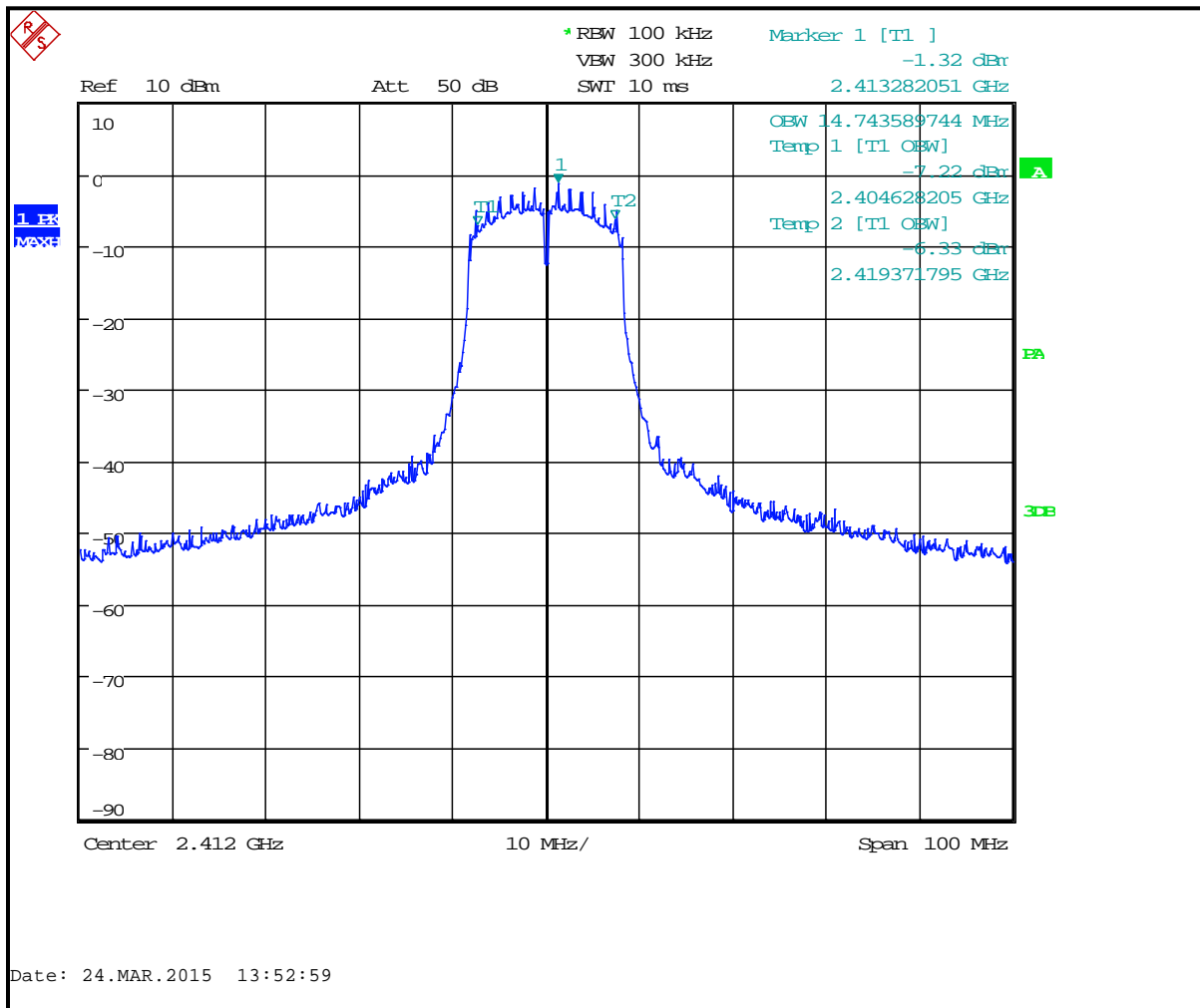

Plot 6-8: 6 dB Bandwidth Channel 6 (TX Frequency 2437 MHz-20 MHz BW) - 802.11n

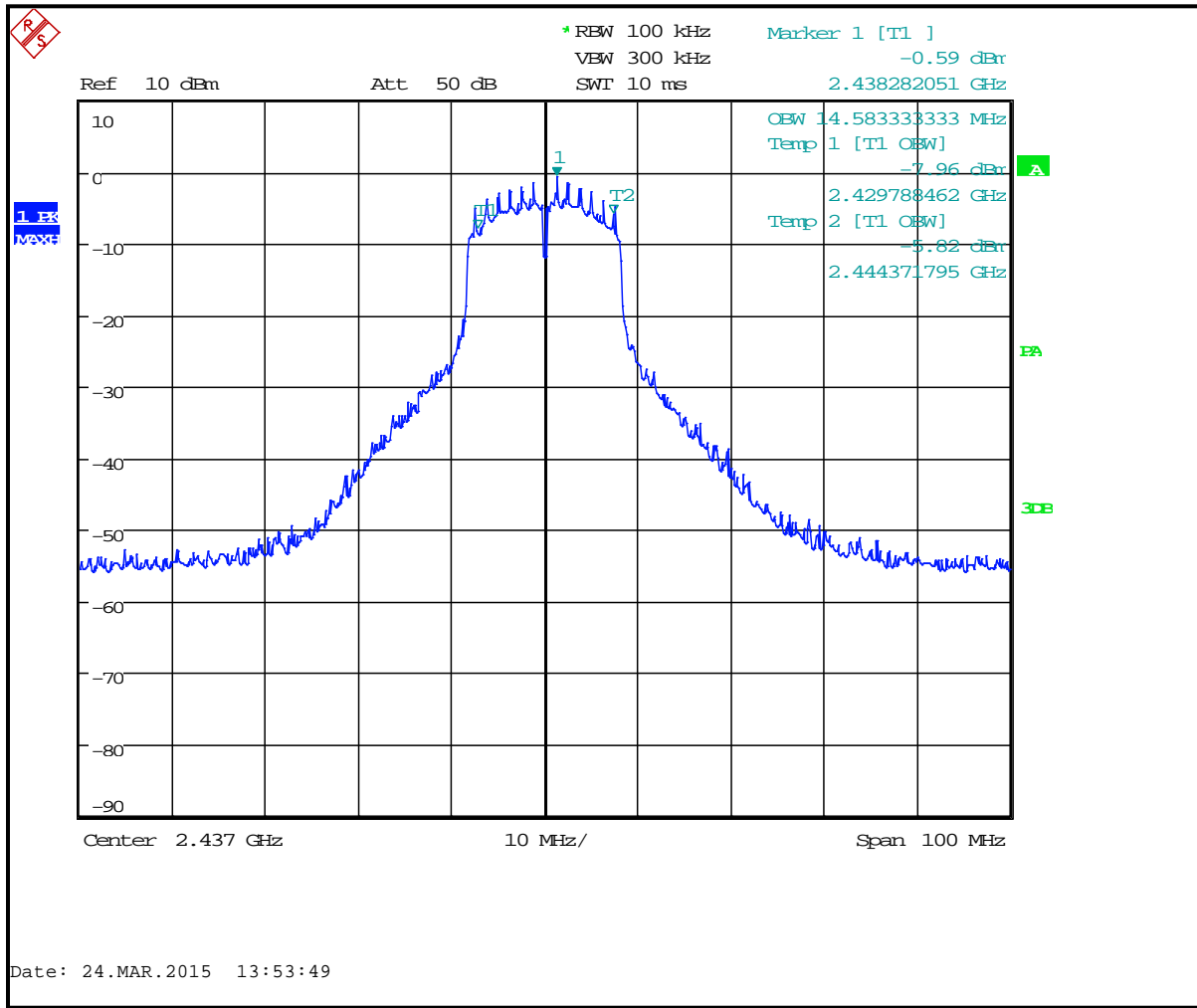

Plot 6-9: 6 dB Bandwidth Channel 11 (TX Frequency 2462 MHz-20 MHz BW) - 802.11n

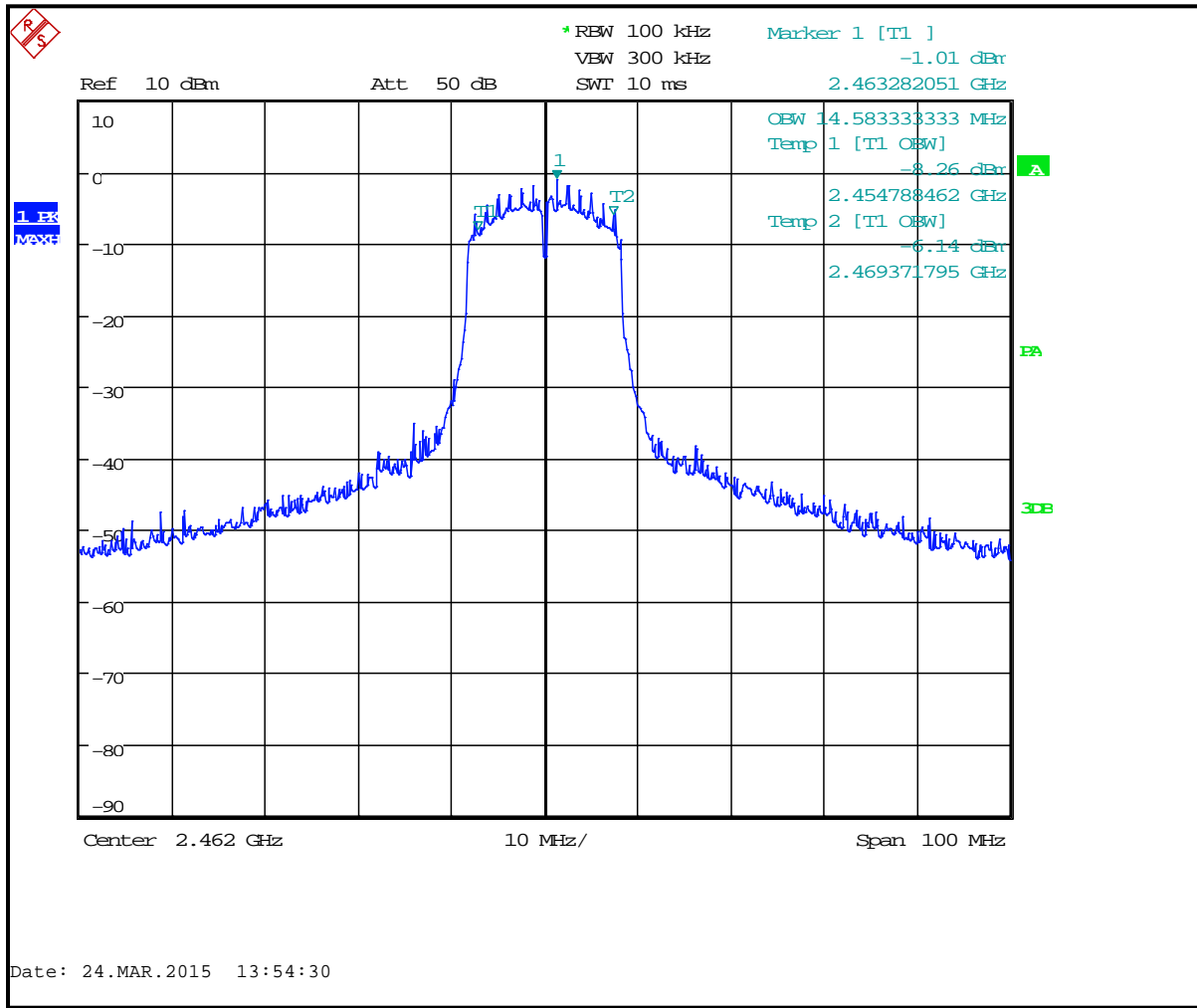

Plot 6-10: 6 dB Bandwidth Channel 8 (TX Frequency 2437 MHz-40 MHz BW) - 802.11n

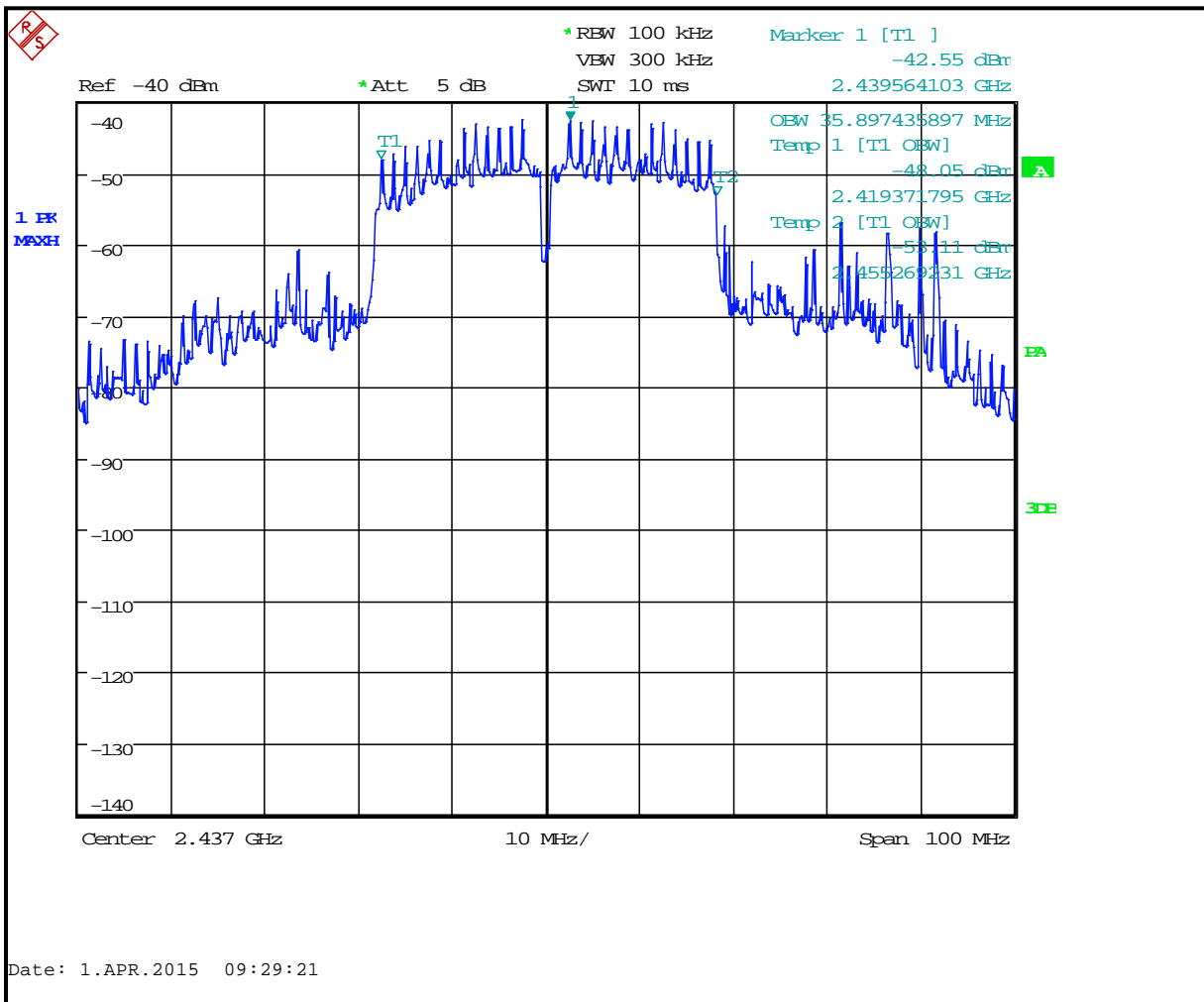

Test Personnel:

Daniel W. Baltzell
 Test Engineer

Daniel W. Baltzell
 Signature

March 15 - April 1, 2015
 Dates of Test

7 Power Spectral Density – FCC 15.247(e); RSS-247 5.2(b)

7.1 Power Spectral Density Test Procedure

The power spectral density per FCC 15.247(e) was measured using a 50-ohm spectrum analyzer with the resolution bandwidth set at 3 kHz, the video bandwidth set at 10 kHz, and the auto sweep time. The spectral lines were resolved for the modulated carriers at 2412 MHz, 2437 MHz, 2462 MHz, 5745 MHz, 5785 MHz, and 5825 MHz respectively. These levels are below the +8 dBm limit. See the power spectral density table and plots.

Table 7-1: Power Spectral Density Test Equipment

RTL Asset #	Manufacturer	Model	Part Type	Serial Number	Calibration Due Date
901581	Rohde & Schwarz	FSU	Spectrum Analyzer	1166.1660.50	11/13/15

7.2 Power Spectral Density Test Data – DSSS WLAN

Table 7-2: Power Spectral Density Test Data – 802.11b (2 Mbps)

Channel	Frequency (MHz)	RF Power Level (dBm)	Maximum Limit +8dBm	Pass/Fail
1	2412	-6.6	8	Pass
6	2437	-8.2	8	Pass
11	2462	-7.7	8	Pass

Table 7-3: Power Spectral Density Test Data – 802.11g (18 Mbps)

Channel	Frequency (MHz)	RF Power Level (dBm)	Maximum Limit +8dBm	Pass/Fail
1	2412	-14.5	8	Pass
6	2437	-18.1	8	Pass
11	2462	-17.2	8	Pass

Table 7-4: Power Spectral Density Test Data – 802.11n (13 Mbps-20MHz BW)

Channel	Frequency (MHz)	RF Power Level (dBm)	Maximum Limit +8dBm	Pass/Fail
1	2412	-17.0	8	Pass
6	2437	-15.3	8	Pass
11	2462	-17.6	8	Pass

Table 7-5: Power Spectral Density Test Data – 802.11n (40 MHz BW)

Channel	Frequency (MHz)	RF Power Level (dBm)	Maximum Limit +8dBm	Pass/Fail
5	2442	-18.2	8	Pass

Plot 7-1: Power Spectral Density: Channel 1 (2412 MHz); 802.11b (2 Mbps)

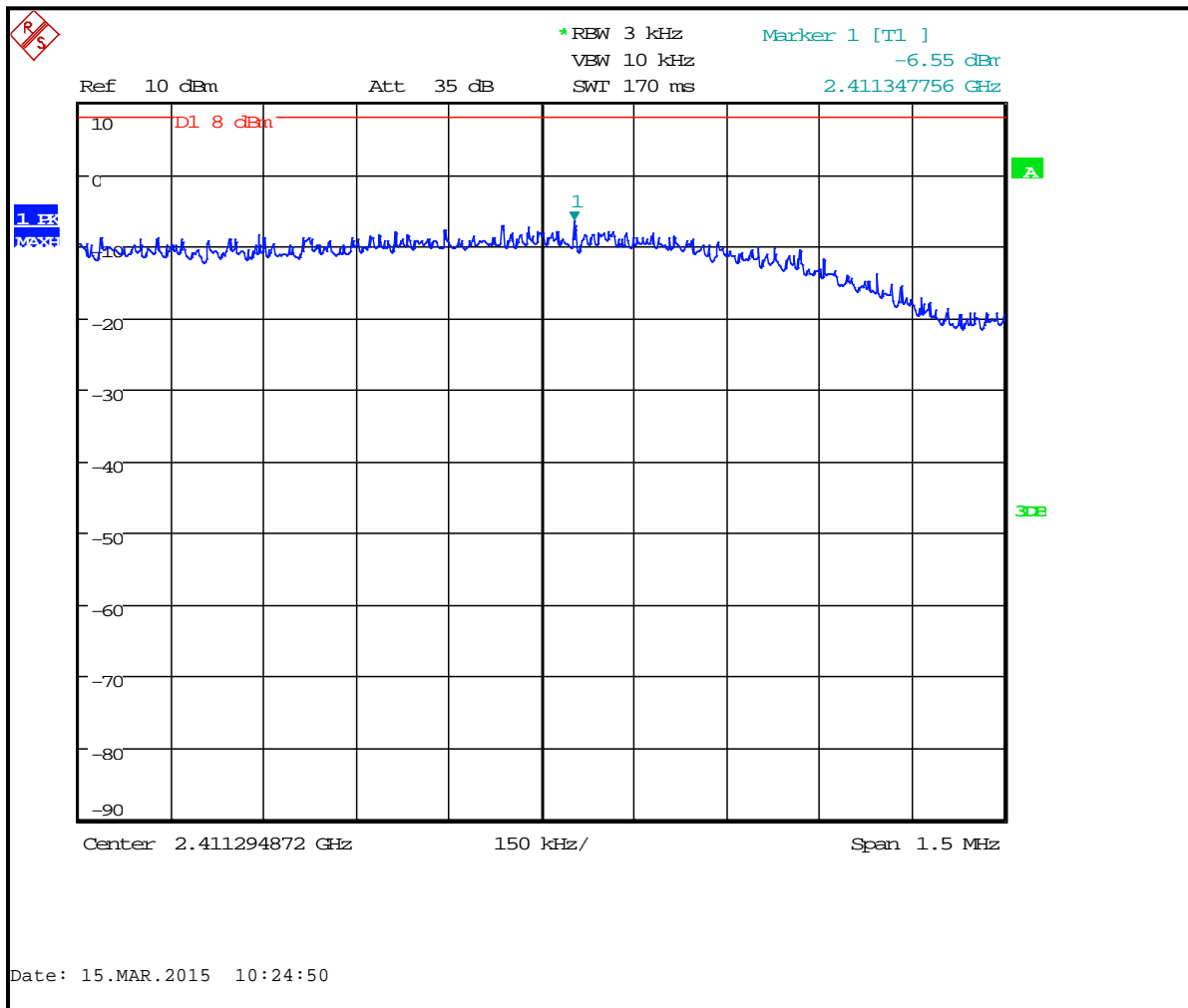

Plot 7-2: Power Spectral Density: Channel 6 (2437 MHz); 802.11b (2 Mbps)

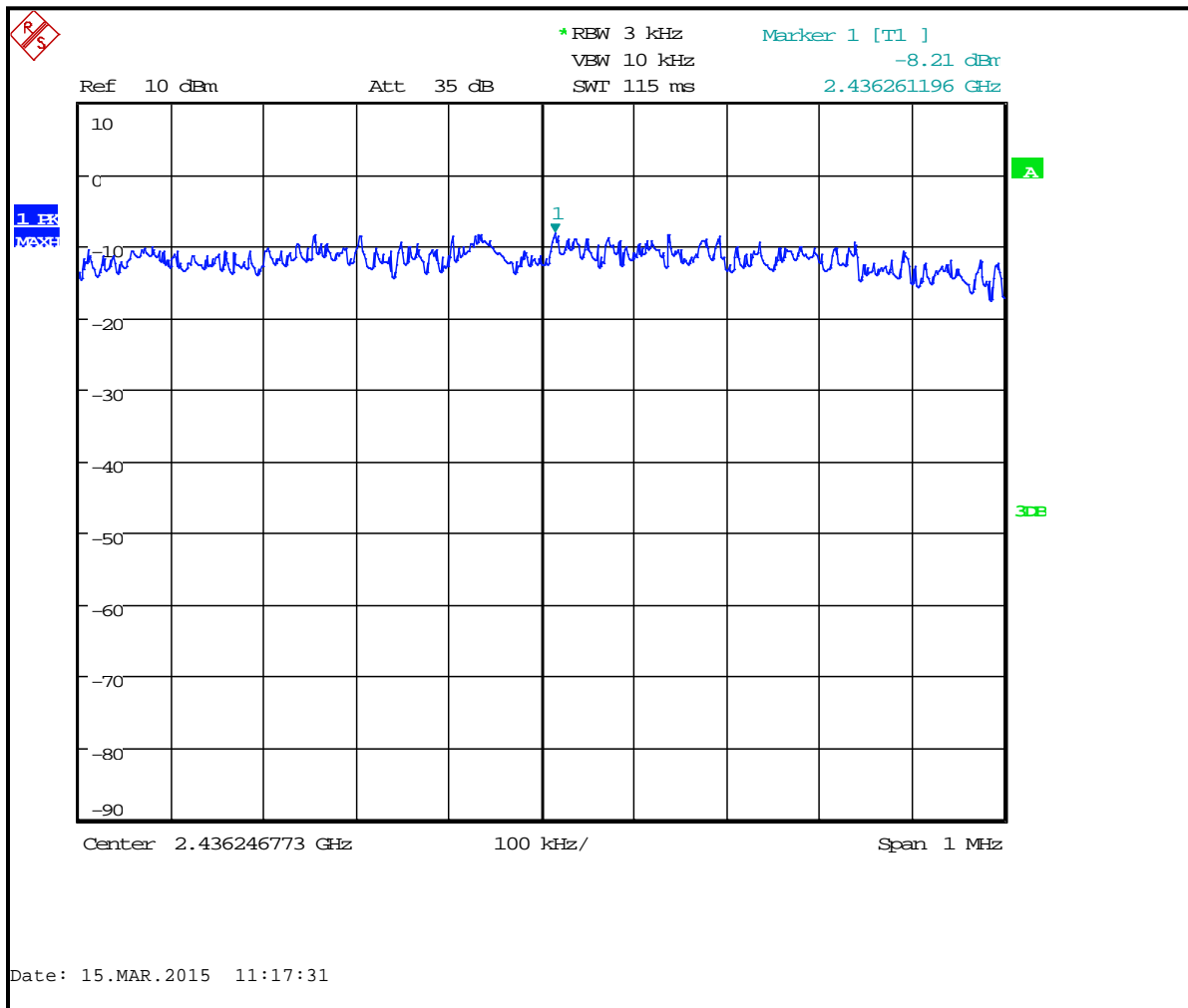

Plot 7-3: Power Spectral Density: Channel 11 (2462 MHz); 802.11b (2 Mbps)

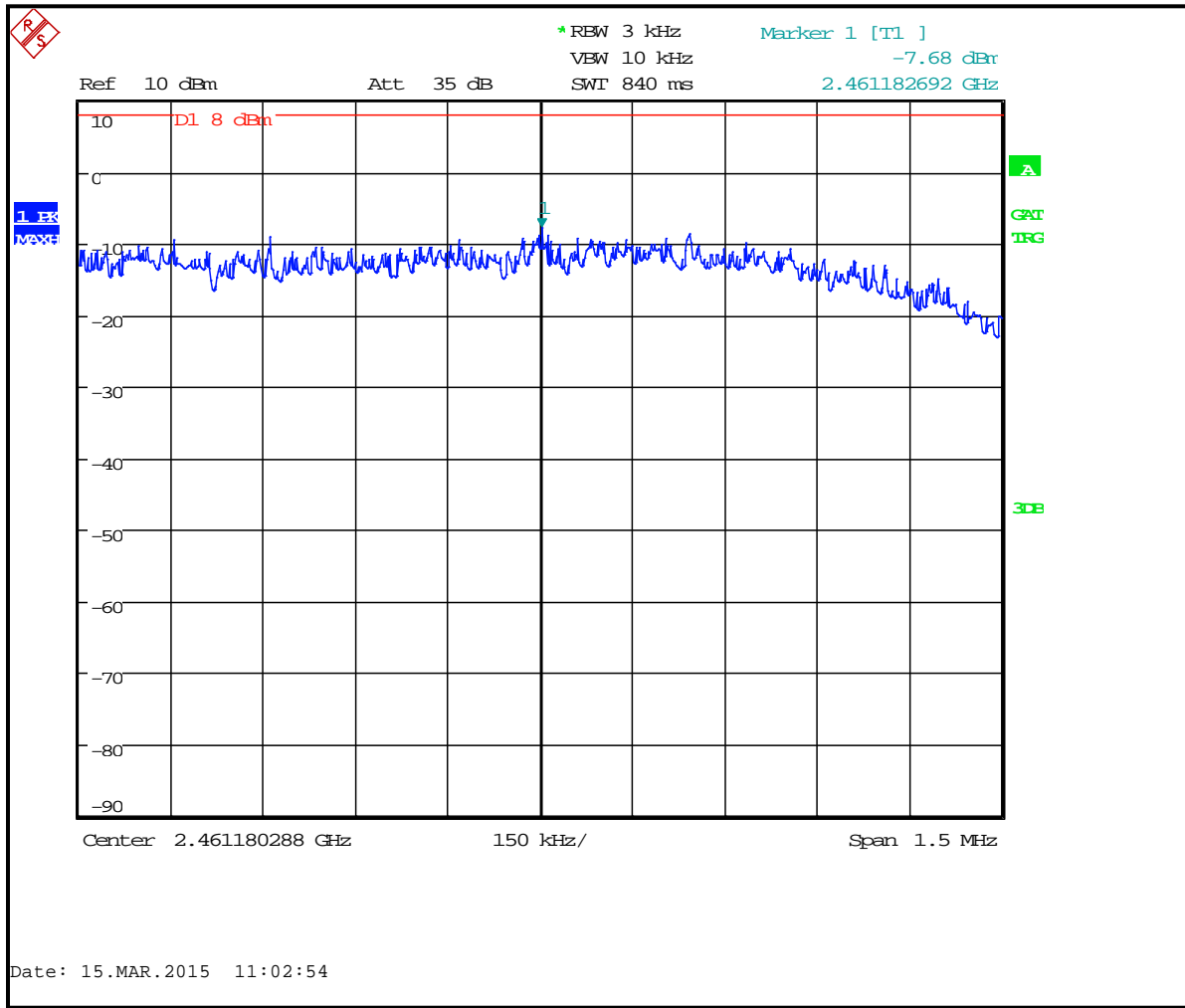

Plot 7-4: Power Spectral Density: Channel 1 (2412 MHz); 802.11g (18 Mbps)

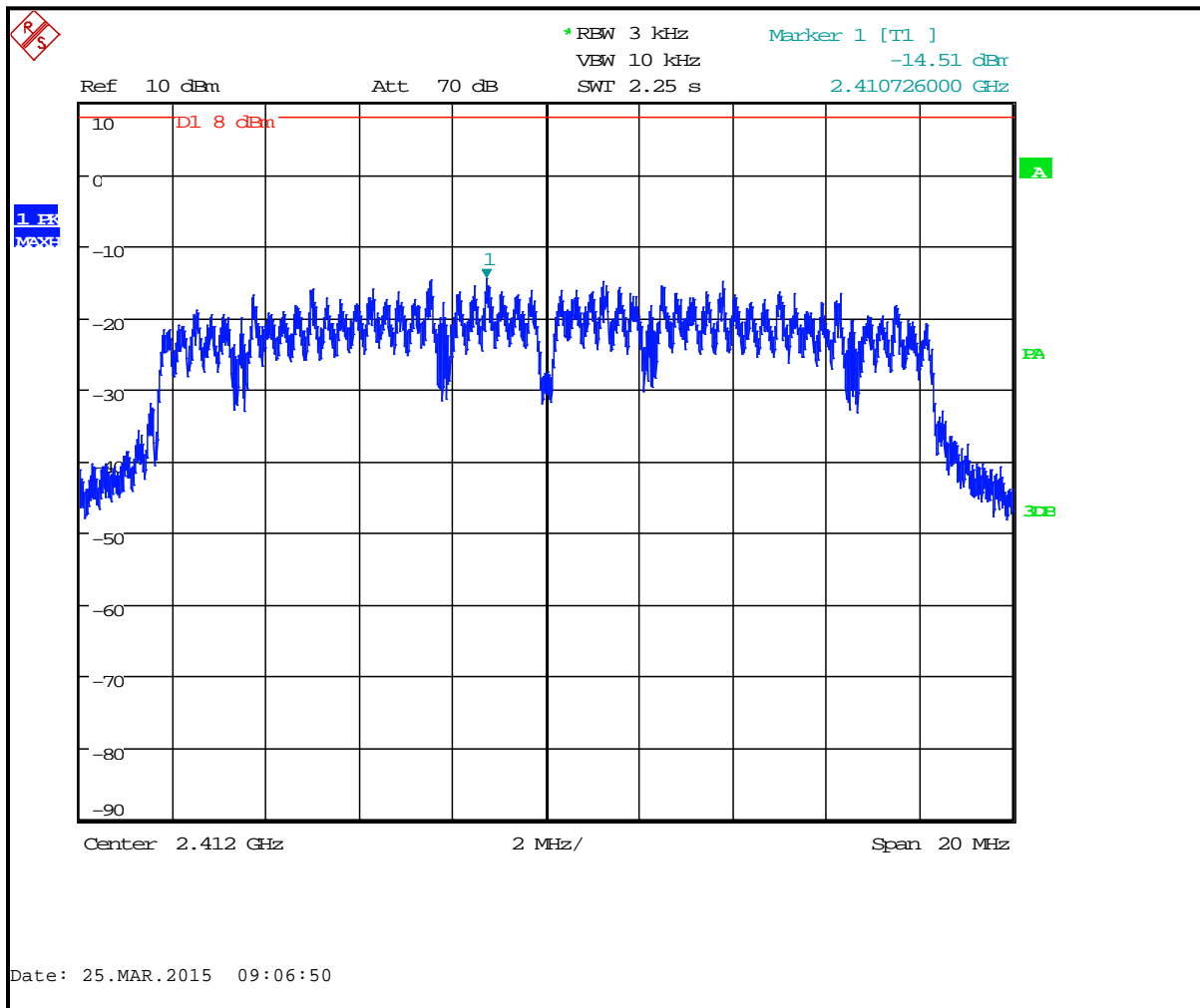

Plot 7-5: Power Spectral Density: Channel 6 (2437 MHz); 802.11g (18 Mbps)

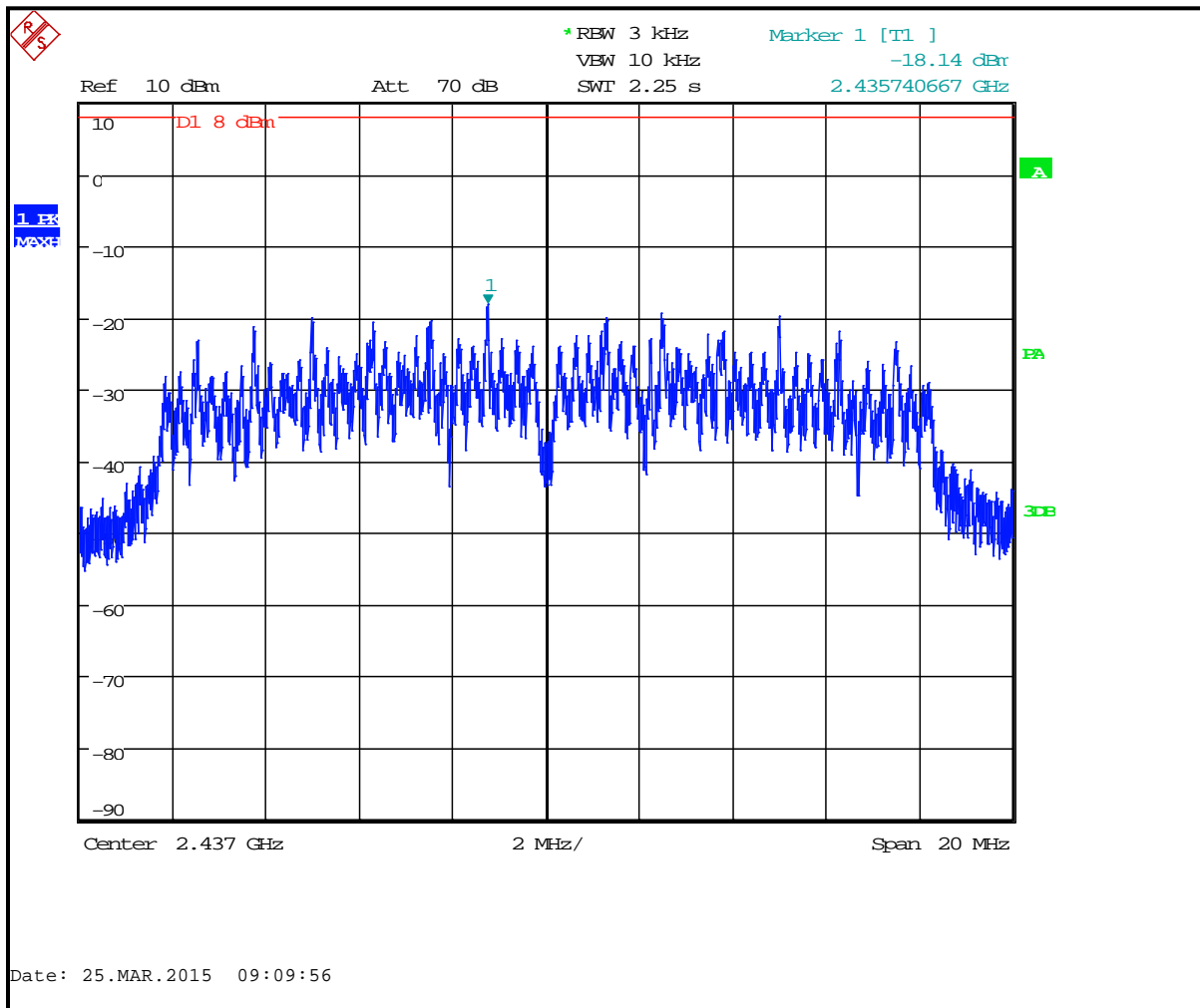

Plot 7-6: Power Spectral Density: Channel 11 (2462 MHz); 802.11g (18 Mbps)

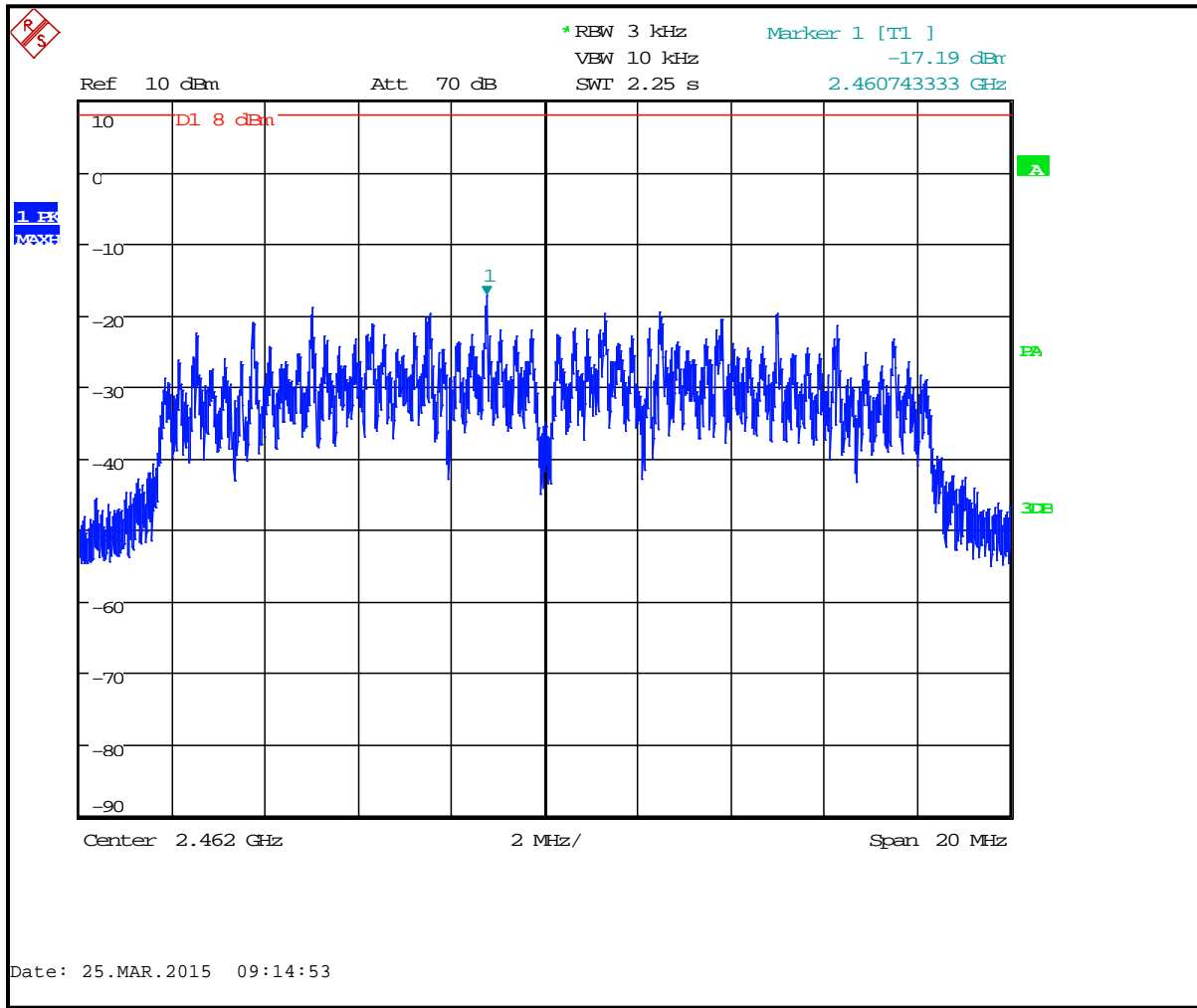

Plot 7-7: Power Spectral Density: Channel 1 (2412 MHz); 802.11n (13 Mbps)

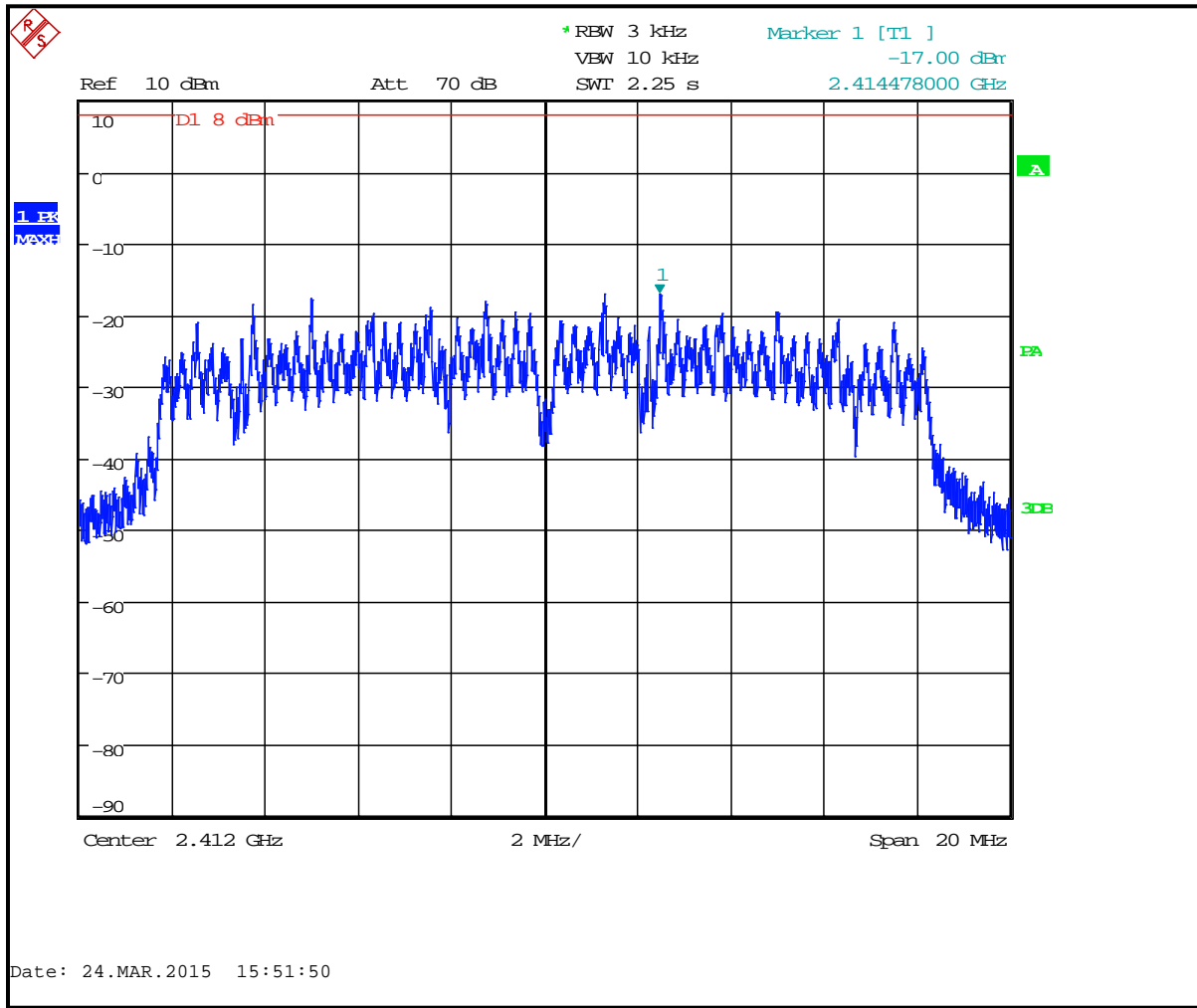

Plot 7-8: Power Spectral Density: Channel 6 (2437 MHz); 802.11n (13 Mbps)

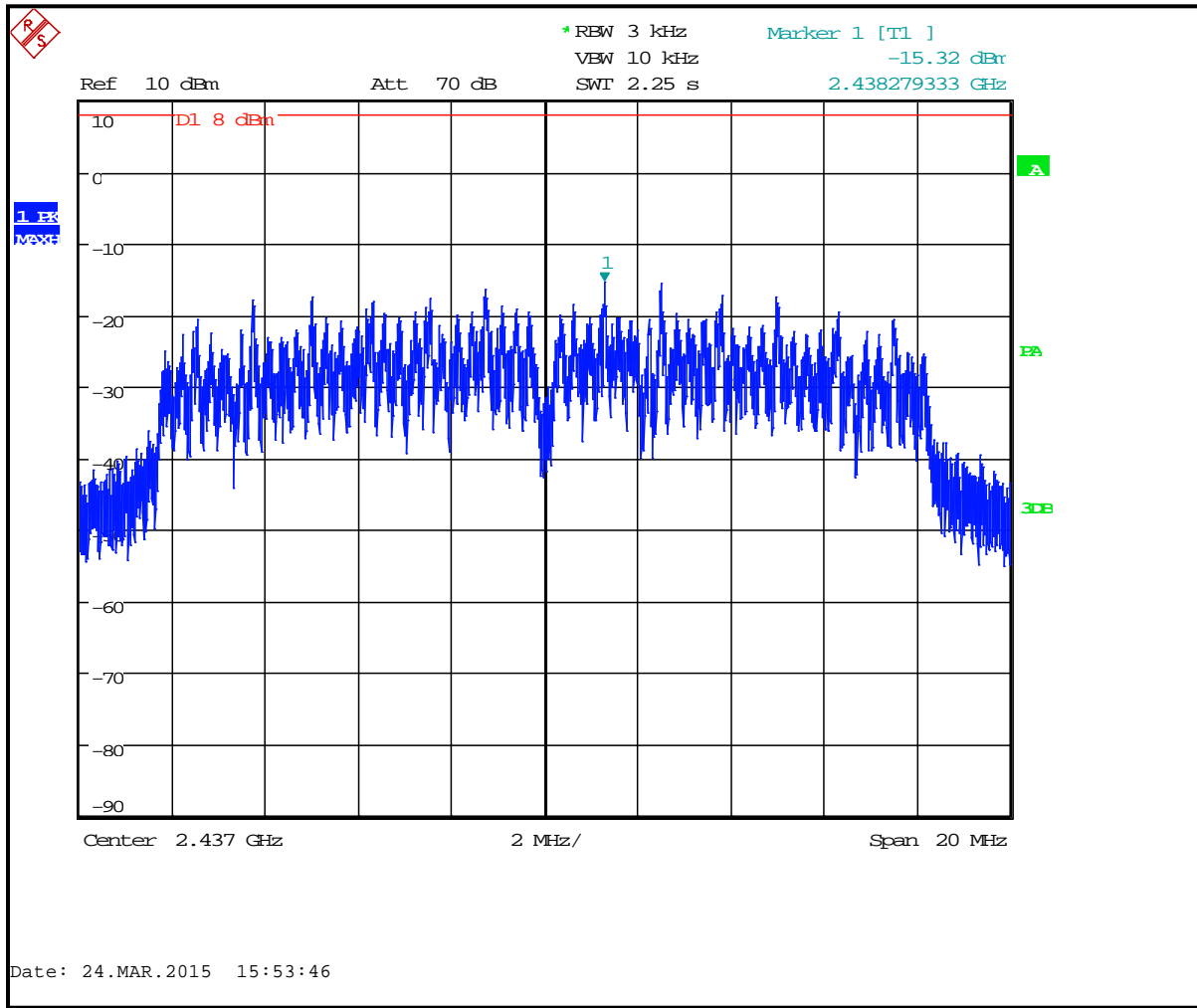

Plot 7-9: Power Spectral Density: Channel 11 (2462 MHz); 802.11n (13 Mbps)

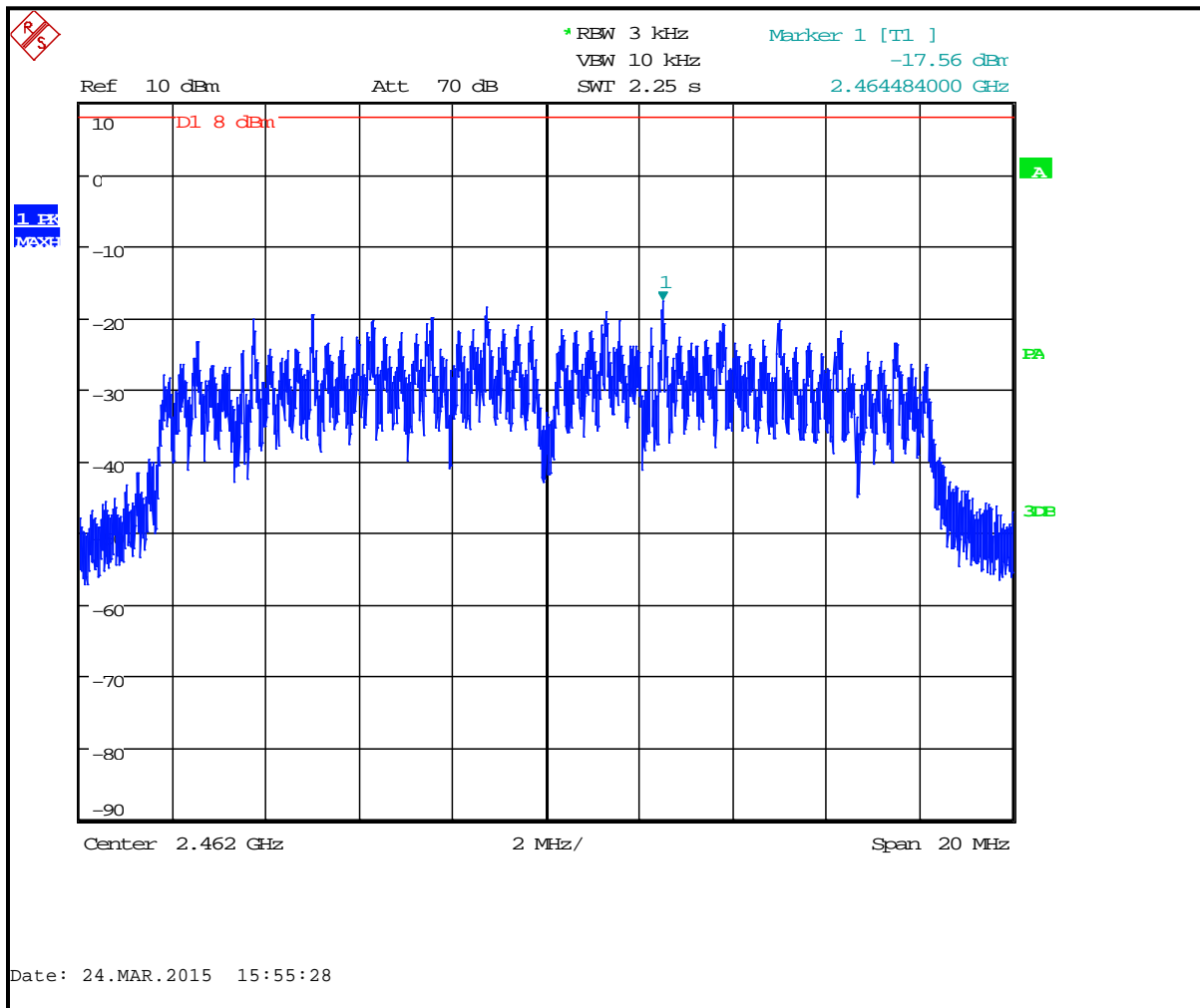

Plot 7-10: Power Spectral Density: Channel 5 (2442 MHz); 802.11n (40MHz BW)

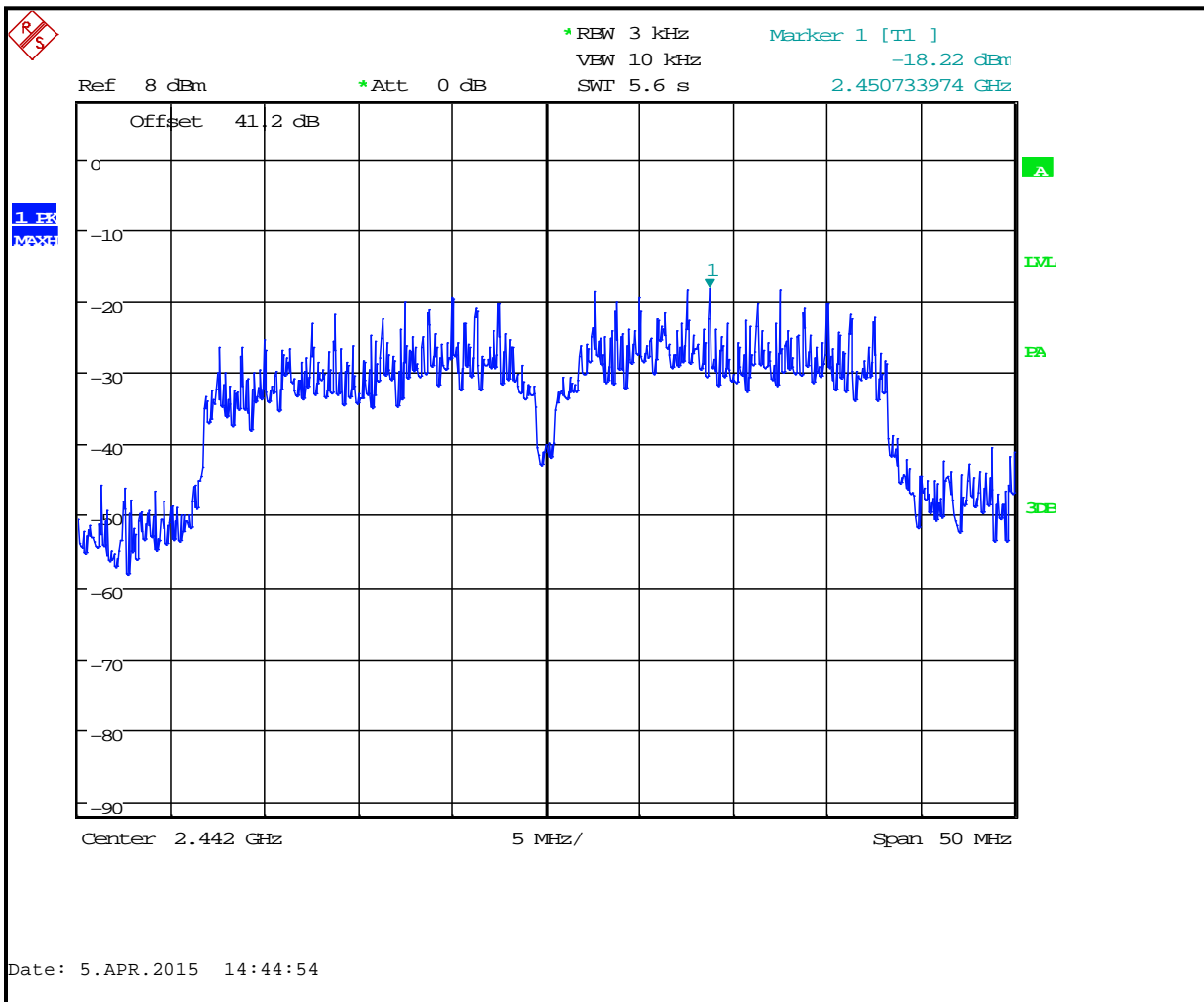

Test Personnel:

Daniel W. Baltzell
 Test Engineer

Daniel W. Baltzell
 Signature

March 15-April 5, 2015
 Dates of Test

8 Radiated Emissions – FCC 15.209; RSS-247 5.5 and RSS-Gen

8.1 Limits of Radiated Emissions Measurement

Frequency (MHz)	Field Strength (uV/m)	Measurement Distance (m)
0.009-0.490	2400/f (kHz)	300
0.490-1.705	2400/f (kHz)	30
1.705-30.0	30	30
30-88	100	3
88-216	150	3
216-960	200	3
Above 960	500	3

As shown in 15.35(b), for frequencies above 1000 MHz, the field strength limits are based on average detector, however, the peak field strength of any emission shall not exceed the maximum permitted average limits, specified above by more than 20 dB under any circumstances of modulation.

8.2 Radiated Emissions Measurement Test Procedure

Procedure: C63.10-2013 6.5, 6.6

Before final measurements of radiated emissions were made on the open-field three/ten meter range, the EUT was scanned indoors at one and three meter distances. This was done in order to determine its emissions spectrum signature. The physical arrangement of the test system and associated cabling was varied in order to determine the effect on the EUT's emissions in amplitude, direction and frequency. This process was repeated during final radiated emissions measurements on the open-field range, at each frequency, in order to ensure that maximum emission amplitudes were attained.

Final radiated emissions measurements were made on the three/ten-meter, open-field test site. The EUT was placed on a nonconductive turntable 0.8 meters above the ground plane. The spectrum was examined from 9 kHz to the 10th harmonic of the highest fundamental transmitter frequency.

At each frequency, the EUT was rotated 360°, and the antenna was raised and lowered from 1 to 4 meters in order to determine the emission's maximum level. Measurements were taken using both horizontal and vertical antenna polarizations. For frequencies between 30 and 1000 MHz, the spectrum analyzer's 6 dB bandwidth was set to 120 kHz, and the analyzer was operated in the CISPR quasi-peak detection mode. For emissions above 1,000 MHz, emissions are measured using the average detector function with a minimum resolution bandwidth of 1 MHz. No video filter less than 10 times the resolution bandwidth was used. The highest emission amplitudes relative to the appropriate limit were measured and recorded in this report.

Table 8-1: Radiated Emissions Test Equipment

RTL Asset #	Manufacturer	Model	Part Type	Serial Number	Calibration Due Date
900878	Rhein Tech Laboratories, Inc.	AM3-1197-0005	3 meter antenna mast, polarizing	OATS1	N/A
901592	Insulated Wire Inc.	KPS-1503-3600-KPR	SMK RF Cables 20'	NA	9/3/15
901593	Insulated Wire Inc.	KPS-1503-360-KPR	SMK RF Cables 36"	NA	9/3/15
901594	Insulated Wire Inc.	KPS-1503-360-KPR	SMK RF Cables 36"	NA	9/3/15
901242	Rhein Tech Laboratories, Inc.	WRT-000-0003	Wood rotating table	N/A	N/A
900791	Chase	CBL6111B	Bilog Antenna (30 MHz – 2000 MHz)	N/A	6/11/17
901218	EMCO	3160-09	Horn Antenna (18 - 26.5 GHz)	960281-003	4/14/18
900772	EMCO	3161-02	Horn Antenna (2 - 4 GHz)	9804-1044	4/09/18
900321	EMCO	3161-03	Horn Antennas (4 – 8.2 GHz)	9508-1020	4/09/18
900323	EMCO	3160-07	Horn Antennas (8.2 – 12.4 GHz)	9605-1054	4/09/18
900356	EMCO	3160-08	Horn Antennas (12.4 – 18 GHz)	9607-1044	4/09/18
901581	Rohde & Schwarz	FSU	Spectrum Analyzer	1166.1660.50	11/13/15

8.3 Radiated Emissions Test Results

8.3.1 Radiated Emissions Harmonics/Spurious

Table 8-2: 2412 MHz; 802.11b; 2 Mbps; Channel 1; Average Mode

Frequency (MHz)	Spectrum Analyzer Average Level (1 MHz RBW/ 10 Hz VBW) (dBuV)	Site Correction Factor (dB/m)	Corrected Average Level (dBuV/m)	Limit (dBuV/m)	Margin (dB)
4824	17.7	33.2	50.9	54.0	-3.1
12060	-7.9	44.0	36.1	54.0	-17.9
14472	-14.8	47.9	33.1	54.0	-20.9
19296	-9.7	52.9	43.2	54.0	-10.8

Table 8-3: 2437 MHz; 802.11b; 2 Mbps; Channel 6; Average Mode

Frequency (MHz)	Spectrum Analyzer Average Level (1 MHz RBW/ 10 Hz VBW) (dBuV)	Site Correction Factor (dB/m)	Corrected Average Level (dBuV/m)	Limit (dBuV/m)	Margin (dB)
4874	11.1	33.3	44.4	54.0	-9.6
7311	0.6	35.7	36.3	54.0	-17.7
12185	-8.7	44.0	35.3	54.0	-18.7
19496	-10.2	53.0	42.8	54.0	-11.2

Table 8-4: 2462 MHz; 802.11b; 2 Mbps; Channel 11; Average Mode

Frequency (MHz)	Spectrum Analyzer Average Level (1 MHz RBW/ 10 Hz VBW) (dBuV)	Site Correction Factor (dB/m)	Corrected Average Level (dBuV/m)	Limit (dBuV/m)	Margin (dB)
4924	6.9	33.4	40.3	54.0	-13.7
7386	0.2	35.7	35.9	54.0	-18.1
12310	-8.6	44.0	35.4	54.0	-18.6
19696	-9.9	53.1	43.2	54.0	-10.8
22158	-11.7	54.2	42.5	54.0	-11.5

Table 8-5: 2412 MHz; 802.11g; 11 Mbps; Channel 1; Average Mode

Frequency (MHz)	Spectrum Analyzer Average Level (1 MHz RBW/ 10 Hz VBW) (dBuV)	Site Correction Factor (dB/m)	Corrected Average Level (dBuV/m)	Limit (dBuV/m)	Margin (dB)
4824	5.6	33.2	38.8	54.0	-15.2
12060	0.3	44.0	44.3	54.0	-9.7
14472	-4.1	47.9	43.8	54.0	-10.2
19296	-6.7	52.9	46.2	54.0	-7.8

Table 8-6: 2437 MHz; 802.11g; 11 Mbps; Channel 6; Average Mode

Frequency (MHz)	Spectrum Analyzer Average Level (1 MHz RBW/ 10 Hz VBW) (dBuV)	Site Correction Factor (dB/m)	Corrected Average Level (dBuV/m)	Limit (dBuV/m)	Margin (dB)
4874	5.7	33.3	39.0	54.0	-15.0
7311	0.1	35.7	35.8	54.0	-18.2
12185	0.5	44.0	44.5	54.0	-9.5
19496	-9.3	53.0	43.7	54.0	-10.3

Table 8-7: 2462 MHz; 802.11g; 11 Mbps; Channel 11; Average Mode

Frequency (MHz)	Spectrum Analyzer Average Level (1 MHz RBW/ 10 Hz VBW) (dBuV)	Site Correction Factor (dB/m)	Corrected Average Level (dBuV/m)	Limit (dBuV/m)	Margin (dB)
4924	3.0	33.4	36.4	54.0	-17.6
7386	0.1	35.7	35.8	54.0	-18.2
12310	0.1	44.0	44.1	54.0	-9.9
19696	-9.3	53.1	43.8	54.0	-10.2
22158	-8.2	54.2	46.0	54.0	-8.0

Table 8-8: 2412 MHz; 802.11n; 65 Mbps; Channel 1; Average Mode

Frequency (MHz)	Spectrum Analyzer Average Level (1 MHz RBW/ 10 Hz VBW) (dBuV)	Site Correction Factor (dB/m)	Corrected Average Level (dBuV/m)	Limit (dBuV/m)	Margin (dB)
4824	1.9	33.2	35.1	54.0	-18.9
12060	0.3	44.0	44.3	54.0	-9.7
14472	-9.8	47.9	38.1	54.0	-15.9
19296	-9.4	52.9	43.5	54.0	-10.5

Table 8-9: 2437 MHz; 802.11n; 65 Mbps; Channel 6; Average Mode

Frequency (MHz)	Spectrum Analyzer Average Level (1 MHz RBW/ 10 Hz VBW) (dBuV)	Site Correction Factor (dB/m)	Corrected Average Level (dBuV/m)	Limit (dBuV/m)	Margin (dB)
4874	1.8	33.3	35.1	54.0	-18.9
7311	-0.2	35.7	35.5	54.0	-18.5
12185	-0.3	44.0	43.7	54.0	-10.3
19496	-9.2	53.0	43.8	54.0	-10.2

Table 8-10: 2462 MHz; 802.11n; 65 Mbps; Channel 11; Average Mode

Frequency (MHz)	Spectrum Analyzer Average Level (1 MHz RBW/ 10 Hz VBW) (dBuV)	Site Correction Factor (dB/m)	Corrected Average Level (dBuV/m)	Limit (dBuV/m)	Margin (dB)
4924	1.4	33.4	34.8	54.0	-19.2
7386	0.0	35.7	35.7	54.0	-18.3
12310	-0.6	44.0	43.4	54.0	-10.6
19696	-9.2	53.1	43.9	54.0	-10.1
22158	-8.4	54.2	45.8	54.0	-8.2
4924	1.4	33.4	34.8	54.0	-19.2

Table 8-11: 2412 MHz; 802.11b; 2 Mbps; Channel 1; Peak Mode

Frequency (MHz)	Spectrum Analyzer Peak Level (1 MHz RBW/ 3 MHz VBW) (dBuV)	Site Correction Factor (dB/m)	Corrected Peak Level (dBuV/m)	Limit (dBuV/m)	Margin (dB)
4824	21.6	33.2	54.8	74.0	-19.2
12060	4.4	44.0	48.4	74.0	-25.6
14472	4.8	47.9	52.7	74.0	-21.3
19296	2.4	52.9	55.3	74.0	-18.7

Table 8-12: 2437 MHz; 802.11b; 2 Mbps; Channel 6; Peak Mode

Frequency (MHz)	Spectrum Analyzer Peak Level (1 MHz RBW/ 3 MHz VBW) (dBuV)	Site Correction Factor (dB/m)	Corrected Peak Level (dBuV/m)	Limit (dBuV/m)	Margin (dB)
4874	17.7	33.3	51.0	74.0	-23.0
7311	12.8	35.7	48.5	74.0	-25.5
12185	1.2	44.0	45.2	74.0	-28.8
19496	1.2	53.0	54.2	74.0	-19.8

Table 8-13: 2462 MHz; 802.11b; 2 Mbps; Channel 11; Peak Mode

Frequency (MHz)	Spectrum Analyzer Peak Level (1 MHz RBW/ 3 MHz VBW) (dBuV)	Site Correction Factor (dB/m)	Corrected Peak Level (dBuV/m)	Limit (dBuV/m)	Margin (dB)
4924	15.1	33.4	48.5	74.0	-25.5
7386	13.6	35.7	49.3	74.0	-24.7
12310	1.3	44.0	45.3	74.0	-28.7
19696	0.4	53.1	53.5	74.0	-20.5
22158	-2.0	54.2	52.2	74.0	-21.8

Table 8-14: 2412 MHz; 802.11g; 11 Mbps; Channel 1; Peak Mode

Frequency (MHz)	Spectrum Analyzer Peak Level (1 MHz RBW/ 3 MHz VBW) (dBuV)	Site Correction Factor (dB/m)	Corrected Peak Level (dBuV/m)	Limit (dBuV/m)	Margin (dB)
4824	17.8	33.2	51.0	74.0	-23.0
12060	13.5	44.0	57.5	74.0	-16.5
14472	6.2	47.9	54.1	74.0	-19.9
19296	5.3	52.9	58.2	74.0	-15.8

Table 8-15: 2437 MHz; 802.11g; 11 Mbps; Channel 6; Peak Mode

Frequency (MHz)	Spectrum Analyzer Peak Level (1 MHz RBW/ 3 MHz VBW) (dBuV)	Site Correction Factor (dB/m)	Corrected Peak Level (dBuV/m)	Limit (dBuV/m)	Margin (dB)
4874	18.0	33.3	51.3	74.0	-22.7
7311	13.5	35.7	49.2	74.0	-24.8
12185	13.3	44.0	57.3	74.0	-16.7
19496	4.0	53.0	57.0	74.0	-17.0

Table 8-16: 2462 MHz; 802.11g; 11 Mbps; Channel 11; Peak Mode

Frequency (MHz)	Spectrum Analyzer Peak Level (1 MHz RBW/ 3 MHz VBW) (dBuV)	Site Correction Factor (dB/m)	Corrected Peak Level (dBuV/m)	Limit (dBuV/m)	Margin (dB)
4924	13.5	33.4	46.9	74.0	-27.1
7386	13.4	35.7	49.1	74.0	-24.9
12310	13.1	44.0	57.1	74.0	-16.9
19696	4.0	53.1	57.1	74.0	-16.9
22158	5.3	54.2	59.5	74.0	-14.5

Table 8-17: 2412 MHz; 802.11n; 65 Mbps; Channel 1; Peak Mode

Frequency (MHz)	Spectrum Analyzer Peak Level (1 MHz RBW/ 3 MHz VBW) (dBuV)	Site Correction Factor (dB/m)	Corrected Peak Level (dBuV/m)	Limit (dBuV/m)	Margin (dB)
4824	16.5	33.2	49.7	74.0	-24.3
12060	13.3	44.0	57.3	74.0	-16.7
14472	3.3	47.9	51.2	74.0	-22.8
19296	3.8	52.9	56.7	74.0	-17.3

Table 8-18: 2437 MHz; 802.11n; 65 Mbps; Channel 6; Peak Mode

Frequency (MHz)	Spectrum Analyzer Peak Level (1 MHz RBW/ 3 MHz VBW) (dBuV)	Site Correction Factor (dB/m)	Corrected Peak Level (dBuV/m)	Limit (dBuV/m)	Margin (dB)
4874	14.6	33.3	47.9	74.0	-26.1
7311	13.2	35.7	48.9	74.0	-25.1
12185	12.6	44.0	56.6	74.0	-17.4
19496	3.9	53.0	56.9	74.0	-17.1

Table 8-19: 2462 MHz; 802.11n; 65 Mbps; Channel 11; Peak Mode

Frequency (MHz)	Spectrum Analyzer Peak Level (1 MHz RBW/ 3 MHz VBW) (dBuV)	Site Correction Factor (dB/m)	Corrected Peak Level (dBuV/m)	Limit (dBuV/m)	Margin (dB)
4924	13.1	33.4	46.5	74.0	-27.5
7386	13.1	35.7	48.8	74.0	-25.2
12310	11.8	44.0	55.8	74.0	-18.2
19696	4.1	53.1	57.2	74.0	-16.8
22158	4.9	54.2	59.1	74.0	-14.9

Test Personnel:

Daniel W. Baltzell
 EMC Test Engineer

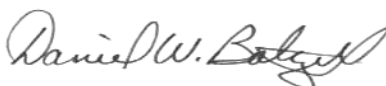

Signature

March 29, 2015
 Date of Test

Rhein Tech Laboratories, Inc.
360 Herndon Parkway
Suite 1400
Herndon, VA 20170
<http://www.rheintech.com>

Client: Harris Corporation
Model: XL-185P
Standards: FCC 15.247/IC RSS-247
ID's: OWDTR-0147-E/3636B-0147
Report #: 2017069DTS

9 Conclusion

The data in this measurement report shows that the Harris Corporation Model XL-185P, FCC ID: OWDTR-0147-E, IC: 3636B-0147, complies with the applicable intentional radiated requirements of FCC Parts 2 and 15 and Industry Canada RSS-Gen and RSS-247.