



Engineering Solutions & Electromagnetic Compatibility Services

**FCC Part 15.247 & Industry Canada RSS-247 Test Report**

<b>Test Lab:</b> Rhein Tech Laboratories, Inc.    Tel: 703-689-0368 360 Herndon Parkway                Fax: 703-689-2056 Suite 1400                                www.rheintech.com Herndon, VA 20170 E-Mail: atcbinfo@rheintech.com		<b>Applicant:</b> Harris Corporation 221 Jefferson Ridge Parkway Lynchburg, VA 24501 Tel: 434-455-9290	
<b>FCC ID/ IC</b>	OWDTR-0146-E 3636B-0146	<b>Test Report Date:</b>	March 1, 2017
<b>Platform</b>	N/A	<b>RTL Work Order #</b>	2017007
<b>Model</b>	XL-200P C1D1 Non-Rebanded	<b>RTL Quote #</b>	QRTL17-007A
<b>American National Standard Institute</b>	ANSI C63.10-2013: American National Standard of Procedures for Compliance Testing of Unlicensed Wireless Devices		
<b>FCC Classification</b>	DTS – Part 15 Digital Transmission System		
<b>FCC Rule Part(s)/Guidance</b>	FCC Rules Part 15.247: Operation within the bands 902-928 MHz, 2400-2483.5 MHz and 5725-5850 MHz Direct Sequence System (10/01/2015)		
<b>Industry Canada</b>	RSS-247 Issue 2 Digital Transmission Systems (DTSs), Frequency Hopping Systems (FHSs) and Licence-Exempt Local Area Network (LE-LAN) Devices		
<b>Digital Interface Information</b>	Digital Interface was found to be compliant		
<b>Frequency Range (MHz)</b>	<b>Output Power (W)*</b>	<b>Frequency Tolerance</b>	<b>Emission Designator</b>
2412 – 2462	0.234	N/A	14M7FXD

\* power is conducted

I, the undersigned, hereby declare that the equipment tested and referenced in this report conforms to the identified standard(s) as described in this test report. No modifications were made to the equipment during testing in order to achieve compliance with these standards. Furthermore, there was no deviation from, additions to, or exclusions from, the applicable parts of FCC Part 2, FCC Part 15, Industry Canada RSS-247, RSS-Gen, and ANSI C63.10.

Signature: 

Date: March 1, 2017

Typed/Printed Name: Desmond A. Fraser

Position: President

*This report may not be reproduced, except in full, without the full written approval of Rhein Tech Laboratories, Inc. and Harris Corporation. Test results relate only to the item(s) tested.*

*These test(s) are accredited under Rhein Tech Laboratories, Inc. ISO/IEC 17025 accreditation issued by ANAB. Refer to certificate and scope of accreditation AT-1445.*

## Table of Contents

---

1	General Information.....	5
1.1	Scope .....	5
1.2	Description of EUT.....	5
1.3	Test Facility.....	5
1.4	Related Submittal(s)/Grant(s).....	5
1.5	Modifications.....	5
2	Test Information .....	6
2.1	Description of Test Modes.....	6
2.2	Exercising the EUT .....	6
2.3	Test Result Summary.....	6
2.4	Test System Details.....	7
3	Peak Output Power – FCC 15.247(b)(1); RSS-247 5.4(4) .....	9
3.1	Power Output Test Procedure .....	9
3.2	Power Output Test Data.....	9
4	Compliance with the Band Edge – FCC 15.247(d); RSS-247 5.5 .....	10
4.1	Band Edge Test Procedure .....	10
4.1.1	Lower Band Edge – 802.11b .....	11
4.1.2	Upper Band Edge – 802.11b .....	12
4.1.3	Lower Band Edge – 802.11g .....	13
4.1.4	Upper Band Edge – 802.11g .....	14
4.1.5	Lower Band Edge – 802.11n .....	15
4.1.6	Upper Band Edge – 802.11n .....	16
4.1.7	Lower Band Edge – 802.11n (40 MHz BW).....	17
4.1.8	Upper Band Edge – 802.11n (40 MHz BW).....	18
5	Antenna Conducted Spurious Emissions – FCC 15.247(d); RSS-247 5.5.....	19
5.1	Antenna Conducted Spurious Emissions Test Procedures .....	19
5.2	Antenna Conducted Spurious Emissions Test Results.....	19
6	Bandwidth – FCC 15.247(a)(2); RSS-247 5.2(1) .....	20
6.1	6 dB Bandwidth Test Procedure .....	20
6.2	6 dB Bandwidth Test Results .....	20
7	Power Spectral Density – FCC 15.247(e); RSS-247 5.2(2).....	31
7.1	Power Spectral Density Test Procedure .....	31
7.2	Power Spectral Density Test Data – DSSS WLAN.....	31
8	Radiated Emissions – FCC 15.209; RSS-247 2.2 and RSS-Gen.....	42
8.1	Limits of Radiated Emissions Measurement .....	42
8.2	Radiated Emissions Measurement Test Procedure .....	42
8.3	Radiated Emissions Test Results .....	44
8.3.1	Radiated Emissions Harmonics/Spurious.....	44
9	Conclusion .....	50

## Table Index

---

Table 2-1:	Channels Tested for DSSS – 802.11b (2 Mbps); 802.11g (12 Mbps).....	6
Table 2-2:	Test Result Summary – FCC Part 15, Subpart C (Section 15.247), IC RSS-247/RSS-Gen 6	
Table 2-3:	Equipment Under Test.....	7
Table 2-4:	Accessory Test Equipment.....	7
Table 3-1:	Power Output Test Equipment.....	9
Table 3-2:	Power Output Test Data – 802.11b.....	9
Table 3-3:	Power Output Test Data – 802.11g.....	9
Table 3-4:	Power Output Test Data – 802.11n.....	9
Table 4-1:	Band Edge Test Equipment.....	10
Table 5-1:	Antenna Conducted Spurious Test Equipment.....	19
Table 6-1:	6 dB Bandwidth Test Equipment.....	20
Table 6-2:	6 dB Bandwidth Test Data – 802.11b (2 Mbps).....	20
Table 6-3:	6 dB Bandwidth Test Data – 802.11g (18 Mbps).....	20
Table 6-4:	6 dB Bandwidth Test Data – 802.11n (6.5 Mbps-20 MHz BW).....	20
Table 6-5:	6 dB Bandwidth Test Data – 802.11n (40 MHz BW).....	20
Table 7-1:	Power Spectral Density Test Equipment.....	31
Table 7-2:	Power Spectral Density Test Data – 802.11b (2 Mbps).....	31
Table 7-3:	Power Spectral Density Test Data – 802.11g (18 Mbps).....	31
Table 7-4:	Power Spectral Density Test Data – 802.11n (13 Mbps-20MHz BW).....	31
Table 7-5:	Power Spectral Density Test Data – 802.11n (40 MHz BW).....	31
Table 8-1:	Radiated Emissions Test Equipment.....	43
Table 8-2:	2412 MHz; 802.11b; 2 Mbps; Channel 1; Average Mode.....	44
Table 8-3:	2437 MHz; 802.11b; 2 Mbps; Channel 6; Average Mode.....	44
Table 8-4:	2462 MHz; 802.11b; 2 Mbps; Channel 11; Average Mode.....	44
Table 8-5:	2412 MHz; 802.11g; 11 Mbps; Channel 1; Average Mode.....	45
Table 8-6:	2437 MHz; 802.11g; 11 Mbps; Channel 6; Average Mode.....	45
Table 8-7:	2462 MHz; 802.11g; 11 Mbps; Channel 11; Average Mode.....	45
Table 8-8:	2412 MHz; 802.11n; 65 Mbps; Channel 1; Average Mode.....	46
Table 8-9:	2437 MHz; 802.11n; 65 Mbps; Channel 6; Average Mode.....	46
Table 8-10:	2462 MHz; 802.11n; 65 Mbps; Channel 11; Average Mode.....	46
Table 8-11:	2412 MHz; 802.11b; 2 Mbps; Channel 1; Peak Mode.....	47
Table 8-12:	2437 MHz; 802.11b; 2 Mbps; Channel 6; Peak Mode.....	47
Table 8-13:	2462 MHz; 802.11b; 2 Mbps; Channel 11; Peak Mode.....	47
Table 8-14:	2412 MHz; 802.11g; 11 Mbps; Channel 1; Peak Mode.....	48
Table 8-15:	2437 MHz; 802.11g; 11 Mbps; Channel 6; Peak Mode.....	48
Table 8-16:	2462 MHz; 802.11g; 11 Mbps; Channel 11; Peak Mode.....	48
Table 8-17:	2412 MHz; 802.11n; 65 Mbps; Channel 1; Peak Mode.....	49
Table 8-18:	2437 MHz; 802.11n; 65 Mbps; Channel 6; Peak Mode.....	49
Table 8-19:	2462 MHz; 802.11n; 65 Mbps; Channel 11; Peak Mode.....	49

---

### Plot Index

---

Plot 4-1:	In Band Emissions - Channel 1 (2412 MHz); 802.11b (2 Mbps).....	11
Plot 4-2:	In Band Emissions - Channel 11 (2462 MHz); 802.11b (2 Mbps).....	12
Plot 4-3:	In Band Emissions - Channel 1 (2412 MHz); 802.11g (12 Mbps).....	13
Plot 4-4:	In Band Emissions - Channel 11 (2462 MHz); 802.11g (12 Mbps).....	14
Plot 4-5:	In Band Emissions - Channel 1 (2412 MHz); 802.11n (65 Mbps).....	15
Plot 4-6:	In Band Emissions - Channel 11 (2462 MHz); 802.11n (65 Mbps).....	16
Plot 4-7:	In Band Emissions - Channel 5 (2422 MHz); 802.11n (65 Mbps).....	17
Plot 4-8:	In Band Emissions - Channel 7 (2432 MHz); 802.11n (40 MHz).....	18
Plot 6-1:	6 dB Bandwidth Channel 1 (TX Frequency 2412 MHz) - 802.11b.....	21
Plot 6-2:	6 dB Bandwidth Channel 6 (TX Frequency 2437 MHz) - 802.11b.....	22
Plot 6-3:	6 dB Bandwidth Channel 11 (TX Frequency 2462 MHz) - 802.11b.....	23
Plot 6-4:	6 dB Bandwidth Channel 1 (TX Frequency 2412 MHz) - 802.11g.....	24
Plot 6-5:	6 dB Bandwidth Channel 6 (TX Frequency 2437 MHz) - 802.11g.....	25
Plot 6-6:	6 dB Bandwidth Channel 11 (TX Frequency 2462 MHz) - 802.11g.....	26
Plot 6-7:	6 dB Bandwidth Channel 1 (TX Frequency 2412 MHz-20 MHz BW) - 802.11n.....	27
Plot 6-8:	6 dB Bandwidth Channel 6 (TX Frequency 2437 MHz-20 MHz BW) - 802.11n.....	28
Plot 6-9:	6 dB Bandwidth Channel 11 (TX Frequency 2462 MHz-20 MHz BW) - 802.11n.....	29
Plot 6-10:	6 dB Bandwidth Channel 8 (TX Frequency 2437 MHz-40 MHz BW) - 802.11n.....	30
Plot 7-1:	Power Spectral Density: Channel 1 (2412 MHz); 802.11b (2 Mbps).....	32
Plot 7-2:	Power Spectral Density: Channel 6 (2437 MHz); 802.11b (2 Mbps).....	33
Plot 7-3:	Power Spectral Density: Channel 11 (2462 MHz); 802.11b (2 Mbps).....	34
Plot 7-4:	Power Spectral Density: Channel 1 (2412 MHz); 802.11g (18 Mbps).....	35
Plot 7-5:	Power Spectral Density: Channel 6 (2437 MHz); 802.11g (18 Mbps).....	36
Plot 7-6:	Power Spectral Density: Channel 11 (2462 MHz); 802.11g (18 Mbps).....	37
Plot 7-7:	Power Spectral Density: Channel 1 (2412 MHz); 802.11n (13 Mbps).....	38
Plot 7-8:	Power Spectral Density: Channel 6 (2437 MHz); 802.11n (13 Mbps).....	39
Plot 7-9:	Power Spectral Density: Channel 11 (2462 MHz); 802.11n (13 Mbps).....	40
Plot 7-10:	Power Spectral Density: Channel 5 (2442 MHz); 802.11n (40MHz BW).....	41

---

### Appendix Index

---

Appendix A: Test Photographs .....	51
------------------------------------	----

---

### Photograph Index

---

Photograph 1: Radiated Testing – Front View .....	51
Photograph 2: Radiated Testing – Back View .....	52

## 1 General Information

### 1.1 Scope

This is an original FCC and Industry Canada certification application report.

Applicable Standards:

- FCC Rules Part 15.247: Frequency Hopping, Direct Spread Spectrum and Hybrid Systems that are in operation within the bands of 902-928 MHz, 2400-2483.5 MHz and 5725-5850 MHz
- RSS-247 Issue 2 Digital Transmission Systems (DTSs), Frequency Hopping Systems (FHSs) and Licence-Exempt Local Area Network (LE-LAN) Devices
- RSS-Gen Issue 4: General Requirements and Information for the Certification of Radio Apparatus

This test report addresses the intentional radiated emissions requirements per FCC 15.247, which are the harmonic/spurious radiated emissions occurring in the restricted bands per FCC 15.205 (against the FCC 15.209 limits).

### 1.2 Description of EUT

<b>Equipment Under Test</b>	XL-200P C1D1 Non-Rebanded
<b>Power Supply</b>	7.4 VDC Li-Ion Battery
<b>Modulation Type</b>	DSSS
<b>Frequency Range</b>	2412 – 2462 MHz
<b>Antenna Connector Type</b>	N/A
<b>Antenna Type</b>	Internal chip

### 1.3 Test Facility

The open area test site and conducted measurement facility used to collect the radiated data is located at 360 Herndon Parkway, Suite 1400, Herndon, Virginia 20170. This site has been fully described in a report and approved by the Federal Communications Commission to perform AC line conducted and radiated emissions testing.

### 1.4 Related Submittal(s)/Grant(s)

This report supports a certification application for Harris Corporation Model XL-200P C1D1 Non-Rebanded, FCC ID: OWDTR-0146-E, IC: 3636B-0146.

### 1.5 Modifications

No physical modifications were required for compliance.

## 2 Test Information

### 2.1 Description of Test Modes

In accordance with FCC 15.31(m), and because the EUT utilizes an operating band greater than 10 MHz, the following frequencies were tested.

**Table 2-1: Channels Tested for DSSS – 802.11b (2 Mbps); 802.11g (12 Mbps)**

Channel	Frequency (MHz)
1	2412
6	2437
11	2462

### 2.2 Exercising the EUT

The EUT was tested in all three orthogonal planes in order to determine worst-case emissions. The EUT was provided with software to continuously transmit during testing. The carrier was also checked to verify that information was being transmitted. There were no deviations from the test standard(s) and/or methods. The test results reported relate only to the item tested.

### 2.3 Test Result Summary

**Table 2-2: Test Result Summary – FCC Part 15, Subpart C (Section 15.247), IC RSS-247/RSS-Gen**

FCC Reference	IC Reference	C63.10 Procedure	Test	Pass/Fail or N/A
FCC 15.209	RSS-247 2.2 RSS-Gen 6.5, A2.9	6.5, 6.6	Radiated Emissions	Pass
FCC 15.247(a)(2)	RSS-247 5.2	11.8	6 dB Bandwidth	Pass
FCC 15.247(b)	RSS-247 5.4 RSS-Gen 6.12	11.9	Maximum Peak Power Output	Pass
FCC 15.247(d)	RSS-247 5.5 RSS-Gen 6.13	11.12.2	Antenna Conducted Spurious Emissions	Pass
FCC 15.247(e)	RSS-247 5.2	11.10	Power Spectral Density	Pass
FCC 15.247(d)	RSS-247 5.5	11.13	Band Edge Measurement	Pass

## 2.4 Test System Details

The test samples were received on February 27, 2014. The FCC identifiers for all applicable equipment, plus descriptions of all cables used in the tested system, are identified in the following tables.

**Table 2-3: Equipment Under Test**

Part	Manufacturer	Model	Serial Number	FCC ID	RTL Bar Code
Radio	Harris Corporation	XL-200P C1D1 Non-Rebanded (System)	14035-1000-01/E00236	OWDTR-0146-E	21612
Radio (conducted connection)	Harris Corporation	XL-200P C1D1 Non-Rebanded (System)	14035-1000-01/0W XD-E00239	OWDTR-0146-E	21614

**Table 2-4: Accessory Test Equipment**

Part	Manufacturer	Model	Serial Number	FCC ID	RTL Bar Code
Battery Eliminator	Harris Corporation	14035-4300-01	N/A	N/A	21553
Breakout Box	Harris Corporation	12082-7980-01	N/A	N/A	20599
Battery	Harris Corporation	BAT-L-CASE-R-HR003	Engineering Sample #73	N/A	21552
Laptop	Samsung	NP300E5A-A01UB	HJV F93EB90320 1D	N/A	901550

**Figure 2-1: Configuration of Tested System**

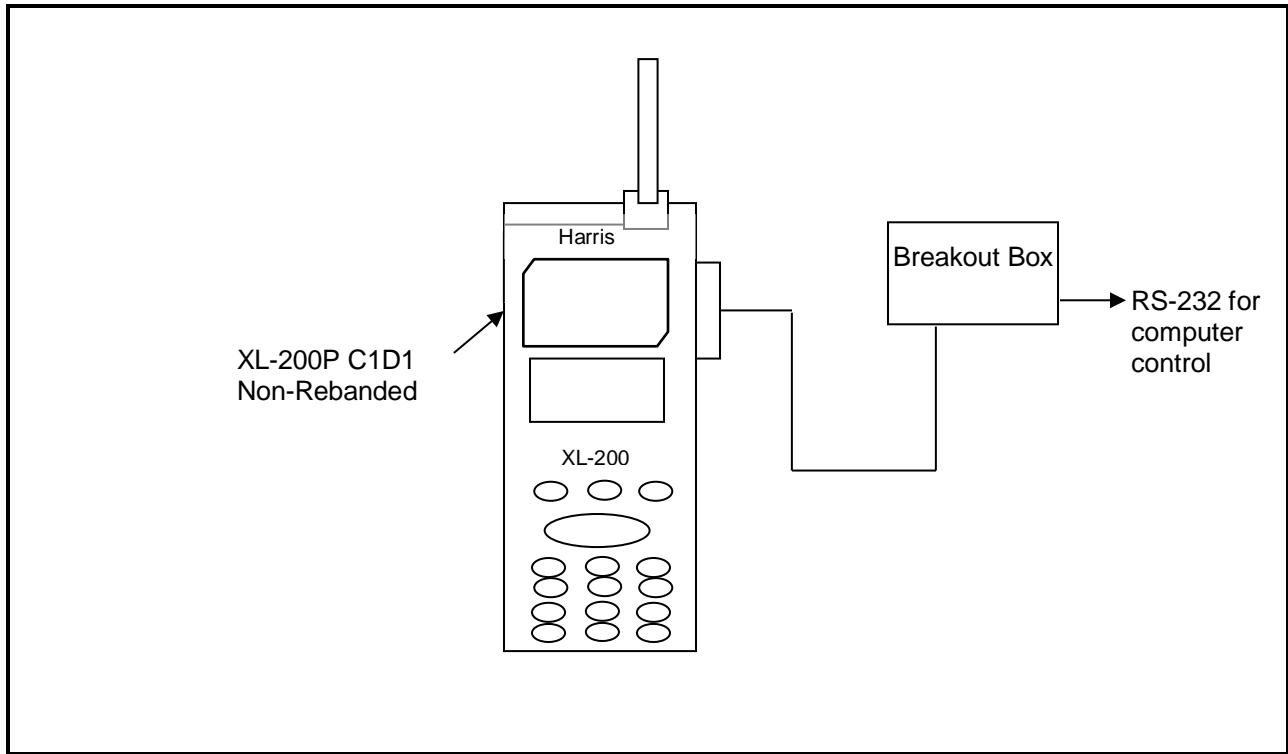



### 3 Peak Output Power – FCC 15.247(b)(1); RSS-247 5.4(d)

#### 3.1 Power Output Test Procedure

A conducted power measurement of the EUT was taken using a Rohde & Schwarz Spectrum Analyzer.

**Table 3-1: Power Output Test Equipment**

RTL Asset #	Manufacturer	Model	Part Type	Serial Number	Calibration Due Date
901581	Rohde & Schwarz	FSU	Spectrum Analyzer	1166.1660.50	11/13/15

#### 3.2 Power Output Test Data

**Table 3-2: Power Output Test Data – 802.11b**

Channel	Frequency (MHz)	Peak Power (dBm)
1	2412	20.3
6	2437	20.7
11	2462	20.0

**Table 3-3: Power Output Test Data – 802.11g**

Channel	Frequency (MHz)	Peak Power (dBm)
1	2412	20.9
6	2437	23.7
11	2462	20.8

**Table 3-4: Power Output Test Data – 802.11n**

Channel	Frequency (MHz)	Peak Power (dBm)
1	2412	21.6
6	2437	23.4
11	2462	21.3

#### Test Personnel:

Daniel W. Baltzell  
 Test Engineer

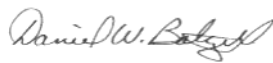

Signature

March 14, 2013  
 Date of Test

#### 4 Compliance with the Band Edge – FCC 15.247(d); RSS-247 5.5

##### 4.1 Band Edge Test Procedure

The transmitter output was connected to its appropriate antenna. Peak (1 MHz RBW/3 MHz VBW) and average (1 MHz RBW/10 Hz VBW) corrected radiated measurements were taken within the restricted band to show compliance.

**Table 4-1: Band Edge Test Equipment**

RTL Asset #	Manufacturer	Model	Part Type	Serial Number	Calibration Due Date
900878	Rhein Tech Laboratories, Inc.	AM3-1197-0005	3 meter antenna mast, polarizing	Outdoor Range 1	Not Required
901592	Insulated Wire Inc.	KPS-1503-3600-KPR	SMK RF Cables 20'	NA	9/3/15
901242	Rhein Tech Laboratories, Inc.	WRT-000-0003	Wood rotating table	N/A	Not Required
900772	EMCO	3161-02	Horn Antenna (2 - 4 GHz)	9804-1044	4/09/18
901581	Rohde & Schwarz	FSU	Spectrum Analyzer	1166.1660.50	11/13/15

#### 4.1.1 Lower Band Edge – 802.11b

94.6 dBuV/m is the average field strength measurement, from which the delta measurement of 51.7 dB is subtracted (reference plots), resulting in a level 42.9 dB. This level has a margin of 11.1 dB below the limit of 54 dBuV/m.

Calculation:  $94.6 \text{ dBuV/m} - 51.7 \text{ dB} - 54 \text{ dBuV/m} = -11.1 \text{ dB}$

Peak Field Strength of Lower Band Edge (1 MHz RBW/3 MHz VBW) = 99.8 dBuV/m  
 Average Field Strength of Lower Band Edge (1 MHz RBW/10 Hz VBW) = 94.6 dBuV/m  
 Delta measurement = 51.7 dB

**Plot 4-1: In Band Emissions - Channel 1 (2412 MHz); 802.11b (2 Mbps)**

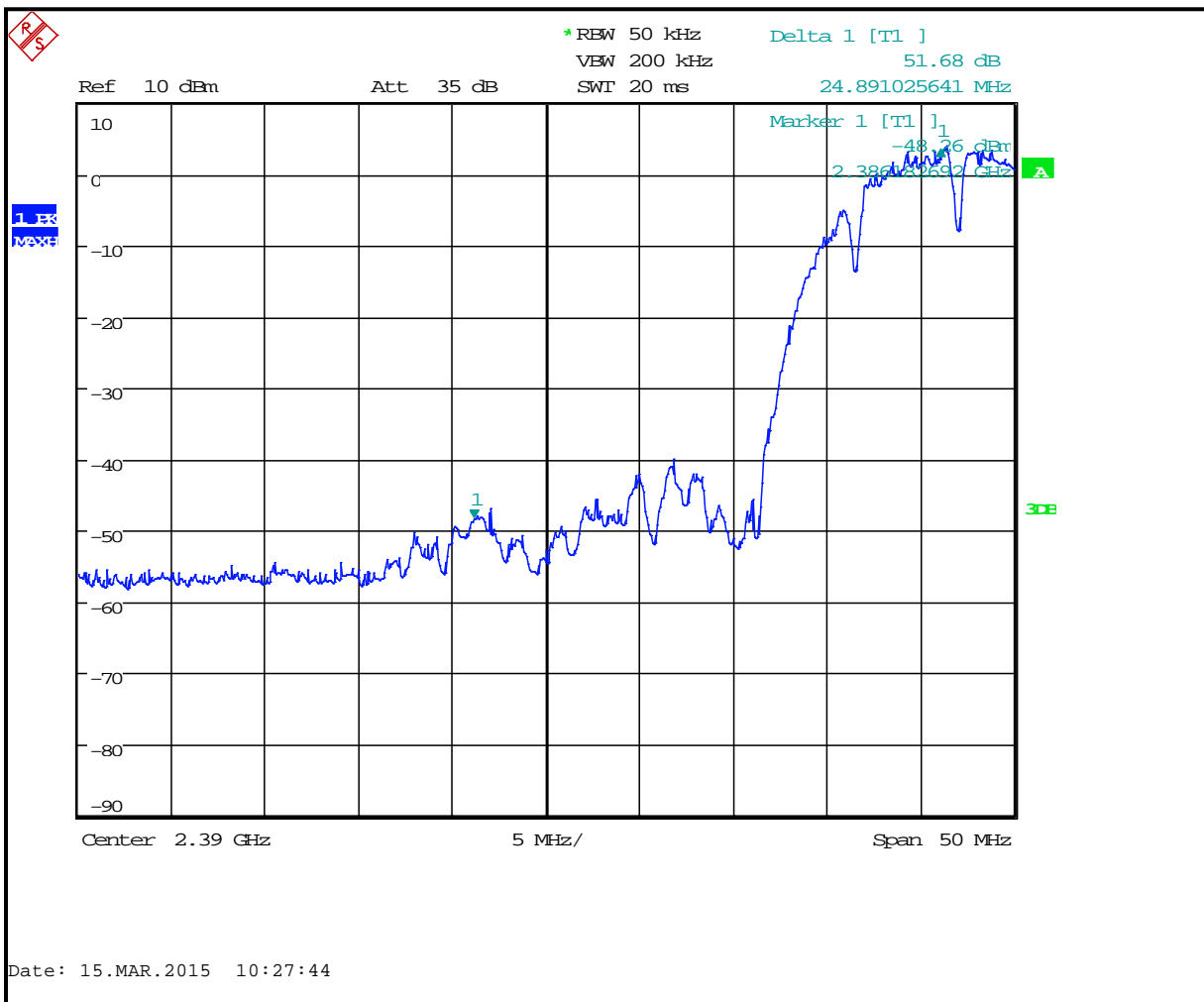

#### 4.1.2 Upper Band Edge – 802.11b

94.8 dBuV/m is the average field strength measurement, from which the delta measurement of 47.6 dB is subtracted (reference plots), resulting in a level 47.2 dB. This level has a margin of 6.8 dB below the limit of 54 dBuV/m.

Calculation:  $94.8 \text{ dBuV/m} - 47.6 \text{ dB} - 54 \text{ dBuV/m} = -6.8 \text{ dB}$

Peak Field Strength of Upper Band Edge (1 MHz RBW/1 MHz VBW) = 100.0 dBuV/m  
 Average Field Strength of Upper Band Edge (1 MHz RBW/10 Hz VBW) = 94.8 dBuV/m  
 Delta measurement = 47.6 dB

**Plot 4-2: In Band Emissions - Channel 11 (2462 MHz); 802.11b (2 Mbps)**

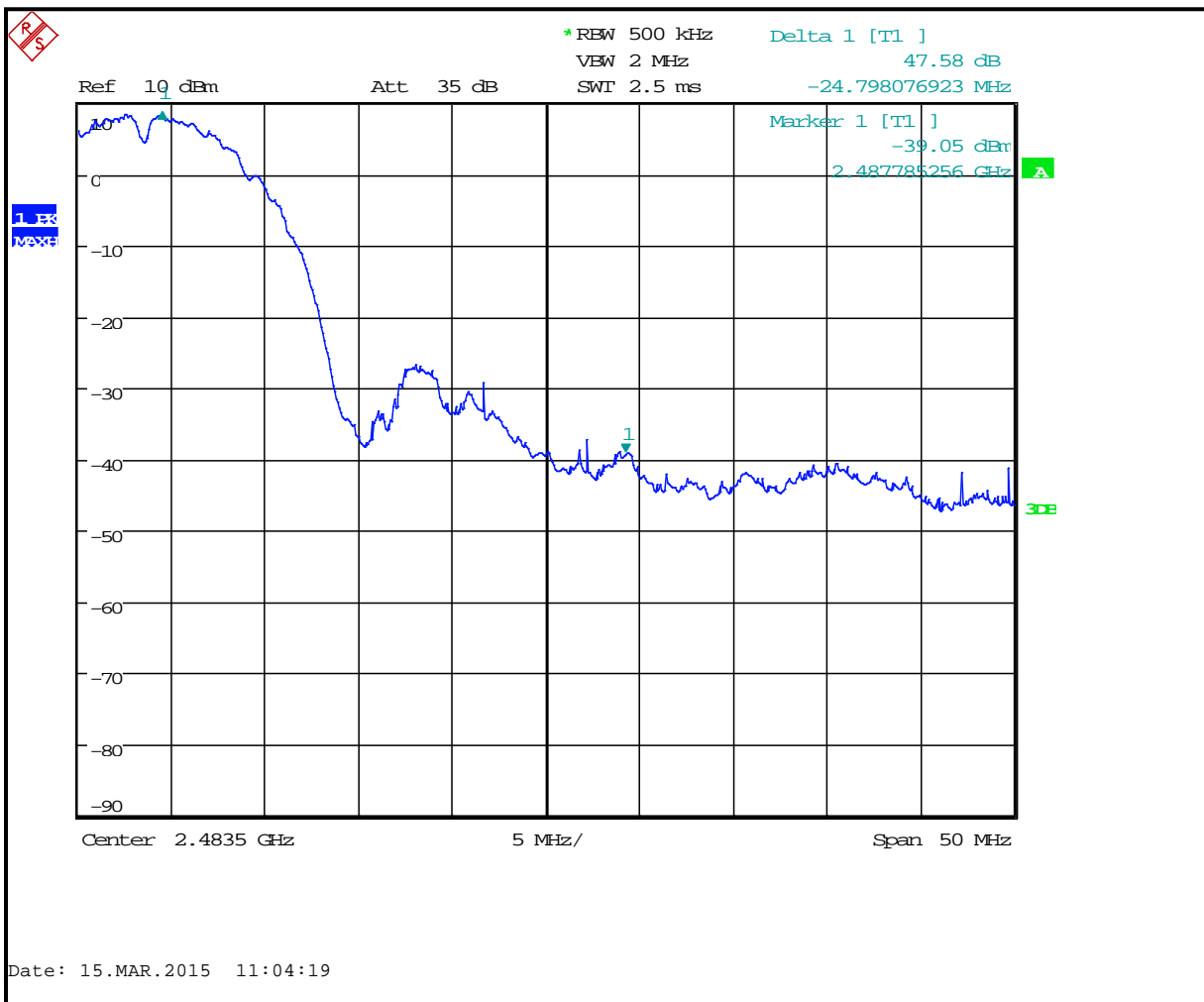

### 4.1.3 Lower Band Edge – 802.11g

89.1 dBuV/m is the average field strength measurement, from which the delta measurement of 35.6 dB is subtracted (reference plots), resulting in a level 53.5 dB. This level has a margin of 0.5 dB below the limit of 54 dBuV/m.

Calculation:  $89.1 \text{ dBuV/m} - 35.6 \text{ dB} - 54 \text{ dBuV/m} = -0.5 \text{ dB}$

Peak Field Strength of Lower Band Edge (1 MHz RBW/3 MHz VBW) = 100.3 dBuV/m  
 Average Field Strength of Lower Band Edge (1 MHz RBW/10 Hz VBW) = 89.1 dBuV/m  
 Delta measurement = 35.6 dB

**Plot 4-3: In Band Emissions - Channel 1 (2412 MHz); 802.11g (12 Mbps)**

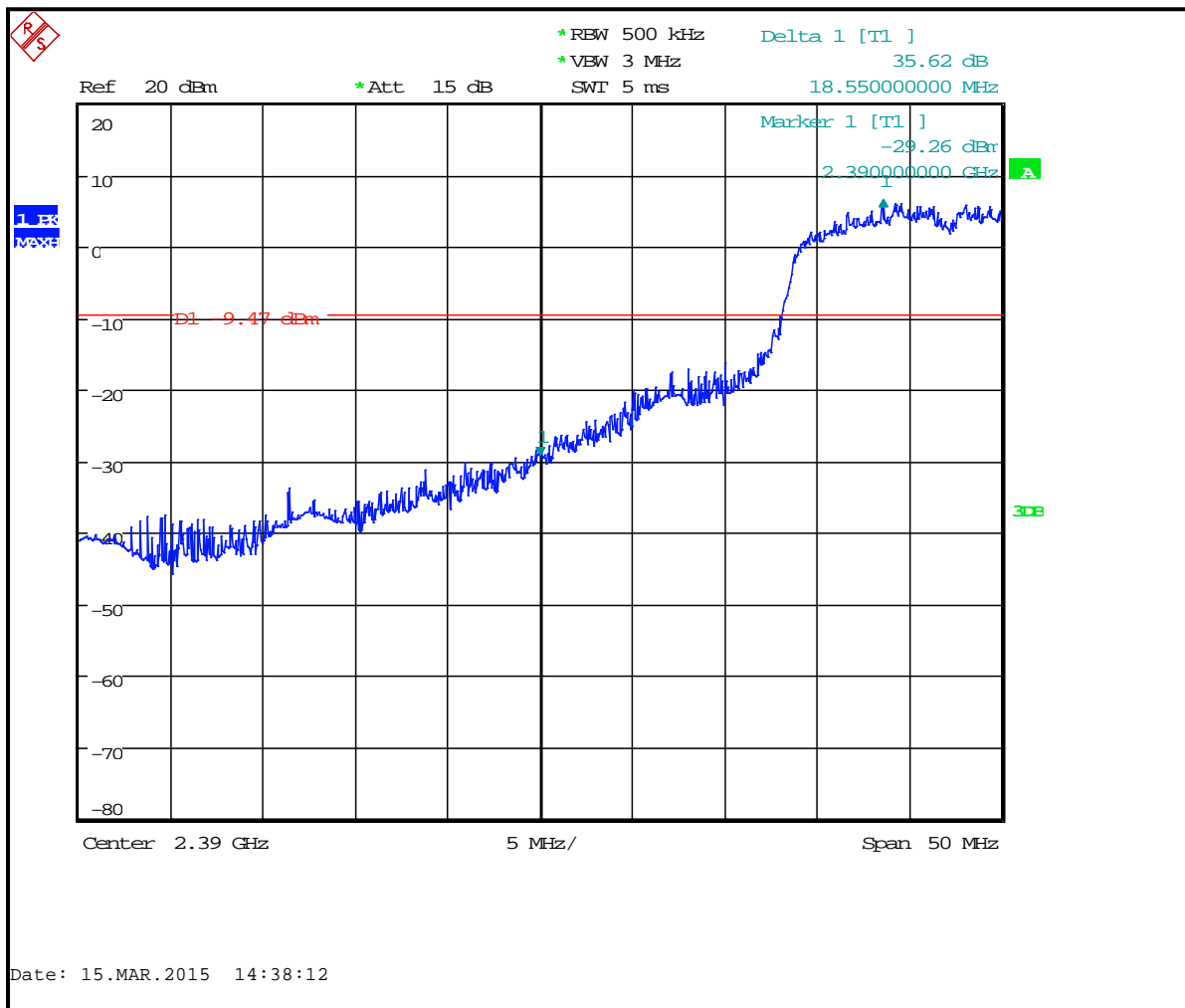

#### 4.1.4 Upper Band Edge – 802.11g

90.9 dBuV/m is the average field strength measurement, from which the delta measurement of 39 dB is subtracted (reference plots), resulting in a level 51.9 dB. This level has a margin of 2.1 dB below the limit of 54 dBuV/m.

Calculation:  $90.9 \text{ dBuV/m} - 39.0 \text{ dB} - 54 \text{ dBuV/m} = -2.1 \text{ dB}$

Peak Field Strength of Upper Band Edge (1 MHz RBW/1 MHz VBW) = 101.6 dBuV/m  
 Average Field Strength of Upper Band Edge (1 MHz RBW/10 Hz VBW) = 90.9 dBuV/m  
 Delta measurement = 39.0 dB

**Plot 4-4: In Band Emissions - Channel 11 (2462 MHz); 802.11g (12 Mbps)**

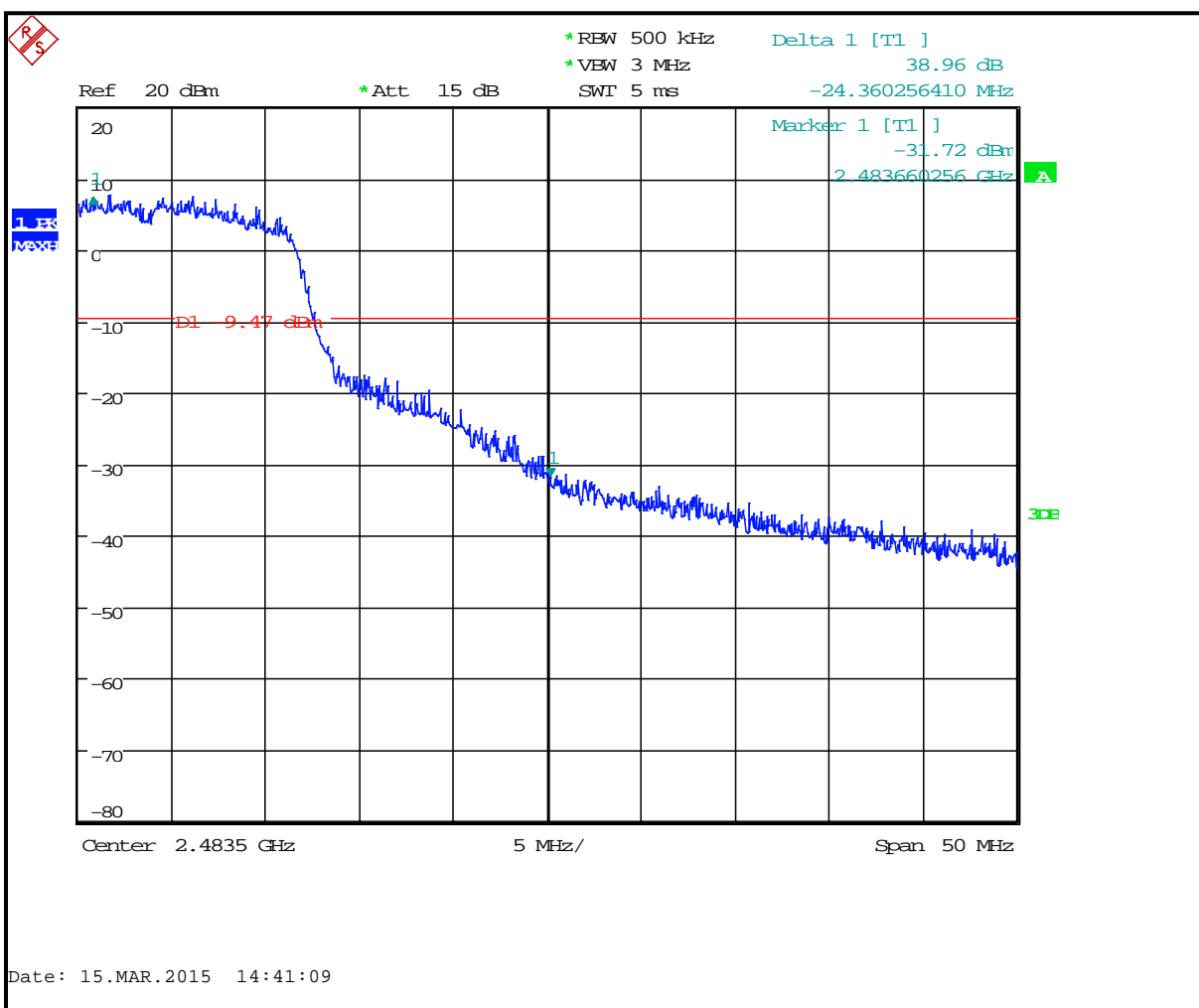

#### 4.1.5 Lower Band Edge – 802.11n

75.4 dBuV/m is the average field strength measurement, from which the delta measurement of 40 dB is subtracted (reference plots), resulting in a level 35.4 dB. This level has a margin of 18.6 dB below the limit of 54 dBuV/m.

Calculation:  $75.4 \text{ dBuV/m} - 40 \text{ dB} - 54 \text{ dBuV/m} = -18.6 \text{ dB}$

Peak Field Strength of Lower Band Edge (1 MHz RBW/3 MHz VBW) = 93.9 dBuV/m  
 Average Field Strength of Lower Band Edge (1 MHz RBW/10 Hz VBW) = 75.4 dBuV/m  
 Delta measurement = 40 dB

**Plot 4-5: In Band Emissions - Channel 1 (2412 MHz); 802.11n (65 Mbps)**

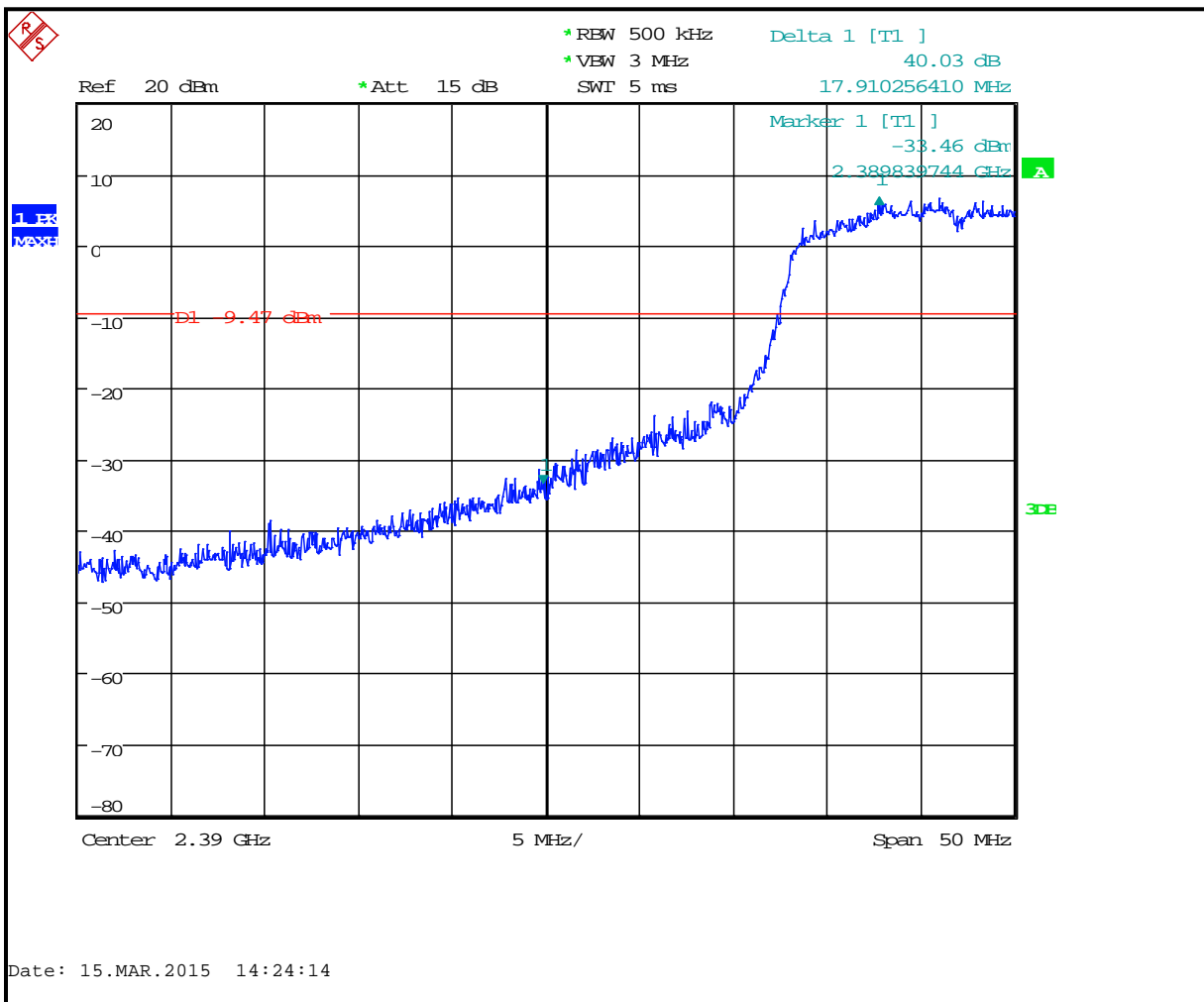

#### 4.1.6 Upper Band Edge – 802.11n

80.5 dBuV/m is the average field strength measurement, from which the delta measurement of 40.7 dB is subtracted (reference plots), resulting in a level 39.8 dB. This level has a margin of 14.2 dB below the limit of 54 dBuV/m.

Calculation:  $80.5 \text{ dBuV/m} - 40.7 \text{ dB} - 54 \text{ dBuV/m} = -14.2 \text{ dB}$

Peak Field Strength of Upper Band Edge (1 MHz RBW/1 MHz VBW) = 94.7 dBuV/m  
 Average Field Strength of Upper Band Edge (1 MHz RBW/10 Hz VBW) = 80.5 dBuV/m  
 Delta measurement = 40.7 dB

**Plot 4-6: In Band Emissions - Channel 11 (2462 MHz); 802.11n (65 Mbps)**

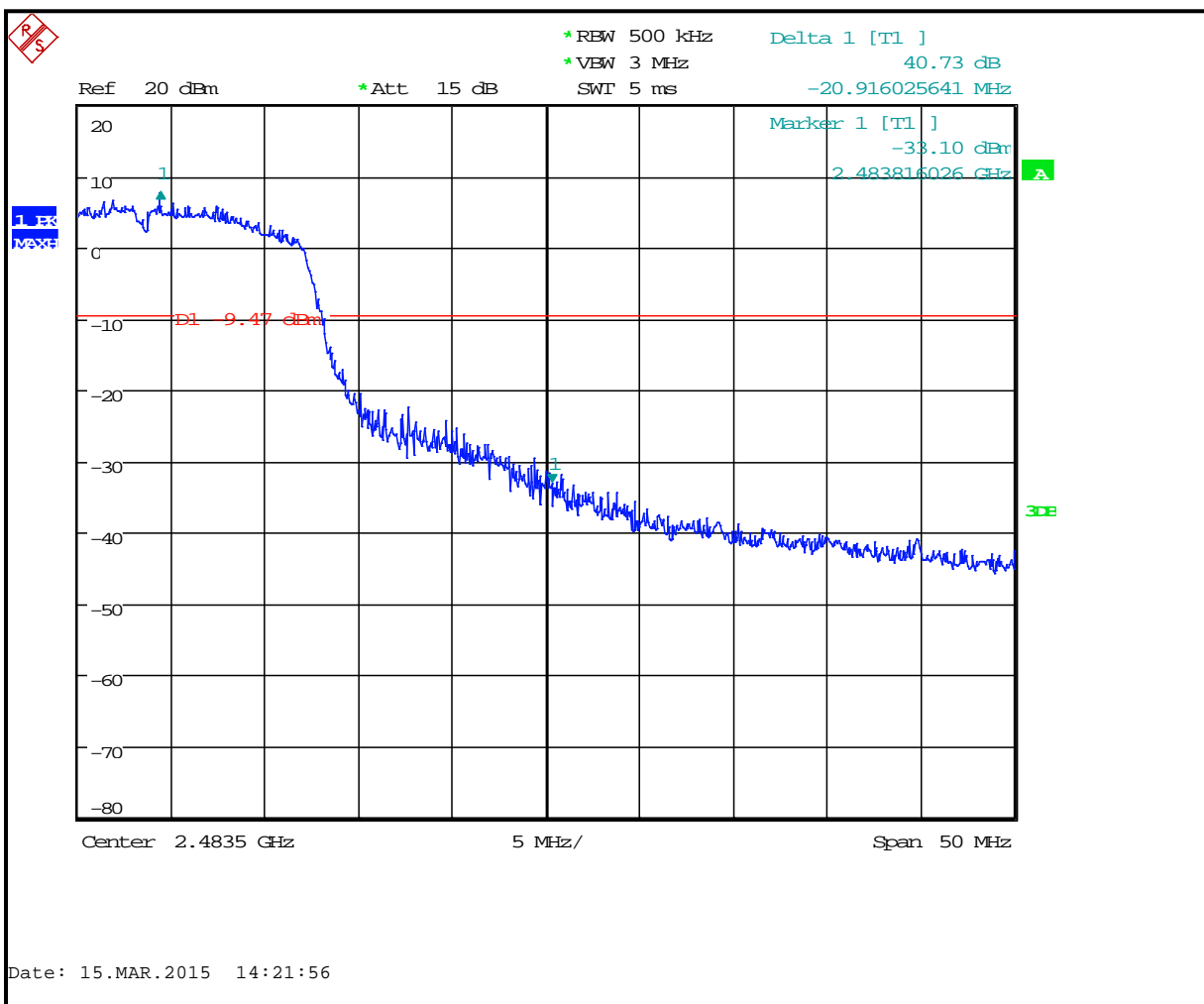



#### 4.1.7 Lower Band Edge – 802.11n (40 MHz BW)

88.2 dBuV/m is the average field strength measurement, from which the delta measurement of 39.3 dB is subtracted (reference plots), resulting in a level 48.9 dB. This level has a margin of 5.1 dB below the limit of 54 dBuV/m.

Calculation:  $88.2 \text{ dBuV/m} - 39.3 \text{ dB} - 54 \text{ dBuV/m} = -5.1 \text{ dB}$

Peak Field Strength of Lower Band Edge (1 MHz RBW/3 MHz VBW) = 94.7 dBuV/m  
 Average Field Strength of Lower Band Edge (1 MHz RBW/10 Hz VBW) = 88.2 dBuV/m  
 Delta measurement = 39.3 dB

**Plot 4-7: In Band Emissions - Channel 5 (2422 MHz); 802.11n (65 Mbps)**

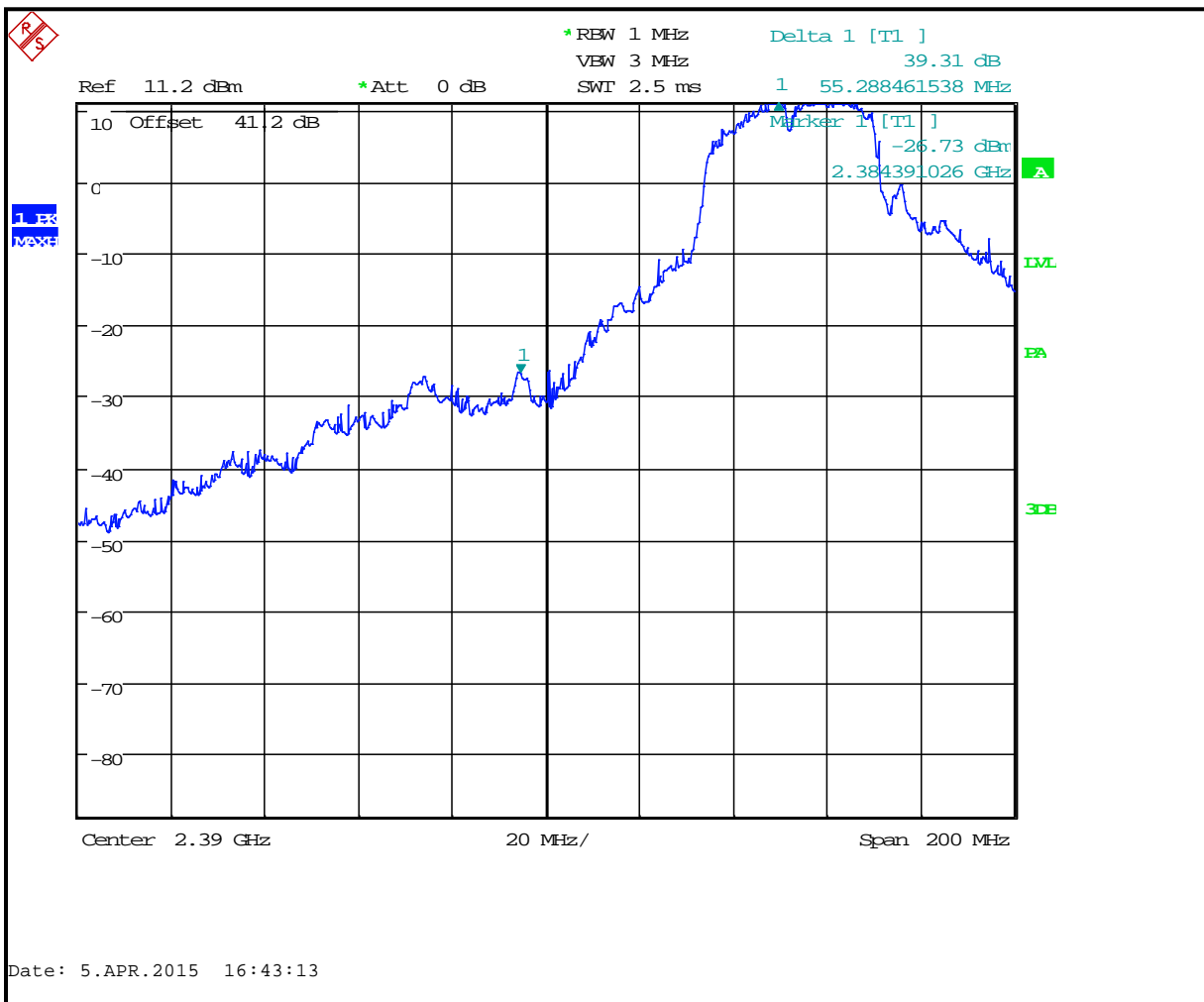

#### 4.1.8 Upper Band Edge – 802.11n (40 MHz BW)

88.2 dBuV/m is the average field strength measurement, from which the delta measurement of 35.8 dB is subtracted (reference plots), resulting in a level 52.4 dB. This level has a margin of 1.6 dB below the limit of 54 dBuV/m.

Calculation:  $88.2 \text{ dBuV/m} - 35.8 \text{ dB} - 54 \text{ dBuV/m} = -1.6 \text{ dB}$

Peak Field Strength of Lower Band Edge (1 MHz RBW/3 MHz VBW) = 94.7 dBuV/m  
 Average Field Strength of Lower Band Edge (1 MHz RBW/10 Hz VBW) = 88.2 dBuV/m  
 Delta measurement = 35.8 dB 23.1 @ch9=

**Plot 4-8: In Band Emissions - Channel 7 (2432 MHz); 802.11n (40 MHz)**

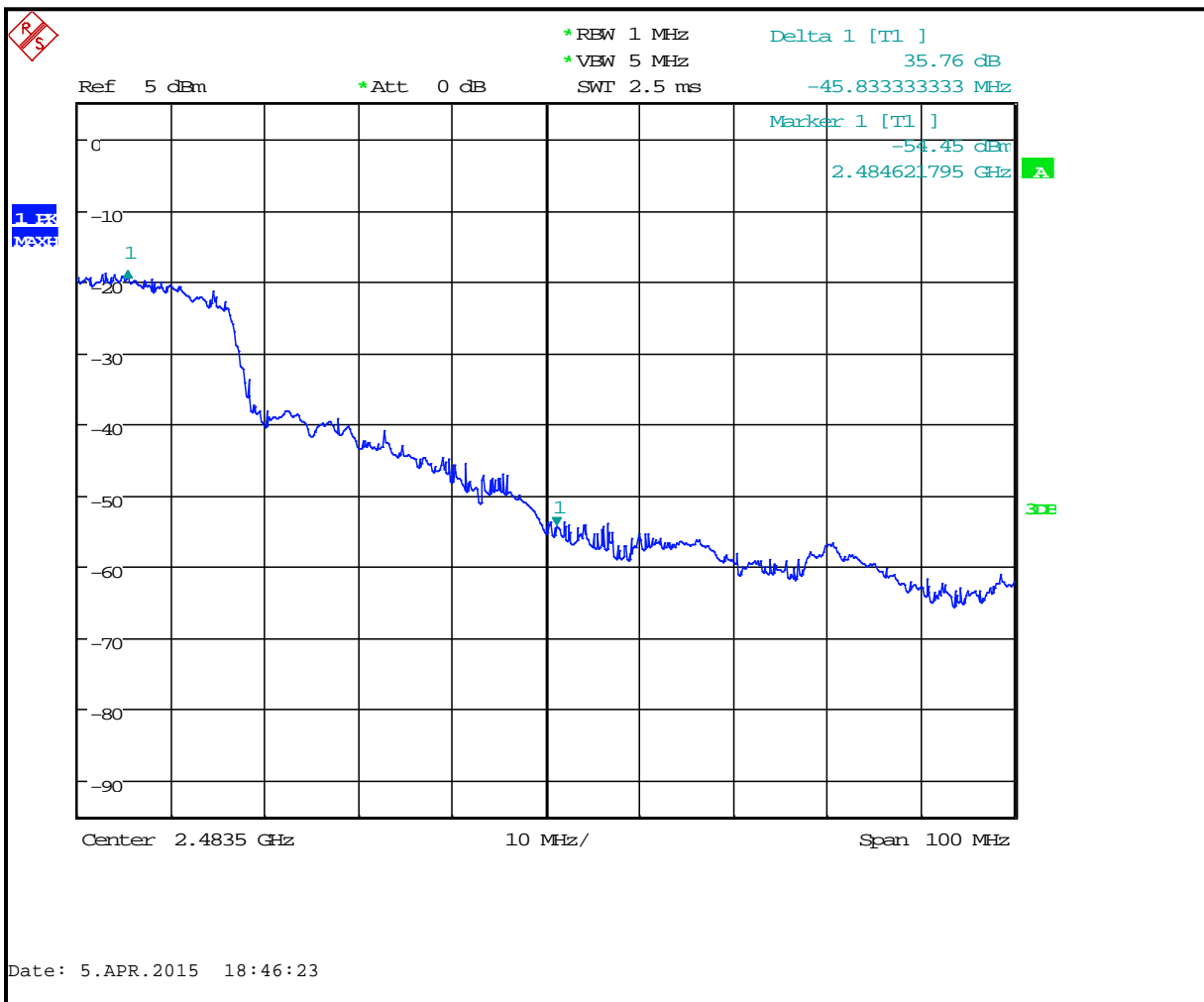

#### Test Personnel:

Daniel W. Baltzell  
 Test Engineer

Signature

March 15 & April 5, 2015  
 Dates of Test

**5 Antenna Conducted Spurious Emissions – FCC 15.247(d); RSS-247 5.5**

**5.1 Antenna Conducted Spurious Emissions Test Procedures**

Antenna spurious emissions per FCC 15.247(d) were measured from the EUT antenna port using a 50-ohm spectrum analyzer with the resolution bandwidth set at 100 kHz, and the video bandwidth set at 300 kHz. The modulated carrier was identified at the following frequencies: 2412 MHz, 2437 MHz and 2462 MHz.

**5.2 Antenna Conducted Spurious Emissions Test Results**

No harmonics or spurs were found within 20 dB (note that we are reporting power as peak) of the carrier level from the carrier to the 10<sup>th</sup> harmonic of the carrier frequency. Per FCC 15.31(o), no data is being reported.

**Table 5-1: Antenna Conducted Spurious Test Equipment**

RTL Asset #	Manufacturer	Model	Part Type	Serial Number	Calibration Due Date
901581	Rohde & Schwarz	FSU	Spectrum Analyzer	1166.1660.50	11/13/15

**Test Personnel:**

Daniel W. Baltzell		March 15, 2015
Test Engineer	Signature	Date of Test

## 6 Bandwidth – FCC 15.247(a)(2); RSS-247 5.2(a)

### 6.1 6 dB Bandwidth Test Procedure

The minimum 6 dB bandwidths per FCC 15.247(a)(2) were measured using a 50-ohm spectrum analyzer with the resolution bandwidth set at 100 kHz, and the video bandwidth set at  $\geq 3xRBW$ . The device was modulated. The minimum 6 dB bandwidths are presented below.

**Table 6-1: 6 dB Bandwidth Test Equipment**

RTL Asset #	Manufacturer	Model	Part Type	Serial Number	Calibration Due Date
901581	Rohde & Schwarz	FSU	Spectrum Analyzer	1166.1660.50	11/13/15

### 6.2 6 dB Bandwidth Test Results

**Table 6-2: 6 dB Bandwidth Test Data – 802.11b (2 Mbps)**

Channel	Frequency (MHz)	6 dB Bandwidth (MHz)	Minimum Limit (MHz)	Pass/Fail
1	2412	10.1	0.5	Pass
6	2437	10.3	0.5	Pass
11	2462	10.1	0.5	Pass

**Table 6-3: 6 dB Bandwidth Test Data – 802.11g (18 Mbps)**

Channel	Frequency (MHz)	6 dB Bandwidth (MHz)	Minimum Limit (MHz)	Pass/Fail
1	2412	14.7	0.5	Pass
6	2437	14.6	0.5	Pass
11	2462	14.4	0.5	Pass

**Table 6-4: 6 dB Bandwidth Test Data – 802.11n (6.5 Mbps-20 MHz BW)**

Channel	Frequency (MHz)	6 dB Bandwidth (MHz)	Minimum Limit (MHz)	Pass/Fail
1	2412	14.7	0.5	Pass
6	2437	14.6	0.5	Pass
11	2462	14.6	0.5	Pass

**Table 6-5: 6 dB Bandwidth Test Data – 802.11n (40 MHz BW)**

Channel	Frequency (MHz)	6 dB Bandwidth (MHz)	Minimum Limit (MHz)	Pass/Fail
8	2437	35.9	0.5	Pass

**Plot 6-1: 6 dB Bandwidth Channel 1 (TX Frequency 2412 MHz) - 802.11b**

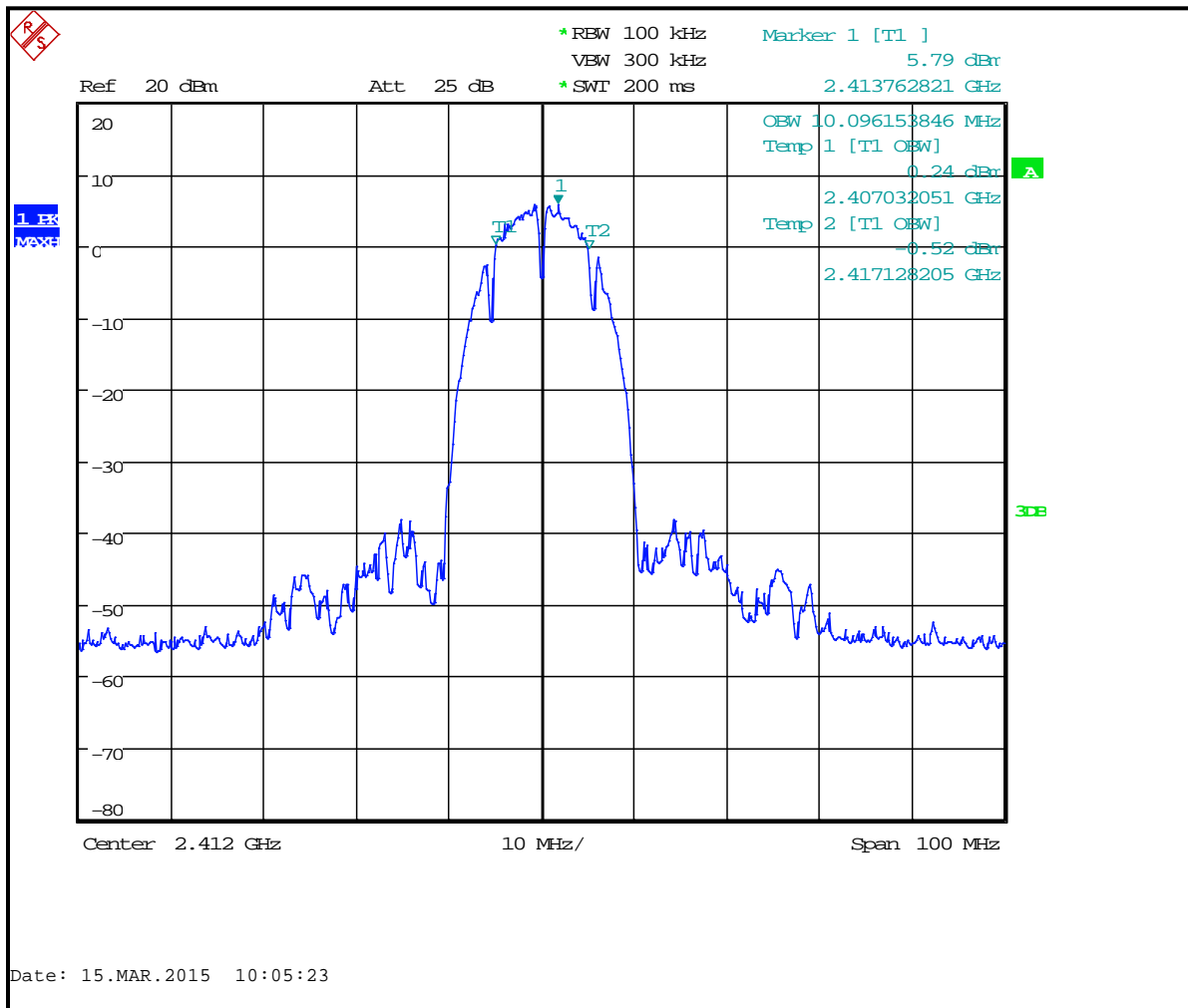

**Plot 6-2: 6 dB Bandwidth Channel 6 (TX Frequency 2437 MHz) - 802.11b**

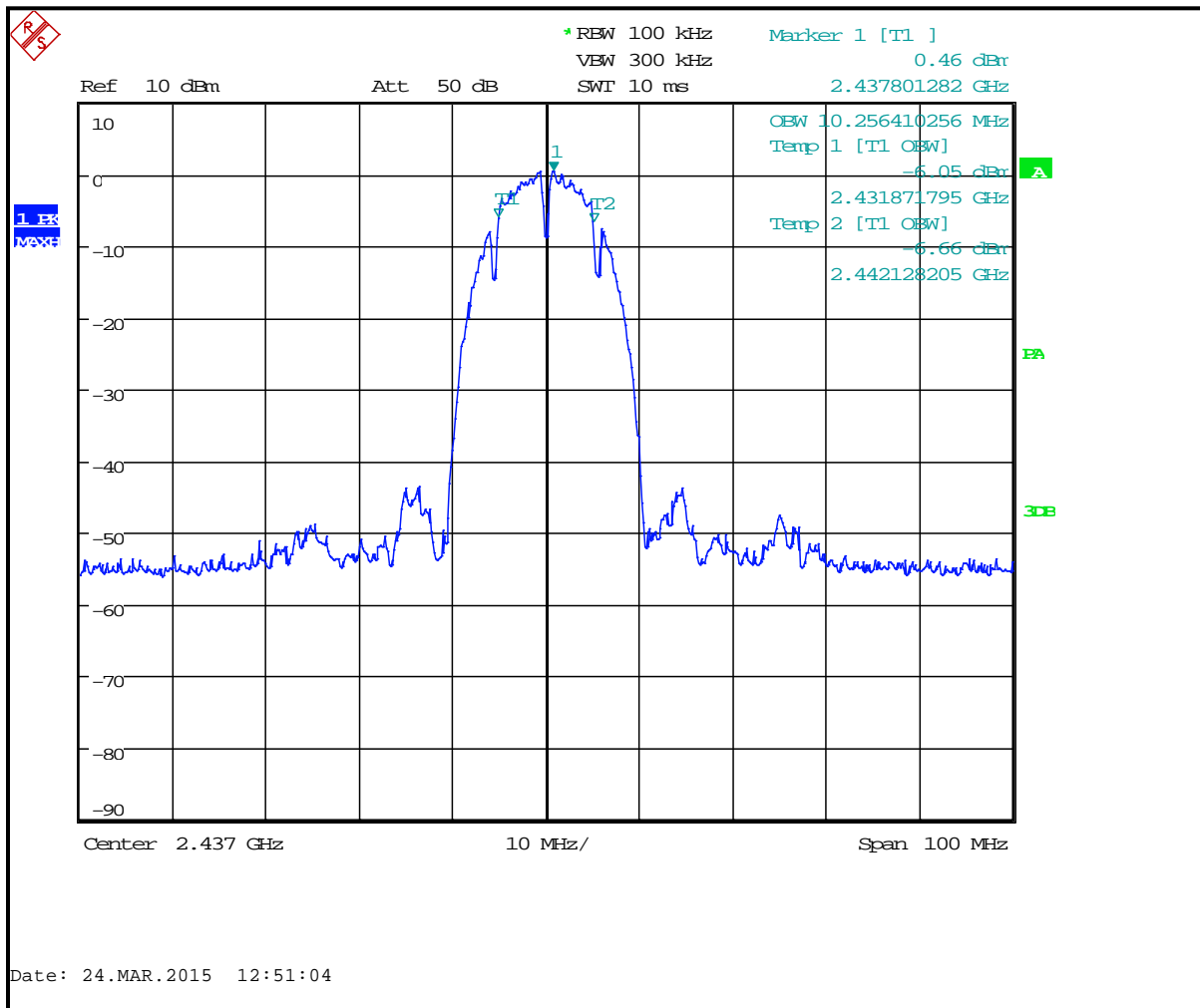

**Plot 6-3: 6 dB Bandwidth Channel 11 (TX Frequency 2462 MHz) - 802.11b**

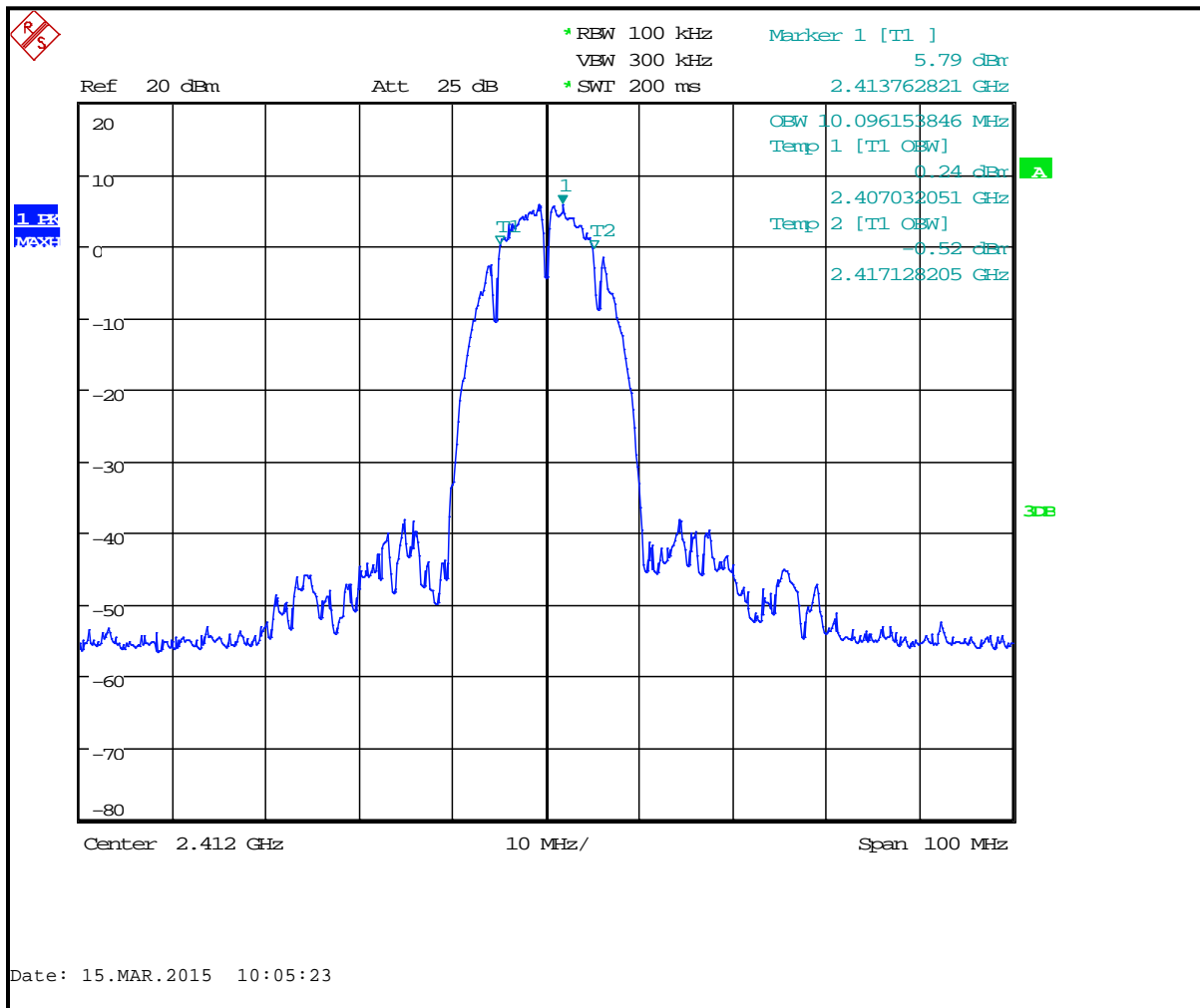

**Plot 6-4: 6 dB Bandwidth Channel 1 (TX Frequency 2412 MHz) - 802.11g**

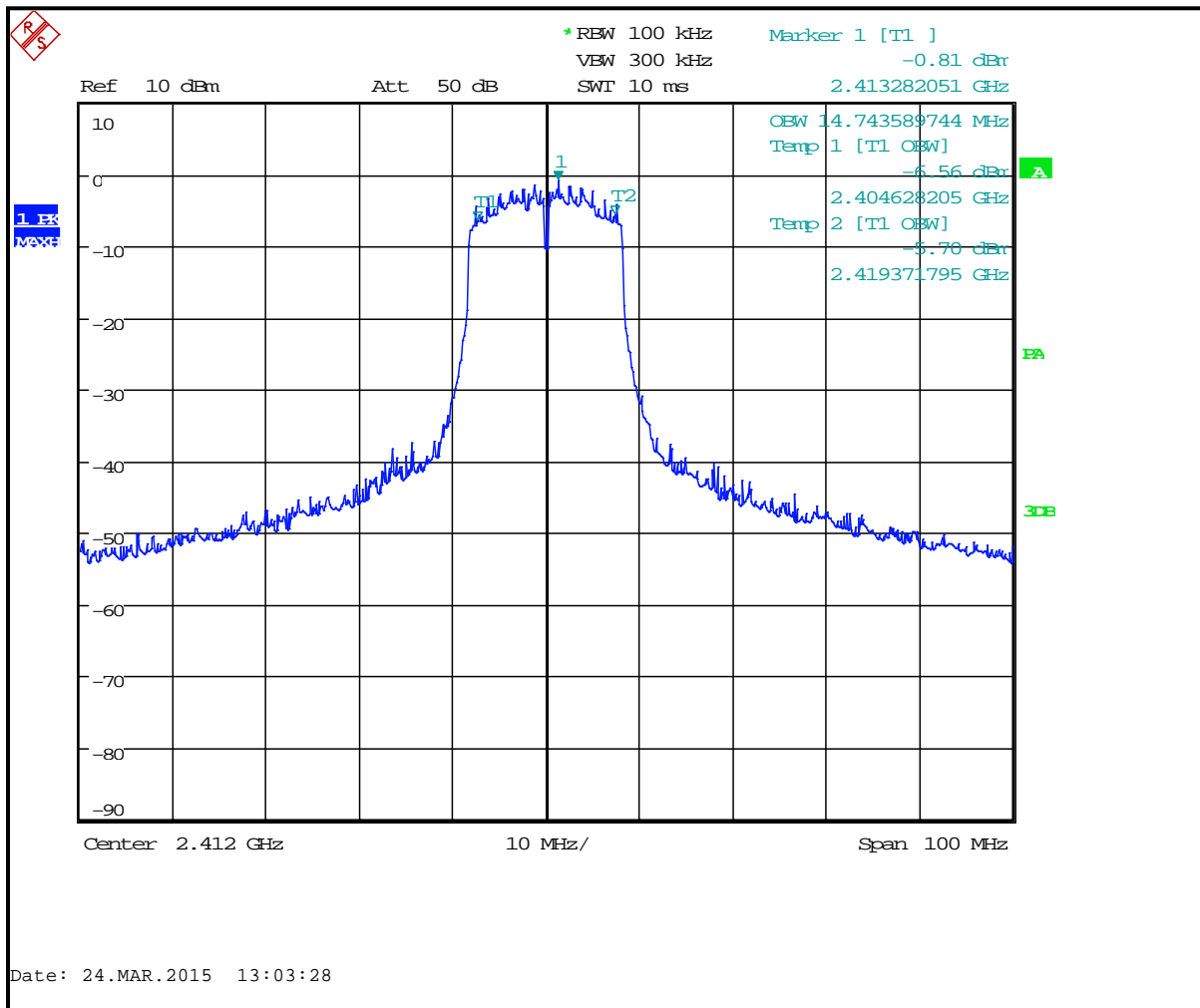



**Plot 6-5: 6 dB Bandwidth Channel 6 (TX Frequency 2437 MHz) - 802.11g**

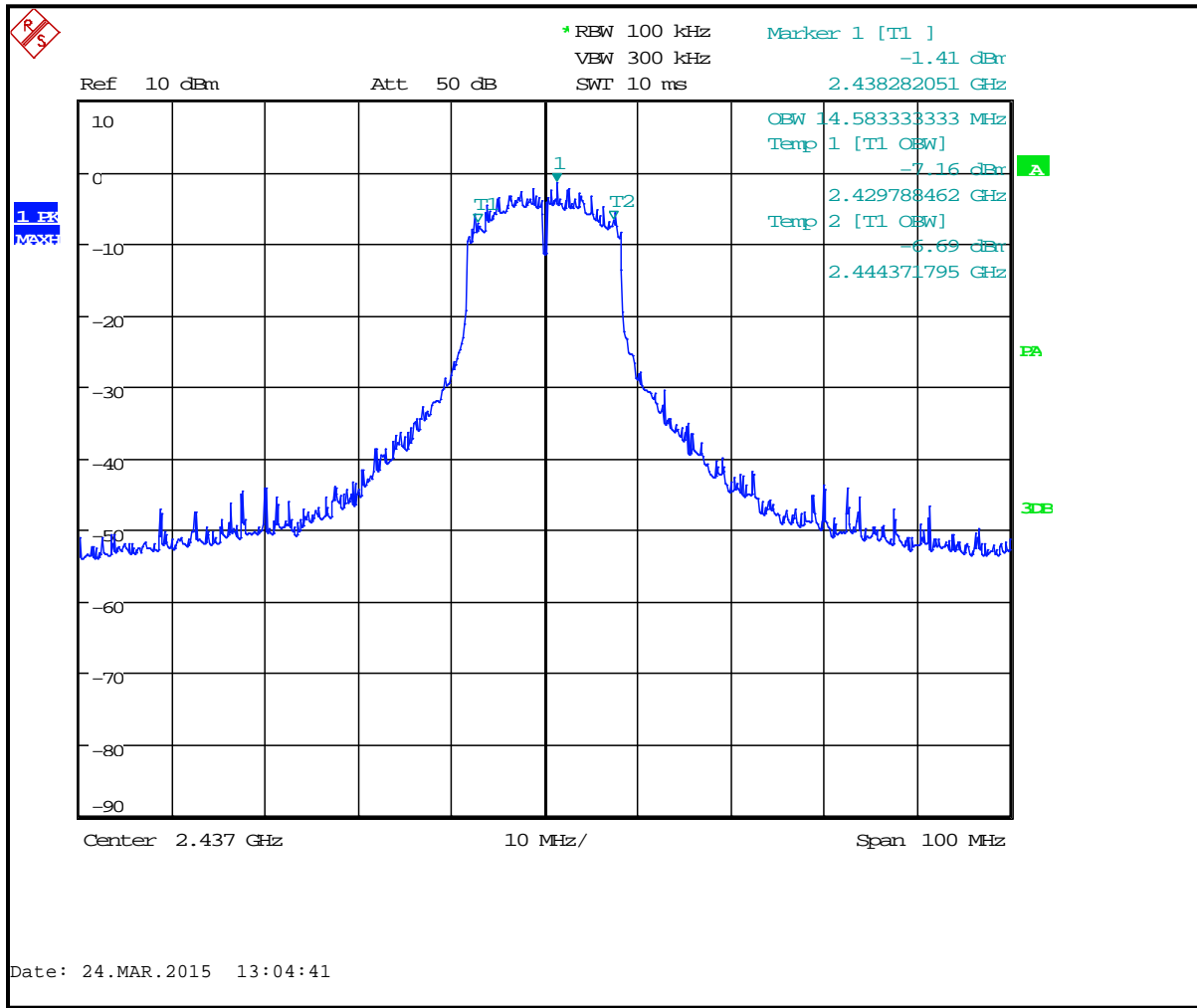

**Plot 6-6: 6 dB Bandwidth Channel 11 (TX Frequency 2462 MHz) - 802.11g**

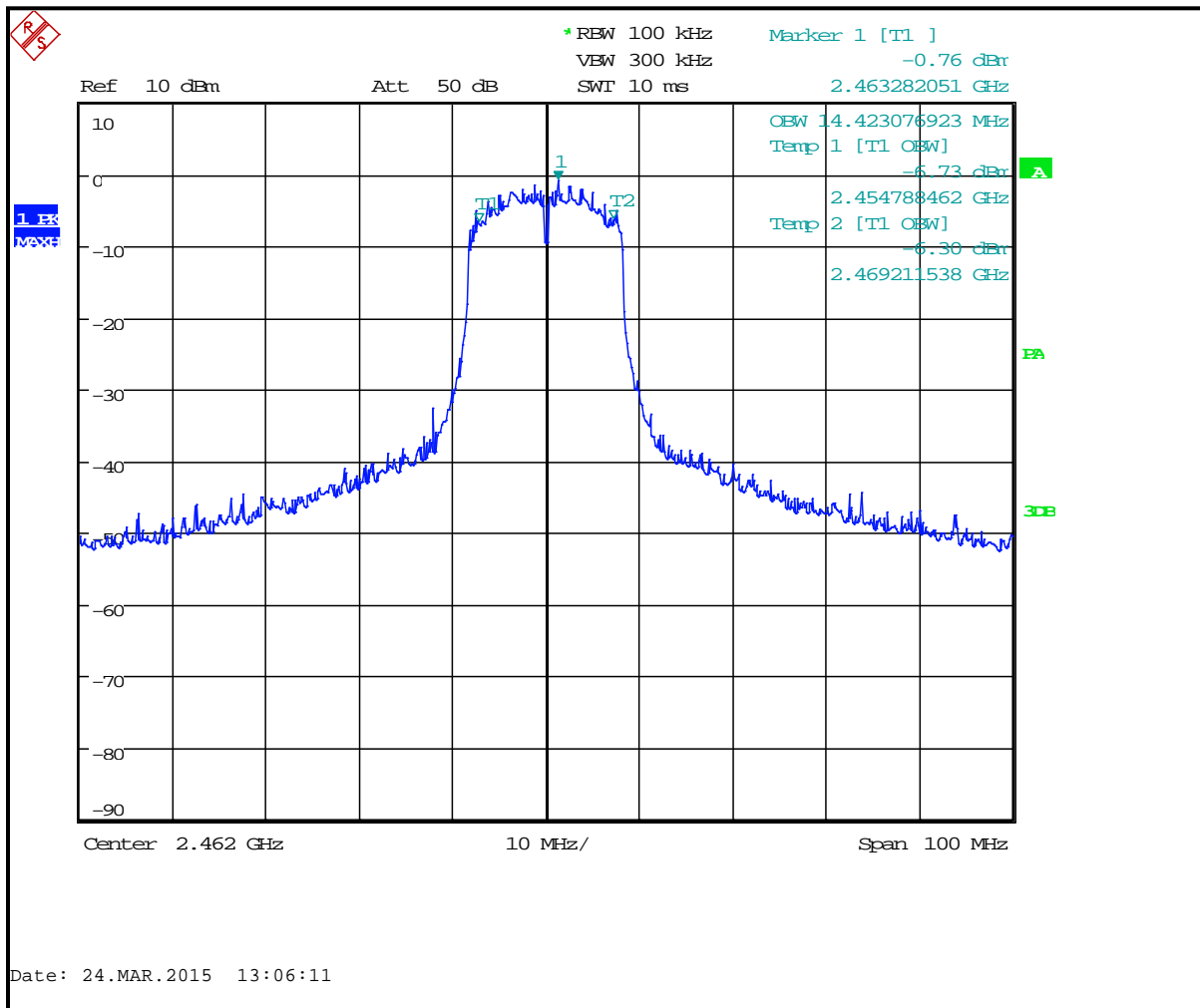

**Plot 6-7: 6 dB Bandwidth Channel 1 (TX Frequency 2412 MHz-20 MHz BW) - 802.11n**

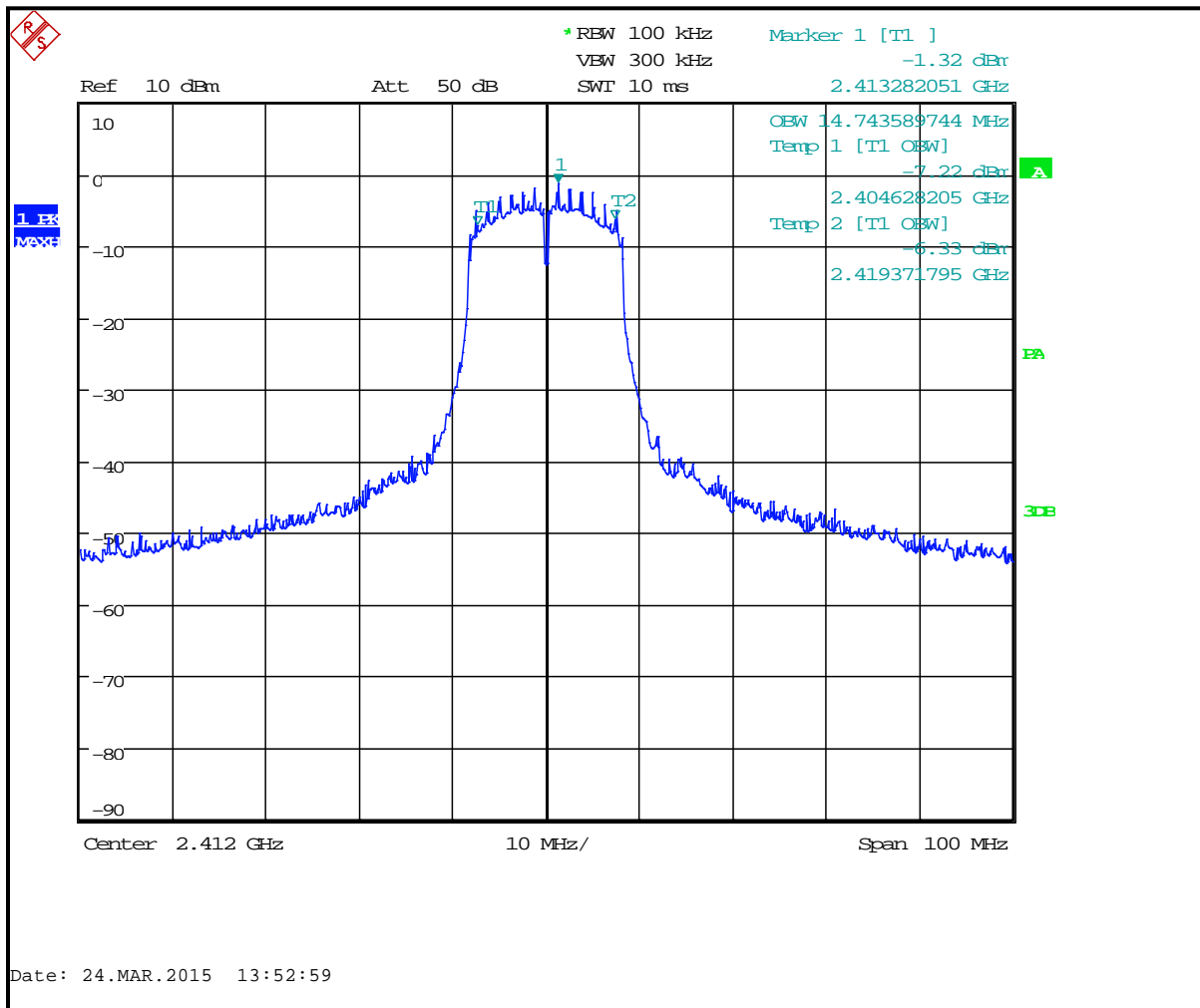

**Plot 6-8: 6 dB Bandwidth Channel 6 (TX Frequency 2437 MHz-20 MHz BW) - 802.11n**

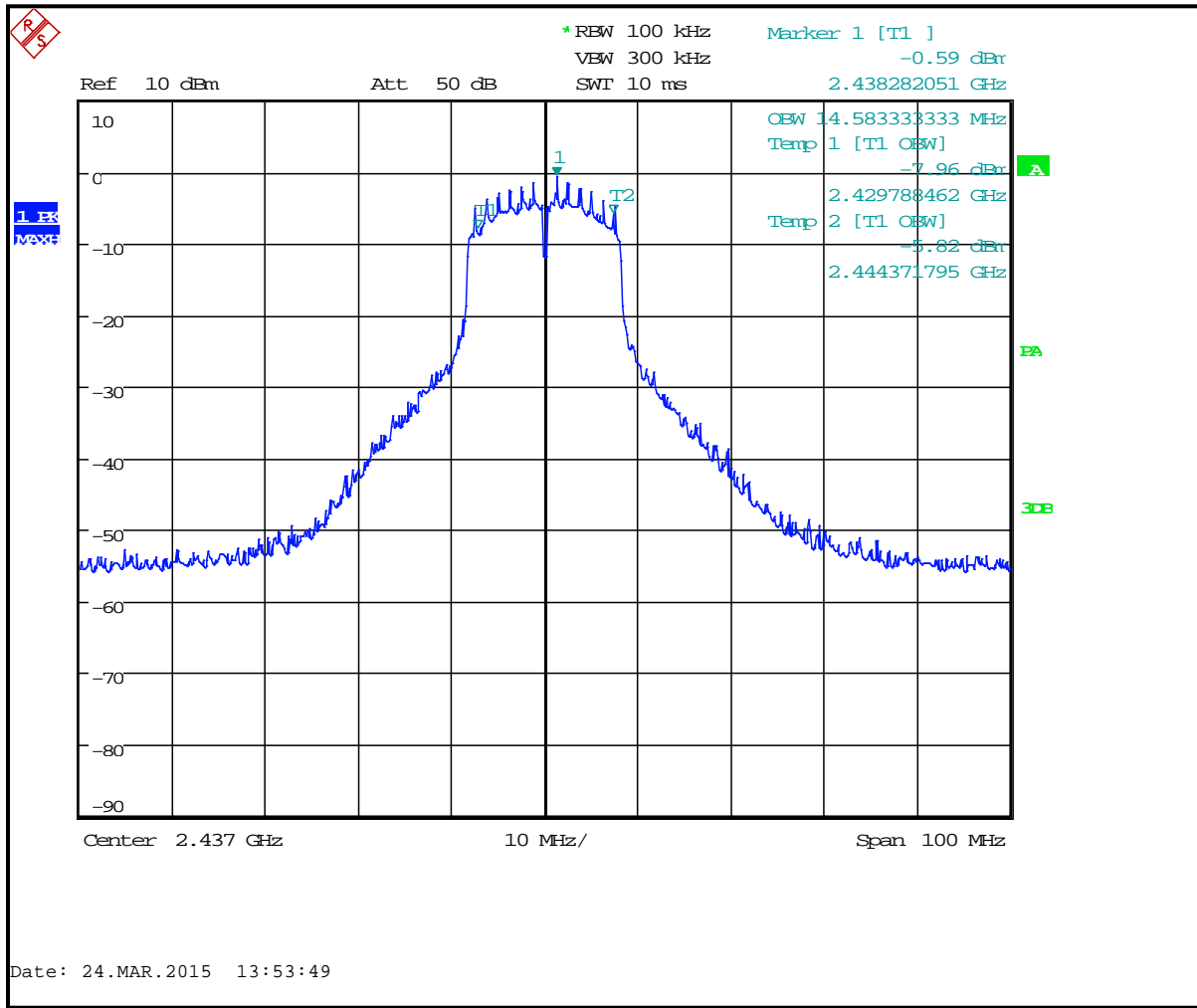

Plot 6-9: 6 dB Bandwidth Channel 11 (TX Frequency 2462 MHz-20 MHz BW) - 802.11n

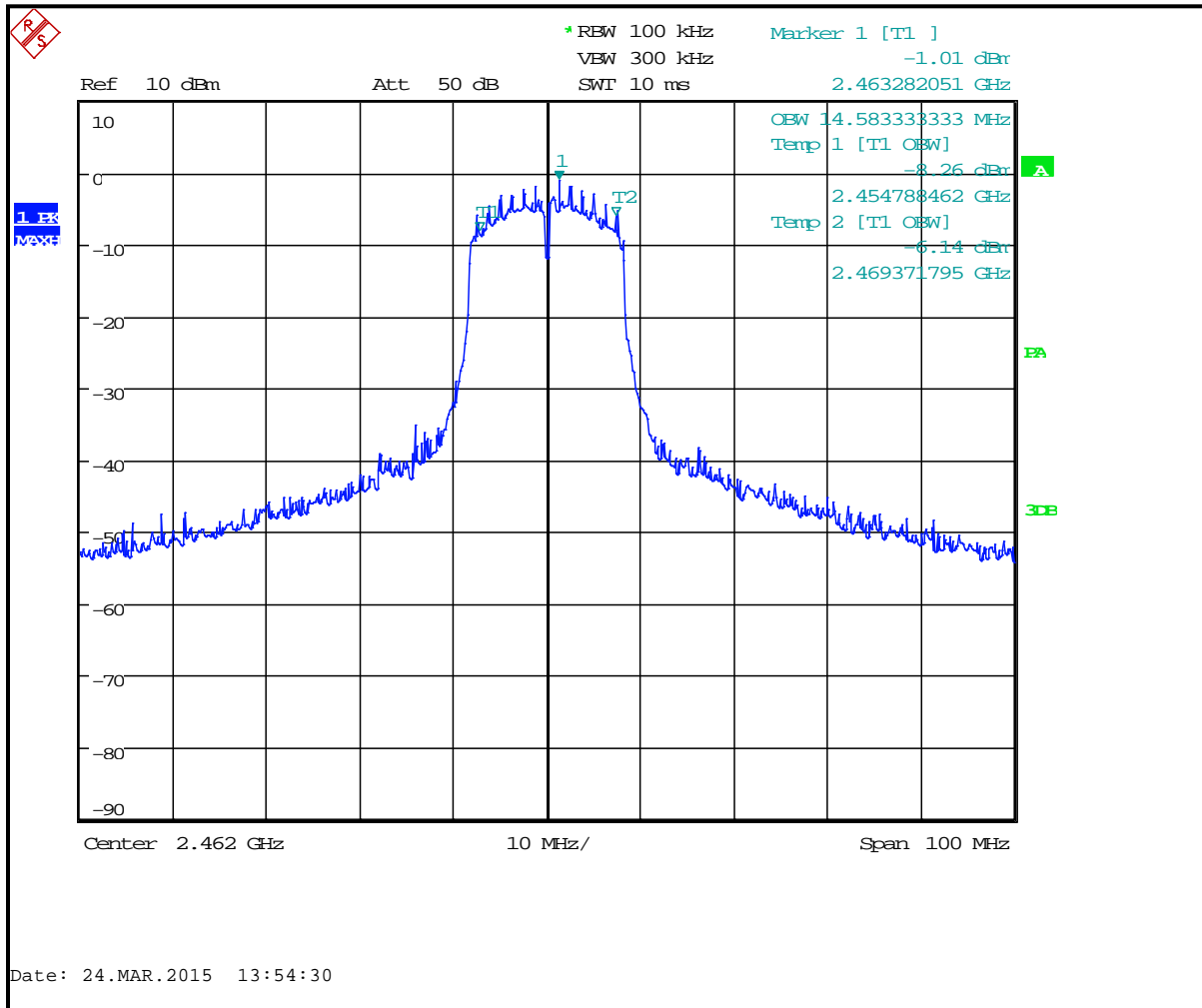

**Plot 6-10: 6 dB Bandwidth Channel 8 (TX Frequency 2437 MHz-40 MHz BW) - 802.11n**

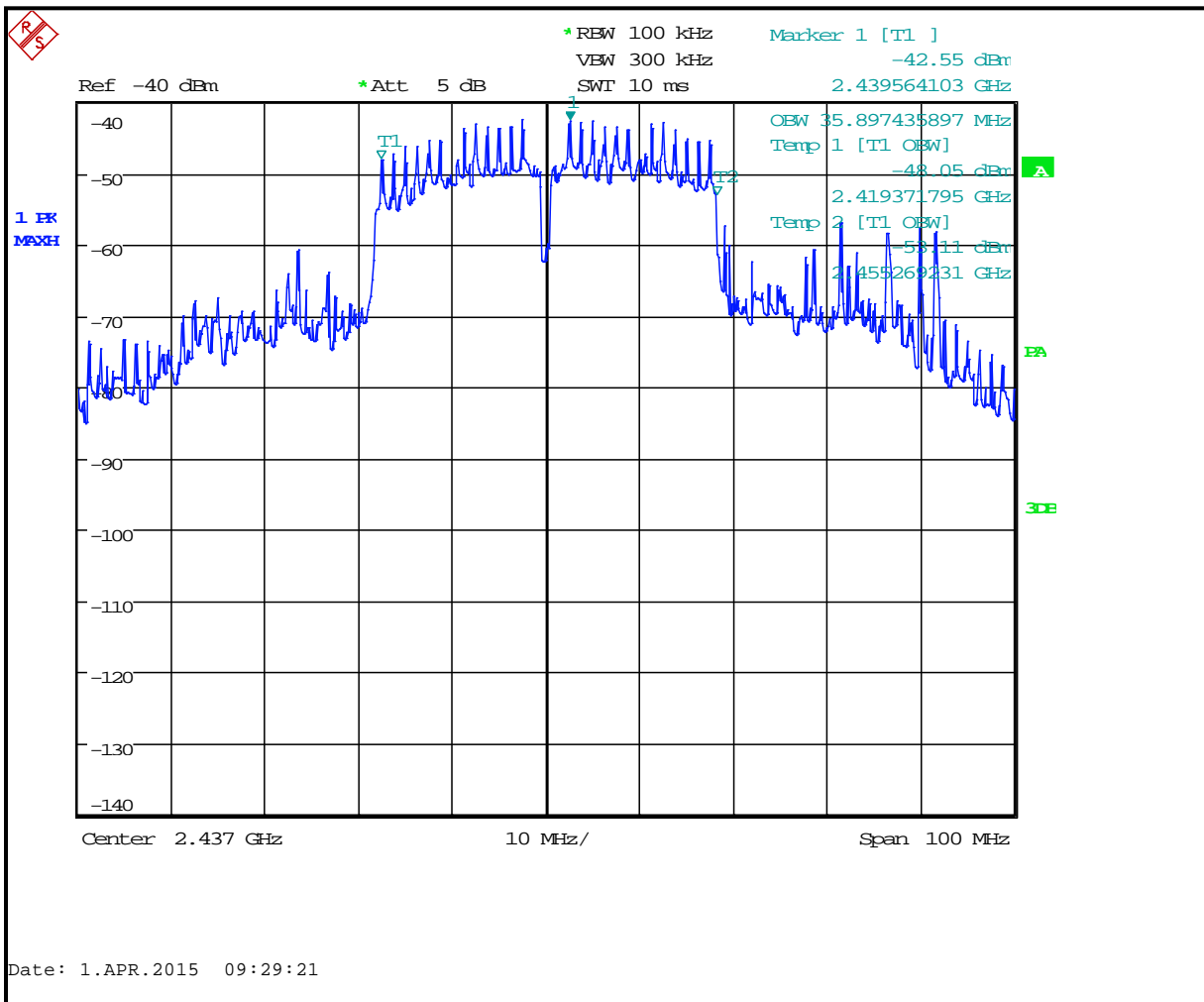

**Test Personnel:**

Daniel W. Baltzell  
 Test Engineer

*Daniel W. Baltzell*  
 Signature

March 15 - April 1, 2015  
 Dates of Test

## 7 Power Spectral Density – FCC 15.247(e); RSS-247 5.2(b)

### 7.1 Power Spectral Density Test Procedure

The power spectral density per FCC 15.247(e) was measured using a 50-ohm spectrum analyzer with the resolution bandwidth set at 3 kHz, the video bandwidth set at 10 kHz, and the auto sweep time. The spectral lines were resolved for the modulated carriers at 2412 MHz, 2437 MHz, 2462 MHz, 5745 MHz, 5785 MHz, and 5825 MHz respectively. These levels are below the +8 dBm limit. See the power spectral density table and plots.

**Table 7-1: Power Spectral Density Test Equipment**

RTL Asset #	Manufacturer	Model	Part Type	Serial Number	Calibration Due Date
901581	Rohde & Schwarz	FSU	Spectrum Analyzer	1166.1660.50	11/13/15

### 7.2 Power Spectral Density Test Data – DSSS WLAN

**Table 7-2: Power Spectral Density Test Data – 802.11b (2 Mbps)**

Channel	Frequency (MHz)	RF Power Level (dBm)	Maximum Limit +8dBm	Pass/Fail
1	2412	-6.6	8	Pass
6	2437	-8.2	8	Pass
11	2462	-7.7	8	Pass

**Table 7-3: Power Spectral Density Test Data – 802.11g (18 Mbps)**

Channel	Frequency (MHz)	RF Power Level (dBm)	Maximum Limit +8dBm	Pass/Fail
1	2412	-14.5	8	Pass
6	2437	-18.1	8	Pass
11	2462	-17.2	8	Pass

**Table 7-4: Power Spectral Density Test Data – 802.11n (13 Mbps-20MHz BW)**

Channel	Frequency (MHz)	RF Power Level (dBm)	Maximum Limit +8dBm	Pass/Fail
1	2412	-17.0	8	Pass
6	2437	-15.3	8	Pass
11	2462	-17.6	8	Pass

**Table 7-5: Power Spectral Density Test Data – 802.11n (40 MHz BW)**

Channel	Frequency (MHz)	RF Power Level (dBm)	Maximum Limit +8dBm	Pass/Fail
5	2442	-18.2	8	Pass

Plot 7-1: Power Spectral Density: Channel 1 (2412 MHz); 802.11b (2 Mbps)

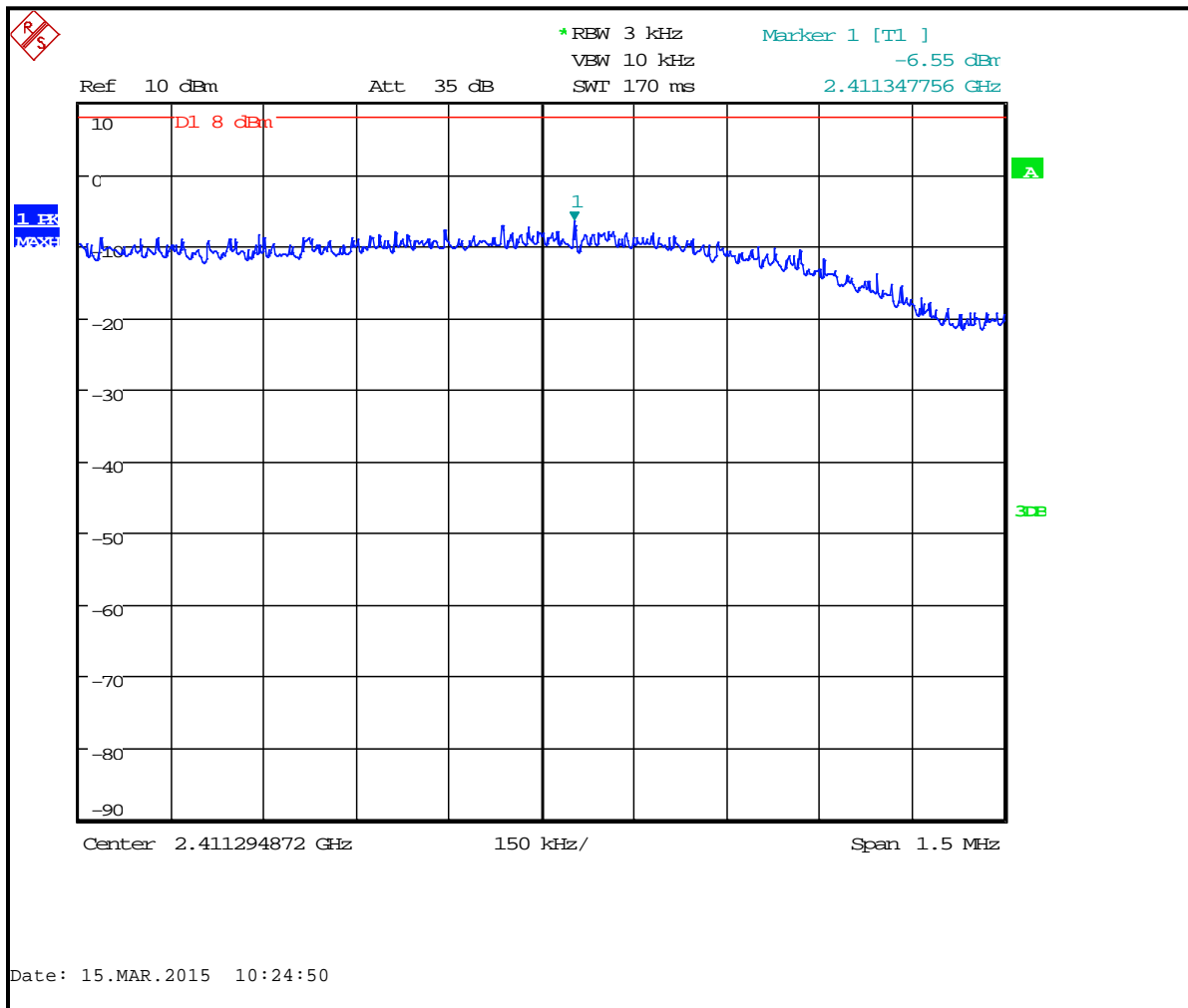



**Plot 7-2: Power Spectral Density: Channel 6 (2437 MHz); 802.11b (2 Mbps)**

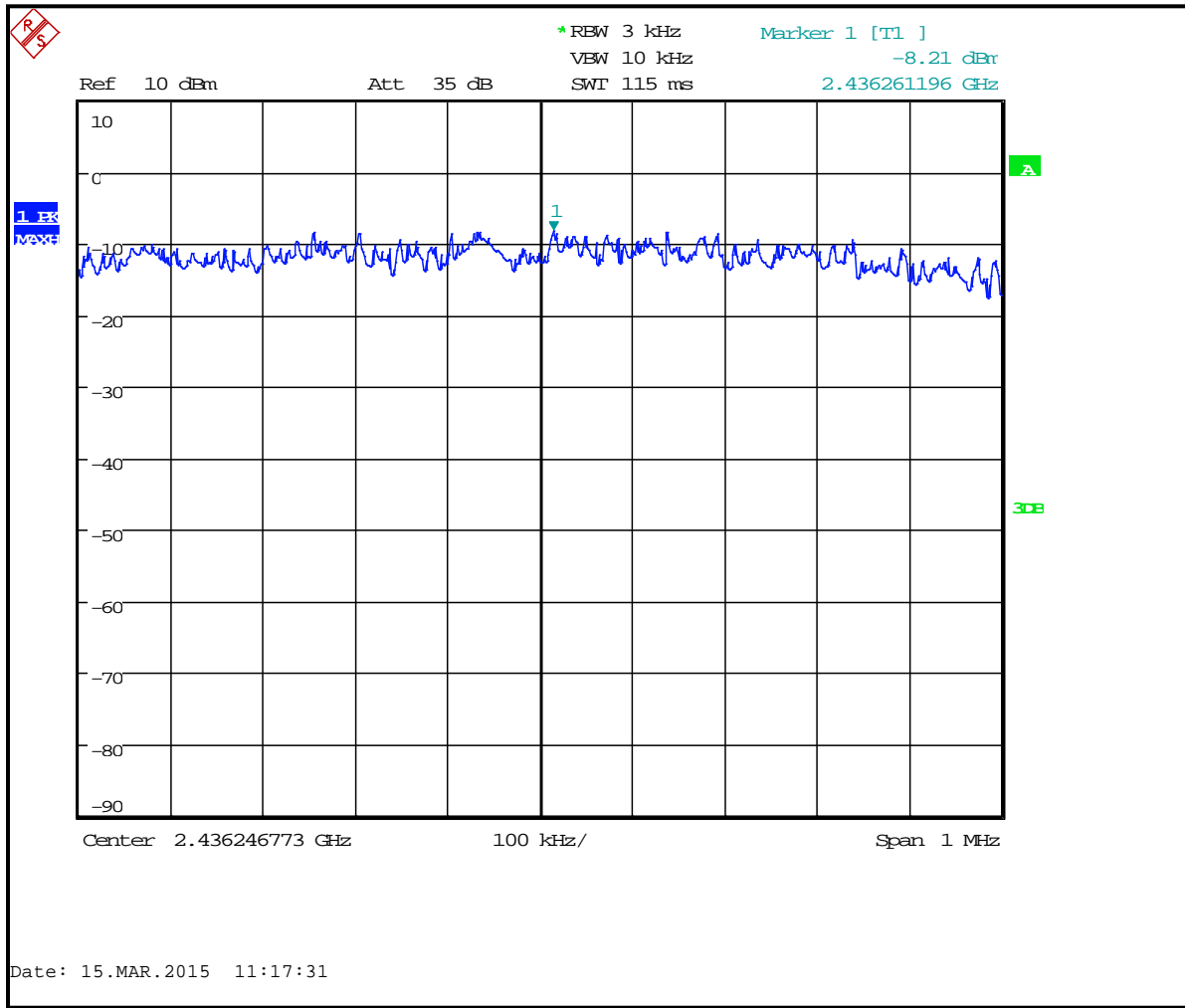

**Plot 7-3: Power Spectral Density: Channel 11 (2462 MHz); 802.11b (2 Mbps)**

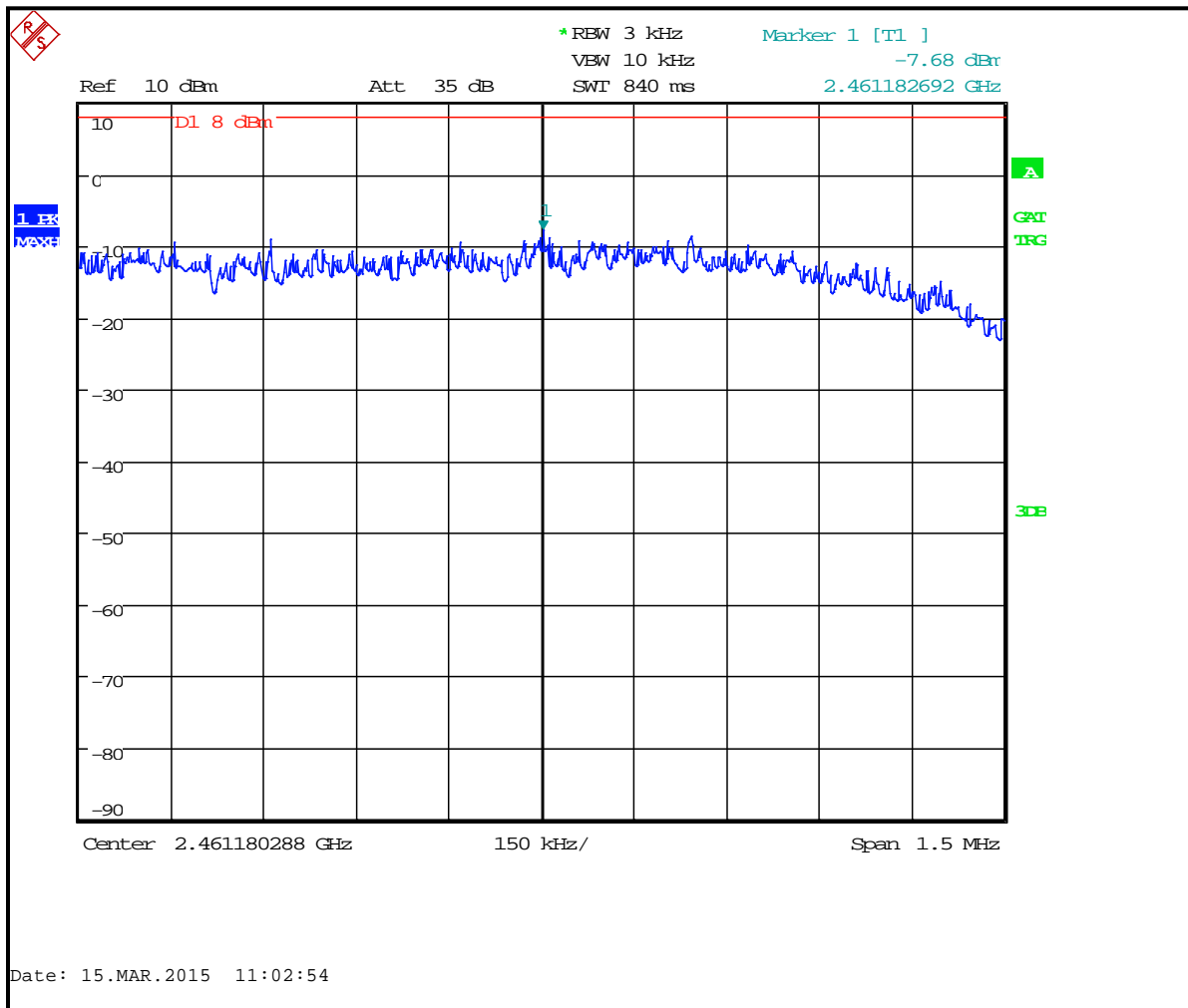

Plot 7-4: Power Spectral Density: Channel 1 (2412 MHz); 802.11g (18 Mbps)

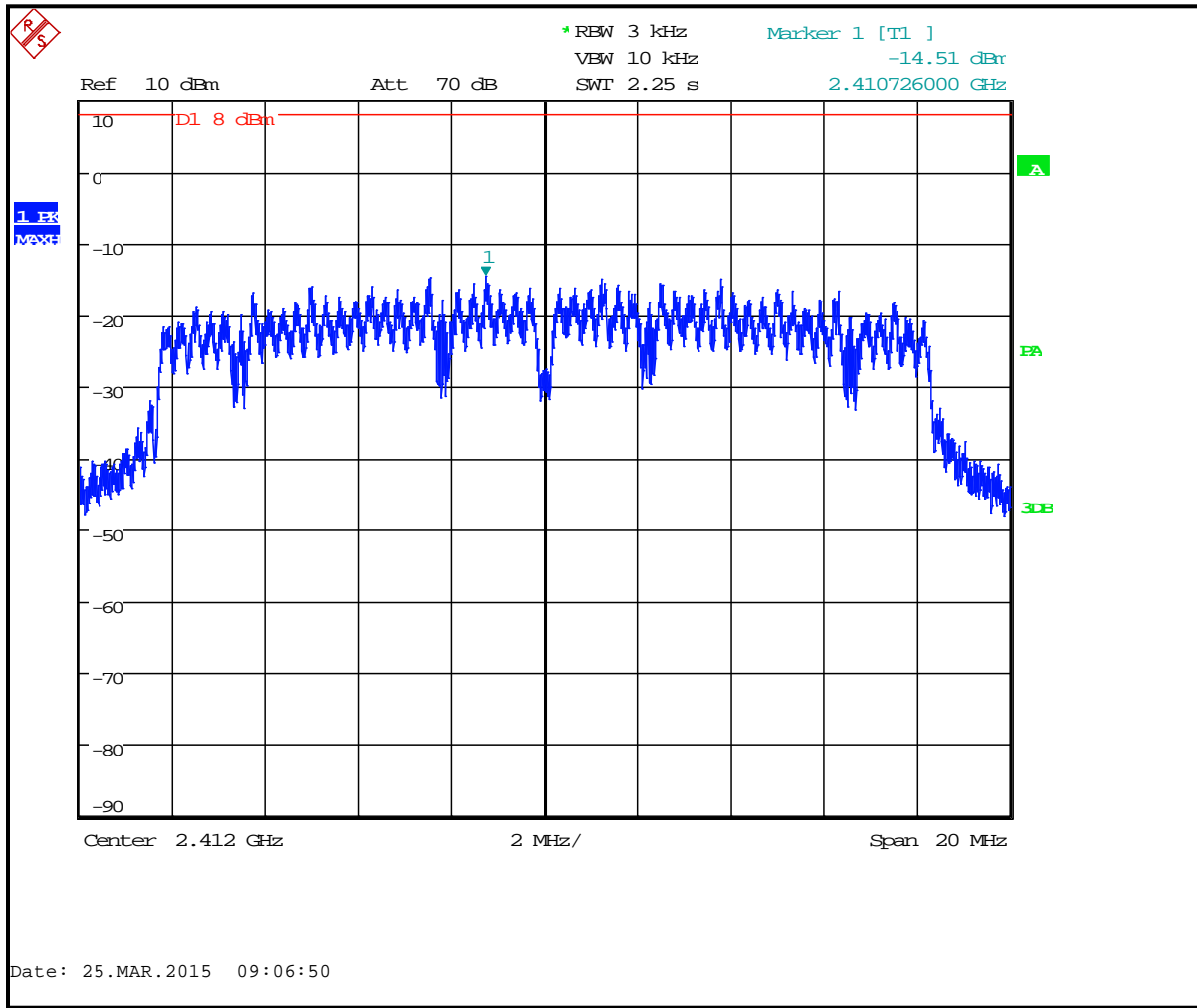

Plot 7-5: Power Spectral Density: Channel 6 (2437 MHz); 802.11g (18 Mbps)

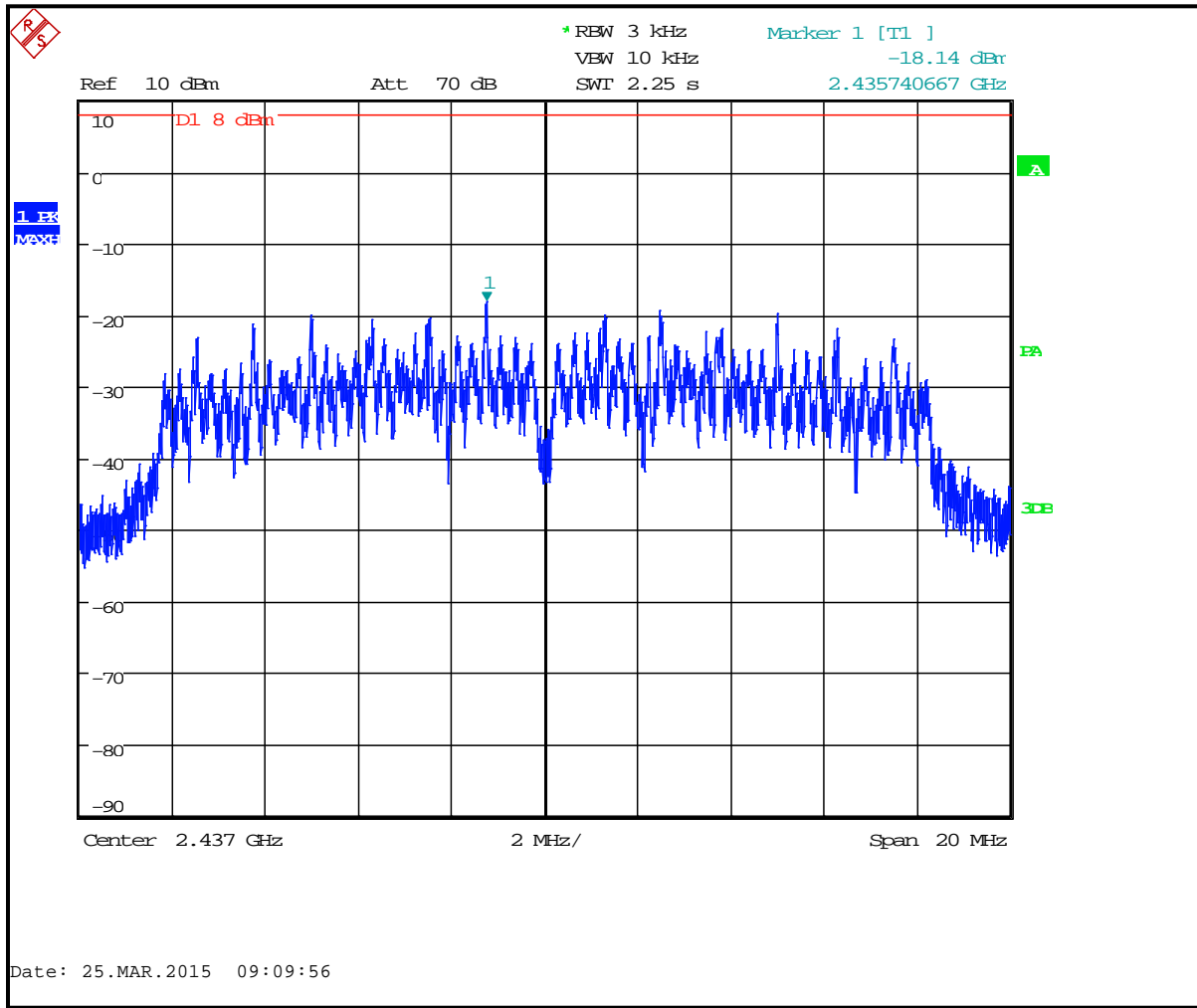

Plot 7-6: Power Spectral Density: Channel 11 (2462 MHz); 802.11g (18 Mbps)

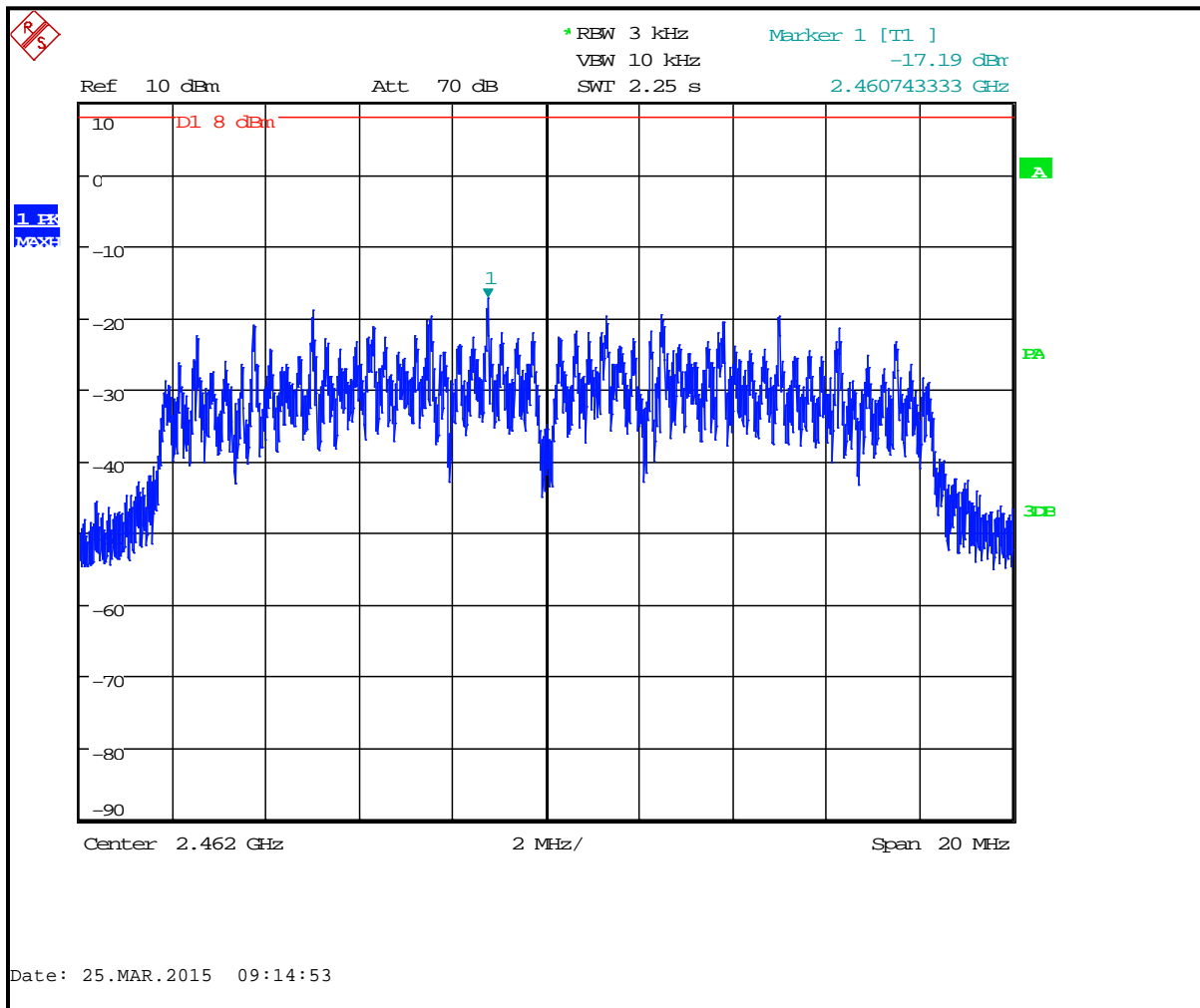

Plot 7-7: Power Spectral Density: Channel 1 (2412 MHz); 802.11n (13 Mbps)

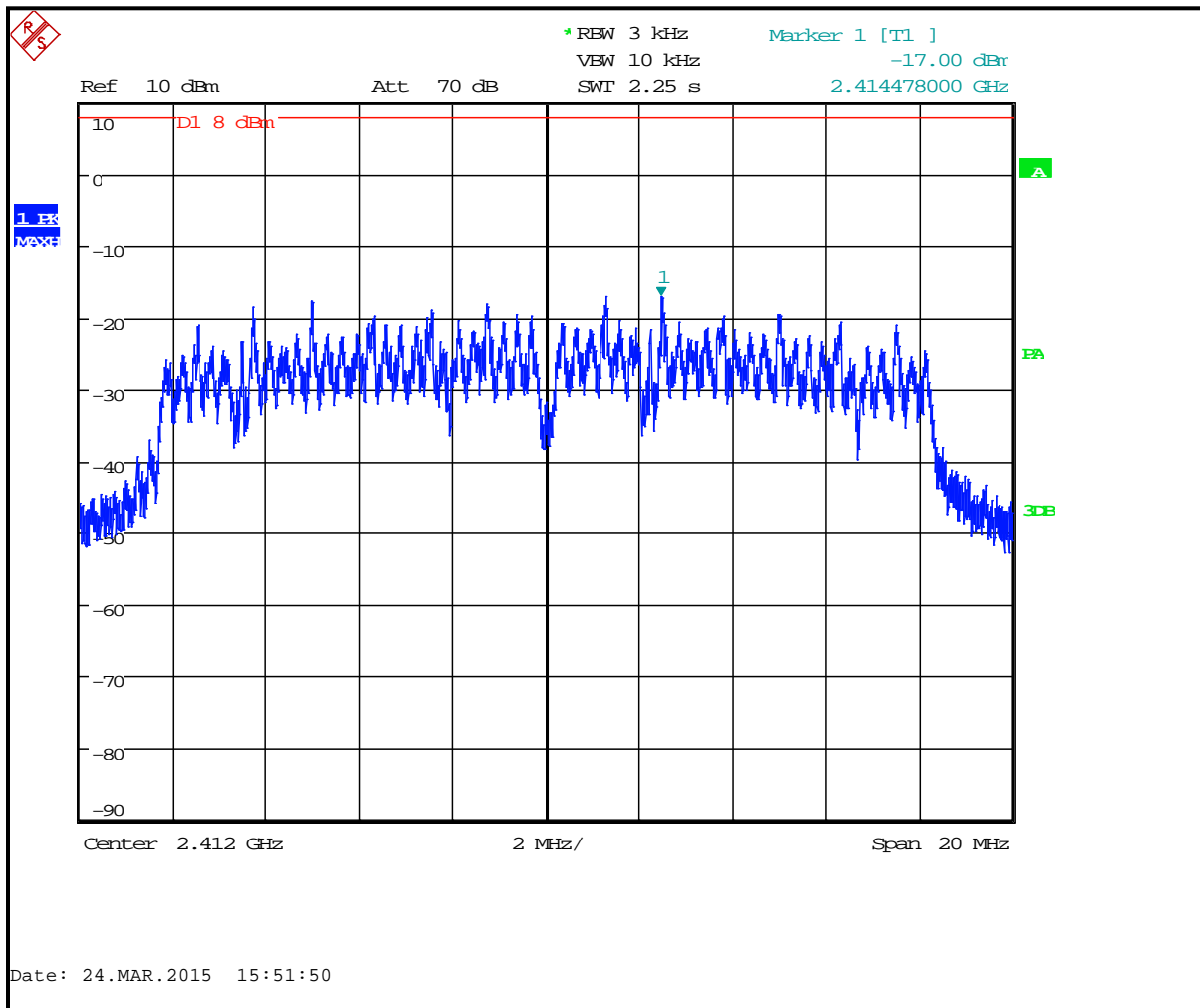

Plot 7-8: Power Spectral Density: Channel 6 (2437 MHz); 802.11n (13 Mbps)

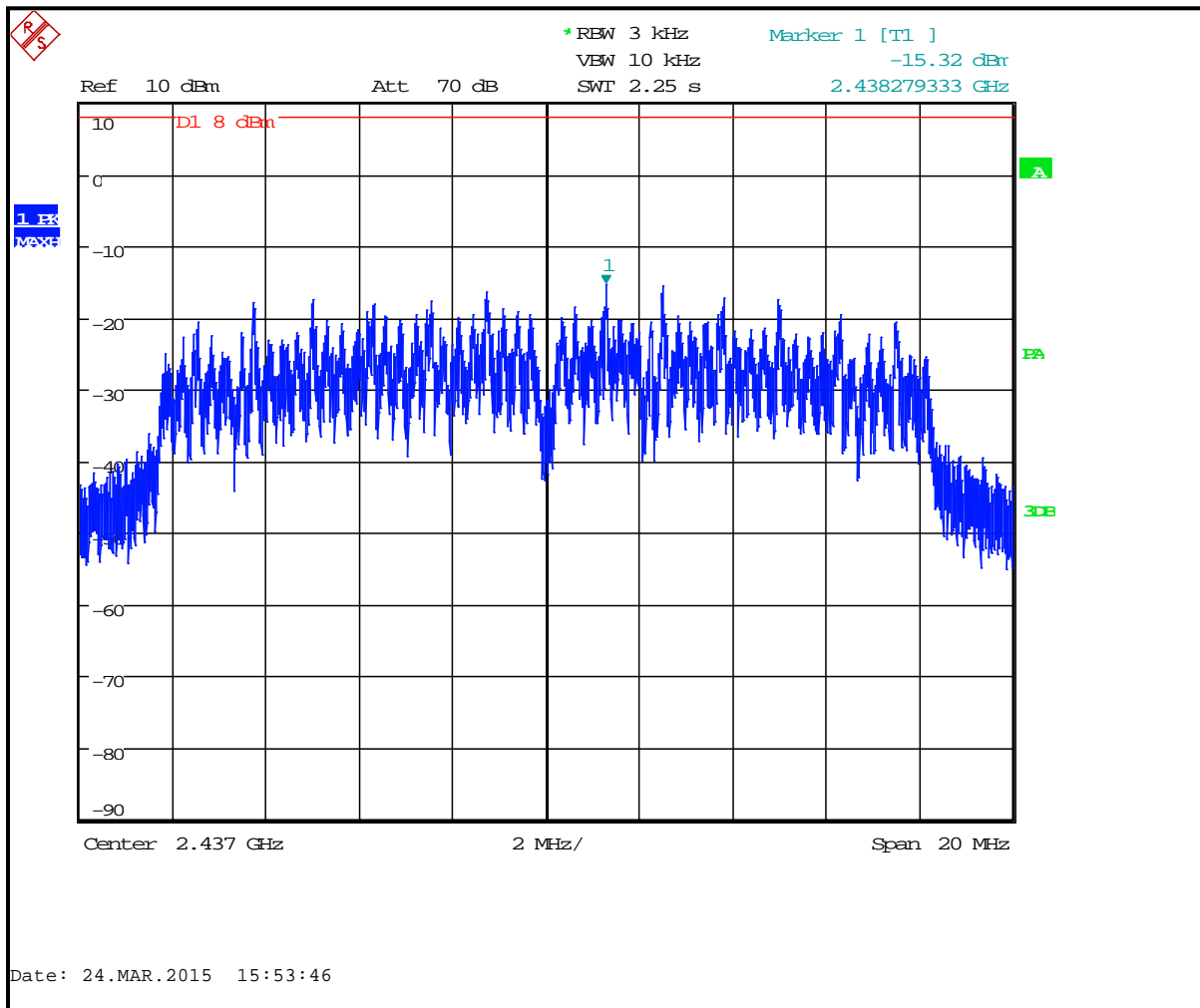

Plot 7-9: Power Spectral Density: Channel 11 (2462 MHz); 802.11n (13 Mbps)

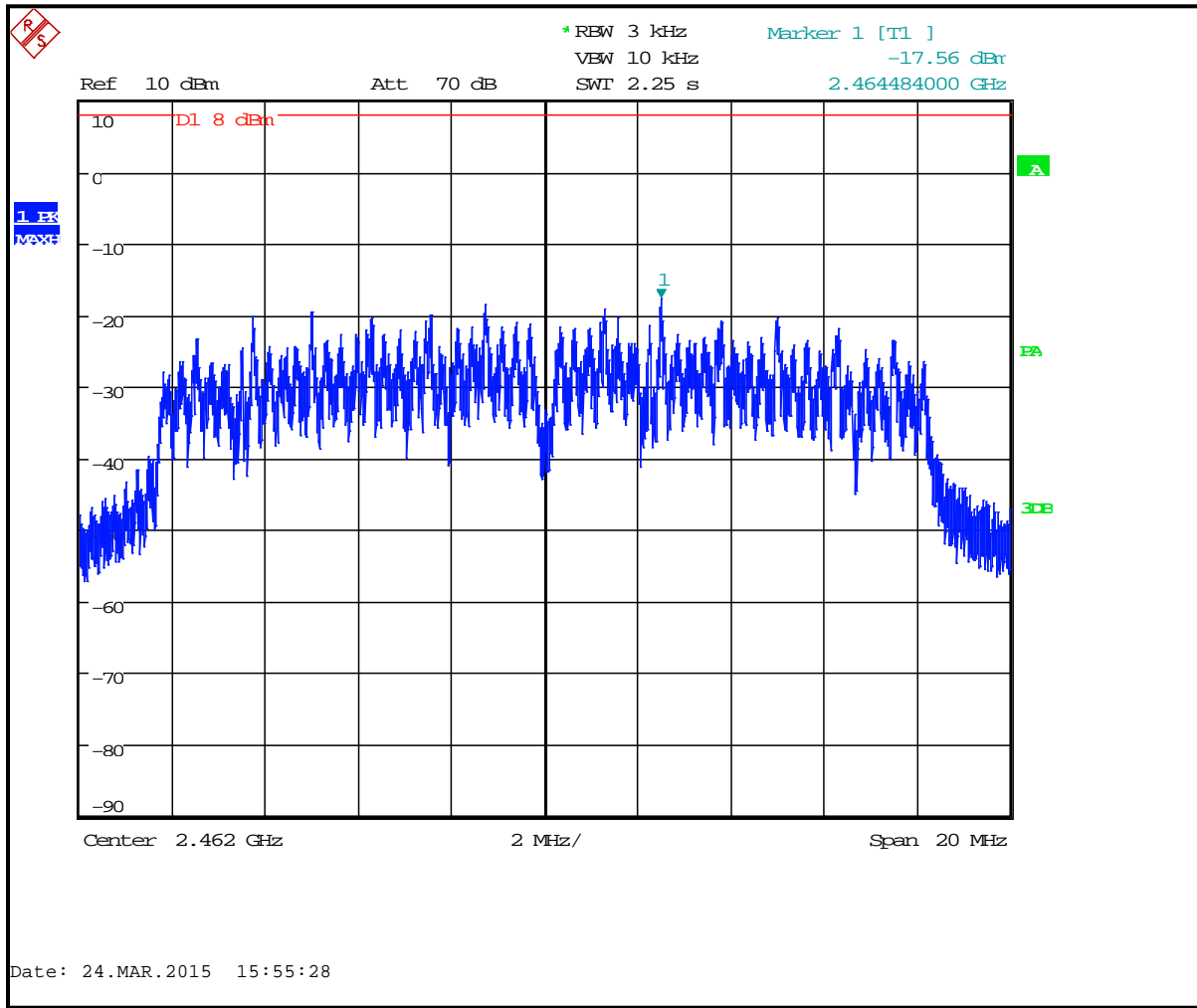



**Plot 7-10: Power Spectral Density: Channel 5 (2442 MHz); 802.11n (40MHz BW)**

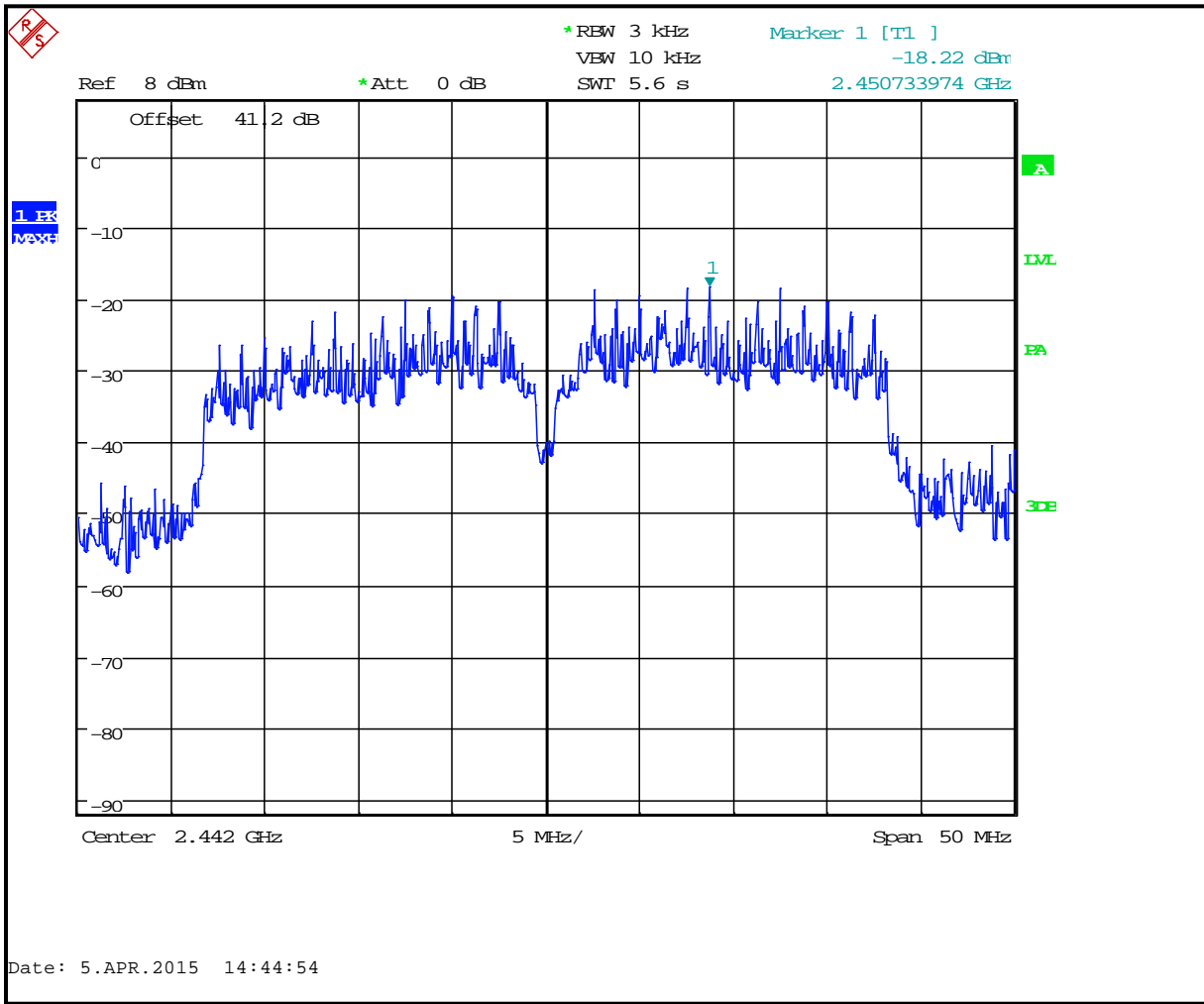

**Test Personnel:**

Daniel W. Baltzell  
Test Engineer

*Daniel W. Baltzell*  
Signature

March 15-April 5, 2015  
Dates of Test

## 8 Radiated Emissions – FCC 15.209; RSS-247 5.5 and RSS-Gen

### 8.1 Limits of Radiated Emissions Measurement

Frequency (MHz)	Field Strength (uV/m)	Measurement Distance (m)
0.009-0.490	2400/f (kHz)	300
0.490-1.705	2400/f (kHz)	30
1.705-30.0	30	30
30-88	100	3
88-216	150	3
216-960	200	3
Above 960	500	3

As shown in 15.35(b), for frequencies above 1000 MHz, the field strength limits are based on average detector, however, the peak field strength of any emission shall not exceed the maximum permitted average limits, specified above by more than 20 dB under any circumstances of modulation.

### 8.2 Radiated Emissions Measurement Test Procedure

Procedure: C63.10-2013 6.5, 6.6

Before final measurements of radiated emissions were made on the open-field three/ten meter range, the EUT was scanned indoors at one and three meter distances. This was done in order to determine its emissions spectrum signature. The physical arrangement of the test system and associated cabling was varied in order to determine the effect on the EUT's emissions in amplitude, direction and frequency. This process was repeated during final radiated emissions measurements on the open-field range, at each frequency, in order to ensure that maximum emission amplitudes were attained.

Final radiated emissions measurements were made on the three/ten-meter, open-field test site. The EUT was placed on a nonconductive turntable 0.8 meters above the ground plane. The spectrum was examined from 9 kHz to the 10<sup>th</sup> harmonic of the highest fundamental transmitter frequency.

At each frequency, the EUT was rotated 360°, and the antenna was raised and lowered from 1 to 4 meters in order to determine the emission's maximum level. Measurements were taken using both horizontal and vertical antenna polarizations. For frequencies between 30 and 1000 MHz, the spectrum analyzer's 6 dB bandwidth was set to 120 kHz, and the analyzer was operated in the CISPR quasi-peak detection mode. For emissions above 1,000 MHz, emissions are measured using the average detector function with a minimum resolution bandwidth of 1 MHz. No video filter less than 10 times the resolution bandwidth was used. The highest emission amplitudes relative to the appropriate limit were measured and recorded in this report.

**Table 8-1: Radiated Emissions Test Equipment**

RTL Asset #	Manufacturer	Model	Part Type	Serial Number	Calibration Due Date
900878	Rhein Tech Laboratories, Inc.	AM3-1197-0005	3 meter antenna mast, polarizing	OATS1	N/A
901592	Insulated Wire Inc.	KPS-1503-3600-KPR	SMK RF Cables 20'	NA	9/3/15
901593	Insulated Wire Inc.	KPS-1503-360-KPR	SMK RF Cables 36"	NA	9/3/15
901594	Insulated Wire Inc.	KPS-1503-360-KPR	SMK RF Cables 36"	NA	9/3/15
901242	Rhein Tech Laboratories, Inc.	WRT-000-0003	Wood rotating table	N/A	N/A
900791	Chase	CBL6111B	Bilog Antenna (30 MHz – 2000 MHz)	N/A	6/11/17
901218	EMCO	3160-09	Horn Antenna (18 - 26.5 GHz)	960281-003	4/14/18
900772	EMCO	3161-02	Horn Antenna (2 - 4 GHz)	9804-1044	4/09/18
900321	EMCO	3161-03	Horn Antennas (4 – 8.2 GHz)	9508-1020	4/09/18
900323	EMCO	3160-07	Horn Antennas (8.2 – 12.4 GHz)	9605-1054	4/09/18
900356	EMCO	3160-08	Horn Antennas (12.4 – 18 GHz)	9607-1044	4/09/18
901581	Rohde & Schwarz	FSU	Spectrum Analyzer	1166.1660.50	11/13/15

### 8.3 Radiated Emissions Test Results

#### 8.3.1 Radiated Emissions Harmonics/Spurious

**Table 8-2: 2412 MHz; 802.11b; 2 Mbps; Channel 1; Average Mode**

Frequency (MHz)	Spectrum Analyzer Average Level (1 MHz RBW/ 10 Hz VBW) (dBuV)	Site Correction Factor (dB/m)	Corrected Average Level (dBuV/m)	Limit (dBuV/m)	Margin (dB)
4824	17.7	33.2	50.9	54.0	-3.1
12060	-7.9	44.0	36.1	54.0	-17.9
14472	-14.8	47.9	33.1	54.0	-20.9
19296	-9.7	52.9	43.2	54.0	-10.8

**Table 8-3: 2437 MHz; 802.11b; 2 Mbps; Channel 6; Average Mode**

Frequency (MHz)	Spectrum Analyzer Average Level (1 MHz RBW/ 10 Hz VBW) (dBuV)	Site Correction Factor (dB/m)	Corrected Average Level (dBuV/m)	Limit (dBuV/m)	Margin (dB)
4874	11.1	33.3	44.4	54.0	-9.6
7311	0.6	35.7	36.3	54.0	-17.7
12185	-8.7	44.0	35.3	54.0	-18.7
19496	-10.2	53.0	42.8	54.0	-11.2

**Table 8-4: 2462 MHz; 802.11b; 2 Mbps; Channel 11; Average Mode**

Frequency (MHz)	Spectrum Analyzer Average Level (1 MHz RBW/ 10 Hz VBW) (dBuV)	Site Correction Factor (dB/m)	Corrected Average Level (dBuV/m)	Limit (dBuV/m)	Margin (dB)
4924	6.9	33.4	40.3	54.0	-13.7
7386	0.2	35.7	35.9	54.0	-18.1
12310	-8.6	44.0	35.4	54.0	-18.6
19696	-9.9	53.1	43.2	54.0	-10.8
22158	-11.7	54.2	42.5	54.0	-11.5

**Table 8-5: 2412 MHz; 802.11g; 11 Mbps; Channel 1; Average Mode**

Frequency (MHz)	Spectrum Analyzer Average Level (1 MHz RBW/ 10 Hz VBW) (dBuV)	Site Correction Factor (dB/m)	Corrected Average Level (dBuV/m)	Limit (dBuV/m)	Margin (dB)
4824	5.6	33.2	38.8	54.0	-15.2
12060	0.3	44.0	44.3	54.0	-9.7
14472	-4.1	47.9	43.8	54.0	-10.2
19296	-6.7	52.9	46.2	54.0	-7.8

**Table 8-6: 2437 MHz; 802.11g; 11 Mbps; Channel 6; Average Mode**

Frequency (MHz)	Spectrum Analyzer Average Level (1 MHz RBW/ 10 Hz VBW) (dBuV)	Site Correction Factor (dB/m)	Corrected Average Level (dBuV/m)	Limit (dBuV/m)	Margin (dB)
4874	5.7	33.3	39.0	54.0	-15.0
7311	0.1	35.7	35.8	54.0	-18.2
12185	0.5	44.0	44.5	54.0	-9.5
19496	-9.3	53.0	43.7	54.0	-10.3

**Table 8-7: 2462 MHz; 802.11g; 11 Mbps; Channel 11; Average Mode**

Frequency (MHz)	Spectrum Analyzer Average Level (1 MHz RBW/ 10 Hz VBW) (dBuV)	Site Correction Factor (dB/m)	Corrected Average Level (dBuV/m)	Limit (dBuV/m)	Margin (dB)
4924	3.0	33.4	36.4	54.0	-17.6
7386	0.1	35.7	35.8	54.0	-18.2
12310	0.1	44.0	44.1	54.0	-9.9
19696	-9.3	53.1	43.8	54.0	-10.2
22158	-8.2	54.2	46.0	54.0	-8.0

**Table 8-8: 2412 MHz; 802.11n; 65 Mbps; Channel 1; Average Mode**

Frequency (MHz)	Spectrum Analyzer Average Level (1 MHz RBW/ 10 Hz VBW) (dBuV)	Site Correction Factor (dB/m)	Corrected Average Level (dBuV/m)	Limit (dBuV/m)	Margin (dB)
4824	1.9	33.2	35.1	54.0	-18.9
12060	0.3	44.0	44.3	54.0	-9.7
14472	-9.8	47.9	38.1	54.0	-15.9
19296	-9.4	52.9	43.5	54.0	-10.5

**Table 8-9: 2437 MHz; 802.11n; 65 Mbps; Channel 6; Average Mode**

Frequency (MHz)	Spectrum Analyzer Average Level (1 MHz RBW/ 10 Hz VBW) (dBuV)	Site Correction Factor (dB/m)	Corrected Average Level (dBuV/m)	Limit (dBuV/m)	Margin (dB)
4874	1.8	33.3	35.1	54.0	-18.9
7311	-0.2	35.7	35.5	54.0	-18.5
12185	-0.3	44.0	43.7	54.0	-10.3
19496	-9.2	53.0	43.8	54.0	-10.2

**Table 8-10: 2462 MHz; 802.11n; 65 Mbps; Channel 11; Average Mode**

Frequency (MHz)	Spectrum Analyzer Average Level (1 MHz RBW/ 10 Hz VBW) (dBuV)	Site Correction Factor (dB/m)	Corrected Average Level (dBuV/m)	Limit (dBuV/m)	Margin (dB)
4924	1.4	33.4	34.8	54.0	-19.2
7386	0.0	35.7	35.7	54.0	-18.3
12310	-0.6	44.0	43.4	54.0	-10.6
19696	-9.2	53.1	43.9	54.0	-10.1
22158	-8.4	54.2	45.8	54.0	-8.2
4924	1.4	33.4	34.8	54.0	-19.2

**Table 8-11: 2412 MHz; 802.11b; 2 Mbps; Channel 1; Peak Mode**

Frequency (MHz)	Spectrum Analyzer Peak Level (1 MHz RBW/ 3 MHz VBW) (dBuV)	Site Correction Factor (dB/m)	Corrected Peak Level (dBuV/m)	Limit (dBuV/m)	Margin (dB)
4824	21.6	33.2	54.8	74.0	-19.2
12060	4.4	44.0	48.4	74.0	-25.6
14472	4.8	47.9	52.7	74.0	-21.3
19296	2.4	52.9	55.3	74.0	-18.7

**Table 8-12: 2437 MHz; 802.11b; 2 Mbps; Channel 6; Peak Mode**

Frequency (MHz)	Spectrum Analyzer Peak Level (1 MHz RBW/ 3 MHz VBW) (dBuV)	Site Correction Factor (dB/m)	Corrected Peak Level (dBuV/m)	Limit (dBuV/m)	Margin (dB)
4874	17.7	33.3	51.0	74.0	-23.0
7311	12.8	35.7	48.5	74.0	-25.5
12185	1.2	44.0	45.2	74.0	-28.8
19496	1.2	53.0	54.2	74.0	-19.8

**Table 8-13: 2462 MHz; 802.11b; 2 Mbps; Channel 11; Peak Mode**

Frequency (MHz)	Spectrum Analyzer Peak Level (1 MHz RBW/ 3 MHz VBW) (dBuV)	Site Correction Factor (dB/m)	Corrected Peak Level (dBuV/m)	Limit (dBuV/m)	Margin (dB)
4924	15.1	33.4	48.5	74.0	-25.5
7386	13.6	35.7	49.3	74.0	-24.7
12310	1.3	44.0	45.3	74.0	-28.7
19696	0.4	53.1	53.5	74.0	-20.5
22158	-2.0	54.2	52.2	74.0	-21.8

**Table 8-14: 2412 MHz; 802.11g; 11 Mbps; Channel 1; Peak Mode**

Frequency (MHz)	Spectrum Analyzer Peak Level (1 MHz RBW/ 3 MHz VBW) (dBuV)	Site Correction Factor (dB/m)	Corrected Peak Level (dBuV/m)	Limit (dBuV/m)	Margin (dB)
4824	17.8	33.2	51.0	74.0	-23.0
12060	13.5	44.0	57.5	74.0	-16.5
14472	6.2	47.9	54.1	74.0	-19.9
19296	5.3	52.9	58.2	74.0	-15.8

**Table 8-15: 2437 MHz; 802.11g; 11 Mbps; Channel 6; Peak Mode**

Frequency (MHz)	Spectrum Analyzer Peak Level (1 MHz RBW/ 3 MHz VBW) (dBuV)	Site Correction Factor (dB/m)	Corrected Peak Level (dBuV/m)	Limit (dBuV/m)	Margin (dB)
4874	18.0	33.3	51.3	74.0	-22.7
7311	13.5	35.7	49.2	74.0	-24.8
12185	13.3	44.0	57.3	74.0	-16.7
19496	4.0	53.0	57.0	74.0	-17.0

**Table 8-16: 2462 MHz; 802.11g; 11 Mbps; Channel 11; Peak Mode**

Frequency (MHz)	Spectrum Analyzer Peak Level (1 MHz RBW/ 3 MHz VBW) (dBuV)	Site Correction Factor (dB/m)	Corrected Peak Level (dBuV/m)	Limit (dBuV/m)	Margin (dB)
4924	13.5	33.4	46.9	74.0	-27.1
7386	13.4	35.7	49.1	74.0	-24.9
12310	13.1	44.0	57.1	74.0	-16.9
19696	4.0	53.1	57.1	74.0	-16.9
22158	5.3	54.2	59.5	74.0	-14.5



**Table 8-17: 2412 MHz; 802.11n; 65 Mbps; Channel 1; Peak Mode**

Frequency (MHz)	Spectrum Analyzer Peak Level (1 MHz RBW/ 3 MHz VBW) (dBuV)	Site Correction Factor (dB/m)	Corrected Peak Level (dBuV/m)	Limit (dBuV/m)	Margin (dB)
4824	16.5	33.2	49.7	74.0	-24.3
12060	13.3	44.0	57.3	74.0	-16.7
14472	3.3	47.9	51.2	74.0	-22.8
19296	3.8	52.9	56.7	74.0	-17.3

**Table 8-18: 2437 MHz; 802.11n; 65 Mbps; Channel 6; Peak Mode**

Frequency (MHz)	Spectrum Analyzer Peak Level (1 MHz RBW/ 3 MHz VBW) (dBuV)	Site Correction Factor (dB/m)	Corrected Peak Level (dBuV/m)	Limit (dBuV/m)	Margin (dB)
4874	14.6	33.3	47.9	74.0	-26.1
7311	13.2	35.7	48.9	74.0	-25.1
12185	12.6	44.0	56.6	74.0	-17.4
19496	3.9	53.0	56.9	74.0	-17.1

**Table 8-19: 2462 MHz; 802.11n; 65 Mbps; Channel 11; Peak Mode**

Frequency (MHz)	Spectrum Analyzer Peak Level (1 MHz RBW/ 3 MHz VBW) (dBuV)	Site Correction Factor (dB/m)	Corrected Peak Level (dBuV/m)	Limit (dBuV/m)	Margin (dB)
4924	13.1	33.4	46.5	74.0	-27.5
7386	13.1	35.7	48.8	74.0	-25.2
12310	11.8	44.0	55.8	74.0	-18.2
19696	4.1	53.1	57.2	74.0	-16.8
22158	4.9	54.2	59.1	74.0	-14.9

**Test Personnel:**

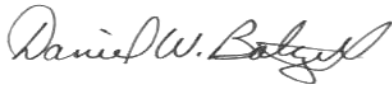
Daniel W. Baltzell EMC Test Engineer	 Signature	March 29, 2015 Date of Test
---	--	--------------------------------

Rhein Tech Laboratories, Inc.  
360 Herndon Parkway  
Suite 1400  
Herndon, VA 20170  
<http://www.rheintech.com>

Client: Harris Corporation  
Model: XL-200P C1D1 Non-Rebanded  
Standards: FCC 15.247/IC RSS-247  
ID's: OWDTR-0146-E/3636B-0146  
Report #: 2017007DTS

## **9 Conclusion**

The data in this measurement report shows that the Harris Corporation Model XL-200P C1D1 Non-Rebanded, FCC ID: OWDTR-0146-E, IC: 3636B-0146, complies with the applicable intentional radiated requirements of FCC Parts 2 and 15 and Industry Canada RSS-Gen and RSS-247.