



Engineering Solutions & Electromagnetic Compatibility Services

FCC & ISED Certification Report

**Harris Corporation
221 Jefferson Ridge Parkway
Lynchburg, VA 24501
Contact: Paresh Chauhan
pchauhan@harris.com**

**Model: XL-185P 7/8/900 MHz
Multiband Portable Radio**

**FCC ID: OWDTR-0143-E
IC: 3636B-0143**

May 5, 2017

Standards Referenced for this Report	
Part 2: 2015	Frequency Allocations and Radio Treaty Matters; General Rules and Regulations
Part 24: 2016	Personal Communications Services
Part 90: 2016	Private Land Mobile Radio Services
Part 101: 2016	Fixed Microwave Services
ANSI/TIA-603-D 2010	Land Mobile FM50 or PM Communications Equipment – Measurement and Performance Standards
RSS-119 Issue 12	Land Mobile and Fixed Radio Transmitters and Receivers 27.41 to 960.0 MHz

Report Prepared By: Daniel Baltzell

Document Number: 2016219TNF

This report may not be reproduced, except in full, without the full written approval of Rhein Tech Laboratories, Inc. and Harris Corporation. Test results relate only to the item tested.

*These tests are accredited and meet the requirements of ISO/IEC 17025 as verified by ANAB.
Refer to certificate and scope of accreditation AT-1445.*

Frequency Range (MHz)	Rated Conducted Output Power (W)	Frequency Tolerance (ppm)	Transmit Mode	Emission Designator
809 – 816 851 – 861 901 – 902 940 – 941 941 – 944	0.5 – 3.0	0.5	Analog FM (WB)	16K0F3E
809 – 816 851 – 861 901 – 902 940 – 941 941 – 944	0.5 – 3.0	0.5	2-level FSK 9600 Data/ Digital Voice (WB)	16K0F1D/E
806 – 809 851 – 861	0.5 – 3.0	0.5	Analog FM (NPSPAC)	14K0F3E
806 – 809 851 – 861	0.5 – 3.0	0.5	2-level FSK 9600 Data/ Digital Voice (NPSPAC)	14K0F1D/E
769 – 775 (FCC) 768 – 776 (ISED) 799 – 805 (FCC) 798 – 806 (ISED) 806 – 816 851 – 861 896 – 901 901 – 902 935 – 940 940 – 941 941 – 944	0.5 – 3.0	0.5	Analog FM (NB)	11K0F3E
769 – 775 (FCC) 768 – 776 (ISED) 799 – 805 (FCC) 798 – 806 (ISED) 806 – 816 851 – 861 896 – 901 901 – 902 935 – 940 940 – 941 941 – 944	0.5 – 3.0	0.5	2-level FSK 9600 Data/ Digital Voice (NB)	11K7F1D/E
896 – 901 901 – 902 935 – 940 940 – 941 941 – 944	0.5 – 3.0	0.5	2-level FSK 4800 Data/ Digital Voice (XNB)	7K10F1D/E
769 – 775 (FCC) 768 – 776 (ISED) 799 – 805 (FCC) 798 – 806 (ISED) 851 – 854 854 – 861 896 – 901	0.5 – 3.0	0.5	C4FM Data/Voice	8K40F1D/E

Rhein Tech Laboratories, Inc.
 360 Herndon Parkway
 Suite 1400
 Herndon, VA20170
<http://www.rheintech.com>

Client: Harris Corporation
 Model: XL-185P 7/8/900 MHz
 ID's: OWDTR-0143-E/3636B-0143
 Standards: FCC Part 24, 90, 101/IC RSS-119
 Report #: 2016219TNF

901 – 902 935 – 940 940 – 941 941 – 944				
769 – 775 (FCC) 768 – 776 (ISED) 799 – 805 (FCC) 798 – 806 (ISED) 851 – 854 854 – 861 896 – 901 901 – 902 935 – 940 940 – 941 941 – 944	0.5 – 3.0	0.5	H-CPM (TDMA) Data/Voice	8K10DXW

Note: As this is a combined FCC and ISED test report, there is test data between 768 – and 769 MHz, 775 – 776 MHz, 798 – 799 MHz and 805 – 806 MHz for frequencies that are only authorized for use in Canada; that is, any test data in the aforementioned frequency ranges is not applicable for the FCC, nor authorized for use in the United States.

Table of Contents

1	Test Result Summary	11
2	General Information	11
2.1	Test Facility	11
2.2	Related Submittal(s)/Grant(s)	11
2.3	Grant Notes	11
2.4	Tested System Details	12
3	FCC Part 2.1033(C)(8): Voltages and Currents through the Final Amplifying Stage	14
4	FCC Part 2.1046(a): RF power output: Conducted; Part 24.132(b): Power and antenna height limits; Part 90.541(b) Transmitting power and antenna height requirements; Part 101.113(a): Transmitter power limitations; IC RSS-119 4.1: Transmitter Output Power.....	14
4.1	Test Procedure.....	14
4.2	Test Data.....	14
5	FCC Part 2.1051: Spurious Emissions at Antenna Terminals; Part 90.210: Emission Limitations	16
5.1	Test Procedure.....	16
5.2	Test Data.....	16
6	FCC Part 90.543(a): Emission Limitations: ACP Requirements; IC RSS-119 4.3 Adjacent Channel Power (ACP) Measurement for Equipment in the Bands 764-776 MHz and 794-806 MHz	17
6.1	Test Procedure.....	17
6.2	Test Data.....	19
7	FCC Part 90.210(g) and Part 2.1053(a): Field Strength of Spurious Radiation; Part 90.543(f): Out of Band Emissions Limit; IC RSS-119 5.8.9.2 Out-of-band Emission Limit	52
7.1	Test Procedure.....	52
7.2	Test Data.....	52
8	FCC Part 2.1049(c)(1): Occupied Bandwidth; Part 24.131, Part 24.133(a)(1),(2): Authorized Bandwidth; Part 90.210 Authorized Bandwidth; Part 101.109, Part 101.111 Bandwidth; IC RSS-119 5.5 Channel Spacing, Authorized Bandwidth, Occupied Bandwidth and Spectrum Masks	65
8.1	Test Procedure.....	65
8.2	Test Data.....	67
9	FCC Part 2.1055: Frequency Stability; Part 24.135: Frequency Stability; Part 90.213, Part 90.539: Frequency Stability; Part 101.107: Frequency Tolerance; IC RSS-119 5.3 Transmitter Frequency Stability ..	182
9.1	Test Procedure.....	182
9.2	Test Data.....	184
9.2.1	Frequency Stability/Voltage Variation	187
10	FCC Part 2.1047: Modulation Characteristics; IC RSS-119 5.8 Types of Modulation	188
10.1	Test Procedures	188
10.1.1	Audio Frequency Response	188
10.1.2	Audio Low Pass Filter Response	188
10.1.3	Modulation Limiting	188
10.2	Test Data.....	189
10.2.1	Audio Frequency Response	189
10.2.2	Audio Low Pass Filter Response	192
10.2.3	Modulation Limiting	195
11	FCC Part 2.202: Necessary Bandwidth and Emission Bandwidth	201
12	Conclusion	202

Table of Figures

Figure 2-1:	Configuration of Tested System	13
-------------	--------------------------------------	----

Table of Tables

Table 2-1:	Equipment Under Test (EUT).....	12
Table 2-2:	Auxiliary Equipment.....	12
Table 4-1:	RF Conducted Output Power – Measured	14
Table 4-2:	Test Equipment Used For Testing RF Power Output - Conducted.....	15
Table 5-1:	Test Equipment Used For Testing Spurious Emissions.....	16
Table 6-1:	Adjacent Channel Power - 768.0125 MHz; Analog Mode (>400 kHz - RX Band)	19
Table 6-2:	Adjacent Channel Power - 769.0125 MHz; Analog Mode (>400 kHz - RX Band)	20
Table 6-3:	Adjacent Channel Power - 772.0125 MHz; Analog Mode (>400 kHz - RX Band)	21
Table 6-4:	Adjacent Channel Power - 775.9875 MHz; Analog Mode (>400 kHz - RX Band)	22
Table 6-5:	Adjacent Channel Power – 798.0125 MHz; Analog Mode (>400 kHz - RX Band)	23
Table 6-6:	Adjacent Channel Power – 799.0125 MHz; Analog Mode (>400 kHz - RX Band)	24
Table 6-7:	Adjacent Channel Power – 801.0125 MHz; Analog Mode (>400 kHz - RX Band)	25
Table 6-8:	Adjacent Channel Power – 805.9875 MHz; Analog Mode (>400 kHz - RX Band)	26
Table 6-9:	Adjacent Channel Power - 768.0125 MHz; 2-Level FSK 9600 NB (>400 kHz - RX Band)	27
Table 6-10:	Adjacent Channel Power - 769.0125 MHz; 2-Level FSK 9600 NB (>400 kHz - RX Band)	28
Table 6-11:	Adjacent Channel Power - 772.0125 MHz; 2-Level FSK 9600 NB (>400 kHz - RX Band)	29
Table 6-12:	Adjacent Channel Power - 775.9875 MHz; 2-Level FSK 9600 NB (>400 kHz - RX Band)	30
Table 6-13:	Adjacent Channel Power – 798.0125 MHz; 2-Level FSK 9600 NB (>400 kHz - RX Band)	31
Table 6-14:	Adjacent Channel Power – 799.0125 MHz; 2-Level FSK 9600 NB (>400 kHz - RX Band)	32
Table 6-15:	Adjacent Channel Power – 801.0125 MHz; 2-Level FSK 9600 NB (>400 kHz - RX Band)	33
Table 6-16:	Adjacent Channel Power – 805.9875 MHz; 2-Level FSK 9600 NB (>400 kHz - RX Band)	34
Table 6-17:	Adjacent Channel Power - 768.0125 MHz; C4FM Mode (>400 kHz - RX Band).....	35
Table 6-18:	Adjacent Channel Power - 769.0125 MHz; C4FM Mode (>400 kHz - RX Band).....	36
Table 6-19:	Adjacent Channel Power - 772.0125 MHz; C4FM Mode (>400 kHz - RX Band).....	37
Table 6-20:	Adjacent Channel Power - 775.9875 MHz; C4FM Mode (>400 kHz - RX Band).....	38
Table 6-21:	Adjacent Channel Power – 798.0125 MHz; C4FM Mode (>400 kHz - RX Band).....	39
Table 6-22:	Adjacent Channel Power – 799.0125 MHz; C4FM Mode (>400 kHz - RX Band).....	40
Table 6-23:	Adjacent Channel Power – 801.0125 MHz; C4FM Mode (>400 kHz - RX Band).....	41
Table 6-24:	Adjacent Channel Power – 805.9875 MHz; C4FM Mode (>400 kHz - RX Band).....	42
Table 6-25:	Adjacent Channel Power - 768.0125 MHz; H-CPM (TDMA) Mode (>400 kHz - RX Band)	43
Table 6-26:	Adjacent Channel Power - 769.0125 MHz; H-CPM (TDMA) Mode (>400 kHz - RX Band)	44
Table 6-27:	Adjacent Channel Power - 772.0125 MHz; H-CPM (TDMA) Mode (>400 kHz - RX Band)	45
Table 6-28:	Adjacent Channel Power - 775.9875 MHz; H-CPM (TDMA) Mode (>400 kHz - RX Band)	46
Table 6-29:	Adjacent Channel Power – 798.0125 MHz; H-CPM (TDMA) Mode (>400 kHz - RX Band)	47
Table 6-30:	Adjacent Channel Power – 799.0125 MHz; H-CPM (TDMA) Mode (>400 kHz - RX Band)	48
Table 6-31:	Adjacent Channel Power – 801.0125 MHz; H-CPM (TDMA) Mode (>400 kHz - RX Band)	49
Table 6-32:	Adjacent Channel Power – 805.9875 MHz; H-CPM (TDMA) Mode (>400 kHz - RX Band)	50
Table 6-33:	Test Equipment Used For Testing ACP Requirements	51
Table 7-1:	Field Strength of Spurious Radiation – 768.0125 MHz.....	52
Table 7-2:	Field Strength of Spurious Radiation – 769.0125 MHz.....	53
Table 7-3:	Field Strength of Spurious Radiation – 772.0125 MHz.....	53
Table 7-4:	Field Strength of Spurious Radiation – 775.9875 MHz.....	54
Table 7-5:	Field Strength of Spurious Radiation – 798.0125 MHz.....	54
Table 7-6:	Field Strength of Spurious Radiation – 799.0125 MHz.....	55

Table 7-7:	Field Strength of Spurious Radiation – 801.0125 MHz.....	55
Table 7-8:	Field Strength of Spurious Radiation – 805.9875 MHz.....	56
Table 7-9:	Field Strength of Spurious Radiation – 806.0125 MHz.....	56
Table 7-10:	Field Strength of Spurious Radiation – 811.0125 MHz.....	57
Table 7-11:	Field Strength of Spurious Radiation – 815.9875 MHz.....	57
Table 7-12:	Field Strength of Spurious Radiation – 851.0125 MHz.....	58
Table 7-13:	Field Strength of Spurious Radiation – 856.0125 MHz.....	58
Table 7-14:	Field Strength of Spurious Radiation – 860.9875 MHz.....	59
Table 7-15:	Field Strength of Spurious Radiation – 896.0125 MHz.....	59
Table 7-16:	Field Strength of Spurious Radiation – 898.5000 MHz.....	60
Table 7-17:	Field Strength of Spurious Radiation – 900.9875 MHz.....	60
Table 7-18:	Field Strength of Spurious Radiation – 901.9750 MHz.....	61
Table 7-19:	Field Strength of Spurious Radiation – 935.0125 MHz.....	61
Table 7-20:	Field Strength of Spurious Radiation – 937.500 MHz.....	62
Table 7-21:	Field Strength of Spurious Radiation – 939.9875 MHz.....	62
Table 7-22:	Field Strength of Spurious Radiation – 940.9750 MHz.....	63
Table 7-23:	Field Strength of Spurious Radiation – 943.99375 MHz.....	63
Table 7-24:	Part 90.543(f): Out of Band Emissions Limit.....	64
Table 7-25:	Test Equipment Used For Testing Field Strength of Spurious Radiation	64
Table 8-1:	Test Equipment Used For Testing Occupied Bandwidth	181
Table 9-1:	Temperature Frequency Stability – 776 MHz.....	184
Table 9-2:	Temperature Frequency Stability – 851 MHz.....	185
Table 9-3:	Temperature Frequency Stability – 898.5 MHz.....	185
Table 9-4:	Test Equipment Used For Testing Frequency Stability.....	186
Table 9-5:	Frequency Stability/Voltage Variation – 776 MHz.....	187
Table 9-6:	Frequency Stability/Voltage Variation – 851 MHz.....	187
Table 9-7:	Frequency Stability/Voltage Variation – 898.5 MHz.....	187
Table 9-8:	Test Equipment Used For Testing Frequency Stability.....	187
Table 10-1:	Test Equipment Used For Testing Modulation Requirements	200

Table of Plots

Plot 6-1:	Adjacent Channel Power - 768.0125 MHz; Analog Mode (9.375 kHz - 350 kHz)	19
Plot 6-2:	Adjacent Channel Power - 769.0125 MHz; Analog Mode (9.375 kHz - 350 kHz)	20
Plot 6-3:	Adjacent Channel Power - 772.0125 MHz; Analog Mode (9.375 kHz - 350 kHz)	21
Plot 6-4:	Adjacent Channel Power - 775.9875 MHz; Analog Mode (9.375 kHz - 350 kHz)	22
Plot 6-5:	Adjacent Channel Power – 798.0125 MHz; Analog Mode; (9.375 kHz - 350 kHz).....	23
Plot 6-6:	Adjacent Channel Power – 799.0125 MHz; Analog Mode; (9.375 kHz - 350 kHz).....	24
Plot 6-7:	Adjacent Channel Power – 801.0125 MHz; Analog Mode; (9.375 kHz - 350 kHz).....	25
Plot 6-8:	Adjacent Channel Power – 805.9875 MHz; Analog Mode; (9.375 kHz - 350 kHz).....	26
Plot 6-9:	Adjacent Channel Power - 768.0125 MHz; 2-Level FSK 9600 NB (9.375 kHz - 350 kHz)..	27
Plot 6-10:	Adjacent Channel Power - 769.0125 MHz; 2-Level FSK 9600 NB (9.375 kHz - 350 kHz)..	28
Plot 6-11:	Adjacent Channel Power - 772.0125 MHz; 2-Level FSK 9600 NB (9.375 kHz - 350 kHz)..	29
Plot 6-12:	Adjacent Channel Power - 775.9875 MHz; 2-Level FSK 9600 NB (9.375 kHz - 350 kHz)..	30
Plot 6-13:	Adjacent Channel Power – 798.0125 MHz; 2-Level FSK 9600 NB (9.375 kHz - 350 kHz) .	31
Plot 6-14:	Adjacent Channel Power – 799.0125 MHz; 2-Level FSK 9600 NB (9.375 kHz - 350 kHz) .	32
Plot 6-15:	Adjacent Channel Power – 801.0125 MHz; 2-Level FSK 9600 NB (9.375 kHz - 350 kHz) .	33
Plot 6-16:	Adjacent Channel Power – 805.9875 MHz; 2-Level FSK 9600 NB (9.375 kHz - 350 kHz) .	34
Plot 6-17:	Adjacent Channel Power - 768.0125 MHz; C4FM Mode (9.375 kHz - 350 kHz)	35
Plot 6-18:	Adjacent Channel Power - 769.0125 MHz; C4FM Mode (9.375 kHz - 350 kHz)	36
Plot 6-19:	Adjacent Channel Power - 772.0125 MHz; C4FM Mode (9.375 kHz - 350 kHz)	37
Plot 6-20:	Adjacent Channel Power - 775.9875 MHz; C4FM Mode (9.375 kHz - 350 kHz)	38

Plot 6-21:	Adjacent Channel Power – 798.0125 MHz; C4FM Mode (9.375 kHz - 350 kHz)	39
Plot 6-22:	Adjacent Channel Power – 799.0125 MHz; C4FM Mode (9.375 kHz - 350 kHz)	40
Plot 6-23:	Adjacent Channel Power – 801.0125 MHz; C4FM Mode (9.375 kHz - 350 kHz)	41
Plot 6-24:	Adjacent Channel Power – 805.9875 MHz; C4FM Mode (9.375 kHz - 350 kHz)	42
Plot 6-25:	Adjacent Channel Power - 768.0125 MHz; H-CPM (TDMA) Mode (9.375 kHz - 350 kHz) .	43
Plot 6-26:	Adjacent Channel Power - 769.0125 MHz; H-CPM (TDMA) Mode (9.375 kHz - 350 kHz) .	44
Plot 6-27:	Adjacent Channel Power - 772.0125 MHz; H-CPM (TDMA) Mode (9.375 kHz - 350 kHz) .	45
Plot 6-28:	Adjacent Channel Power - 775.9875 MHz; H-CPM (TDMA) Mode (9.375 kHz - 350 kHz) .	46
Plot 6-29:	Adjacent Channel Power – 798.0125 MHz; H-CPM (TDMA) Mode; (9.375 kHz - 350 kHz)	47
Plot 6-30:	Adjacent Channel Power – 799.0125 MHz; H-CPM (TDMA) Mode; (9.375 kHz - 350 kHz)	48
Plot 6-31:	Adjacent Channel Power – 801.0125 MHz; H-CPM (TDMA) Mode; (9.375 kHz - 350 kHz)	49
Plot 6-32:	Adjacent Channel Power – 805.9875 MHz; H-CPM (TDMA) Mode; (9.375 kHz - 350 kHz)	50
Plot 8-1:	Occupied Bandwidth – 806.0125 MHz; NB Analog; Mask B	67
Plot 8-2:	Occupied Bandwidth – 811.0125 MHz; NB Analog; Mask B	68
Plot 8-3:	Occupied Bandwidth – 815.9875 MHz; NB Analog; Mask B	69
Plot 8-4:	Occupied Bandwidth – 851.0125 MHz; NB Analog; Mask B	70
Plot 8-5:	Occupied Bandwidth – 856.0125 MHz; NB Analog; Mask B	71
Plot 8-6:	Occupied Bandwidth – 860.9875 MHz; NB Analog; Mask B	72
Plot 8-7:	Occupied Bandwidth – 806.0125 MHz; NB Analog; Mask D (IC)	73
Plot 8-8:	Occupied Bandwidth – 811.0125 MHz; NB Analog; Mask D (IC)	74
Plot 8-9:	Occupied Bandwidth – 815.9875 MHz; NB Analog; Mask D (IC)	75
Plot 8-10:	Occupied Bandwidth – 851.0125 MHz; NB Analog; Mask D (IC)	76
Plot 8-11:	Occupied Bandwidth – 856.0125 MHz; NB Analog; Mask D (IC)	77
Plot 8-12:	Occupied Bandwidth – 860.9875 MHz; NB Analog; Mask D (IC)	78
Plot 8-13:	Occupied Bandwidth – 896.0125 MHz; NB Analog; Mask I	79
Plot 8-14:	Occupied Bandwidth – 898.5000 MHz; NB Analog; Mask I	80
Plot 8-15:	Occupied Bandwidth – 900.9875 MHz; NB Analog; Mask I	81
Plot 8-16:	Occupied Bandwidth – 935.0125 MHz; NB Analog; Mask I	82
Plot 8-17:	Occupied Bandwidth – 937.5 MHz; NB Analog; Mask I	83
Plot 8-18:	Occupied Bandwidth – 939.9875 MHz; NB Analog; Mask I	84
Plot 8-19:	Occupied Bandwidth – 806.0125 MHz; Analog NPSPAC; Mask B	85
Plot 8-20:	Occupied Bandwidth – 806.0125 MHz; Analog NPSPAC; Mask H	86
Plot 8-21:	Occupied Bandwidth – 851.0125 MHz; Analog NPSPAC; Mask B	87
Plot 8-22:	Occupied Bandwidth – 851.0125 MHz; Analog NPSPAC; Mask H	88
Plot 8-23:	Occupied Bandwidth – 856.0125 MHz; Analog NPSPAC; Mask B	89
Plot 8-24:	Occupied Bandwidth – 860.9875 MHz; Analog NPSPAC; Mask B	90
Plot 8-25:	Occupied Bandwidth – 809.0125 MHz; WB Analog; Mask B	91
Plot 8-26:	Occupied Bandwidth – 811.0125 MHz; WB Analog; Mask B	92
Plot 8-27:	Occupied Bandwidth – 815.9875 MHz; WB Analog; Mask B	93
Plot 8-28:	Occupied Bandwidth – 851.0125 MHz; WB Analog; Mask B	94
Plot 8-29:	Occupied Bandwidth – 856.0125 MHz; WB Analog; Mask B	95
Plot 8-30:	Occupied Bandwidth – 860.9875 MHz; WB Analog; Mask B	96
Plot 8-31:	Occupied Bandwidth – 896.0125 MHz; 2-Level FSK 4800 XNB; Mask J	97
Plot 8-32:	Occupied Bandwidth – 898.5 MHz; 2-Level FSK 4800 XNB; Mask J	98
Plot 8-33:	Occupied Bandwidth – 900.9875 MHz; 2-Level FSK 4800 XNB; Mask J	99
Plot 8-34:	Occupied Bandwidth – 935.0125 MHz; 2-Level FSK 4800 XNB; Mask J	100
Plot 8-35:	Occupied Bandwidth – 937.5 MHz; 2-Level FSK 4800 XNB; Mask J	101
Plot 8-36:	Occupied Bandwidth – 939.9875 MHz; 2-Level FSK 4800 XNB; Mask J	102
Plot 8-37:	Occupied Bandwidth – 806.0125 MHz; 2-Level FSK 9600 NB; Mask H	103
Plot 8-38:	Occupied Bandwidth – 811.0125 MHz; 2-Level FSK 9600 NB; Mask G	104
Plot 8-39:	Occupied Bandwidth – 815.9875 MHz; 2-Level FSK 9600 NB; Mask G	105
Plot 8-40:	Occupied Bandwidth – 851.0125 MHz; 2-Level FSK 9600 NB; Mask H	106
Plot 8-41:	Occupied Bandwidth – 856.0125 MHz; 2-Level FSK 9600 NB; Mask G	107

Plot 8-42:	Occupied Bandwidth – 860.9875 MHz; 2-Level FSK 9600 NB; Mask G	108
Plot 8-43:	Occupied Bandwidth – 806.0125 MHz; 2-Level FSK 9600 NB; Mask D (IC)	109
Plot 8-44:	Occupied Bandwidth – 811.0125 MHz; 2-Level FSK 9600 NB; Mask D (IC)	110
Plot 8-45:	Occupied Bandwidth – 815.9875 MHz; 2-Level FSK 9600 NB; Mask D (IC)	111
Plot 8-46:	Occupied Bandwidth – 851.0125 MHz; 2-Level FSK 9600 NB; Mask D (IC)	112
Plot 8-47:	Occupied Bandwidth – 856.0125 MHz; 2-Level FSK 9600 NB; Mask D (IC)	113
Plot 8-48:	Occupied Bandwidth – 860.9875 MHz; 2-Level FSK 9600 NB; Mask D (IC)	114
Plot 8-49:	Occupied Bandwidth – 896.0125 MHz; 2-Level FSK 9600 NB; Mask J	115
Plot 8-50:	Occupied Bandwidth – 898.5 MHz; 2-Level FSK 9600 NB; Mask J	116
Plot 8-51:	Occupied Bandwidth – 900.9875 MHz; 2-Level FSK 9600 NB; Mask J	117
Plot 8-52:	Occupied Bandwidth – 935.0125 MHz; 2-Level FSK 9600 NB; Mask J	118
Plot 8-53:	Occupied Bandwidth – 937.5 MHz; 2-Level FSK 9600 NB; Mask J	119
Plot 8-54:	Occupied Bandwidth – 939.9875 MHz; 2-Level FSK 9600 NB; Mask J	120
Plot 8-55:	Occupied Bandwidth – 806.0125 MHz; 2-Level FSK 9600 NPSPAC; Mask H.....	121
Plot 8-56:	Occupied Bandwidth – 851.0125 MHz; 2-Level FSK 9600 NPSPAC; Mask H.....	122
Plot 8-57:	Occupied Bandwidth – 856.0125 MHz; 2-Level FSK 9600 NPSPAC; Mask G	123
Plot 8-58:	Occupied Bandwidth – 860.9875 MHz; 2-Level FSK 9600 NPSPAC; Mask G	124
Plot 8-59:	Occupied Bandwidth – 809.0125 MHz; WB 2-Level FSK 9600; Mask G	125
Plot 8-60:	Occupied Bandwidth – 811.0125 MHz; WB 2-Level FSK 9600; Mask G	126
Plot 8-61:	Occupied Bandwidth – 815.9875 MHz; WB 2-Level FSK 9600; Mask G	127
Plot 8-62:	Occupied Bandwidth – 851.0125 MHz; WB 2-Level FSK 9600; Mask H.....	128
Plot 8-63:	Occupied Bandwidth – 856.0125 MHz; WB 2-Level FSK 9600; Mask G	129
Plot 8-64:	Occupied Bandwidth – 860.9875 MHz; WB 2-Level FSK 9600; Mask G	130
Plot 8-65:	Occupied Bandwidth – 806.0125 MHz; P25; Mask H	131
Plot 8-66:	Occupied Bandwidth – 811.0125 MHz; P25; Mask G	132
Plot 8-67:	Occupied Bandwidth – 815.9875 MHz; P25; Mask G	133
Plot 8-68:	Occupied Bandwidth – 851.0125 MHz; P25; Mask H	134
Plot 8-69:	Occupied Bandwidth – 856.0125 MHz; P25; Mask G	135
Plot 8-70:	Occupied Bandwidth – 860.9875 MHz; P25; Mask G	136
Plot 8-71:	Occupied Bandwidth – 806.0125 MHz; P25; Mask D	137
Plot 8-72:	Occupied Bandwidth – 811.0125 MHz; P25; Mask D	138
Plot 8-73:	Occupied Bandwidth – 815.9875 MHz; P25; Mask D	139
Plot 8-74:	Occupied Bandwidth – 851.0125 MHz; P25; Mask D	140
Plot 8-75:	Occupied Bandwidth – 856.0125 MHz; P25; Mask D	141
Plot 8-76:	Occupied Bandwidth – 860.9875 MHz; P25; Mask D	142
Plot 8-77:	Occupied Bandwidth – 806.0125 MHz; P25 Phase 2; Mask H.....	143
Plot 8-78:	Occupied Bandwidth – 811.0125 MHz; P25 Phase 2; Mask G.....	144
Plot 8-79:	Occupied Bandwidth – 815.9875 MHz; P25 Phase 2; Mask G.....	145
Plot 8-80:	Occupied Bandwidth – 851.0125 MHz; P25 Phase 2; Mask H.....	146
Plot 8-81:	Occupied Bandwidth – 856.0125 MHz; P25 Phase 2; Mask G.....	147
Plot 8-82:	Occupied Bandwidth – 860.9875 MHz; P25 Phase 2; Mask G.....	148
Plot 8-83:	Occupied Bandwidth – 806.0125 MHz; P25 Phase 2; Mask D.....	149
Plot 8-84:	Occupied Bandwidth – 811.0125 MHz; P25 Phase 2; Mask D.....	150
Plot 8-85:	Occupied Bandwidth – 815.9875 MHz; P25 Phase 2; Mask D.....	151
Plot 8-86:	Occupied Bandwidth – 851.0125 MHz; P25 Phase 2; Mask D.....	152
Plot 8-87:	Occupied Bandwidth – 856.0125 MHz; P25 Phase 2; Mask D.....	153
Plot 8-88:	Occupied Bandwidth – 860.9875 MHz; P25 Phase 2; Mask D.....	154
Plot 8-89:	Occupied Bandwidth – 896.0125 MHz; P25 Phase 2; Mask J.....	155
Plot 8-90:	Occupied Bandwidth – 898.5000 MHz; P25 Phase 2; Mask J.....	156
Plot 8-91:	Occupied Bandwidth – 900.9875 MHz; P25 Phase 2; Mask J.....	157
Plot 8-92:	Occupied Bandwidth – 935.0125 MHz; P25 Phase 2; Mask J.....	158
Plot 8-93:	Occupied Bandwidth – 937.5000 MHz; P25 Phase 2; Mask J.....	159
Plot 8-94:	Occupied Bandwidth – 939.9875 MHz; P25 Phase 2; Mask J.....	160

Plot 8-95:	Occupied Bandwidth – 901.9750 MHz; NB Analog; Mask 24.133(1)	161
Plot 8-96:	Occupied Bandwidth – 901.9750 MHz; WB Analog; Mask 24.133(1).....	162
Plot 8-97:	Occupied Bandwidth – 901.9750 MHz; 2-Level FSK 9600 WB; Mask 24.133(1).....	163
Plot 8-98:	Occupied Bandwidth – 901.9750 MHz; 2-Level FSK 9600 NB; Mask 24.133(1).....	164
Plot 8-99:	Occupied Bandwidth – 901.9750 MHz; 2-Level FSK 4800 XNB; Mask 24.133(1)	165
Plot 8-100:	Occupied Bandwidth – 901.9750 MHz; P25; Mask 24.133(1)	166
Plot 8-101:	Occupied Bandwidth – 901.9750 MHz; P25 Phase 2; Mask 24.133(1).....	167
Plot 8-102:	Occupied Bandwidth – 940.9750 MHz; NB Analog; Mask 24.133(1)	168
Plot 8-103:	Occupied Bandwidth – 940.9750 MHz; WB Analog; Mask 24.133(1).....	169
Plot 8-104:	Occupied Bandwidth – 940.9750 MHz; 2-Level FSK 9600 WB; Mask 24.133(1).....	170
Plot 8-105:	Occupied Bandwidth – 940.9750 MHz; 2-Level FSK 9600 NB; Mask 24.133(1).....	171
Plot 8-106:	Occupied Bandwidth – 940.9750 MHz; 2-Level FSK 4800 XNB; Mask 24.133(1)	172
Plot 8-107:	Occupied Bandwidth – 940.9750 MHz; P25; Mask 24.133(1)	173
Plot 8-108:	Occupied Bandwidth – 940.9750 MHz; P25 Phase 2; Mask 24.133(1).....	174
Plot 8-109:	Occupied Bandwidth – 943.99375 MHz; NB Analog; Mask 101.111(1)	175
Plot 8-110:	Occupied Bandwidth – 943.99375 MHz; WB Analog; Mask 101.111(1).....	176
Plot 8-111:	Occupied Bandwidth – 943.99375 MHz; 2-Level FSK 9600 WB; Mask 101.111(2).....	177
Plot 8-112:	Occupied Bandwidth – 943.99375 MHz; 2-Level FSK 9600 NB; Mask 101.111(2).....	178
Plot 8-113:	Occupied Bandwidth – 943.99375 MHz; 2-Level FSK 4800 XNB; Mask 101.111(2)	179
Plot 8-114:	Occupied Bandwidth – 943.99375 MHz; P25; Mask 101.111(2)	180
Plot 8-115:	Occupied Bandwidth – 943.99375 MHz; P25 Phase 2; Mask 101.111(2).....	181
Plot 10-1:	Modulation Characteristics - Audio Frequency Response – 772.0125 MHz (NB)	189
Plot 10-2:	Modulation Characteristics - Audio Frequency Response – 856.0125 MHz (NPSPAC) ...	190
Plot 10-3:	Modulation Characteristics - Audio Frequency Response – 900.9875 MHz (WB)	191
Plot 10-4:	Modulation Characteristics – Audio Low Pass Filter – 772.0125 MHz (NB).....	192
Plot 10-5:	Modulation Characteristics – Audio Low Pass Filter – 856.0125 MHz (NPSPAC)	193
Plot 10-6:	Modulation Characteristics – Audio Low Pass Filter – 900.9875 MHz (WB)	194
Plot 10-7:	Modulation Characteristics – Modulation Limiting – 772.0125 MHz; (NB); Positive Peak .	195
Plot 10-8:	Modulation Characteristics – Modulation Limiting - 772.0125 MHz; (NB) Negative Peak .	196
Plot 10-9:	Modulation Characteristics – Modulation Limiting – 856.0125 MHz; (NPSPAC); Positive Peak	197
Plot 10-10:	Modulation Characteristics – Modulation Limiting – 856.0125 MHz; (NPSPAC); Negative Peak	198
Plot 10-11:	Modulation Characteristics – Modulation Limiting – 900.9875 MHz; (WB); Positive Peak	199
Plot 10-12:	Modulation Characteristics – Modulation Limiting – 900.9875 MHz; (WB); Negative Peak	200

Table of Appendixes

Appendix A:	FCC Part 1.1307, 1.1310, 2.1091, 2.1093: RF Exposure	203
Appendix B:	Agency Authorization	204
Appendix C:	FCC and IC Confidentiality Request Letter	205
Appendix D:	IC Letters	206
Appendix E:	Canadian Based Representative Attestation Letter	207
Appendix F:	AFC Attestation	208
Appendix G:	Application Review Attestation	209
Appendix H:	IC RSS-119 P25 Attestation.....	210
Appendix I:	ID Label & Location	211
Appendix J:	Operational Description	212
Appendix K:	Parts List.....	213
Appendix L:	Test / Tune Procedure.....	214
Appendix M:	Schematics	215
Appendix N:	Block Diagrams	216
Appendix O:	Manual	217
Appendix P:	Test Configuration Photographs.....	2

Rhein Tech Laboratories, Inc.
360 Herndon Parkway
Suite 1400
Herndon, VA20170
<http://www.rheintech.com>

Client: Harris Corporation
Model: XL-185P 7/8/900 MHz
ID's: OWDTR-0143-E/3636B-0143
Standards: FCC Part 24, 90, 101/IC RSS-119
Report #: 2016219TNF

Appendix Q:	External Photographs	222
Appendix R:	Internal Photographs	223

Table of Photographs

Photograph 1:	Radiated Emissions (Spurious/Harmonics) – Front View (Above 1 GHz)	218
Photograph 2:	Radiated Emissions (Spurious/Harmonics) – Back View (Above 1 GHz)	219
Photograph 3:	Radiated Emissions (Spurious/Harmonics) – Front View (Below 1 GHz)	220
Photograph 4:	Radiated Emissions (Spurious/Harmonics) – Back View (Below 1 GHz)	221

1 Test Result Summary

Test	FCC Reference	IC Reference	Result
RF Power Output	2.1046(a), 24.132(b), 90.541(d), 101.113(a)	RSS-119 5.4	Complies
Spurious Emissions at Antenna Terminals	2.1051, 90.210	RSS-119 5.5, 5.8	Complies
Field Strength of Spurious Radiation	2.1053(a), 90.543(c); 90.210	RSS-119 5.5, 5.8	Complies
Occupied Bandwidth/Emission Masks	2.1049(c)(1), 24.131, 24.133(a)(1),(2), 90.543(d); 90.210, 101.109, 101.111	RSS-119 5.5, 5.8	Complies
Adjacent Channel Power	90.543	RSS-119 5.3	Complies
Frequency Stability vs. Temperature and Voltage	2.1055, 24.135, 90.213, 90.539, 101.107	N/A	Complies
Modulation Characteristics	2.1047(a)(b)	RSS-119 5.9	Complies
Transient Frequency Response	90.214	RSS-119 5.9	N/A

2 General Information

The following Certification Report is prepared on behalf of Harris Corporation in accordance with the Federal Communications Commission and Industry Canada rules and regulations. The Equipment Under Test (EUT) was the XL-185P 7/8/900 MHz portable radio family; FCC ID: OWDTR-0143-E, IC: 3636B-0143.

The radio is subject to FCC DoC. DoC testing was performed and the data is contained in a separate DoC report.

All measurements contained in this application were conducted in accordance with the applicable sections of FCC Rules and Regulations CFR 47 Parts 2, 24, 90 and 101. Calibration checks are performed regularly on the instruments, and all accessories including high pass filter, coaxial attenuator, preamplifier and cables.

2.1 Test Facility

The open area test site and conducted measurement facility used to collect the radiated data is located on the parking lot of Rhein Tech Laboratories, Inc. 360 Herndon Parkway, Suite 1400, Herndon, Virginia 20170. This site has been fully described in a report submitted to, and approved by, the Federal Communications Commission to perform AC line conducted and radiated emissions testing.

2.2 Related Submittal(s)/Grant(s)

This is a new certification application for FCC and Industry Canada. The Industry Canada application is for family certification and includes four model numbers (HVINs): XL-PFM9M, XL-PFM9Y (System versions), XL-PPM9M and XL-PPM9Y (Scan versions).

2.3 Grant Notes

RF power switchable from 0.5 W to rated power 3 W.

2.4 Tested System Details

The test sample was received on December 12, 2016. Listed below are the identifiers and descriptions of all equipment, cables, and internal devices used with the EUT for this test, as applicable.

The device was programmed for multiple modes of operation and modulation types.

Table 2-1: Equipment Under Test (EUT)

Part	Manufacturer	Model	PN/SN	FCC ID	RTL Bar Code
XL-185P Radio	Harris Corporation	XL-185P 7/8/900 MHz	14035-1020-71/ E000002	OWDTR-0143-E	22283
XL-185P Radio	Harris Corporation	XL-185P 7/8/900 MHz	14035-1020-71/ E000003	OWDTR-0143-E	22282

Table 2-2: Auxiliary Equipment

Part	Manufacturer	Model	PN/SN	FCC ID	RTL Bar Code
Microphone	Harris Corporation	EM105	N/A	N/A	21563
Antenna (762-870 MHz)	Harris Corporation	N/A	14035-4450-01	N/A	22284
Battery	Harris Corporation	Li-Ion Rechargeable Battery	14035-4010-04	N/A	22299
Battery	Harris Corporation	Li-Ion Rechargeable Battery	14035-4010-04	N/A	22300
Power Supply	Hewlett Packard	E3610A	KR72917306	N/A	901699
Battery Eliminator	Harris Corporation	-	-	N/A	-

Figure 2-1: Configuration of Tested System

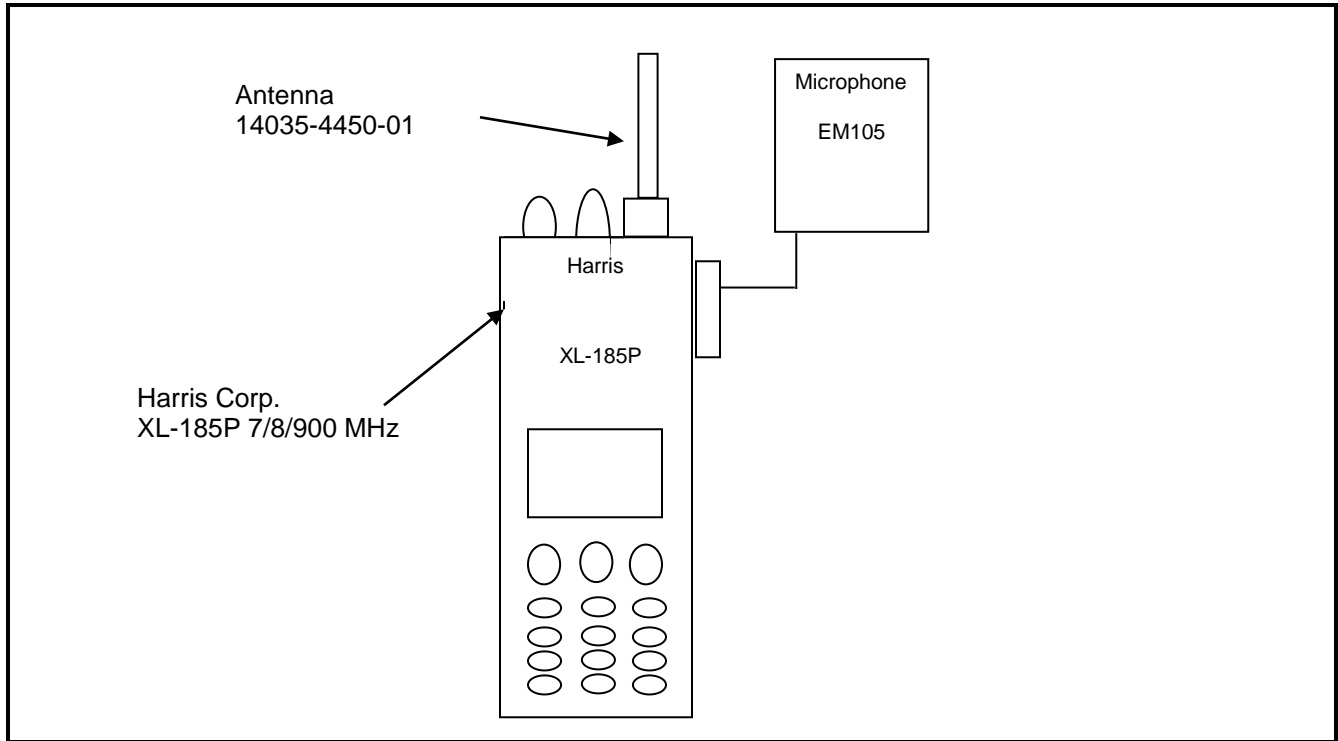

3 FCC Part 2.1033(C)(8): Voltages and Currents through the Final Amplifying Stage

7.5VDC / 0.74 A

4 FCC Part 2.1046(a): RF power output: Conducted; Part 24.132(b): Power and antenna height limits; Part 90.541(d) Transmitting power and antenna height requirements; Part 101.113(a): Transmitter power limitations; IC RSS-119 4.1: Transmitter Output Power

4.1 Test Procedure

ANSI/TIA-603-D 2010, section 2.2.1

The EUT was connected to a coaxial attenuator having a 50 Ω load impedance.

Manufacturer's rated power: 3 W for 700, 800 and 900 MHz bands; for the 2 W ERP used in the 700 MHz band on-scene incident channels, a power setting of 1.9 W is used.

4.2 Test Data

Table 4-1: RF Conducted Output Power – Measured

Frequency (MHz)	High Power (dBm)	High Power (W)	Low Power (dBm)	Low Power (W)
768.0125	34.3	2.7	27.0	0.5
769.0125	34.3	2.7	27.0	0.5
772.0125	34.3	2.7	27.0	0.5
775.9875	34.3	2.7	27.0	0.5
798.0125	34.3	2.7	27.0	0.5
799.0125	34.4	2.8	27.0	0.5
801.0125	34.3	2.7	27.0	0.5
805.9875	34.3	2.7	27.0	0.5
806.0125	35.0	3.2	27.2	0.5
811.0125	35.1	3.2	27.3	0.5
815.9875	35.2	3.3	27.3	0.5
851.0125	35.0	3.2	27.2	0.5
856.0125	35.1	3.2	27.3	0.5
860.9875	35.0	3.2	27.3	0.5
896.0125	35.0	3.2	27.2	0.5
898.5000	35.1	3.2	27.2	0.5
900.9875	35.0	3.2	27.2	0.5
901.9750	35.0	3.2	27.0	0.5
935.0125	35.1	3.2	27.3	0.5
937.5000	35.1	3.2	27.3	0.5
939.9875	35.0	3.2	27.2	0.5
940.9750	35.0	3.2	27.0	0.5
943.99375	35.0	3.2	27.0	0.5

Notes: Data presented is for analog mode. All other modes were investigated and found to have equivalent power within measurement tolerances.

Rhein Tech Laboratories, Inc.
360 Herndon Parkway
Suite 1400
Herndon, VA20170
<http://www.rheintech.com>

Client: Harris Corporation
Model: XL-185P 7/8/900 MHz
ID's: OWDTR-0143-E/3636B-0143
Standards: FCC Part 24, 90, 101/IC RSS-119
Report #: 2016219TNF

Table 4-2: Test Equipment Used For Testing RF Power Output - Conducted

RTL Asset #	Manufacturer	Model	Part Type	Serial Number	Calibration Due Date
901581	Rohde & Schwarz	FSU	Spectrum Analyzer	1166.1660.50	3/22/18
901536	Aeroflex	48-40-34	40 dB Attenuator	CB6627	9/6/17

Test Personnel:

Daniel Baltzell EMC Test Engineer	 Signature	December 13, 2016 & January 23, 2017 Dates of Test
--------------------------------------	--	--

5 FCC Part 2.1051: Spurious Emissions at Antenna Terminals; Part 90.210: Emission Limitations

5.1 Test Procedure

ANSI/TIA-603-D 2010, Section 2.2.13

The transmitter is terminated with a 50 Ω load and interfaced with a spectrum analyzer.

Device with digital modulation: Modulated to its maximum extent using a pseudo-random data sequence.

5.2 Test Data

Frequency range of measurement per Part 2.1057: 9 kHz to 10 x Fc

Limits: (43+10LOG P(W)) for wideband and 50 + 10 LOG P(W)) for narrowband

The following channels (in MHz) were investigated:

700 MHz	800 MHz	900 MHz
768.0125	806.0125	896.0125
769.0125	811.0125	898.5000
772.0125	823.9875	900.9875
775.9875	851.0125	901.9750
798.0125	856.0125	935.0125
799.0125	868.9875	937.5000
801.0125		939.9875
805.9875		940.9750
		943.99375

Both high and low power settings were checked; high power was found to be worst case and is presented. All modes were investigated and no emissions were found within 20 dB below the limit, therefore no data is presented.

Table 5-1: Test Equipment Used For Testing Spurious Emissions

RTL Asset #	Manufacturer	Model	Part Type	Serial Number	Calibration Due Date
901581	Rohde & Schwarz	FSU	Spectrum Analyzer	1166.1660.50	3/22/18
901139	Weinschel Corporation	47-20-34	Attenuator DC-18 GHz 20 dB 100W	BK5859	3/30/18
901128	Par Electronics	806-902 (25W)	UHF Notch Filter	N/A	9/26/17

Test Personnel:

Daniel Baltzell EMC Test Engineer	 Signature	December 14, 2015 & January 23, 2017 Dates of Test
--------------------------------------	--	--

6 FCC Part 90.543(a): Emission Limitations: ACP Requirements; IC RSS-119 4.3 Adjacent Channel Power (ACP) Measurement for Equipment in the Bands 764-776 MHz and 794-806 MHz

Effective October 23, 2007, transmitters designed to operate in the 769–775 MHz and 799–805 MHz frequency bands must meet the emission limitations in paragraphs (a) through (d) of this section. Transmitters operating in the 763–768 MHz and 793–798 MHz bands must meet the emission limitations in (e) of this section.

6.1 Test Procedure

ANSI/TIA-603-D 2010, Section 2.2.14 Unwanted Emissions: Adjacent Channel Power Ratio

Device with digital modulation: Modulated to its maximum extent using a pseudo-random data sequence.

For a Portable transmitter designed to operate with a 12.5 kHz channel bandwidth, the ACP shall be in accordance with the values in the following table:

Offset from Center Frequency (kHz)	Measurement Bandwidth (kHz)	Maximum ACP Relative (dBc)
(+/-)9.375	6.25	-40
(+/-)15.625	6.25	-60
(+/-)21.875	6.25	-60
(+/-)37.5	25	-60
(+/-)62.5	25	-65
(+/-)87.5	25	-65
(+/-)150	100	-65
(+/-)250	100	-65
(+/-)350	100	-65
>400 kHz to 12 MHz	30(s)	-75
12 MHz to paired receive band	30(s)	-75
In the paired receive band	30(s)	-100

For a Portable transmitter designed to operate with a 25 kHz channel bandwidth, the ACP shall be in accordance with the values in the following table:

Offset from Center Frequency (kHz)	Measurement Bandwidth (kHz)	Maximum ACP Relative (dBc)
(+/-)15.625	6.25	-40
(+/-)21.875	6.25	-60
(+/-)37.5	25	-60
(+/-)62.5	25	-65
(+/-)87.5	25	-65
(+/-)150	100	-65
(+/-)250	100	-65
(+/-)350	100	-65
>400 kHz to 12 MHz	30(s)	-75
12 MHz to paired receive band	30(s)	-75
In the paired receive band	30(s)	-100

FCC Rules and Regulations - 90.543(b)

Setting Reference Level - 90.543(b)(1): Using a spectrum analyzer capable of ACP measurements, set the measurement bandwidth to the channel size. Set the frequency offset of the measurement to zero and adjust the center frequency of the spectrum analyzer to give the power level in the measurement bandwidth. Record this power as the reference power level.

Measuring the power level at the frequency offset <600 kHz - §90.543(b)(2): Using a spectrum analyzer capable of adjacent channel power (ACP) measurements, set the measurement bandwidth as shown in the table. Measure ACP in dBm. These measurements are made at maximum power. Calculate the coupled power by subtracting the measurements made in this step from the reference power level. The absolute ACP values must be less than the values given in the table for each condition.

Measuring the power level at the frequency offset >600 kHz - §90.543(b)(3): Set the spectrum analyzer to 30 kHz resolution bandwidth, 1 MHz video bandwidth and sample detection mode. Sweep +/-6 MHz from the carrier frequency. Set the reference level to the RMS value of the transmitter power and note the power. The response at frequencies >600 kHz must be less than the values listed in the table.

6.2 Test Data

Plot 6-1: Adjacent Channel Power - 768.0125 MHz; Analog Mode (9.375 kHz - 350 kHz)

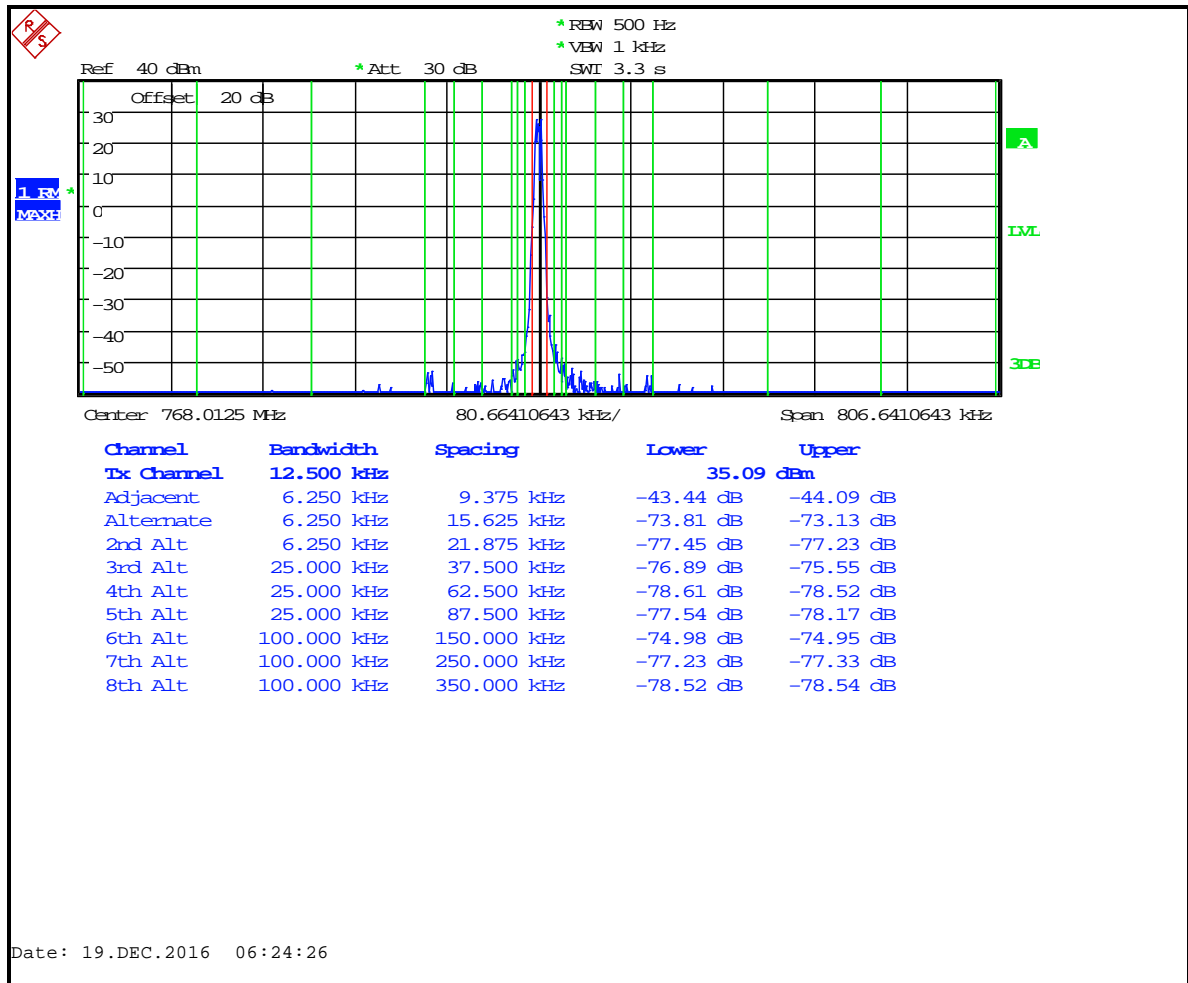

Table 6-1: Adjacent Channel Power - 768.0125 MHz; Analog Mode (>400 kHz - RX Band)

Offset from Center Frequency (kHz)	Measurement BW (kHz)	Max ACP (dBc)	Measured ACP (dBc)
>400 to 12 MHz	30(s)	-75	-82.8
12 MHz to receive band	30(s)	-75	-82.6
In receive band	30(s)	-100	-103.6

Plot 6-2: Adjacent Channel Power - 769.0125 MHz; Analog Mode (9.375 kHz - 350 kHz)

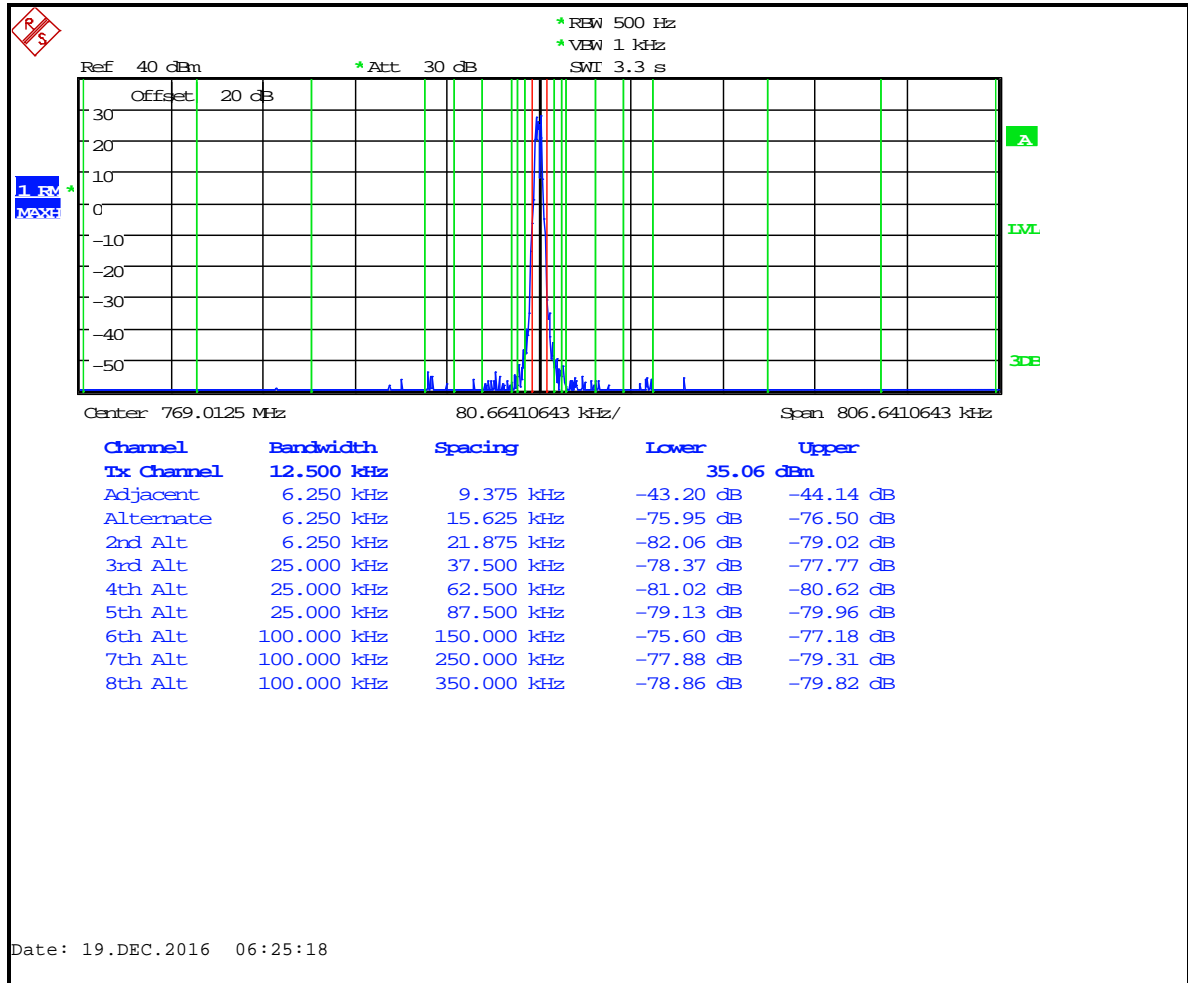

Table 6-2: Adjacent Channel Power - 769.0125 MHz; Analog Mode (>400 kHz - RX Band)

Offset from Center Frequency (kHz)	Measurement BW (kHz)	Max ACP (dBc)	Measured ACP (dBc)
>400 to 12 MHz	30(s)	-75	-88.4
12 MHz to receive band	30(s)	-75	-82.8
In receive band	30(s)	-100	-103.5

Plot 6-3: Adjacent Channel Power - 772.0125 MHz; Analog Mode (9.375 kHz - 350 kHz)

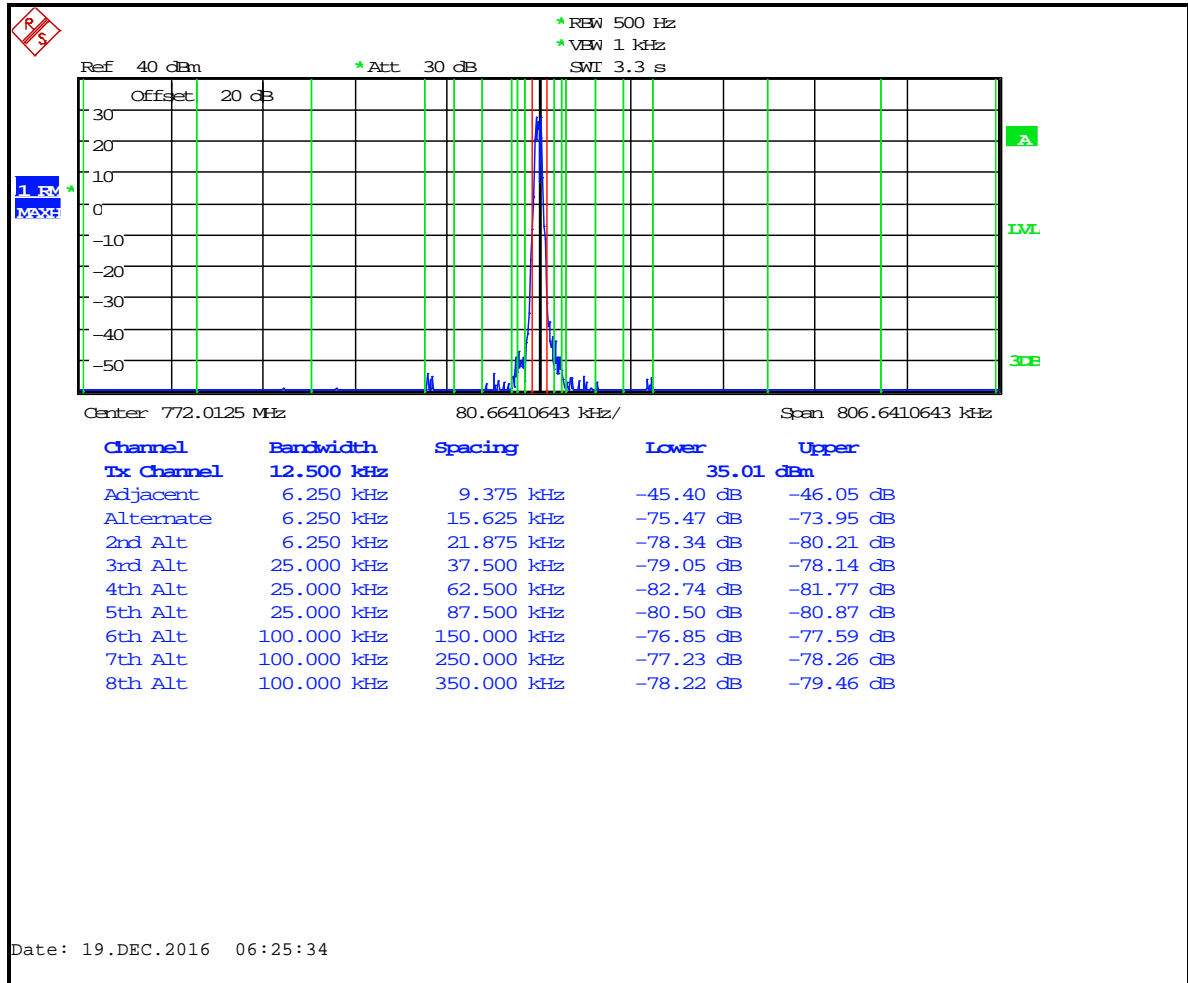

Table 6-3: Adjacent Channel Power - 772.0125 MHz; Analog Mode (>400 kHz - RX Band)

Offset from Center Frequency (kHz)	Measurement BW (kHz)	Max ACP (dBc)	Measured ACP (dBc)
>400 to 12 MHz	30(s)	-75	-82.2
12 MHz to receive band	30(s)	-75	-83.2
In receive band	30(s)	-100	-103.6

Plot 6-4: Adjacent Channel Power - 775.9875 MHz; Analog Mode (9.375 kHz - 350 kHz)

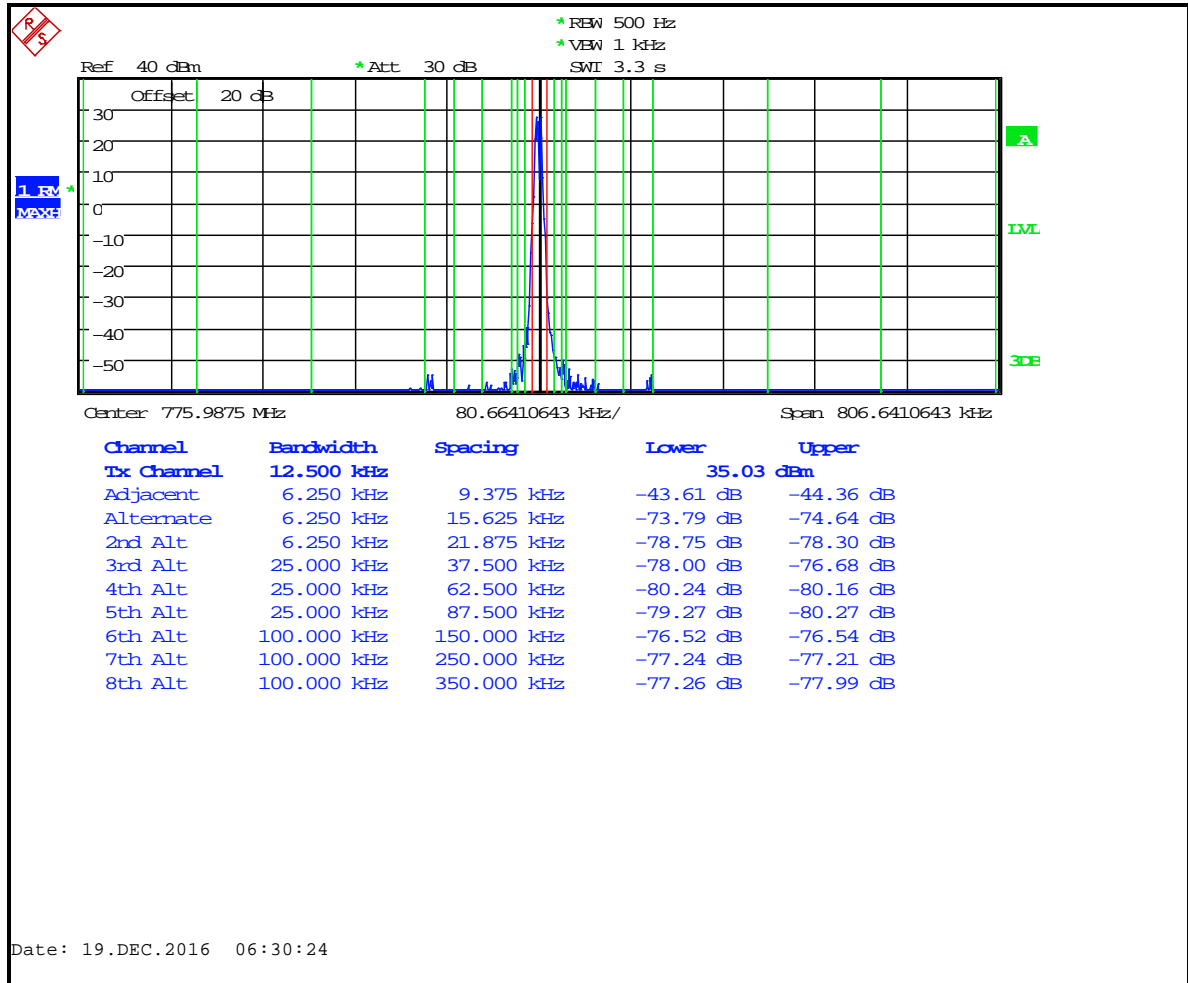

Table 6-4: Adjacent Channel Power - 775.9875 MHz; Analog Mode (>400 kHz - RX Band)

Offset from Center Frequency (kHz)	Measurement BW (kHz)	Max ACP (dBc)	Measured ACP (dBc)
>400 to 12 MHz	30(s)	-75	-81.7
12 MHz to receive band	30(s)	-75	-83.2
In receive band	30(s)	-100	-103.2

Plot 6-5: Adjacent Channel Power – 798.0125 MHz; Analog Mode; (9.375 kHz - 350 kHz)

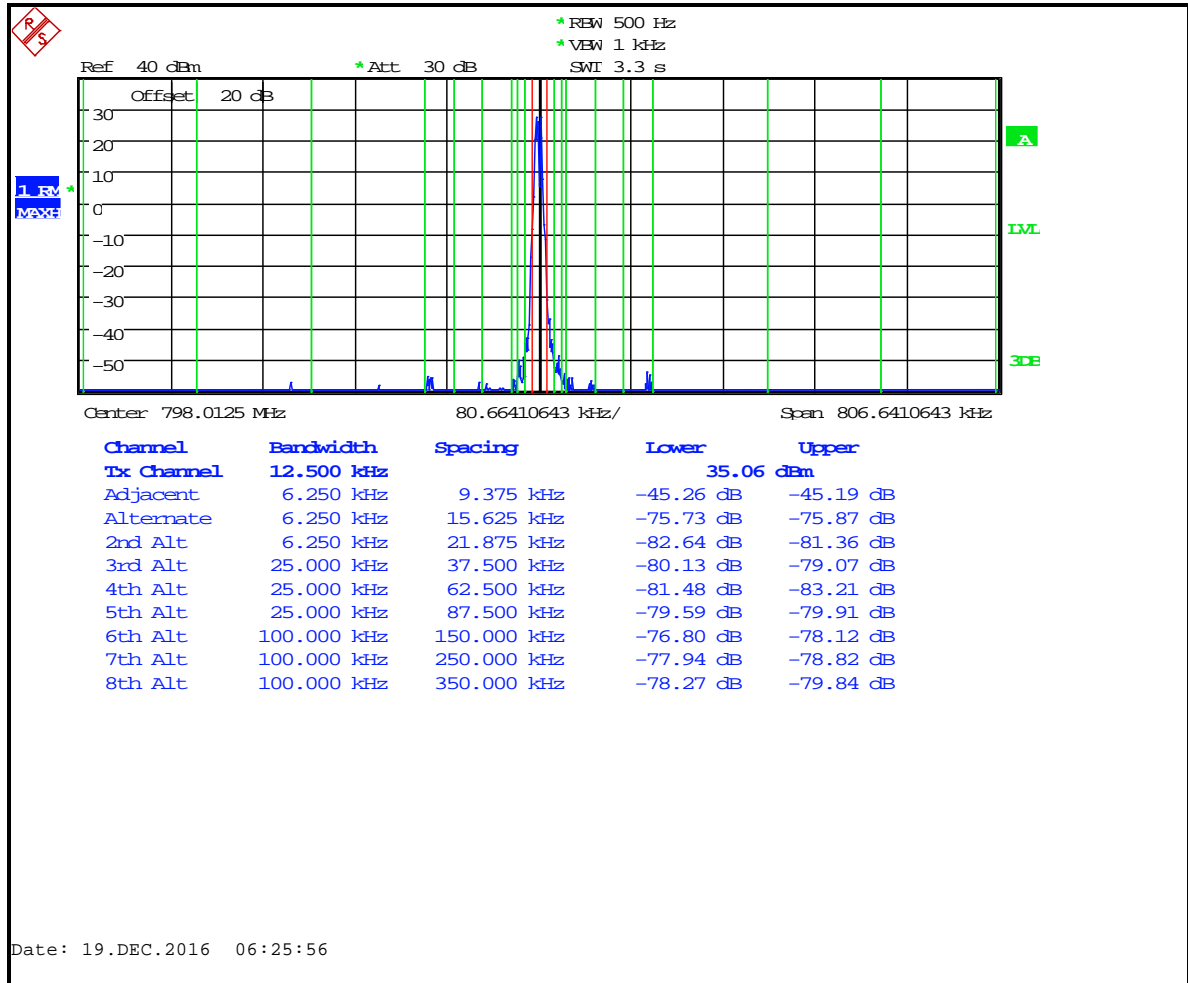

Table 6-5: Adjacent Channel Power – 798.0125 MHz; Analog Mode (>400 kHz - RX Band)

Offset from Center Frequency (kHz)	Measurement BW (kHz)	Max ACP (dBc)	Measured ACP (dBc)
>400 to 12 MHz	30(s)	-75	-82.8
12 MHz to receive band	30(s)	-75	-82.9
In receive band	30(s)	-100	-102.1

Plot 6-6: Adjacent Channel Power – 799.0125 MHz; Analog Mode; (9.375 kHz - 350 kHz)

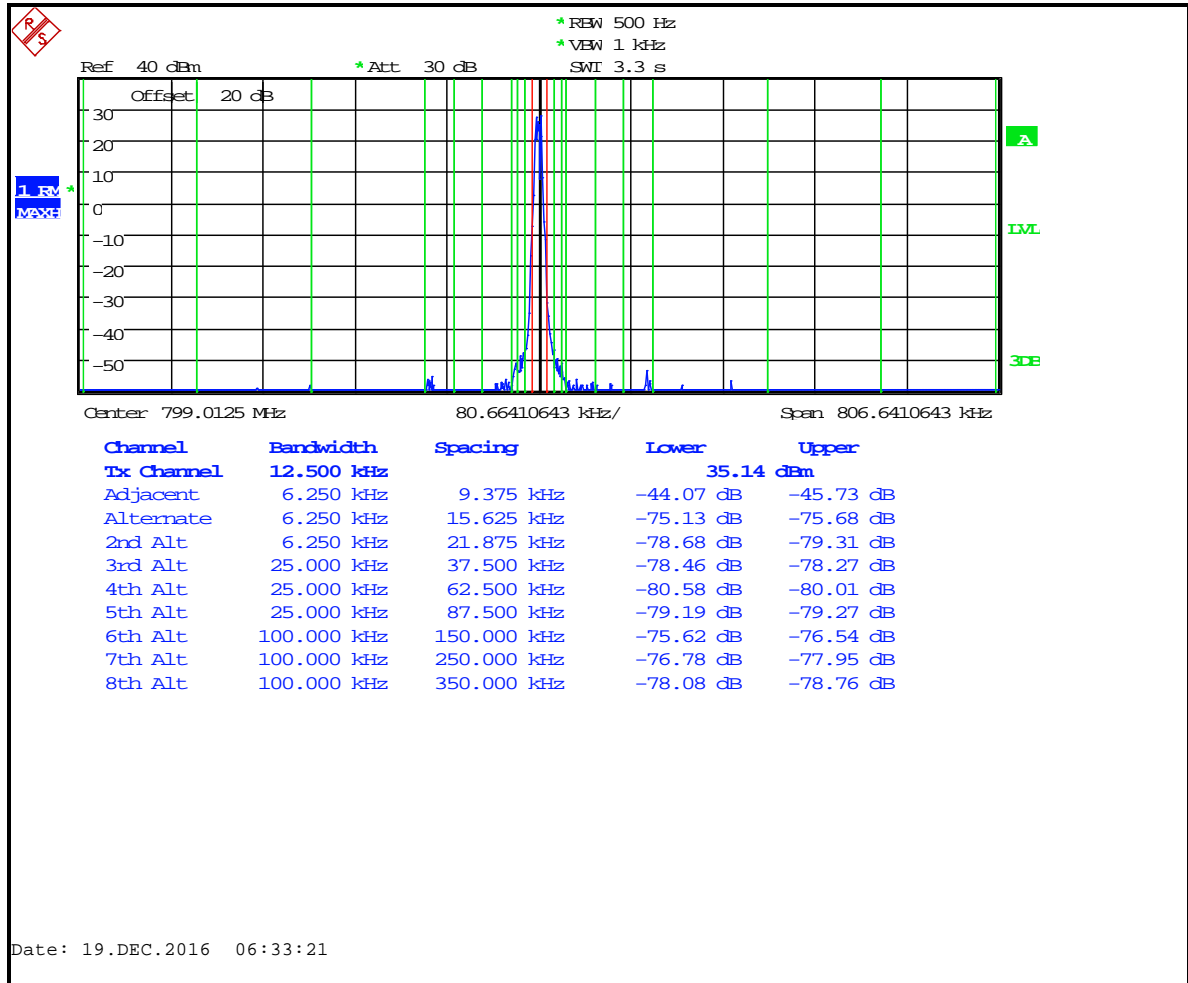

Table 6-6: Adjacent Channel Power – 799.0125 MHz; Analog Mode (>400 kHz - RX Band)

Offset from Center Frequency (kHz)	Measurement BW (kHz)	Max ACP (dBc)	Measured ACP (dBc)
>400 to 12 MHz	30(s)	-75	-82.8
12 MHz to receive band	30(s)	-75	-82.4
In receive band	30(s)	-100	-101.5

Plot 6-7: Adjacent Channel Power – 801.0125 MHz; Analog Mode; (9.375 kHz - 350 kHz)

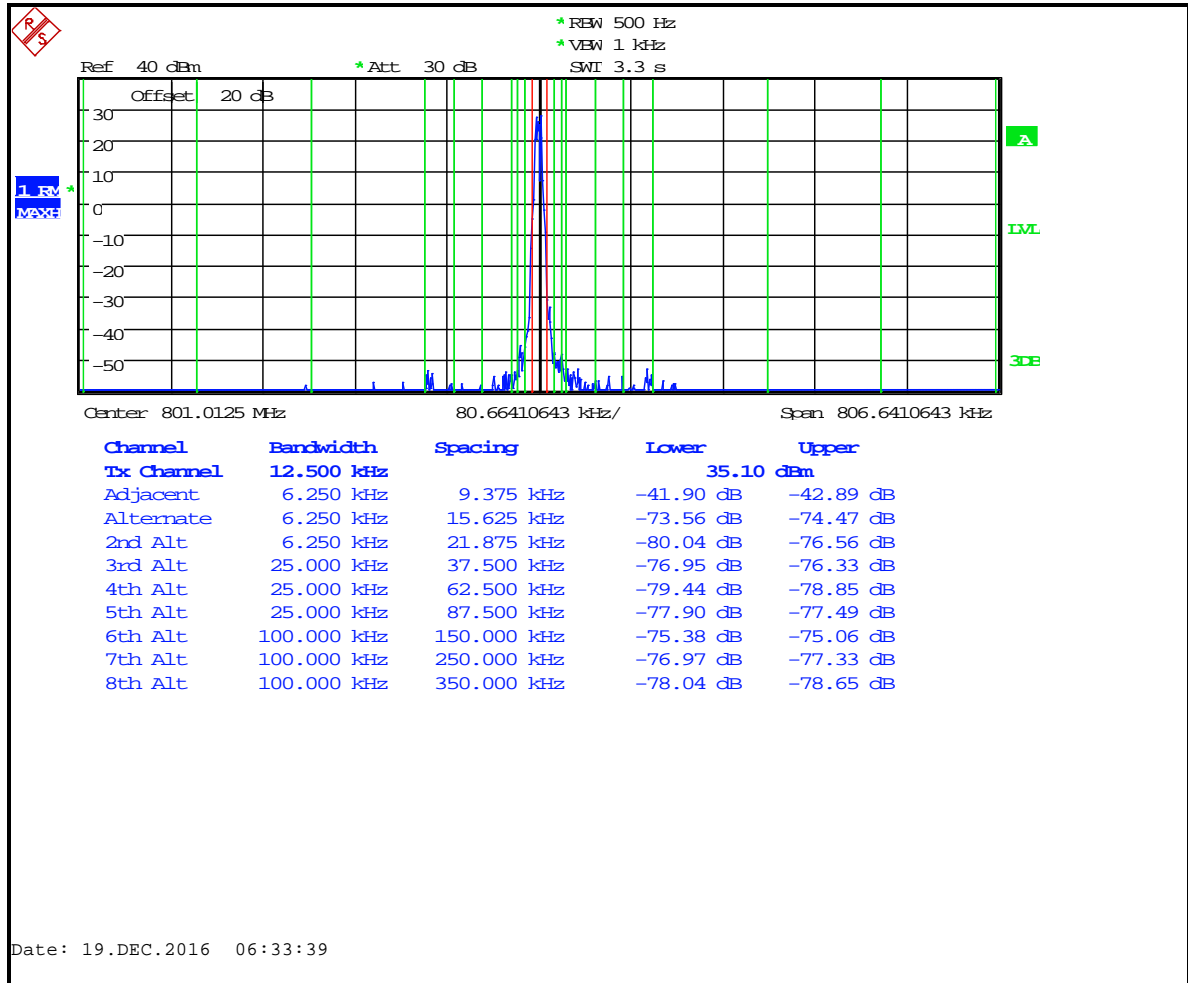

Table 6-7: Adjacent Channel Power – 801.0125 MHz; Analog Mode (>400 kHz - RX Band)

Offset from Center Frequency (kHz)	Measurement BW (kHz)	Max ACP (dBc)	Measured ACP (dBc)
>400 to 12 MHz	30(s)	-75	-82.4
12 MHz to receive band	30(s)	-75	-82.9
In receive band	30(s)	-100	-102.6

Plot 6-8: Adjacent Channel Power – 805.9875 MHz; Analog Mode; (9.375 kHz - 350 kHz)

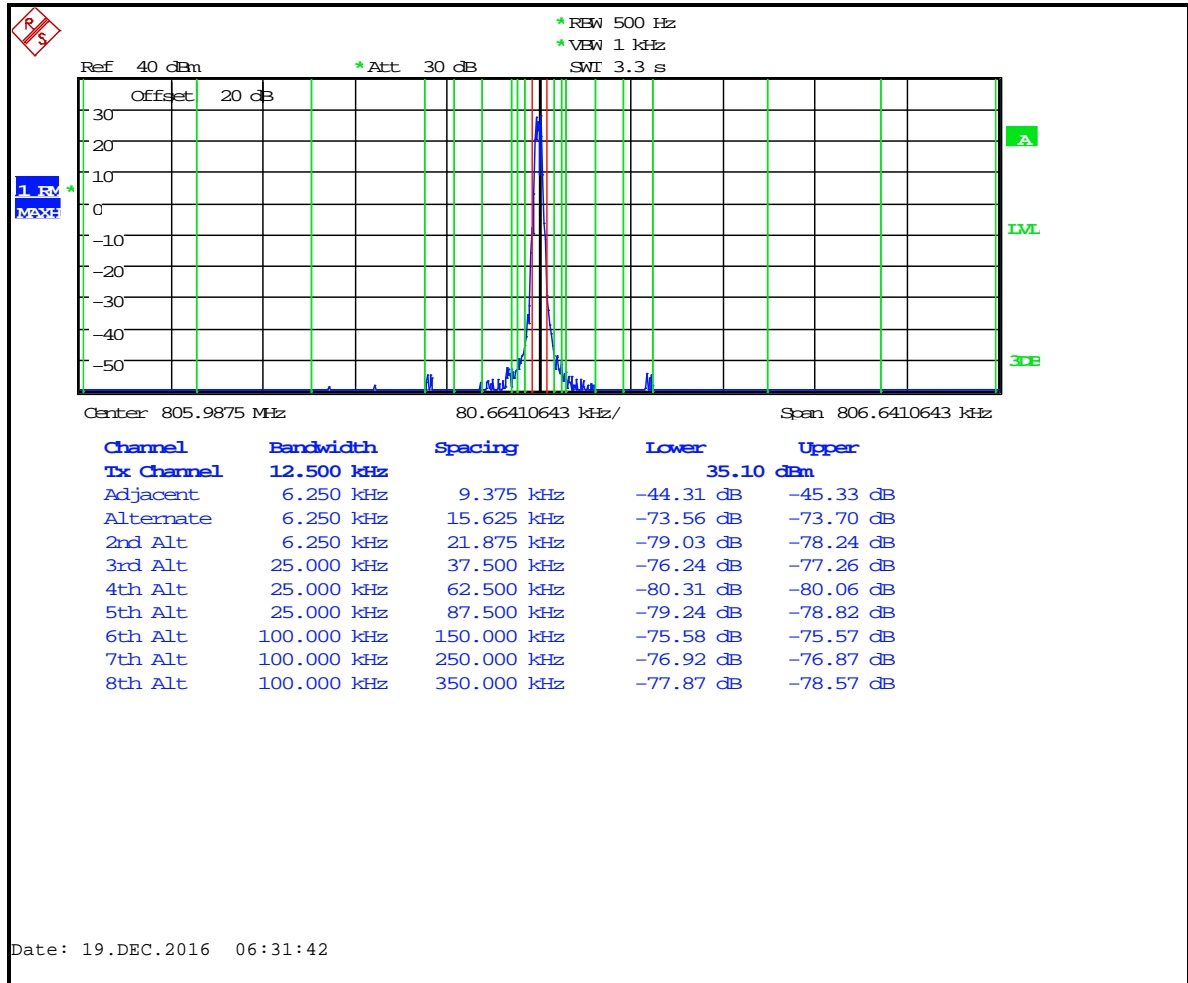

Table 6-8: Adjacent Channel Power – 805.9875 MHz; Analog Mode (>400 kHz - RX Band)

Offset from Center Frequency (kHz)	Measurement BW (kHz)	Max ACP (dBc)	Measured ACP (dBc)
>400 to 12 MHz	30(s)	-75	-83.0
12 MHz to receive band	30(s)	-75	-83.3
In receive band	30(s)	-100	-103.5

Plot 6-9: Adjacent Channel Power - 768.0125 MHz; 2-Level FSK 9600 NB (9.375 kHz - 350 kHz)

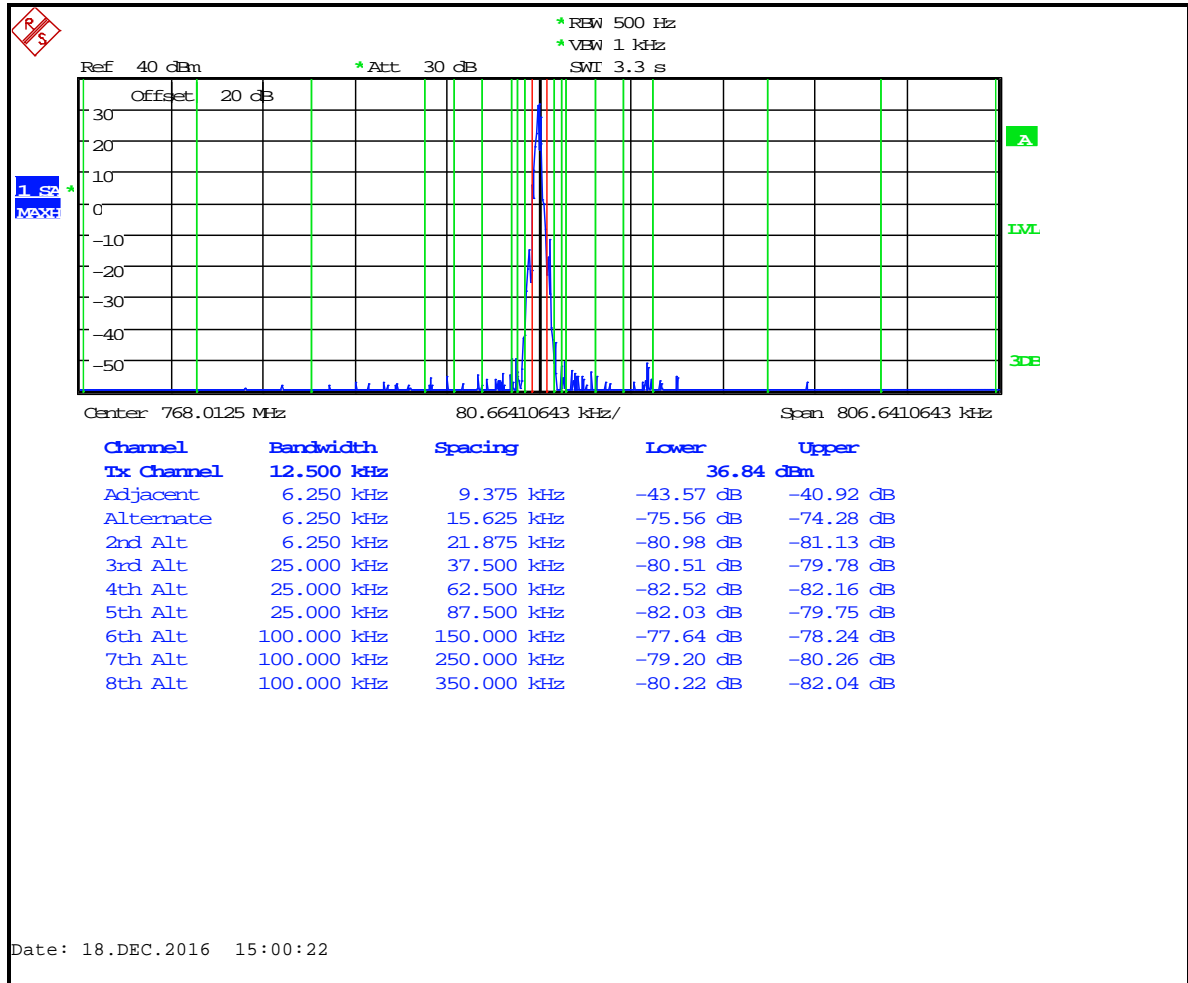

Table 6-9: Adjacent Channel Power - 768.0125 MHz; 2-Level FSK 9600 NB (>400 kHz - RX Band)

Offset from Center Frequency (kHz)	Measurement BW (kHz)	Max ACP (dBc)	Measured ACP (dBc)
>400 to 12 MHz	30(s)	-75	-85.6
12 MHz to receive band	30(s)	-75	-90.8
In receive band	30(s)	-100	-103.4

Plot 6-10: Adjacent Channel Power - 769.0125 MHz; 2-Level FSK 9600 NB (9.375 kHz - 350 kHz)

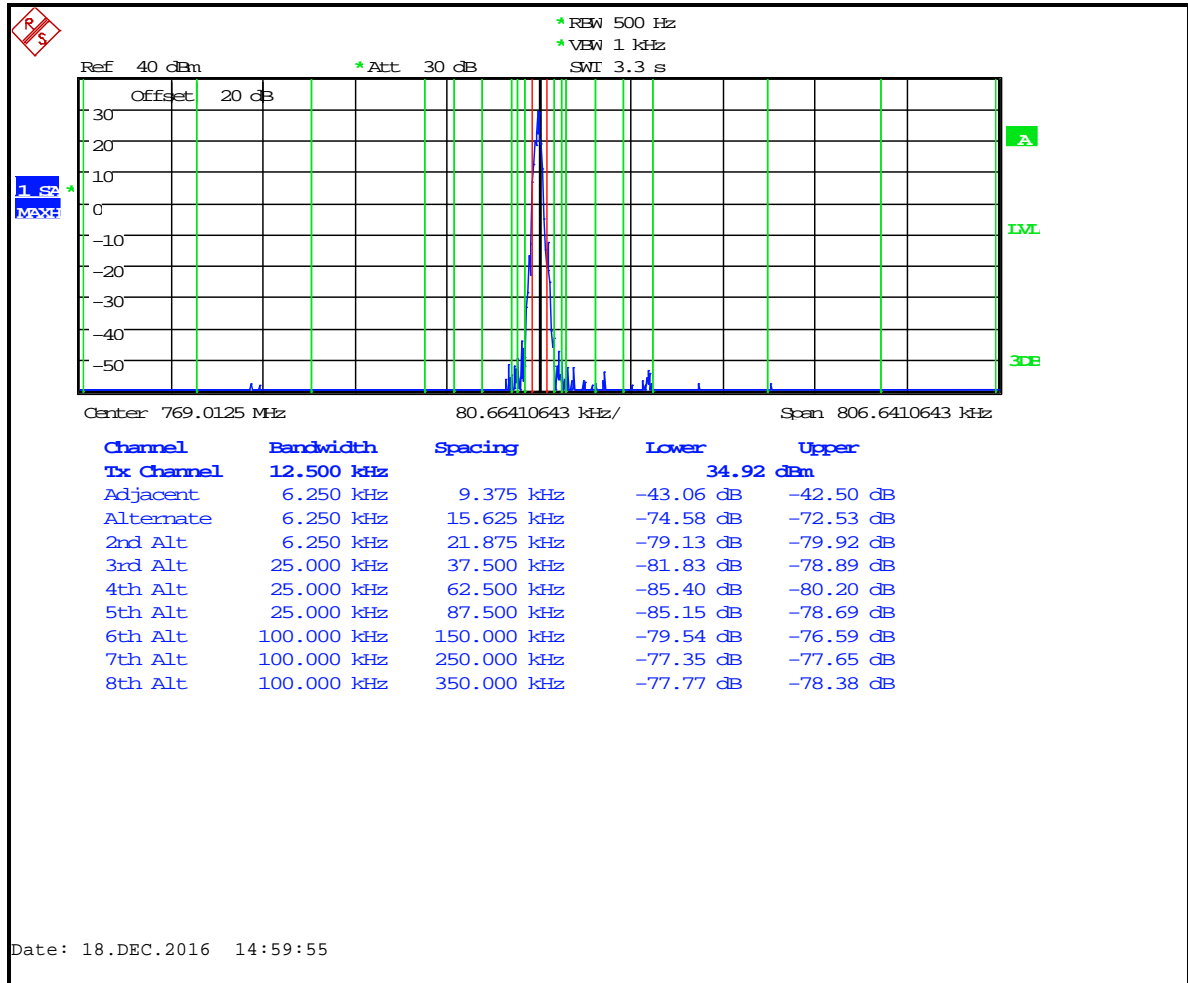

Table 6-10: Adjacent Channel Power - 769.0125 MHz; 2-Level FSK 9600 NB (>400 kHz - RX Band)

Offset from Center Frequency (kHz)	Measurement BW (kHz)	Max ACP (dBc)	Measured ACP (dBc)
>400 to 12 MHz	30(s)	-75	-83.8
12 MHz to receive band	30(s)	-75	-91.6
In receive band	30(s)	-100	-103.6

Plot 6-11: Adjacent Channel Power - 772.0125 MHz; 2-Level FSK 9600 NB (9.375 kHz - 350 kHz)

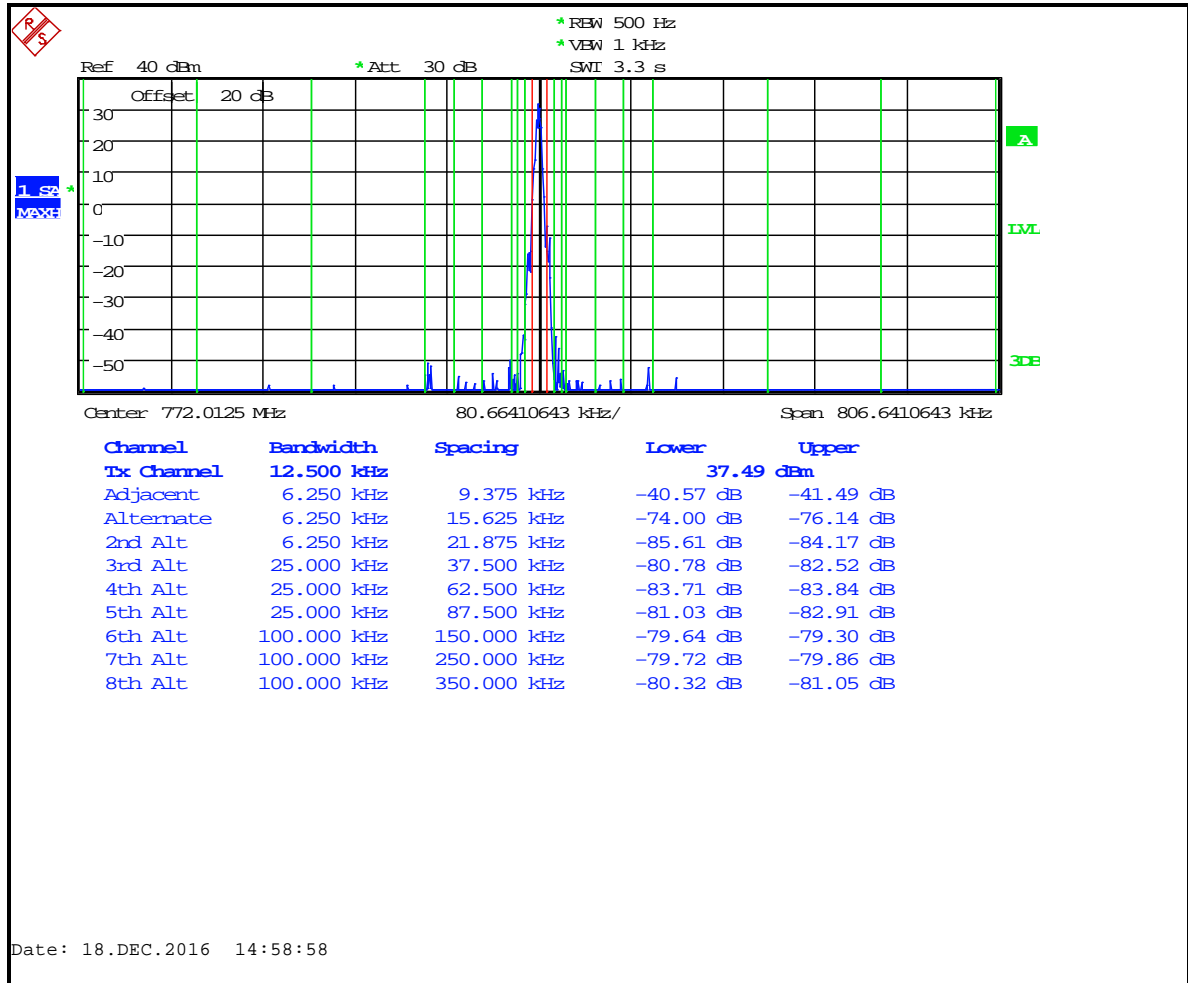

Table 6-11: Adjacent Channel Power - 772.0125 MHz; 2-Level FSK 9600 NB (>400 kHz - RX Band)

Offset from Center Frequency (kHz)	Measurement BW (kHz)	Max ACP (dBc)	Measured ACP (dBc)
>400 to 12 MHz	30(s)	-75	-84.0
12 MHz to receive band	30(s)	-75	-91.4
In receive band	30(s)	-100	-103.5

Plot 6-12: Adjacent Channel Power - 775.9875 MHz; 2-Level FSK 9600 NB (9.375 kHz - 350 kHz)

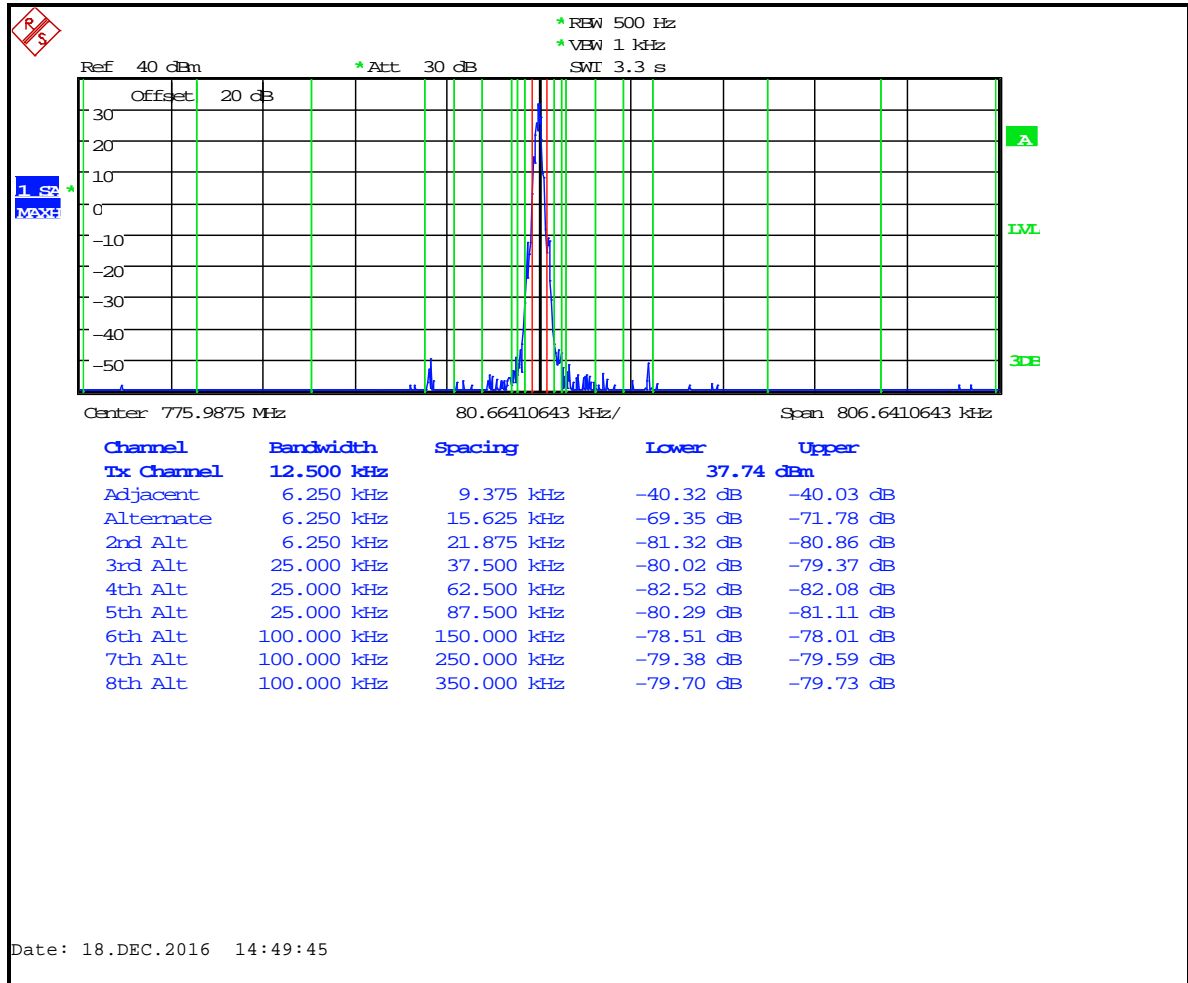

Table 6-12: Adjacent Channel Power - 775.9875 MHz; 2-Level FSK 9600 NB (>400 kHz - RX Band)

Offset from Center Frequency (kHz)	Measurement BW (kHz)	Max ACP (dBc)	Measured ACP (dBc)
>400 to 12 MHz	30(s)	-75	-84.4
12 MHz to receive band	30(s)	-75	-91.5
In receive band	30(s)	-100	-103.4

Plot 6-13: Adjacent Channel Power – 798.0125 MHz; 2-Level FSK 9600 NB (9.375 kHz - 350 kHz)

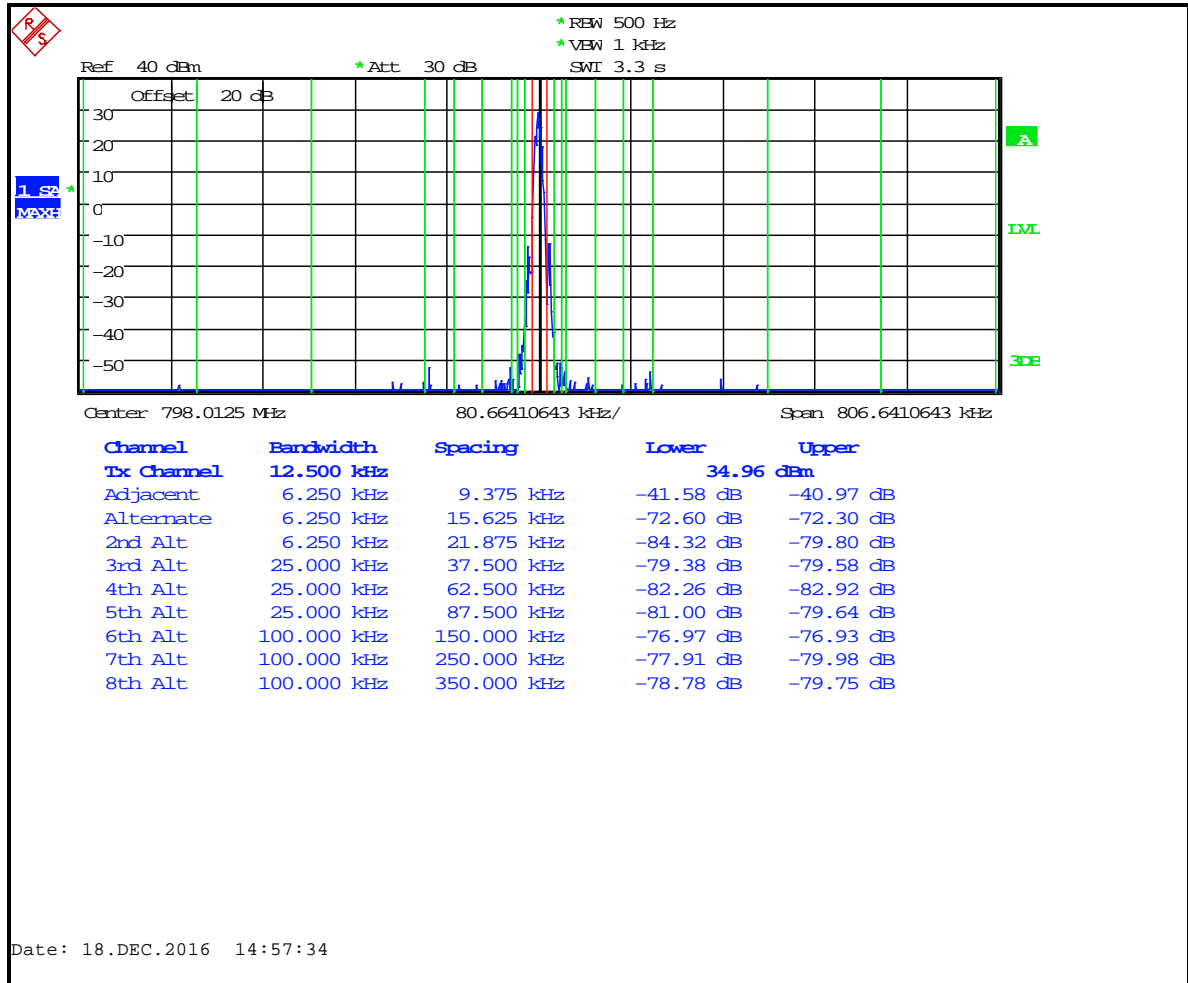

Table 6-13: Adjacent Channel Power – 798.0125 MHz; 2-Level FSK 9600 NB (>400 kHz - RX Band)

Offset from Center Frequency (kHz)	Measurement BW (kHz)	Max ACP (dBc)	Measured ACP (dBc)
>400 to 12 MHz	30(s)	-75	-84.4
12 MHz to receive band	30(s)	-75	-91.2
In receive band	30(s)	-100	-101.9

Plot 6-14: Adjacent Channel Power – 799.0125 MHz; 2-Level FSK 9600 NB (9.375 kHz - 350 kHz)

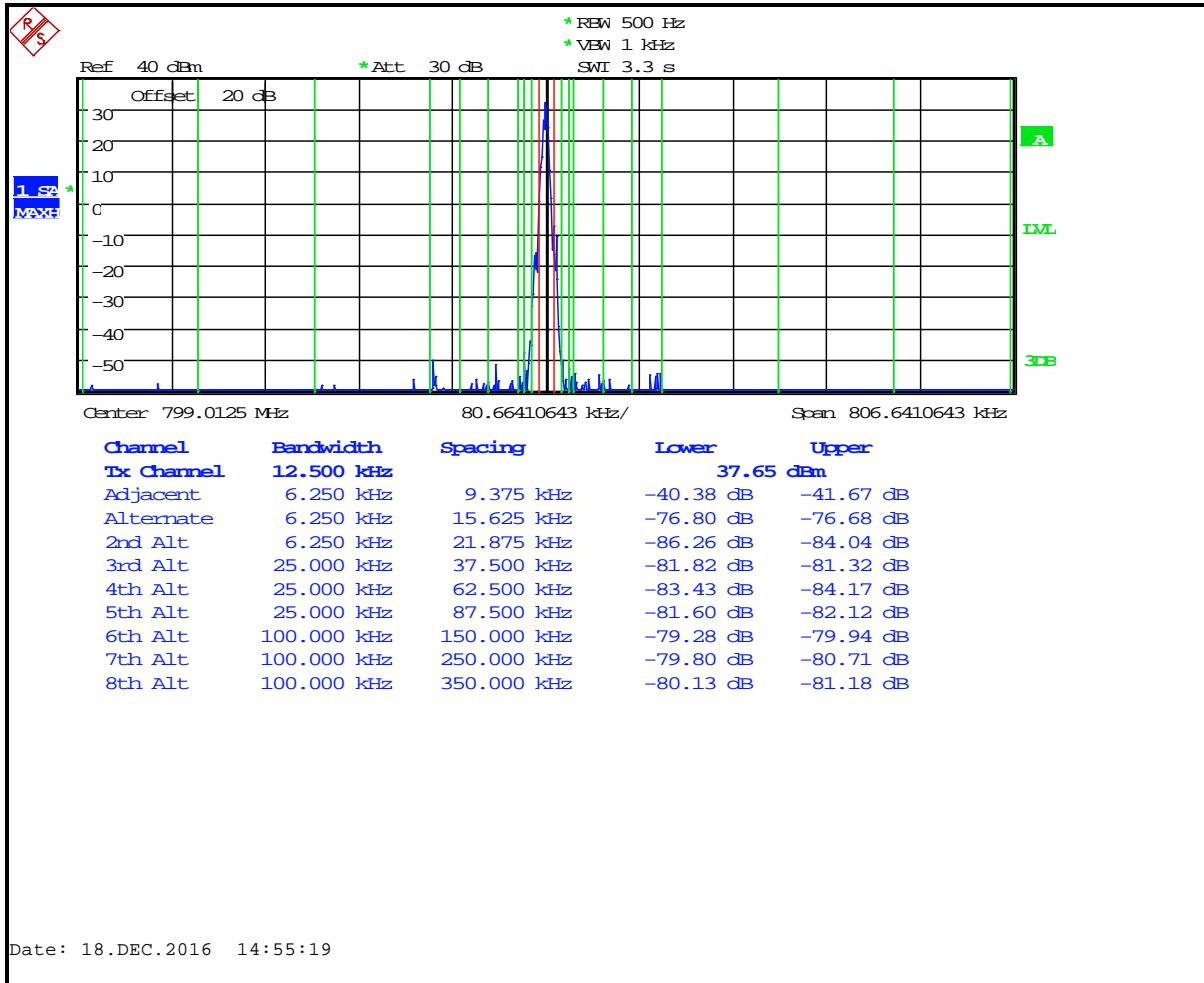

Table 6-14: Adjacent Channel Power – 799.0125 MHz; 2-Level FSK 9600 NB (>400 kHz - RX Band)

Offset from Center Frequency (kHz)	Measurement BW (kHz)	Max ACP (dBc)	Measured ACP (dBc)
>400 to 12 MHz	30(s)	-75	-83.8
12 MHz to receive band	30(s)	-75	-91.3
In receive band	30(s)	-100	-101.8

Plot 6-15: Adjacent Channel Power – 801.0125 MHz; 2-Level FSK 9600 NB (9.375 kHz - 350 kHz)

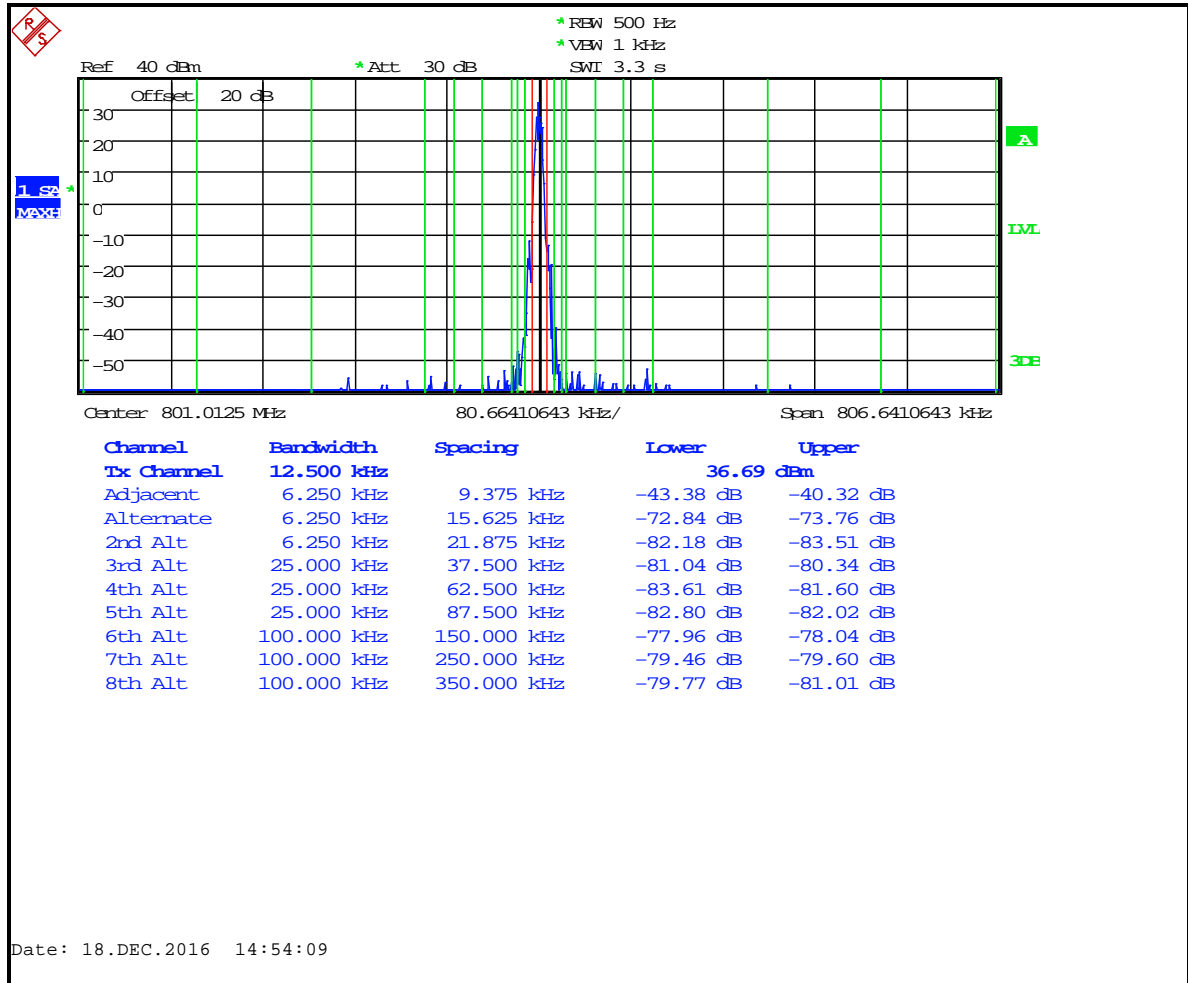

Table 6-15: Adjacent Channel Power – 801.0125 MHz; 2-Level FSK 9600 NB (>400 kHz - RX Band)

Offset from Center Frequency (kHz)	Measurement BW (kHz)	Max ACP (dBc)	Measured ACP (dBc)
>400 to 12 MHz	30(s)	-75	-85.9
12 MHz to receive band	30(s)	-75	-91.0
In receive band	30(s)	-100	-102.3

Plot 6-16: Adjacent Channel Power – 805.9875 MHz; 2-Level FSK 9600 NB (9.375 kHz - 350 kHz)

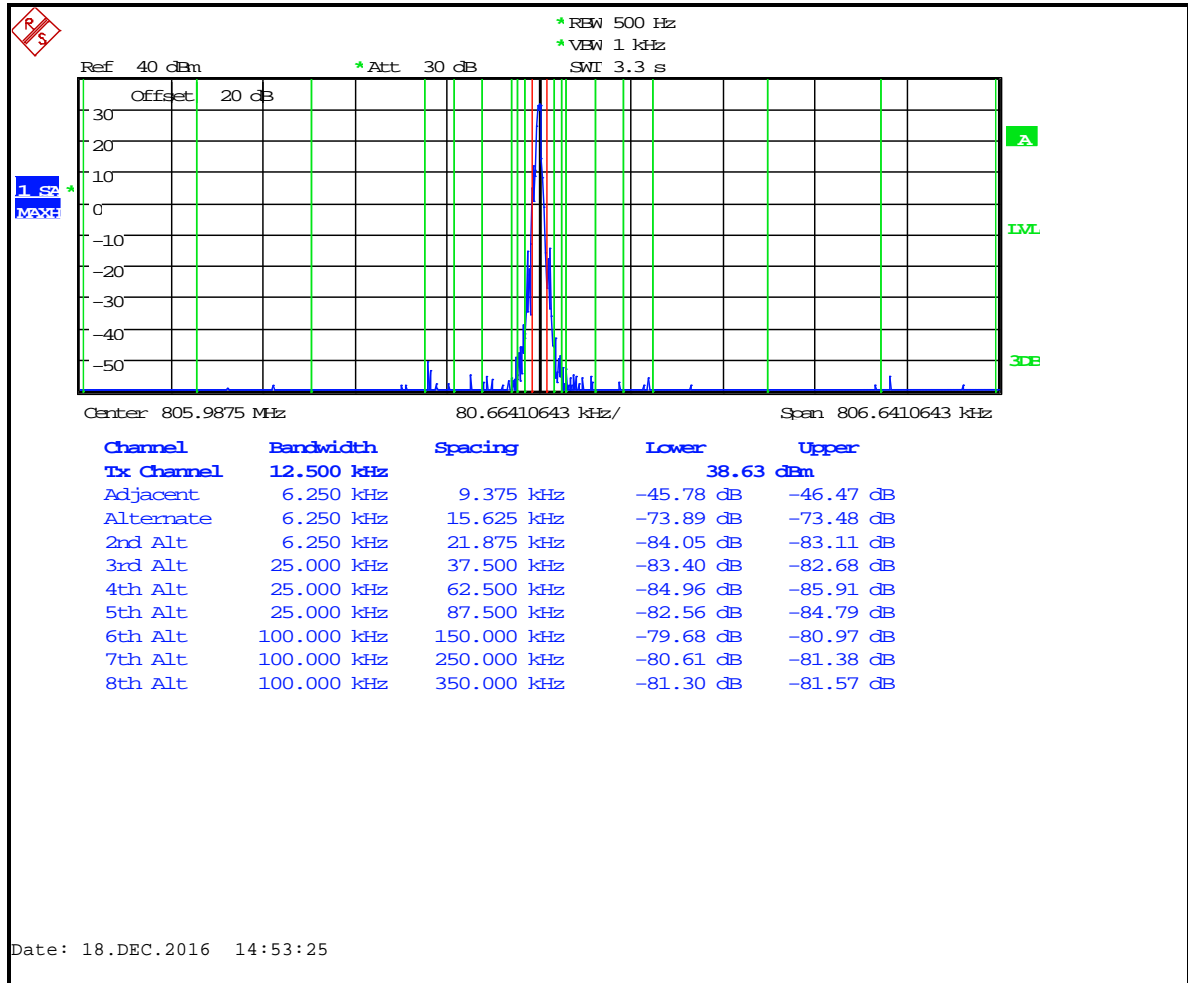

Table 6-16: Adjacent Channel Power – 805.9875 MHz; 2-Level FSK 9600 NB (>400 kHz - RX Band)

Offset from Center Frequency (kHz)	Measurement BW (kHz)	Max ACP (dBc)	Measured ACP (dBc)
>400 to 12 MHz	30(s)	-75	-84.2
12 MHz to receive band	30(s)	-75	-90.0
In receive band	30(s)	-100	-103.2

Plot 6-17: Adjacent Channel Power - 768.0125 MHz; C4FM Mode (9.375 kHz - 350 kHz)

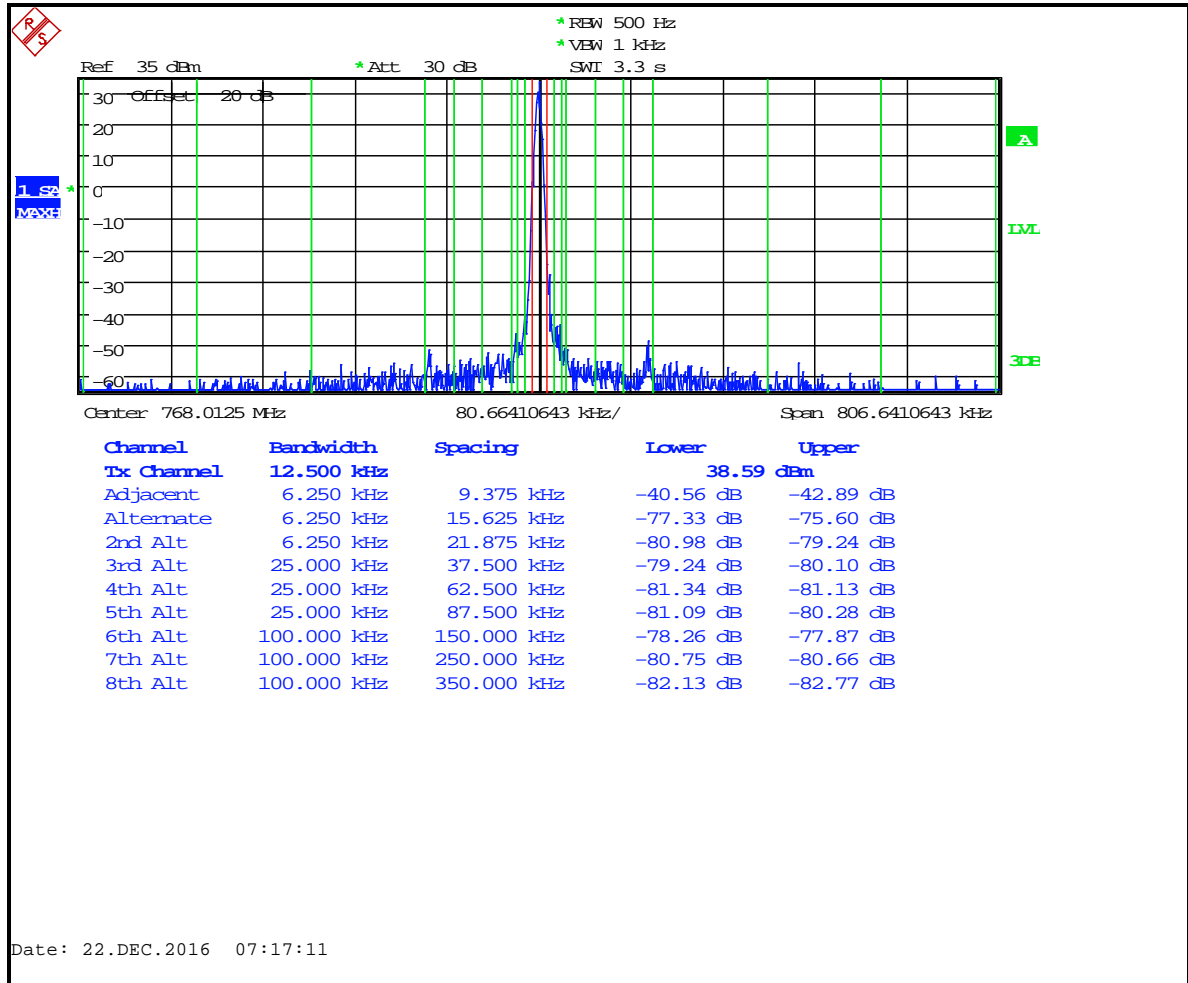

Table 6-17: Adjacent Channel Power - 768.0125 MHz; C4FM Mode (>400 kHz - RX Band)

Offset from Center Frequency (kHz)	Measurement BW (kHz)	Max ACP (dBc)	Measured ACP (dBc)
>400 to 12 MHz	30(s)	-75	-83.2
12 MHz to receive band	30(s)	-75	-85.7
In receive band	30(s)	-100	-105.4

Plot 6-18: Adjacent Channel Power - 769.0125 MHz; C4FM Mode (9.375 kHz - 350 kHz)

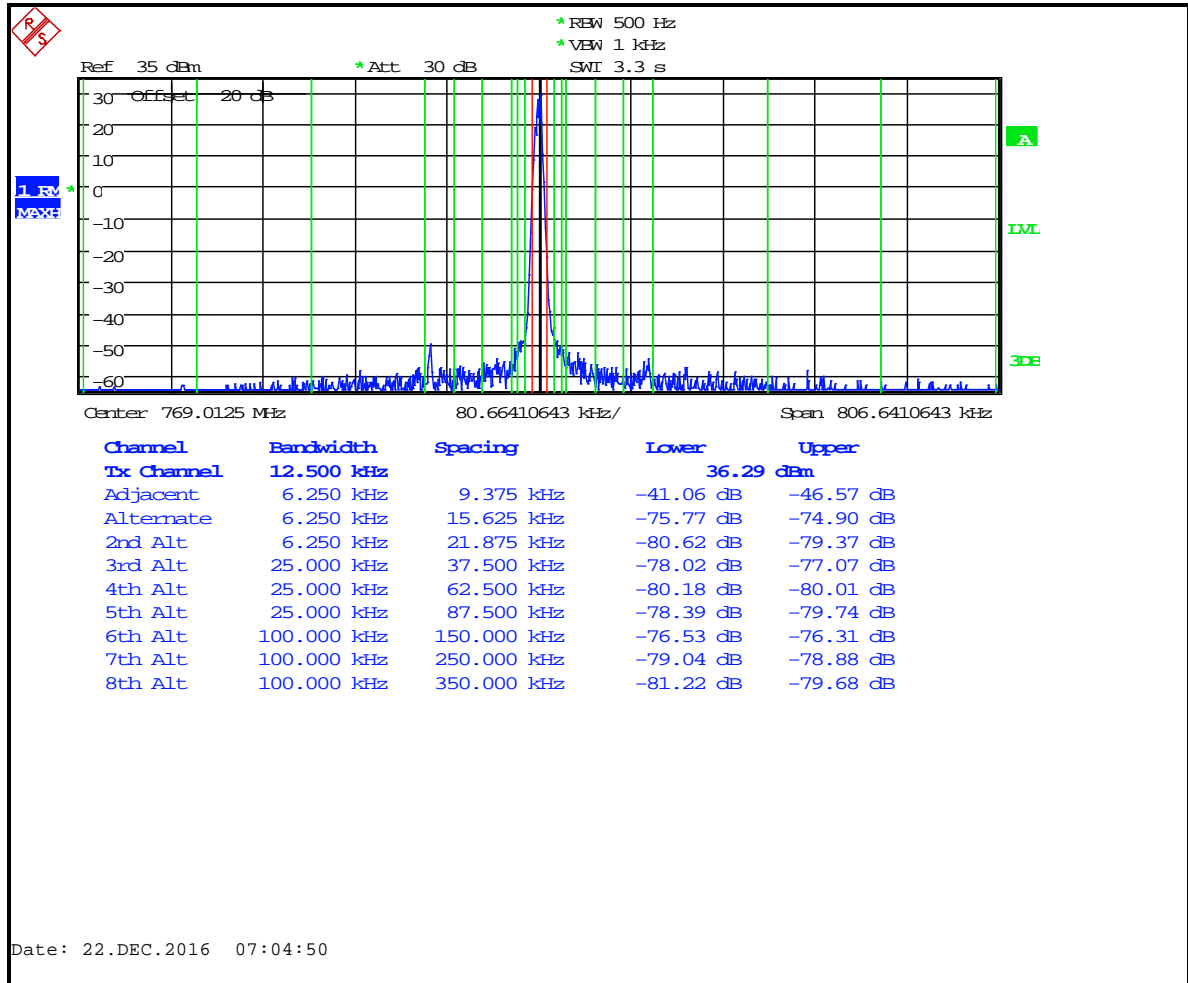

Table 6-18: Adjacent Channel Power - 769.0125 MHz; C4FM Mode (>400 kHz - RX Band)

Offset from Center Frequency (kHz)	Measurement BW (kHz)	Max ACP (dBc)	Measured ACP (dBc)
>400 to 12 MHz	30(s)	-75	-80.5
12 MHz to receive band	30(s)	-75	-86.4
In receive band	30(s)	-100	-105.4

Plot 6-19: Adjacent Channel Power - 772.0125 MHz; C4FM Mode (9.375 kHz - 350 kHz)

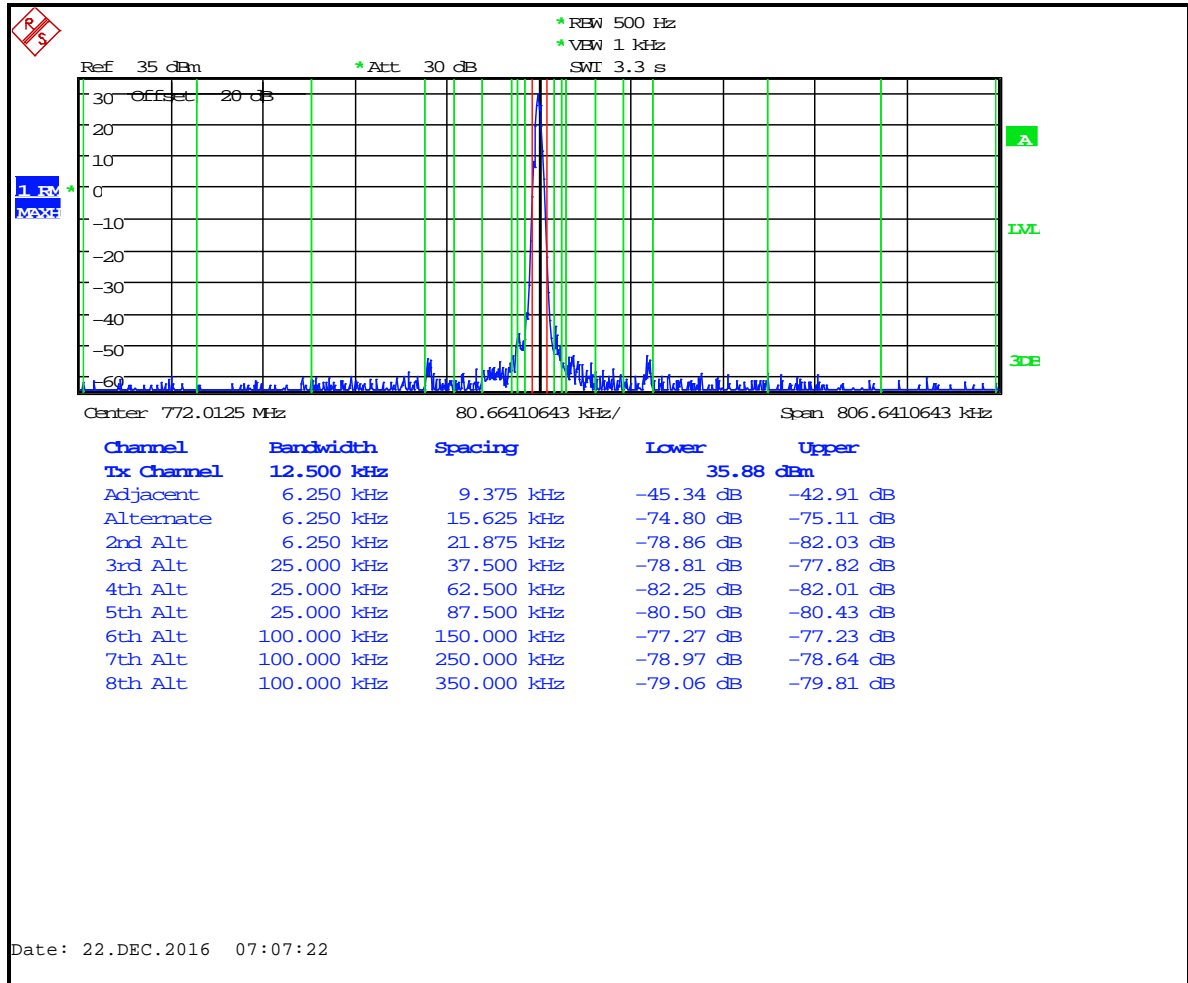

Table 6-19: Adjacent Channel Power - 772.0125 MHz; C4FM Mode (>400 kHz - RX Band)

Offset from Center Frequency (kHz)	Measurement BW (kHz)	Max ACP (dBc)	Measured ACP (dBc)
>400 to 12 MHz	30(s)	-75	-80.5
12 MHz to receive band	30(s)	-75	-85.8
In receive band	30(s)	-100	-105.3

Plot 6-20: Adjacent Channel Power - 775.9875 MHz; C4FM Mode (9.375 kHz - 350 kHz)

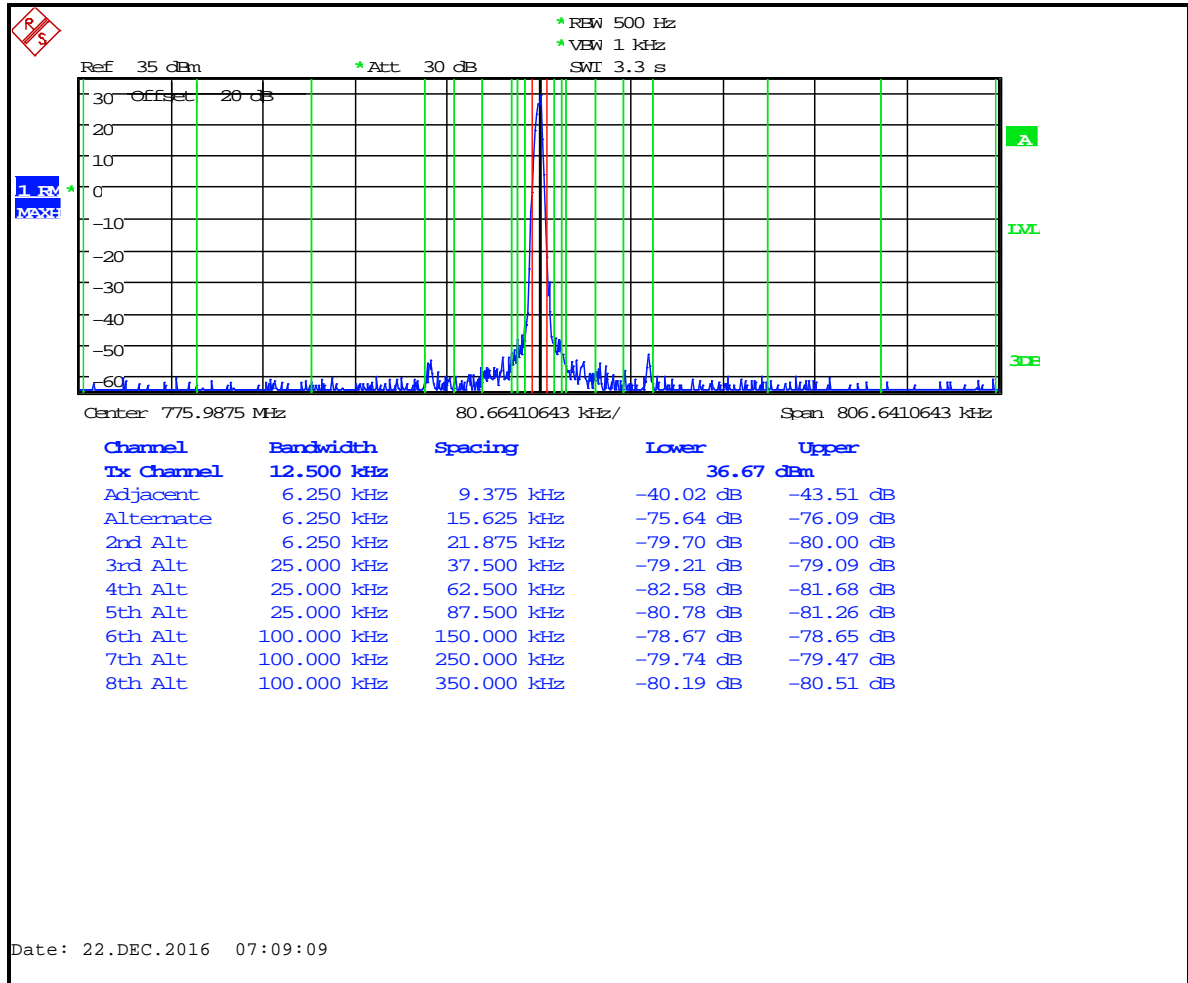

Table 6-20: Adjacent Channel Power - 775.9875 MHz; C4FM Mode (>400 kHz - RX Band)

Offset from Center Frequency (kHz)	Measurement BW (kHz)	Max ACP (dBc)	Measured ACP (dBc)
>400 to 12 MHz	30(s)	-75	-79.5
12 MHz to receive band	30(s)	-75	-85.4
In receive band	30(s)	-100	-105.4

Plot 6-21: Adjacent Channel Power – 798.0125 MHz; C4FM Mode (9.375 kHz - 350 kHz)

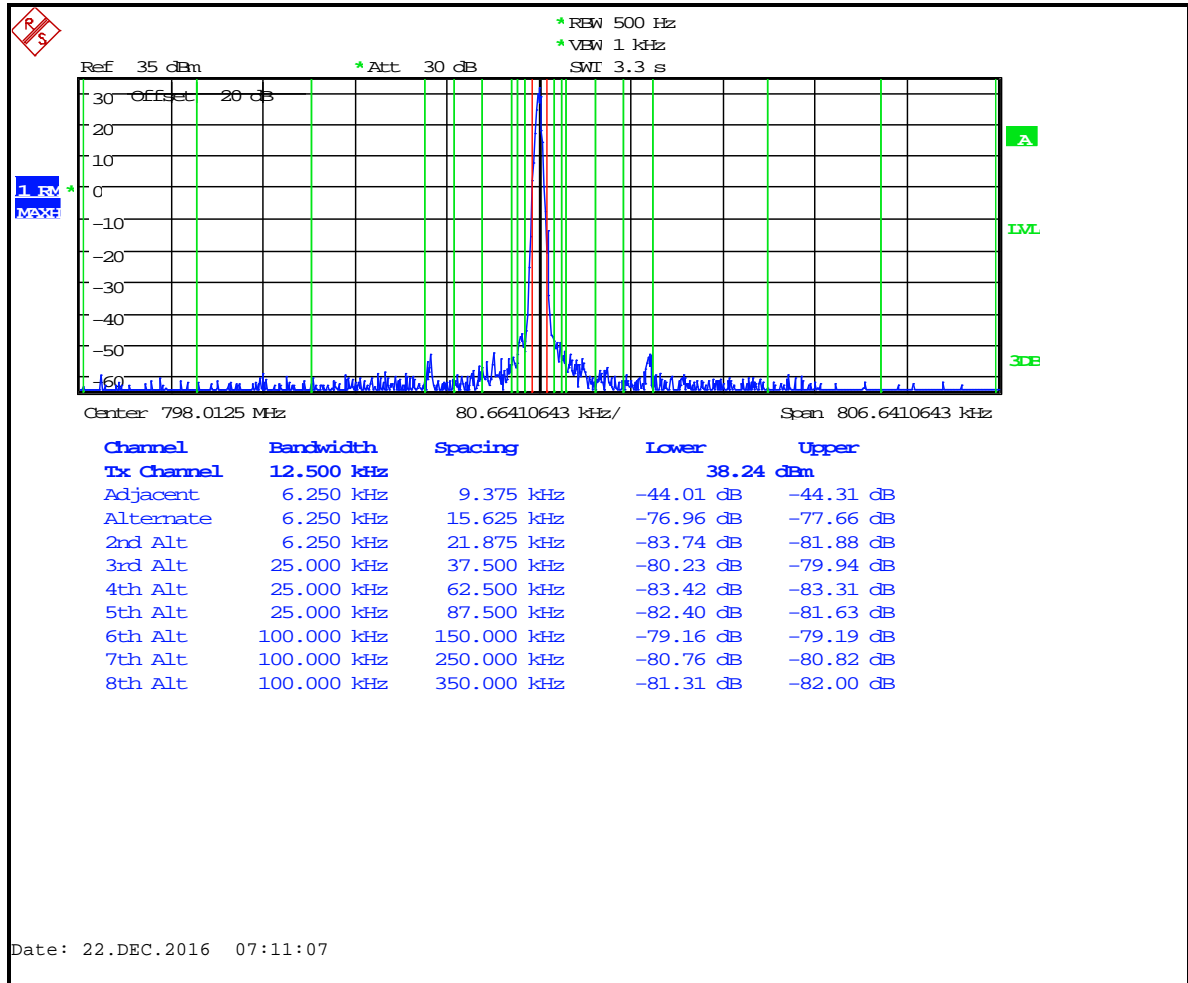

Table 6-21: Adjacent Channel Power – 798.0125 MHz; C4FM Mode (>400 kHz - RX Band)

Offset from Center Frequency (kHz)	Measurement BW (kHz)	Max ACP (dBc)	Measured ACP (dBc)
>400 to 12 MHz	30(s)	-75	-79.5
12 MHz to receive band	30(s)	-75	-85.1
In receive band	30(s)	-100	-103.1

Plot 6-22: Adjacent Channel Power – 799.0125 MHz; C4FM Mode (9.375 kHz - 350 kHz)

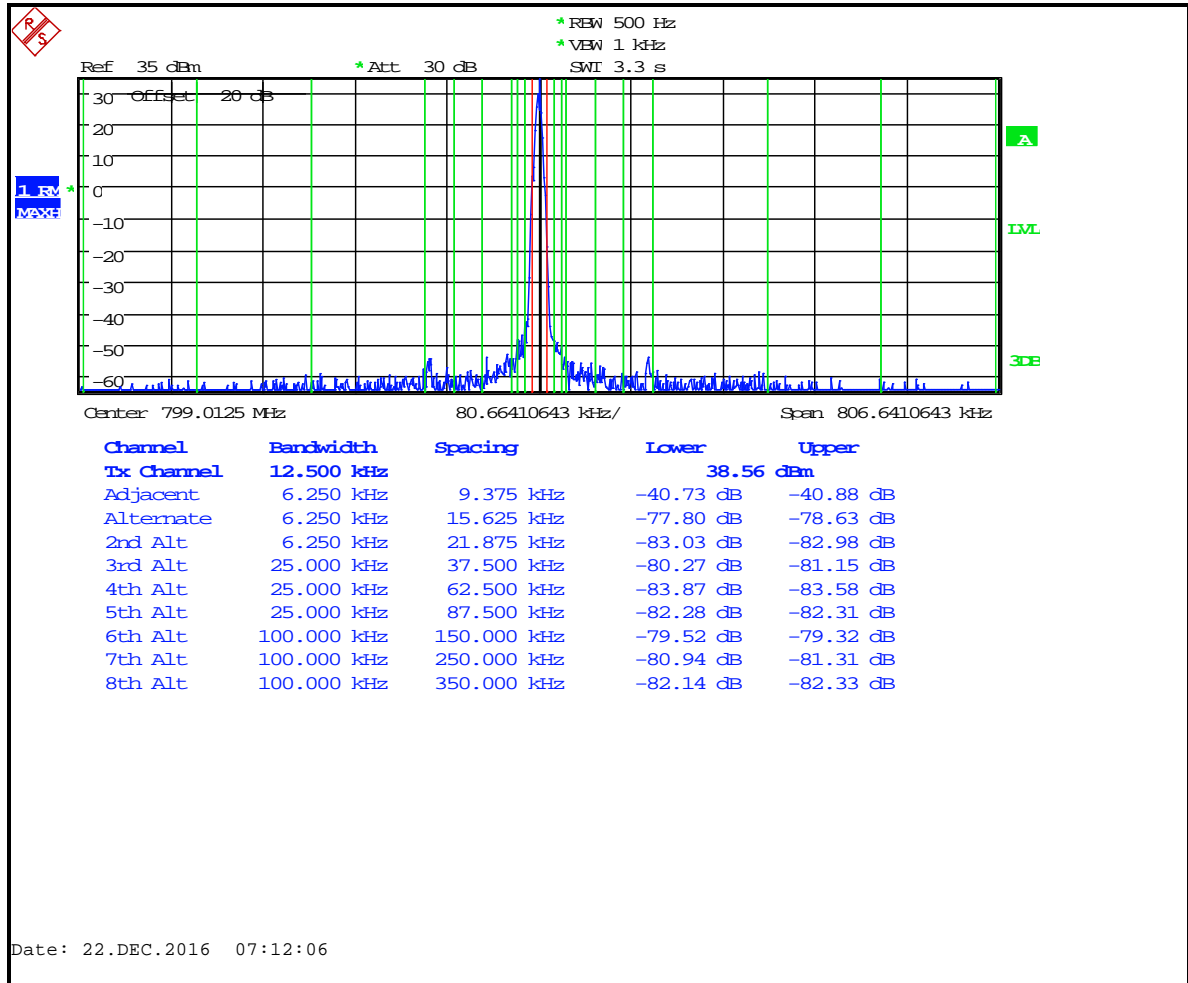

Table 6-22: Adjacent Channel Power – 799.0125 MHz; C4FM Mode (>400 kHz - RX Band)

Offset from Center Frequency (kHz)	Measurement BW (kHz)	Max ACP (dBc)	Measured ACP (dBc)
>400 to 12 MHz	30(s)	-75	-80.2
12 MHz to receive band	30(s)	-75	-86.2
In receive band	30(s)	-100	-103.5

Plot 6-23: Adjacent Channel Power – 801.0125 MHz; C4FM Mode (9.375 kHz - 350 kHz)

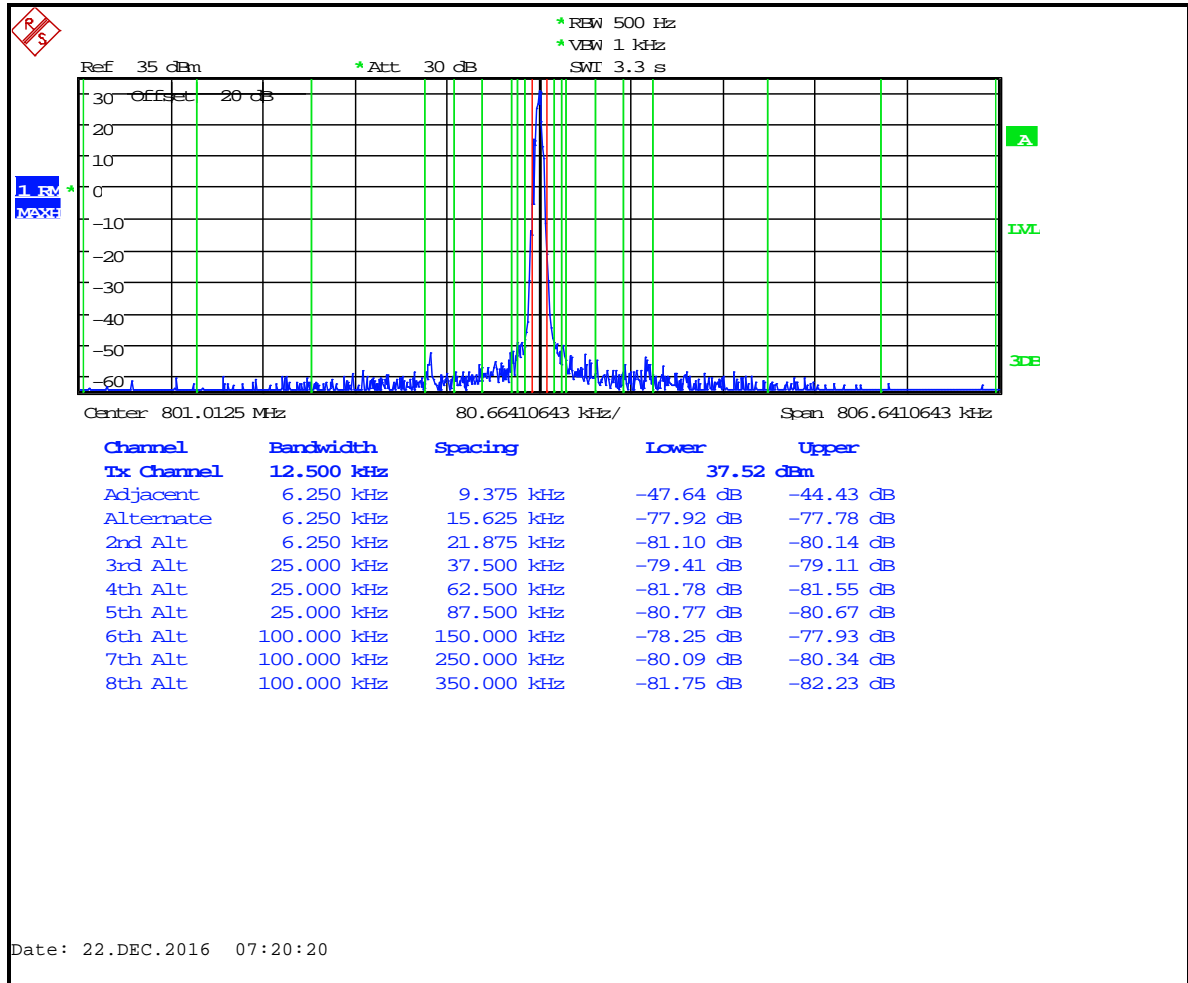

Table 6-23: Adjacent Channel Power – 801.0125 MHz; C4FM Mode (>400 kHz - RX Band)

Offset from Center Frequency (kHz)	Measurement BW (kHz)	Max ACP (dBc)	Measured ACP (dBc)
>400 to 12 MHz	30(s)	-75	-82.4
12 MHz to receive band	30(s)	-75	-85.9
In receive band	30(s)	-100	-103.8

Plot 6-24: Adjacent Channel Power – 805.9875 MHz; C4FM Mode (9.375 kHz - 350 kHz)

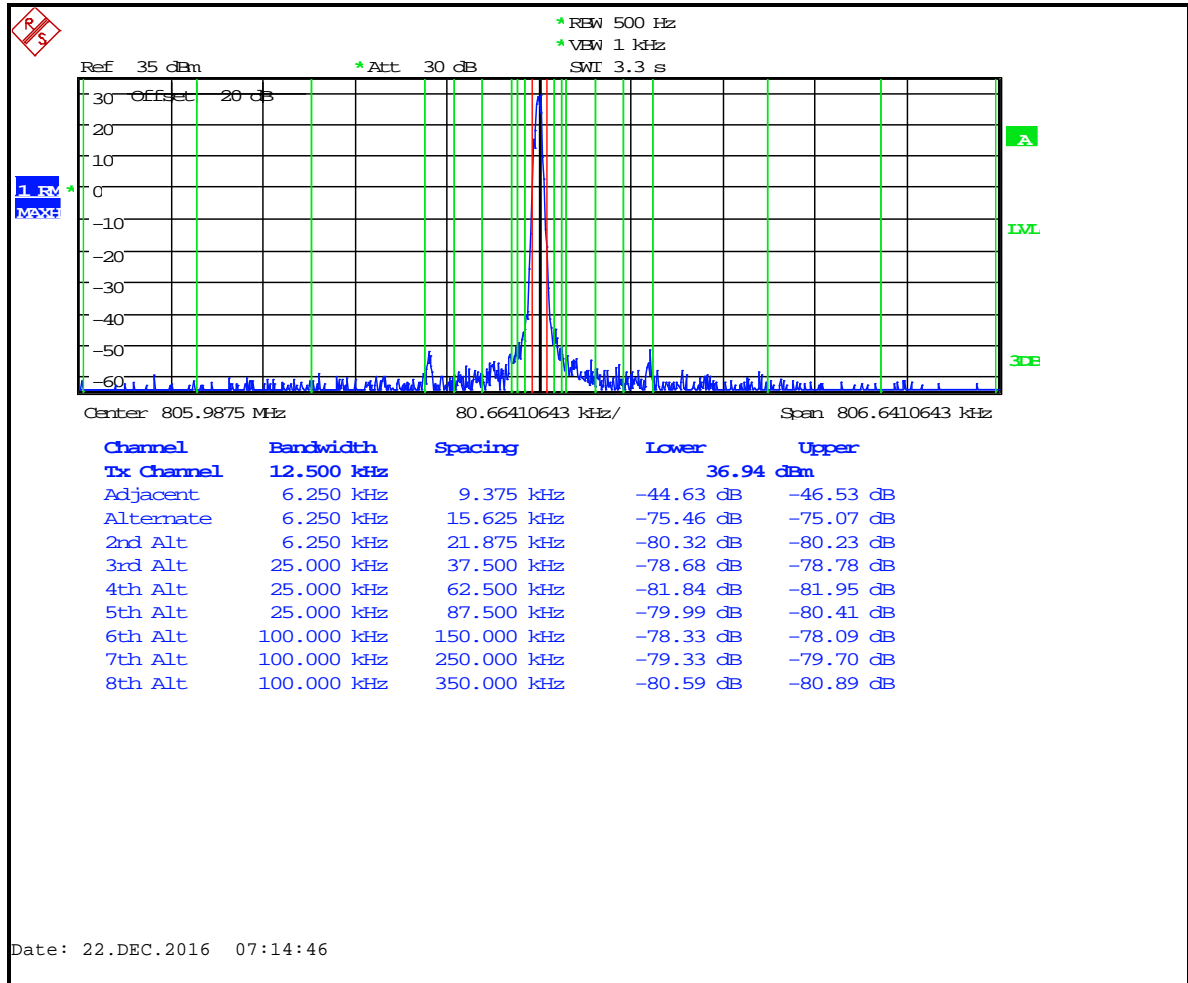

Table 6-24: Adjacent Channel Power – 805.9875 MHz; C4FM Mode (>400 kHz - RX Band)

Offset from Center Frequency (kHz)	Measurement BW (kHz)	Max ACP (dBc)	Measured ACP (dBc)
>400 to 12 MHz	30(s)	-75	-80.1
12 MHz to receive band	30(s)	-75	-84.8
In receive band	30(s)	-100	-105.5

Plot 6-25: Adjacent Channel Power - 768.0125 MHz; H-CPM (TDMA) Mode (9.375 kHz - 350 kHz)

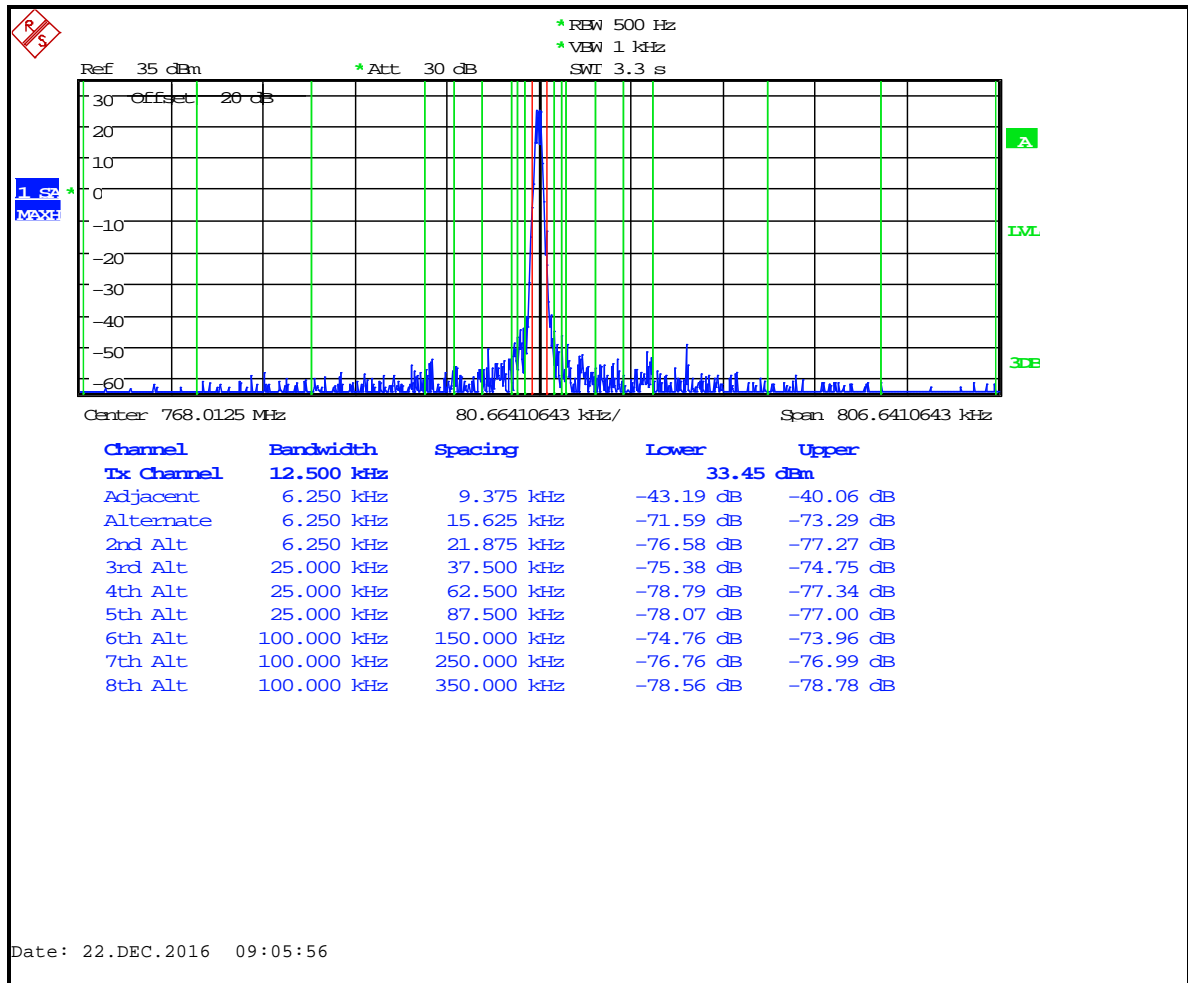

Table 6-25: Adjacent Channel Power - 768.0125 MHz; H-CPM (TDMA) Mode (>400 kHz - RX Band)

Offset from Center Frequency (kHz)	Measurement BW (kHz)	Max ACP (dBc)	Measured ACP (dBc)
>400 to 12 MHz	30(s)	-75	-87.1
12 MHz to receive band	30(s)	-75	-85.8
In receive band	30(s)	-100	-105.4

Plot 6-26: Adjacent Channel Power - 769.0125 MHz; H-CPM (TDMA) Mode (9.375 kHz - 350 kHz)

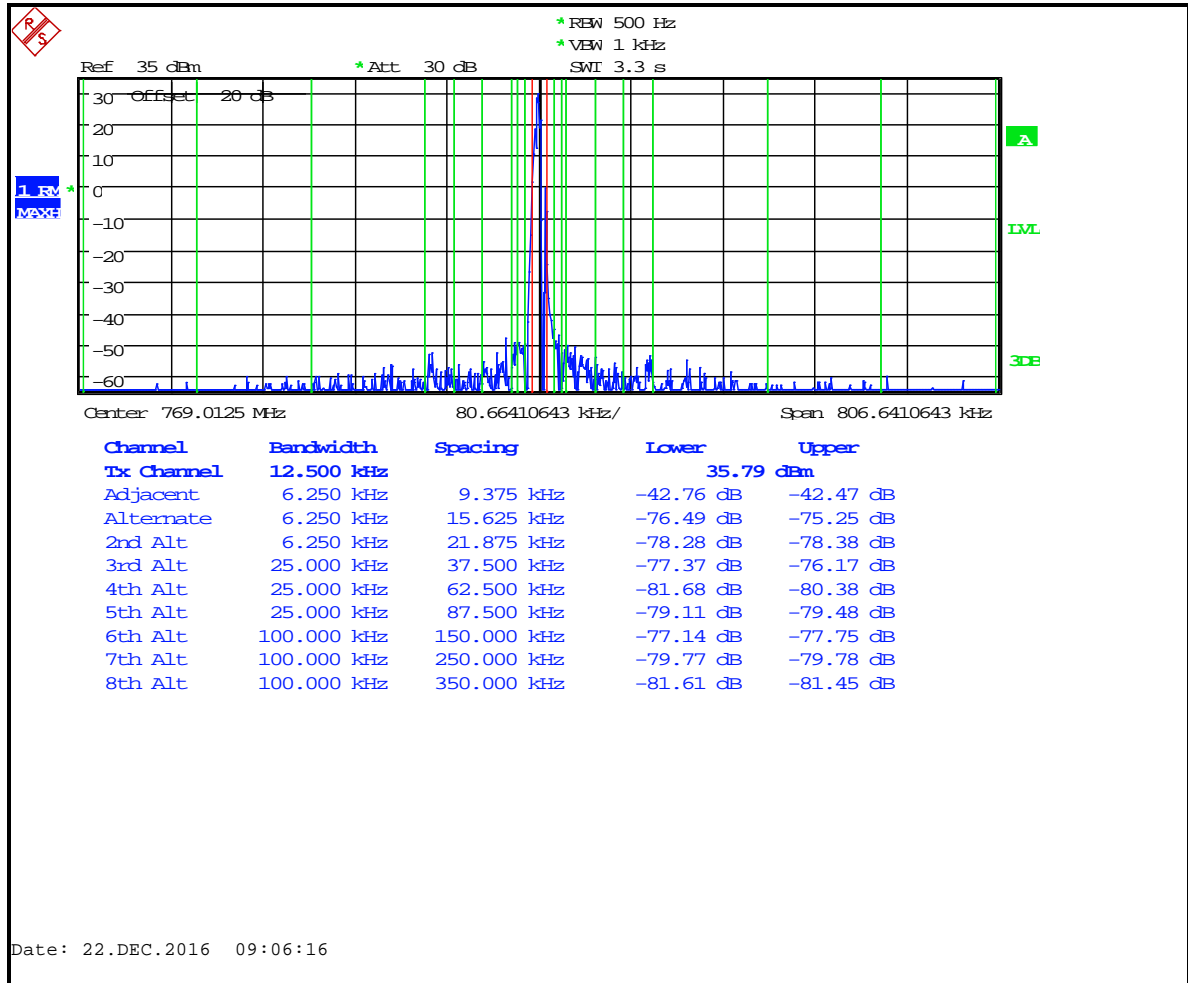

Table 6-26: Adjacent Channel Power - 769.0125 MHz; H-CPM (TDMA) Mode (>400 kHz - RX Band)

Offset from Center Frequency (kHz)	Measurement BW (kHz)	Max ACP (dBc)	Measured ACP (dBc)
>400 to 12 MHz	30(s)	-75	-85.6
12 MHz to receive band	30(s)	-75	-93.4
In receive band	30(s)	-100	-105.4

Plot 6-27: Adjacent Channel Power - 772.0125 MHz; H-CPM (TDMA) Mode (9.375 kHz - 350 kHz)

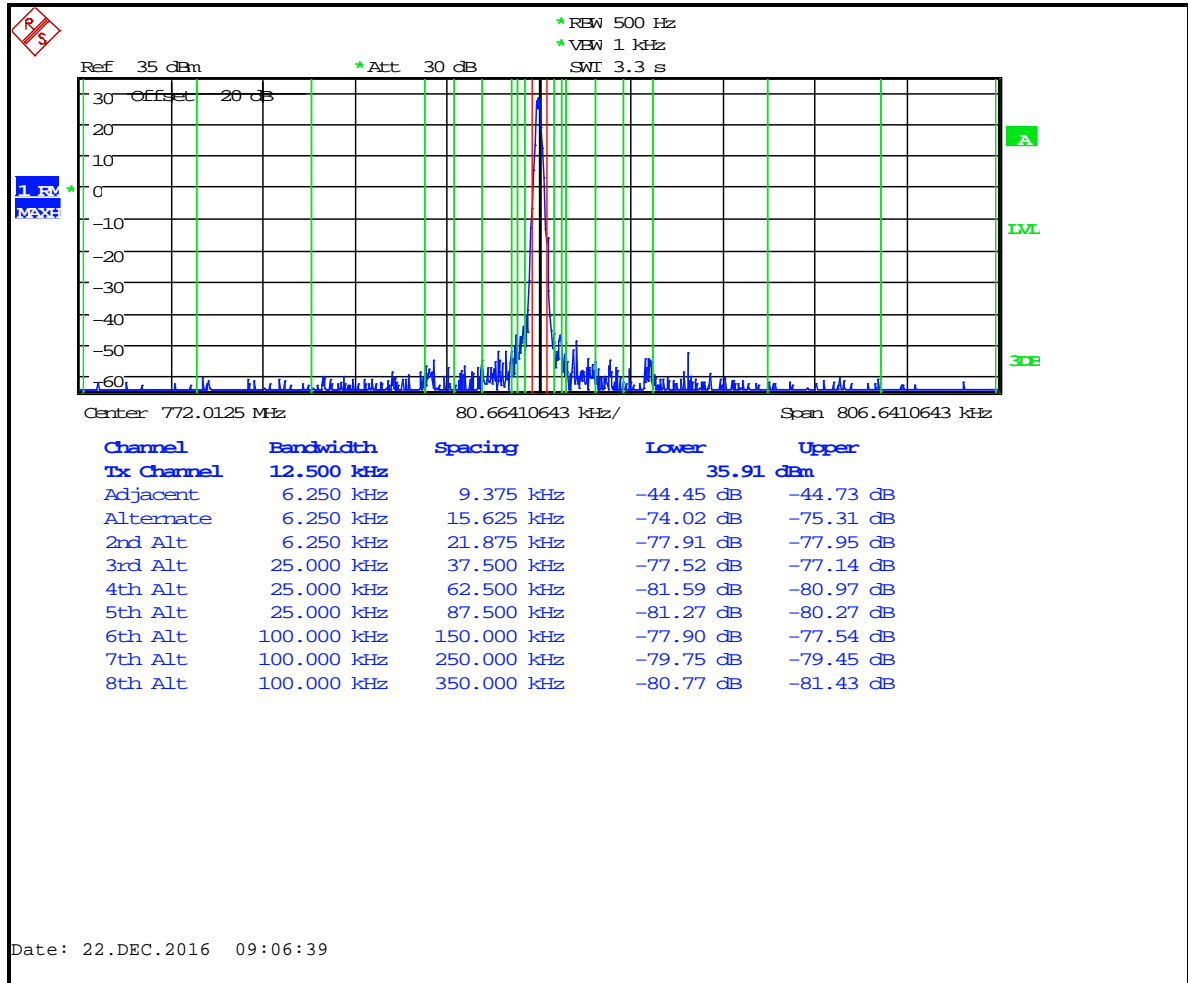

Table 6-27: Adjacent Channel Power - 772.0125 MHz; H-CPM (TDMA) Mode (>400 kHz - RX Band)

Offset from Center Frequency (kHz)	Measurement BW (kHz)	Max ACP (dBc)	Measured ACP (dBc)
>400 to 12 MHz	30(s)	-75	-80.5
12 MHz to receive band	30(s)	-75	-85.5
In receive band	30(s)	-100	-105.4

Plot 6-28: Adjacent Channel Power - 775.9875 MHz; H-CPM (TDMA) Mode (9.375 kHz - 350 kHz)

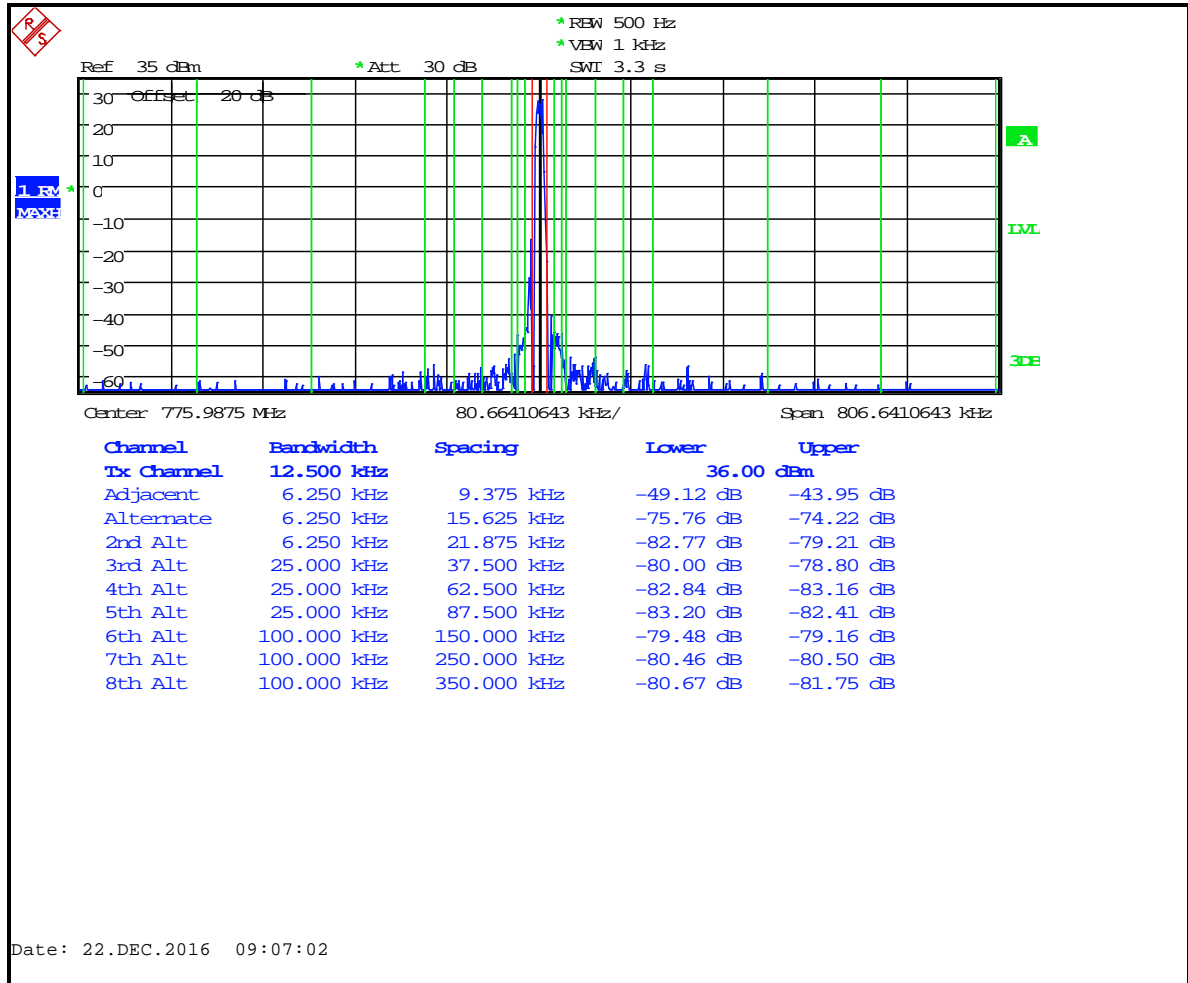

Table 6-28: Adjacent Channel Power - 775.9875 MHz; H-CPM (TDMA) Mode (>400 kHz - RX Band)

Offset from Center Frequency (kHz)	Measurement BW (kHz)	Max ACP (dBc)	Measured ACP (dBc)
>400 to 12 MHz	30(s)	-75	-84.5
12 MHz to receive band	30(s)	-75	-85.6
In receive band	30(s)	-100	-105.3

Plot 6-29: Adjacent Channel Power – 798.0125 MHz; H-CPM (TDMA) Mode; (9.375 kHz - 350 kHz)

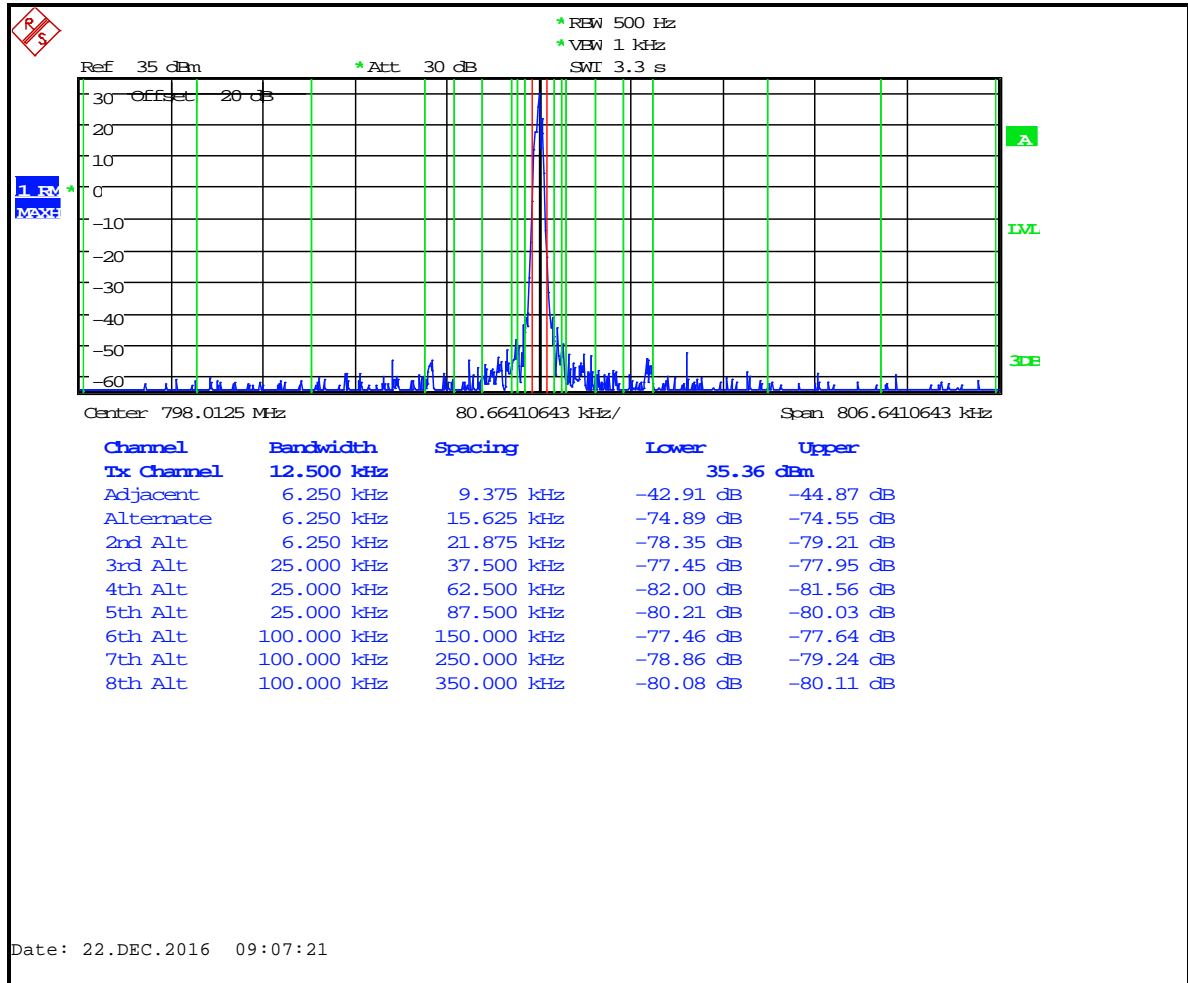

Table 6-29: Adjacent Channel Power – 798.0125 MHz; H-CPM (TDMA) Mode (>400 kHz - RX Band)

Offset from Center Frequency (kHz)	Measurement BW (kHz)	Max ACP (dBc)	Measured ACP (dBc)
>400 to 12 MHz	30(s)	-75	-79.3
12 MHz to receive band	30(s)	-75	-86.4
In receive band	30(s)	-100	-102.9

Plot 6-30: Adjacent Channel Power – 799.0125 MHz; H-CPM (TDMA) Mode; (9.375 kHz - 350 kHz)

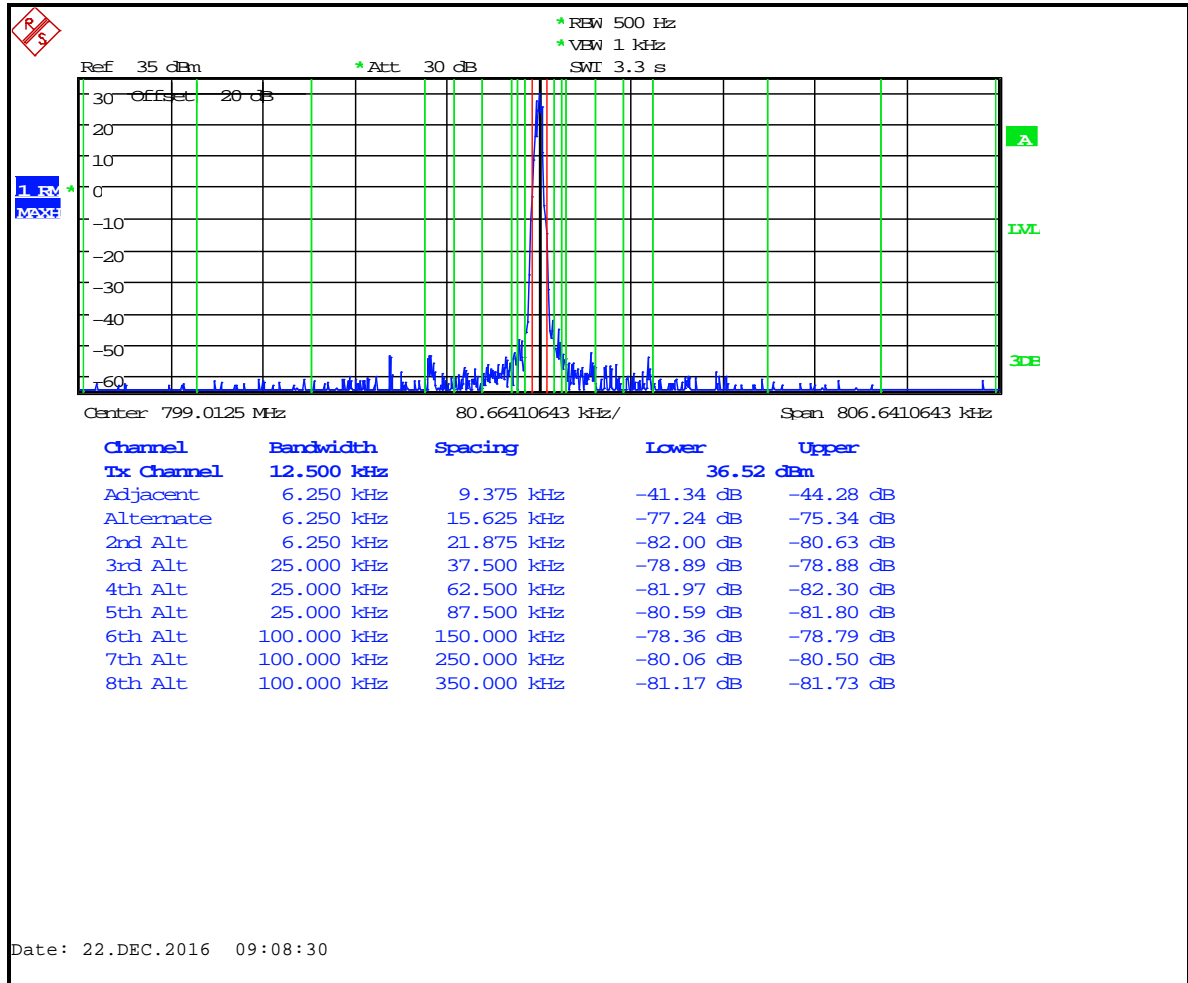

Table 6-30: Adjacent Channel Power – 799.0125 MHz; H-CPM (TDMA) Mode (>400 kHz - RX Band)

Offset from Center Frequency (kHz)	Measurement BW (kHz)	Max ACP (dBc)	Measured ACP (dBc)
>400 to 12 MHz	30(s)	-75	-79.2
12 MHz to receive band	30(s)	-75	-86.5
In receive band	30(s)	-100	-103.8

Plot 6-31: Adjacent Channel Power – 801.0125 MHz; H-CPM (TDMA) Mode; (9.375 kHz - 350 kHz)

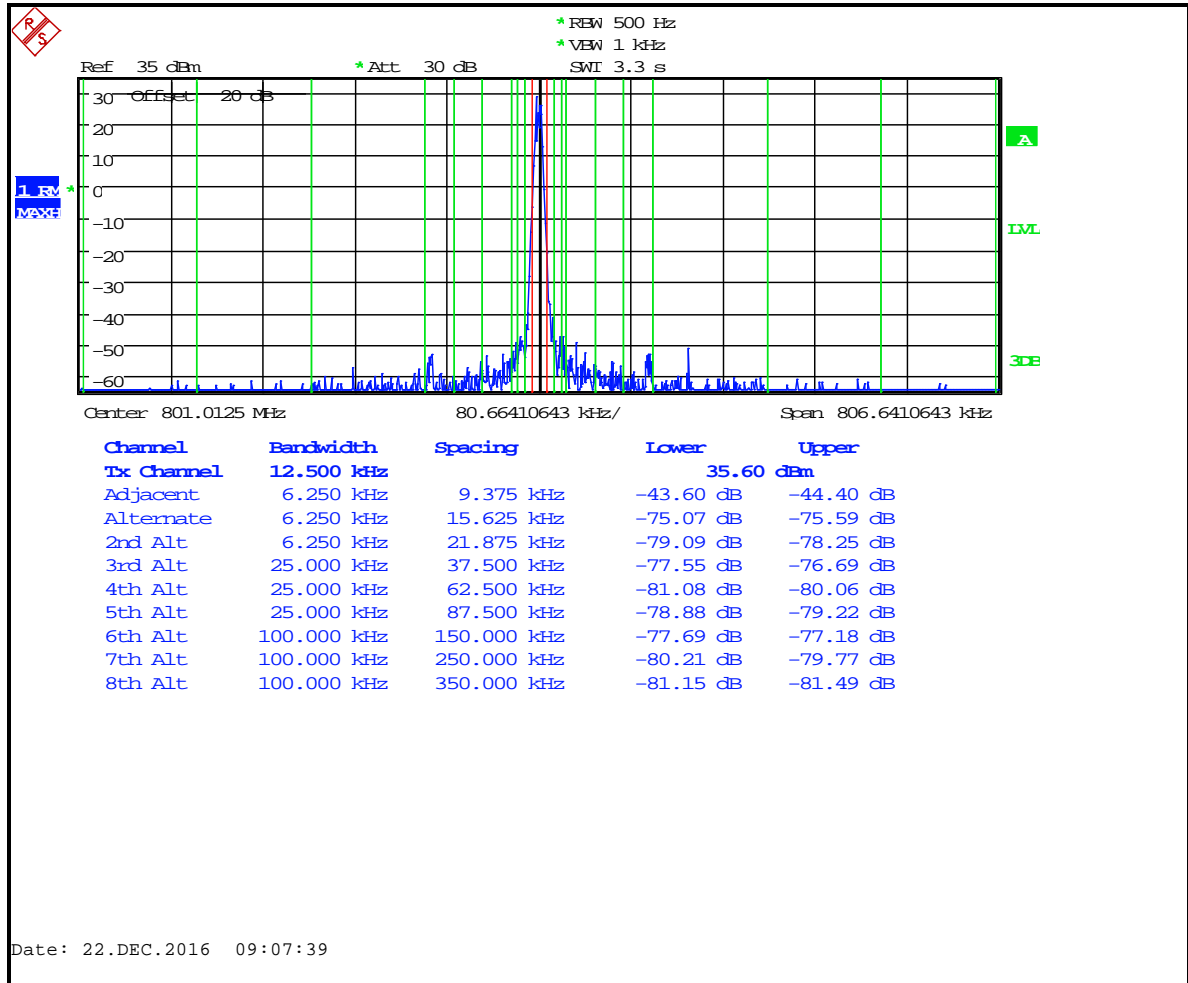
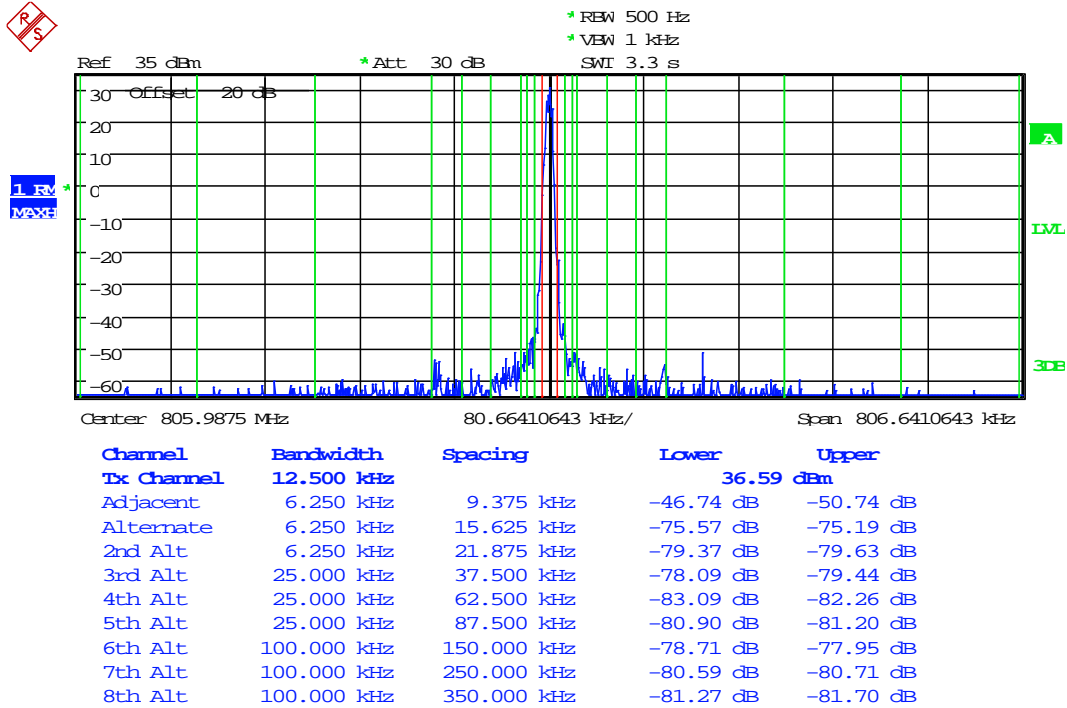

Table 6-31: Adjacent Channel Power – 801.0125 MHz; H-CPM (TDMA) Mode (>400 kHz - RX Band)

Offset from Center Frequency (kHz)	Measurement BW (kHz)	Max ACP (dBc)	Measured ACP (dBc)
>400 to 12 MHz	30(s)	-75	-80.8
12 MHz to receive band	30(s)	-75	-86.2
In receive band	30(s)	-100	-103.8

Plot 6-32: Adjacent Channel Power – 805.9875 MHz; H-CPM (TDMA) Mode; (9.375 kHz - 350 kHz)



Date: 22.DEC.2016 09:07:57

Table 6-32: Adjacent Channel Power – 805.9875 MHz; H-CPM (TDMA) Mode (>400 kHz - RX Band)

Offset from Center Frequency (kHz)	Measurement BW (kHz)	Max ACP (dBc)	Measured ACP (dBc)
>400 to 12 MHz	30(s)	-75	-80.3
12 MHz to receive band	30(s)	-75	-84.3
In receive band	30(s)	-100	-105.2

Rhein Tech Laboratories, Inc.
360 Herndon Parkway
Suite 1400
Herndon, VA20170
<http://www.rheintech.com>

Client: Harris Corporation
Model: XL-185P 7/8/900 MHz
ID's: OWDTR-0143-E/3636B-0143
Standards: FCC Part 24, 90, 101/IC RSS-119
Report #: 2016219TNF

Table 6-33: Test Equipment Used For Testing ACP Requirements

RTL Asset #	Manufacturer	Model	Part Type	Serial Number	Calibration Due Date
901581	Rohde & Schwarz	FSU	Spectrum Analyzer	1166.1660.50	3/22/18
901139	Weinschel Corporation	48-20-34	Attenuator DC-18 GHz 20 dB 100W	BK5859	3/30/18

Test Personnel:

Daniel Baltzell
EMC Test Engineer

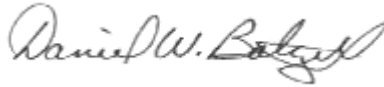

Signature

December 18-19, 2016
Dates of Tests

7 FCC Part 90.210(g) and Part 2.1053(a): Field Strength of Spurious Radiation; Part 90.543(f): Out of Band Emissions Limit; IC RSS-119 5.8.9.2 Out-of-band Emission Limit

7.1 Test Procedure

ANSI/TIA-603-D 2010, section 2.2.12

The device uses digital modulation modulated to its maximum extent using a pseudo-random data sequence.

The spurious emissions levels were measured, and the device under test was replaced by a substitution antenna connected to a signal generator. This signal generator level was then corrected by subtracting the cable loss from the substitution antenna to the signal generator, and the gain of the antenna (dBi) was added to achieve the EIRP level, then converted from the corrected signal generator level (dBm) to dBc, or dBW for 700 MHz band, and compared to the limit.

For emissions in the 1559-1610 band, Part 90.543(f) states: "For operations in the 763–775 MHz and 793–805 MHz bands, all emissions including harmonics in the band 1559–1610 MHz shall be limited to -70 dBW/MHz equivalent isotropically radiated power (EIRP) for wideband signals, and -80 dBW EIRP for discrete emissions of less than 700 Hz bandwidth. For the purpose of equipment authorization, a transmitter shall be tested with an antenna that is representative of the type that will be used with the equipment in normal operation."

7.2 Test Data

Table 7-1: Field Strength of Spurious Radiation – 768.0125 MHz

Conducted Power 34.3 dBm; 2.7 W; Limit=50+10LogP=54.3 dBc

Frequency (MHz)	Spectrum Analyzer Level (dBuV)	Signal Generator Level (dBm)	Cable Loss to Transmit Antenna (dB)	Substitution Antenna Gain (dBi)	Corrected Signal Generator Level (dBc)	Margin (dB)
1536.0250	20.2	-52.6	0.4	8.7	78.6	-24.3
2304.0375	5.0	-73.7	0.5	9.5	99.0	-44.7
3072.0500	10.0	-66.8	0.7	9.3	92.5	-38.2
3840.0625	-1.8	-75.5	0.8	9.1	101.5	-47.2
4608.0750	40.8	-65.7	0.9	11.0	89.9	-35.6
5376.0875	37.8	-68.5	1.0	10.7	93.1	-38.8
6144.1000	22.1	-48.6	1.2	11.3	72.7	-18.4
6912.1125	10.1	-59.8	1.3	11.6	83.8	-29.5
7680.1250	34.1	-69.4	1.4	11.4	93.7	-39.4

Table 7-2: Field Strength of Spurious Radiation – 769.0125 MHz

Conducted Power 34.3 dBm; 2.7 W; Limit=50+10LogP=54.3 dBc

Frequency (MHz)	Spectrum Analyzer Level (dBuV)	Signal Generator Level (dBm)	Cable Loss to Transmit Antenna (dB)	Substitution Antenna Gain (dBi)	Corrected Signal Generator Level (dBc)	Margin (dB)
1538.0250	19.5	-53.5	0.4	8.7	79.5	-25.2
2307.0375	7.4	-71.3	0.5	9.5	96.6	-42.3
3076.0500	11.1	-65.7	0.7	9.3	91.4	-37.1
3845.0625	-1.9	-75.6	0.8	9.1	101.6	-47.3
4614.0750	-2.4	-73.8	0.9	11.0	98.0	-43.7
5383.0875	-1.9	-73.3	1.0	10.7	97.9	-43.6
6152.1000	22.7	-48.0	1.2	11.3	72.2	-17.9
6921.1125	40.9	-63.9	1.3	11.6	87.9	-33.6
7690.1250	28.6	-74.9	1.4	11.4	99.2	-44.9

Table 7-3: Field Strength of Spurious Radiation – 772.0125 MHz

Conducted Power 34.3 dBm; 2.7 W; Limit=50+10LogP=54.3 dBc

Frequency (MHz)	Spectrum Analyzer Level (dBuV)	Signal Generator Level (dBm)	Cable Loss to Transmit Antenna (dB)	Substitution Antenna Gain (dBi)	Corrected Signal Generator Level (dBc)	Margin (dB)
1544.0250	17.5	-55.4	0.4	8.7	81.4	-27.1
2316.0375	19.1	-59.6	0.5	9.5	85.0	-30.7
3088.0500	17.3	-59.5	0.7	9.3	85.2	-30.9
3860.0625	-2.5	-76.2	0.8	9.1	102.2	-47.9
4632.0750	10.9	-60.5	0.9	11.0	84.6	-30.3
5404.0875	9.9	-61.5	1.0	10.6	86.2	-31.9
6176.1000	20.3	-50.4	1.2	11.3	74.6	-20.3
6948.1125	10.8	-59.1	1.3	11.6	83.0	-28.7
7720.1250	11.7	-57.1	1.4	11.4	81.4	-27.1

Table 7-4: Field Strength of Spurious Radiation – 775.9875 MHz

Conducted Power 34.3 dBm; 2.7 W; Limit=50+10LogP=54.3 dBc

Frequency (MHz)	Spectrum Analyzer Level (dBuV)	Signal Generator Level (dBm)	Cable Loss to Transmit Antenna (dB)	Substitution Antenna Gain (dBi)	Corrected Signal Generator Level (dBc)	Margin (dB)
1551.9750	20.5	-52.4	0.4	8.7	78.4	-24.1
2327.9625	13.0	-65.6	0.5	9.5	91.0	-36.7
3103.9500	17.4	-59.4	0.7	9.2	85.2	-30.9
3879.9375	-0.4	-74.0	0.8	9.1	100.0	-45.7
4655.9250	0.5	-70.9	0.9	11.1	95.1	-40.8
5431.9125	48.9	-57.4	1.1	10.7	82.1	-27.8
6207.9000	20.4	-50.2	1.2	11.2	74.4	-20.1
6983.8875	6.8	-63.0	1.3	11.7	86.9	-32.6
7759.8750	2.1	-66.7	1.4	11.4	91.0	-36.7

Table 7-5: Field Strength of Spurious Radiation – 798.0125 MHz

Conducted Power 34.3 dBm; 2.7 W; Limit=50+10LogP=54.3 dBc

Frequency (MHz)	Spectrum Analyzer Level (dBuV)	Signal Generator Level (dBm)	Cable Loss to Transmit Antenna (dB)	Substitution Antenna Gain (dBi)	Corrected Signal Generator Level (dBc)	Margin (dB)
1596.0250	23.3	-51.9	0.4	7.8	78.8	-24.5
2394.0375	8.2	-68.3	0.5	9.4	93.7	-39.4
3192.0500	15.0	-61.5	0.7	9.2	87.3	-33.0
3990.0625	-5.6	-79.0	0.8	9.6	104.5	-50.2
4788.0750	38.7	-67.8	0.9	11.0	92.0	-37.7
5586.0875	54.0	-52.2	1.1	10.8	76.7	-22.4
6384.1000	35.3	-70.0	1.2	11.7	93.8	-39.5
7182.1125	42.2	-62.1	1.3	11.4	86.4	-32.1
7980.1250	-3.5	-72.1	1.4	11.4	96.5	-42.2

Table 7-6: Field Strength of Spurious Radiation – 799.0125 MHz

Conducted Power 34.4 dBm; 2.8 W; Limit=50+10LogP=54.4 dBc

Frequency (MHz)	Spectrum Analyzer Level (dBuV)	Signal Generator Level (dBm)	Cable Loss to Transmit Antenna (dB)	Substitution Antenna Gain (dBi)	Corrected Signal Generator Level (dBc)	Margin (dB)
1598.0250	18.8	-54.1	0.4	7.8	81.1	-26.7
2397.0375	10.7	-67.8	0.5	9.4	93.3	-38.9
3196.0500	15.0	-61.5	0.7	9.2	87.4	-33.0
3995.0625	-5.2	-78.6	0.8	9.6	104.2	-49.8
4794.0750	17.6	-54.2	1.0	11.0	78.5	-24.1
5593.0875	10.7	-60.5	1.1	10.9	85.1	-30.7
6392.1000	13.2	-57.3	1.2	11.7	81.2	-26.8
7191.1125	10.2	-59.4	1.3	11.3	83.8	-29.4
7990.1250	12.5	-57.0	1.4	11.4	81.5	-27.1

Table 7-7: Field Strength of Spurious Radiation – 801.0125 MHz

Conducted Power 34.3 dBm; 2.7 W; Limit=50+10LogP=54.3 dBc

Frequency (MHz)	Spectrum Analyzer Level (dBuV)	Signal Generator Level (dBm)	Cable Loss to Transmit Antenna (dB)	Substitution Antenna Gain (dBi)	Corrected Signal Generator Level (dBc)	Margin (dB)
1602.0250	20.7	-52.2	0.4	8.9	78.0	-23.7
2403.0375	18.7	-57.8	0.5	9.4	83.2	-28.9
3204.0500	12.5	-64.0	0.7	9.2	89.8	-35.5
4005.0625	30.2	-40.7	0.8	9.7	66.1	-11.8
4806.0750	36.7	-70.1	1.0	11.0	94.4	-40.1
5607.0875	55.2	-50.8	1.1	10.9	75.3	-21.0
6408.1000	10.1	-60.3	1.2	11.7	84.1	-29.8
7209.1125	8.4	-61.2	1.3	11.3	85.6	-31.3
8010.1250	-4.1	-72.3	1.4	11.3	96.7	-42.4

Table 7-8: Field Strength of Spurious Radiation – 805.9875 MHz

Conducted Power 34.3 dBm; 2.7 W; Limit=50+10LogP=54.3 dBc

Frequency (MHz)	Spectrum Analyzer Level (dBuV)	Signal Generator Level (dBm)	Cable Loss to Transmit Antenna (dB)	Substitution Antenna Gain (dBi)	Corrected Signal Generator Level (dBc)	Margin (dB)
1611.9750	19.4	-53.6	0.4	8.9	79.4	-25.1
2417.9625	15.5	-61.0	0.6	9.5	86.4	-32.1
3223.9500	11.6	-64.9	0.7	9.2	90.7	-36.4
4029.9375	31.6	-39.3	0.8	9.8	64.6	-10.3
4835.9250	2.8	-68.8	1.0	11.0	93.1	-38.8
5641.9125	54.4	-51.6	1.1	11.0	76.1	-21.8
6447.9000	7.4	-63.0	1.2	11.8	86.7	-32.4
7253.8875	45.6	-58.8	1.3	11.1	83.4	-29.1
8059.8750	-4.0	-70.1	1.5	11.3	94.5	-40.2

Table 7-9: Field Strength of Spurious Radiation – 806.0125 MHz

Conducted Power 35.0 dBm; 3.2 W; Limit=50+10LogP=55.0 dBc

Frequency (MHz)	Spectrum Analyzer Level (dBuV)	Signal Generator Level (dBm)	Cable Loss to Transmit Antenna (dB)	Substitution Antenna Gain (dBi)	Corrected Signal Generator Level (dBc)	Margin (dB)
1612.0250	26.3	-46.5	0.4	8.9	73.0	-18.0
2418.0375	21.1	-55.4	0.6	9.5	81.5	-26.5
3224.0500	16.7	-59.8	0.7	9.2	86.3	-31.3
4030.0625	33.7	-37.2	0.8	9.8	63.2	-8.2
4836.0750	4.1	-67.5	1.0	11.0	92.5	-37.5
5642.0875	63.7	-42.3	1.1	11.0	67.5	-12.5
6448.1000	45.8	-59.4	1.2	11.8	83.8	-28.8
7254.1125	55.0	-49.2	1.3	11.1	74.5	-19.5
8060.1250	-3.1	-69.2	1.5	11.3	94.3	-39.3

Table 7-10: Field Strength of Spurious Radiation – 811.0125 MHz

Conducted Power 35.1 dBm; 3.2 W; Limit=50+10LogP=55.1 dBc

Frequency (MHz)	Spectrum Analyzer Level (dBuV)	Signal Generator Level (dBm)	Cable Loss to Transmit Antenna (dB)	Substitution Antenna Gain (dBi)	Corrected Signal Generator Level (dBc)	Margin (dB)
1622.0250	25.4	-47.2	0.4	8.8	73.9	-18.8
2433.0375	12.7	-63.7	0.6	9.5	89.9	-34.8
3244.0500	16.1	-60.3	0.7	9.2	86.9	-31.8
4055.0625	33.2	-37.7	0.8	9.9	63.7	-8.6
4866.0750	10.9	-60.8	1.0	11.0	85.8	-30.7
5677.0875	18.9	-52.3	1.1	11.1	77.4	-22.3
6488.1000	15.2	-55.2	1.2	11.9	79.6	-24.5
7299.1125	52.8	-51.4	1.3	10.9	77.0	-21.9
8110.1250	-6.8	-70.8	1.5	11.4	96.0	-40.9

Table 7-11: Field Strength of Spurious Radiation – 815.9875 MHz

Conducted Power 35.2 dBm; 3.3 W; Limit=50+10LogP=55.2 dBc

Frequency (MHz)	Spectrum Analyzer Level (dBuV)	Signal Generator Level (dBm)	Cable Loss to Transmit Antenna (dB)	Substitution Antenna Gain (dBi)	Corrected Signal Generator Level (dBc)	Margin (dB)
1631.9750	32.3	-40.3	0.4	8.8	67.1	-11.9
2447.9625	18.0	-58.4	0.6	9.5	84.7	-29.5
3263.9500	16.3	-60.1	0.7	9.2	86.8	-31.6
4079.9375	33.9	-37.1	0.8	10.1	63.1	-7.9
4895.9250	10.0	-61.7	1.0	11.0	86.9	-31.7
5711.9125	20.2	-50.9	1.1	11.2	76.0	-20.8
6527.9000	12.4	-57.9	1.2	11.9	82.5	-27.3
7343.8875	13.5	-55.8	1.3	10.8	81.5	-26.3
8159.8750	-5.4	-67.4	1.5	11.4	92.7	-37.5

Table 7-12: Field Strength of Spurious Radiation – 851.0125 MHz

Conducted Power 35.0 dBm; 3.2 W; Limit=50+10LogP=55.0 dBc

Frequency (MHz)	Spectrum Analyzer Level (dBuV)	Signal Generator Level (dBm)	Cable Loss to Transmit Antenna (dB)	Substitution Antenna Gain (dBi)	Corrected Signal Generator Level (dBc)	Margin (dB)
1702.0250	29.1	-43.4	0.4	8.5	70.3	-15.3
2553.0375	12.3	-63.9	0.6	9.5	89.9	-34.9
3404.0500	15.8	-60.2	0.7	9.7	86.2	-31.2
4255.0625	30.2	-40.9	0.9	10.8	66.0	-11.0
5106.0750	11.6	-60.1	1.0	10.9	85.2	-30.2
5957.0875	18.9	-52.0	1.1	11.8	76.4	-21.4
6808.1000	10.2	-59.8	1.3	11.6	84.5	-29.5
7659.1125	10.4	-58.4	1.4	11.3	83.4	-28.4
8510.1250	5.5	-55.6	1.5	11.6	80.6	-25.6

Table 7-13: Field Strength of Spurious Radiation – 856.0125 MHz

Conducted Power 35.1 dBm; 3.2 W; Limit=50+10LogP=55.1 dBc

Frequency (MHz)	Spectrum Analyzer Level (dBuV)	Signal Generator Level (dBm)	Cable Loss to Transmit Antenna (dB)	Substitution Antenna Gain (dBi)	Corrected Signal Generator Level (dBc)	Margin (dB)
1712.0250	28.4	-44.1	0.4	8.6	71.1	-16.0
2568.0375	15.1	-63.0	0.6	9.6	89.1	-34.0
3424.0500	19.0	-56.9	0.7	9.7	83.0	-27.9
4280.0625	24.6	-46.5	0.9	10.8	71.6	-16.5
5136.0750	19.2	-52.5	1.0	10.8	77.8	-22.7
5992.0875	19.9	-51.0	1.1	11.7	75.6	-20.5
6848.1000	11.0	-59.0	1.3	11.6	83.8	-28.7
7704.1125	-0.8	-70.1	1.4	11.4	95.2	-40.1
8560.1250	2.5	-58.7	1.5	11.6	83.7	-28.6

Table 7-14: Field Strength of Spurious Radiation – 860.9875 MHz

Conducted Power 35.0 dBm; 3.2 W; Limit=50+10LogP=55.0 dBc

Frequency (MHz)	Spectrum Analyzer Level (dBuV)	Signal Generator Level (dBm)	Cable Loss to Transmit Antenna (dB)	Substitution Antenna Gain (dBi)	Corrected Signal Generator Level (dBc)	Margin (dB)
1721.9750	32.6	-40.0	0.4	8.6	66.8	-11.8
2582.9625	18.9	-59.1	0.6	9.6	85.1	-30.1
3443.9500	18.6	-57.3	0.7	9.7	83.3	-28.3
4304.9375	18.9	-52.2	0.9	10.9	77.2	-22.2
5165.9250	10.8	-60.8	1.0	10.8	86.1	-31.1
6026.9125	21.1	-49.7	1.1	11.6	74.3	-19.3
6887.9000	10.6	-59.3	1.3	11.6	84.0	-29.0
7748.8875	9.8	-59.0	1.4	11.4	83.9	-28.9
8609.8750	3.6	-57.8	1.5	11.7	82.6	-27.6

Table 7-15: Field Strength of Spurious Radiation – 896.0125 MHz

Conducted Power 35.0 dBm; 3.2 W; Limit=50+10LogP=55.0 dBc

Frequency (MHz)	Spectrum Analyzer Level (dBuV)	Signal Generator Level (dBm)	Cable Loss to Transmit Antenna (dB)	Substitution Antenna Gain (dBi)	Corrected Signal Generator Level (dBc)	Margin (dB)
1792.0250	17.5	-54.3	0.4	8.8	80.9	-25.9
2688.0375	19.8	-58.0	0.6	9.8	83.8	-28.8
3584.0500	13.1	-62.4	0.8	9.7	88.4	-33.4
4480.0625	10.8	-60.5	0.9	11.0	85.4	-30.4
5376.0750	9.1	-62.3	1.0	10.7	87.7	-32.7
6272.0875	33.5	-37.1	1.2	11.3	62.0	-7.0
7168.1000	10.1	-59.5	1.3	11.4	84.4	-29.4
8064.1125	10.4	-55.5	1.5	11.3	80.6	-25.6
8960.1250	-1.0	-63.3	1.6	11.1	88.8	-33.8

Table 7-16: Field Strength of Spurious Radiation – 898.5000 MHz

Conducted Power 35.1 dBm; 3.2 W; Limit=50+10LogP=55.1 dBc

Frequency (MHz)	Spectrum Analyzer Level (dBuV)	Signal Generator Level (dBm)	Cable Loss to Transmit Antenna (dB)	Substitution Antenna Gain (dBi)	Corrected Signal Generator Level (dBc)	Margin (dB)
1797.0000	17.0	-55.2	0.4	8.8	81.9	-26.8
2695.5000	10.8	-67.0	0.6	9.8	92.9	-37.8
3594.0000	6.8	-67.4	0.8	9.7	93.5	-38.4
4492.5000	10.2	-61.1	0.9	11.0	86.2	-31.1
5391.0000	10.1	-61.3	1.0	10.7	86.8	-31.7
6289.5000	33.9	-36.7	1.2	11.4	61.6	-6.5
7188.0000	9.9	-59.7	1.3	11.3	84.8	-29.7
8086.5000	10.4	-54.6	1.5	11.3	79.8	-24.7
8985.0000	-2.1	-64.4	1.6	11.1	90.0	-34.9

Table 7-17: Field Strength of Spurious Radiation – 900.9875 MHz

Conducted Power 35.0 dBm; 3.2 W; Limit=50+10LogP=55.0 dBc

Frequency (MHz)	Spectrum Analyzer Level (dBuV)	Signal Generator Level (dBm)	Cable Loss to Transmit Antenna (dB)	Substitution Antenna Gain (dBi)	Corrected Signal Generator Level (dBc)	Margin (dB)
1801.9750	16.4	-55.5	0.4	8.8	82.1	-27.1
2702.9625	10.9	-66.9	0.6	9.8	92.7	-37.7
3603.9500	7.8	-66.4	0.8	9.7	92.4	-37.4
4504.9375	10.4	-60.9	0.9	11.0	85.8	-30.8
5405.9250	9.6	-61.8	1.0	10.6	87.2	-32.2
6306.9125	33.9	-36.6	1.2	11.4	61.4	-6.4
7207.9000	9.7	-59.9	1.3	11.3	84.9	-29.9
8108.8875	10.2	-53.9	1.5	11.4	79.0	-24.0
9009.8750	-1.7	-64.1	1.6	11.1	89.6	-34.6

Table 7-18: Field Strength of Spurious Radiation – 901.9750 MHz

Conducted Power 35.0 dBm; 3.2 W; Limit=50+10LogP=55.0 dBc

Frequency (MHz)	Spectrum Analyzer Level (dBuV)	Signal Generator Level (dBm)	Cable Loss to Transmit Antenna (dB)	Substitution Antenna Gain (dBi)	Corrected Signal Generator Level (dBc)	Margin (dB)
1803.950	33.2	-38.7	0.4	7.6	66.6	-11.6
2705.925	17.1	-60.7	0.6	9.7	86.6	-31.6
3607.900	11.7	-63.8	0.8	9.4	90.2	-35.2
4509.875	-1.6	-73.2	0.9	12.5	96.6	-41.6
5411.850	-3.2	-74.6	1.0	11.6	99.1	-44.1
6313.825	26.7	-44.2	1.2	13.9	66.5	-11.5
7215.800	3.7	-66.1	1.3	13.3	89.1	-34.1
8117.775	-3.5	-67.2	1.5	13.7	90.0	-35.0
9019.750	-7.9	-70.3	1.6	13.0	93.9	-38.9

Table 7-19: Field Strength of Spurious Radiation – 935.0125 MHz

Conducted Power 35.1 dBm; 3.2 W; Limit=50+10LogP=55.1 dBc

Frequency (MHz)	Spectrum Analyzer Level (dBuV)	Signal Generator Level (dBm)	Cable Loss to Transmit Antenna (dB)	Substitution Antenna Gain (dBi)	Corrected Signal Generator Level (dBc)	Margin (dB)
1870.0250	16.6	-55.3	0.5	8.5	82.3	-27.2
2805.0375	10.4	-67.1	0.6	10.1	92.8	-37.7
3740.0500	12.8	-61.1	0.8	9.2	87.7	-32.6
4675.0625	11.6	-59.8	0.9	11.1	84.7	-29.6
5610.0750	11.8	-59.8	1.1	10.9	85.1	-30.0
6545.0875	21.5	-48.8	1.2	11.8	73.3	-18.2
7480.1000	9.8	-59.2	1.4	11.0	84.6	-29.5
8415.1125	0.6	-60.3	1.5	11.5	85.4	-30.3
9350.1250	-5.3	-68.6	1.6	11.5	93.8	-38.7

Table 7-20: Field Strength of Spurious Radiation – 937.500 MHz

Conducted Power 35.1 dBm; 3.2 W; Limit=50+10LogP=55.1 dBc

Frequency (MHz)	Spectrum Analyzer Level (dBuV)	Signal Generator Level (dBm)	Cable Loss to Transmit Antenna (dB)	Substitution Antenna Gain (dBi)	Corrected Signal Generator Level (dBc)	Margin (dB)
1875.0000	15.7	-56.0	0.5	8.5	83.1	-28.0
2812.5000	14.4	-63.1	0.6	10.0	88.8	-33.7
3750.0000	12.6	-61.3	0.8	9.2	88.0	-32.9
4687.5000	5.7	-65.8	0.9	11.1	90.7	-35.6
5625.0000	17.2	-54.0	1.1	10.9	79.3	-24.2
6562.5000	20.8	-49.5	1.2	11.8	74.0	-18.9
7500.0000	11.4	-57.5	1.4	11.1	82.9	-27.8
8437.5000	0.8	-60.1	1.5	11.5	85.2	-30.1
9375.0000	-7.0	-70.3	1.7	11.5	95.5	-40.4

Table 7-21: Field Strength of Spurious Radiation – 939.9875 MHz

Conducted Power 35.0 dBm; 3.2 W; Limit=50+10LogP=55.0 dBc

Frequency (MHz)	Spectrum Analyzer Level (dBuV)	Signal Generator Level (dBm)	Cable Loss to Transmit Antenna (dB)	Substitution Antenna Gain (dBi)	Corrected Signal Generator Level (dBc)	Margin (dB)
1879.9750	15.4	-56.3	0.5	8.5	83.3	-28.3
2819.9625	14.2	-63.3	0.6	10.0	88.9	-33.9
3759.9500	13.6	-60.3	0.8	9.2	86.9	-31.9
4699.9375	5.5	-66.0	0.9	11.1	90.8	-35.8
5639.9250	13.8	-57.4	1.1	11.0	82.5	-27.5
6579.9125	21.5	-49.1	1.2	11.8	73.5	-18.5
7519.9000	7.9	-61.3	1.4	11.1	86.6	-31.6
8459.8875	1.9	-59.1	1.5	11.5	84.1	-29.1
9399.8750	-8.0	-71.4	1.7	11.5	96.5	-41.5

Table 7-22: Field Strength of Spurious Radiation – 940.9750 MHz

Conducted Power 35.0 dBm; 3.2 W; Limit=50+10LogP=55.0 dBc

Frequency (MHz)	Spectrum Analyzer Level (dBuV)	Signal Generator Level (dBm)	Cable Loss to Transmit Antenna (dB)	Substitution Antenna Gain (dBi)	Corrected Signal Generator Level (dBc)	Margin (dB)
1881.950	40.7	-33.1	0.4	7.6	61.0	-6.0
2822.925	17.4	-60.1	0.6	9.7	86.0	-31.0
3763.900	19.5	-54.4	0.8	9.4	80.8	-25.8
4704.875	6.9	-64.6	0.9	12.5	88.0	-33.0
5645.850	11.6	-59.6	1.0	11.6	84.1	-29.1
6586.825	19.0	-51.5	1.2	13.9	73.8	-18.8
7527.800	1.2	-67.7	1.3	13.3	90.7	-35.7
8468.775	0.2	-60.8	1.5	13.7	83.6	-28.6
9409.750	-8.3	-71.7	1.6	13.0	95.3	-40.3

Table 7-23: Field Strength of Spurious Radiation – 943.99375 MHz

Conducted Power 35.0 dBm; 3.2 W; Limit=50+10LogP=55.0 dBc

Frequency (MHz)	Spectrum Analyzer Level (dBuV)	Signal Generator Level (dBm)	Cable Loss to Transmit Antenna (dB)	Substitution Antenna Gain (dBi)	Corrected Signal Generator Level (dBc)	Margin (dB)
1887.988	44.3	-29.7	0.5	7.0	58.2	-3.2
2831.981	26.6	-49.1	0.6	10.0	74.7	-19.7
3775.975	21.2	-52.7	0.8	8.2	80.3	-25.3
4719.969	11.2	-60.3	0.9	12.8	83.4	-28.4
5663.963	16.1	-55.1	1.1	12.7	78.5	-23.5
6607.956	20.4	-49.8	1.2	15.1	71.0	-16.0
7551.950	4.6	-64.3	1.4	13.0	87.6	-32.6
8495.944	3.9	-57.2	1.5	14.3	79.5	-24.5
9439.938	-8.6	-72.1	1.7	14.3	94.4	-39.4

Table 7-24: Part 90.543(f): Out of Band Emissions Limit

Frequency (MHz)	Spectrum Analyzer Level (dBuV)	Signal Generator Level (dBm)	Cable Loss to Transmit Antenna (dB)	Substitution Antenna Gain (dBi)	Corrected Signal Generator Level (dBW)	Limit (dBW)	Margin (dB)
1596.025	23.3	-51.9	0.4	7.8	-74.5	-70.0	-4.5
1598.025	18.8	-54.1	0.4	7.8	-76.7	-70.0	-6.7
1609.975	19.5	-53.1	0.4	7.7	-75.8	-70.0	-5.8

Table 7-25: Test Equipment Used For Testing Field Strength of Spurious Radiation

RTL Asset #	Manufacturer	Model	Part Type	Serial Number	Calibration Due Date
900878	Rhein Tech Laboratories	AM3-1197-0005	3 meter antenna mast, polarizing	OATS1	N/A
901592	Insulated Wire Inc.	KPS-1503-3600-KPR	SMK RF Cables 20'	NA	8/3/17
901593	Insulated Wire Inc.	KPS-1503-360-KPR	SMK RF Cables 36"	NA	8/1/17
901594	Insulated Wire Inc.	KPS-1503-360-KPR	SMK RF Cables 36"	NA	8/1/17
901242	Rhein Tech Laboratories	WRT-000-0003	Wood rotating table	N/A	N/A
900791	Chase	CBL6111B	Bilog Antenna (30 MHz – 2000 MHz)	N/A	6/11/17
900321	EMCO	3161-03	Horn Antenna (4.0 - 8.2 GHz)	9508-1020	4/9/18
900323	EMCO	3160-07	Horn Antenna (8.2 - 12.4 GHz)	9605-1054	4/9/18
900772	EMCO	3161-02	Horn Antenna (2 - 4 GHz)	9804-1044	4/9/18
901582	Rohde & Schwarz	1167.0000.02	Signal Generator	101903	3/20/18
901581	Rohde & Schwarz	FSU	Spectrum Analyzer	1166.1660.50	3/22/18
901583	Agilent Technologies	N9010A	EXA Signal Analyzer (10 Hz - 26.5 GHz)	MY51250846	4/21/17
900932	Hewlett Packard	8449B OPT H02	Preamplifier (1 - 26.5 GHz)	3008A00505	9/16/17

Test Personnel:

Daniel Baltzell
 Test Engineer

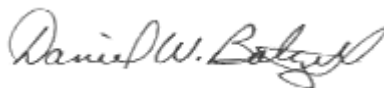

Signature

December 13-
 January 24, 2017
 Dates of Tests

8 FCC Part 2.1049(c)(1): Occupied Bandwidth; Part 24.131, Part 24.133(a)(1),(2): Authorized Bandwidth; Part 90.210 Authorized Bandwidth; Part 101.109, Part 101.111 Bandwidth; IC RSS-119 5.5 Channel Spacing, Authorized Bandwidth, Occupied Bandwidth and Spectrum Masks

Occupied Bandwidth - Compliance with the Emission Masks

8.1 Test Procedure

ANSI/TIA-603-D 2010, section 2.2.11

Device with digital modulation: Modulated to its maximum extent using a pseudo-random data sequence.

Part 24.131 Authorized bandwidth

The authorized bandwidth of narrowband PCS channels will be 10 kHz for 12.5 kHz channels and 45 kHz for 50 kHz channels. For aggregated adjacent channels, a maximum authorized bandwidth of 5 kHz less than the total aggregated channel width is permitted.

Part 24.133 Emission limits

(1) For transmitters authorized a bandwidth greater than 10 kHz:

(i) On any frequency outside the authorized bandwidth and removed from the edge of the authorized bandwidth by a displacement frequency (f_d in kHz) of up to and including 40 kHz: at least $116 \log_{10} ((f_d + 10)/6.1)$ decibels or $50 + 10 \log_{10} (P)$ decibels or 70 decibels, whichever is the lesser attenuation;

(ii) On any frequency outside the authorized bandwidth and removed from the edge of the authorized bandwidth by a displacement frequency (f_d in kHz) of more than 40 kHz: at least $43 + 10 \log_{10} (P)$ decibels or 80 decibels, whichever is the lesser attenuation.

(2) For transmitters authorized a bandwidth of 10 kHz:

(i) On any frequency outside the authorized bandwidth and removed from the edge of the authorized bandwidth by a displacement frequency (f_d in kHz) of up to and including 20 kHz: at least $116 \times \log_{10} ((f_d + 5)/3.05)$ decibels or $50 + 10 \times \log_{10} (P)$ decibels or 70 decibels, whichever is the lesser attenuation;

(ii) On any frequency outside the authorized bandwidth and removed from the edge of the authorized bandwidth by a displacement frequency (f_d in kHz) of more than 20 kHz: at least $43 + 10 \log_{10} (P)$ decibels or 80 decibels, whichever is the lesser attenuation.

(d) The following minimum spectrum analyzer resolution bandwidth settings will be used: 300 Hz when showing compliance with paragraphs (a)(1)(i) and (a)(2)(i) of this section; and 30 kHz when showing compliance with paragraphs (a)(1)(ii) and (a)(2)(ii) of this section.

Part 90.210 Authorized Bandwidth

Applicable Emission Masks		
Frequency Band (MHz)	Mask for Equipment With Audio Low Pass Filter	Mask for Equipment Without Audio Low Pass Filter
Below 25 ¹	A or B.....	A or C
25–50.....	B.....	C
72–76.....	B.....	C
150–174 ²	B, D, or E.....	C, D, or E
150 Paging-only	B.....	C
220–222	F.....	F
421–512 ²	B, D, or E.....	C, D, or E
450 Paging-only	B.....	G
806–809/851–854	B.....	H
809–824/854–869 ^{3 5}	B.....	G
896–901/935–940	I.....	J
902–928	K.....	K
929–930	B.....	G
4940–4990 MHz	L or M.....	L or M
5850–5925 ⁴		
All other bands	B.....	C

¹ Equipment using single sideband J3E emission must meet the requirements of Emission Mask A. Equipment using other emissions must meet the requirements of Emission Mask B or C, as applicable.
² Equipment designed to operate with a 25 kHz channel bandwidth must meet the requirements of Emission Mask B or C, as applicable. Equipment designed to operate with a 12.5 kHz channel bandwidth must meet the requirements of Emission Mask D, and equipment designed to operate with a 6.25 kHz channel bandwidth must meet the requirements of Emission Mask E.
³ Equipment used in this licensed to EA or non-EA systems shall comply with the emission mask provisions of §90.691.
⁴ DSRCS Roadside Unit equipment in the 5850–5925 MHz band is governed under subpart M of this part.
⁵ Equipment may alternatively meet the Adjacent Channel Power limits of §90.221.

Part 101.109, 101.111 Bandwidth

(1) When using transmissions other than those employing digital modulation techniques: (i) On any frequency removed from the assigned frequency by more than 50 percent up to and including 100 percent of the authorized bandwidth: At least 25 decibels; (ii) On any frequency removed from the assigned frequency by more than 100 percent up to and including 250 percent of the authorized bandwidth: At least 35 decibels; (iii) On any frequency removed from the assigned frequency by more than 250 percent of the authorized bandwidth: At least 43 + 10 Log₁₀ (mean output power in watts) decibels, or 80 decibels, whichever is the lesser attenuation.

(2) When using transmissions employing digital modulation techniques (see §101.141(b)) in situations not covered in this section: (i) For operating frequencies below 15 GHz, in any 4 KHz band, the center frequency of which is removed from the assigned frequency by more than 50 percent up to and including 250 percent of the authorized bandwidth: As specified by the following equation but in no event less than 50 decibels: $A = 35 + 0.8(P - 50) + 10 \text{ Log}_{10} B$. (Attenuation greater than 80 decibels or to an absolute power of less than -13 dBm/1MHz is not required.) where: A = Attenuation (in decibels) below the mean output power level. P = Percent removed from the center frequency of the transmitter bandwidth. B = Authorized bandwidth in MHz.

8.2 Test Data

Plot 8-1: Occupied Bandwidth – 806.0125 MHz; NB Analog; Mask B

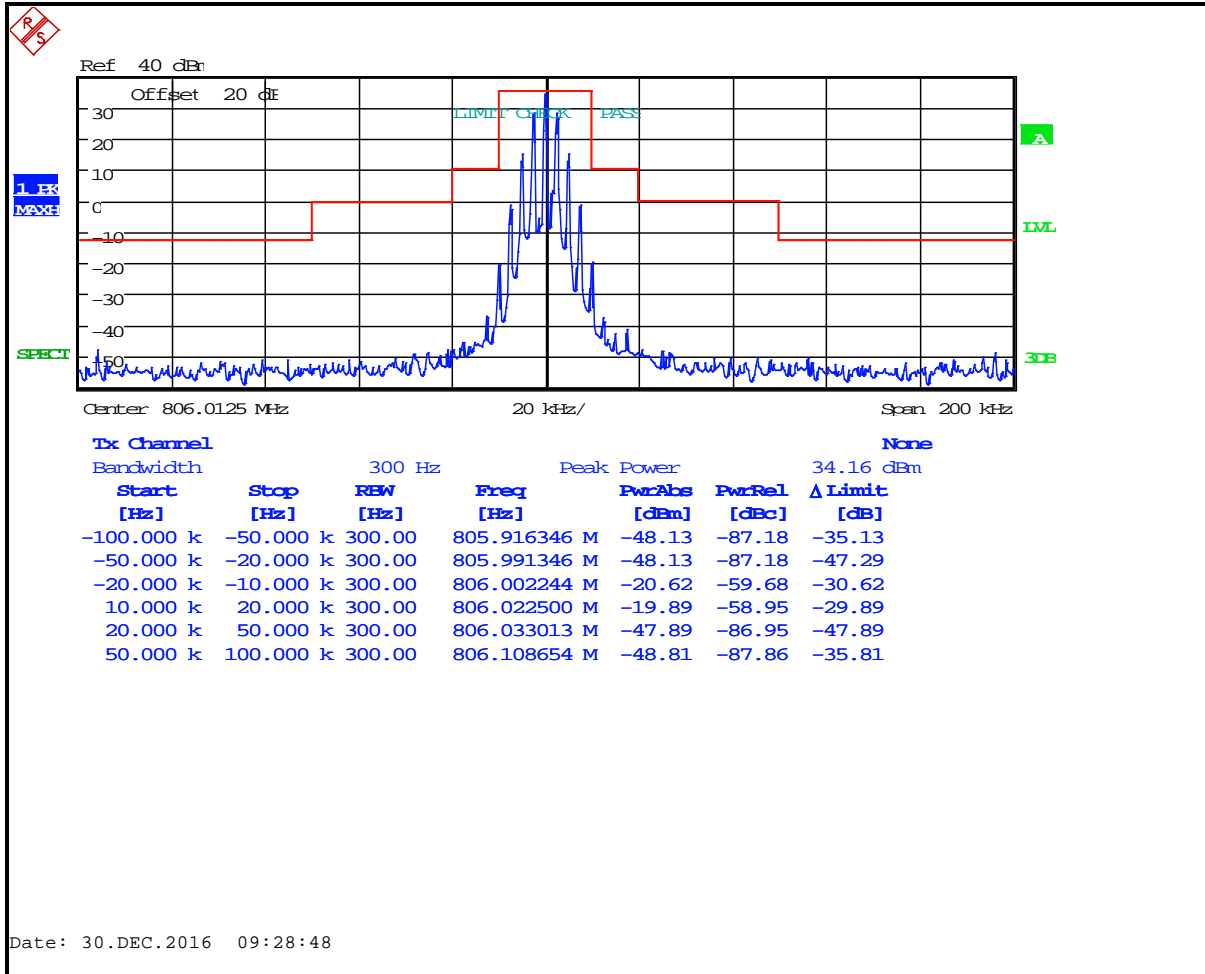

Plot 8-2: Occupied Bandwidth – 811.0125 MHz; NB Analog; Mask B

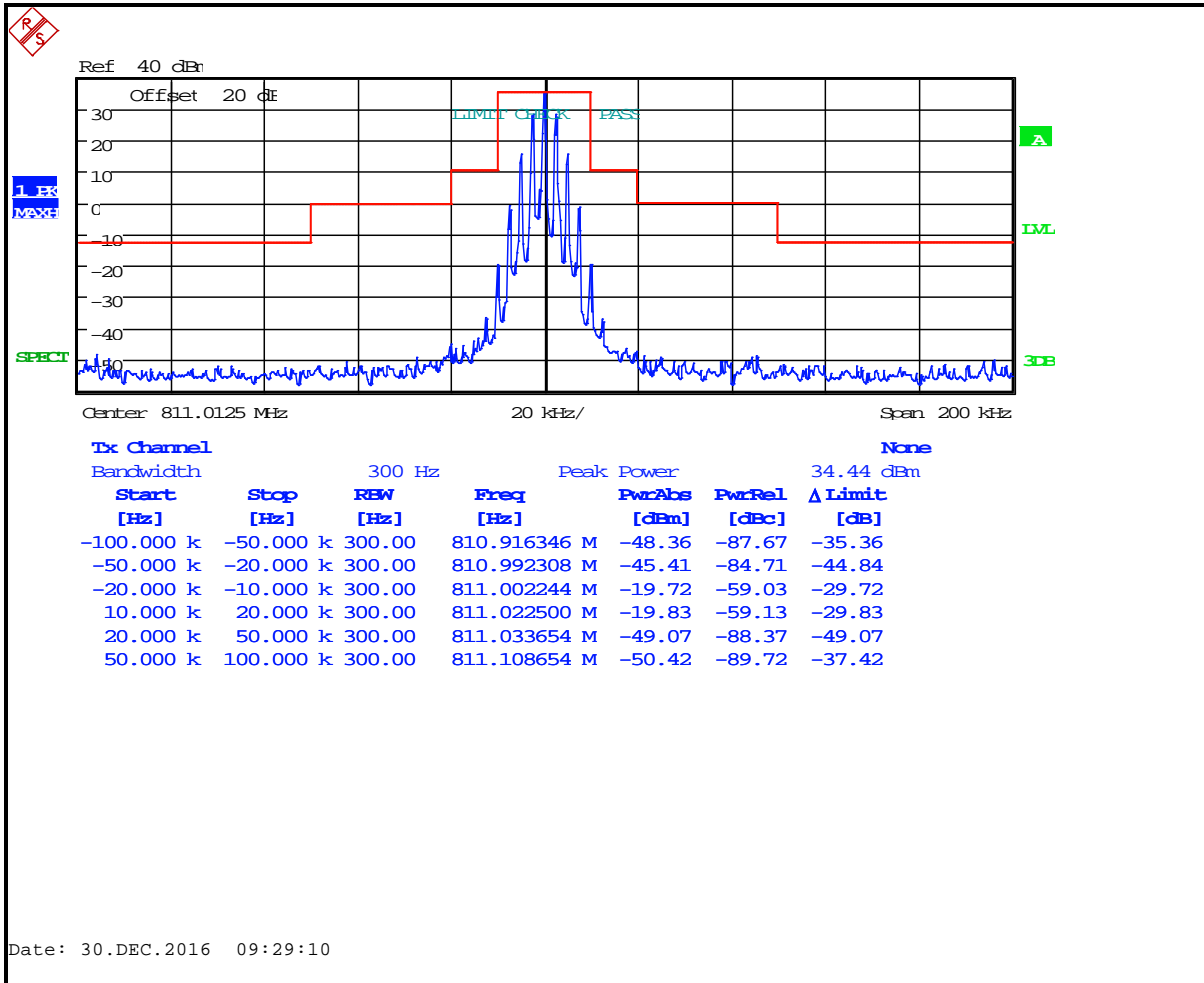

Plot 8-3: Occupied Bandwidth – 815.9875 MHz; NB Analog; Mask B

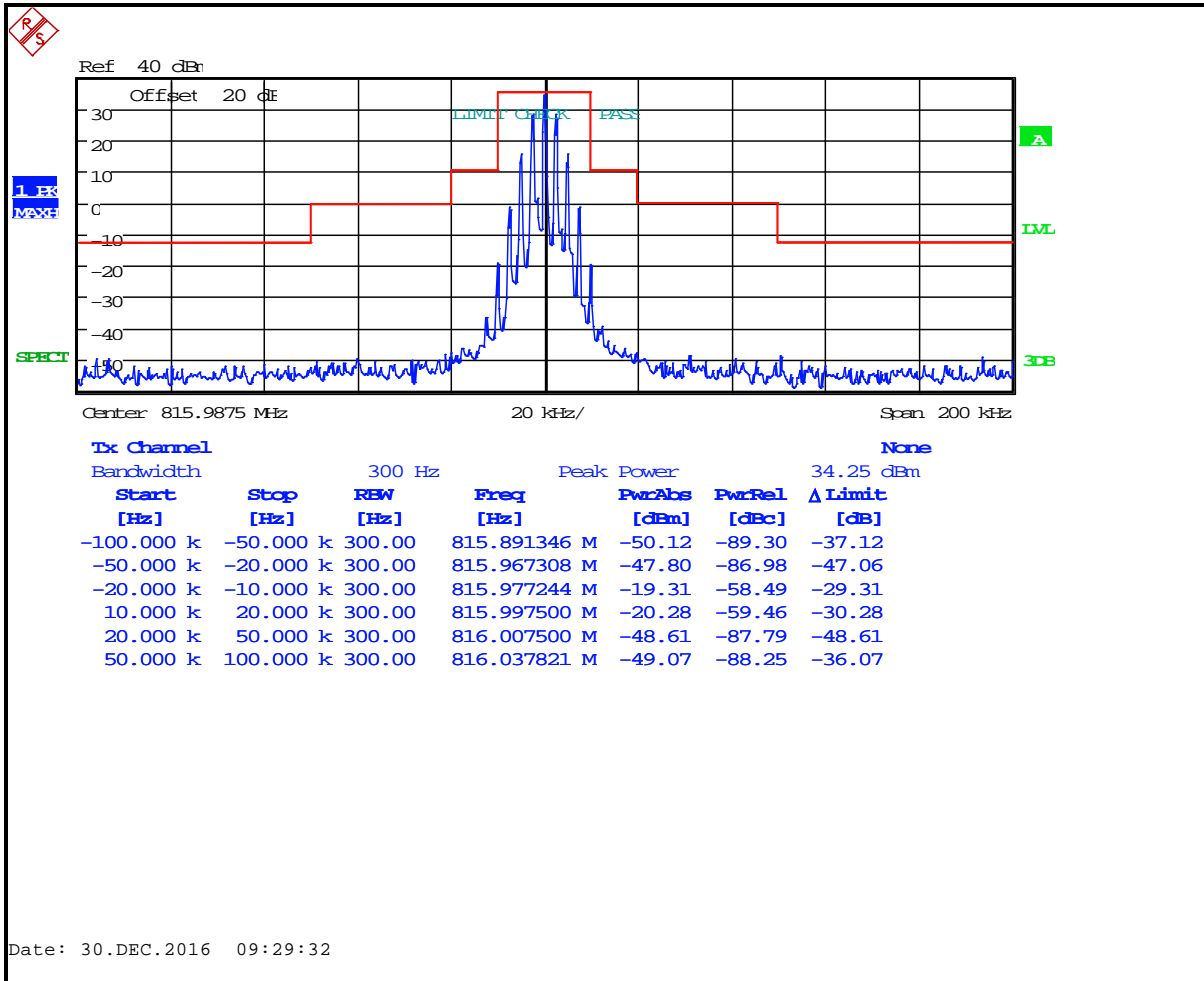

Plot 8-4: Occupied Bandwidth – 851.0125 MHz; NB Analog; Mask B

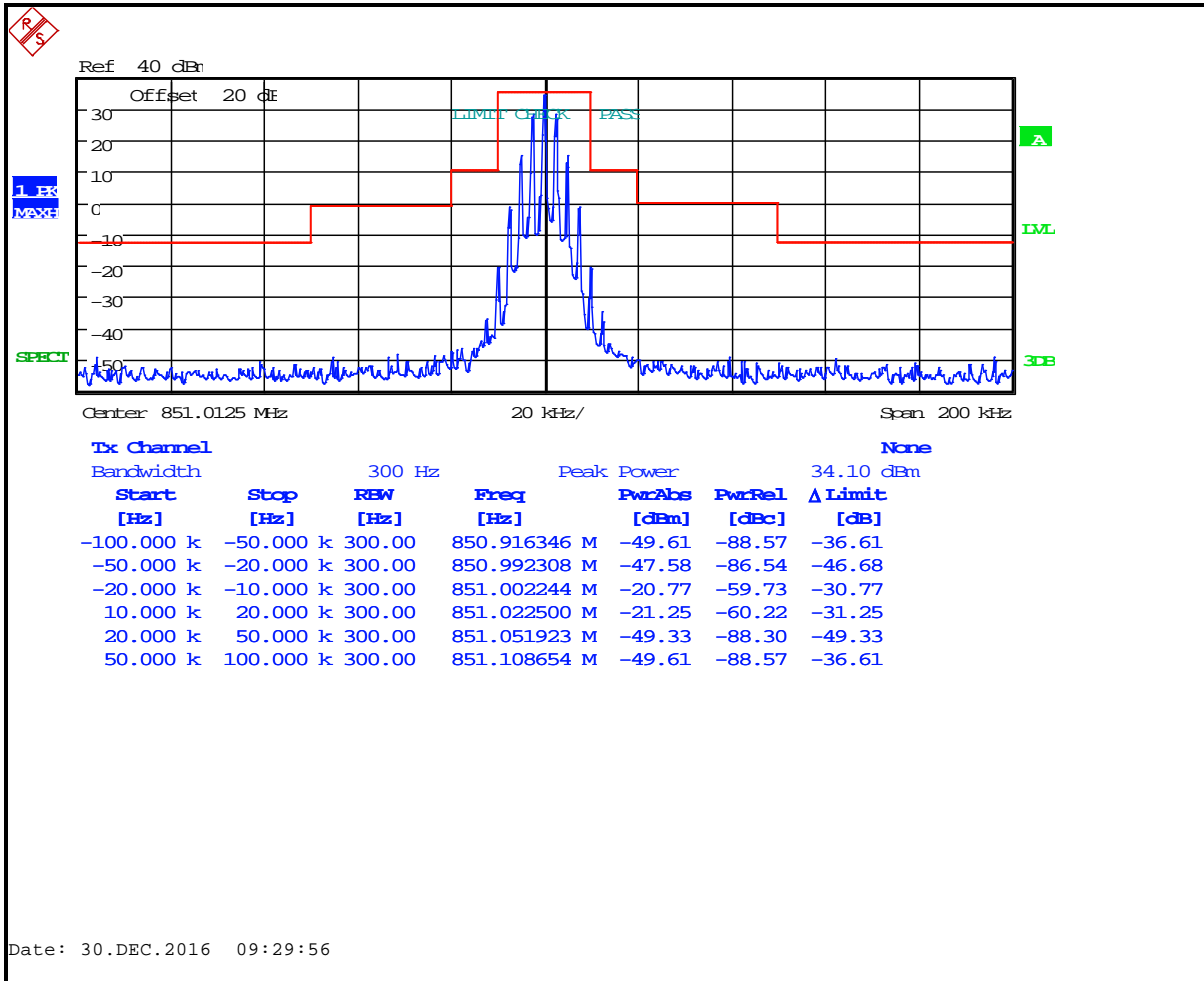

Plot 8-5: Occupied Bandwidth – 856.0125 MHz; NB Analog; Mask B

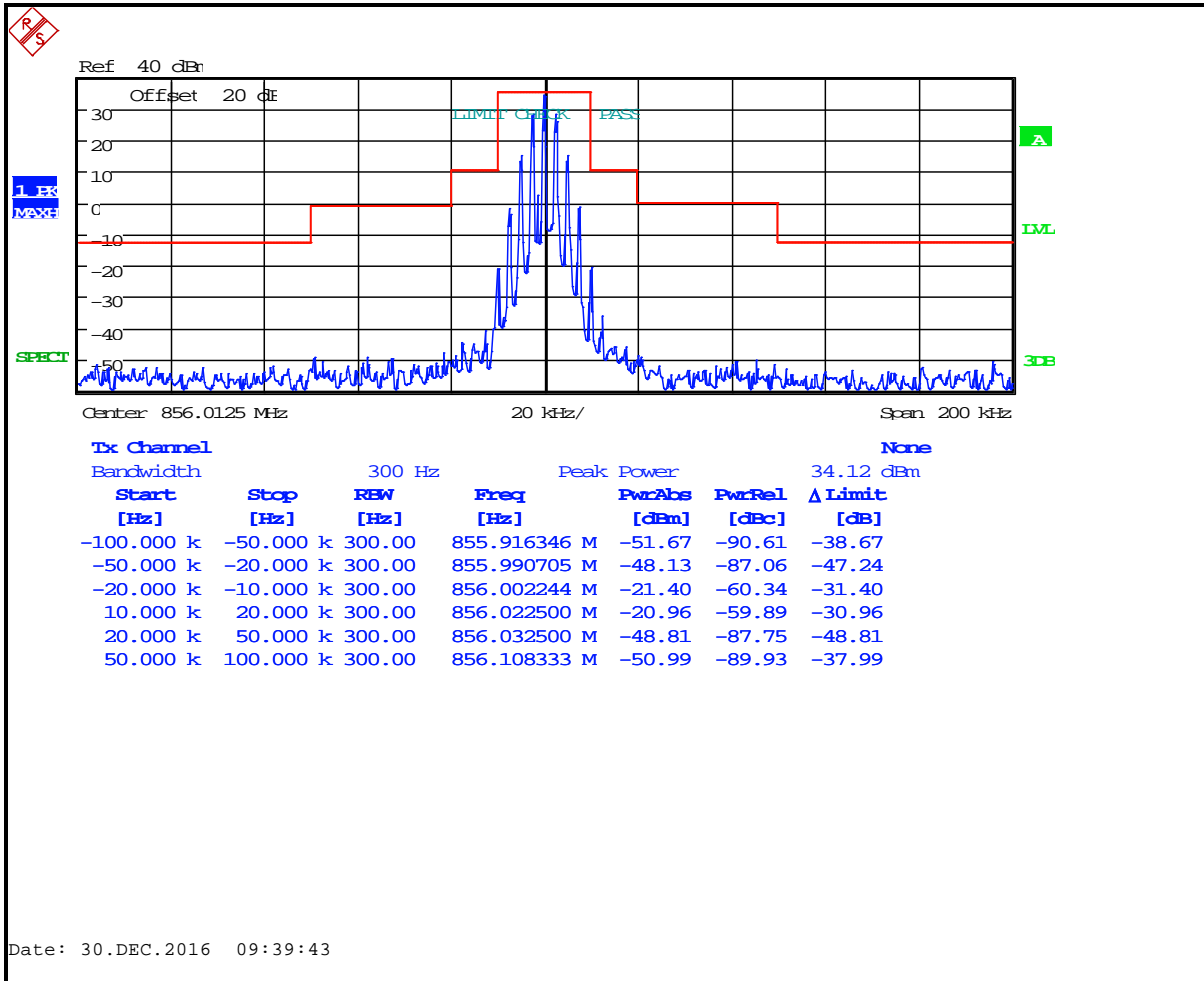

Plot 8-6: Occupied Bandwidth – 860.9875 MHz; NB Analog; Mask B

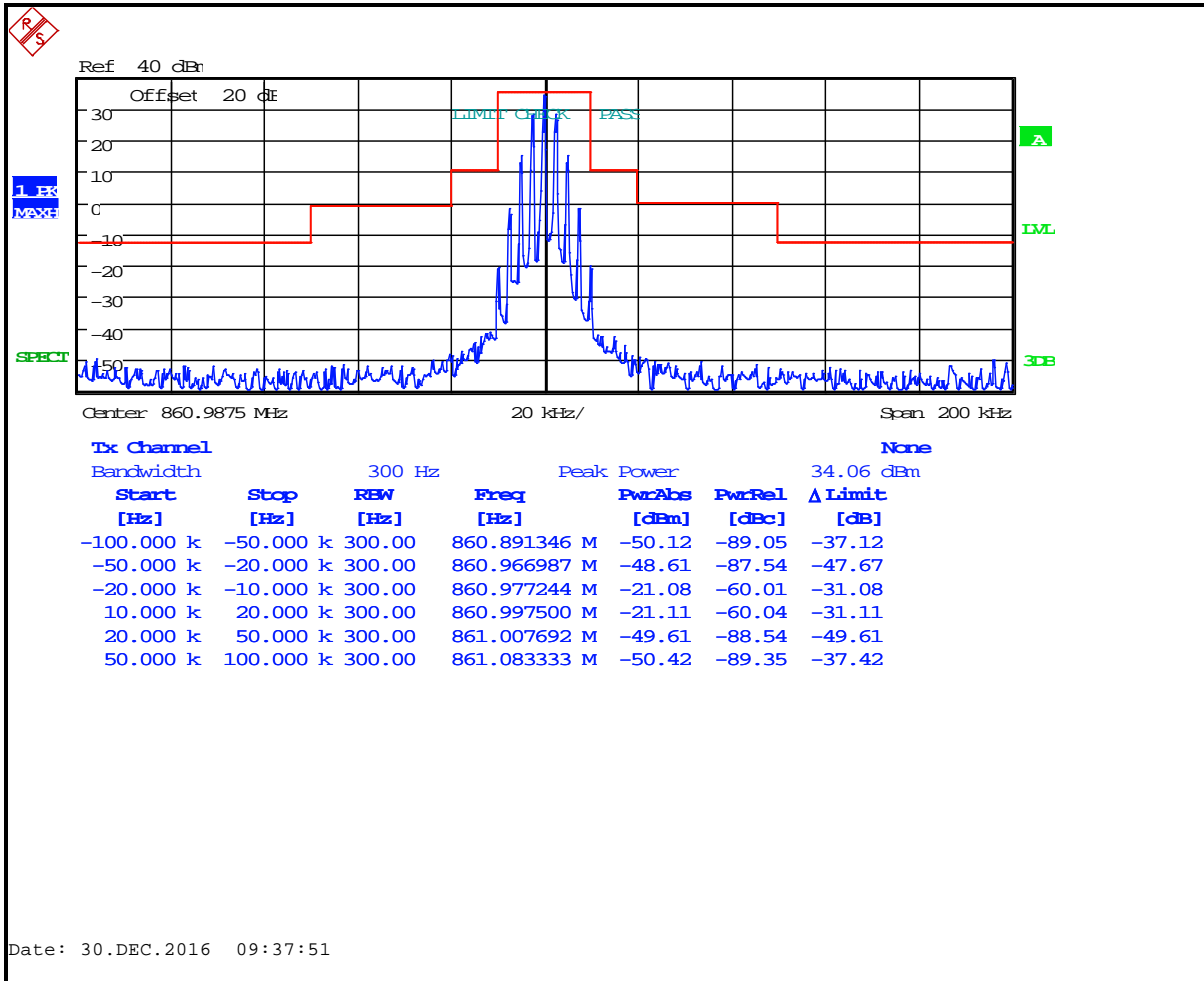

Plot 8-7: Occupied Bandwidth – 806.0125 MHz; NB Analog; Mask D (IC)

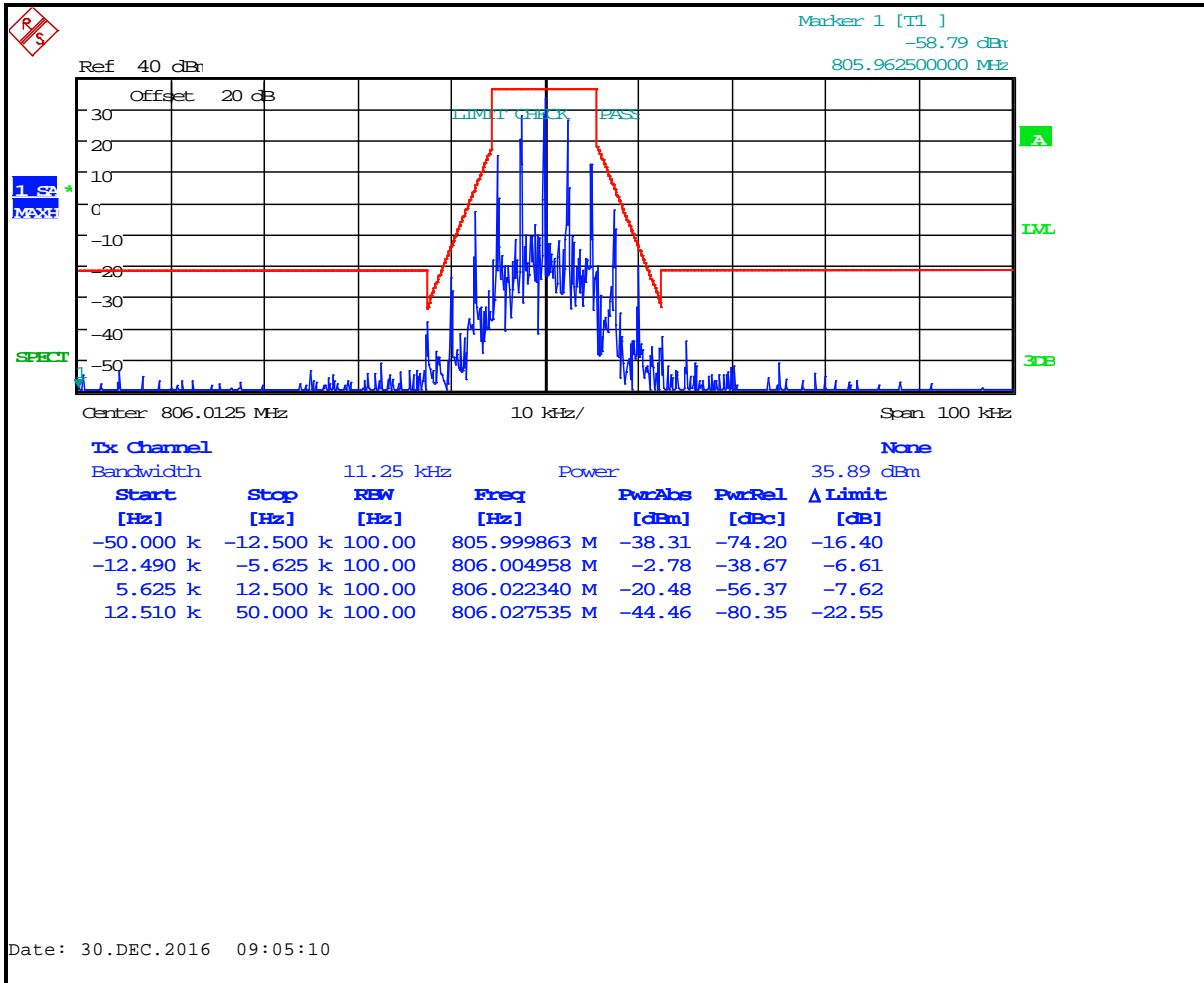

Plot 8-8: Occupied Bandwidth – 811.0125 MHz; NB Analog; Mask D (IC)

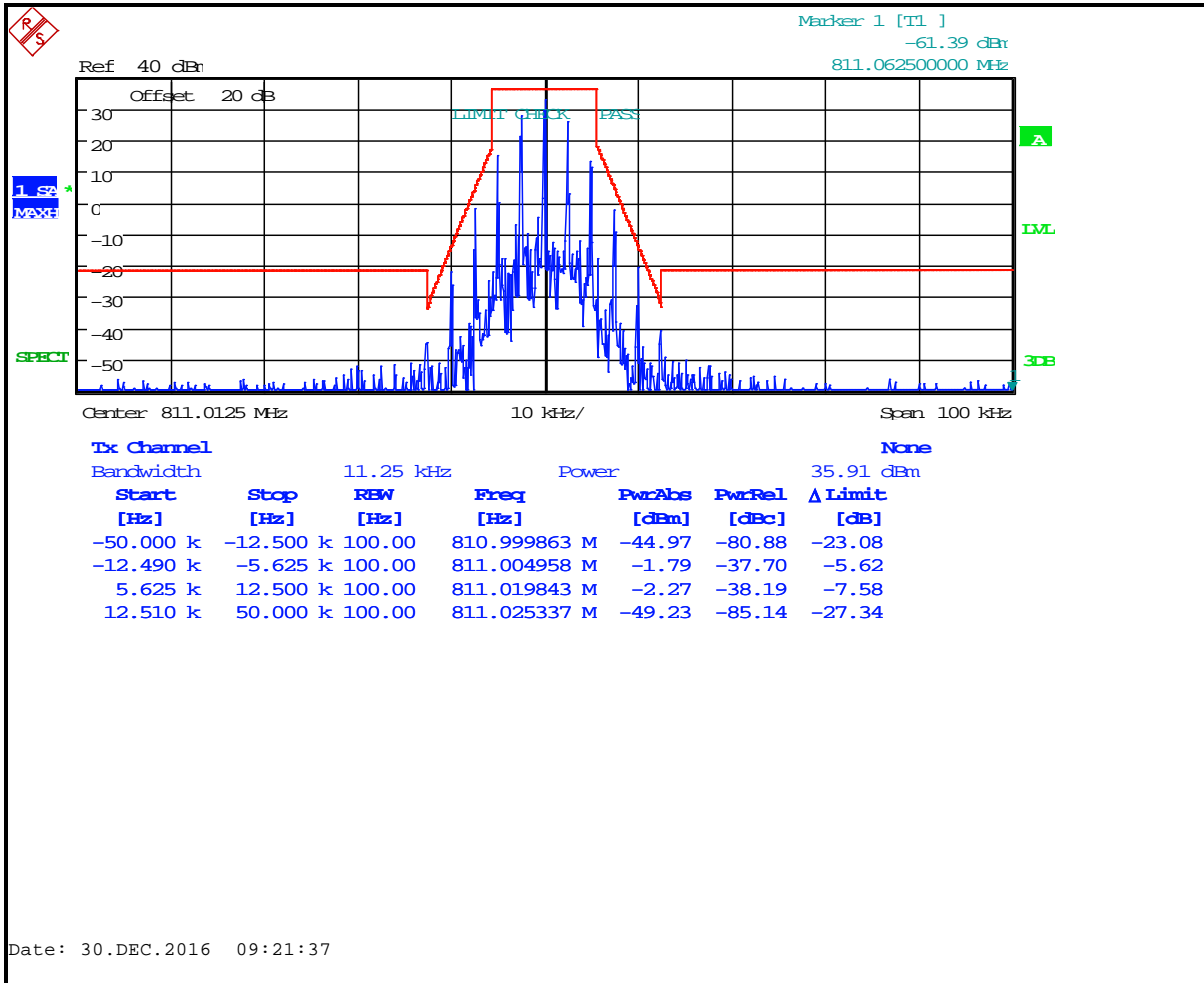

Plot 8-9: Occupied Bandwidth – 815.9875 MHz; NB Analog; Mask D (IC)

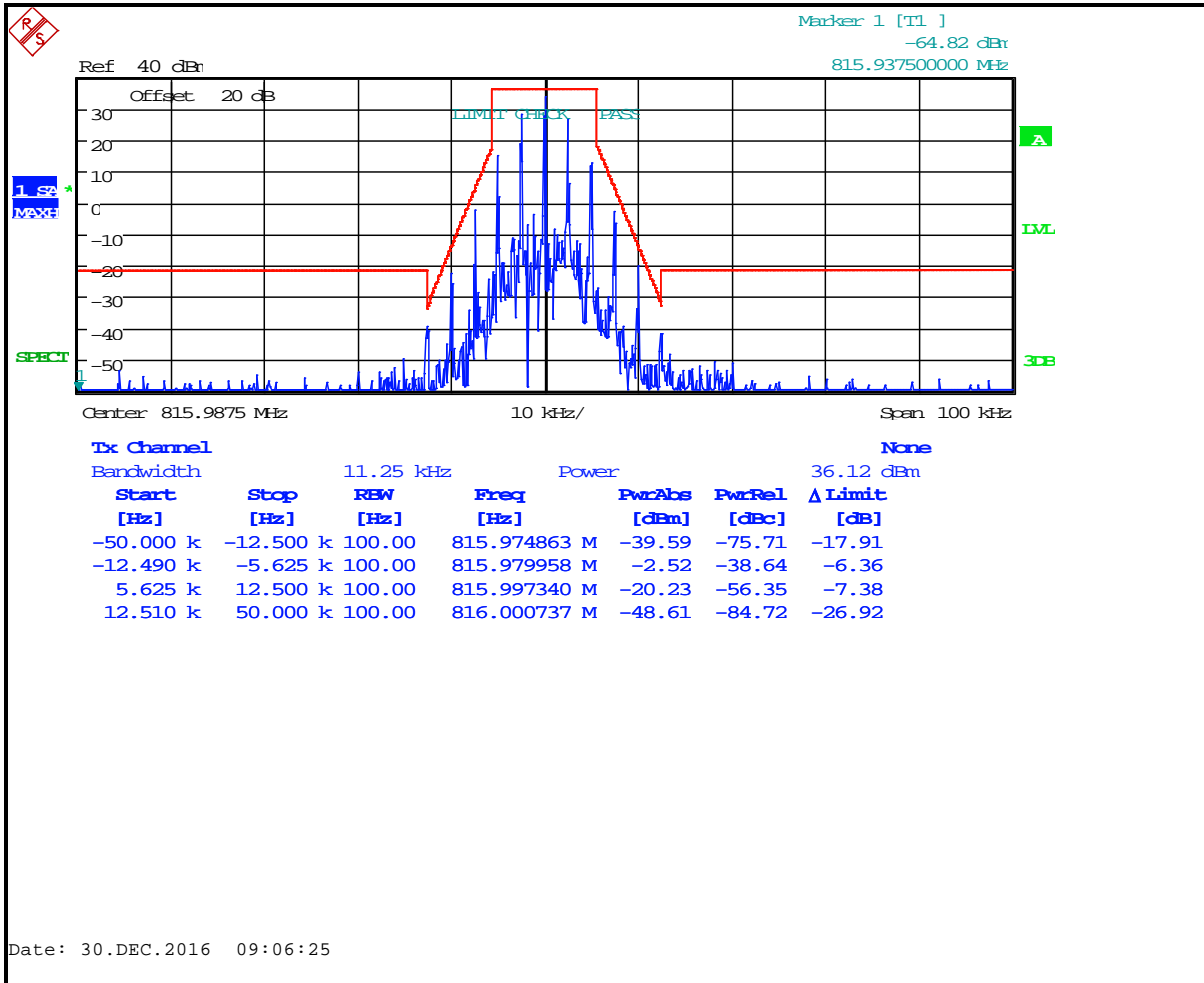

Plot 8-10: Occupied Bandwidth – 851.0125 MHz; NB Analog; Mask D (IC)

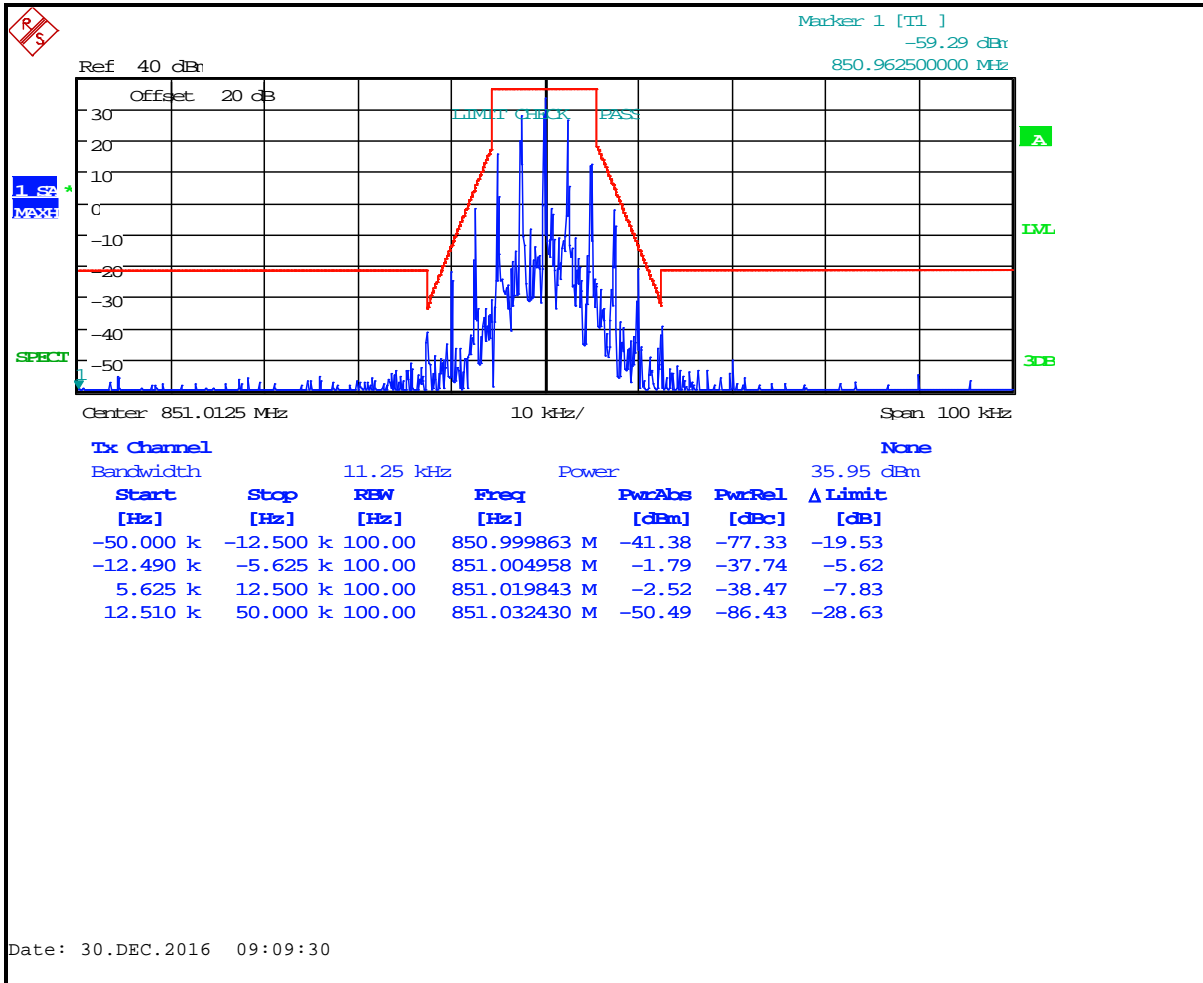

Plot 8-11: Occupied Bandwidth – 856.0125 MHz; NB Analog; Mask D (IC)

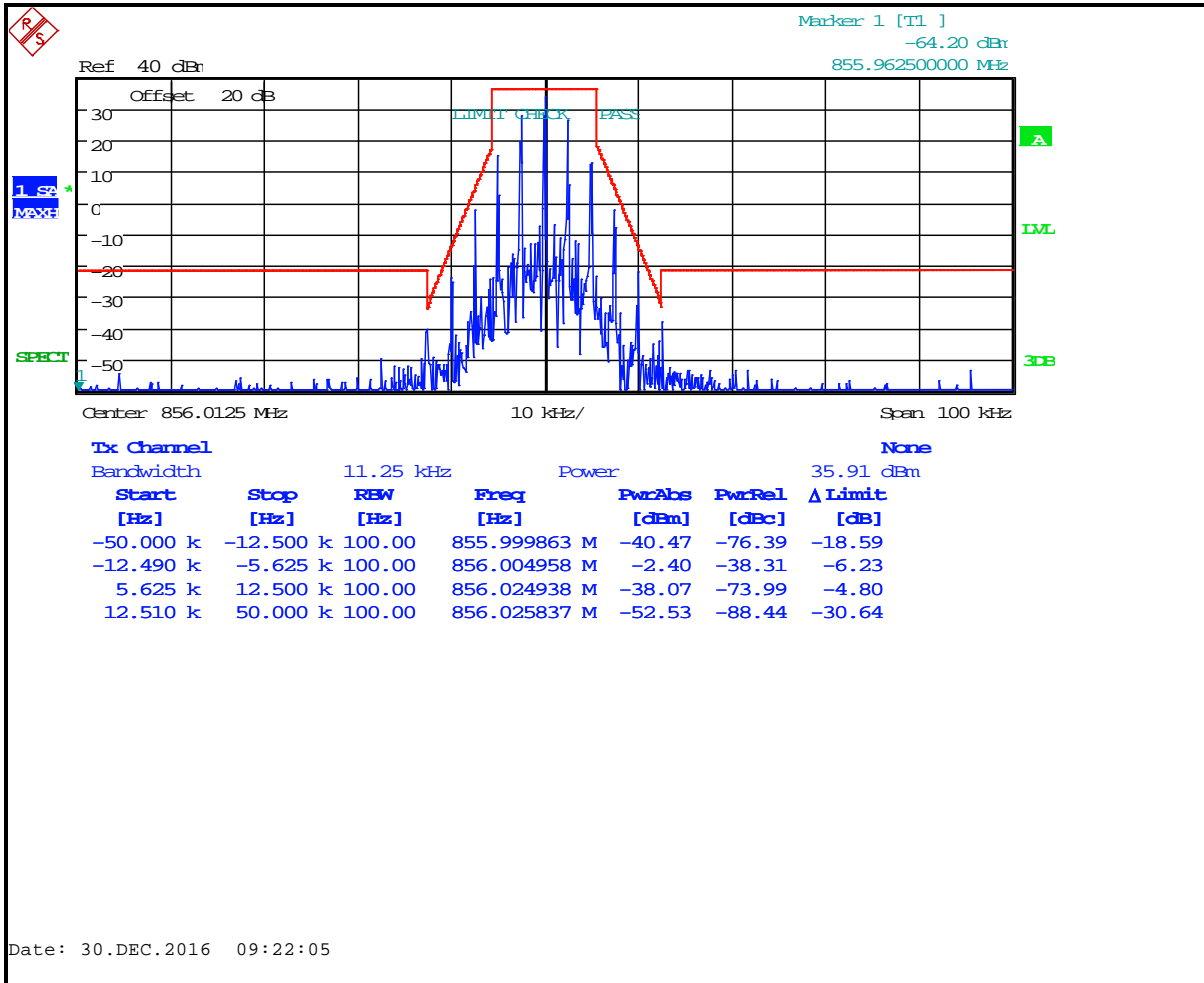

Plot 8-12: Occupied Bandwidth – 860.9875 MHz; NB Analog; Mask D (IC)

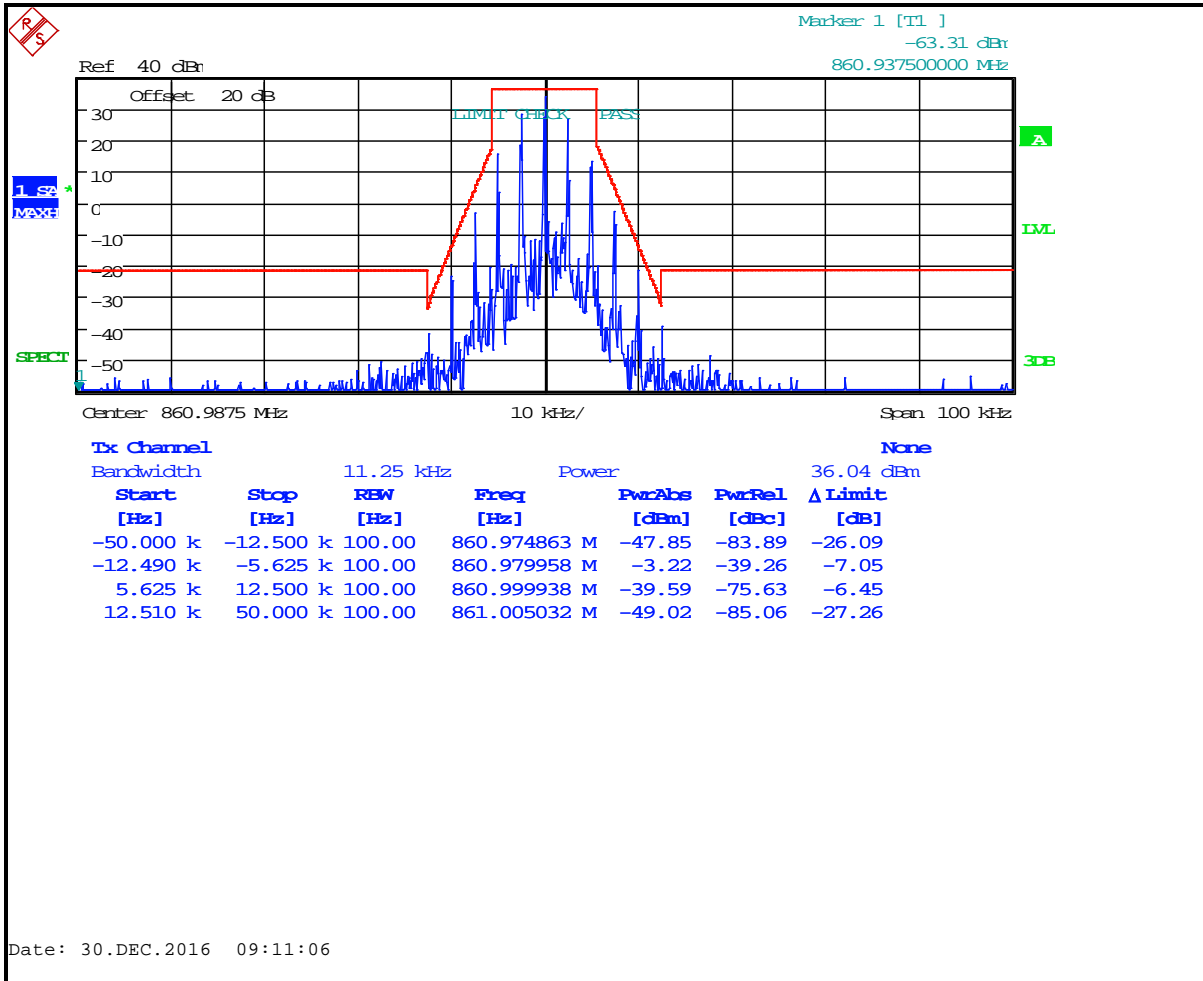

Plot 8-13: Occupied Bandwidth – 896.0125 MHz; NB Analog; Mask I

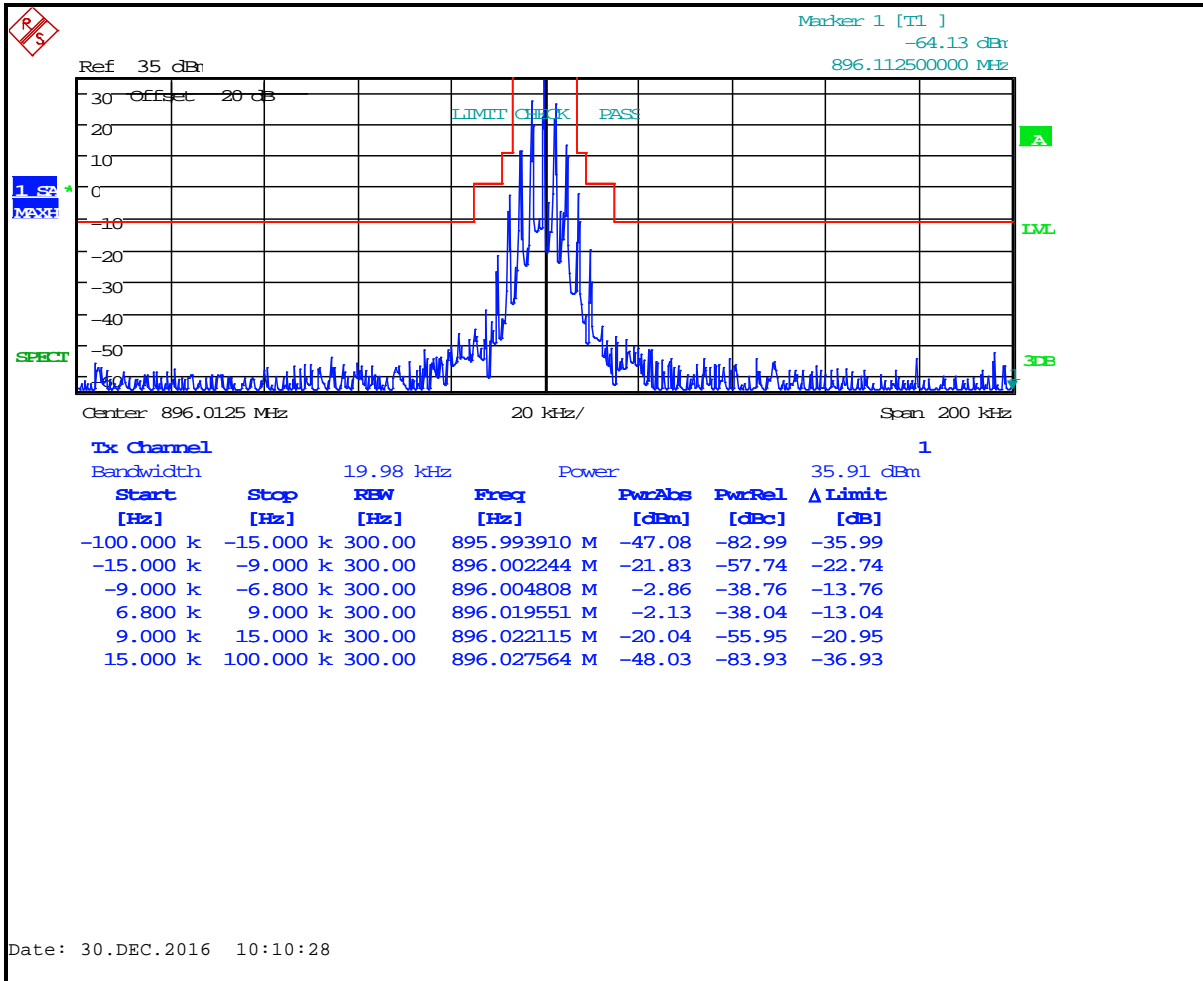

Plot 8-14: Occupied Bandwidth – 898.5000 MHz; NB Analog; Mask I

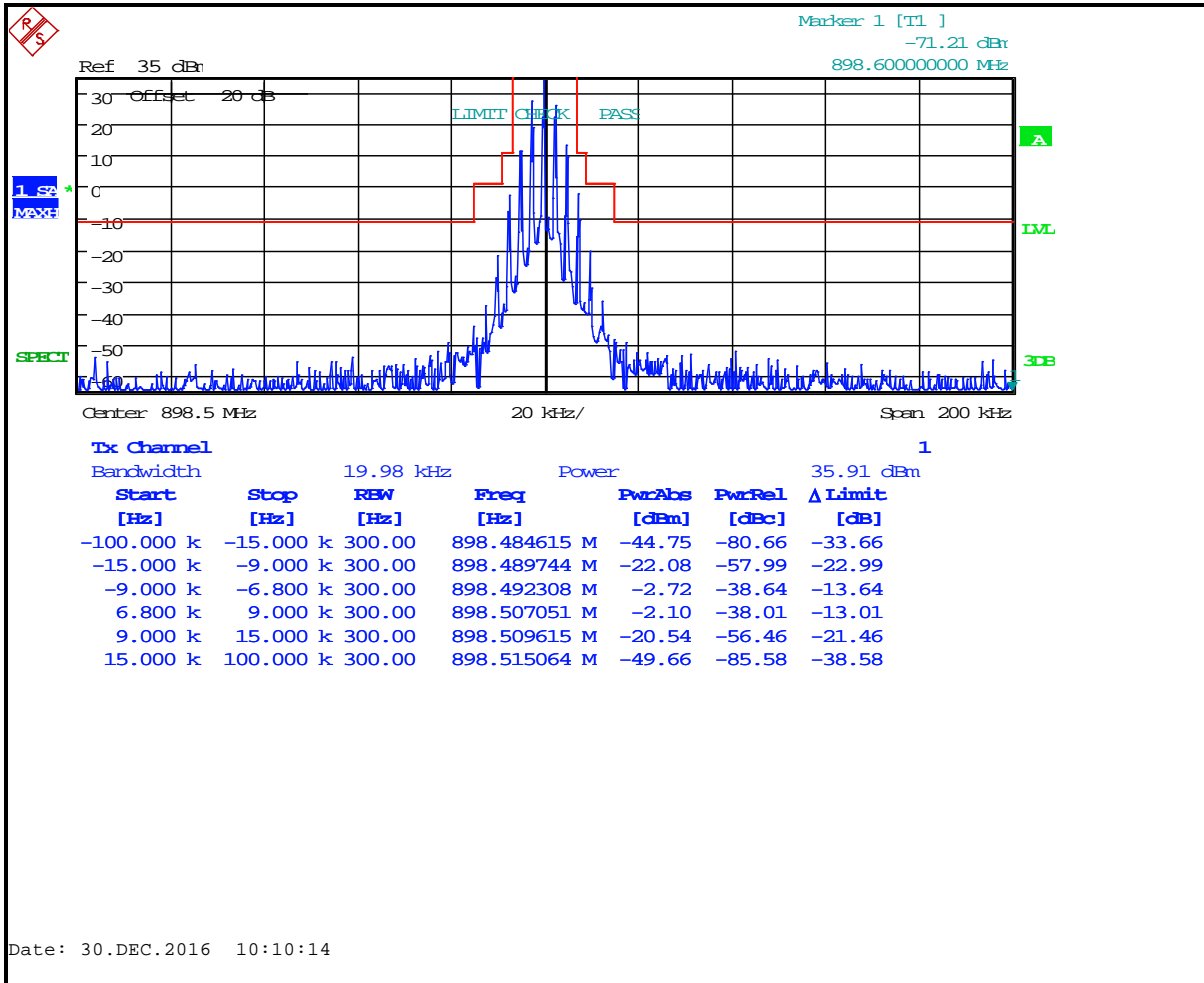

Plot 8-15: Occupied Bandwidth – 900.9875 MHz; NB Analog; Mask I

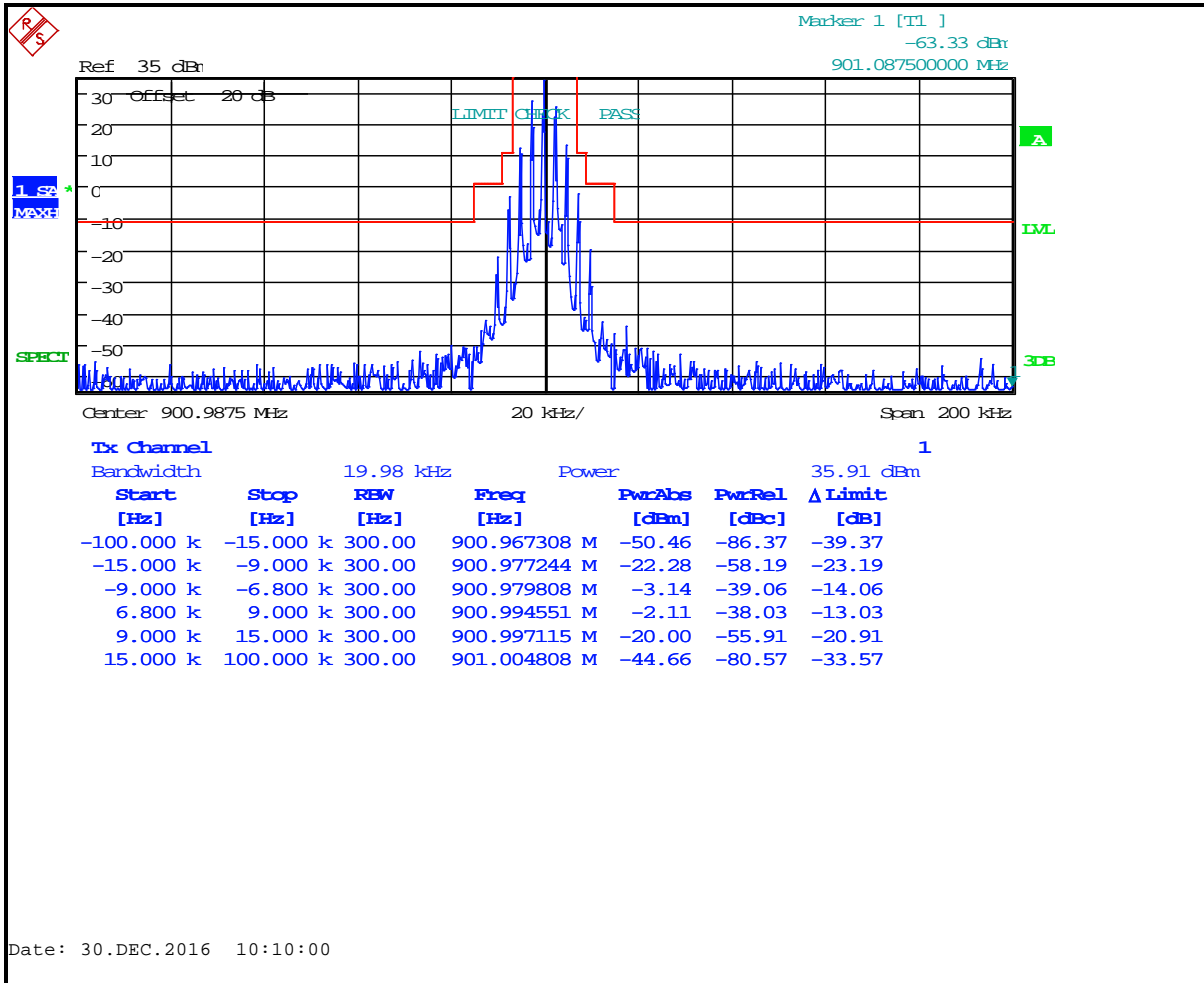

Plot 8-16: Occupied Bandwidth – 935.0125 MHz; NB Analog; Mask I

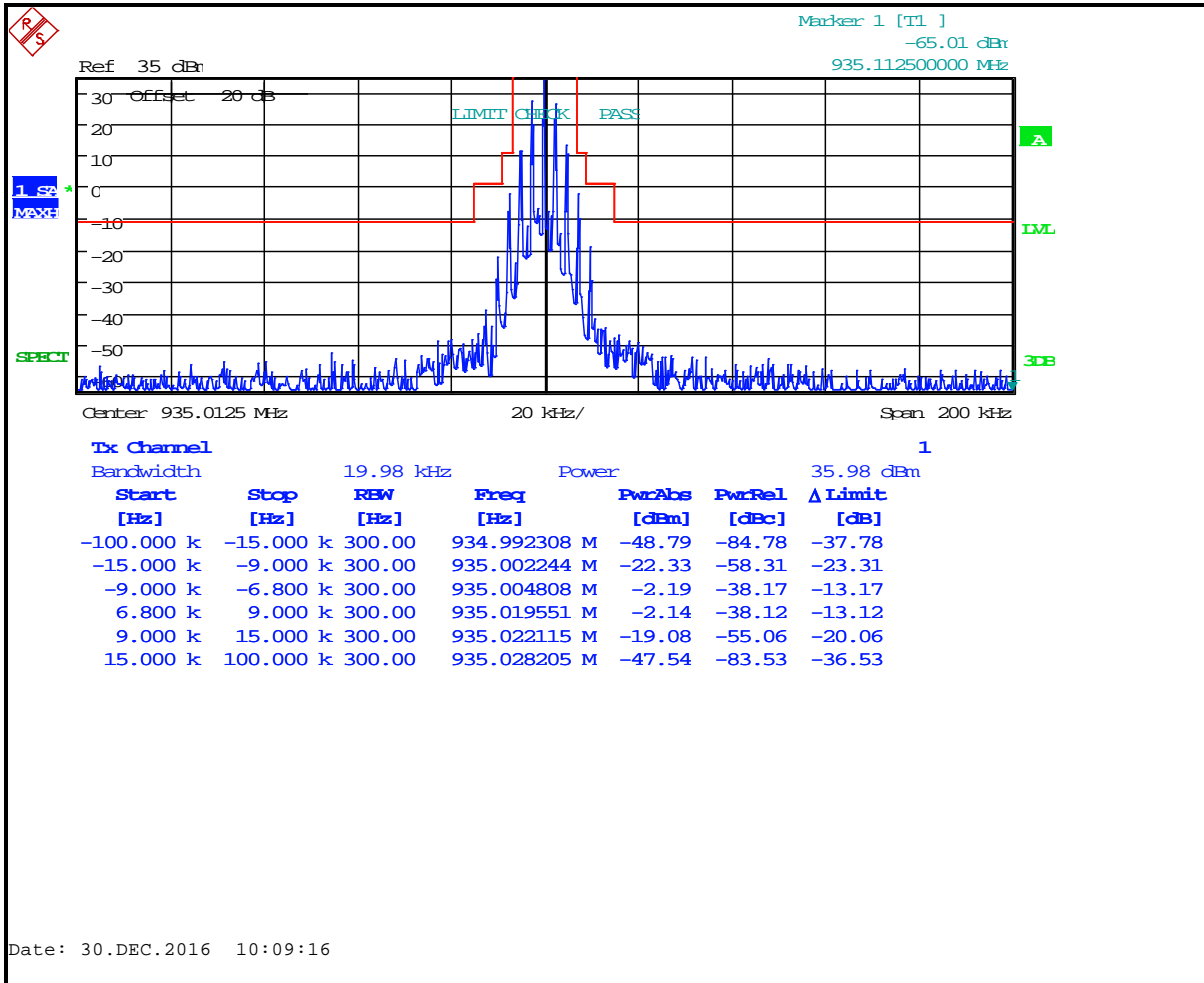

Plot 8-17: Occupied Bandwidth – 937.5 MHz; NB Analog; Mask I

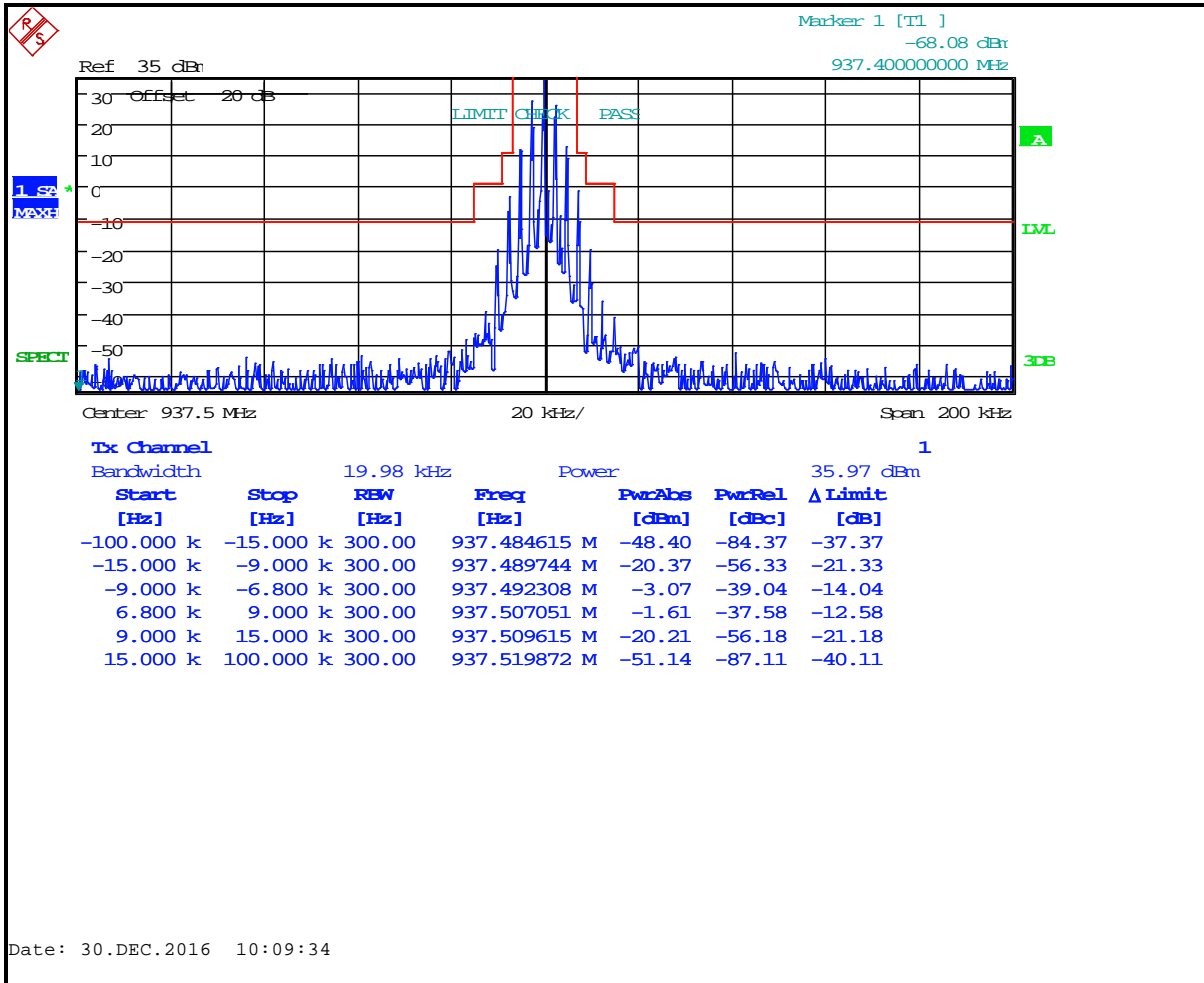

Plot 8-18: Occupied Bandwidth – 939.9875 MHz; NB Analog; Mask I

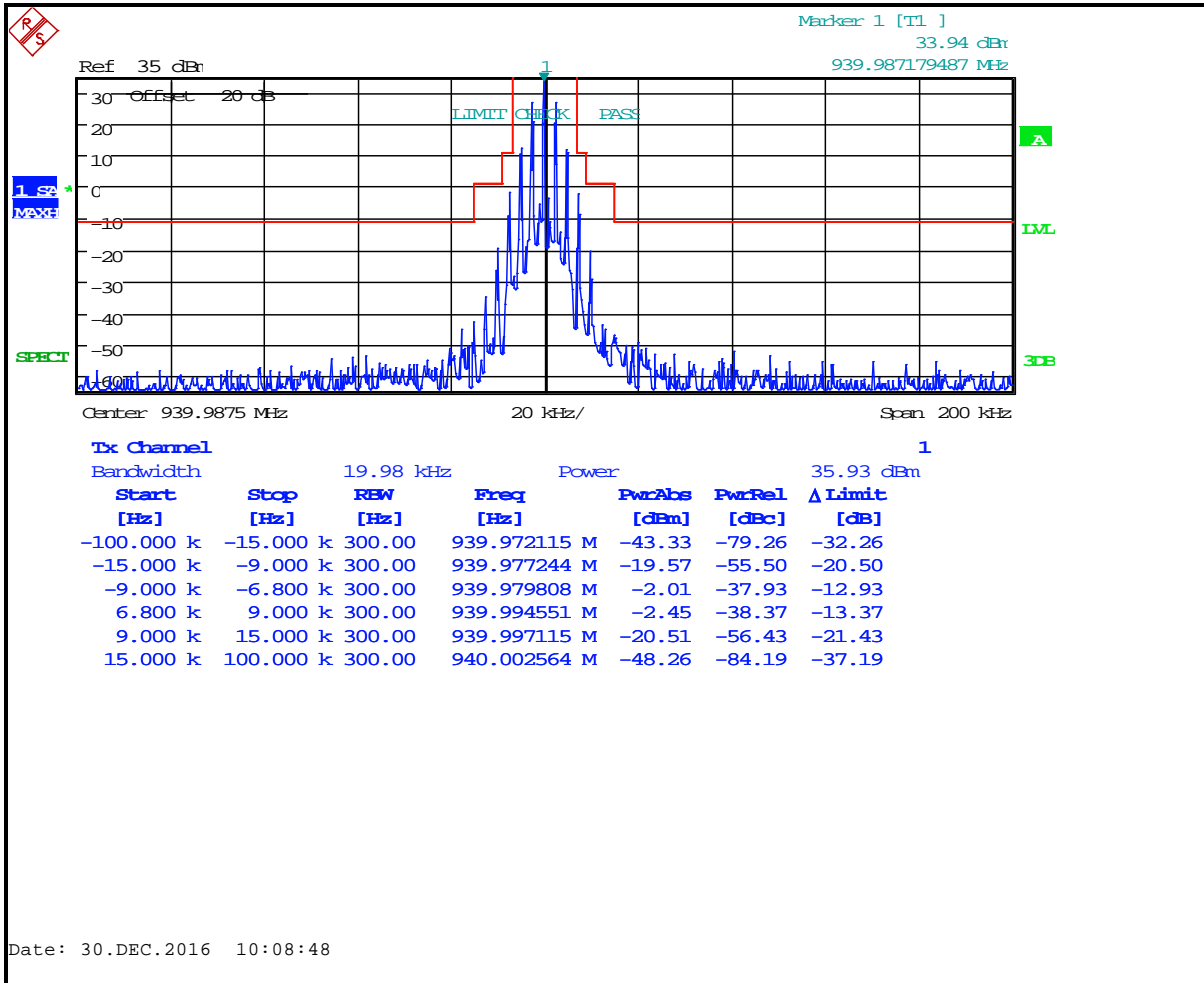

Plot 8-19: Occupied Bandwidth – 806.0125 MHz; Analog NPSPAC; Mask B

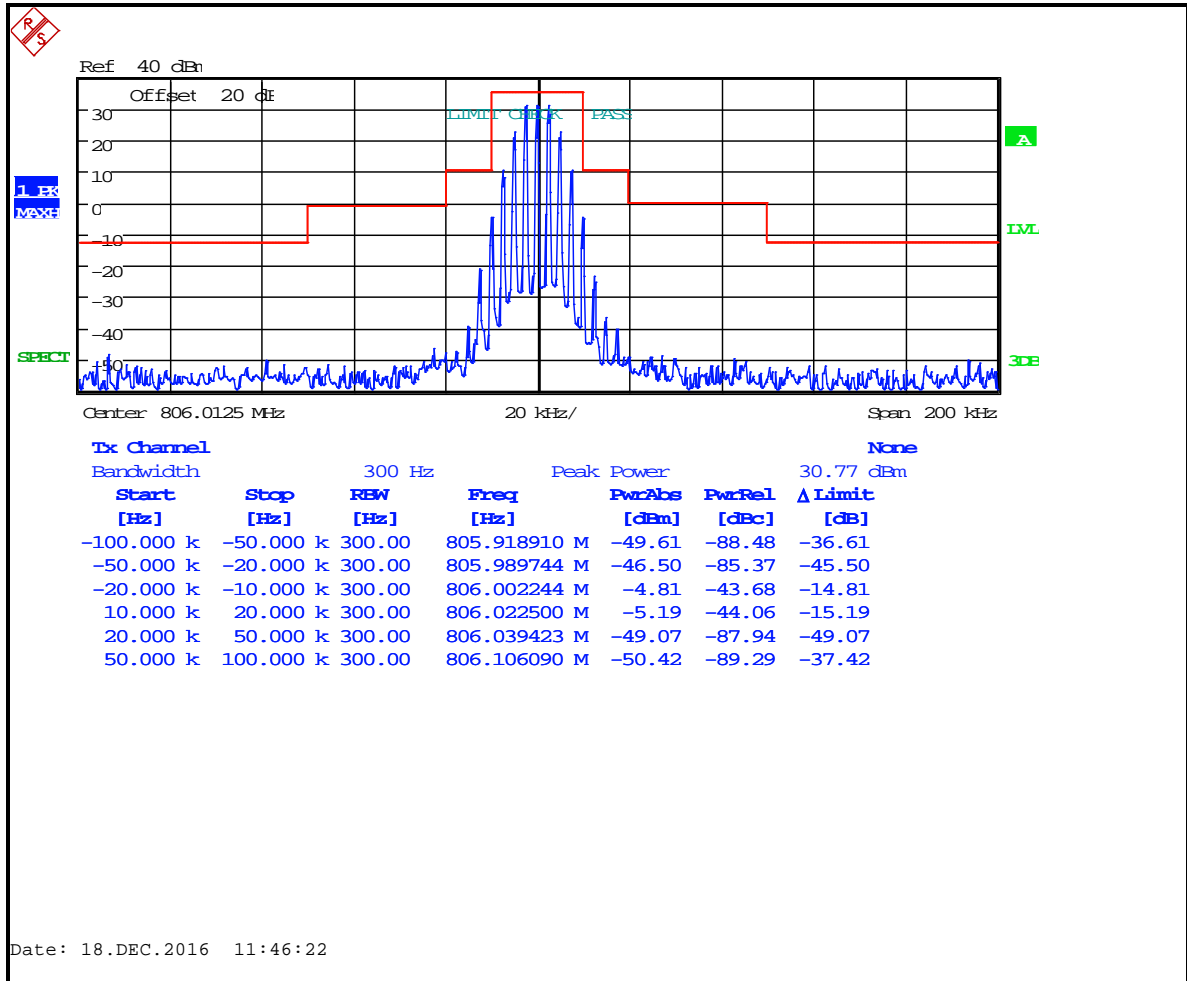

Plot 8-20: Occupied Bandwidth – 806.0125 MHz; Analog NPSPAC; Mask H

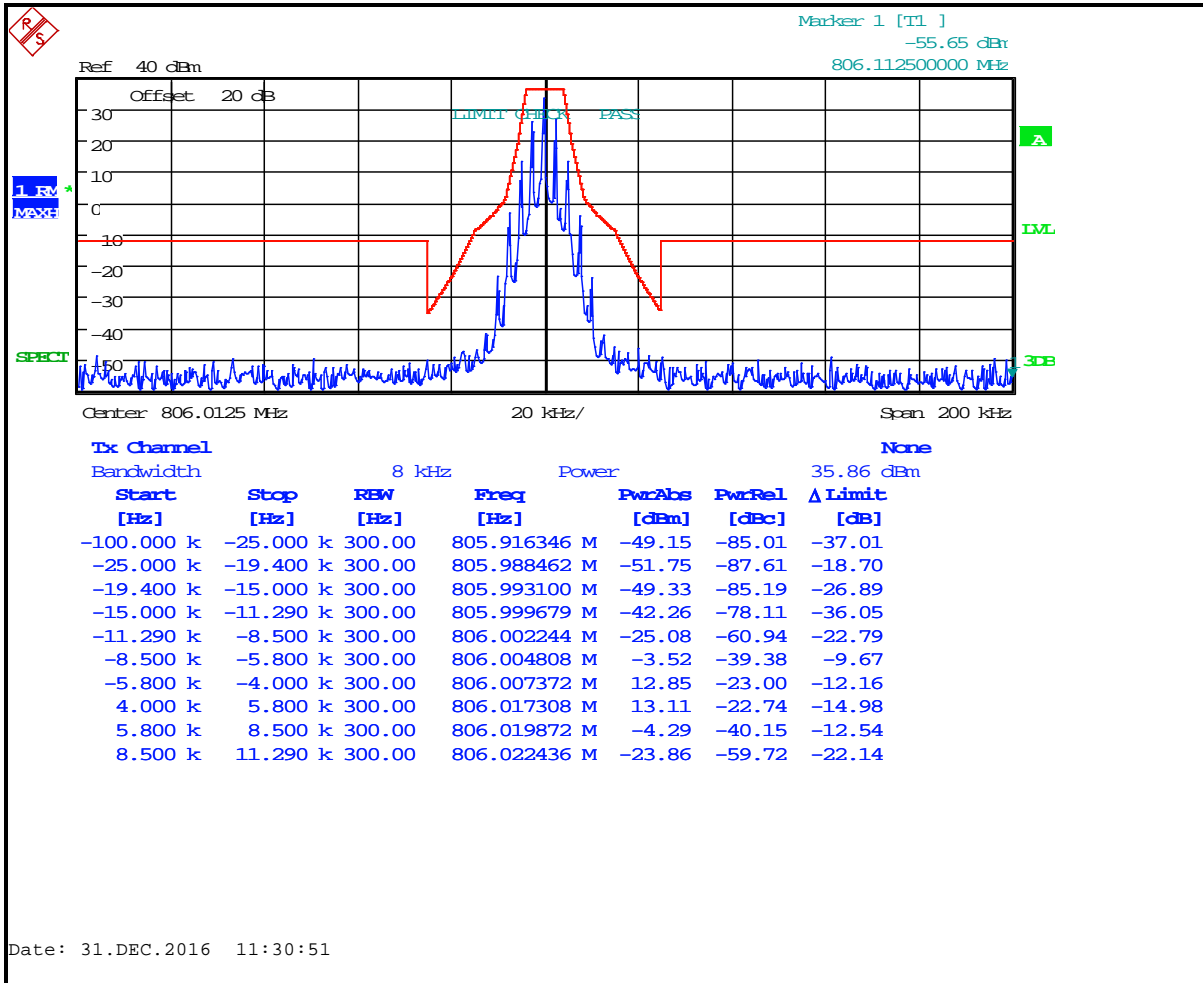

Plot 8-21: Occupied Bandwidth – 851.0125 MHz; Analog NPSPAC; Mask B

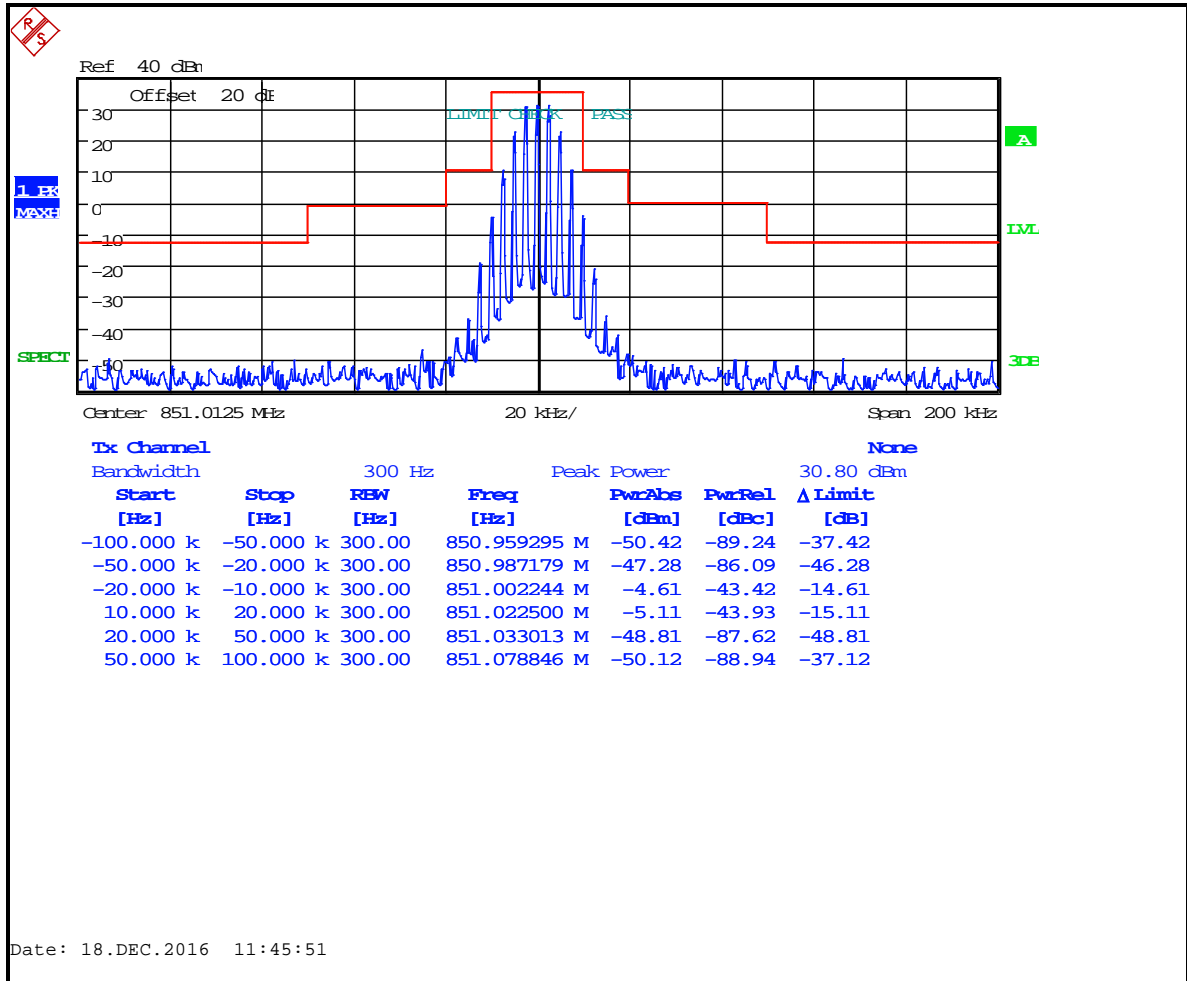

Plot 8-22: Occupied Bandwidth – 851.0125 MHz; Analog NPSPAC; Mask H

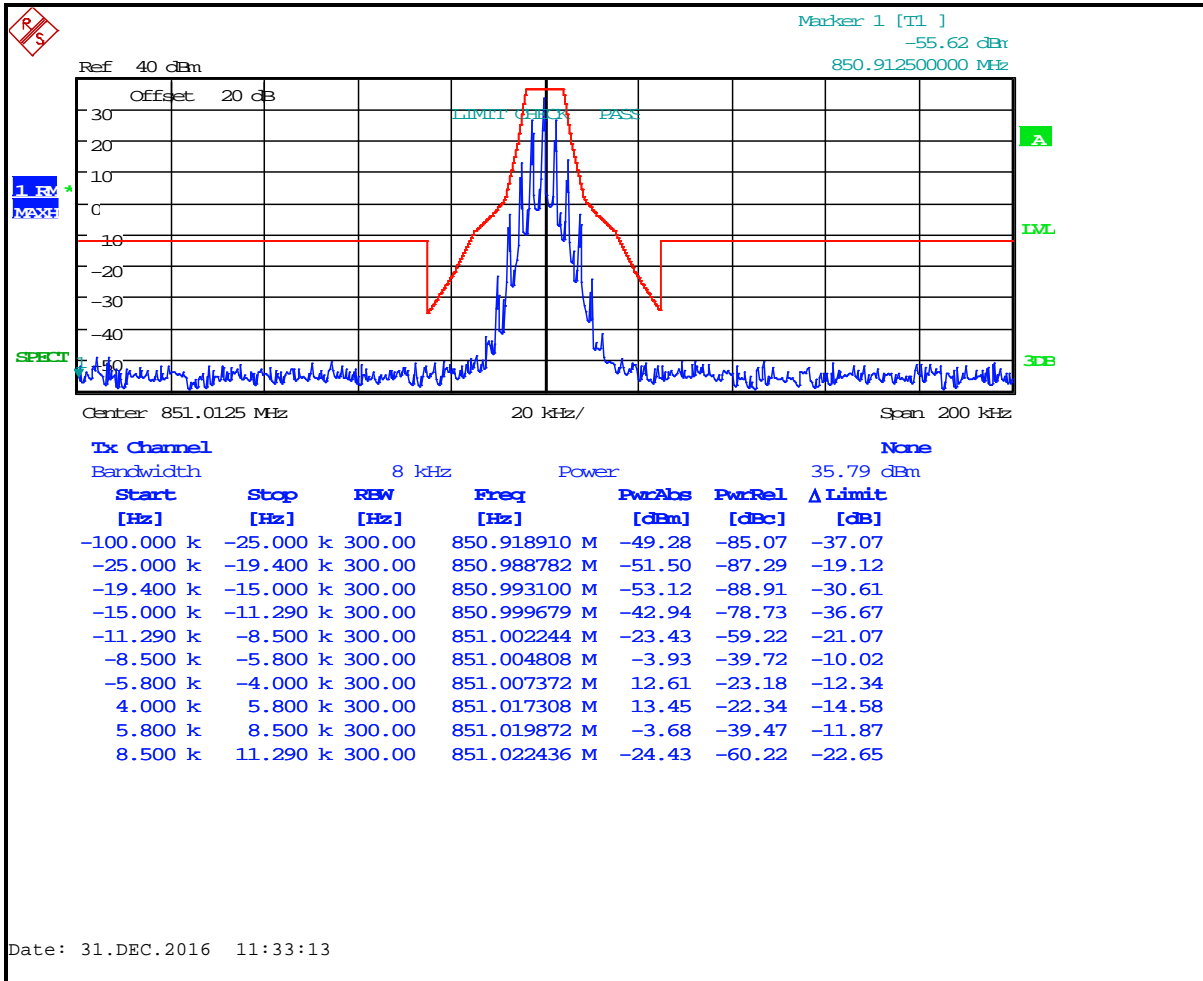

Plot 8-23: Occupied Bandwidth – 856.0125 MHz; Analog NPSPAC; Mask B

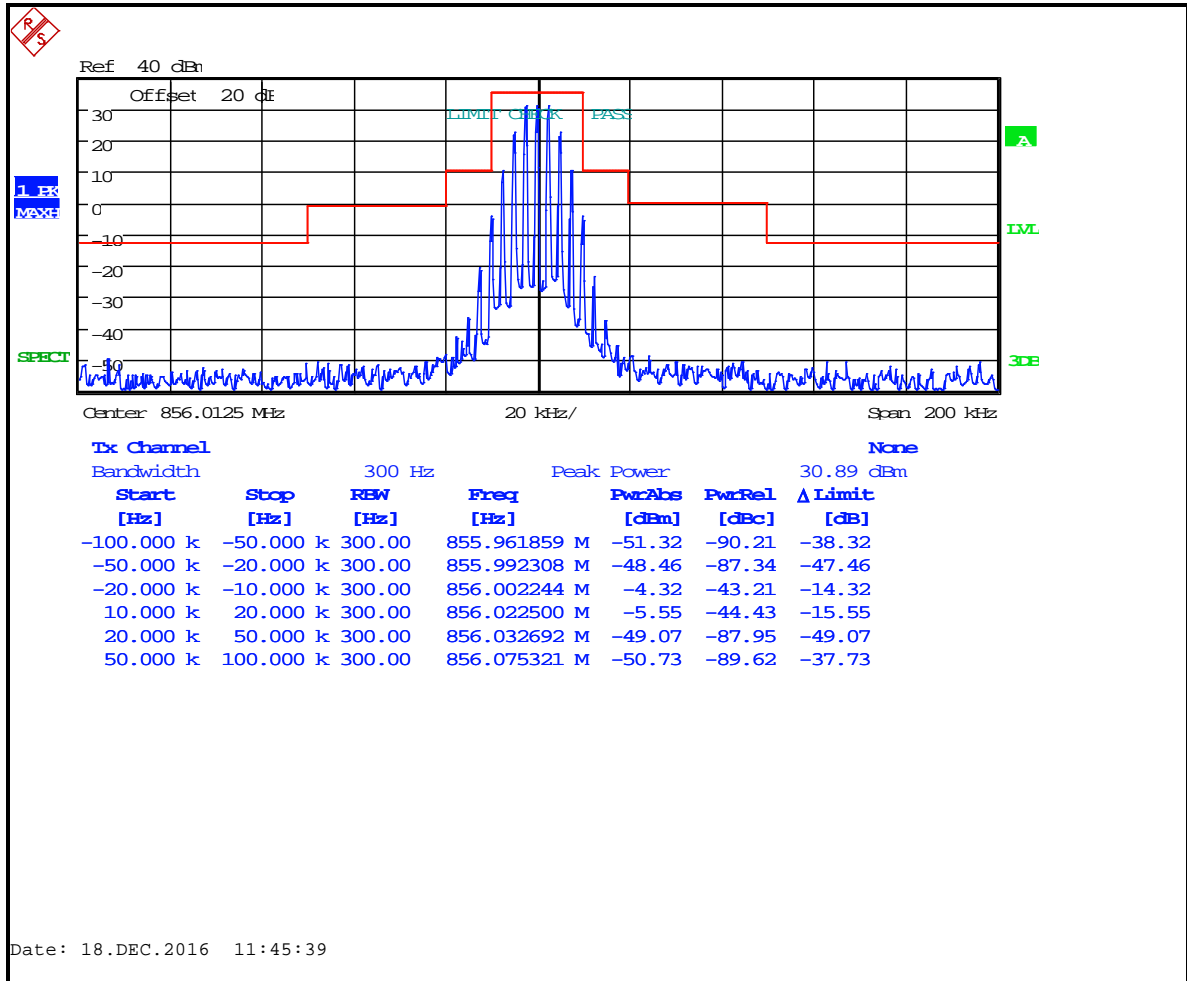

Plot 8-24: Occupied Bandwidth – 860.9875 MHz; Analog NPSPAC; Mask B

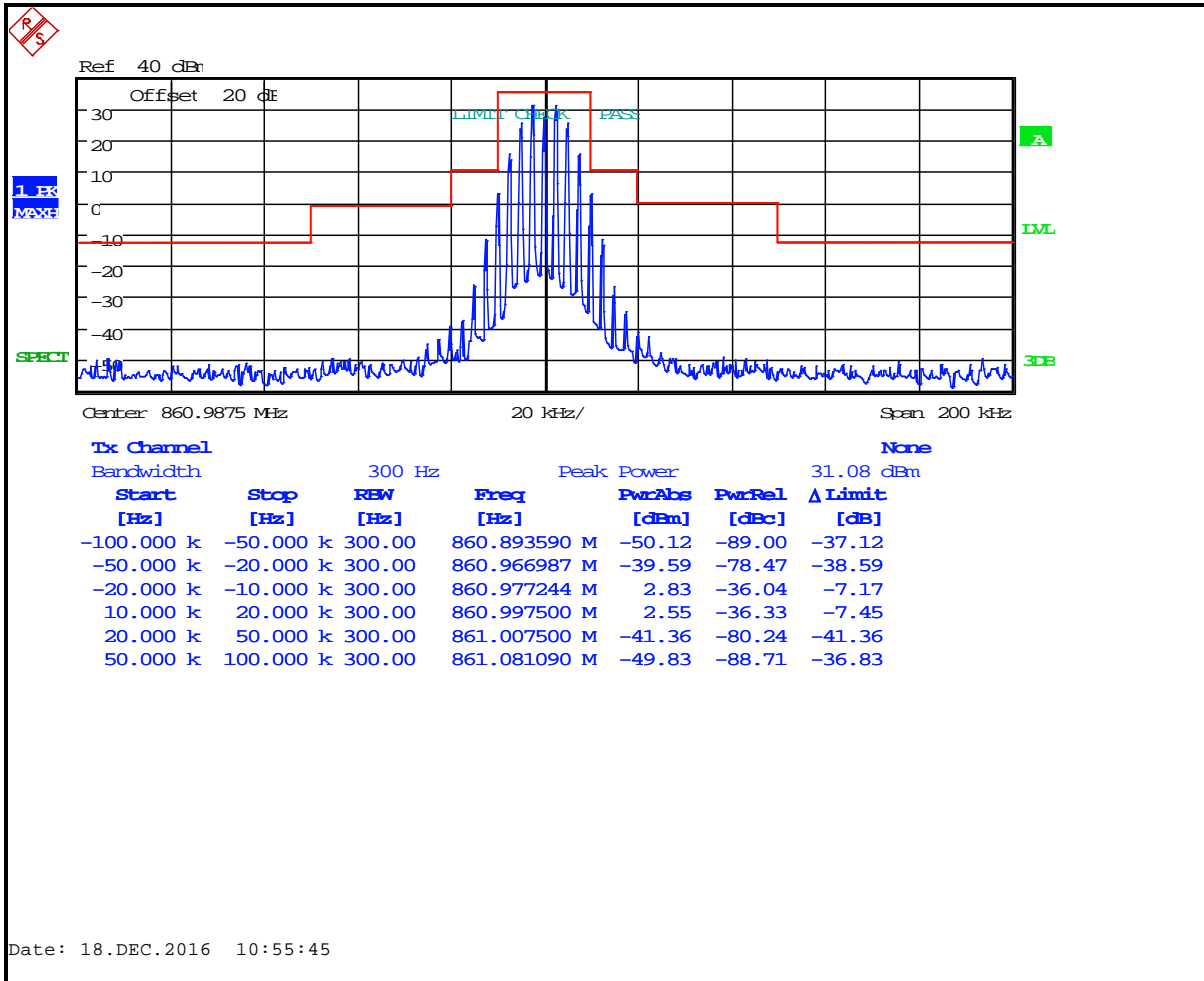

Plot 8-25: Occupied Bandwidth – 809.0125 MHz; WB Analog; Mask B

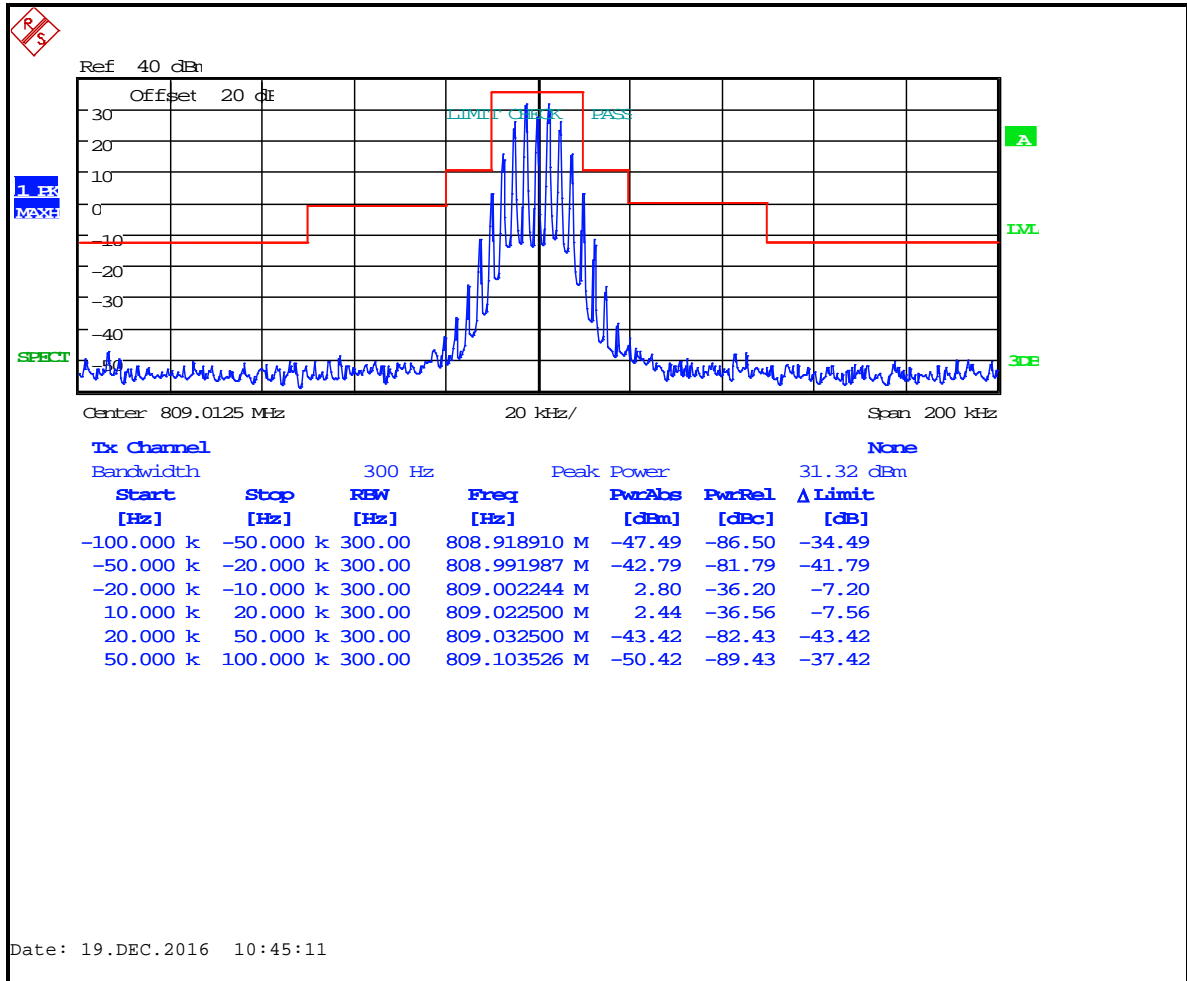

Plot 8-26: Occupied Bandwidth – 811.0125 MHz; WB Analog; Mask B

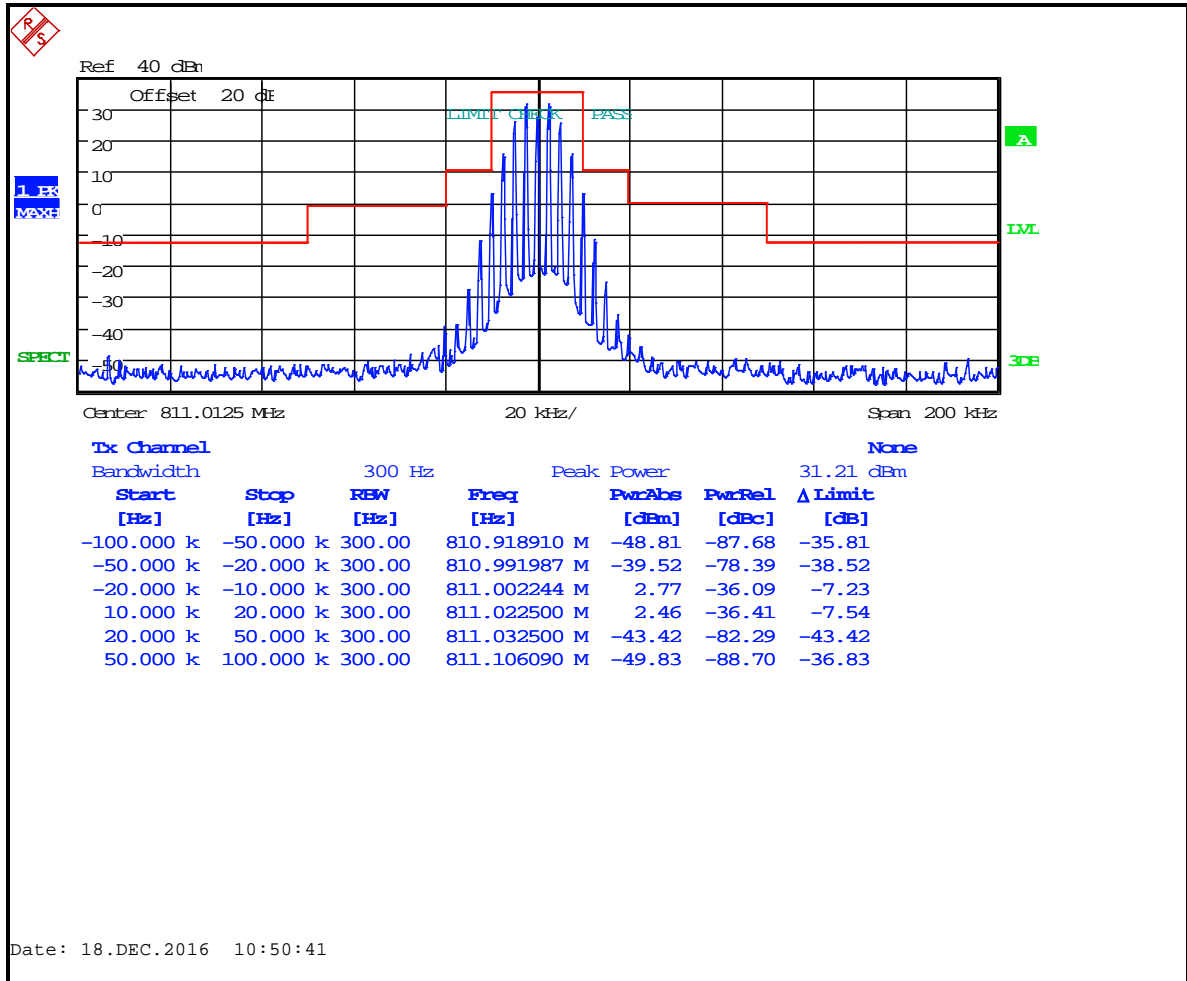

Plot 8-27: Occupied Bandwidth – 815.9875 MHz; WB Analog; Mask B

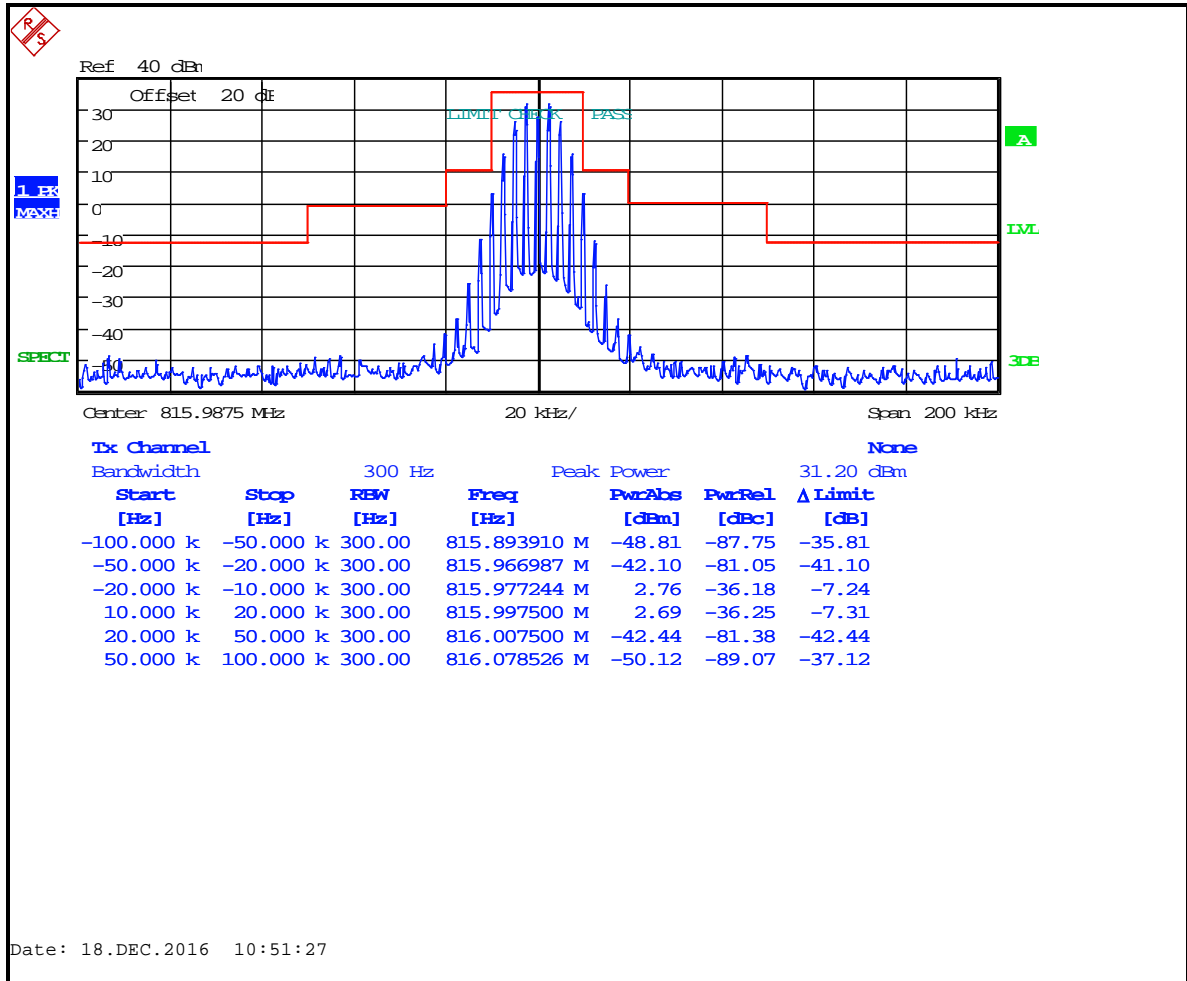

Plot 8-28: Occupied Bandwidth – 851.0125 MHz; WB Analog; Mask B

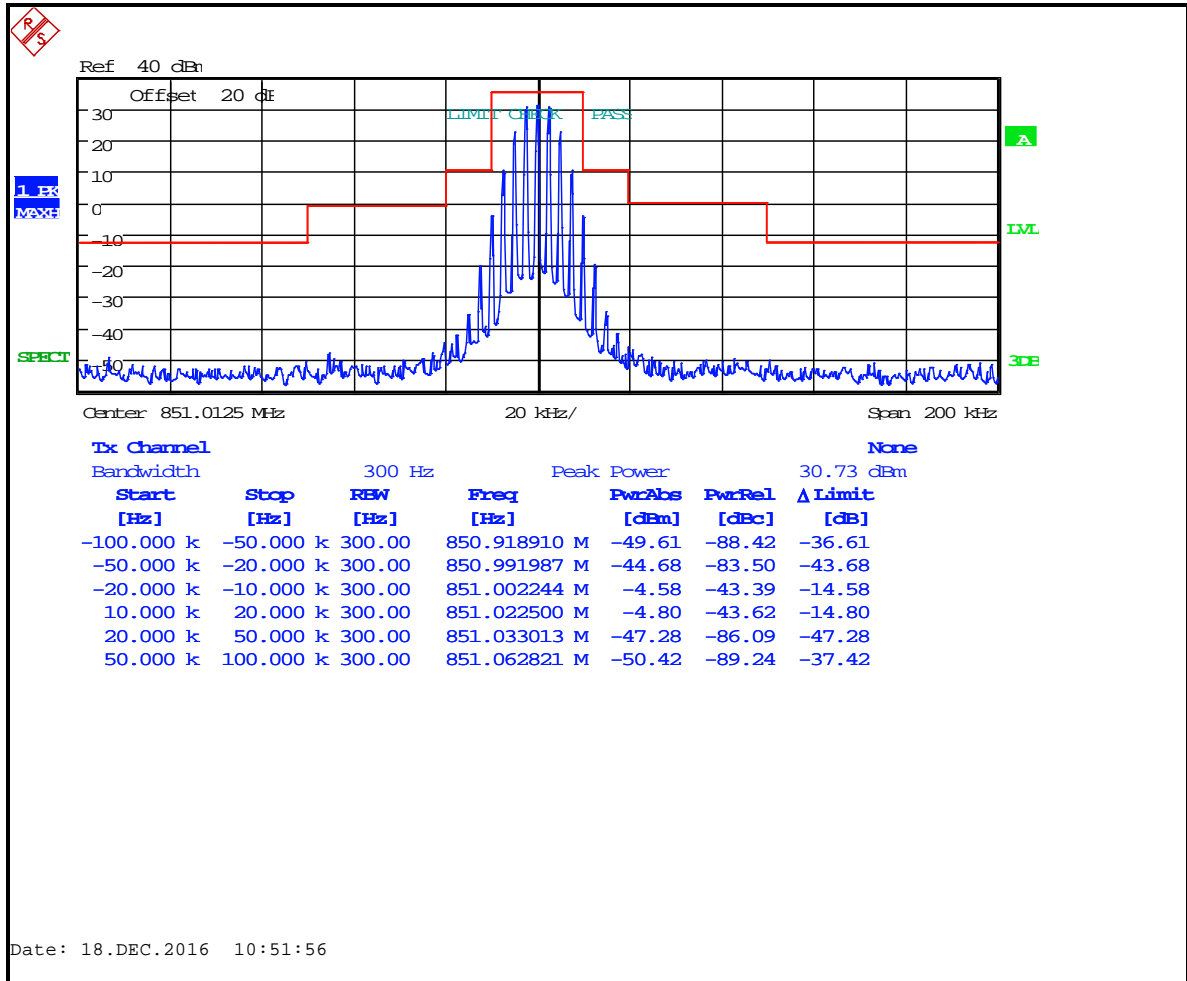

Plot 8-29: Occupied Bandwidth – 856.0125 MHz; WB Analog; Mask B

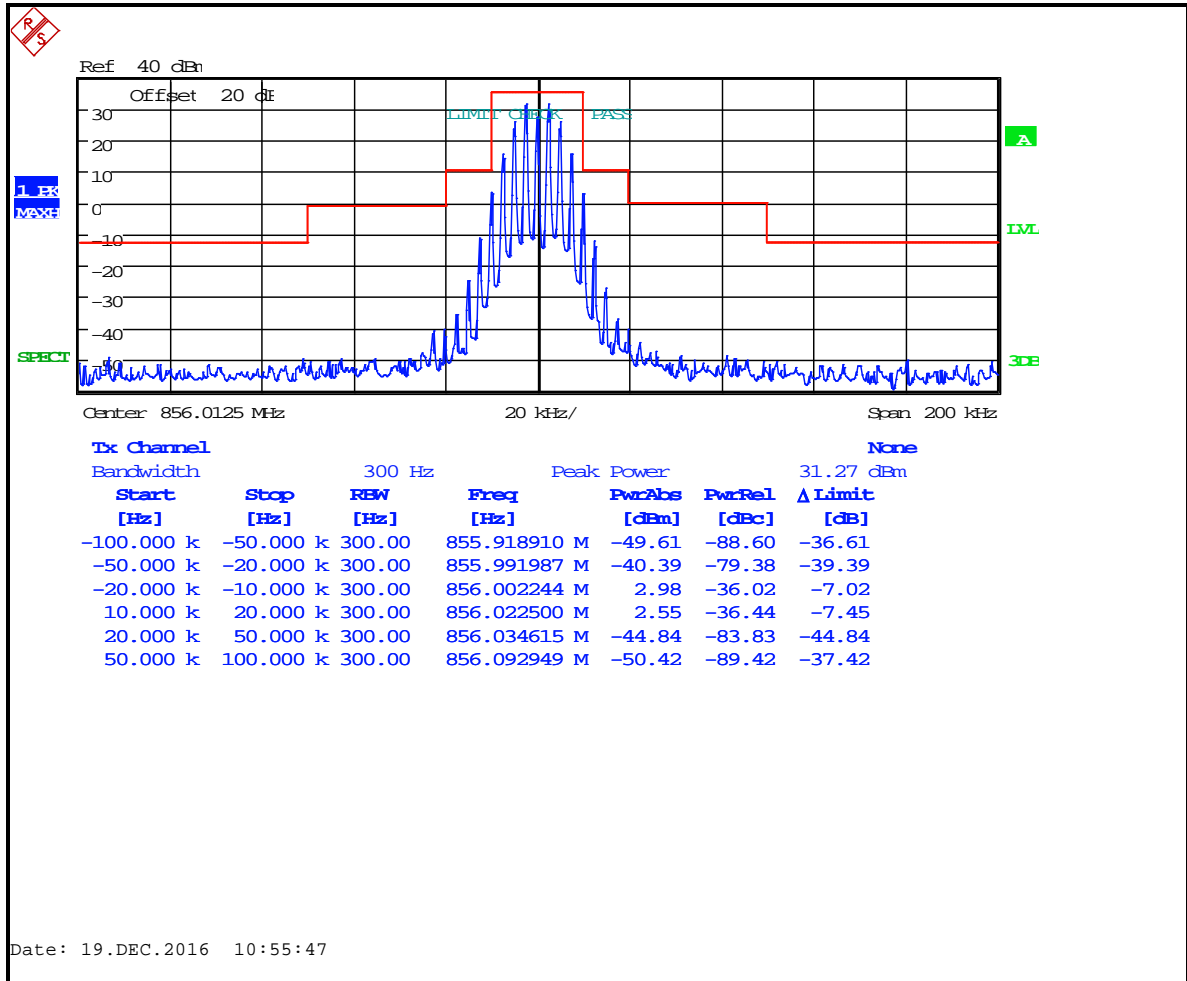

Plot 8-30: Occupied Bandwidth – 860.9875 MHz; WB Analog; Mask B

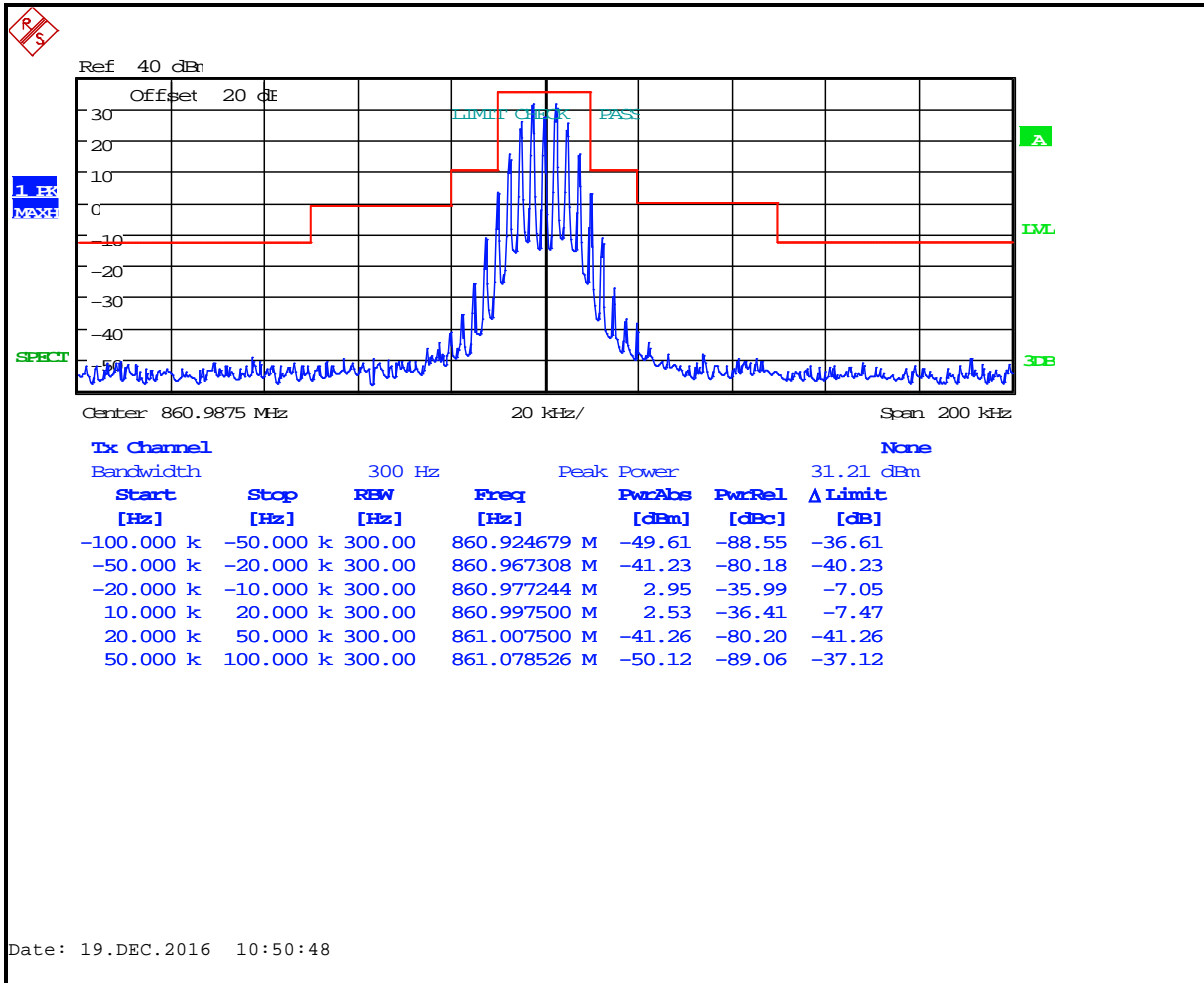

Plot 8-31: Occupied Bandwidth – 896.0125 MHz; 2-Level FSK 4800 XNB; Mask J

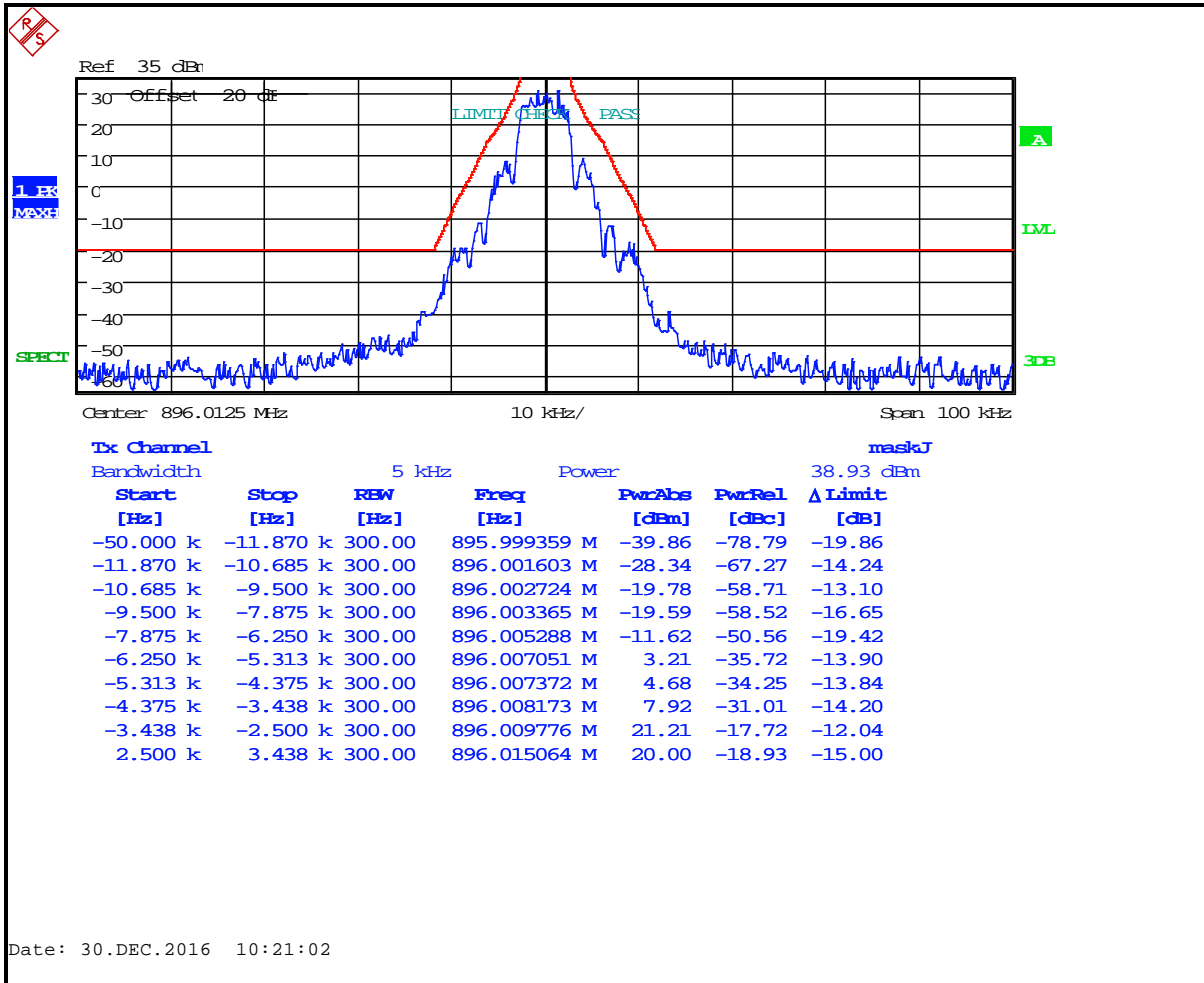

Plot 8-32: Occupied Bandwidth – 898.5 MHz; 2-Level FSK 4800 XNB; Mask J

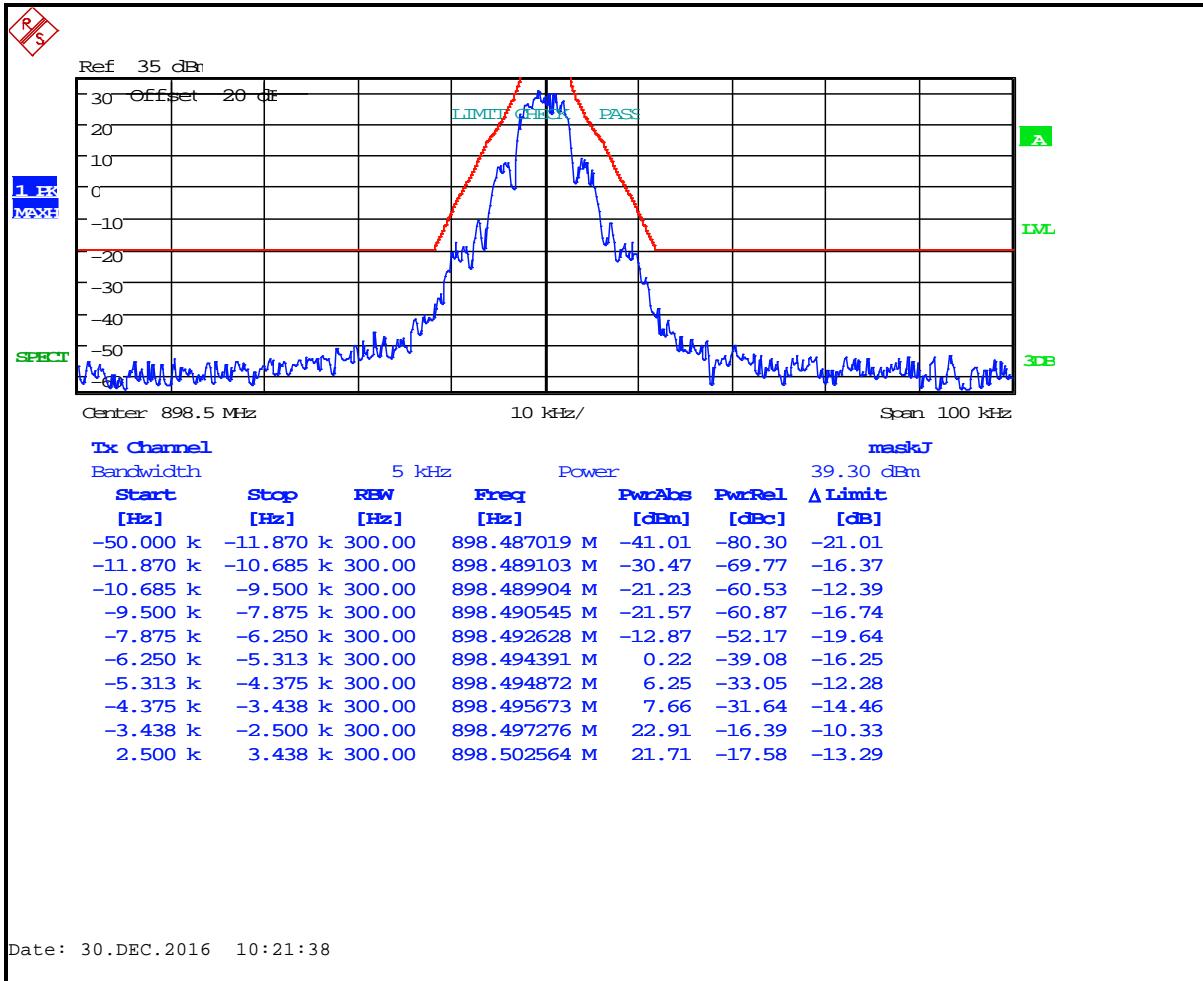

Plot 8-33: Occupied Bandwidth – 900.9875 MHz; 2-Level FSK 4800 XNB; Mask J

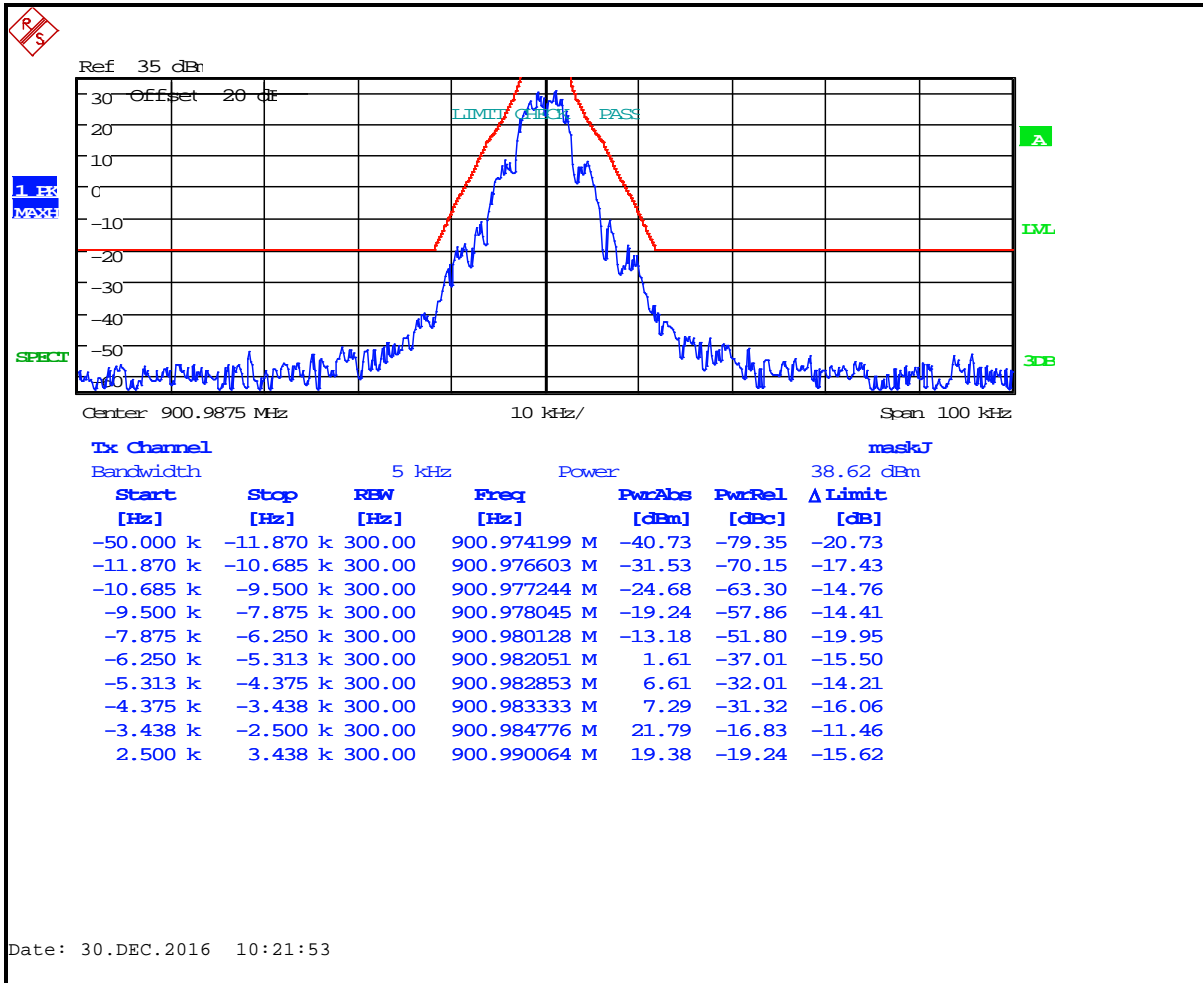

Plot 8-34: Occupied Bandwidth – 935.0125 MHz; 2-Level FSK 4800 XNB; Mask J

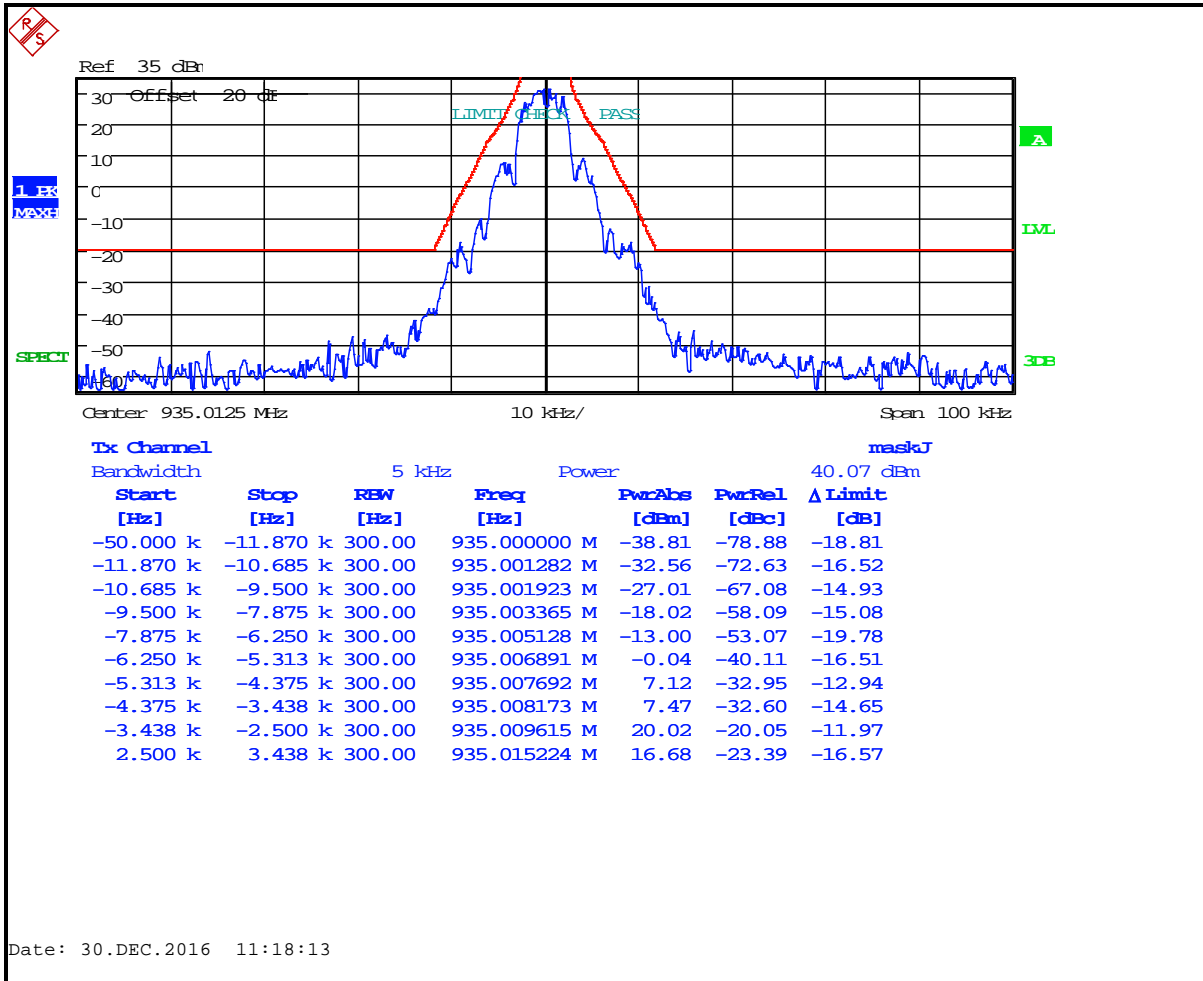

Plot 8-35: Occupied Bandwidth – 937.5 MHz; 2-Level FSK 4800 XNB; Mask J

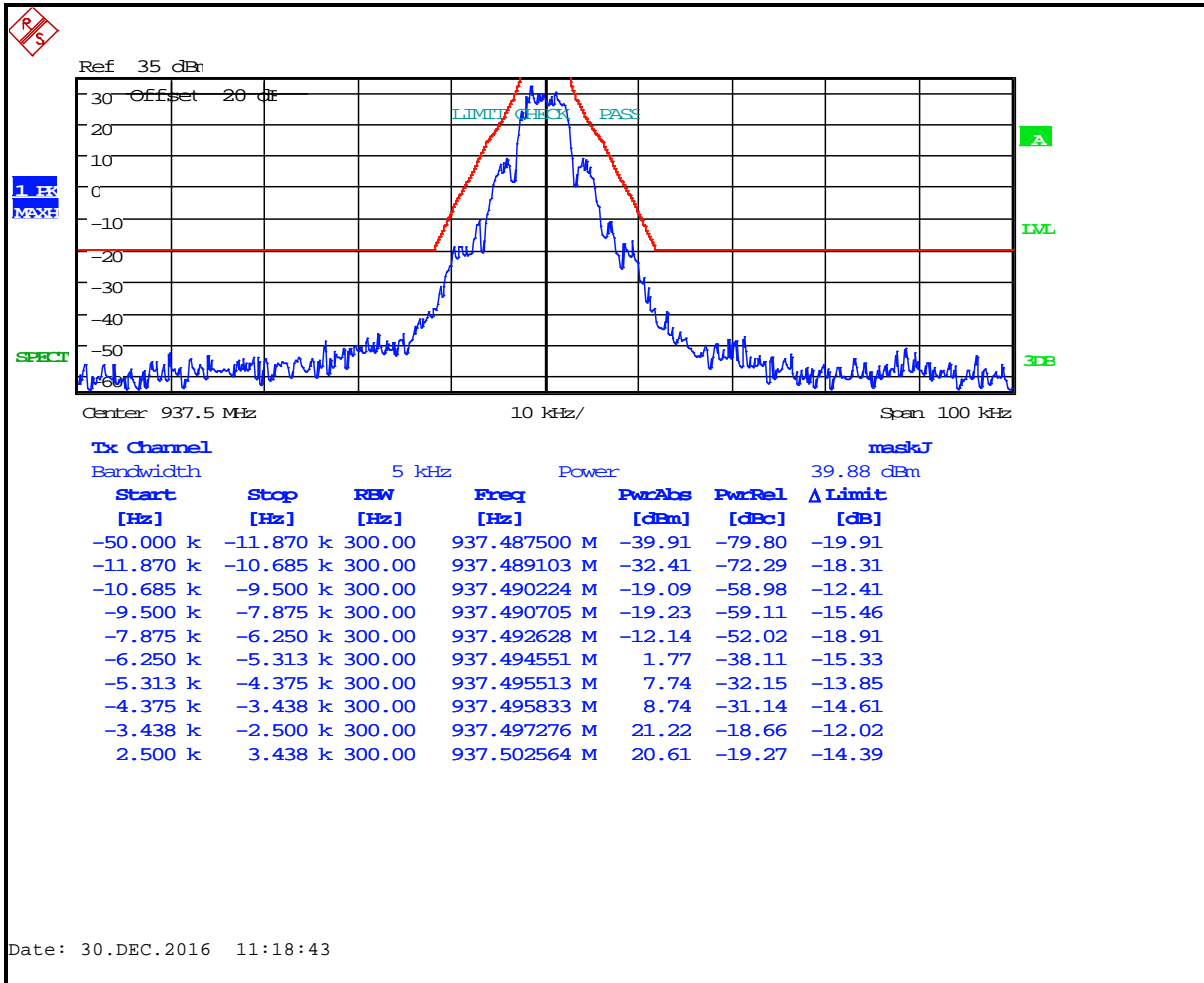

Plot 8-36: Occupied Bandwidth – 939.9875 MHz; 2-Level FSK 4800 XNB; Mask J

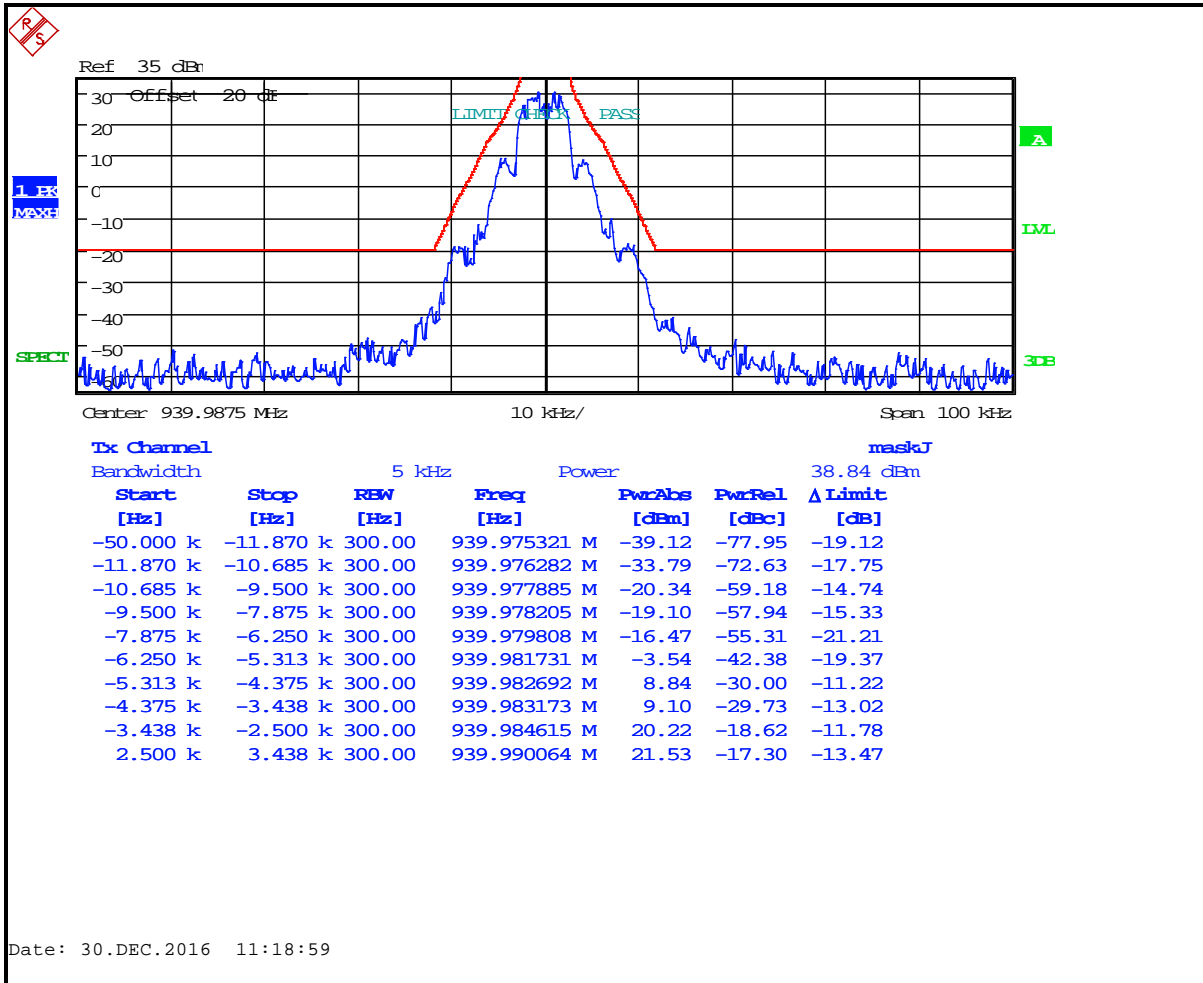

Plot 8-37: Occupied Bandwidth – 806.0125 MHz; 2-Level FSK 9600 NB; Mask H

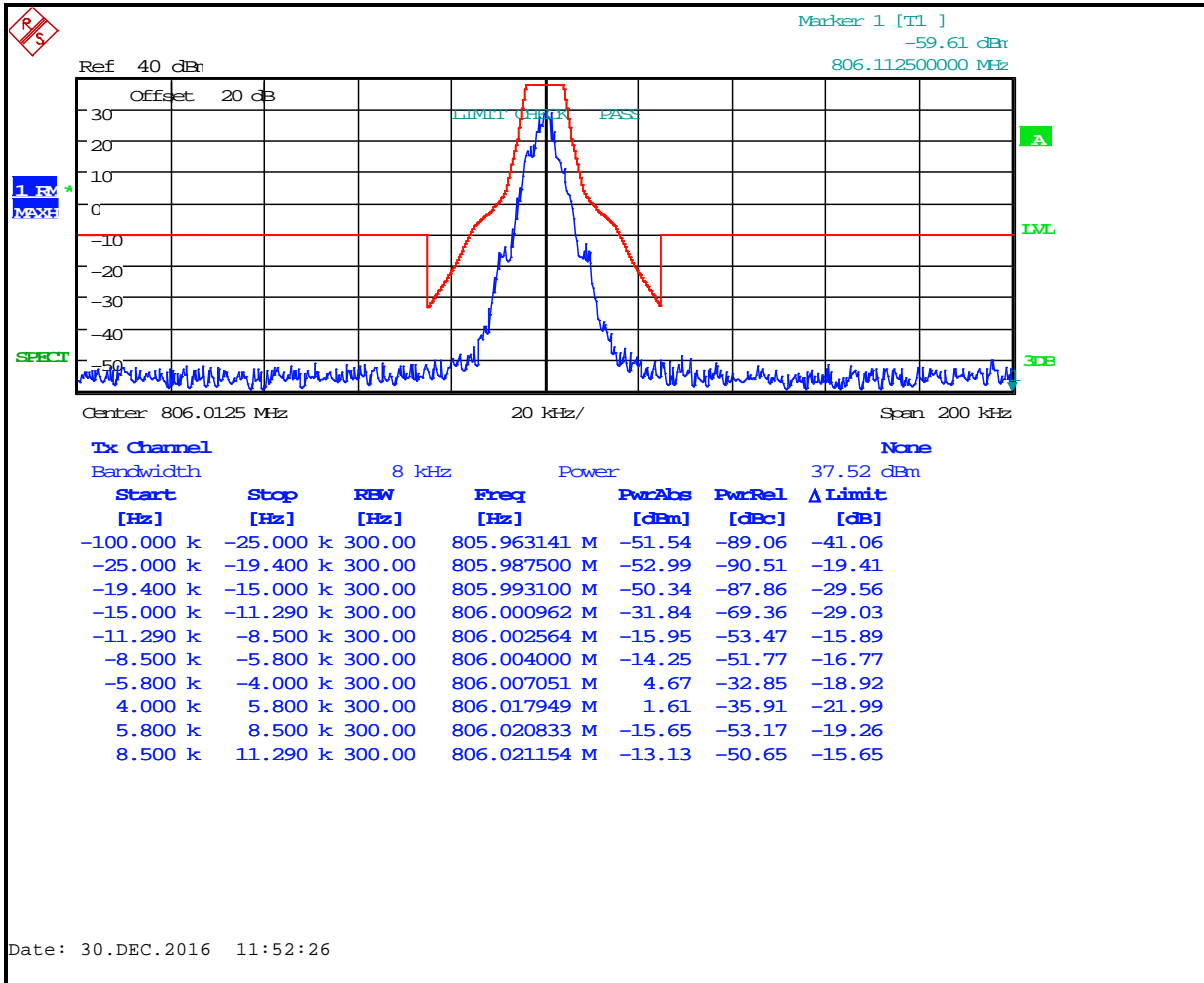

Plot 8-38: Occupied Bandwidth – 811.0125 MHz; 2-Level FSK 9600 NB; Mask G

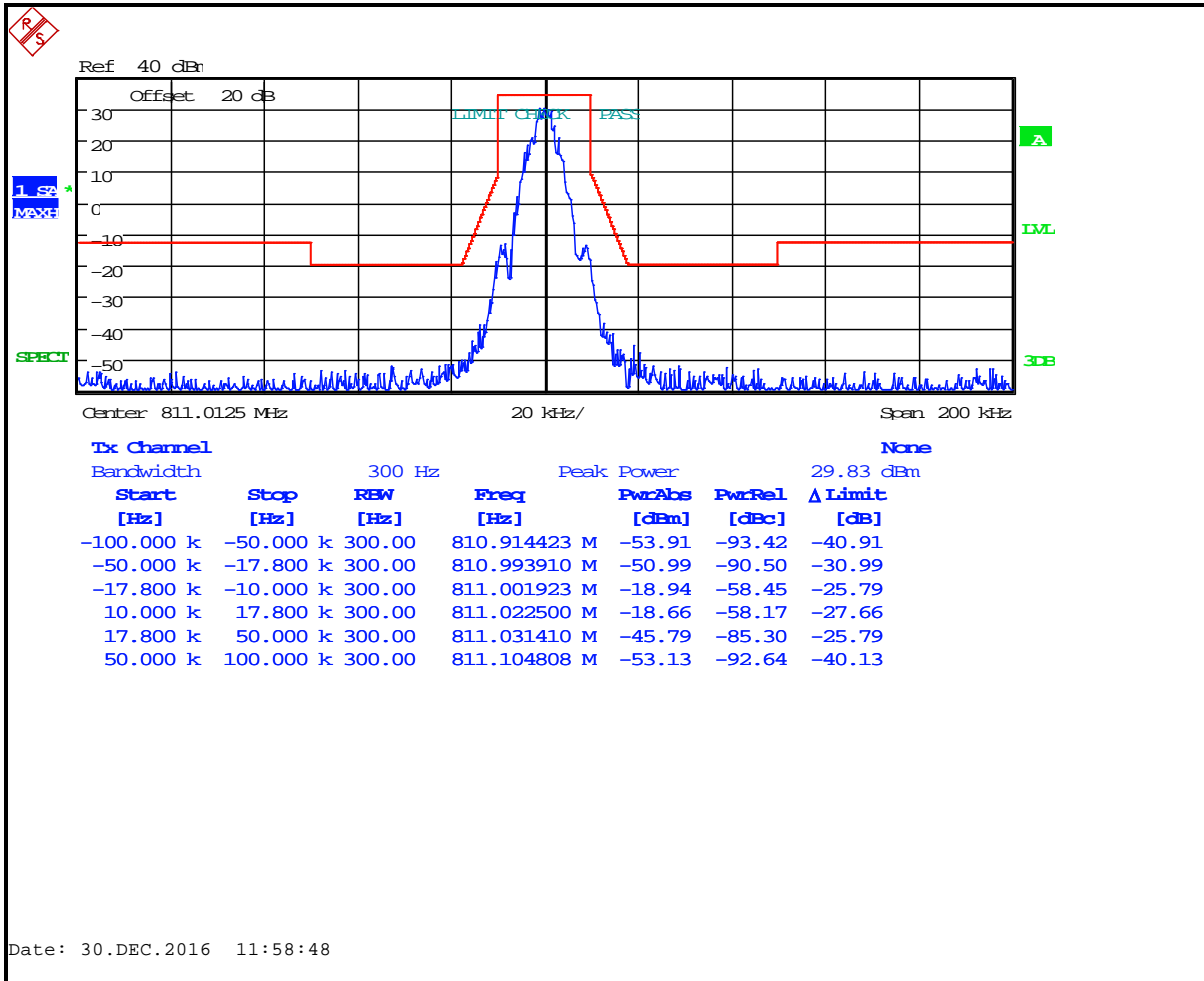

Plot 8-39: Occupied Bandwidth – 815.9875 MHz; 2-Level FSK 9600 NB; Mask G

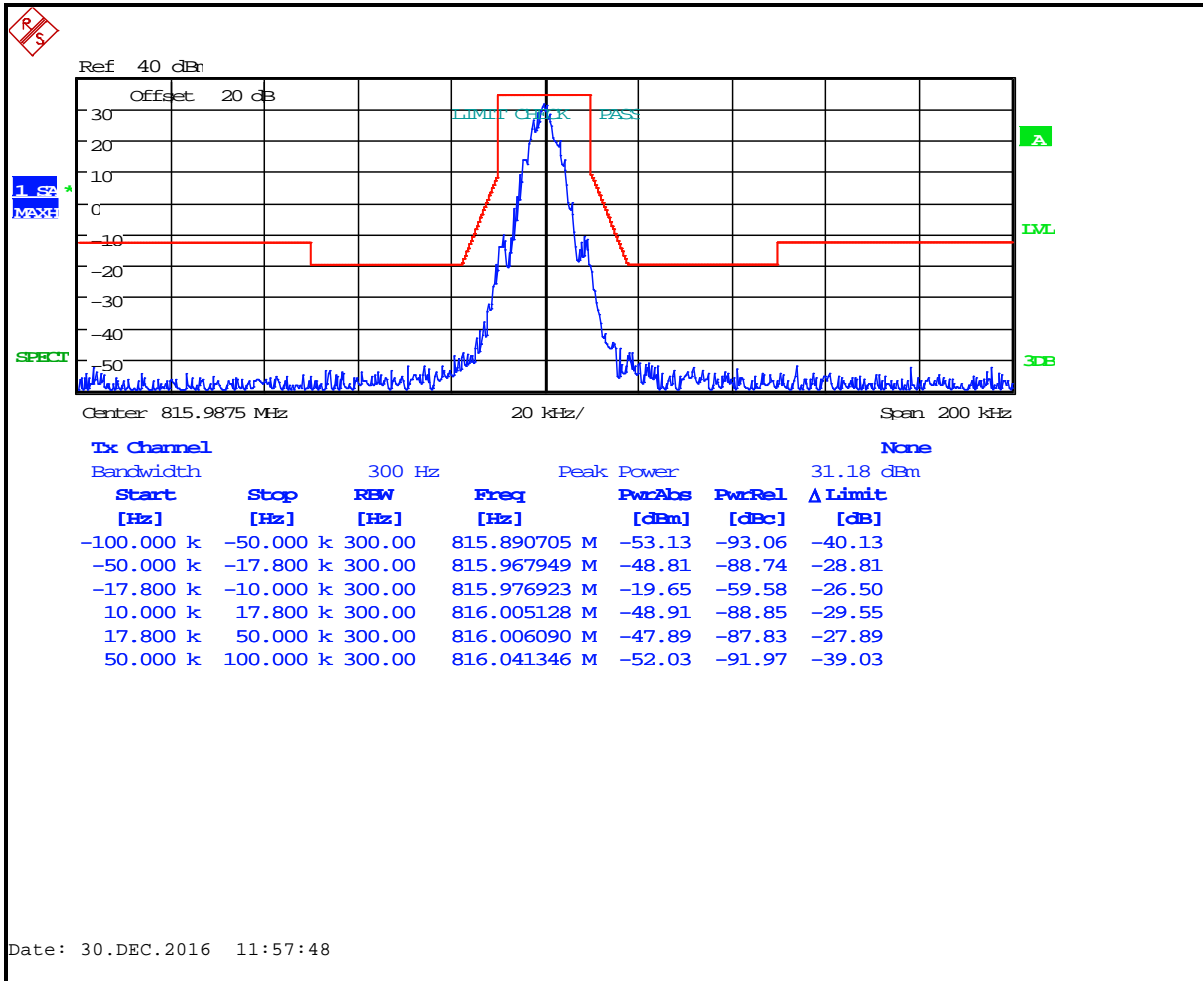

Plot 8-40: Occupied Bandwidth – 851.0125 MHz; 2-Level FSK 9600 NB; Mask H

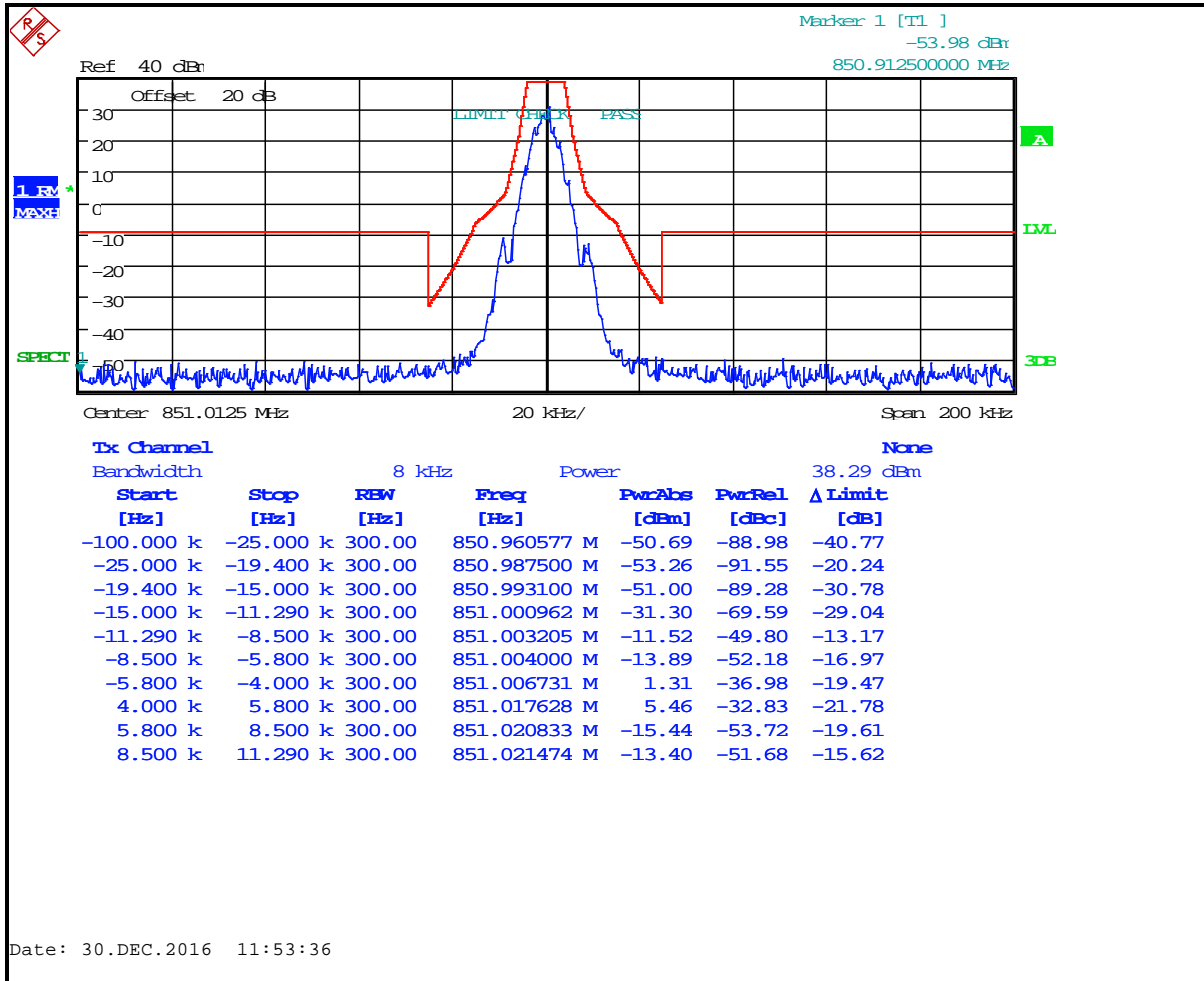

Plot 8-41: Occupied Bandwidth – 856.0125 MHz; 2-Level FSK 9600 NB; Mask G

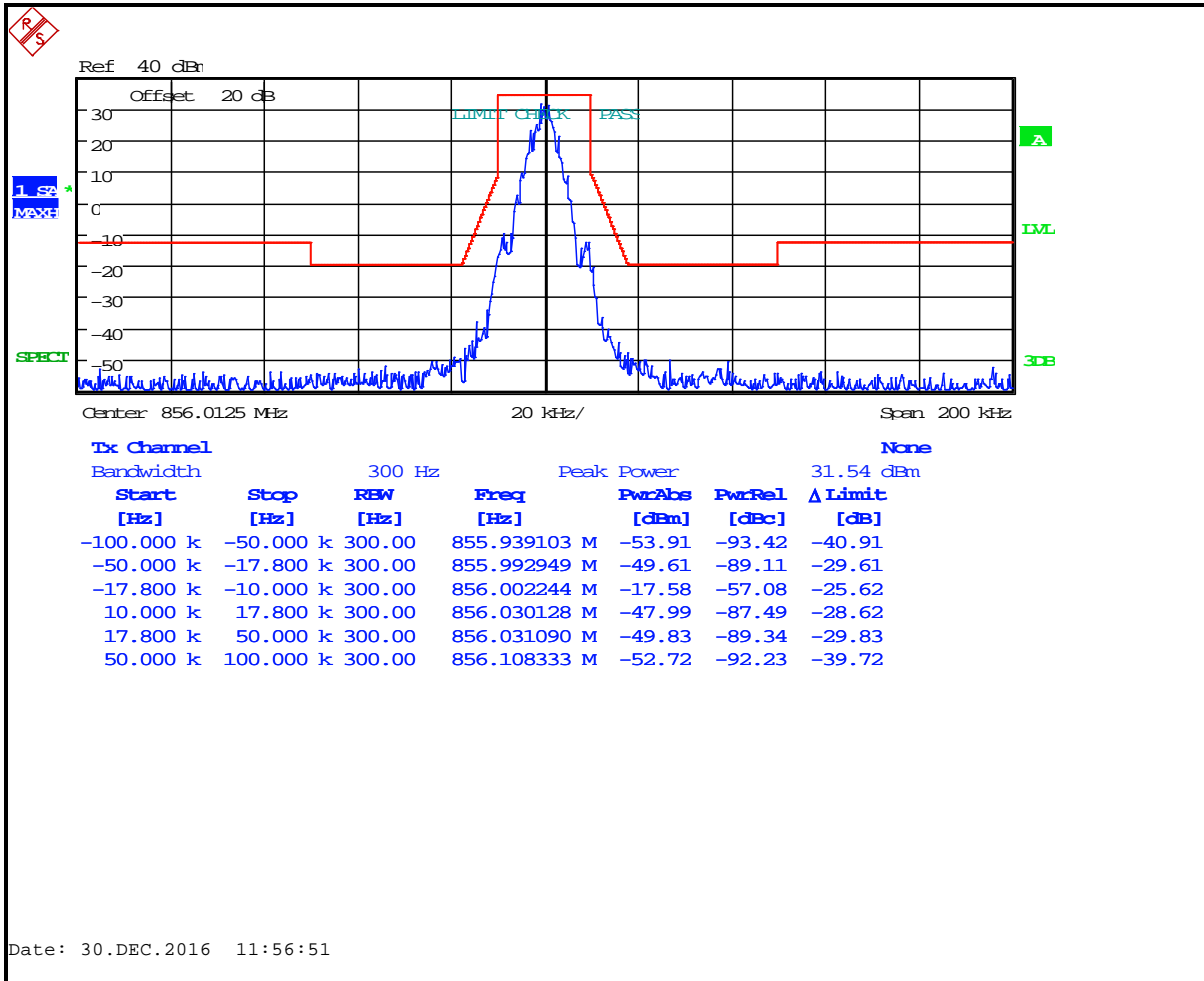

Plot 8-42: Occupied Bandwidth – 860.9875 MHz; 2-Level FSK 9600 NB; Mask G

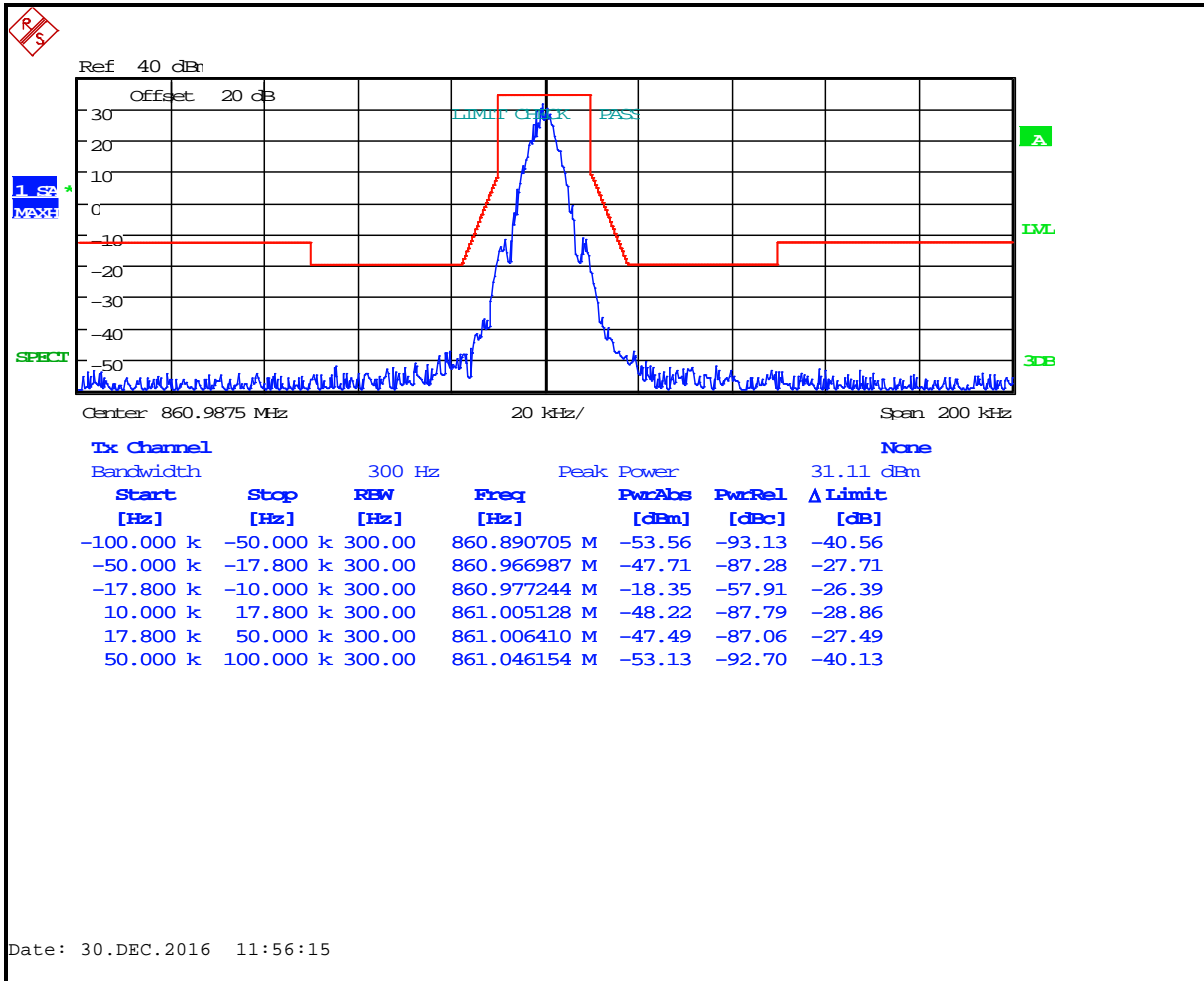

Plot 8-43: Occupied Bandwidth – 806.0125 MHz; 2-Level FSK 9600 NB; Mask D (IC)

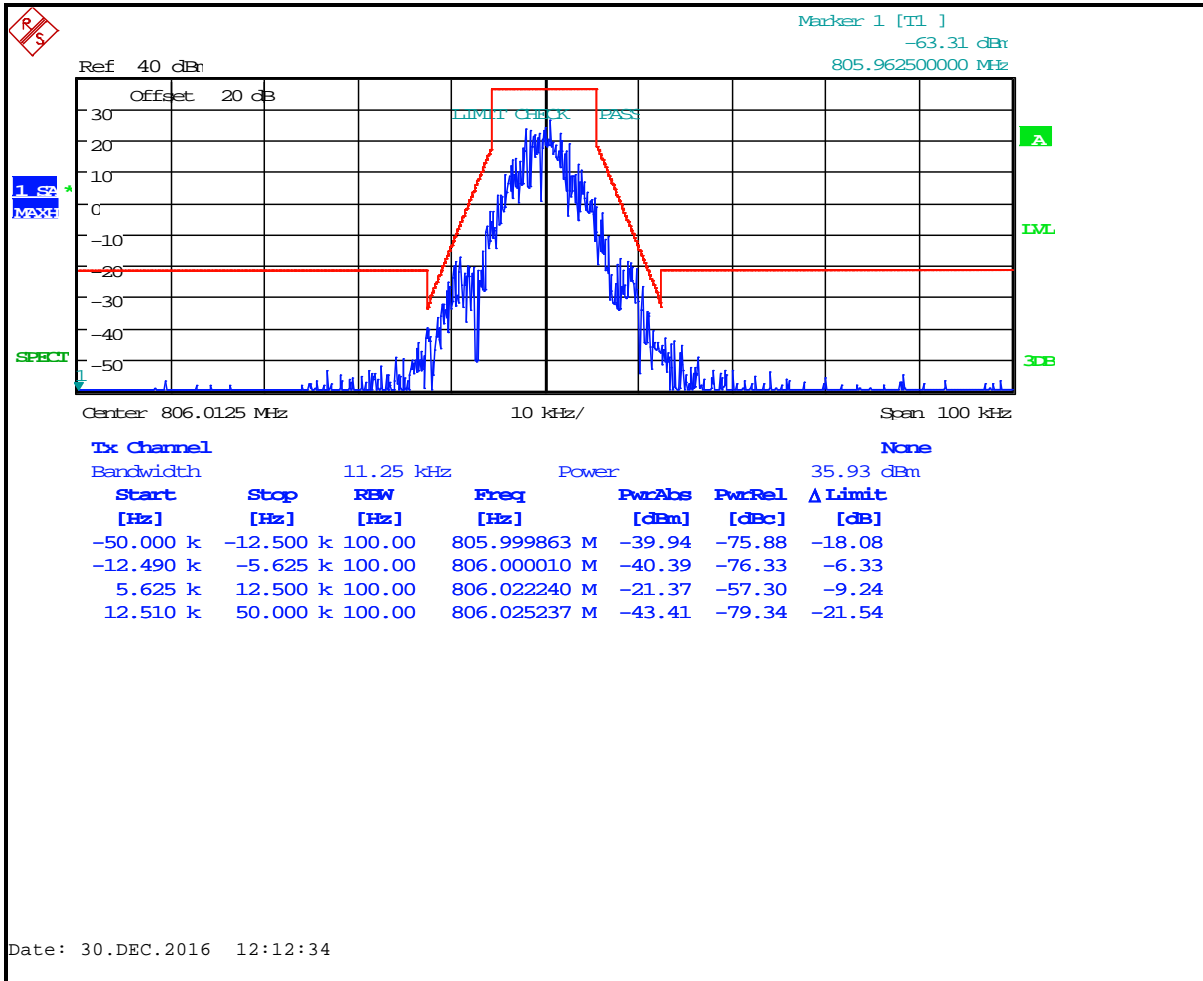

Plot 8-44: Occupied Bandwidth – 811.0125 MHz; 2-Level FSK 9600 NB; Mask D (IC)

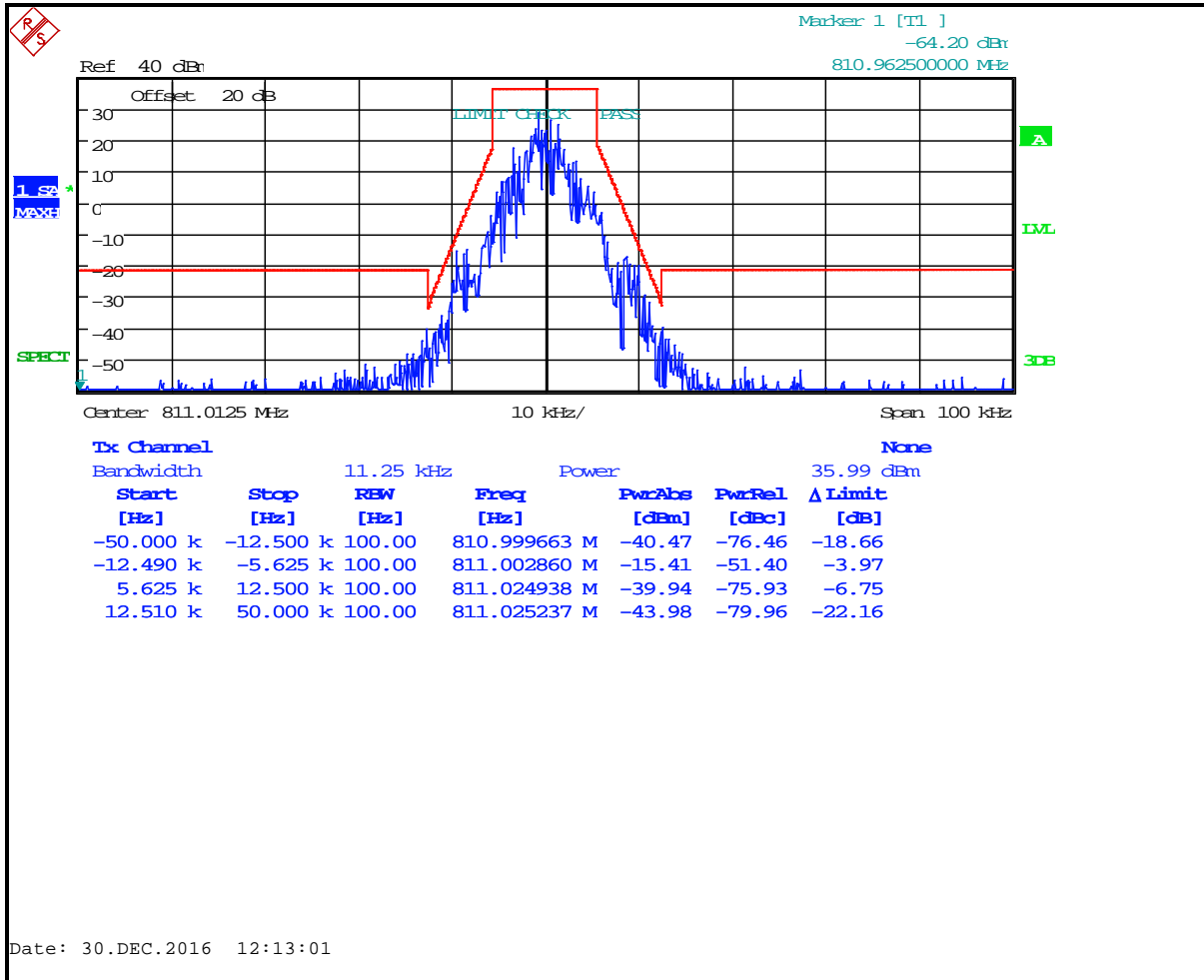

Plot 8-45: Occupied Bandwidth – 815.9875 MHz; 2-Level FSK 9600 NB; Mask D (IC)

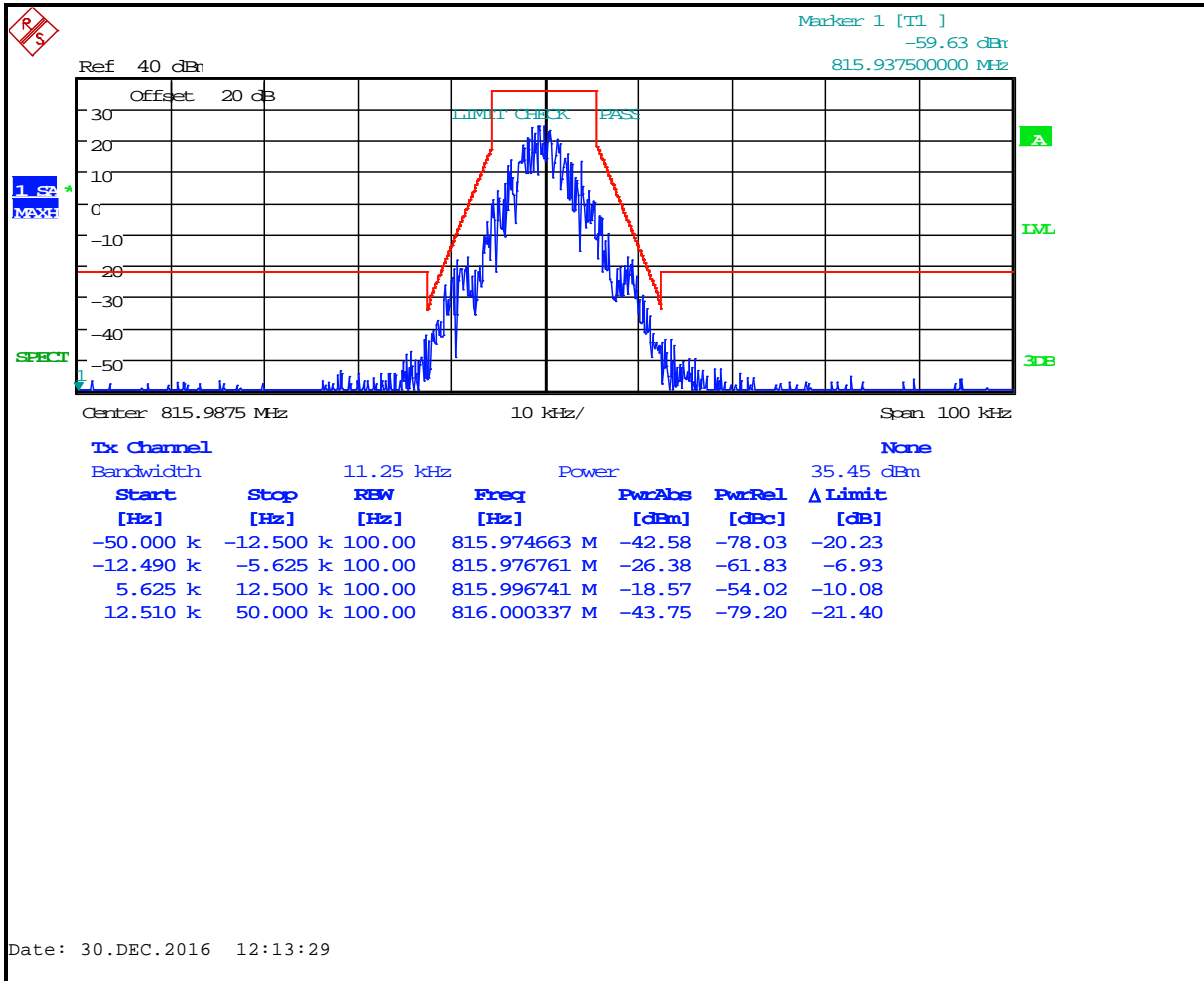

Plot 8-46: Occupied Bandwidth – 851.0125 MHz; 2-Level FSK 9600 NB; Mask D (IC)

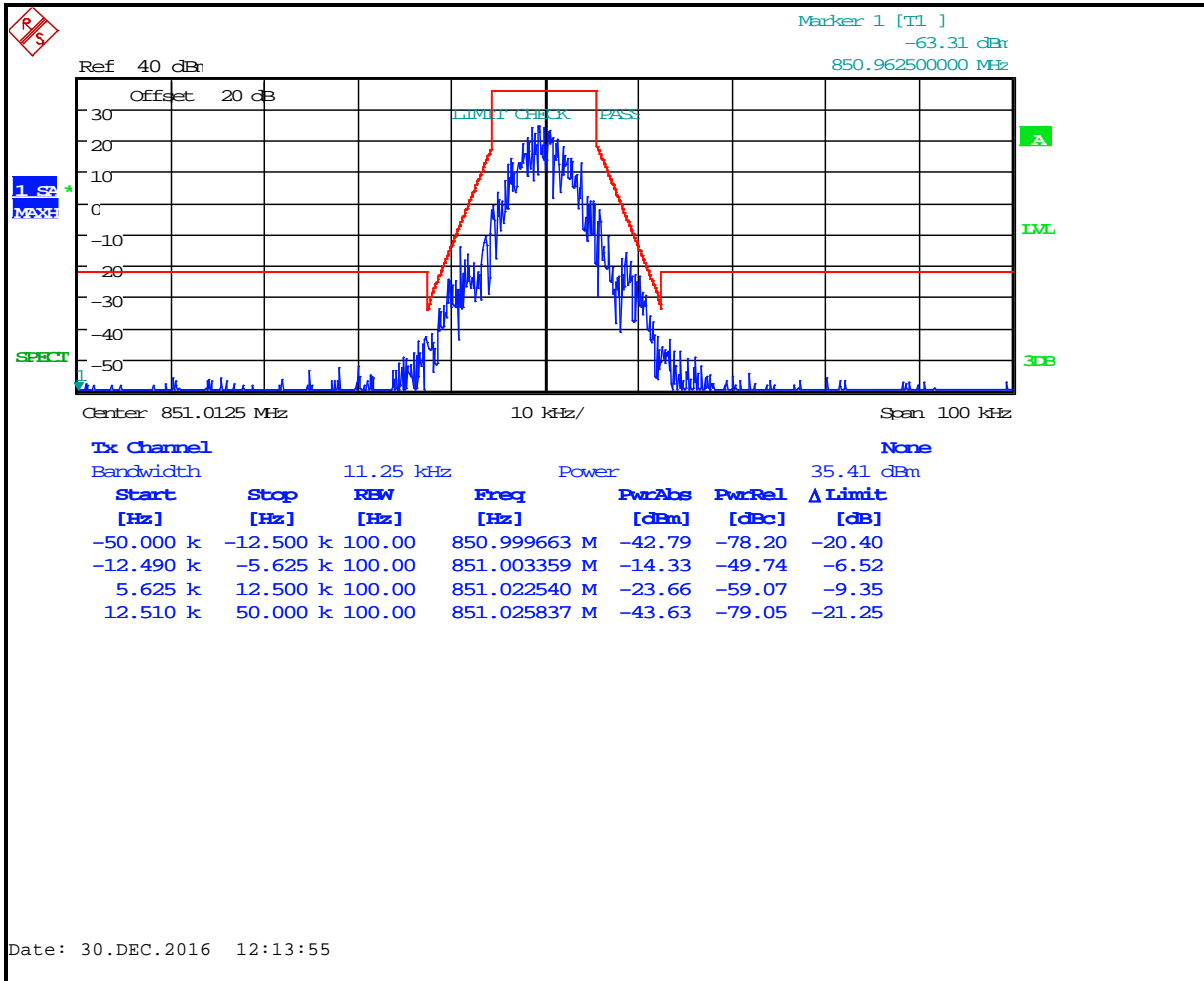

Plot 8-47: Occupied Bandwidth – 856.0125 MHz; 2-Level FSK 9600 NB; Mask D (IC)

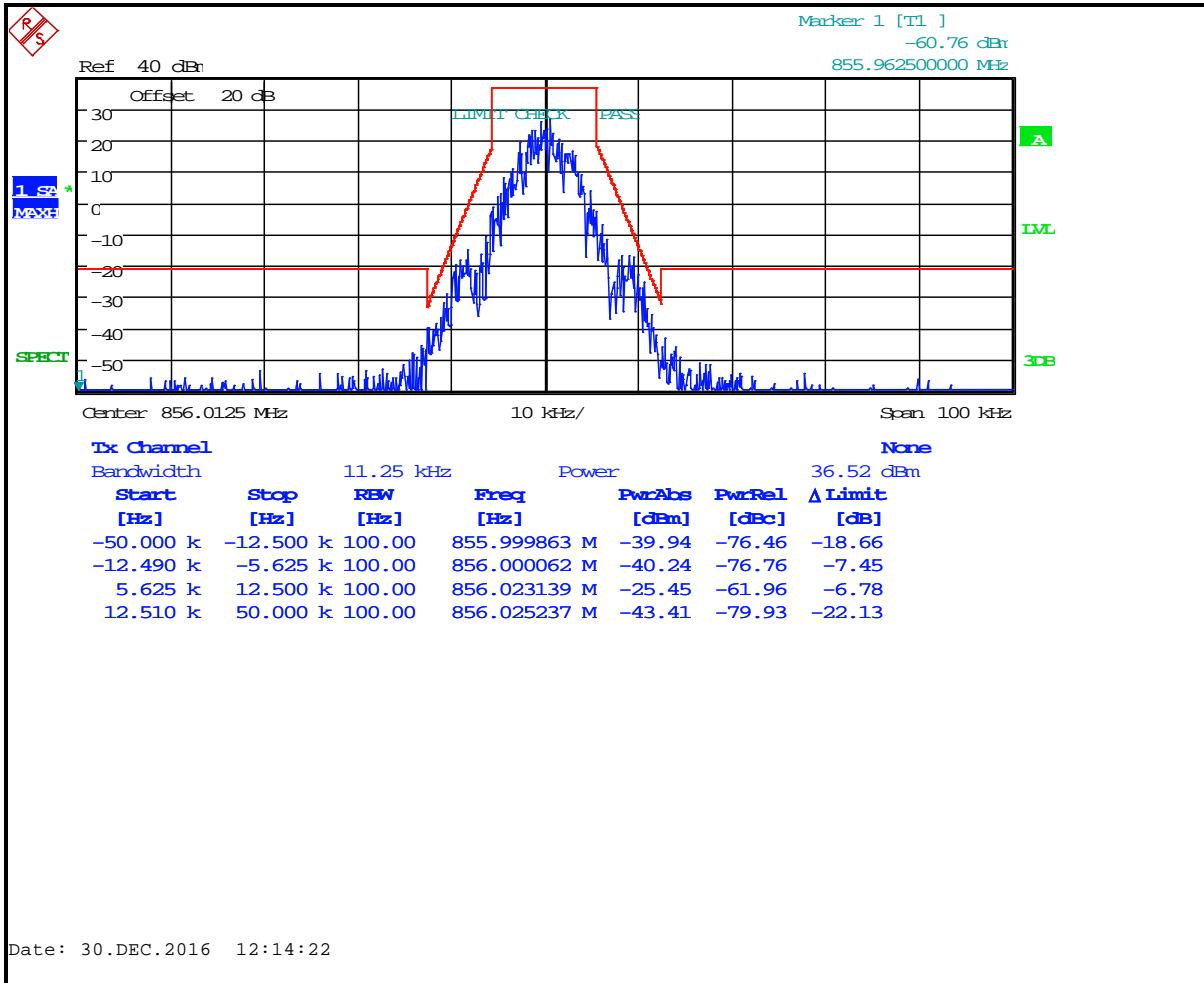

Plot 8-48: Occupied Bandwidth – 860.9875 MHz; 2-Level FSK 9600 NB; Mask D (IC)

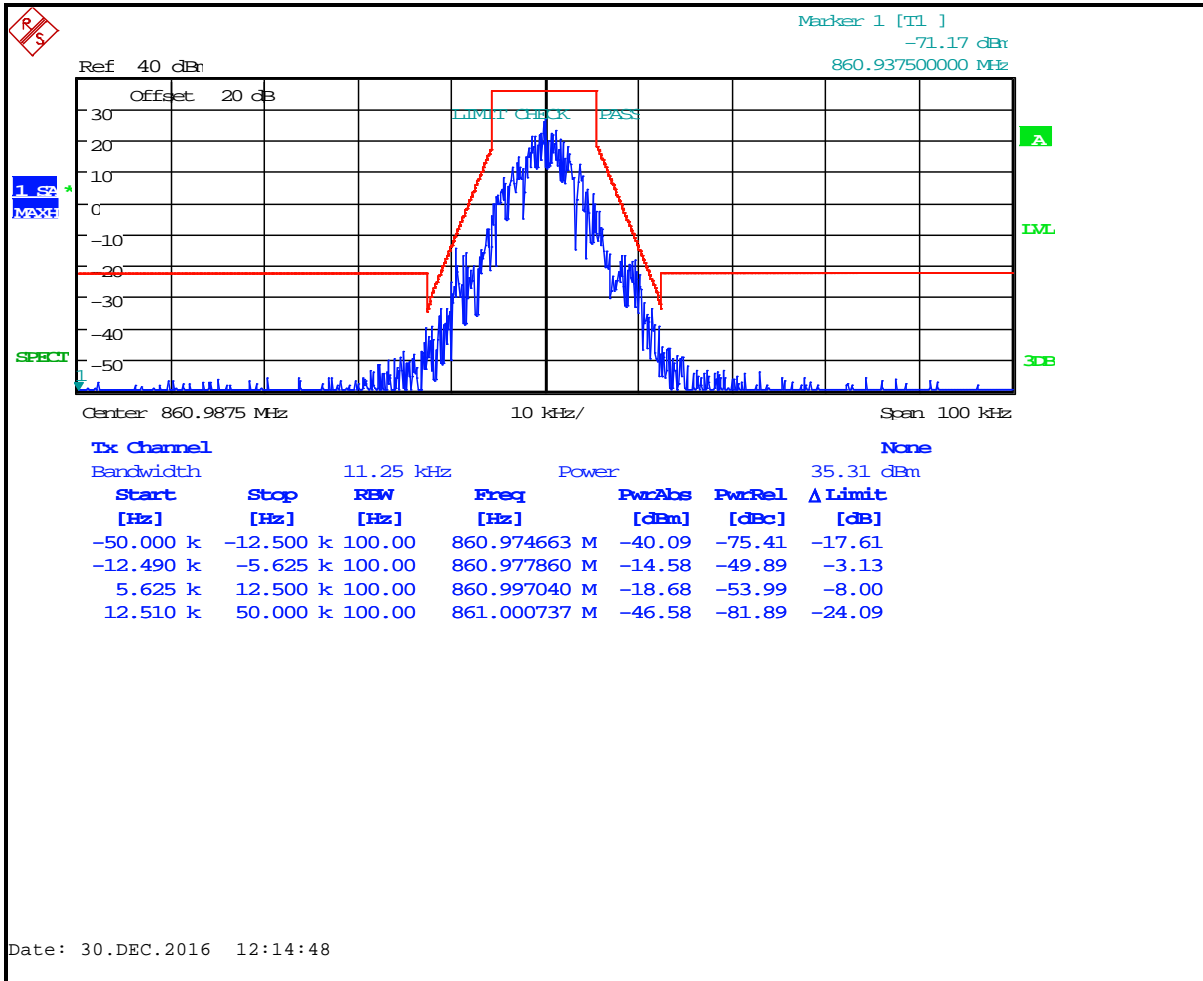

Plot 8-49: Occupied Bandwidth – 896.0125 MHz; 2-Level FSK 9600 NB; Mask J

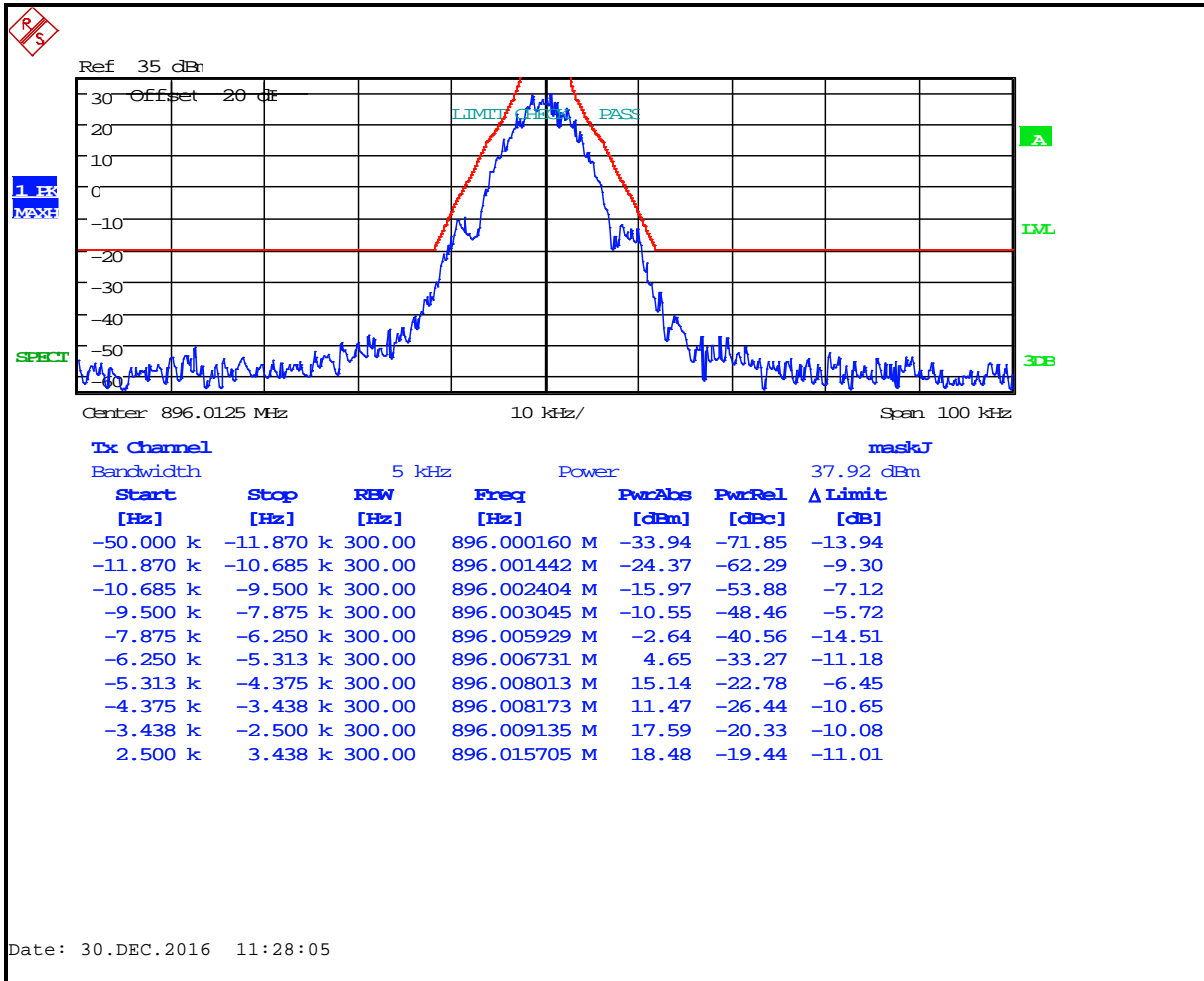

Plot 8-50: Occupied Bandwidth – 898.5 MHz; 2-Level FSK 9600 NB; Mask J

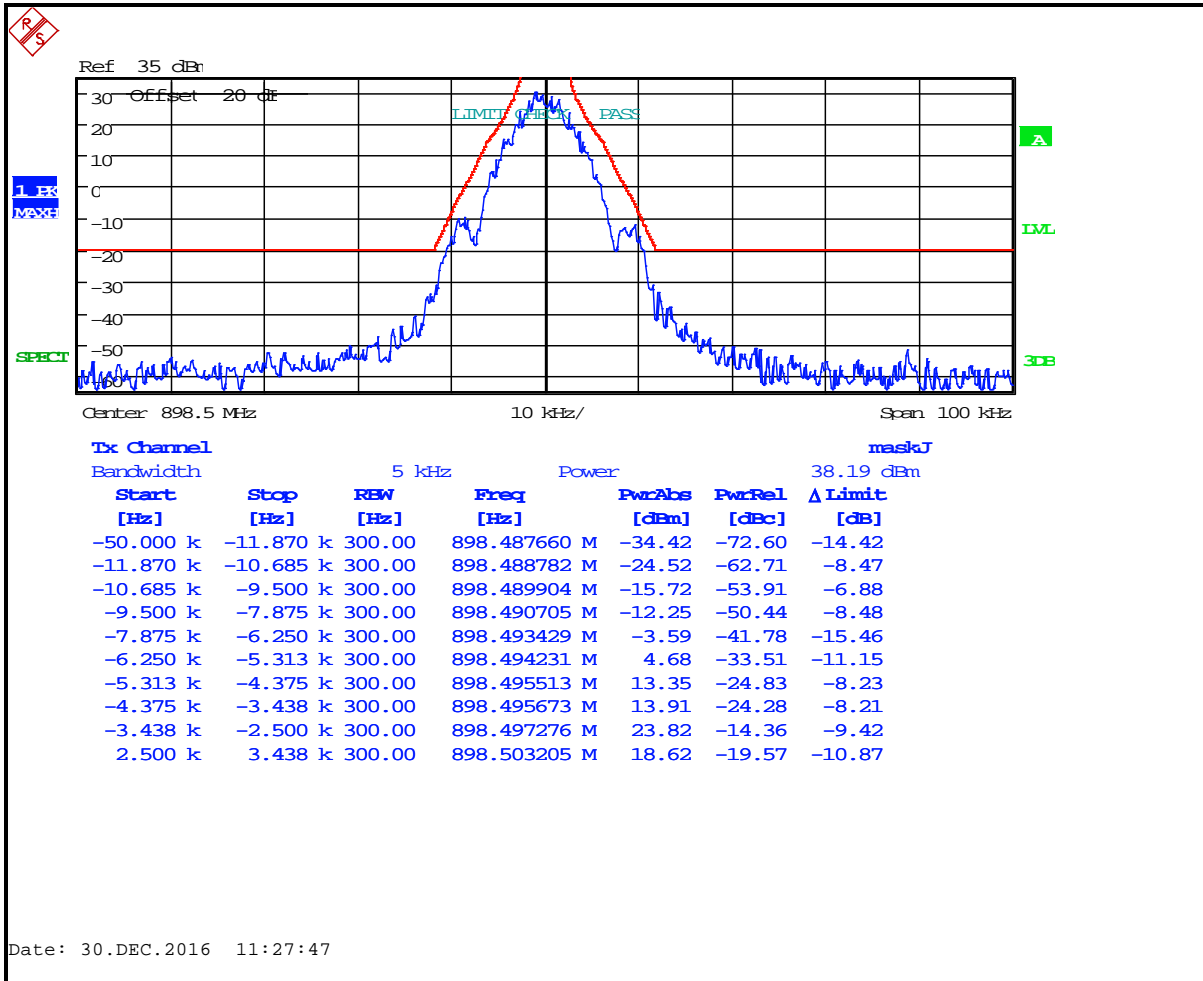

Plot 8-51: Occupied Bandwidth – 900.9875 MHz; 2-Level FSK 9600 NB; Mask J

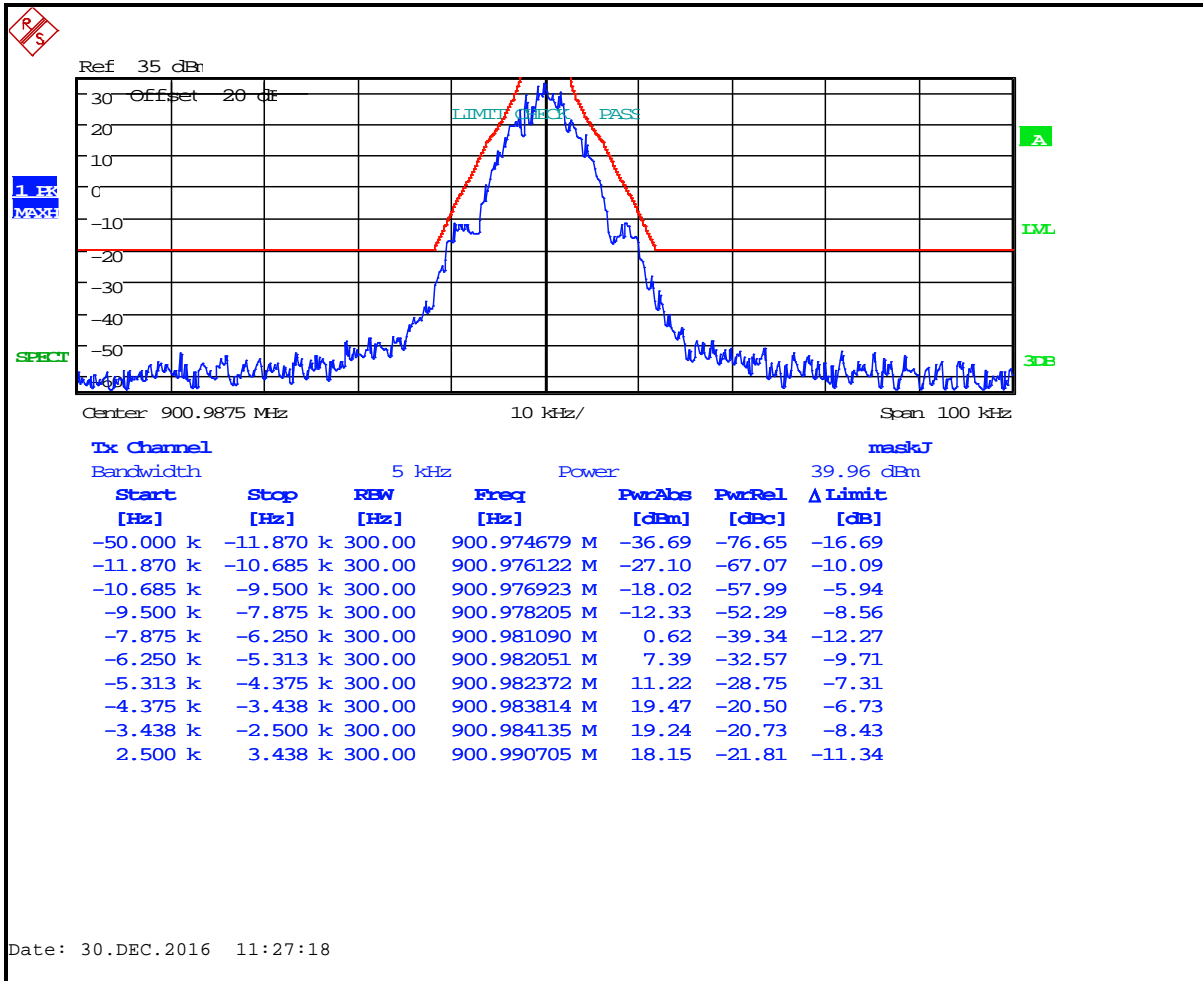

Plot 8-52: Occupied Bandwidth – 935.0125 MHz; 2-Level FSK 9600 NB; Mask J

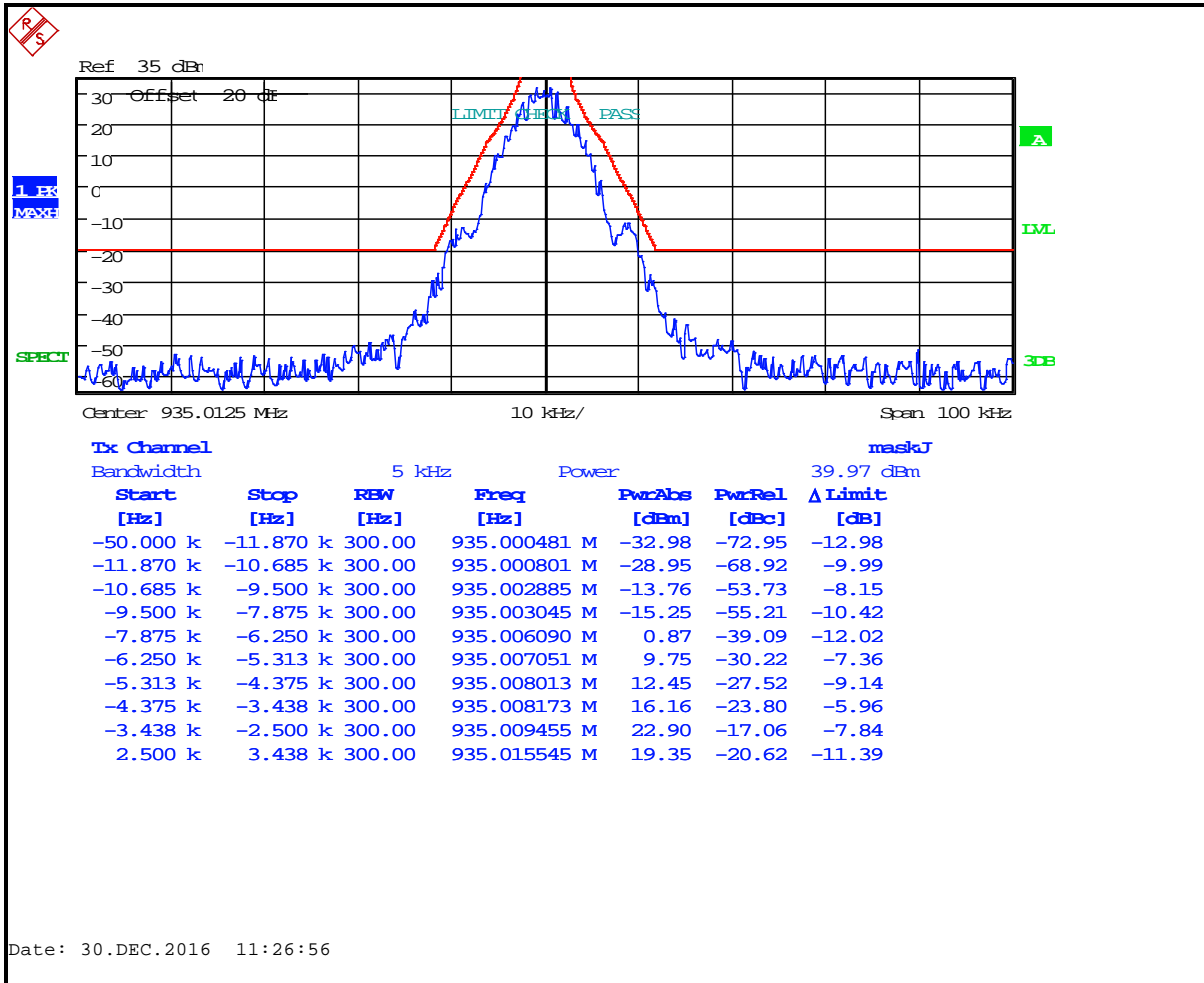

Plot 8-53: Occupied Bandwidth – 937.5 MHz; 2-Level FSK 9600 NB; Mask J

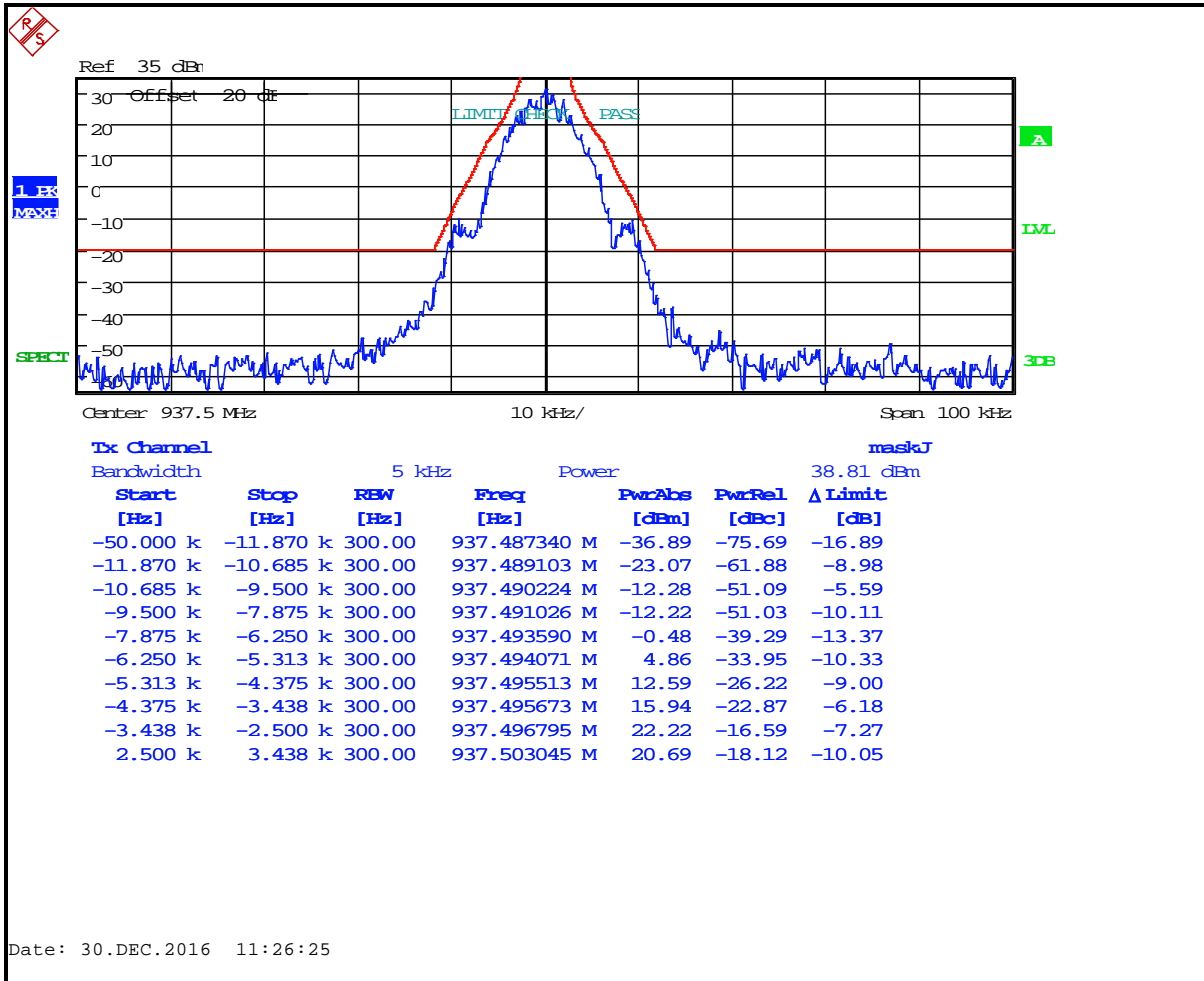

Plot 8-54: Occupied Bandwidth – 939.9875 MHz; 2-Level FSK 9600 NB; Mask J

