



Engineering Solutions & Electromagnetic Compatibility Services

**FCC & IC Certification Report for
FCC Part 15.247 & Industry Canada RSS-247**

| | | | |
|---|--|--|--|
| Test Lab: Rhein Tech Laboratories, Inc. 360 Herndon Parkway Suite 1400 Herndon, VA 20170 E-Mail: atcbinfo@rheintech.com | | Applicant: Harris Corporation 221 Jefferson Ridge Parkway Lynchburg, VA 24501 Tel: 434-455-9290 | |
| FCC ID/ IC OWDTR-0140-E 3636B-0140 | | Test Report Date: July 20, 2016 | |
| Platform N/A | | RTL Work Order # 2015076 | |
| Model XG-25P | | RTL Quote # QRTL15-025A | |
| American National Standard Institute | | ANSI C63.10-2013: American National Standard of Procedures for Compliance Testing of Unlicensed Wireless Devices | |
| FCC Classification | | DSS – Part 15 Spread Spectrum Transmitter | |
| FCC Rule Part(s)/Guidance | | FCC Rules Part 15.247: Operation within the bands 902-928 MHz, 2400-2483.5 MHz and 5725-5850 MHz Direct Sequence System (10/01/2015) | |
| Industry Canada | | RSS-247 Issue 1 Digital Transmission Systems (DTSS), Frequency Hopping Systems (FHSS) and Licence-Exempt Local Area Network (LE-LAN) Devices | |
| Digital Interface Information | | Digital Interface was found to be compliant | |
| Frequency Range (MHz) | | Emission Designator | |
| 2402 – 2480 | | 1M43FXD | |
| Output Power (W)* | | Frequency Tolerance | |
| 0.0011 | | N/A | |

* power is conducted

I, the undersigned, hereby declare that the equipment tested and referenced in this report conforms to the identified standard(s) as described in this test report. No modifications were made to the equipment during testing in order to achieve compliance with these standards. Furthermore, there was no deviation from, additions to, or exclusions from, the applicable parts of FCC Part 2, FCC Part 15, Industry Canada RSS-247, RSS-Gen, and ANSI C63.10.

Signature: 

Date: July 20, 2016

Typed/Printed Name: Desmond A. Fraser

Position: President

This report may not be reproduced, except in full, without the full written approval of Rhein Tech Laboratories, Inc. and Harris Corporation. Test results relate only to the item tested.

This/these test(s) is/are accredited under Rhein Tech Laboratories, Inc. ISO/IEC 17025 accreditation issued by the ANSI-ASQ National Accreditation Board. Refer to certificate and scope of accreditation AT-1445.

Table of Contents

| | | |
|------|---|----|
| 1 | General Information | 5 |
| 1.1 | Scope | 5 |
| 1.2 | Description of EUT | 5 |
| 1.3 | Test Facility | 5 |
| 1.4 | Related Submittal(s)/Grant(s) | 5 |
| 1.5 | Modifications | 5 |
| 2 | Test Information | 6 |
| 2.1 | Description of Test Modes | 6 |
| 2.2 | Exercising the EUT | 6 |
| 2.3 | Test Result Summary..... | 6 |
| 2.4 | Tested System Details | 7 |
| 3 | Peak Output Power – FCC 15.247(b)(1), RSS-247 5.4(2), RSS-Gen 6.12..... | 9 |
| 3.1 | Power Output Test Procedure | 9 |
| 3.2 | Power Output Test Data..... | 9 |
| 4 | Duty Cycle Correction..... | 10 |
| 5 | Antenna Conducted Spurious Emissions – FCC 15.247(d), RSS-247 5.5 | 12 |
| 6 | Band-Edge Compliance of RF Conducted Emissions – FCC 15.247(d), RSS-247 5.5 | 12 |
| 6.1 | Band Edge Test Procedure..... | 12 |
| 6.2 | Test Results | 13 |
| 6.3 | Radiated Band Edge Emissions | 17 |
| 7 | 20 dB Bandwidth – FCC 15.247(a)(1), RSS-247 5.1(1) | 18 |
| 7.1 | 20 dB Bandwidth Test Procedure | 18 |
| 7.2 | 20 dB Modulated Bandwidth Test Data | 18 |
| 7.3 | 20 dB Bandwidth Plots | 19 |
| 8 | Carrier Frequency Separation - 15.247(a)(1), RSS-247 5.1(2) | 28 |
| 8.1 | Carrier Frequency Separation Test Procedure | 28 |
| 8.2 | Carrier Frequency Separation Test Data | 28 |
| 9 | Hopping Characteristics – FCC 15.247(a)(1)(iii), RSS-247 5.1(4) | 29 |
| 9.1 | Hopping Characteristics Test Procedure | 29 |
| 9.2 | Number of Hopping Frequencies | 29 |
| 9.3 | Average Time of Occupancy..... | 30 |
| 10 | Radiated Emissions Test Results - FCC Rules and Regulations Part 15.247(d); RSS-247 2.2 | 32 |
| 10.1 | Limits of Radiated Emissions Measurement..... | 32 |
| 10.2 | Radiated Emissions Measurement Test Procedure | 32 |
| 10.3 | Radiated Emissions Harmonics/Spurious Test Data | 33 |
| 11 | Conclusion | 36 |

Figure Index

| | |
|---|---|
| Figure 2-1: Configuration of Tested System..... | 8 |
|---|---|

Table Index

| | |
|---|----|
| Table 2-1: Channels Tested | 6 |
| Table 2-2: Test Result Summary – FCC Part 15, Subpart C (Section 15.247) / IC RSS-247 | 6 |
| Table 2-3: Equipment Under Test (EUT)..... | 7 |
| Table 2-4: Accessory Test Equipment | 7 |
| Table 3-1: Power Output Test Data..... | 9 |
| Table 3-2: Power Output Test Equipment | 9 |
| Table 4-1: Duty Cycle Test Equipment..... | 11 |
| Table 5-1: Antenna Conducted Spurious Emissions Test Equipment | 12 |
| Table 6-1: Band-Edge Compliance of RF Conducted Emissions Test Equipment | 16 |
| Table 6-2: Radiated Band Edge Emissions Test Data | 17 |
| Table 6-3: Radiated Band Edge Test Equipment..... | 17 |
| Table 7-1: 20 dB Modulated Bandwidth Test Data – GFSK (1 Mbps) | 18 |
| Table 7-2: 20 dB Modulated Bandwidth Test Data – 2-EDR (2 Mbps) | 18 |
| Table 7-3: 20 dB Modulated Bandwidth Test Data – 3-EDR (3 Mbps) | 18 |
| Table 7-4: 20 dB Bandwidth Test Equipment..... | 27 |
| Table 9-1: Hopping Characteristics Test Equipment..... | 31 |
| Table 10-1: Radiated Emissions Harmonics/Spurious - 2402 MHz - Average | 33 |
| Table 10-2: Radiated Emissions Harmonics/Spurious - 2402 MHz - Peak..... | 33 |
| Table 10-3: Radiated Emissions Harmonics/Spurious - 2441 MHz - Average | 33 |
| Table 10-4: Radiated Emissions Harmonics/Spurious – 2441 MHz - Peak..... | 34 |
| Table 10-5: Radiated Emissions Harmonics/Spurious - 2480 MHz - Average | 34 |
| Table 10-6: Radiated Emissions Harmonics/Spurious – 2480 MHz - Peak..... | 34 |
| Table 10-7: Radiated Emissions Harmonics/Spurious – Peak Hopping Mode | 35 |
| Table 10-8: Radiated Emissions Harmonics/Spurious - Average Hopping Mode..... | 35 |
| Table 10-9: Radiated Emissions Test Equipment | 36 |

Plot Index

| | | |
|-----------|---|----|
| Plot 4-1: | Pulse Width – 2.86ms | 10 |
| Plot 4-2: | Single Pulse per 100ms | 11 |
| Plot 6-1: | Lower Band Edge TX Frequency - 2402 MHz | 13 |
| Plot 6-2: | Lower Band Edge TX Frequency - 2402 MHz (Hopping) | 14 |
| Plot 6-3: | Upper Band Edge TX Frequency - 2480 MHz | 15 |
| Plot 6-4: | Upper Band Edge TX Frequency - 2480 MHz (Hopping) | 16 |
| Plot 7-1: | 20 dB Bandwidth - 2402 MHz; GFSK..... | 19 |
| Plot 7-2: | 20 dB Bandwidth - 2402 MHz; 2-EDR..... | 20 |
| Plot 7-3: | 20 dB Bandwidth - 2402 MHz; 3-EDR..... | 21 |
| Plot 7-4: | 20 dB Bandwidth - 2441 MHz; GFSK..... | 22 |
| Plot 7-5: | 20 dB Bandwidth - 2441 MHz; 2-EDR..... | 23 |
| Plot 7-6: | 20 dB Bandwidth - 2441 MHz; 3-EDR..... | 24 |
| Plot 7-7: | 20 dB Bandwidth - 2480 MHz; GFSK..... | 25 |
| Plot 7-8: | 20 dB Bandwidth - 2480 MHz; 2-EDR..... | 26 |
| Plot 7-9: | 20 dB Bandwidth - 2480 MHz; 3-EDR..... | 27 |
| Plot 8-1: | Carrier Frequency Separation..... | 28 |
| Plot 9-1: | Number of Hopping Frequencies (2402 - 2480 MHz) | 29 |
| Plot 9-2: | Time of Occupancy (Dwell Time) | 30 |
| Plot 9-3: | Number of Pulses in 31.6 Second Sweep | 31 |

Appendix Index

| | |
|------------------------------------|----|
| Appendix A: Test Photographs | 37 |
|------------------------------------|----|

Photograph Index

| | | |
|---------------|---|----|
| Photograph 1: | Radiated Emissions – Front View | 37 |
| Photograph 2: | Radiated Emissions – Back View..... | 38 |
| Photograph 3: | Radiated Emissions – Radiated Emissions above 1 GHz | 39 |

1 General Information

1.1 Scope

This is an original FCC and Industry Canada certification application report.

Applicable Standards:

- FCC Rules Part 15.247: Frequency Hopping, Direct Spread Spectrum and Hybrid Systems that are in operation within the bands of 902-928 MHz, 2400-2483.5 MHz and 5725-5850 MHz
- RSS-247 Issue 1: Digital Transmission Systems (DTSs), Frequency Hopping Systems (FHSs) and License Exempt Local Area Network (LE-LAN) Devices

1.2 Description of EUT

| | |
|-------------------------------|---------------------------------|
| Equipment Under Test | XG-25P Portable Radio |
| Power Supply | Internal radio battery operated |
| Modulation Type | FHSS |
| Frequency Range | 2402 – 2480 MHz |
| Antenna Connector Type | N/A |
| Antenna Type | Internal chip |

1.3 Test Facility

The open area test site and conducted measurement facility used to collect the radiated data is located at 360 Herndon Parkway, Suite 1400, Herndon, Virginia 20170. This site has been fully described in a report and approved by the Federal Communications Commission to perform AC line conducted and radiated emissions testing.

1.4 Related Submittal(s)/Grant(s)

This is an original application. Harris will be seeking IC family certification for two model numbers, DPXG-PF78B-e1 (System) and DPXG-PB78B-e1 (Scan).

1.5 Modifications

None.

2 Test Information

2.1 Description of Test Modes

In accordance with FCC 15.31(m), and because the EUT utilizes an operating band greater than 10 MHz, the following frequencies were tested:

Table 2-1: Channels Tested

| Channel | Frequency |
|---------|-----------|
| Low | 2402 |
| Middle | 2441 |
| High | 2480 |

2.2 Exercising the EUT

The EUT was supplied with test software to select various transmit/receive modes (for example, high, mid, and low channel, hopping on/off, etc.) for testing, and to continuously transmit during testing. The carrier was also checked to verify that information was being transmitted. There were no deviations from the test standard(s) and/or methods. The test results reported relate only to the item tested.

GFSK, 2-EDR and 3-EDR modes were investigated. Where pertinent, data is presented for the three modes; otherwise, worst-case data is presented. GFSK was found to be worst case for radiated measurements, data for it is presented.

2.3 Test Result Summary

Table 2-2: Test Result Summary – FCC Part 15, Subpart C (Section 15.247) / IC RSS-247

| Test | FCC Reference | IC Reference | Result |
|--------------------------------------|-----------------------|----------------------------------|--------|
| AC Power Conducted Emissions | FCC 15.207 | RSS-Gen 8.8 | N/A |
| Radiated Emissions | FCC 15.209 | RSS-247 5.5; RSS-Gen 6.13/7.1 | Pass |
| Maximum Peak Power Output | FCC 15.247(b)(1) | RSS-247 5.4(2), RSS-Gen 6.12 | Pass |
| Antenna Conducted Spurious Emissions | FCC 15.247(d) | RSS-247 5.5, RSS-Gen 6.13 | Pass |
| Carrier Frequency Separation | FCC 15.247(a)(1) | RSS-247 5.1(2) | Pass |
| Band Edge Measurement | FCC 15.247(d) | RSS-247 5.5 | Pass |
| 20 dB Bandwidth | FCC 15.247(a)(1)(ii) | RSS-247 5.1(1) | Pass |
| Hopping Characteristics | FCC 15.247(a)(1)(iii) | IC RSS-247 5.1(4) | Pass |
| Average Time of Occupancy | FCC 15.247(a)(1)(iii) | IC RSS-247 5.1(4) | Pass |

2.4 Tested System Details

The test sample was received on February 11, 2016. Listed below are the identifiers and descriptions of all equipment, cables, and internal devices used with the EUT for this test, as applicable.

The EUT includes a System model and a Scan model, the difference being that the System model has a DTMF keypad. The System model is considered to be representative of the radio family and to have the worst case emissions, and was therefore used for testing.

The device was programmed for multiple modes of operation and modulation types.

Table 2-3: Equipment Under Test (EUT)

| Part | Manufacturer | Model | PN/SN | FCC ID | RTL Bar Code |
|---|-----------------------|---------------------------|---|--------------|--------------|
| XG-25P 700/800 MHz Radio | Harris Corporation | DPXG-PF78B-e1 (System) | 14011-0020-01/ 7/800 MHz TMS No.5 | OWDTR-0140-E | 22088 |
| XG-25P 700/800 MHz Radio | Harris Corporation | DPXG-PB78B-e1 (Scan) | 14011-0020-02/ 7/800 MHz TMS No.6 | OWDTR-0140-E | 22087 |
| Radio with Conducted Port for Bluetooth Testing | Harris Corporation | XG-25P | VHF TMS No. 15 | OWDTR-0140-E | 21976 |

Table 2-4: Accessory Test Equipment

| Part | Manufacturer | Model | SN | FCC ID | RTL Bar Code |
|-----------------------|-----------------------|---------------|-----|--------|--------------|
| Battery Eliminator | Harris Corporation | 14035-4300-01 | N/A | N/A | 21553 |

Figure 2-1: Configuration of Tested System

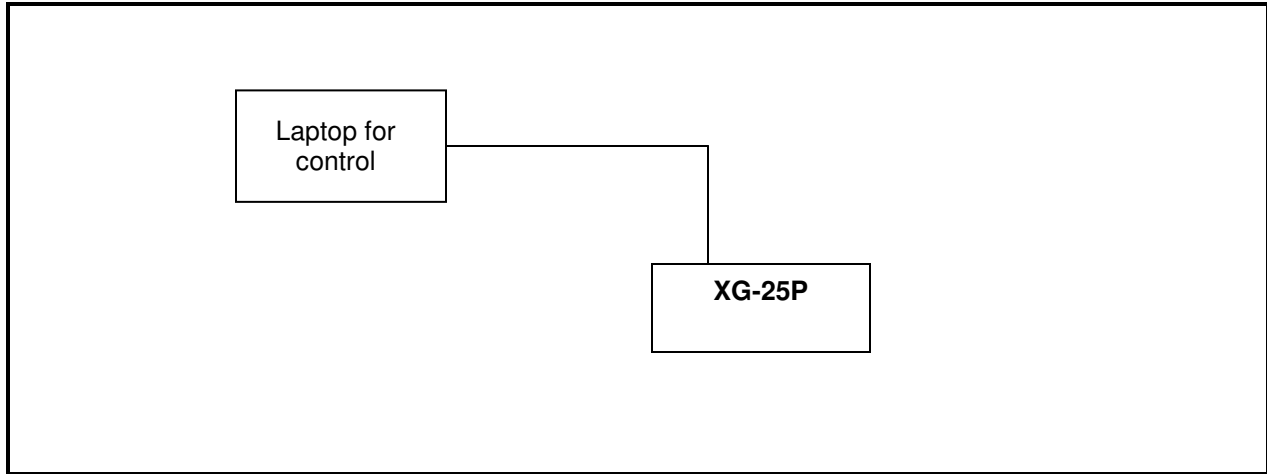

3 Peak Output Power – FCC 15.247(b)(1), RSS-247 5.4(2), RSS-Gen 6.12

3.1 Power Output Test Procedure

Procedure: C63.10-2013

3.2 Power Output Test Data

Table 3-1: Power Output Test Data

| Frequency (MHz) | Peak Power (dBm) | Peak Power (mW) |
|-----------------|------------------|-----------------|
| 2402 | 0.2 | 1.05 |
| 2441 | -0.3 | 0.93 |
| 2480 | -0.7 | 0.85 |

Table 3-2: Power Output Test Equipment

| RTL Asset # | Manufacturer | Model | Part Type | Serial Number | Calibration Due Date |
|-------------|-----------------|--------|-------------------------------------|---------------|----------------------|
| 900930 | Hewlett Packard | 85662A | Spectrum Analyzer Display Section | 3144A20839 | 4/21/16 |
| 900931 | Hewlett Packard | 8566B | Spectrum Analyzer (100 Hz - 22 GHz) | 3138A07771 | 4/21/16 |

Test Personnel:

Daniel W. Baltzell
 EMC Test Engineer

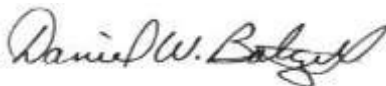

Signature

March 14, 2016
 Date of Test

4 Duty Cycle Correction

Plot 4-1: Pulse Width – 2.86ms

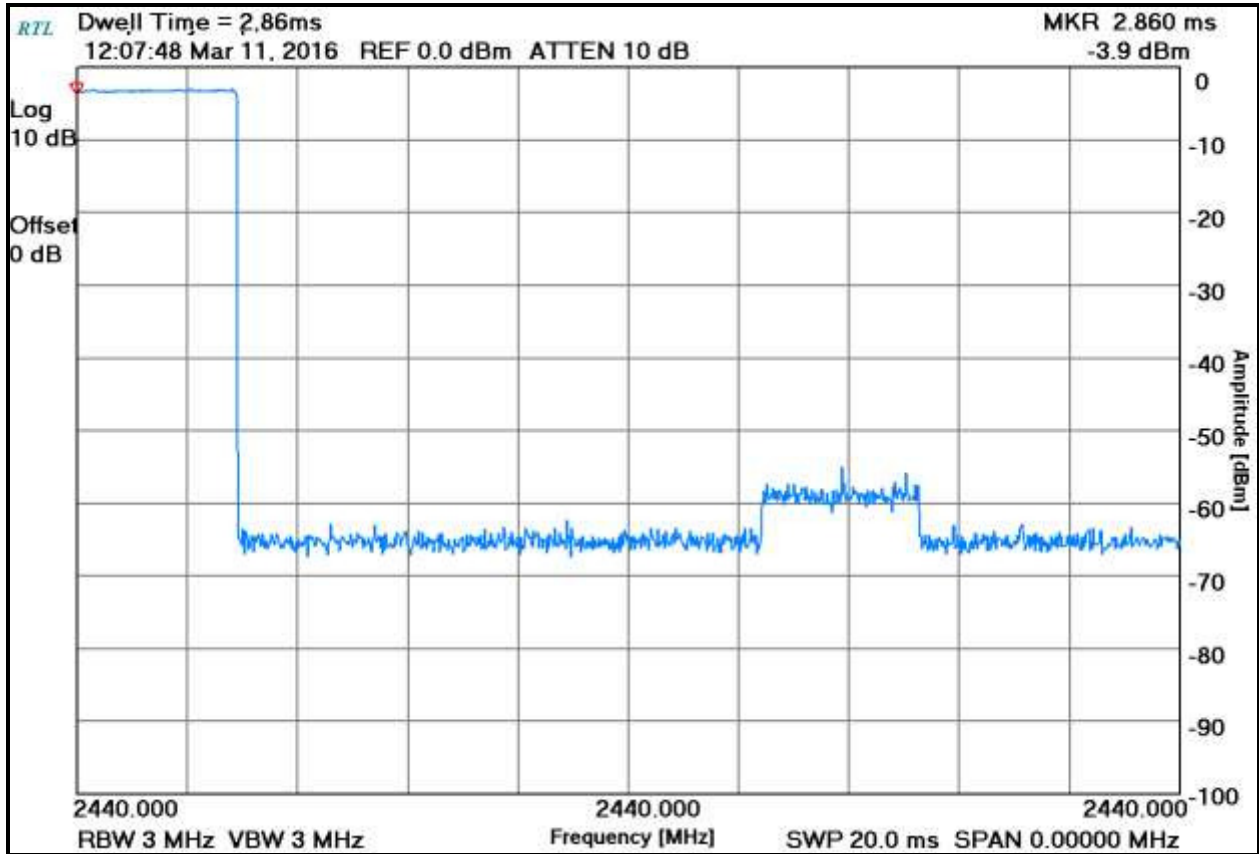

Plot 4-2: Single Pulse per 100ms

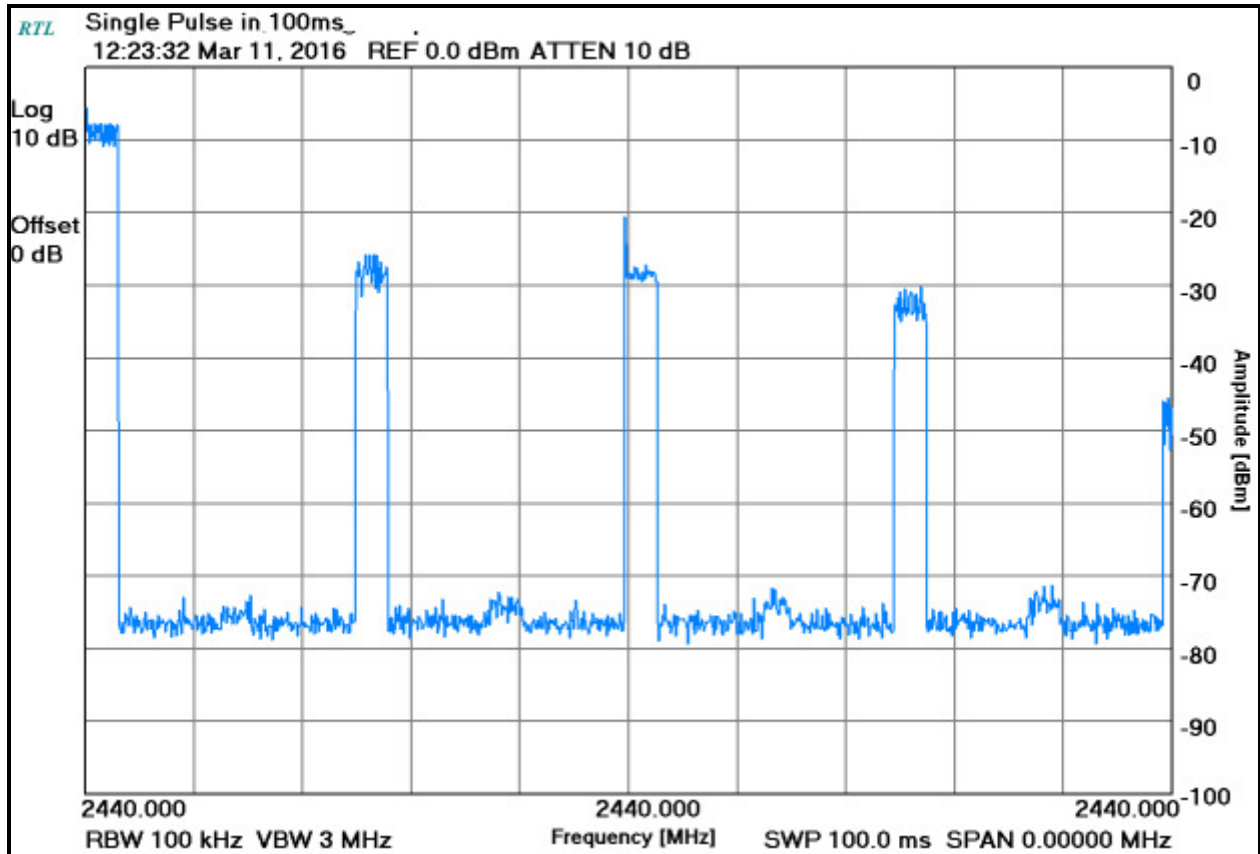

Duty Cycle Calculation:

$20 \text{ Log } (2.86/100) = -30.9 \text{ dB correction}$

Table 4-1: Duty Cycle Test Equipment

| RTL Asset # | Manufacturer | Model | Part Type | Serial Number | Calibration Due Date |
|-------------|-----------------|--------|-------------------------------------|---------------|----------------------|
| 900930 | Hewlett Packard | 85662A | Spectrum Analyzer Display Section | 3144A20839 | 4/21/16 |
| 900931 | Hewlett Packard | 8566B | Spectrum Analyzer (100 Hz - 22 GHz) | 3138A07771 | 4/21/16 |

Test Personnel:

Daniel W. Baltzell
 EMC Test Engineer

Signature

March 11, 2016
 Date of Test

5 Antenna Conducted Spurious Emissions – FCC 15.247(d), RSS-247 5.5

Procedure: C63.10-2013 6.7

No conducted spurious emissions were within 20 dB of the limit, therefore no data is reported.

Table 5-1: Antenna Conducted Spurious Emissions Test Equipment

| RTL Asset # | Manufacturer | Model | Part Type | Serial Number | Calibration Due Date |
|-------------|-----------------|--------|-------------------------------------|---------------|----------------------|
| 900930 | Hewlett Packard | 85662A | Spectrum Analyzer Display Section | 3144A20839 | 4/21/16 |
| 900931 | Hewlett Packard | 8566B | Spectrum Analyzer (100 Hz - 22 GHz) | 3138A07771 | 4/21/16 |

Test Personnel:

| | | |
|--------------------|---|----------------|
| Daniel W. Baltzell |  | March 11, 2016 |
| EMC Test Engineer | Signature | Date of Test |

6 Band-Edge Compliance of RF Conducted Emissions – FCC 15.247(d), RSS-247 5.5

6.1 Band Edge Test Procedure

Procedure: C63.10-2013 6.10

The EUT was connected to the spectrum analyzer through suitable attenuation. The span was set wide enough to capture the peak level of the emission operating on the channel closest to the band edge, as well as any modulation products which fall outside of the authorized band of operation. The spectrum analyzer was set to the following:

RBW > = 1 % of span
VBW > = RBW
Sweep = auto
Detector function = peak
Trace = max hold

The trace was allowed to stabilize. The marker was set on the emission at the band edge. The marker-delta was used to show the delta between the maximum in-band emission and the emission at the band edge, and was compared to the 20 dBc requirement of 15.247(d) (when using peak emissions). This measurement was taken in both fixed frequency and hopping modes.

6.2 Test Results

Plot 6-1: Lower Band Edge TX Frequency - 2402 MHz

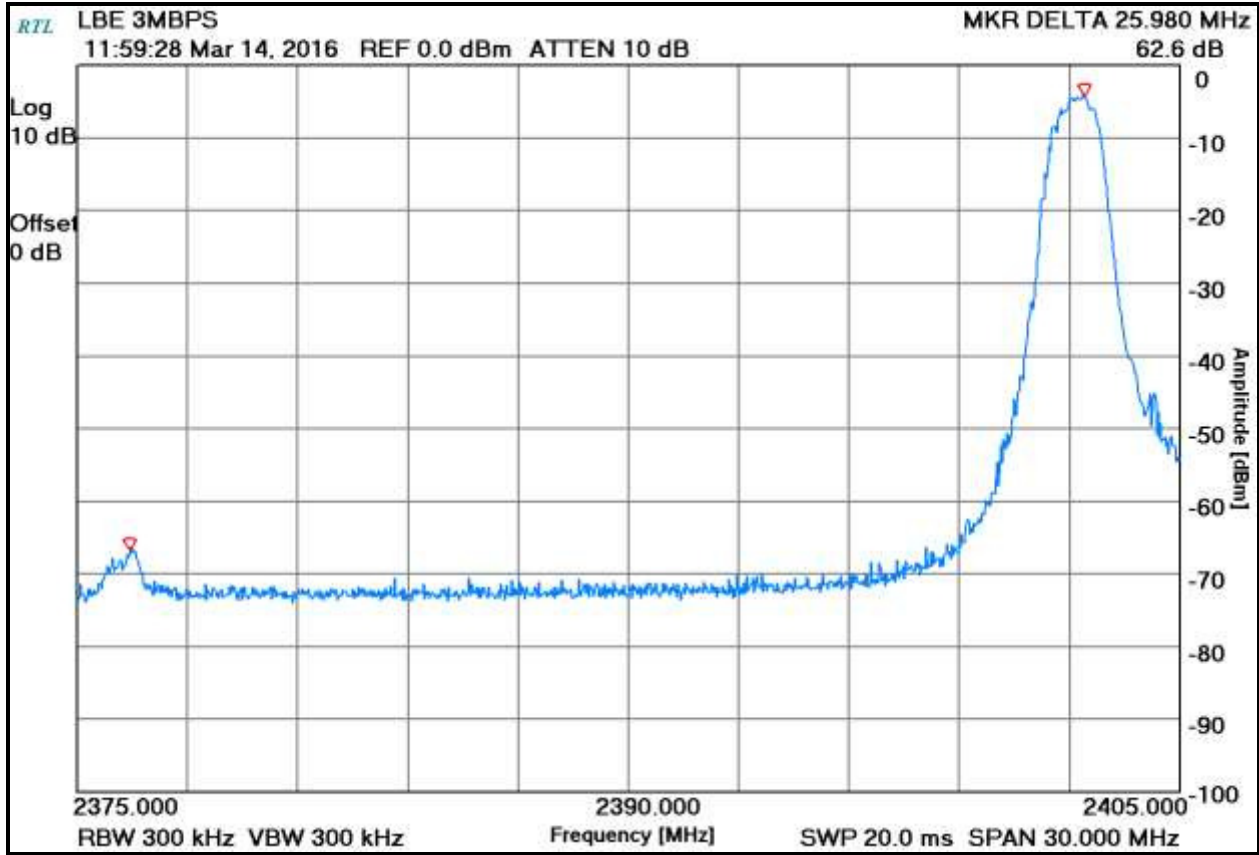

Plot 6-2: Lower Band Edge TX Frequency - 2402 MHz (Hopping)

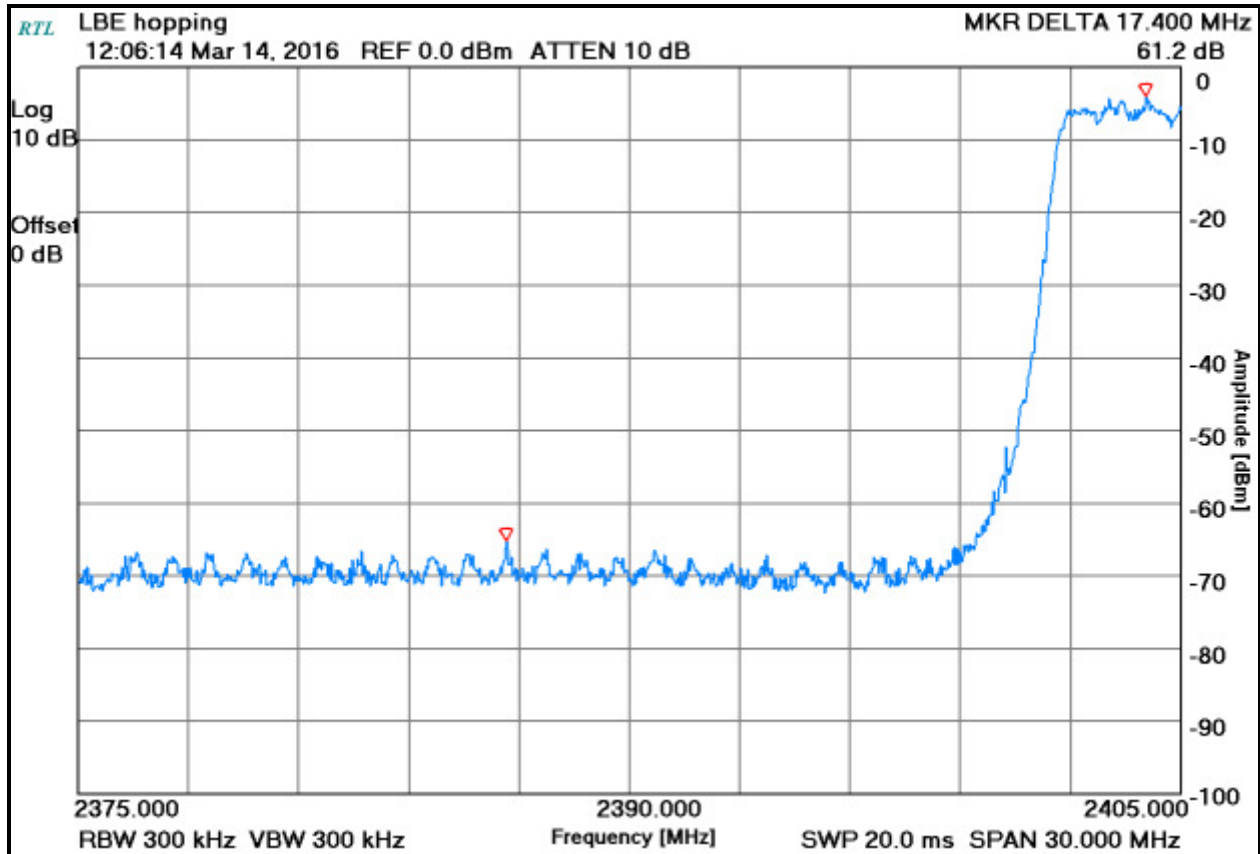

Plot 6-3: Upper Band Edge TX Frequency - 2480 MHz

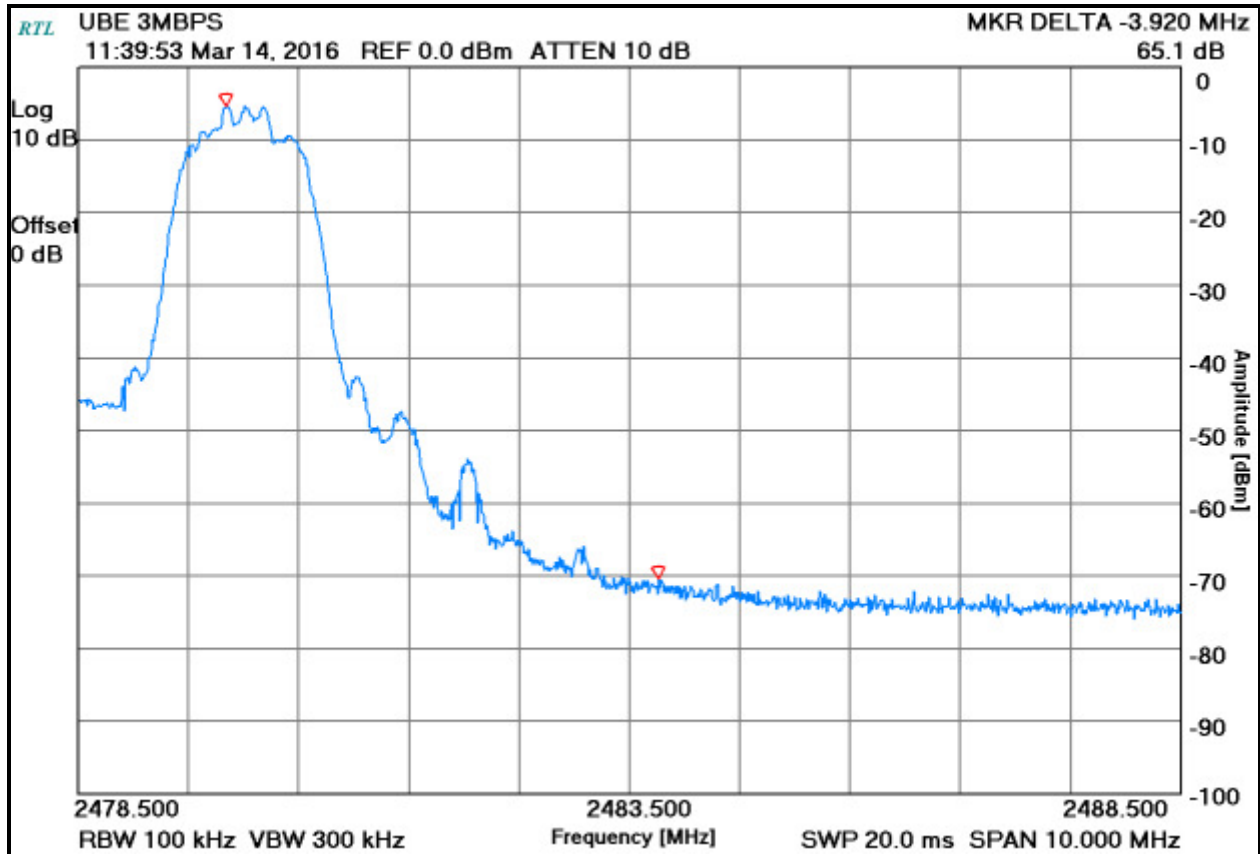

Plot 6-4: Upper Band Edge TX Frequency - 2480 MHz (Hopping)

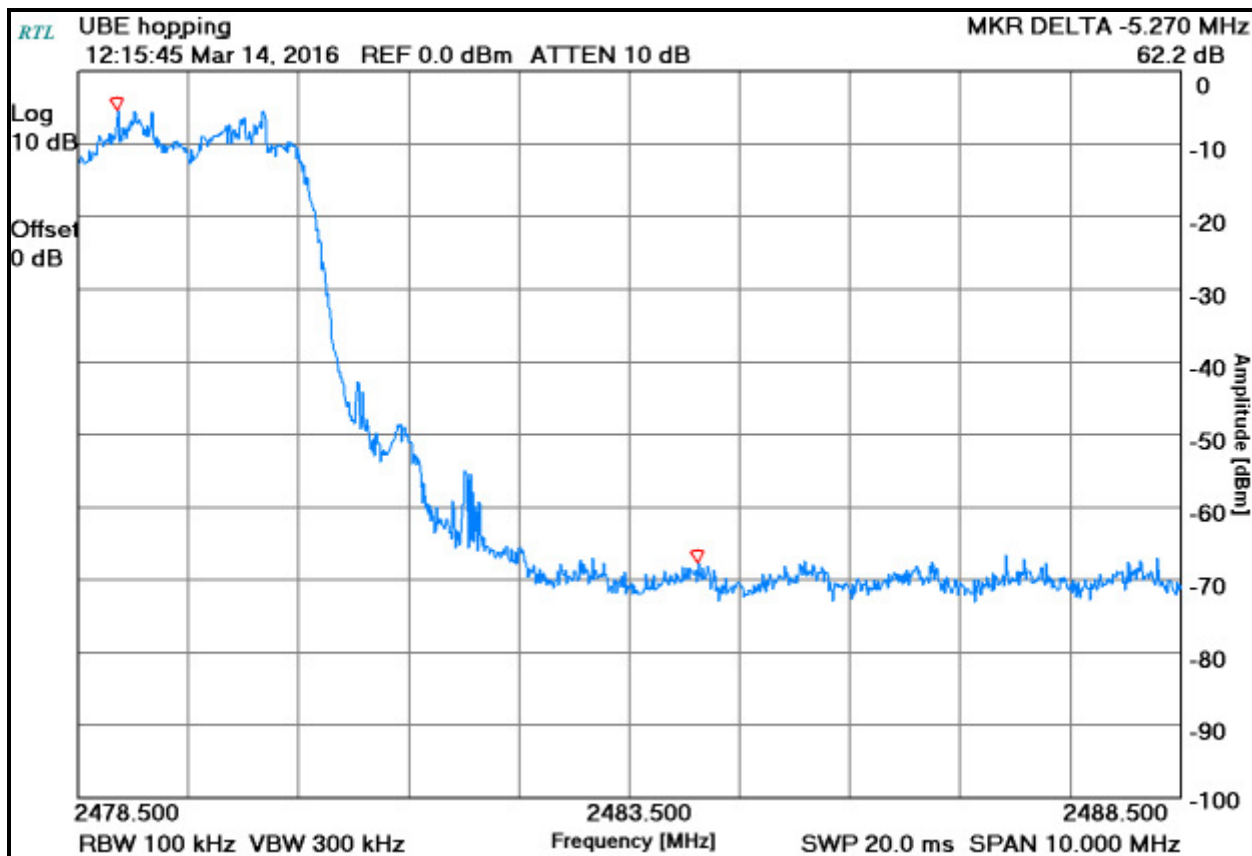

Table 6-1: Band-Edge Compliance of RF Conducted Emissions Test Equipment

| RTL Asset # | Manufacturer | Model | Part Type | Serial Number | Calibration Due Date |
|-------------|-----------------|--------|-------------------------------------|---------------|----------------------|
| 900930 | Hewlett Packard | 85662A | Spectrum Analyzer Display Section | 3144A20839 | 4/21/16 |
| 900931 | Hewlett Packard | 8566B | Spectrum Analyzer (100 Hz - 22 GHz) | 3138A07771 | 4/21/16 |

Test Personnel:

Daniel W. Baltzell
 EMC Test Engineer

Signature

March 14, 2016
 Date of Test

6.3 Radiated Band Edge Emissions

Table 6-2: Radiated Band Edge Emissions Test Data

| Frequency (MHz) | Peak Spectrum Analyzer Level (1 MHz RBW/ 3 MHz VBW) (dBuV) | Average Analyzer Detector (1 MHz RBW/ 3 MHz VBW) (dBuV) | Site Correction Factor (dB/m) with Duty Cycle Correction -47.6 dB | Corrected Average Level (dBuV/m) | Delta Measurement from Plots (dB) | Average Limit (dBuV/m) | Margin (dB) |
|-----------------|--|---|---|----------------------------------|-----------------------------------|------------------------|-------------|
| 2402.0 | 99.6 | 99.6 | -10.4 | 89.2 | 61.2 | 54.0 | -26.0 |
| 2480.0 | 94.7 | 94.7 | -10.0 | 84.7 | 62.2 | 54.0 | -31.5 |

Table 6-3: Radiated Band Edge Test Equipment

| RTL Asset # | Manufacturer | Model | Part Type | Serial Number | Calibration Due Date |
|-------------|---------------------|-------------------|-------------------------------------|---------------|----------------------|
| 901592 | Insulated Wire Inc. | KPS-1503-3600-KPR | SMK RF Cables 20' | NA | 9/4/16 |
| 900930 | Hewlett Packard | 85662A | Spectrum Analyzer Display Section | 3144A20839 | 4/21/16 |
| 900931 | Hewlett Packard | 8566B | Spectrum Analyzer (100 Hz - 22 GHz) | 3138A07771 | 4/21/16 |
| 900772 | EMCO | 3161-02 | Horn Antenna (2 - 4 GHz) | 9804-1044 | 4/09/18 |
| 900886 | EMI Shop | WRT000-0003 | Turntable OATS | N/A | Not Required |
| 900932 | Hewlett Packard | 8449B OPT H02 | Preamplifier (1 - 26.5 GHz) | 3008A00505 | 9/10/16 |

Test Personnel:

Daniel W. Baltzell
 EMC Test Engineer

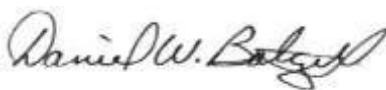

Signature

March 14, 2016
 Date of Test

7 20 dB Bandwidth – FCC 15.247(a)(1), RSS-247 5.1(1)

7.1 20 dB Bandwidth Test Procedure

Procedure: C63.10-2013 6.9

7.2 20 dB Modulated Bandwidth Test Data

Table 7-1: 20 dB Modulated Bandwidth Test Data – GFSK (1 Mbps)

| Frequency (MHz) | 20 dB Bandwidth (MHz) |
|-----------------|-----------------------|
| 2402 | 1.13 |
| 2441 | 1.16 |
| 2480 | 1.16 |

Table 7-2: 20 dB Modulated Bandwidth Test Data – 2-EDR (2 Mbps)

| Frequency (MHz) | 20 dB Bandwidth (MHz) |
|-----------------|-----------------------|
| 2402 | 1.43 |
| 2441 | 1.40 |
| 2480 | 1.41 |

Table 7-3: 20 dB Modulated Bandwidth Test Data – 3-EDR (3 Mbps)

| Frequency (MHz) | 20 dB Bandwidth (MHz) |
|-----------------|-----------------------|
| 2402 | 1.42 |
| 2441 | 1.39 |
| 2480 | 1.41 |

7.3 20 dB Bandwidth Plots

Plot 7-1: 20 dB Bandwidth - 2402 MHz; GFSK

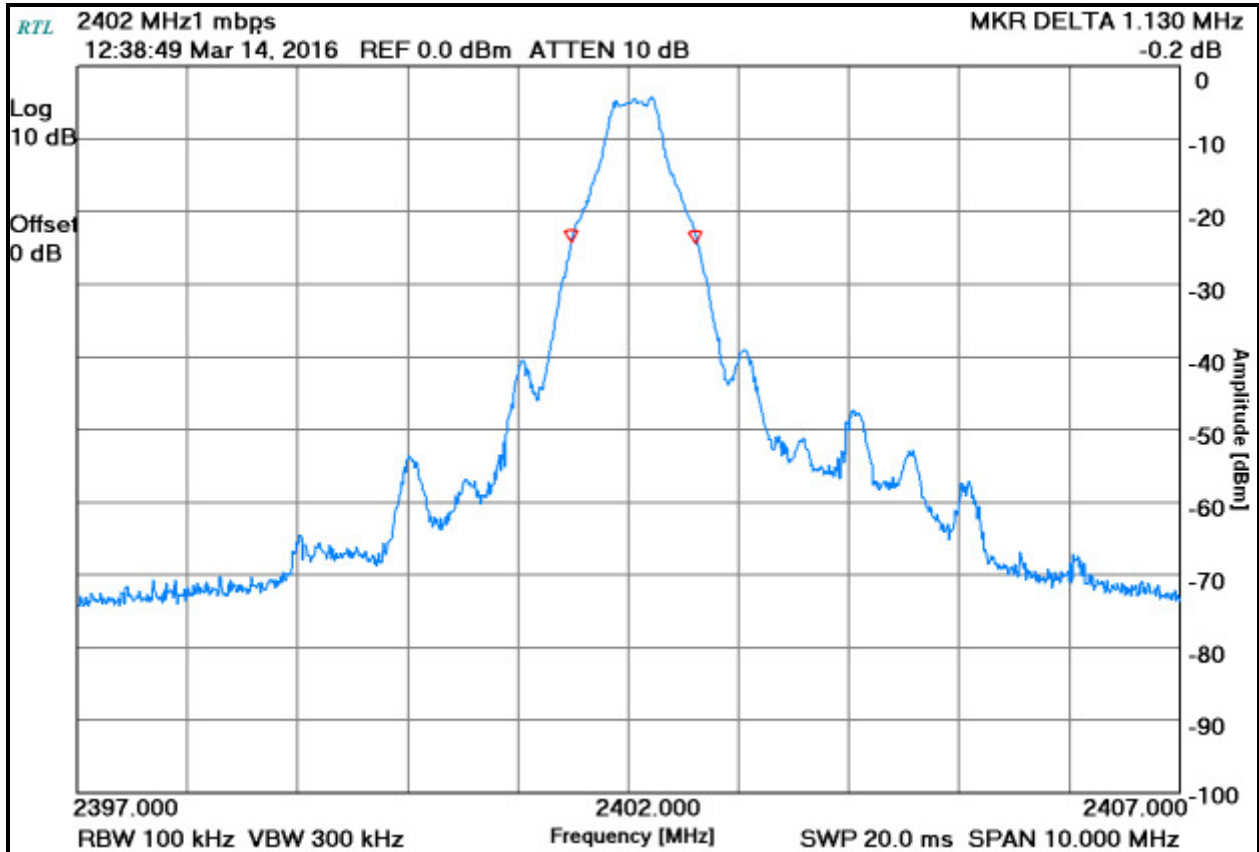

Plot 7-2: 20 dB Bandwidth - 2402 MHz; 2-EDR

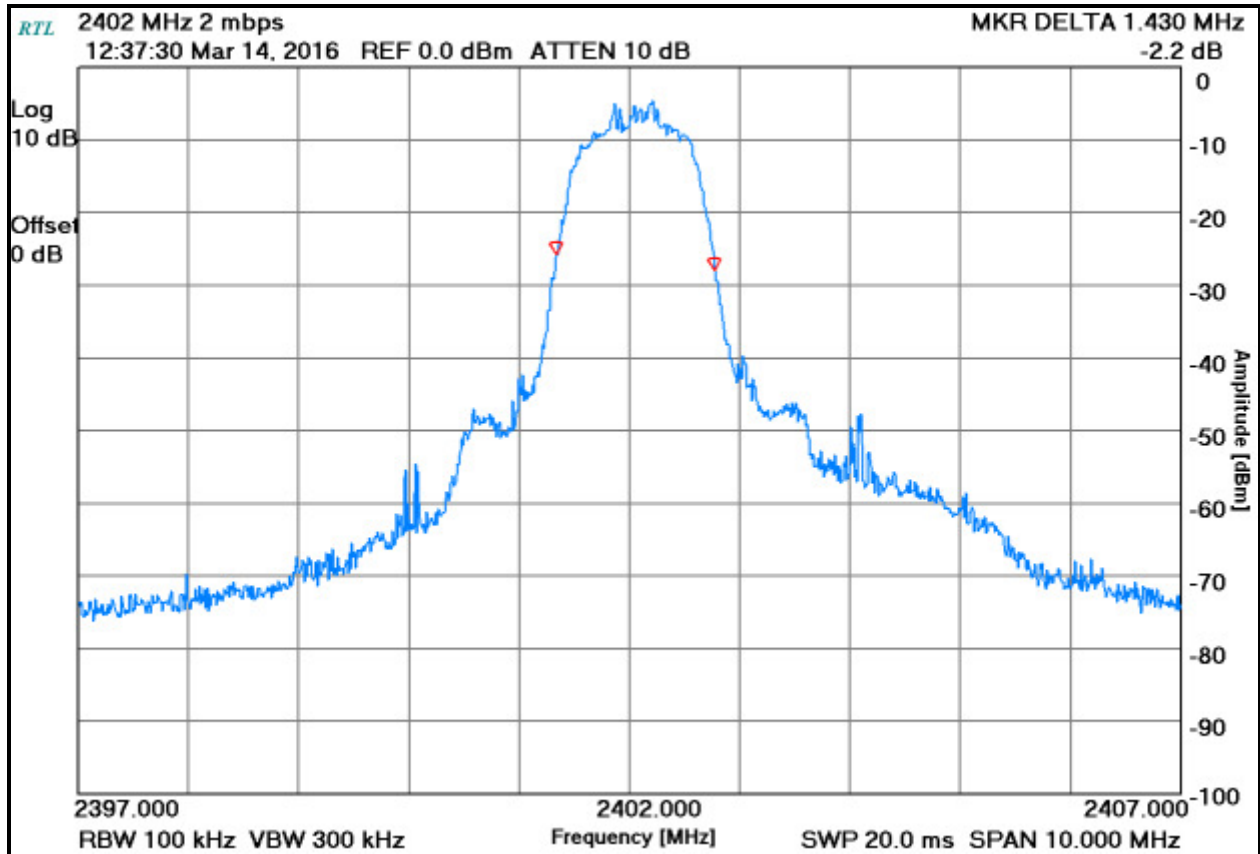

Plot 7-3: 20 dB Bandwidth - 2402 MHz; 3-EDR

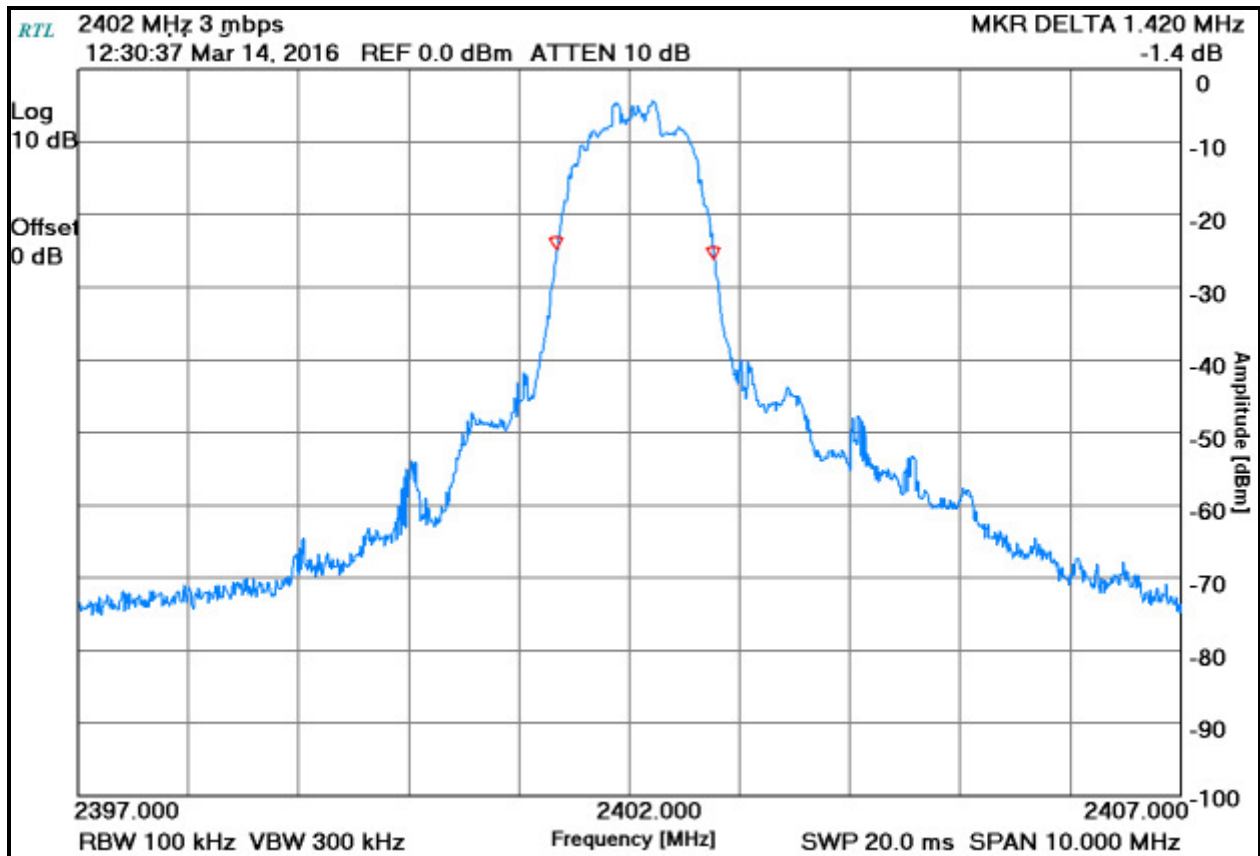

Plot 7-4: 20 dB Bandwidth - 2441 MHz; GFSK

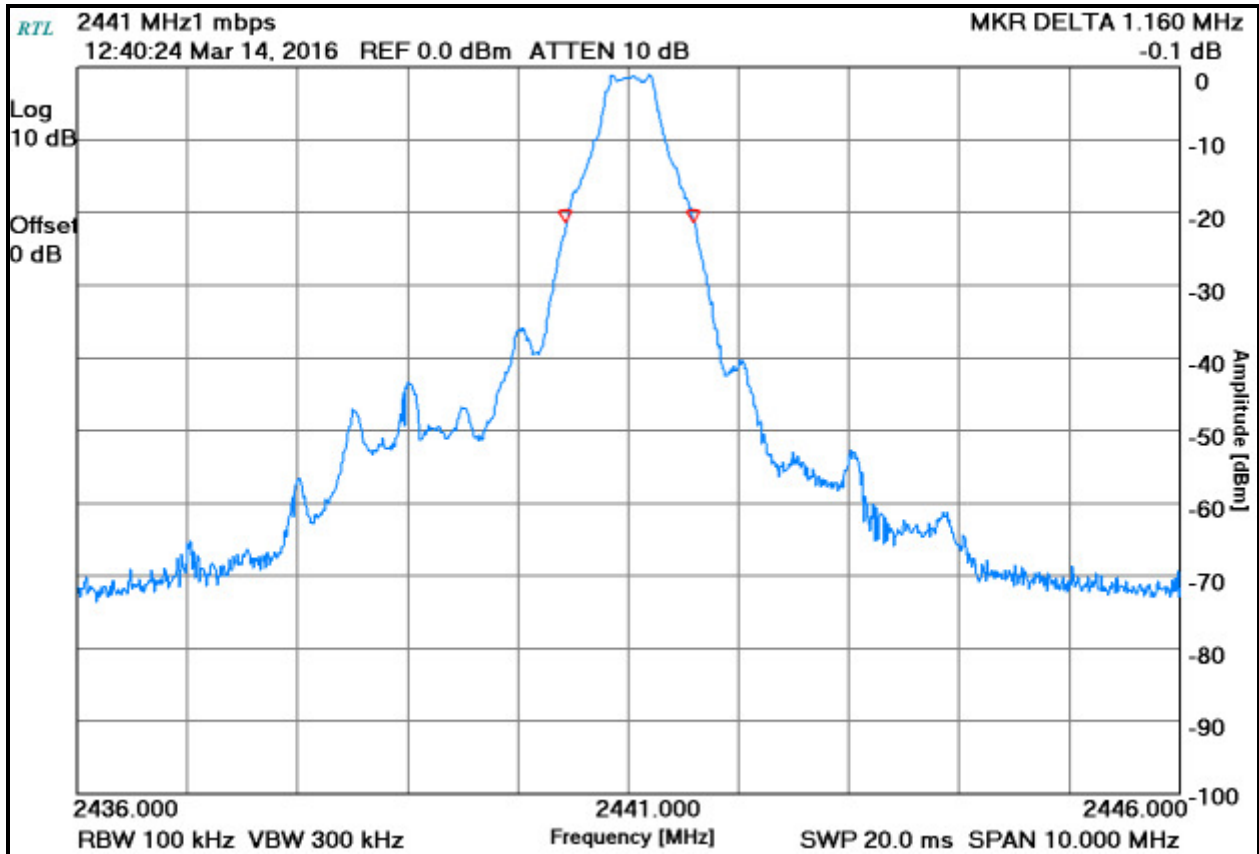

Plot 7-5: 20 dB Bandwidth - 2441 MHz; 2-EDR

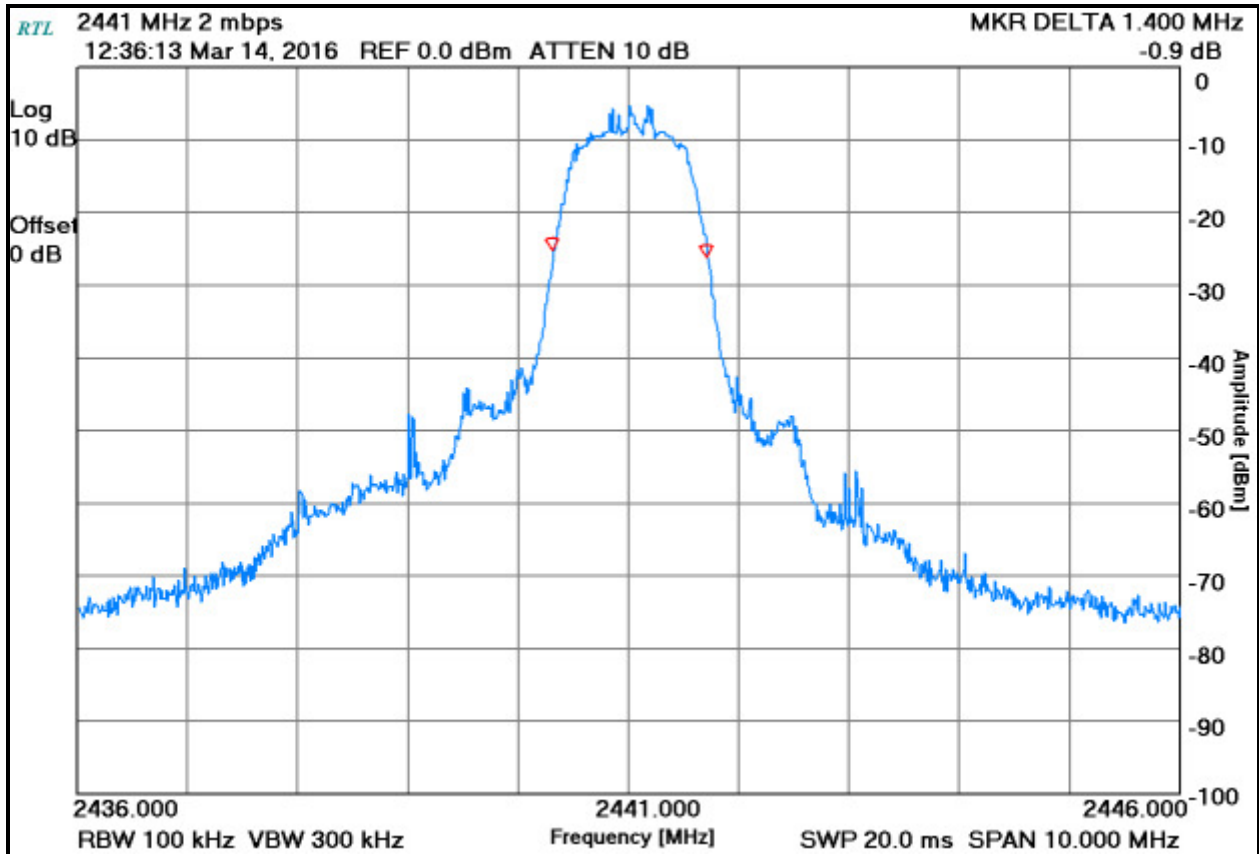

Plot 7-6: 20 dB Bandwidth - 2441 MHz; 3-EDR

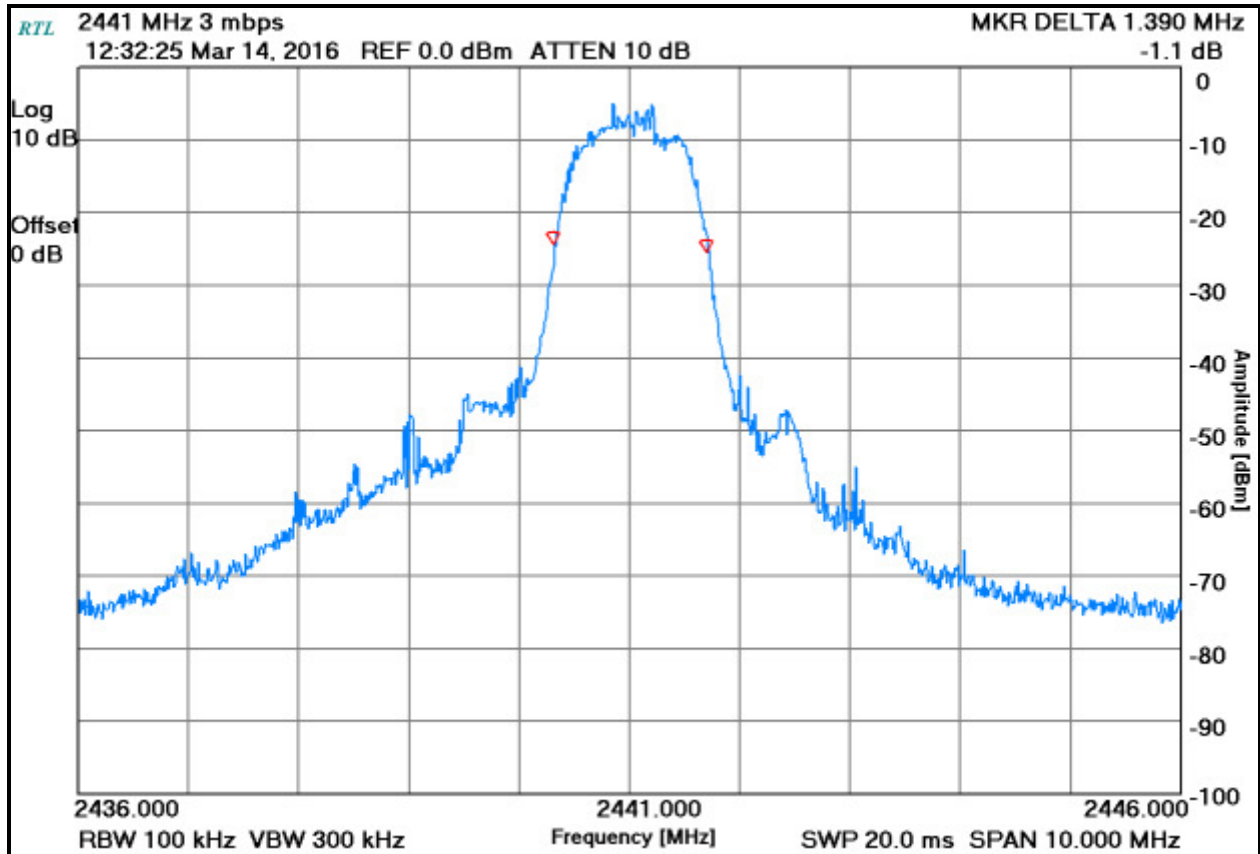

Plot 7-7: 20 dB Bandwidth - 2480 MHz; GFSK

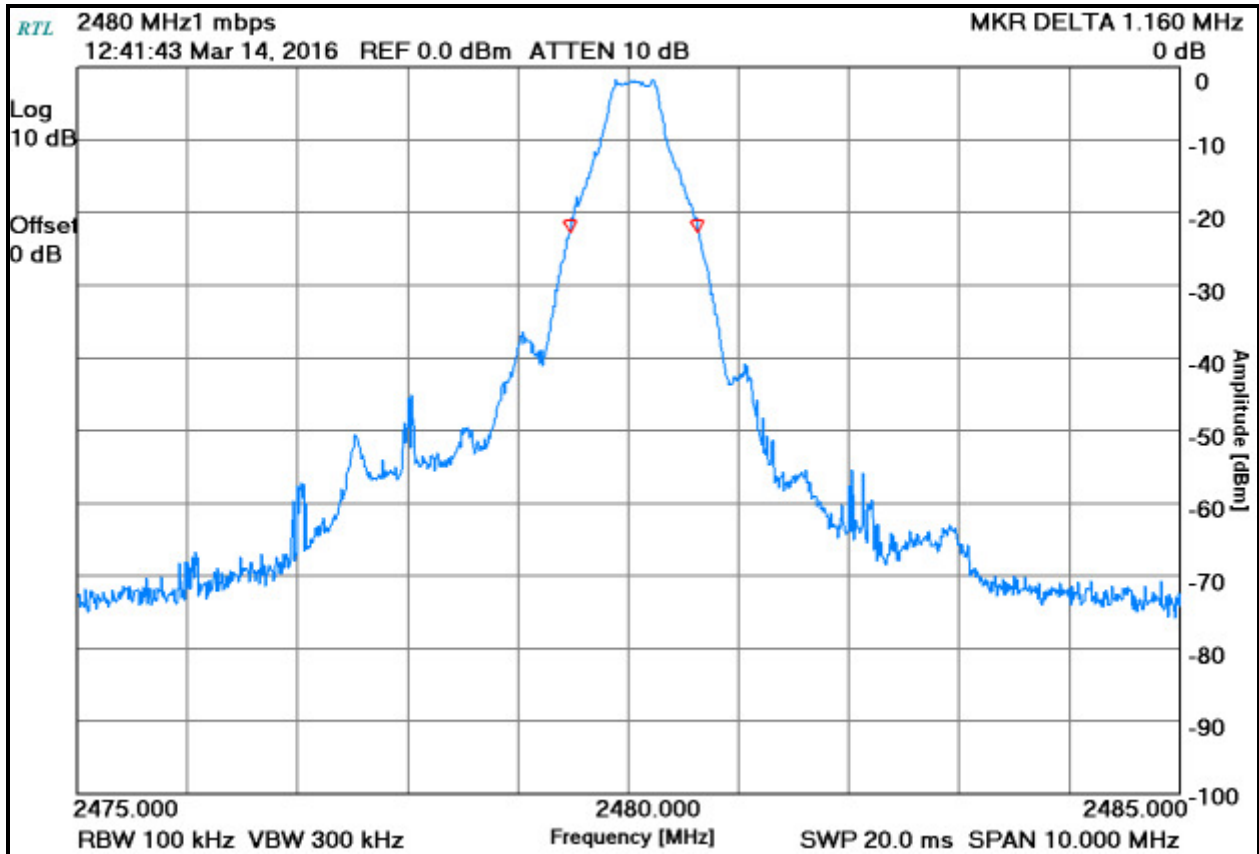

Plot 7-8: 20 dB Bandwidth - 2480 MHz; 2-EDR

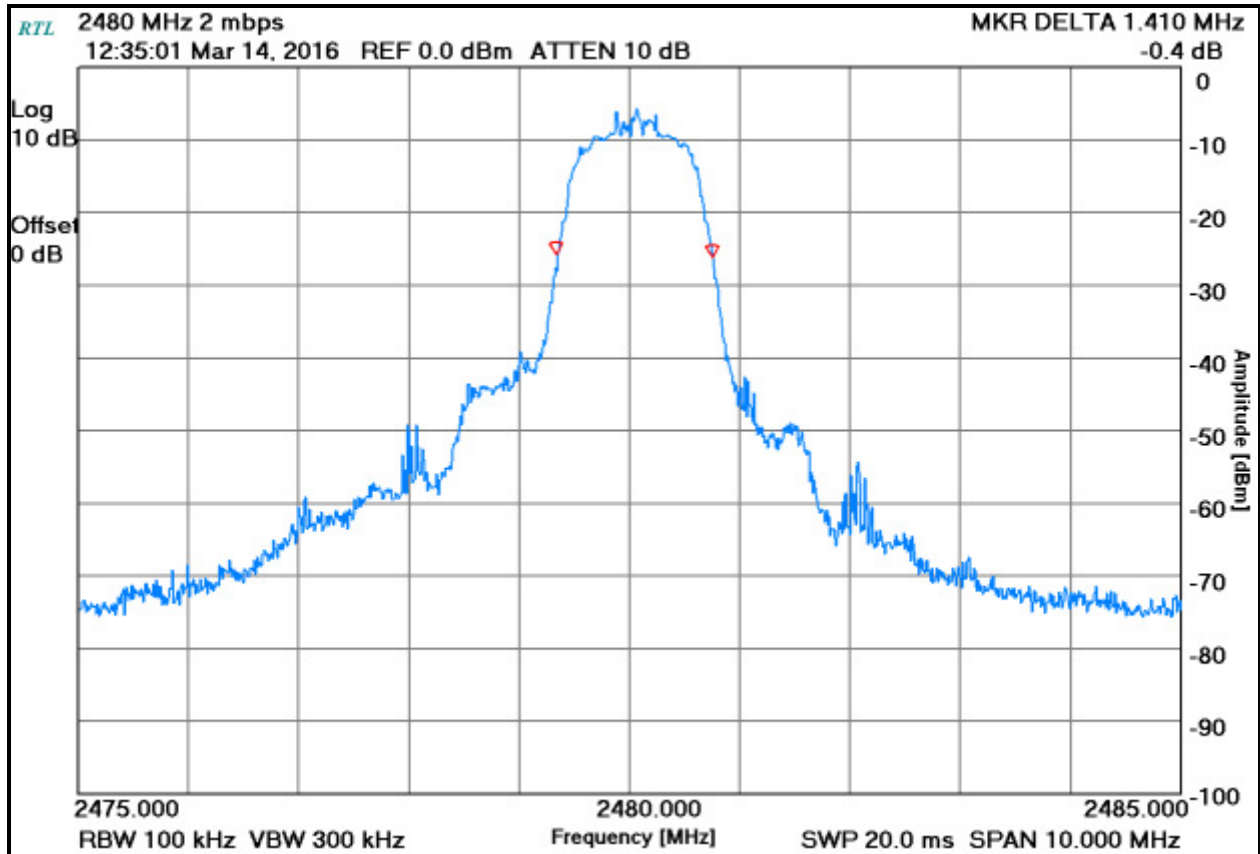

Plot 7-9: 20 dB Bandwidth - 2480 MHz; 3-EDR

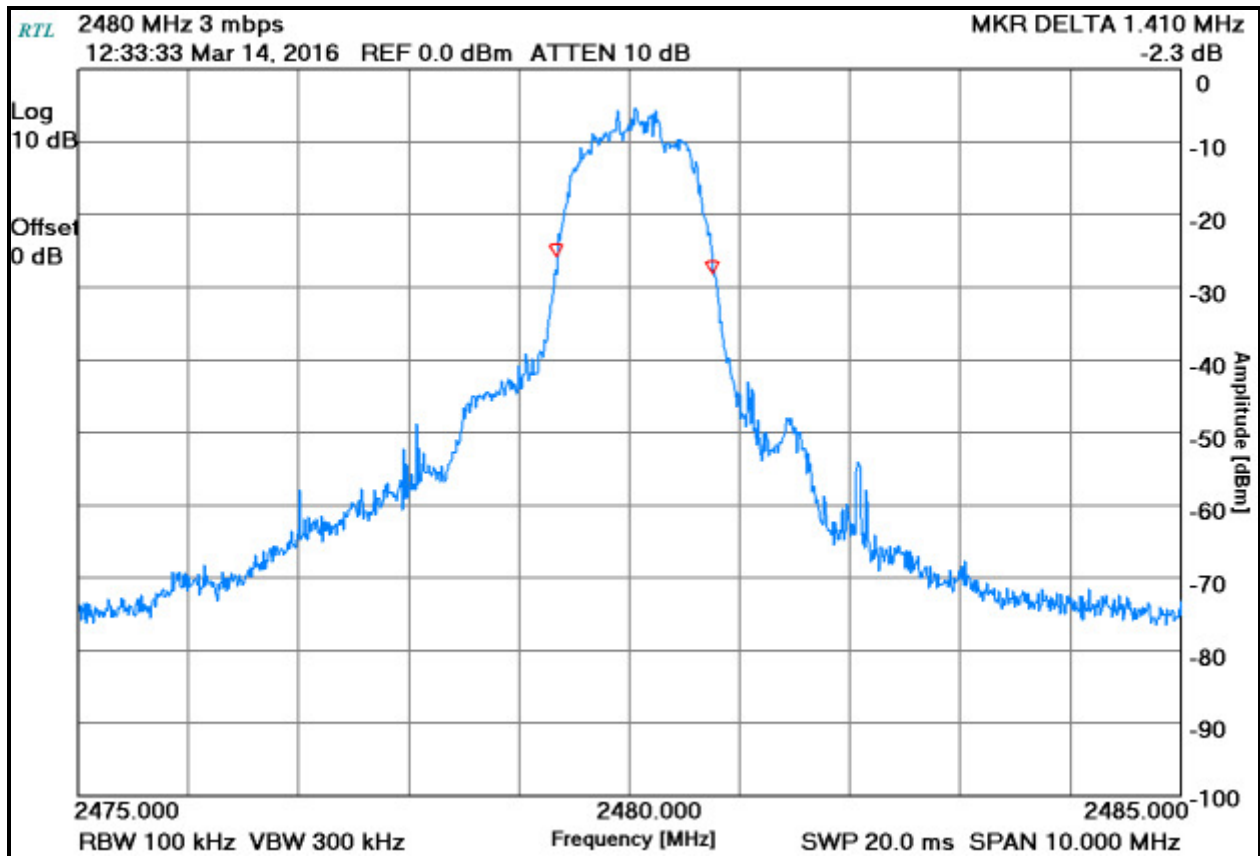

Table 7-4: 20 dB Bandwidth Test Equipment

| RTL Asset # | Manufacturer | Model | Part Type | Serial Number | Calibration Due Date |
|-------------|-----------------|--------|-------------------------------------|---------------|----------------------|
| 900930 | Hewlett Packard | 85662A | Spectrum Analyzer Display Section | 3144A20839 | 4/21/16 |
| 900931 | Hewlett Packard | 8566B | Spectrum Analyzer (100 Hz - 22 GHz) | 3138A07771 | 4/21/16 |

Test Personnel:

Daniel W. Baltzell
 EMC Test Engineer

Signature

March 14, 2016
 Date of Test

8 Carrier Frequency Separation - 15.247(a)(1), RSS-247 5.1(2)

8.1 Carrier Frequency Separation Test Procedure

Procedure: C63.10-2013 7.8.2

Frequency hopping systems shall have hopping channel carrier frequencies separated by a minimum of 25 kHz, or the 20 dB bandwidth of the hopping channel, whichever is greater. Alternatively, frequency hopping systems operating in the 2400–2483.5 MHz band may have hopping channel carrier frequencies that are separated by 25 kHz or two-thirds of the 20 dB bandwidth of greater, provided the systems operate with an output power no greater than 125 mW.

Measured frequency separation = 1.0 MHz

8.2 Carrier Frequency Separation Test Data

Plot 8-1: Carrier Frequency Separation

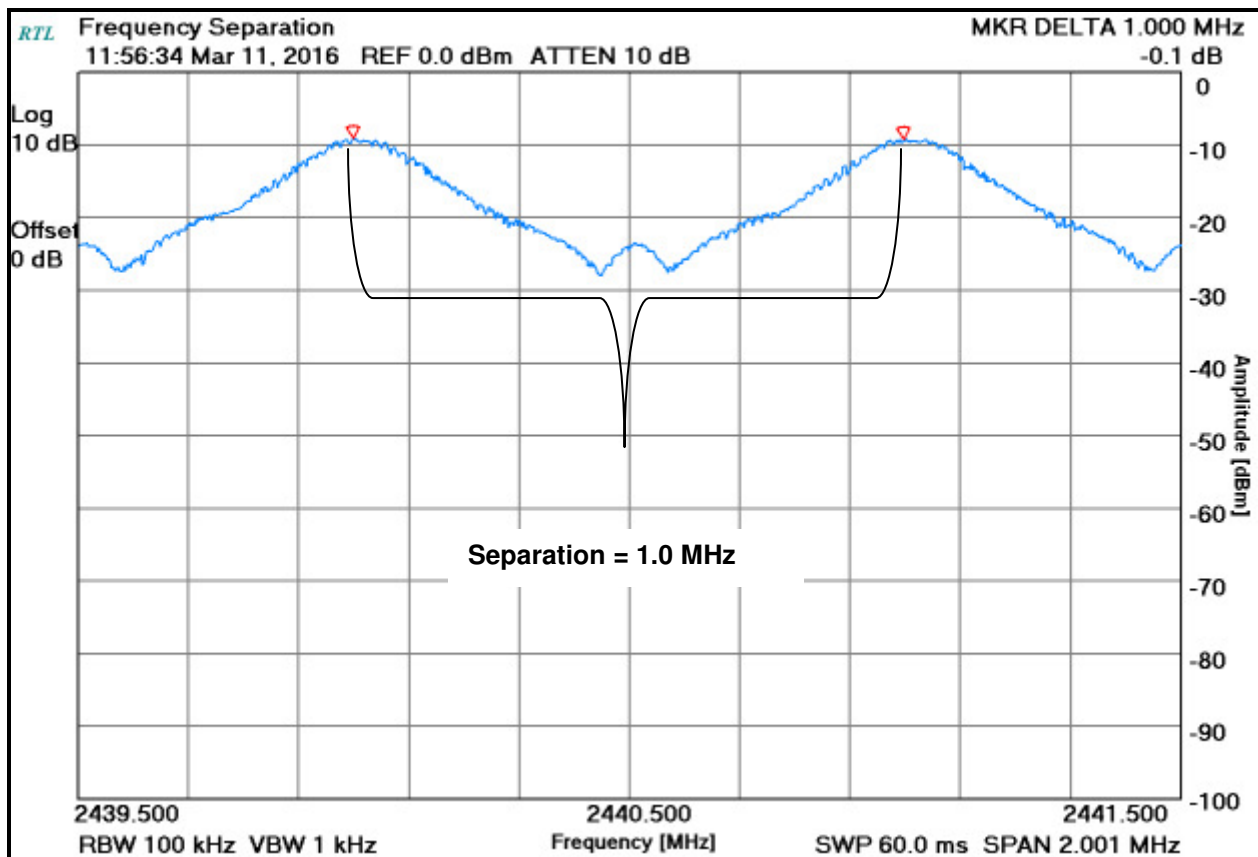

9 Hopping Characteristics – FCC 15.247(a)(1)(iii), RSS-247 5.1(4)

9.1 Hopping Characteristics Test Procedure

Procedure: C63.10-2013 7.8.3

Frequency hopping systems in the 2400–2483.5 MHz band shall use at least 15 channels. The average time of occupancy on any channel shall not be greater than 0.4 seconds within a period of 0.4 seconds multiplied by the number of hopping channels employed. Frequency hopping systems may avoid or suppress transmissions on a particular hopping frequency provided that a minimum of 15 channels are used.

9.2 Number of Hopping Frequencies

Measured number of hopping frequencies = 79

Plot 9-1: Number of Hopping Frequencies (2402 - 2480 MHz)

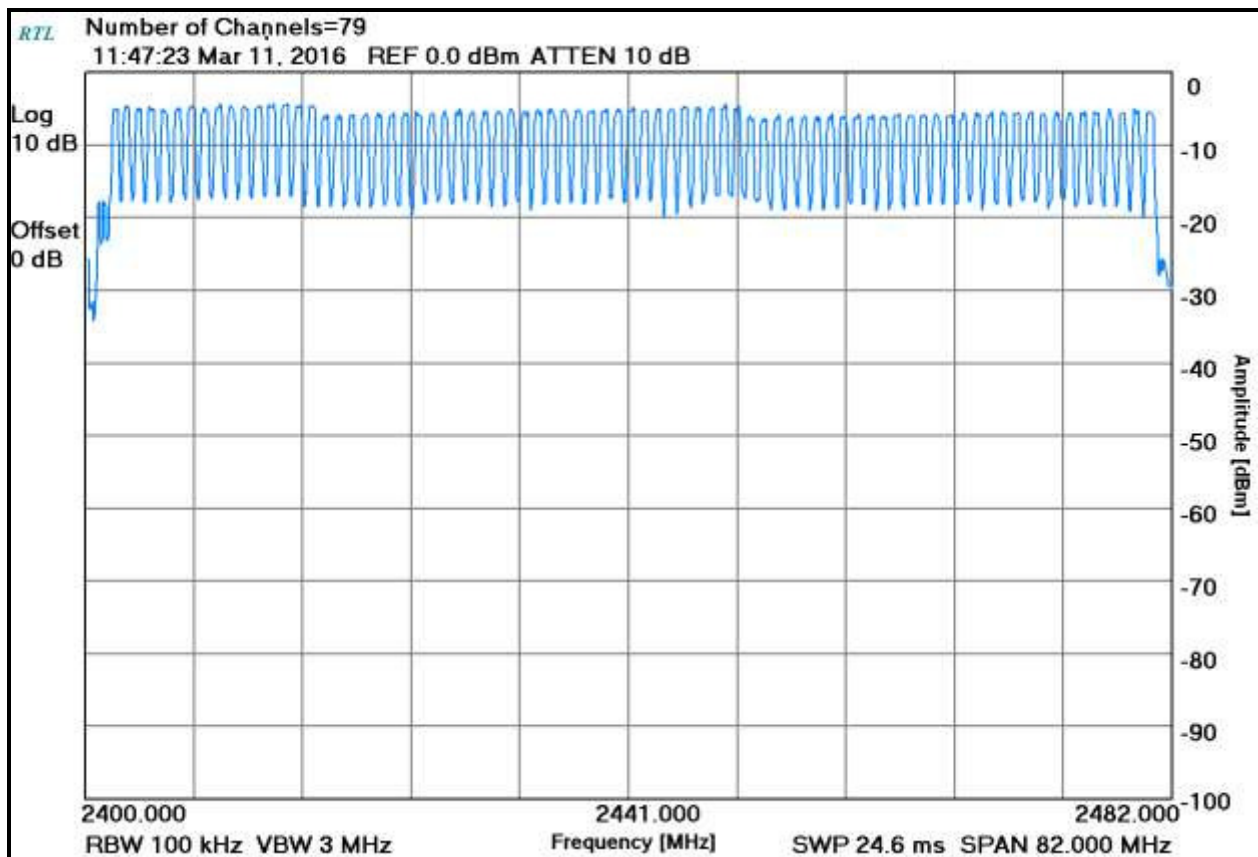

9.3 Average Time of Occupancy

Procedure: C63.10-2013 7.8.4

The average time of occupancy on any channel shall not be greater than 0.4 seconds within a period of 0.4 seconds multiplied by the number of hopping channels employed.

Allowed period = 0.4 s X 79 channels = 31.6 s

Pulse width = 2.86 ms

Number of pulses within a 31.6 s sweep = 32

Average time of occupancy in 31.6 s = 2.86 ms X 32 pulses = 0.092 s, which meets the limit of 0.4 s

Plot 9-2: Time of Occupancy (Dwell Time)

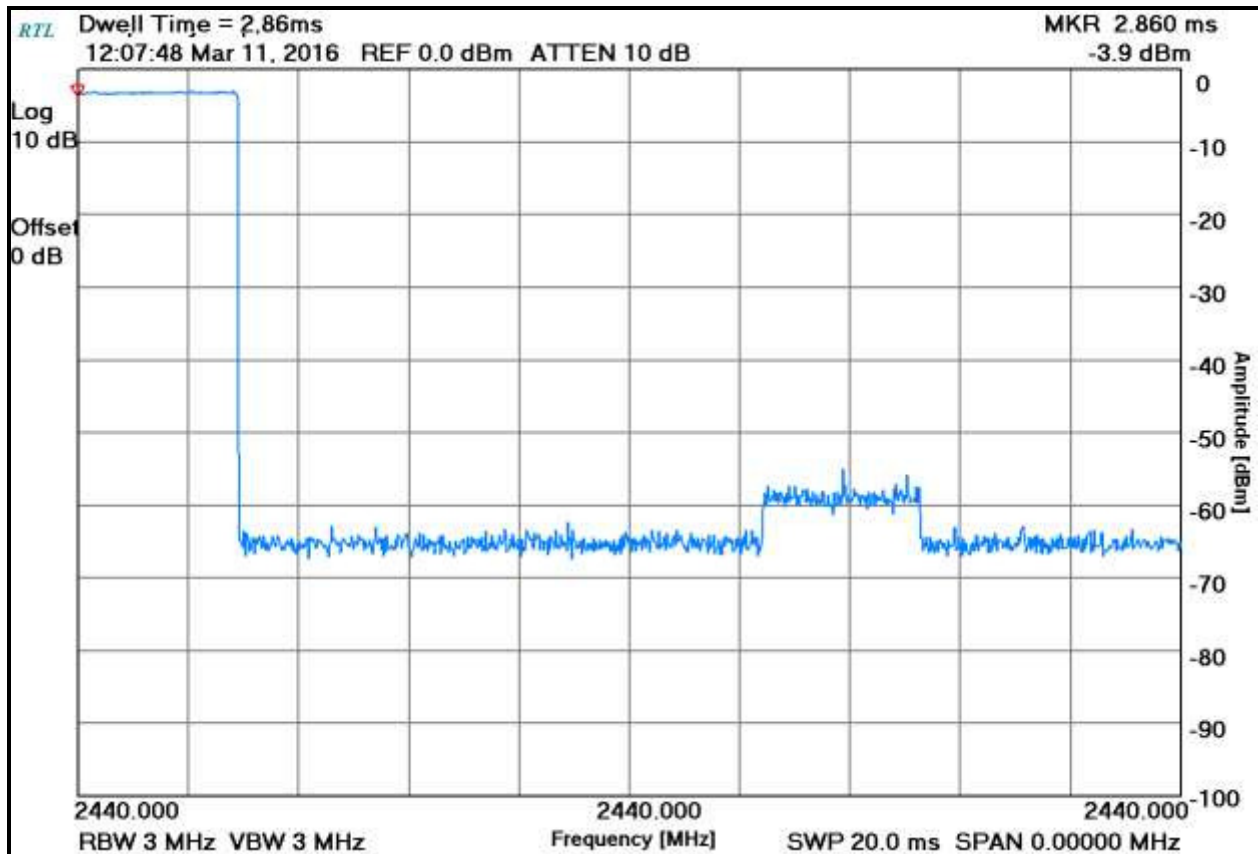

Plot 9-3: Number of Pulses in 31.6 Second Sweep

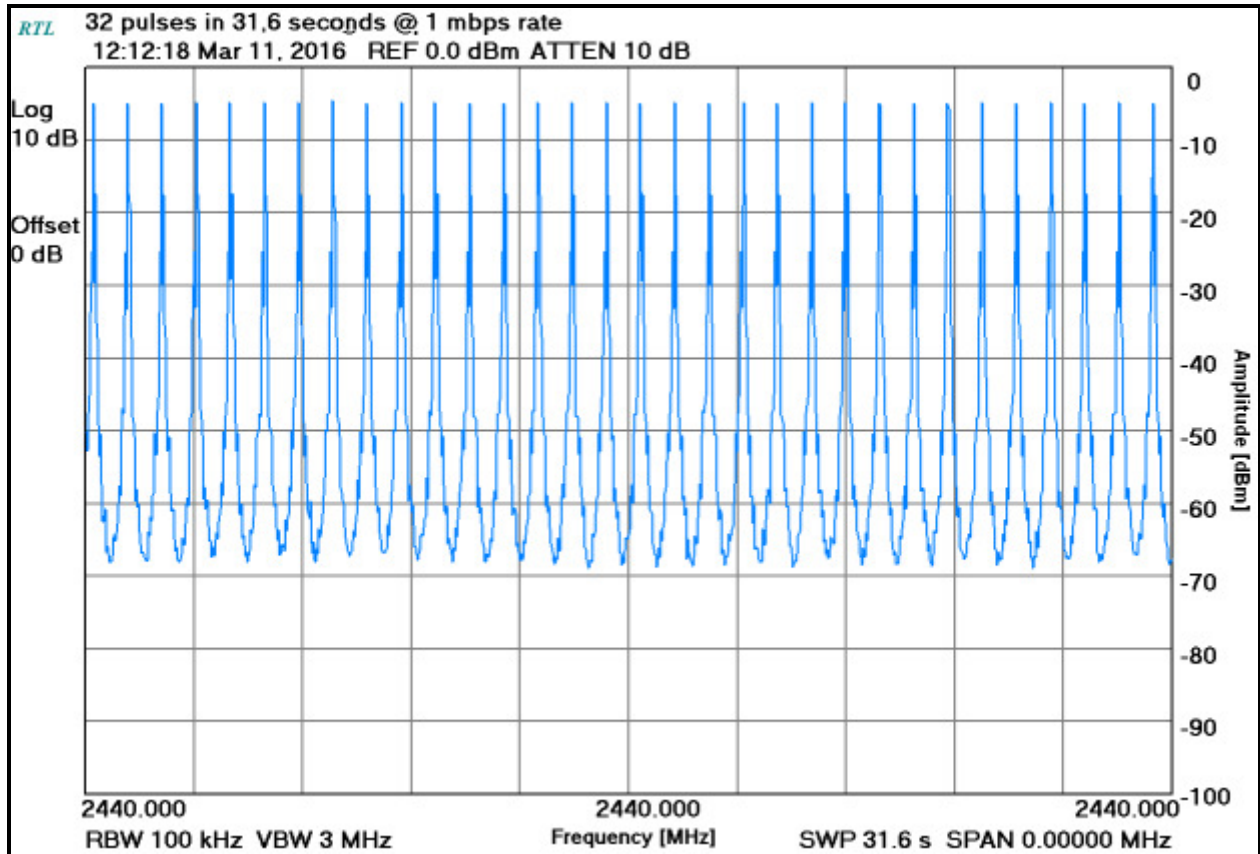

Table 9-1: Hopping Characteristics Test Equipment

| RTL Asset # | Manufacturer | Model | Part Type | Serial Number | Calibration Due Date |
|-------------|-----------------|--------|-------------------------------------|---------------|----------------------|
| 900930 | Hewlett Packard | 85662A | Spectrum Analyzer Display Section | 3144A20839 | 4/21/16 |
| 900931 | Hewlett Packard | 8566B | Spectrum Analyzer (100 Hz - 22 GHz) | 3138A07771 | 4/21/16 |

Test Personnel:

Daniel W. Baltzell
 EMC Test Engineer

Signature

March 11, 2016
 Date of Test

10 Radiated Emissions Test Results - FCC Rules and Regulations Part 15.247(d); RSS-247 2.2

10.1 Limits of Radiated Emissions Measurement

| Frequency (MHz) | Field Strength (uV/m) | Measurement Distance (m) |
|-----------------|-----------------------|--------------------------|
| 0.009-0.490 | 2400/f (kHz) | 300 |
| 0.490-1.705 | 2400/f (kHz) | 30 |
| 1.705-30.0 | 30 | 30 |
| 30-88 | 100 | 3 |
| 88-216 | 150 | 3 |
| 216-960 | 200 | 3 |
| Above 960 | 500 | 3 |

As shown in 15.35(b), for frequencies above 1000 MHz, the field strength limits are based on average detector, however, the peak field strength of any emission shall not exceed the maximum permitted average limits, specified above by more than 20 dB under any circumstances of modulation.

10.2 Radiated Emissions Measurement Test Procedure

Before final measurements of radiated emissions were made on the open-field three/ten meter range, the EUT was scanned indoors at one and three meter distances. This was done in order to determine its emissions spectrum signature. The physical arrangement of the test system and associated cabling was varied in order to determine the effect on the EUT's emissions in amplitude, direction and frequency. This process was repeated during final radiated emissions measurements on the open-field range, at each frequency, in order to ensure that maximum emission amplitudes were attained.

Final radiated emissions measurements were made on the three/ten-meter, open-field test site. The EUT was placed on a nonconductive turntable 0.8 meters above the ground plane. The spectrum was examined from 9 kHz to the 10th harmonic of the highest fundamental transmitter frequency (24.8 GHz).

At each frequency, the EUT was rotated 360°, and the antenna was raised and lowered from 1 to 4 meters in order to determine the emission's maximum level. Measurements were taken using both horizontal and vertical antenna polarizations. For frequencies between 30 and 1000 MHz, the spectrum analyzer's 6 dB bandwidth was set to 120 kHz, and the analyzer was operated in the CISPR quasi-peak detection mode. For emissions above 1000 MHz, emissions are measured using the average detector function with a minimum resolution bandwidth of 1 MHz. No video filter less than 10 times the resolution bandwidth was used. The highest emission amplitudes relative to the appropriate limit were measured and recorded in this report.

10.3 Radiated Emissions Harmonics/Spurious Test Data

Table 10-1: Radiated Emissions Harmonics/Spurious - 2402 MHz - Average

| Emission Frequency (MHz) | Calculated Average (dBuV) Peak – 47.6 duty cycle correction | Site Correction Factor (dB/m) | Average Emission Level (dBuV/m) | Average Limit (dBuV/m) | Average Margin (dB) |
|--------------------------|--|-------------------------------|---------------------------------|------------------------|---------------------|
| 4804.0 | 33.1 | -0.4 | 32.7 | 54.0 | -21.3 |
| 12012.0 | 11.9 | 12.0 | 23.9 | 54.0 | -30.1 |
| 19218.0 | 26.1 | 23.6 | 49.7 | 54.0 | -4.3 |

Table 10-2: Radiated Emissions Harmonics/Spurious - 2402 MHz - Peak

| Emission Frequency (MHz) | Peak Analyzer Reading (dBuV) (1 MHz RBW/VBW) | Site Correction Factor (dB/m) | Peak Emission Level (dBuV/m) | Peak Limit (dBuV/m) | Peak Margin (dB) |
|--------------------------|---|-------------------------------|------------------------------|---------------------|------------------|
| 4804.0 | 43.9 | -0.4 | 43.5 | 74.0 | -30.5 |
| 12012.0 | 25.9 | 12.0 | 37.9 | 74.0 | -36.1 |
| 19218.0 | 44.7 | 23.6 | 68.3 | 74.0 | -5.7 |

Table 10-3: Radiated Emissions Harmonics/Spurious - 2441 MHz - Average

| Emission Frequency (MHz) | Calculated Average (dBuV) Peak – 47.6 duty cycle correction | Site Correction Factor (dB/m) | Average Emission Level (dBuV/m) | Average Limit (dBuV/m) | Average Margin (dB) |
|--------------------------|--|-------------------------------|---------------------------------|------------------------|---------------------|
| 4882.0 | 32.7 | -0.3 | 32.4 | 54.0 | -21.6 |
| 7323.0 | 10.4 | 2.6 | 13.0 | 54.0 | -41.0 |
| 12205.0 | 11.9 | 12.1 | 24.0 | 54.0 | -30.0 |
| 19528.0 | 26.5 | 23.9 | 50.4 | 54.0 | -3.6 |

Table 10-4: Radiated Emissions Harmonics/Spurious – 2441 MHz - Peak

| Emission Frequency (MHz) | Peak Analyzer Reading (dBuV) (1 MHz RBW/VBW) | Site Correction Factor (dB/m) 47.6 Duty Cycle Correction | Peak Emission Level (dBuV/m) | Peak Limit (dBuV/m) | Peak Margin (dB) |
|--------------------------|--|--|------------------------------|---------------------|------------------|
| 4882.0 | 43.8 | -0.3 | 43.5 | 74.0 | -30.5 |
| 7323.0 | 18.1 | 2.6 | 20.7 | 74.0 | -53.3 |
| 12205.0 | 25.6 | 12.1 | 37.7 | 74.0 | -36.3 |
| 19528.0 | 43.1 | 23.9 | 67.0 | 74.0 | -7.0 |

Table 10-5: Radiated Emissions Harmonics/Spurious - 2480 MHz - Average

| Emission Frequency (MHz) | Calculated Average (dBuV) Peak – 47.6 duty cycle correction | Site Correction Factor (dB/m) | Average Emission Level (dBuV/m) | Average Limit (dBuV/m) | Average Margin (dB) |
|--------------------------|---|-------------------------------|---------------------------------|------------------------|---------------------|
| 4960.0 | 33.3 | -0.1 | 33.2 | 54.0 | -20.8 |
| 7440.1 | 7.5 | 2.8 | 10.3 | 54.0 | -43.7 |
| 12400.0 | 12.1 | 12.2 | 24.3 | 54.0 | -29.7 |
| 19840.0 | 27.2 | 24.2 | 51.4 | 54.0 | -2.6 |
| 22320.0 | 22.1 | 26.9 | 49.0 | 54.0 | -5.0 |

Table 10-6: Radiated Emissions Harmonics/Spurious – 2480 MHz - Peak

| Emission Frequency (MHz) | Peak Analyzer Reading (dBuV) (1 MHz RBW/VBW) | Site Correction Factor (dB/m) 47.6 Duty Cycle Correction | Peak Emission Level (dBuV/m) | Peak Limit (dBuV/m) | Peak Margin (dB) |
|--------------------------|--|--|------------------------------|---------------------|------------------|
| 4960.0 | 37.6 | -0.1 | 37.5 | 74.0 | -36.5 |
| 7440.1 | 14.2 | 2.8 | 17.0 | 74.0 | -57.0 |
| 12400.0 | 25.9 | 12.2 | 38.1 | 74.0 | -35.9 |
| 19840.0 | 45.7 | 24.2 | 69.9 | 74.0 | -4.1 |
| 22320.0 | 40.7 | 26.9 | 67.6 | 74.0 | -6.4 |

Table 10-7: Radiated Emissions Harmonics/Spurious – Peak Hopping Mode

| Emission Frequency (MHz) | Peak Analyzer Reading (dBuV) (1 MHz RBW/VBW) | Site Correction Factor (dB/m) 47.6 Duty Cycle Correction | Peak Emission Level (dBuV/m) | Peak Limit (dBuV/m) | Peak Margin (dB) |
|--------------------------|--|--|------------------------------|---------------------|------------------|
| 4877.0 | 37.3 | -0.3 | 37.0 | 74.0 | -37.0 |
| 4893.0 | 36.7 | -0.3 | 36.4 | 74.0 | -37.6 |
| 4953.8 | 42.4 | -0.1 | 42.3 | 74.0 | -31.7 |
| 7349.4 | 40.2 | 2.6 | 42.8 | 74.0 | -31.2 |
| 7410.0 | 42.8 | 2.7 | 45.5 | 74.0 | -28.5 |
| 12143.4 | 42.6 | 12.0 | 54.6 | 74.0 | -19.4 |
| 12268.6 | 43.0 | 12.1 | 55.1 | 74.0 | -18.9 |

Table 10-8: Radiated Emissions Harmonics/Spurious - Average Hopping Mode

| Emission Frequency (MHz) | Calculated Average (dBuV) Peak – 47.6 duty cycle correction | Site Correction Factor (dB/m) | Average Emission Level (dBuV/m) | Average Limit (dBuV/m) | Average Margin (dB) |
|--------------------------|---|-------------------------------|---------------------------------|------------------------|---------------------|
| 4877.0 | 26.8 | -0.3 | 26.5 | 54.0 | -27.5 |
| 4893.0 | 27.4 | -0.3 | 27.1 | 54.0 | -26.9 |
| 4953.8 | 28.1 | -0.1 | 28.0 | 54.0 | -26.0 |
| 7349.4 | 26.9 | 2.6 | 29.5 | 54.0 | -24.5 |
| 7410.0 | 28.2 | 2.7 | 30.9 | 54.0 | -23.1 |
| 12143.4 | 29.0 | 12.0 | 41.0 | 54.0 | -13.0 |
| 12268.6 | 28.7 | 12.1 | 40.8 | 54.0 | -13.2 |

Table 10-9: Radiated Emissions Test Equipment

| RTL Asset # | Manufacturer | Model | Part Type | Serial Number | Calibration Due Date |
|-------------|-------------------------|-------------------|--|---------------|----------------------|
| 900932 | Hewlett Packard | 8449B OPT H02 | Preamplifier (1 - 26.5 GHz) | 3008A00505 | 9/10/16 |
| 900878 | Rhein Tech Laboratories | AM3-1197-0005 | 3 meter antenna mast, polarizing | OATS1 | N/A |
| 901592 | Insulated Wire Inc. | KPS-1503-3600-KPR | SMK RF Cables 20' | NA | 9/4/16 |
| 901593 | Insulated Wire Inc. | KPS-1503-360-KPR | SMK RF Cables 36" | NA | 9/4/16 |
| 901594 | Insulated Wire Inc. | KPS-1503-360-KPR | SMK RF Cables 36" | NA | 9/4/16 |
| 901242 | Rhein Tech Laboratories | WRT-000-0003 | Wood rotating table | N/A | N/A |
| 900791 | Chase | CBL6111B | Bilog Antenna (30 MHz – 2000 MHz) | N/A | 6/11/17 |
| 900321 | EMCO | 3161-03 | Horn Antennas (4 – 8 GHz) | 9508-1020 | 4/09/18 |
| 900323 | EMCO | 3160-07 | Horn Antennas (8.2 – 12 GHz) | 9605-1054 | 4/09/18 |
| 900356 | EMCO | 3160-08 | Horn Antennas (12.4 – 18 GHz) | 9607-1044 | 4/09/18 |
| 901218 | EMCO | 3160-09 | Horn Antenna (18 - 26 GHz) | 960281-003 | 4/14/18 |
| 900772 | EMCO | 3161-02 | Horn Antenna (2 - 4 GHz) | 9804-1044 | 4/09/18 |
| 900930 | Hewlett Packard | 85662A | Spectrum Analyzer Display Section | 3144A20839 | 4/21/16 |
| 900931 | Hewlett Packard | 8566B | Spectrum Analyzer (100 Hz - 22 GHz) | 3138A07771 | 4/21/16 |

Test Personnel:

| | | |
|---|--|------------------------------------|
| Daniel W. Baltzell EMC Test Engineer |  Signature | March 11-15, 2016 Dates of Test |
|---|--|------------------------------------|

11 Conclusion

The data in this measurement report shows that the **Harris Corporation Model XG-25P 700/800 MHz, FCC ID: OWDTR-0140-E, IC: 3636B-0140**, complies with the applicable requirements of FCC Part 15 and Part 2, and IC RSS-247.