

Figure 17 - Tx Synthesizer disassembled

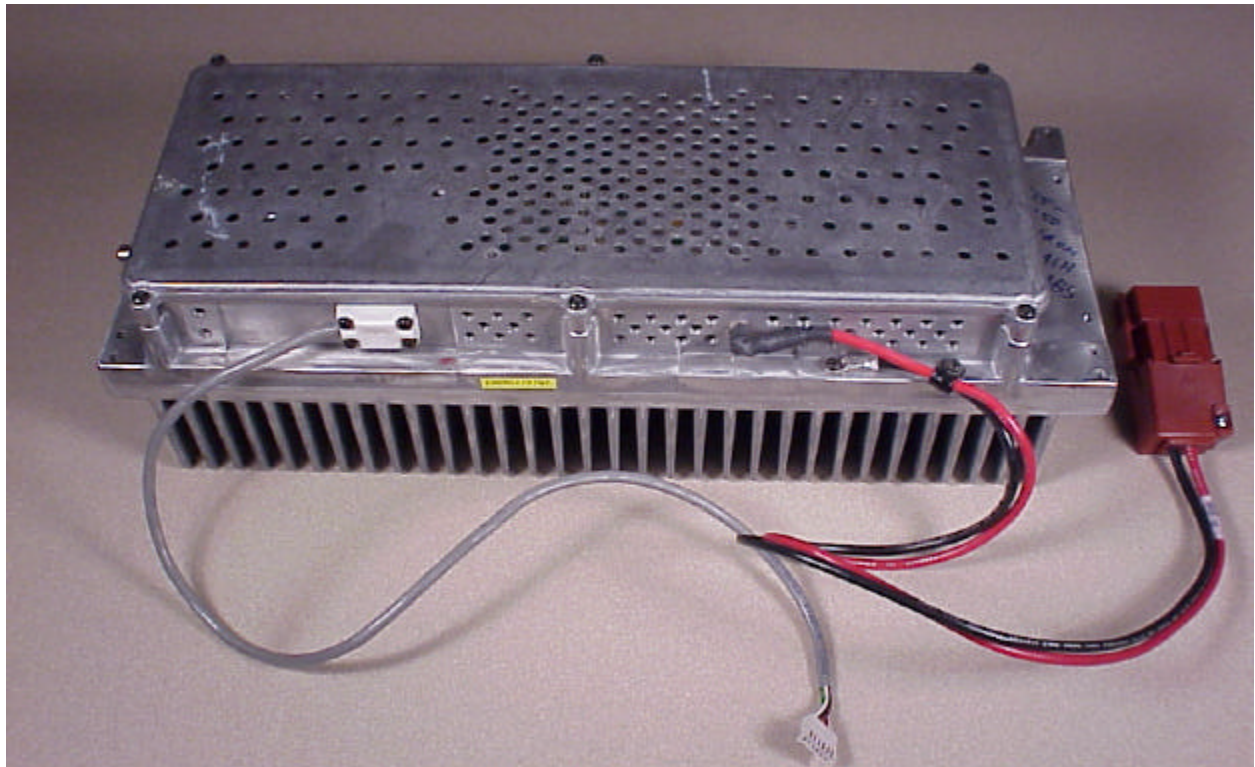

Figure 18 - PA overall

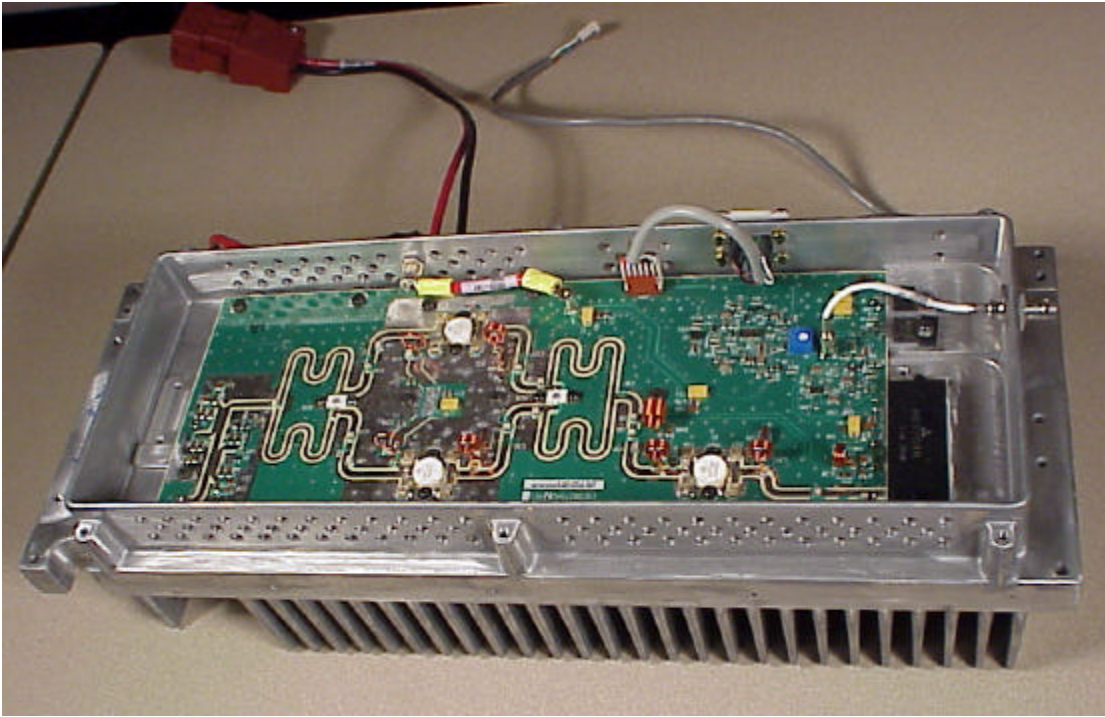

Figure 19 - PA with cover removed

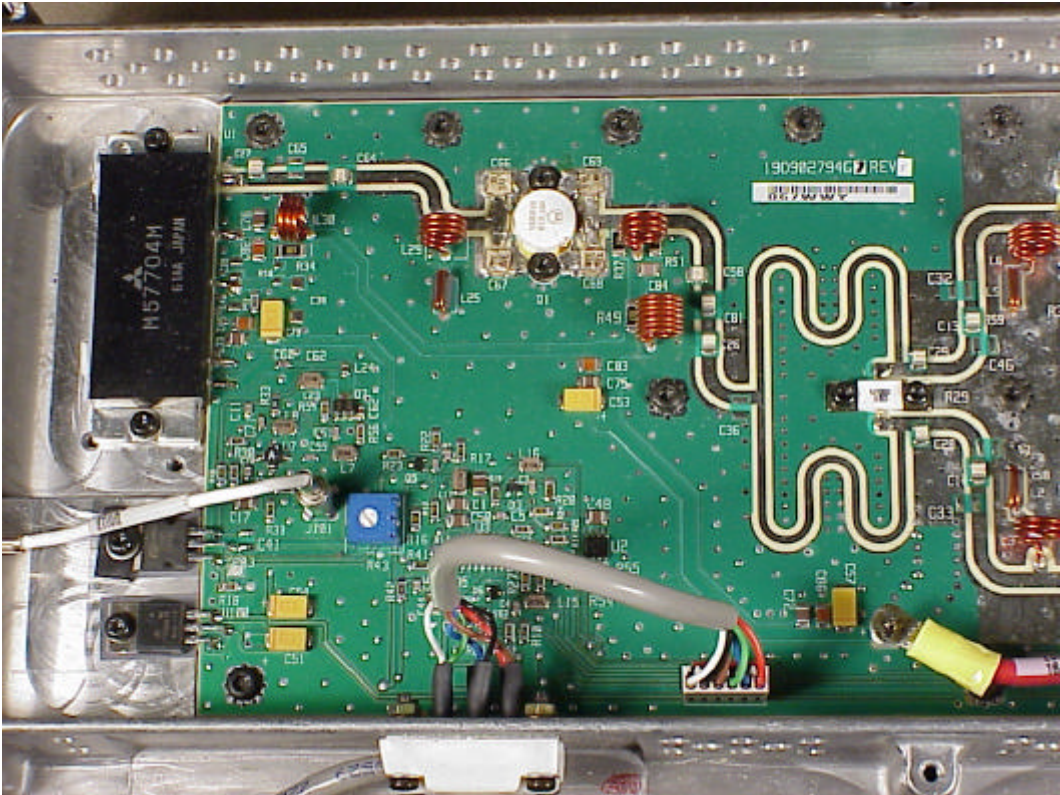

Figure 20 - PA board top, input end

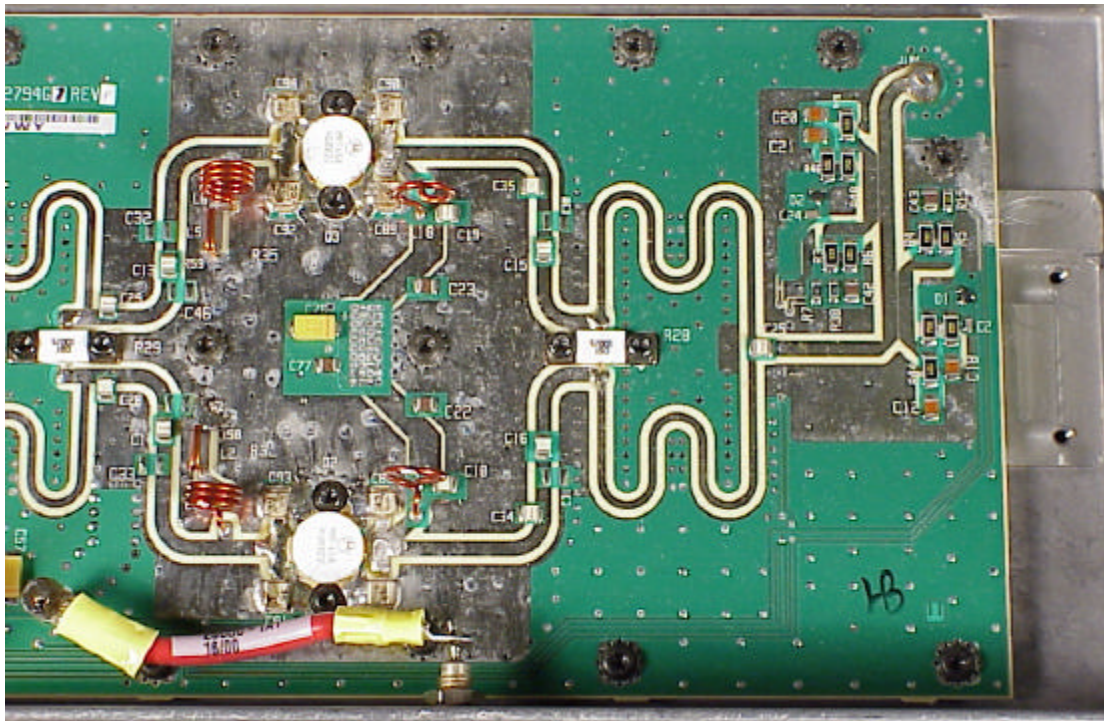

Figure 21 - PA board top, output end

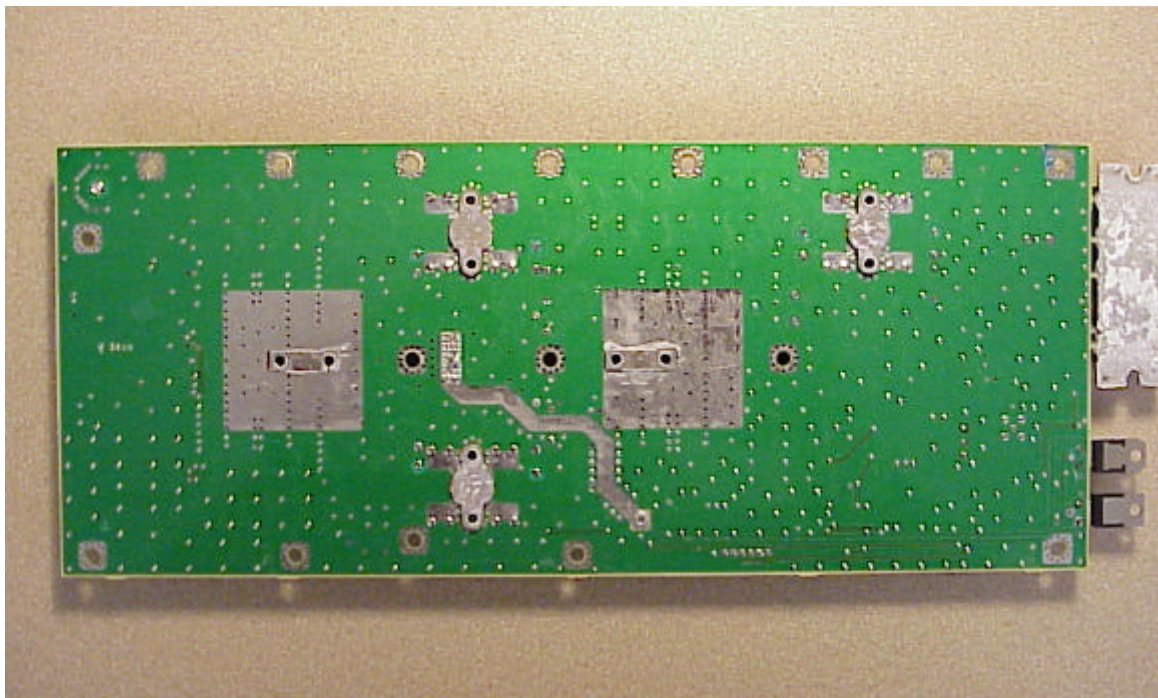

Figure 22 - PA board bottom

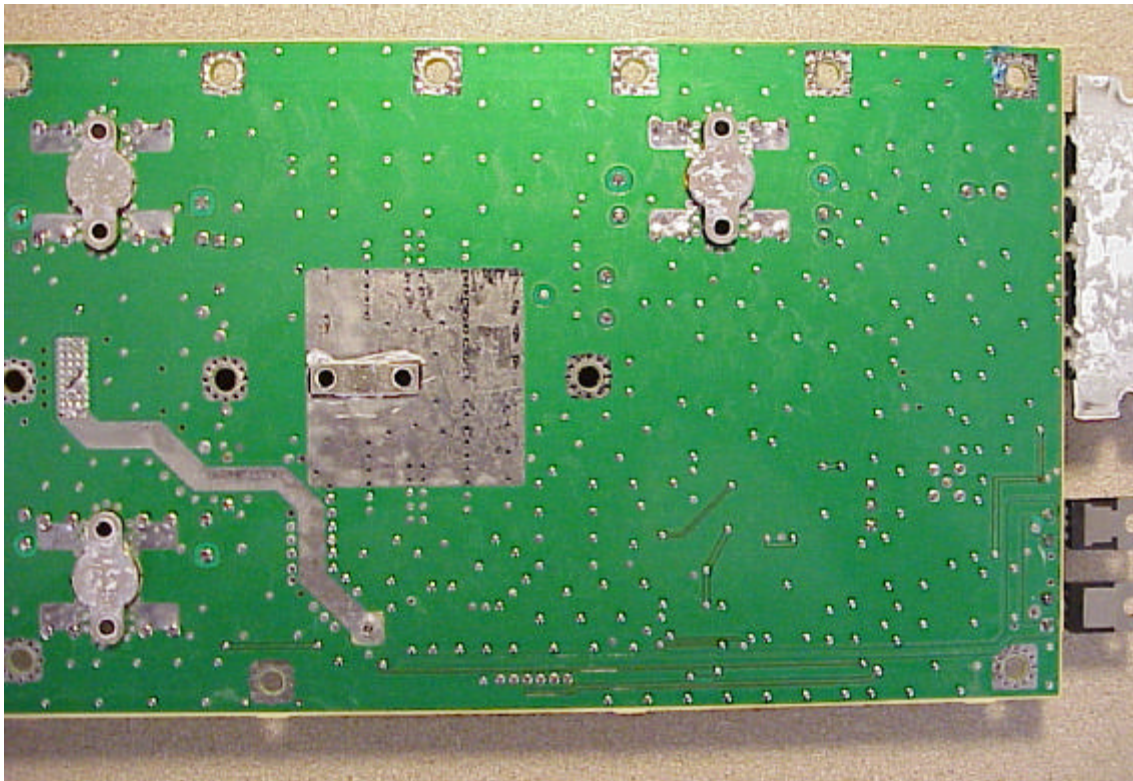

Figure 23 - PA board bottom - input end

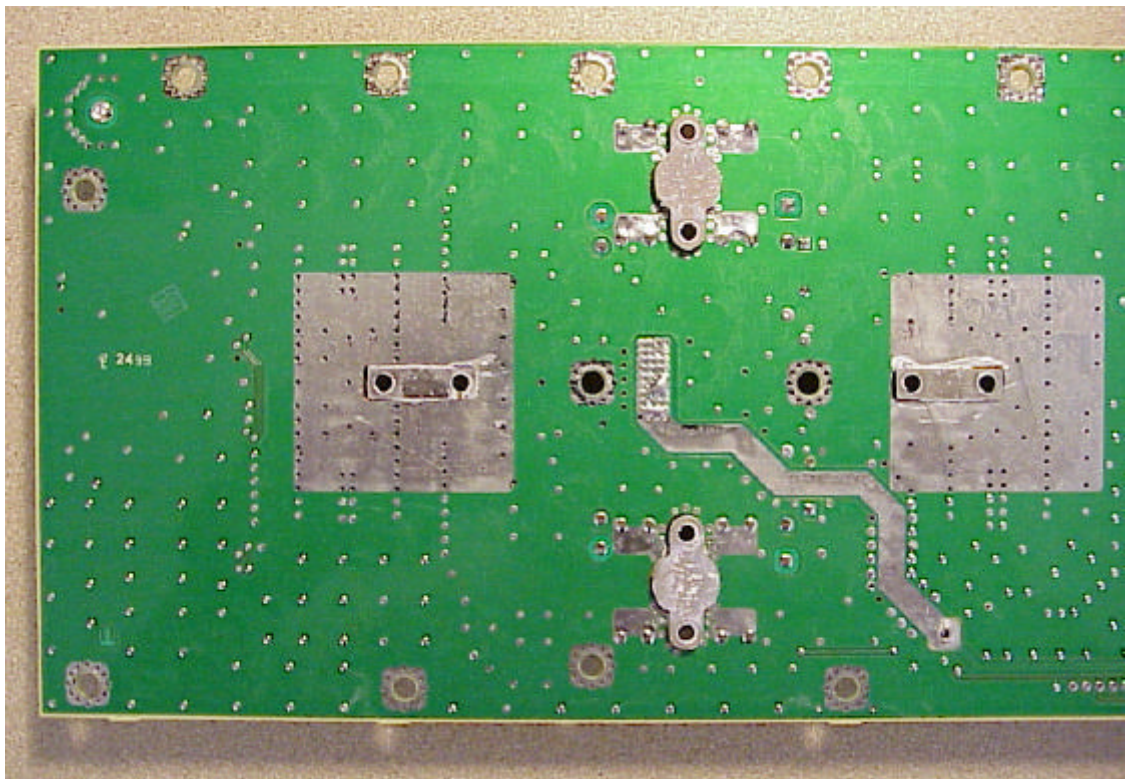

Figure 24 - PA board bottom - output end

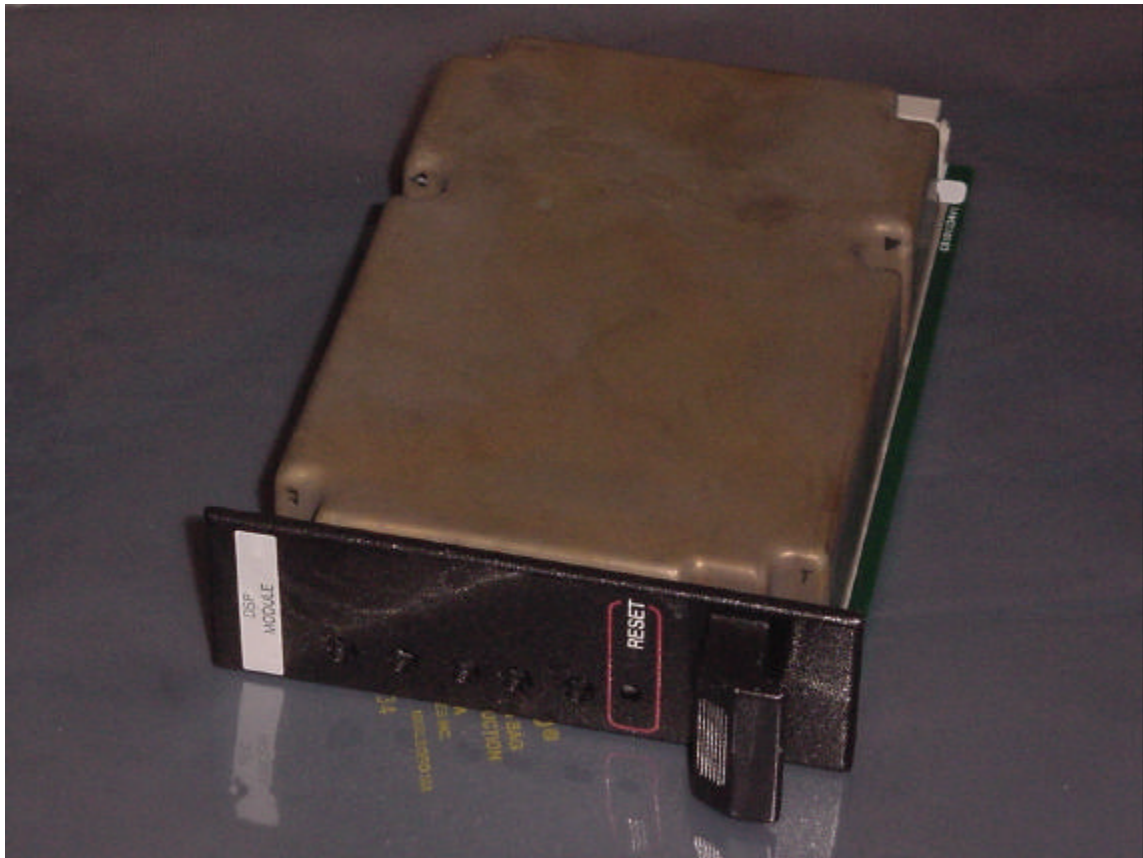

Figure 25 - Power Module overall

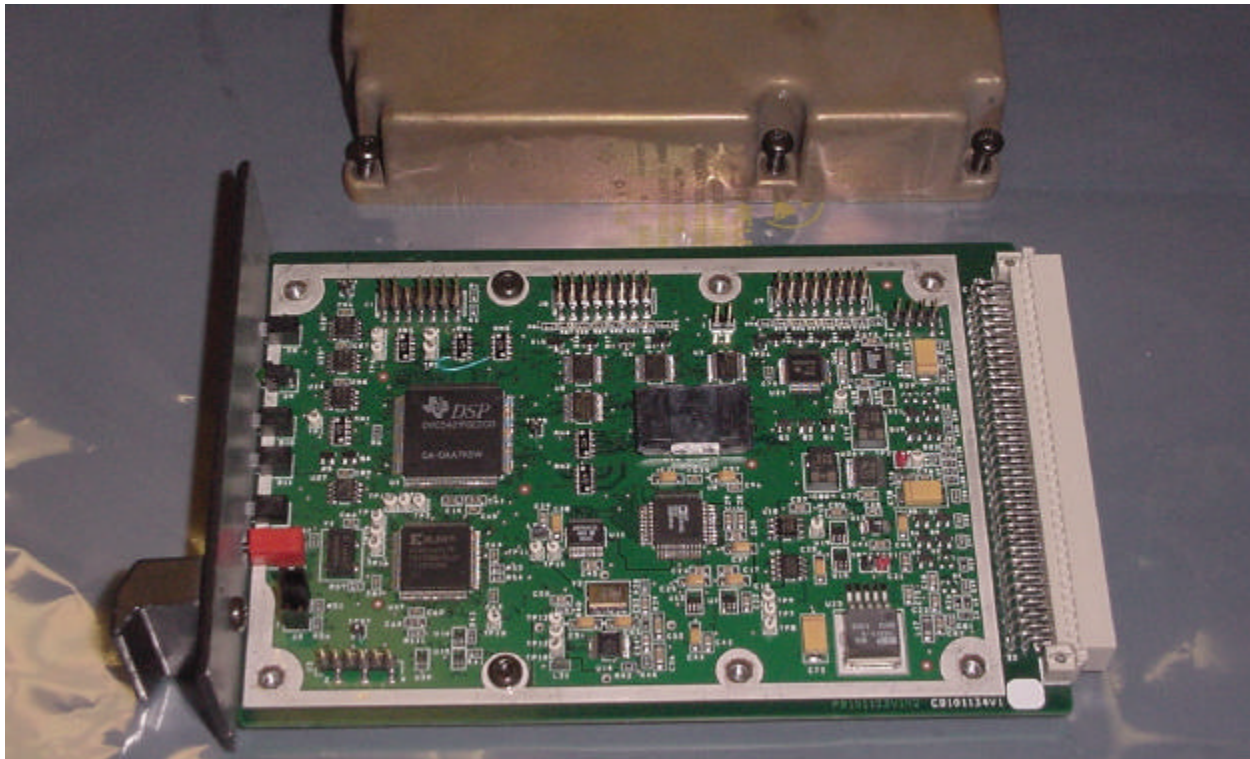

Figure 26 - Power Module board top

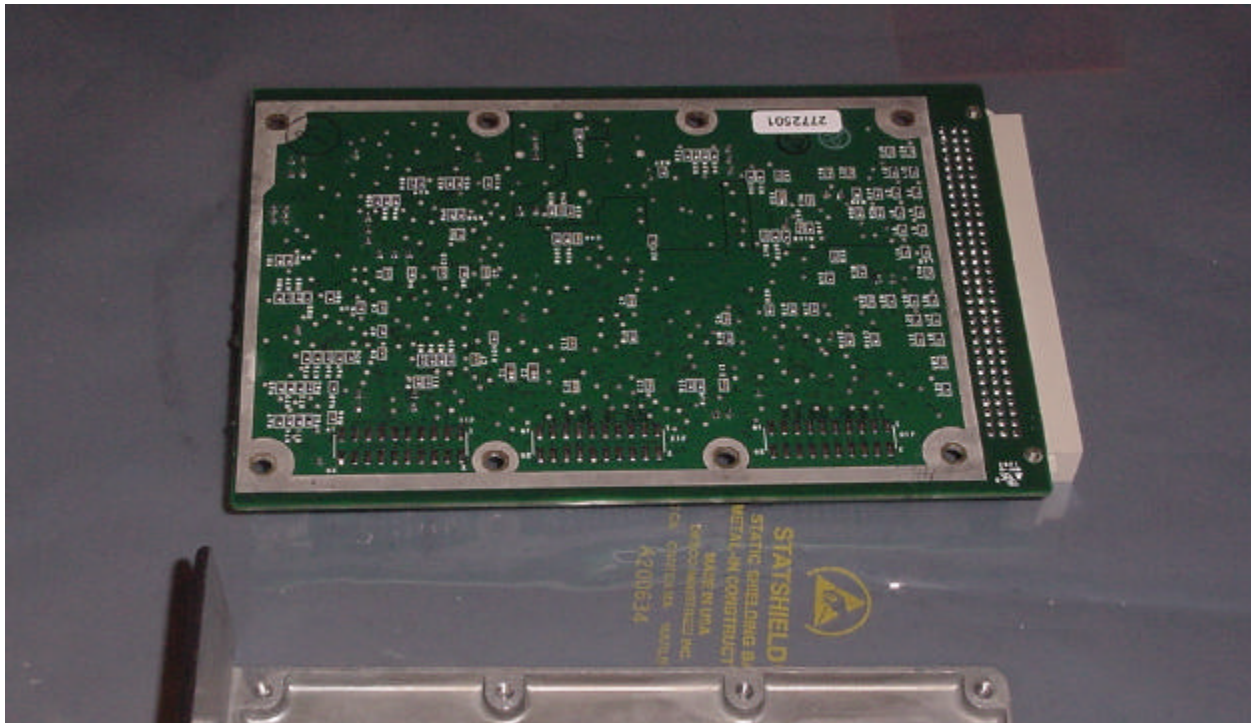

Figure 27 - Power Module board bottom

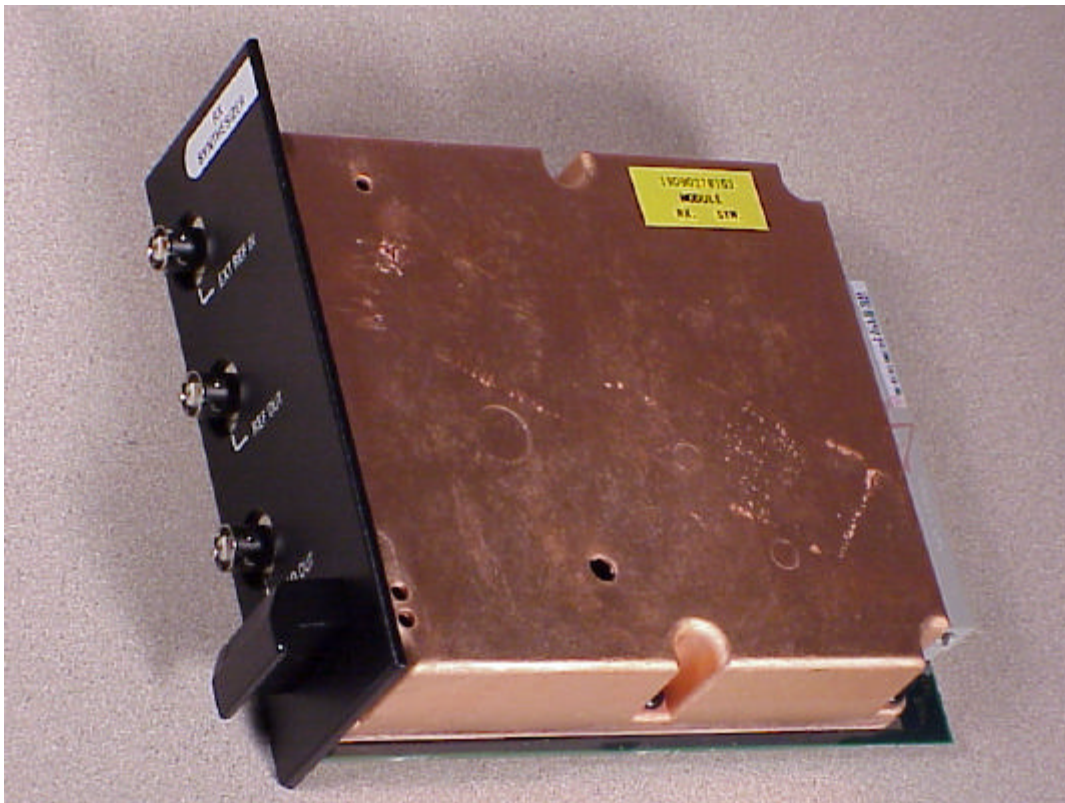

Figure 28 - Rx Synthesizer overall

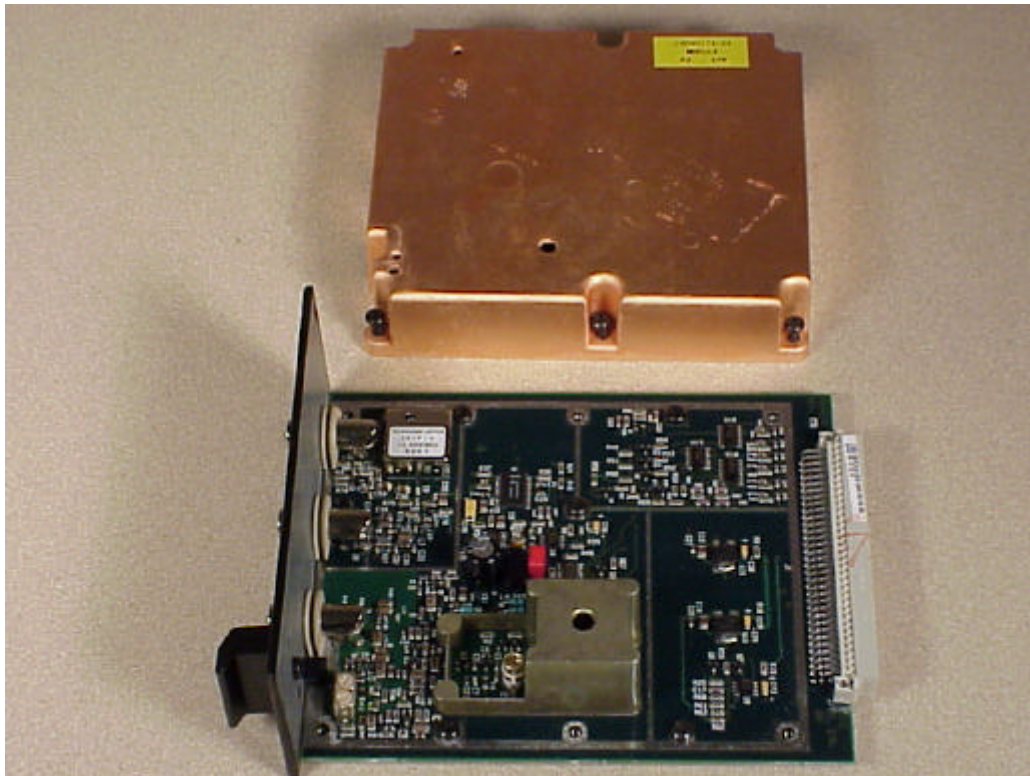

Figure 29 - Rx Synthesizer cover removed

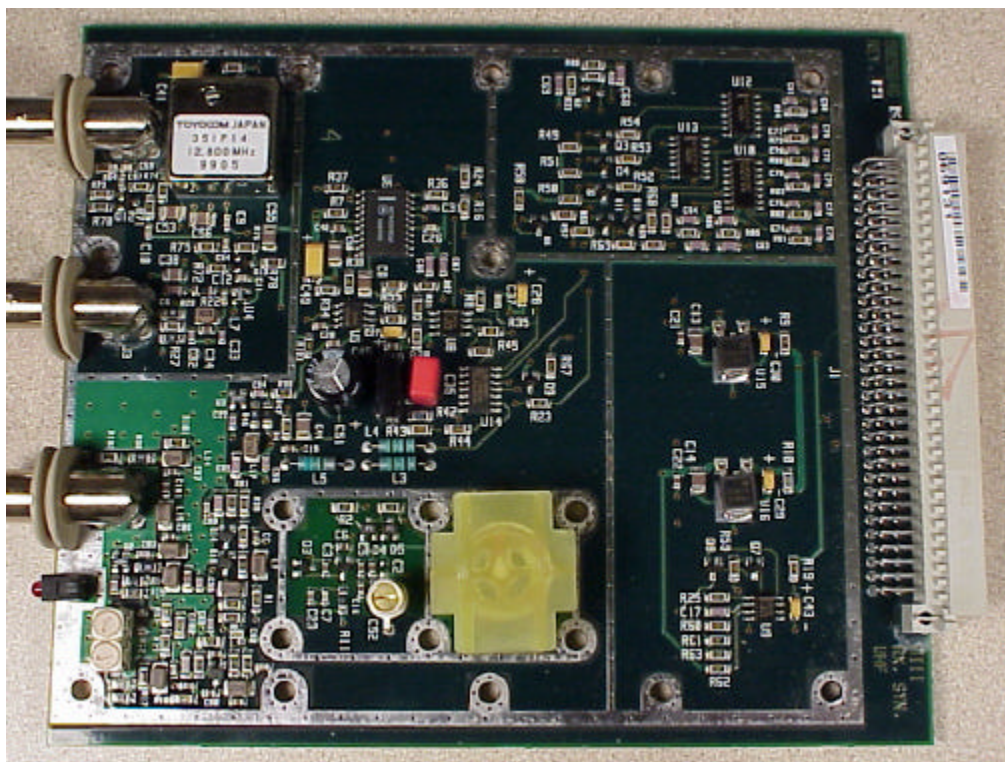

Figure 30 - Rx Synthesizer board top

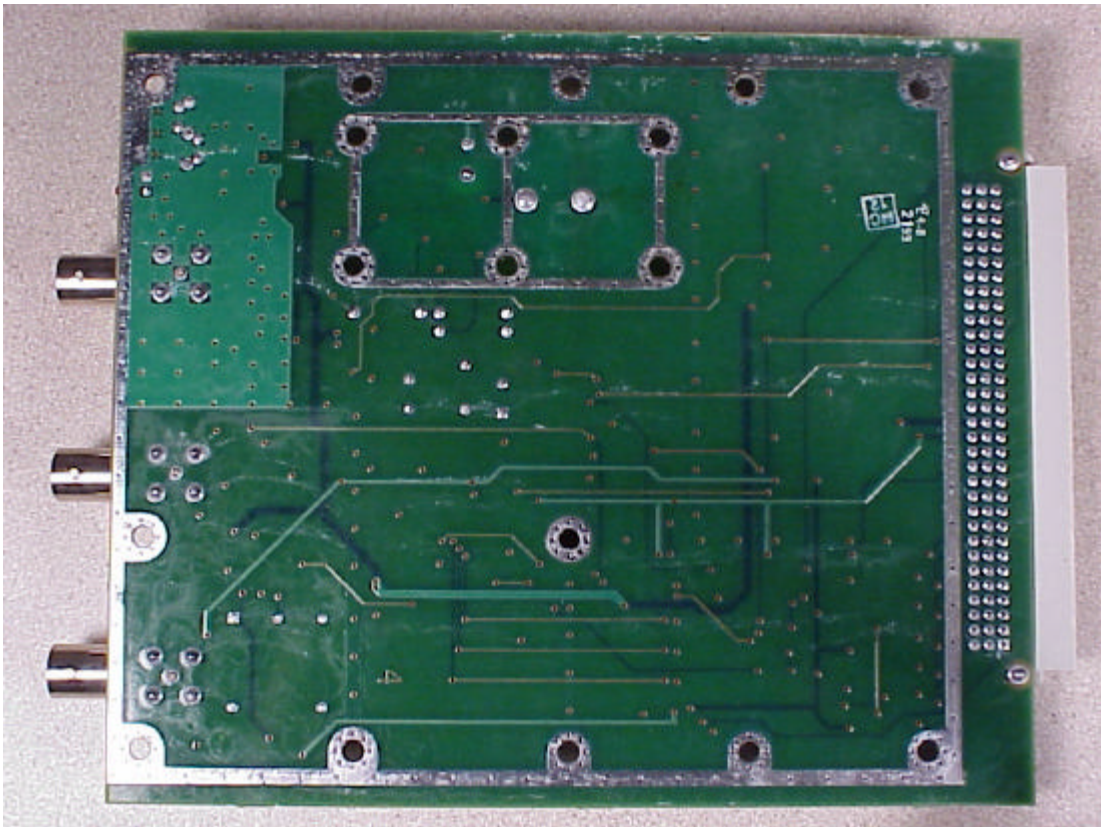

Figure 31 - Rx Synthesizer board bottom

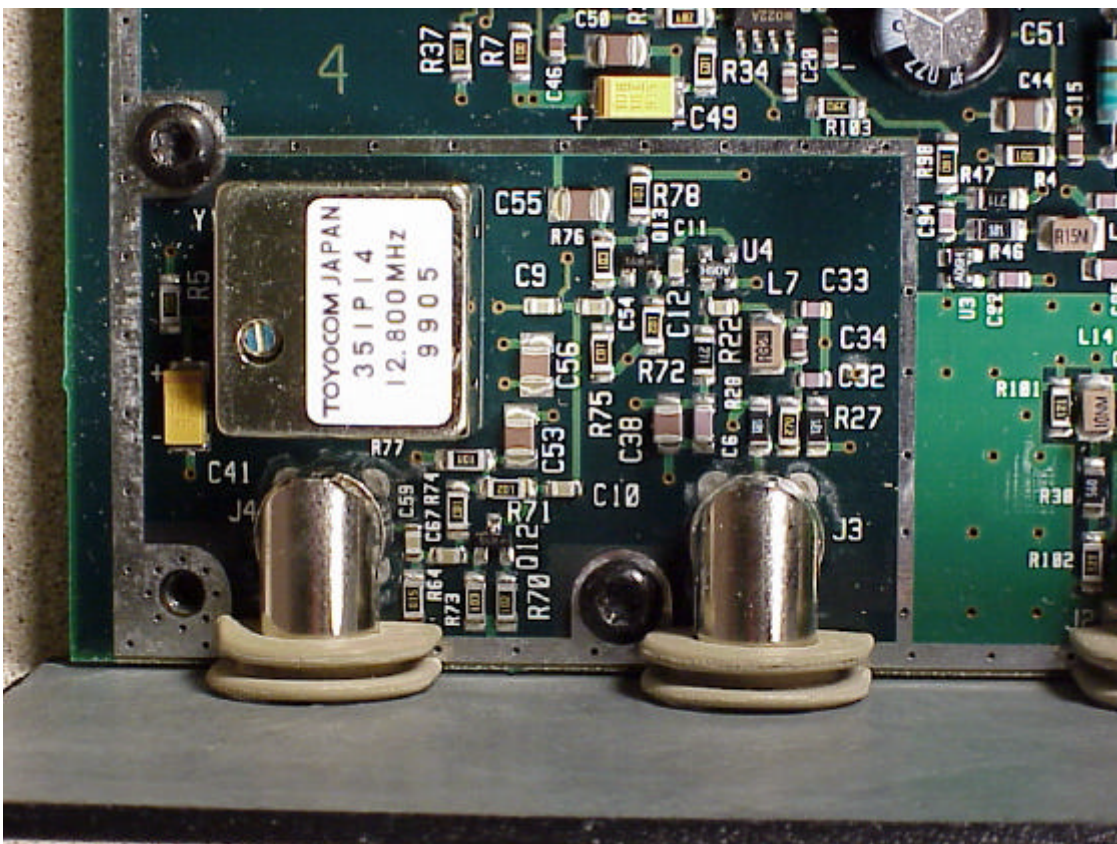

Figure 32 - Rx Synthesizer frequency reference

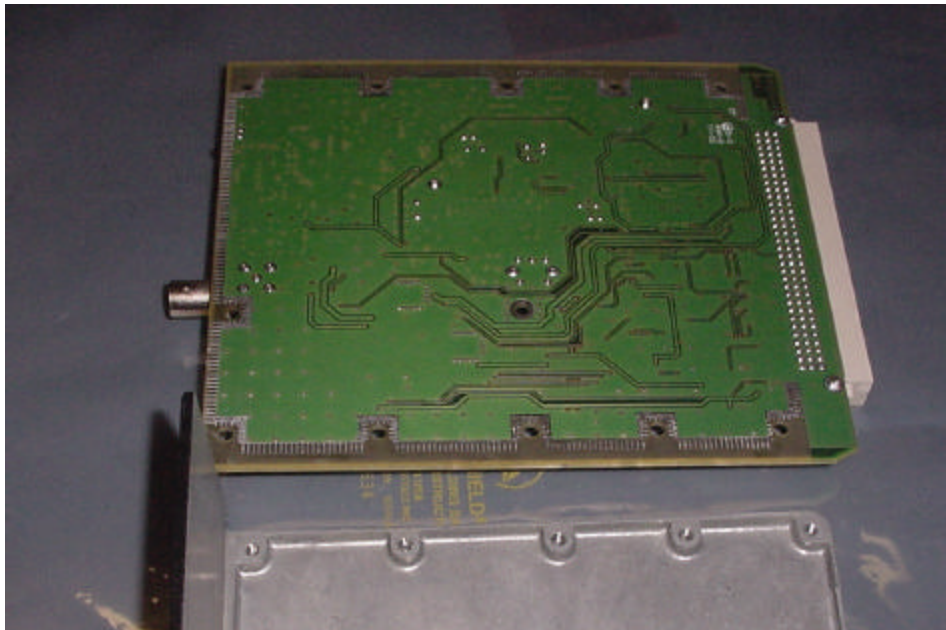



**Figure 33 - Rx IF overall**



**Figure 34 - Rx IF board top**



**Figure 35 - Rx IF board bottom**