

future
The Future of Mobile Radio

EDACS® Interface Panels 19D904009G1-G32

TABLE OF CONTENTS

EDACS® Interface Module.....	LBI-38813
PTT Module.....	LBI-38816
EDACS® CTIS Module	LBI-38818
Power Monitor for Simulcast.....	LBI-38819
EDACS® Interface VAX Site Controller	LBI-38943
Power Monitor / Channel Select Module.....	LBI-38944
Simulcast 150 Baud Interface Module.....	LBI-38945
Euro EDACS® Interface Board.....	LBI-38946
RIC Transformer Signal In/Out Isolation.....	LBI-38947
EDACS® Interface TUAI for Simulcast.....	LBI-38948
STN-Voter Interface Board.....	LBI-39021
RIC-Voter Interface Board.....	LBI-39022
Timing Interface Module	LBI-39099
Serial Interface Module.....	LBI-39136
Power Sensor Interface Module	LBI-39137
Site Sentry/ELI/SIM Interface Board.....	EN/LZB 119 3775/1
Prism ELI Audio Interface Module.....	AE/LZB 119 4106/1

MANUAL REVISION

LBI-38812J – Added EDACS Interface Panels 19C904009G31 and G32 used in **SitePro** applications. Updated parts list and all drawings to the latest revision (*Revision 5*). Reformatted manual for M/A-COM Private Radio Systems, Inc.

LBI-38812K – Added revised drawing, 19D904009 (Revision 7), and safety information

SAFETY NOTICE

- The means of disconnecting power from a station cabinet is the cabinet power supply plug.
- When conducting repair/maintenance, disconnect the cabinet power supply plug from the AC source.
- In European applications, equipment must be installed in a closed cabinet.
- Only replace components with components specified by M/A-COM Private Radio Systems, Inc.

NOTICE!

This manual covers **M/A-COM Private Radio Systems, Inc.**, products manufactured and sold by **M/A-COM Private Radio Systems, Inc.**

NOTICE!

Repairs to this equipment should be made only by an authorized service technician or facility designated by the supplier. Any repairs, alterations or substitution of recommended parts made by the user to this equipment not approved by the manufacturer could void the user's authority to operate the equipment in addition to the manufacturer's warranty.

NOTICE!

The software contained in this device is copyrighted by **M/A-COM Private Radio Systems, Inc.** Unpublished rights are reserved under the copyright laws of the United States.

This manual is published by **M/A-COM Private Radio Systems, Inc.**, without any warranty. Improvements and changes to this manual necessitated by typographical errors, inaccuracies of current information, or improvements to programs and/or equipment, may be made by **M/A-COM Private Radio Systems, Inc.**, at any time and without notice. Such changes will be incorporated into new editions of this manual. No part of this manual may be reproduced or transmitted in any form or by any means, electronic or mechanical, including photocopying and recording, for any purpose, without the express written permission of **M/A-COM Private Radio Systems, Inc.**

Copyright © 1994-2002 M/A-COM Private Radio Systems, Inc. All rights reserved.

TABLE OF CONTENTS

	<u>Page</u>
1.0 SPECIFICATIONS	4
2.0 PANEL DESCRIPTIONS	5
3.0 MODULE DESCRIPTIONS	9
4.0 PARTS LIST	11
5.0 STATION ASSEMBLY DIAGRAMS:.....	12
EDACS INTERFACE PANEL (G1) – STATION ASSEMBLY	12
EDACS INTERFACE PANEL (G2) - CTIS MAIN COMPUTER CABINET	13
EDACS INTERFACE PANEL (G3) – CTIS RIC CABINET	14
EDACS INTERFACE PANEL (G4) – SIMULCAST STATION.....	15
EDACS INTERFACE PANEL (G5) – SIMULCAST TX COMMON EQUIPMENT	16
EDACS INTERFACE PANEL (G6) – SITE CONTROLLER-PDP11	17
EDACS INTERFACE PANEL (G7) – AUXILIARY RECEIVER – MODEM.....	18
EDACS INTERFACE PANEL (G8) – EURO EDACS ASSEMBLY	19
EDACS INTERFACE PANEL (G9) – GETC SIMULCAST CONTROL POINT (1-12).....	20
EDACS INTERFACE PANEL (G10) – GETC SIMULCAST CONTROL POINT (13-20).....	21
EDACS INTERFACE PANEL (G11) – VOTER INTERFACE PANEL	22
EDACS INTERFACE PANEL (G12) – SITE CONTROLLER VAX-DEC (#1)	23
EDACS INTERFACE PANEL (G13) – SITE CONTROLLER VAX-DEC (#2)	24
EDACS INTERFACE PANEL (G14) – CTIS MAIN COMPUTER VAX-DEC.....	25
EDACS INTERFACE PANEL (G15) – SIMULCAST CONTROL POINT	26
EDACS INTERFACE PANEL (G16) – EURO EDACS LEASED LINE INTERFACE.....	27
EDACS INTERFACE PANEL (G17) – RIC TRANSFORMER PANEL.....	28
EDACS INTERFACE PANEL (G18) – JESSICA CONTROL	29
EDACS INTERFACE PANEL (G19) – DVIU INTERFACE PANEL.....	30
EDACS INTERFACE PANEL (G20) – STN VOTER INTERFACE.....	31
EDACS INTERFACE PANEL (G21) – VOTER RIC INTERFACE.....	32
EDACS INTERFACE PANEL (G22) – AUXILIARY RECEIVER RS-232	33
EDACS INTERFACE PANEL (G23) – AUXILIARY RECEIVER CONVENTIONAL.....	34
EDACS INTERFACE PANEL (G25) – SIMULCAST TX STE (RS-232 DATA).....	35
EDACS INTERFACE PANEL (G26) – SIM INTERFACE PANEL.....	36
EDACS INTERFACE PANEL (G28) – SITE SENTRY/ELI/SIM (MASTR III).....	37
EDACS INTERFACE PANEL (G29) – PRISM SITE SENTRY/SIM	38
EDACS INTERFACE PANEL (G30) – PRISM ELI AUDIO	39
EDACS INTERFACE PANEL (G31 & G32) – STATION ASSEMBLY WITH SITEPRO.....	40

1.0 SPECIFICATIONS¹

- DIMENSIONS..... 19" wide X 5 1/4" high (3 RU)
- MOUNTING..... Fits standard 19-inch equipment rack.
- MODULES Provides mounting space for one 1 7/8" wide X 5 1/8" high module, and up to five 3" wide X 5 1/8" high modules. (Spaces may also be combined to accommodate wider modules.)

¹ These specifications are intended primarily for the use of the service technician. Refer to the appropriate Specifications Sheet in the applicable maintenance manual for the complete specifications.

2.0 PANEL DESCRIPTIONS

The 19D904009G1 through G30 (group 1 through group 30) Enhanced Digital Access Communications System (EDACS) Interface Panels are used as the connection points between cables outside and cables inside an EDACS equipment cabinet. The EDACS Interface Panels are intended to simplify the wiring between EDACS equipment cabinets through the use of standard cables and easily accessible connection points.

Each EDACS Interface Panel consists of a frame on which one or more interface modules are mounted. Each EDACS Interface Panel group number, representing one combination of these interface modules, is described below. The Assembly Diagrams located at the end of this manual, show where and which interface modules are mounted on the frame.

19D904009G1 Station Assembly - This interface panel provides the connection points for the standard EDACS Repeater cabinet to accommodate the IDA Local Telephone Interconnect. See Assembly Diagram 19D904009, Sheet 1, Part 1 (*number in circle*).

19D904009G2 CTIS Main Computer Cabinet - This interface panel provides the connection points for the CTIS Main Computer cabinet to accommodate the PDP computer. See Assembly Diagram 19D904009, Sheet 2, Part 7 (*number in circle*).

19D904009G3 CTIS RIC Cabinet - This interface panel provides the connection points for the cabinet containing the CTIS RIC's. See Assembly Diagram 19D904009, Sheet 3, Part 9 (*number in circle*).

19D904009G4 Simulcast Station - This interface panel provides the connection points for the Simulcast Station cabinet. See Assembly Diagram 19D904009, Sheet 4, Part 12 (*number in circle*).

19D904009G5 Simulcast Tx Common Equipment - This interface panel provides the connection points for the cabinet containing the common equipment at a Simulcast transmit site. See Assembly Diagram 19D904009, Sheet 5, Part 14 (*number in circle*).

19D904009G6 Site Controller - PDP11 - This interface panel provides the connection points for the Site Controller cabinet to accommodate the PDP computer. See Assembly Diagram 19D904009, Sheet 6, Part 20 (*number in circle*).

19D904009G7 Auxiliary Receiver - Modem - This interface panel provides the connection points for voice and data circuits to a cabinet containing Auxiliary Receivers. See Assembly Diagram 19D904009, Sheet 7, Part 37 (*number in circle*).

19D904009G8 Euro EDACS Assembly - This interface panel provides the connection points for station audio and modem data circuits in some European EDACS applications. See Assembly Diagram 19D904009, Sheet 8, Part 38 (*number in circle*).

19D904009G9 GETC Simulcast Control Point (1-12) - This interface panel provides the connection points for the cabinet containing the GETC's for channels 1 through 12 at the Control Point location in a Simulcast System. See Assembly Diagram 19D904009, Sheet 9, Part 39 (*number in circle*).

19D904009G10 GETC Simulcast Control Point (13-20) - This interface panel provides the connection points for the cabinet containing the GETC's for channels 13 through 20 at the Control Point location in a Simulcast System. See Assembly Diagram 19D904009, Sheet 10, Part 40 (*number in circle*).

19D904009G11 Voter Interface Panel - This interface panel provides the connection points for the cabinet containing the Voter at the Main location in a Voted System or at the Control Point location in a Simulcast System. See Assembly Diagram 19D904009, Sheet 11, Part 41 (*number in circle*).

19D904009G12 Site Controller VAX-DEC (#1) - This interface panel (along with G13) provides the connection points for the Site Controller cabinet to accommodate the VAX computer. See Assembly Diagram 19D904009, Sheet 12, Part 42 (*number in circle*).

19D904009G13 Site Controller VAX-DEC (#2) - This interface panel (along with G12) provides the connection points for the Site Controller cabinet to accommodate the VAX computer. See Assembly Diagram 19D904009, Sheet 13, Part 43 (*number in circle*).

19D904009G14 CTIS Main Computer VAX-DEC - This interface panel replaces the G2 CTIS Main Computer Cabinet Panel, to accommodate a VAX computer, and provides the connection points for the latest CTIS Main Computer cabinet. See Assembly Diagram 19D904009, Sheet 14, Part 44 (*number in circle*).

19D904009G15 Simulcast Control Point - This interface panel is used to re-map jackfield appearances of 150-Baud data at the Control Point location in a Simulcast System. See Assembly Diagram 19D904009, Sheet 15, Part 45 (*number in circle*).

19D904009G16 Euro EDACS Lease Line Interface - This interface panel provides connection points for some European EDACS applications requiring 8-pin modular RJ11 type connectors. See Assembly Diagram 19D904009, Sheet 16, Part 46 (*number in circle*).

19D904009G17 RIC Transformer Panel - This interface panel provides connection points and isolation transformers for the RIC audio circuits to the cabinet containing the RIC Shelves at a CTIS site, or the Control Point location in a Simulcast System. See Assembly Diagram 19D904009, Sheet 17, Part 47 (*number in circle*).

19D904009G18 Jessica Control - This interface panel provides connection points for the EDACS Data Gateway cabinet in the Jessica centralized telephone interconnect system. See Assembly Diagram 19D904009, Sheet 18, Part 48 (*number in circle*).

19D904009G19 DVIU Interface Panel - This interface panel provides connection points for the Console Interface Unit. See Assembly Diagram 19D904009, Sheet 19, Part 49 (*number in circle*).

19D904009G20 STN Voter Interface - This interface panel provides the connection points between modem shelves and the IMC switch (or the Voter Selector GETC) for a Simulcast System. See Assembly Diagram 19D904009, Sheet 20, Part 50 (*number in circle*).

19D904009G21 Voter RIC Interface - This interface panel provides connection points at the Control Point location in a Simulcast System. See Assembly Diagram 19D904009, Sheet 21, Part 51 (*number in circle*).

19D904009G22 Auxiliary Receiver RS-232 - This interface panel provides the connection points for a cabinet containing trunked MASTR III Auxiliary Receivers. See Assembly Diagram 19D904009, Sheet 22, Part 52 (*number in circle*).

19D904009G23 Auxiliary Receiver Conventional - This interface panel provides the connection points for a cabinet containing conventional MASTR III Auxiliary Receivers. When this interface panel is used in the Voter 95 application, see LBI-39075. See Assembly Diagram 19D904009, Sheet 23, Part 53 (*number in circle*).

19D904009G24 Station Assembly with GTI - This interface panel provides the connection points for the standard EDACS Repeater cabinet to accommodate the ELI Local Telephone Interconnect. See Assembly Diagram 19D904009, Sheet 1, Part 54 (*number in circle*).

19D904009G25 Simulcast Tx Site (RS-232 Data) - This interface panel provides the connection points for the channel clock signal circuits between the Channel Bank, the Universal Sync. Shelf, and the Digital Cross Connect Panel (at the Control Point location) or the Transmit Cross Connect Panel (*at a Transmit Site*) in a Simulcast System. See Assembly Diagram 19D904009, Sheet 24, Part 55 (*number in circle*).

19D904009G26 – SIM Interface Panel - This interface panel provides the connection points for the Site Interface Module (SIM) used in MASTR III station Hotline enhanced telephone interconnect applications (Site Sentry & ELI). See Assembly Diagram 19D904009, Sheet 26, Part 60 (*number in circle*).

19D904009G27 – ELI/Site Controller Panel – This interface panel provides the connection points for the Site Sentry module and Site Interface Module (SIM) used in EDACS PRISM station Hotline enhanced telephone interconnect applications. See Assembly Diagram 19D904009, Sheet 27, Part 61 (*number in circle*).

19D904009G28 SITE SENTRY/ELI/SIM (MASTR III) – This Interface Panel provides the connections points in a MASTR III system for the power sensor circuits in the system to the Site Sentry module. It also connects the Site Sentry module to the Orion Test Unit module via the Site Interface module.

19D904009G29 PRISM SITE SENTRY/ELI/SIM – This Interface Panel provides the connection points in a Prism MASTR system for the system to the Site Sentry module to the Orion Test Unit module via the Site Interface module. Connections between the PM BSL/FSL are made via the Serial Interface module to the SIM shelf.

19D904009G30 PRISM ELI AUDIO – This Interface Panel provides the connection points in a Prism MASTR system for the Tx audio and intercom audio from each channel to its appropriate ELI shelf. It also connects the ELI shelf to the telephone lines.

19D904009G31 STATION ASSEMBLY W/SITEPRO (Cabinet w/SIM) – This interface panel provides the connection points for the standard EDACS repeater cabinet w/SitePro. Connection points provided are BSL 0, BSL 1, Downlink Data, GTI Audio, Station Audio and Power Sensor. See Assembly drawing 19D904009, Sheet 29, Part 64 (*number in circle*).

19D904009G32 STATION ASSEMBLY W/SITEPRO (Cabinet wo/SIM) – This interface panel provides the connection points for the standard EDACS repeater cabinet w/SitePro. Connection points provided are BSL 0, BSL1, Ethernet, GTI Audio, Station Audio and Power Sensor. See Assembly drawing 19D904009, Sheet 29, Part 64 (*number in circle*).

A summary of how many of which interface modules make up each EDACS Interface Panel by group number is shown in Table I.

PANEL DESCRIPTIONS

Table 1 – Module Makeup of EDACS Interface Panels by Group Number

INTERFACE MODULE	19D904009G1 THROUGH G32 EDACS INTERFACE PANEL																																			
	DRAWING NO.	1	2	3	4	5	6	7	8	9	10	11	12	13	14	15	16	17	18	19	20	21	22	23	24	25	26	27	28	29	30	31	32			
19C852204G1	5	2	4	2	1	2	2	2	2	2	2	2	3	4	2	4	4	3	1	4	1	1	1	2	3	2										
19C852213G1					1																															
19C852215G1					1																															
19C852218G1					1																															
19C852226G1			1						2																											
19C852313G1											2	1																								
19C852327G1												2	1				2	1						1	1	1	1	1	1	1	1	1	1	1	1	
19C852339G1					1																															
19C852349G1																	2																			
19C852447G1	1	1		1	1	1						1	1											1	1							1	2	2		
19D904427G1																1																				
19D904678G1																							1													
19D904833G1																							1													
188D5120G1																								1												
ROA1172209																									1											
ROA1172410/1																																		1	1	
ROA1172442/1																																				
ROA1172485/1																																			1	
FM101263V1																																				1
CN101314V1																																				4

Panel Names:

- 19D904009G1 - Station Assembly
- 19D904009G2 - CTIS Main Computer Cabinet
- 19D904009G3 - CTIS RIC Cabinet
- 19D904009G4 - Simulcast Station
- 19D904009G5 - Simulcast Tx Common Equipment
- 19D904009G6 - Site Controller - PDP11
- 19D904009G7 - Auxiliary Receiver - Modem
- 19D904009G8 - Euro EDACS Assembly
- 19D904009G9 - GETC Simulcast Control Point (1-12)
- 19D904009G10 - GETC Simulcast Control Point (13-20)
- 19D904009G11 - Voter Interface Panel
- 19D904009G12 - Site Controller VAX-DEC (#1)
- 19D904009G13 - Site Controller VAX-DEC (#2)
- 19D904009G14 - CTIS Main Computer VAX-DEC
- 19D904009G15 - Simulcast Control Point
- 19D904009G16 - Euro EDACS Lease Line Interface
- 19D904009G17 - RIC Transformer Panel
- 19D904009G18 - Jessica Control
- 19D904009G19 - DVIU Interface Panel
- 19D904009G20 - STN Voter Interface
- 19D904009G21 - Voter RIC Interface
- 19D904009G22 - Auxiliary Receiver RS-232
- 19D904009G23 - Auxiliary Receiver Conventional
- 19D904009G24 - Station Assembly with GTI
- 19D904009G25 - Simulcast Tx Site (RS-232 Data)
- 19D904009G26 - SIM Interface Panel
- 19D904009G27 - ELI/Site Controller Panel
- 19D904009G28 - UAS/ELI/SIM Panel (MASTR III)
- 19D904009G29 - Prism Site Sentry/ELI/SIM Panel

- 19D904009G30 - Prism ELI Audio Panel
- 19D904009G31 - Station Assembly w/SitePro (cabinet w/SIM)
- 19D904009G32 - Station Assembly w/SitePro (cabinet wo/SIM)

Module Names:

- 19C852204G1 - Interface Module
- 19C852213G1 - Power Monitor Module
- 19C852215G1 - PTT Module
- 19C852218G1 - Power Monitor Module for Simulcast
- 19C852226G1 - CTIS Module
- 19C852313G1 - VAX Site Controller
- 19C852327G1 - Euro EDACS Interface Board
- 19C852339G1 - TUAI for Simulcast
- ROA1172442/1 - ELI Interface Module
- ROA1172485/1 - Prism ELI Audio Module
- 19C852349G1 - RIC Transformer Signal In/Out Isolation
- 19C852447G1 - Serial Interface Module
- 19C852632G1 - Power Sensor Interface Module
- 19D904427G1 - Simulcast 150 Baud Interface Module
- 19D904678G1 - RIC-Voter Interface Board
- 19D904833G1 - STN-Voter Interface Board
- 188D5120G1 - Microwave Distribution Panel
- ROA1172209 - Timing Interface Module
- ROA1172410/1 - UAS/ELI/SIM Module (MASTR III)
- ROA1172485/1 - Prism ELI Audio Module

3.0 MODULE DESCRIPTIONS

The following descriptions for each interface module give the application and a reference to the applicable instruction manual:

19C852204G1 Interface Module - This is a general-purpose interface module that connects four wires from each of ten six-pin modular connectors (for inside connections) to two fifty-pin Telco connectors (for outside connections). See LBI-38813.

19C852213G1 Power Monitor Module - This module provides the connection points for transmitter and antenna power sensor circuits at the Site Controller cabinet when using the old DB8843-based Power Monitor Unit. (See the 19C852632G1 Power Sensor Interface Module when using the new DB8860-based Power Monitor Unit.) See LBI-38815.

19C852215G1 PTT Module - This module is used as a connection point and cross connect for the PTT and Analog/Digital signaling circuits between the microwave link and the station transmitters at a Remote Transmit Site in a Simulcast system. See LBI-38816.

19C852218G1 EDACS Interface Power Monitor Module for Simulcast - This module provides the connection points for transmitter and antenna power sensor circuits at a Simulcast site. See LBI-38819.

19C852226G1 EDACS CTIS Module - This module is used to collect and route telephone interface analog/data for the Central Telephone Interconnect System (CTIS). See LBI-38818.

19C852313G1 EDACS Interface VAX Site Controller - This module provides the connection points for the GETC Data circuits in the EDACS Interface Panel for the VAX Site Controller. See LBI-38943.

19C852323G1 EDACS Interface Serial Module - This module provides the connection points for the Failsoft and RIC data links. This module has been replaced by the 19C852447G1 module which adds connection points for GETC reset and status lines (used by Guardog). See LBI-38930.

19C852327G1 Euro EDACS Interface Board - This is a general-purpose interface module that provides inside connection points for six 8-pin modular connectors. See LBI-38946.

19C852339G1 TUAI for Simulcast - This module replaces the earlier 19C852219G1 TUAI Module, and provides alarm connection points for up to 25 TUAI channels and up to four Test Units. See LBI-38948.

19C852349G1 EDACS Interface RIC Transformer Signal In/Out Isolation - This module provides isolation transformers for eight telephone circuits. See LBI-38947.

19C852379G1 EDACS Interface Power Monitor / Channel Select Module - This plug-in board provides grounding jumpers for the power sensor circuits connected to a Power Monitor Unit. This board is used with the 19C852632G1 Power Sensor Interface Module used with the new DB8860-based Power Monitor Unit. See LBI-38944.

19C852427G1 EDACS Interface Simulcast 150-Baud Interface Module - This module is used to re-map jackfield appearances of 150-Baud data. See LBI-38945.

MODULE DESCRIPTIONS

19C852447G1 Serial Interface Module - This module replaces the earlier 19C852323G1 Serial Interface Module and adds connection points for the GETC reset and status lines (used by Guardog) to the previously provided connection points for the Failsoft and RIC data links. See LBI-39136.

19C852632G1 Power Sensor Interface Module - This module provides the connection points for transmitter and antenna power sensor circuits at the Site Controller cabinet when using the new DB8860-based Power Monitor Unit. This module is added to (but is not a part of) the EDACS Interface Panel in the Site Controller cabinet when the new DB8860-based Power Monitor Unit is added. This module also comes with two plug-in 19C852379G1 Power Sensor Termination Boards. See LBI-39137.

19D904678G1 RIC-Voter Interface Board - This module provides the connection points between the Voter Analog Cross Connect Panel, Analog Processing Shelf, and RIC Shelves at the Main Site of a Voted System (or the Control Point of a Simulcast System) with IDA Local Telephone Interconnect. See LBI-39022.

19D904833G1 STN-Voter Interface Board - This module provides the connection points between the Modem Shelves and the Voter Analog Cross Connect Panel (or the Voter Selector GETC when using Digital Dispatch) at the Main Site of a Voted System (or the Control Point of a Simulcast System). See LBI-39021.

188D5120G1 Microwave Distribution Panel - This module provides the connection points and cross connects to group all of low-speed data circuits on one connector, all alarm circuits on a second connector, and all sync tone circuits on a third connector, from ten other connectors connected to separate Microwave Cross Connect Panels at the Control Point of a Simulcast System.

ROA1172209 Timing Interface Module (RS-232 Version) - This module provides the cross connects for the clock reference circuits between the Transmit (or Control Point) Cross Connect, Universal Sync Shelf, and Multiplex Cross Connect (or Timing Concentrator) at the Transmit (or Control Point) site of a Simulcast System. See Maintenance Manual LBI-39099.

ROA1172410/1 UAS/ELI/SIM – This module provides the connection points between the power sensor circuits in the system and the Universal Alarm system. See Maintenance Manual EN/LZB 119 3775/1.

ROA1172485/1 PRISM ELI AUDIO – This module provides the connection points in a Prism MASTR system for the Tx audio and Intercom audio from each channel to its appropriate ELI shelf. See Maintenance Manual AE/LZB 119 4601/1.

4.0 PARTS LIST²EDACS INTERFACE PANELS
(19D904009G1 – G32)

SYMBOL	PART NUMBER	DESCRIPTION
		----- MODULES -----
3	19C852204G1	Interface Modules (Used in G1-G11, G13, G14, G16, G18, G19, G22 - G24, G28, G29, G31 and G32).
4	19C852447G1*	Serial Interface Module (Used in G1, G2, G4-G6, G12, G14, G24, G29, G31 and G32).
11	19C852226G1	CTIS Module (Used in G3 and G9).
16	19C852213G1	Power Monitor Module (Used in G6).
17	19C852215G1	PPT Module (Used in G5).
19	19C852218G1	Power Monitor Module for Simulcast (Used in G5).
21	19C852313G1	VAX Site Controller (Used in G12 and G14).
22	19D904427G7	Simulcast 150-Baud Interface Module (Used in G15).
23	19C852339*	TUAI for Simulcast (Used in G5).
24	19C852327G1	Euro EDACS Interface Board (Used in G16, G18, G24, G28, G29, G30, G31 and G32).
25	19C852349G1	RIC Transformer Signal In/Out Isolation (Used in G17).
27	19D904833G1	STN-Voter Interface Board (Used in G20).
28	19D904678G1	RIC-Voter Interface Board (Used in G21).
29	ROA1172209	Timing Interface Module (Used in G25).
30	188D5120G1	Microwave Distribution Panel (Used in G21).
58	ROA1172442/1	ELI/Site Controller Module (Used in G27).
59	ROA1172410/1	UAS/ELI/SIM Interface Module (Used in G28 & G29).
63	ROA1172485/1	Prism ELI Audio Interface Module (Used in G30).
66	FM101263V1	Connector Panel (Used in G32).
67	CN101314V1	RJ-11 Connectors J1 thru J4 (Used in G32).
		----- MISCELLANEOUS -----
2	19D903881P1	Frame (One per EDACS Interface Panel).
5	19A702381P506	Screw, Thread Forming, Torx Head, M3.5 – 0.6 x 6 (4 per smaller modules, 8 per larger modules).
6	344A4111P1	Label, Adhesive, Name, Assortment (One per EDACS Interface Panel).

² COMPONENTS ADDED, DELETED OR CHANGED BY PRODUCTION CHANGES

5.0 STATION ASSEMBLY DIAGRAMS:

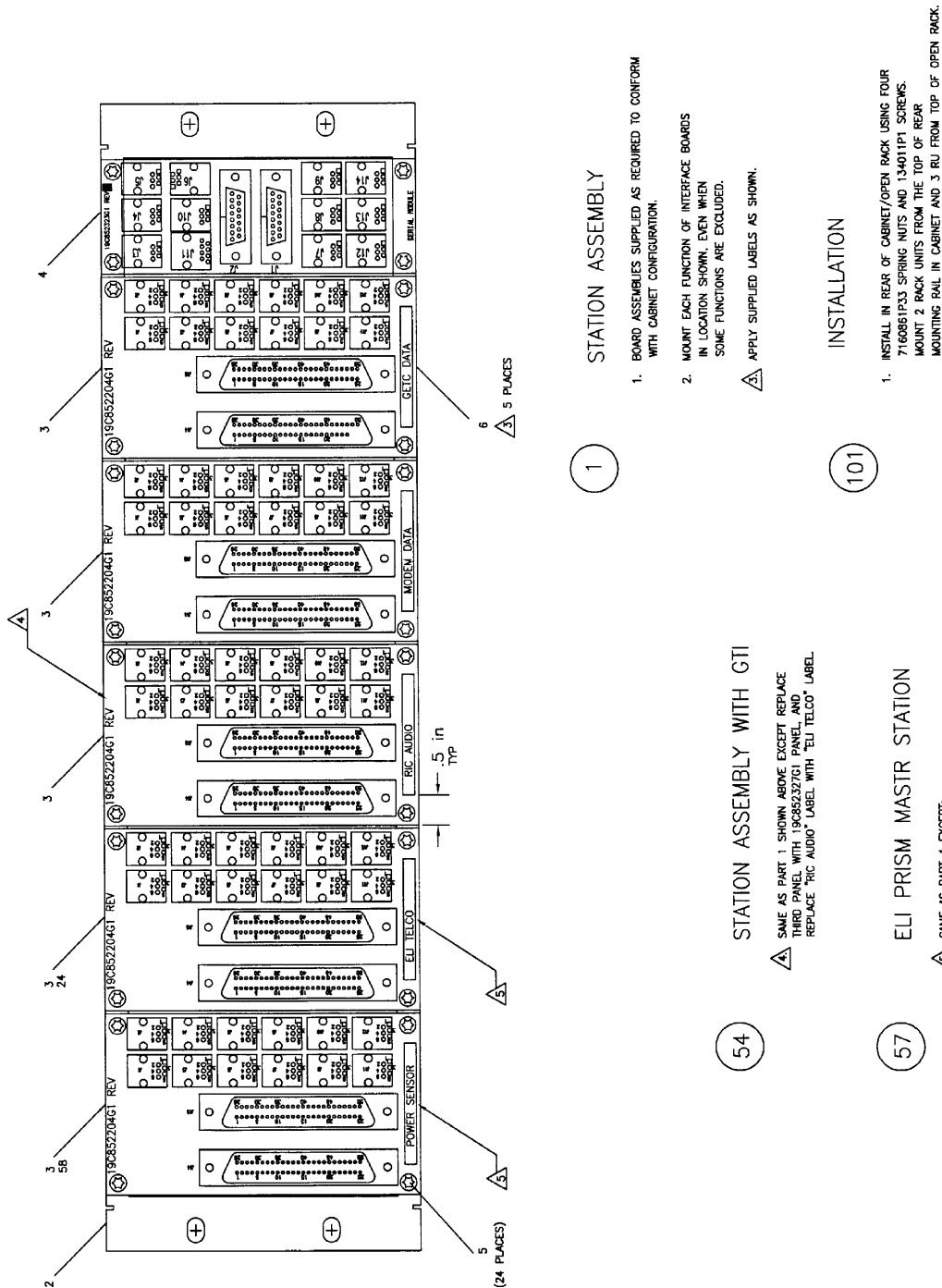

1
STATION ASSEMBLY

1. BOARD ASSEMBLIES SUPPLIED AS REQUIRED TO CONFORM WITH CABINET CONFIGURATION.
2. MOUNT EACH FUNCTION OF INTERFACE BOARDS IN LOCATION SHOWN. EVEN WHEN SOME FUNCTIONS ARE EXCLUDED.
▲ APPLY SUPPLIED LABELS AS SHOWN.

101
INSTALLATION

1. INSTALL IN REAR OF CABINET/OPEN RACK USING FOUR 7160861933 SPRING NUTS AND 134011P1 SCREWS. MOUNT 2 RACK UNITS FROM THE TOP OF REAR MOUNTING RAIL IN CABINET AND 3 RU FROM TOP OF OPEN RACK.

54
STATION ASSEMBLY WITH GTI

- ▲ SAME AS PART 1 SHOWN ABOVE EXCEPT REPLACE THIRD PANEL WITH 19C852327G1 PANEL AND REPLACE "RIC AUDIO" LABEL WITH "ELI TELECO" LABEL.

57
ELI PRISM MASTR STATION

- ▲ SAME AS PART 1 EXCEPT: LABEL ITEM 24 WITH "ELI TELECO" AND ITEM 58 WITH "ELI PRISM MASTR".

EDACS INTERFACE PANEL (G1) – STATION ASSEMBLY

(19D904009, Sh. 1, Rev.7)

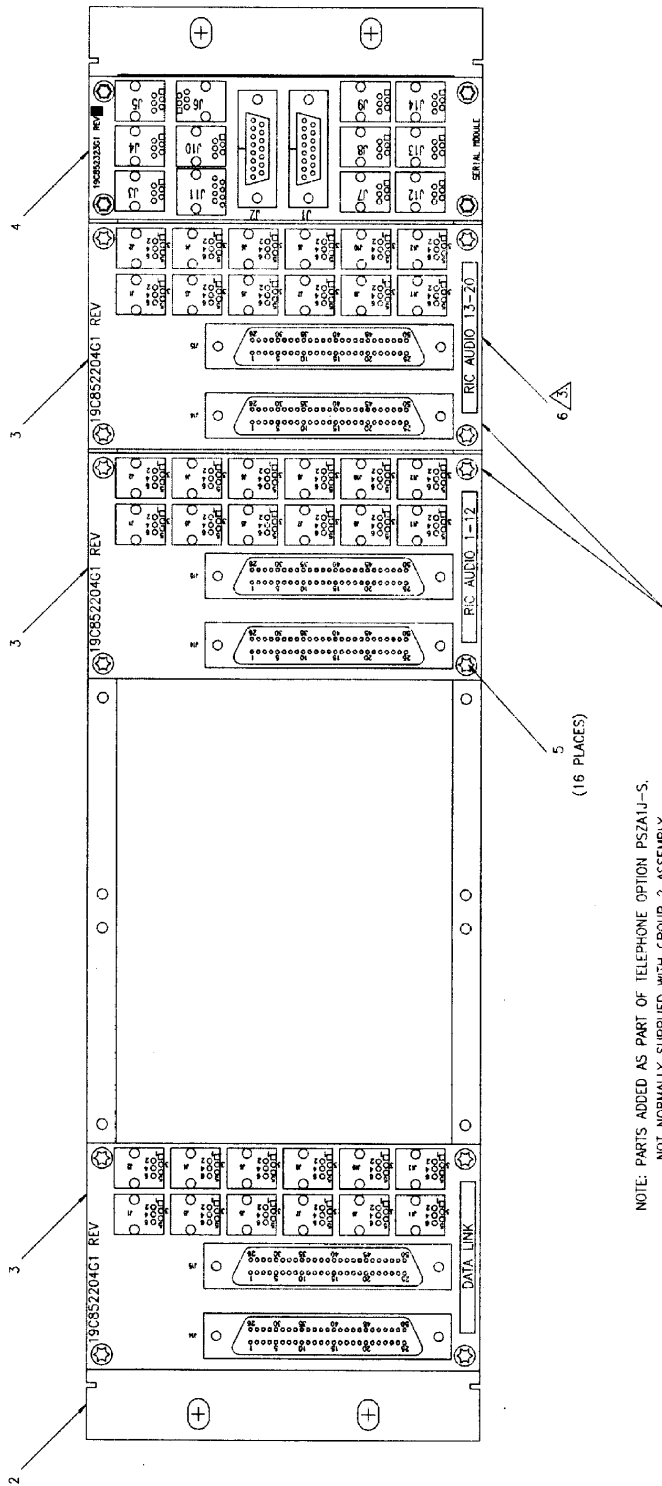

NOTE: PARTS ADDED AS PART OF TELEPHONE OPTION PSZAIJ-S.
NOT NORMALLY SUPPLIED WITH GROUP 2 ASSEMBLY

107

CTIS MAIN COMPUTER CABINET

1. BOARD ASSEMBLIES SUPPLIED AS REQUIRED TO CONFORM WITH CABINET CONFIGURATION.
2. MOUNT EACH FUNCTION OF INTERFACE BOARDS IN LOCATION SHOWN, EVEN WHEN SOME FUNCTIONS ARE EXCLUDED.
3. APPLY SUPPLIED LABELS AS SHOWN.

7

INSTALLATION

1. INSTALL IN REAR OF CABINET/OPEN RACK USING FOUR 7160861P33 SPRING NUTS AND 134011P1 SCREWS. MOUNT 2 RACK UNITS FROM THE TOP OF REAR MOUNTING RAIL IN CABINET AND 3 RU FROM TOP OF OPEN RACK.

EDACS INTERFACE PANEL (G2) - CTIS MAIN COMPUTER CABINET

(19D904009, Sh. 2, Rev. 7)

STATION ASSEMBLY DIAGRAM

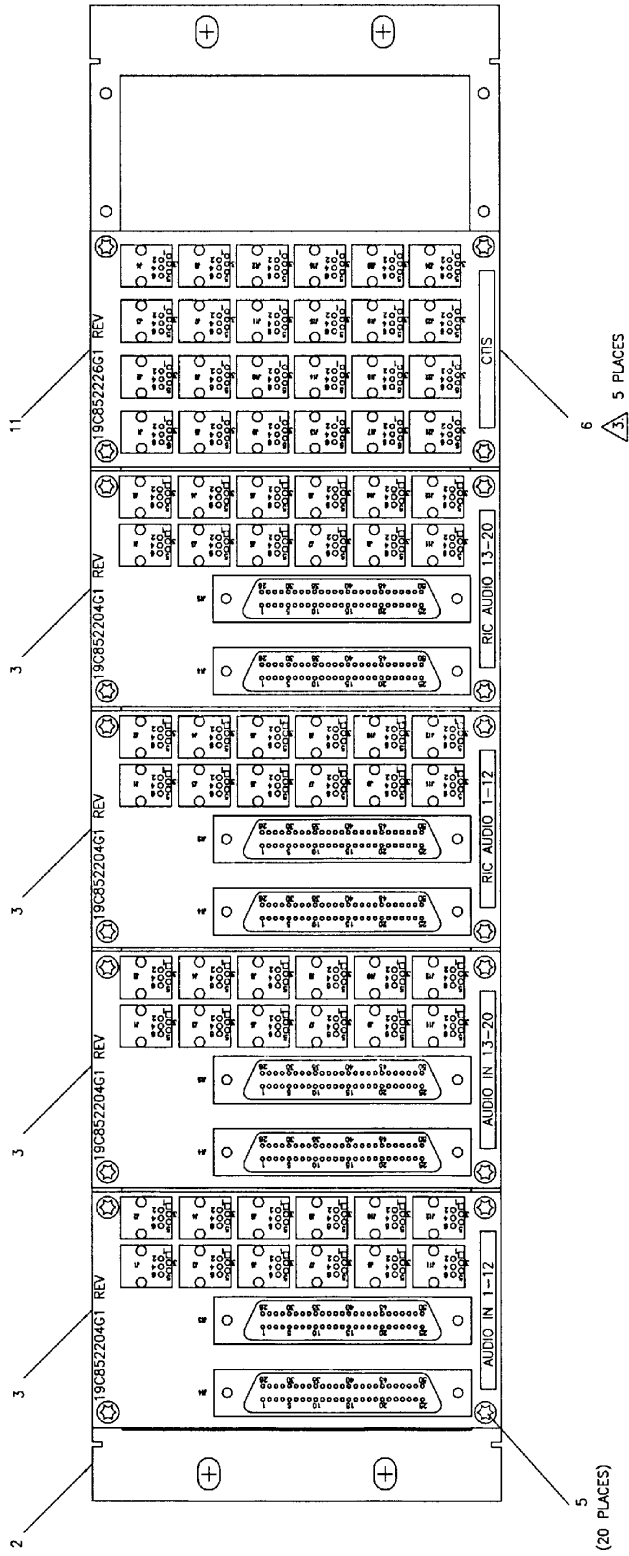

CTIS RIC CABINET

9

1. BOARD ASSEMBLIES SUPPLIED AS REQUIRED TO CONFORM WITH CABINET CONFIGURATION.
2. MOUNT EACH FUNCTION OF INTERFACE BOARDS IN LOCATION SHOWN, EVEN WHEN SOME FUNCTIONS ARE EXCLUDED.
3. APPLY SUPPLIED LABELS AS SHOWN.

INSTALLATION

109

1. INSTALL IN REAR OF CABINET/OPEN RACK USING FOUR 7160861P33 SPRING NUTS AND 134011P1 SCREWS. MOUNT 2 RACK UNITS FROM THE TOP OF REAR MOUNTING RAIL IN CABINET AND 3 RU FROM TOP OF OPEN RACK.

EDACS INTERFACE PANEL (G3) – CTIS RIC CABINET

(Part of 19D904009, Sh. 3, Rev. 7)

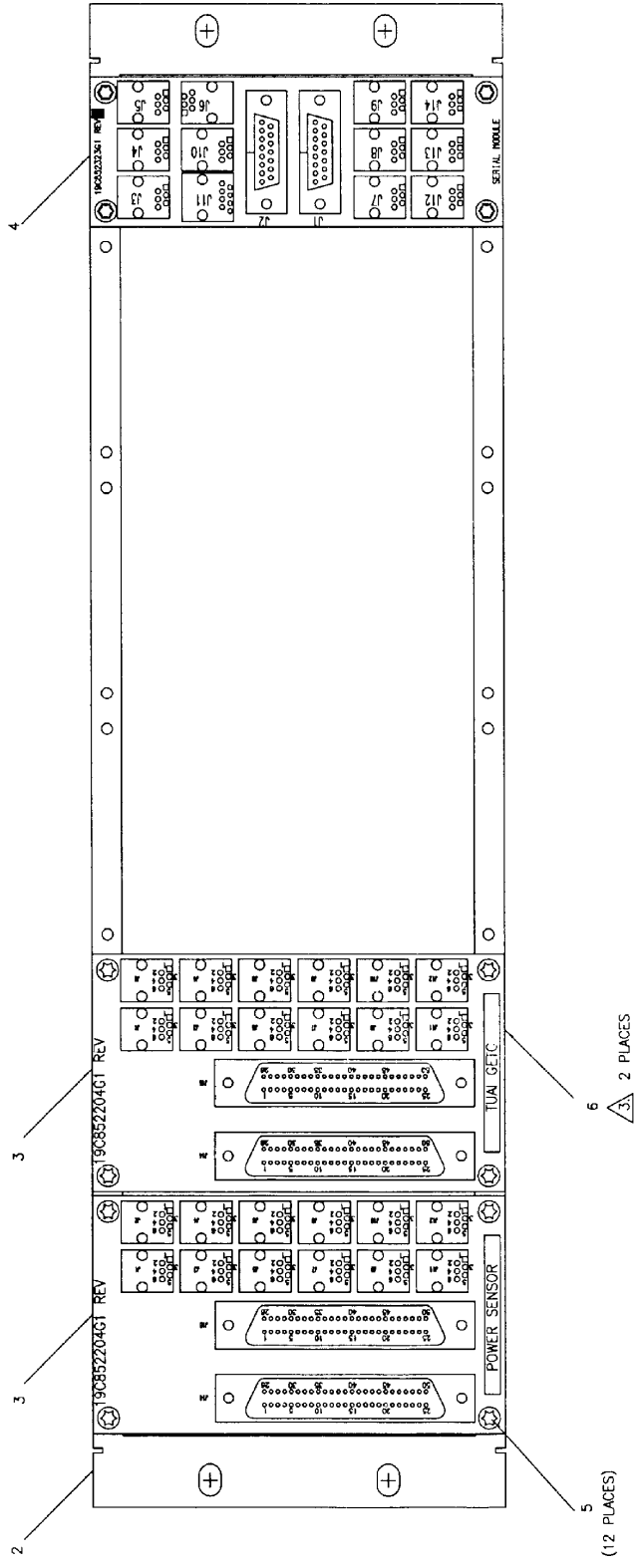

EDACS INTERFACE PANEL (G4) – SIMULCAST STATION

SIMULCAST STATION

1. BOARD ASSEMBLIES SUPPLIED AS REQUIRED TO CONFORM WITH CABINET CONFIGURATION.
2. MOUNT EACH FUNCTION OF INTERFACE BOARDS IN LOCATION SHOWN, EVEN WHEN SOME FUNCTIONS ARE EXCLUDED.
3. APPLY SUPPLIED LABELS AS SHOWN.

EDACS ADVANTAGE INTERFACE PANEL

- MOD INSTRUCTIONS SAME AS GROUP 4 (PART 12) SHOWN EXCEPT.
1. REPLACE OR COVER "POWER SENSOR" LABEL WITH "GETC DATA" LABEL.
 2. REPLACE OR COVER "TUAI GETC" LABEL WITH "TELI INTERFERENCE" LABEL.

INSTALLATION

1. INSTALL IN REAR OF CABINET/OPEN RACK USING FOUR 7160861P33 SPRING NUTS AND 134011P1 SCREWS. MOUNT 2 RACK UNITS FROM THE TOP OF REAR MOUNTING RAIL IN CABINET AND 3 RU FROM TOP OF OPEN RACK.

STATION ASSEMBLY DIAGRAM

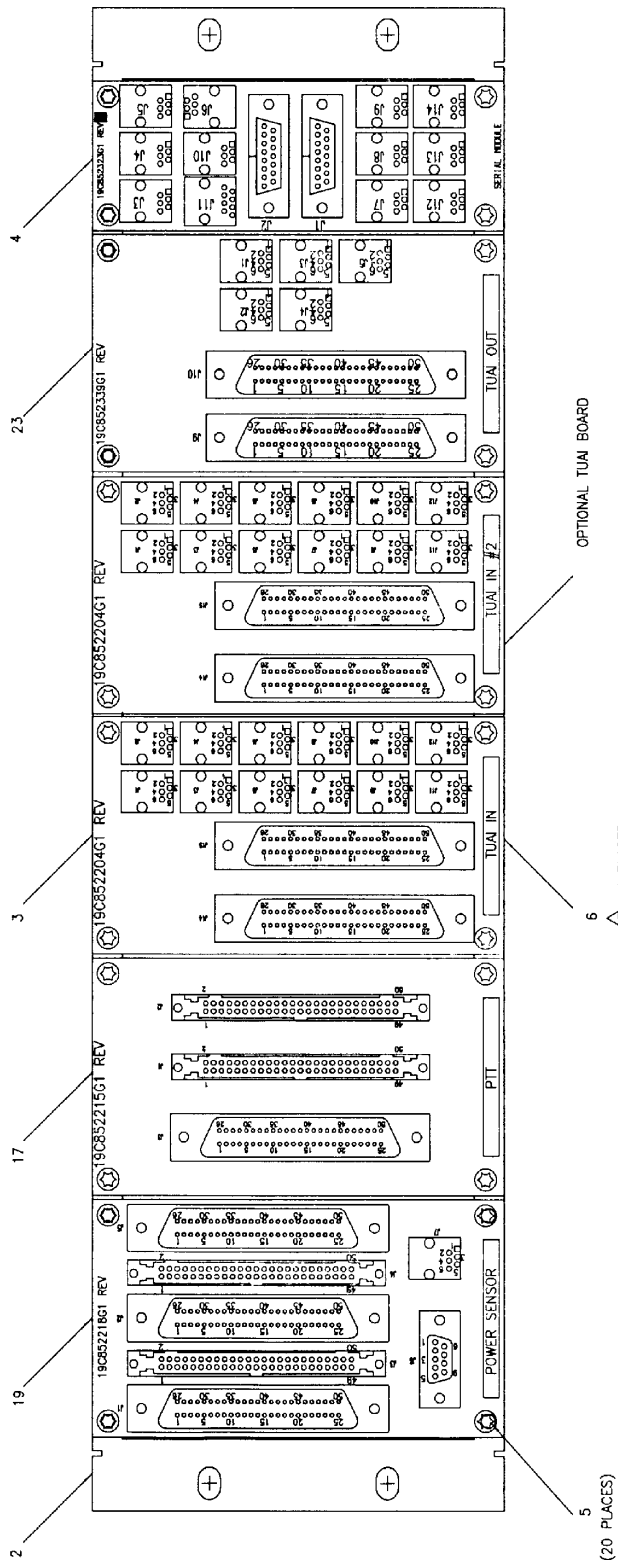

114

14 SIMULCAST TX COMMON EQUIPMENT

INSTALLATION

1. BOARD ASSEMBLIES SUPPLIED AS REQUIRED TO CONFORM WITH CABINET CONFIGURATION.
 2. MOUNT EACH FUNCTION OF INTERFACE BOARDS IN LOCATION SHOWN, EVEN WHEN SOME FUNCTIONS ARE EXCLUDED.
 3. APPLY SUPPLIED LABELS AS SHOWN.
1. INSTALL IN REAR OF CABINET/OPEN RACK USING FOUR 7160861P33 SPRING NUTS AND 134011P1 SCREWS. MOUNT 2 RACK UNITS FROM THE TOP OF REAR MOUNTING RAIL IN CABINET AND 3 RU FROM TOP OF OPEN RACK.

EDACS INTERFACE PANEL (G5) – SIMULCAST TX COMMON EQUIPMENT

(19D904009, Sh. 5, Rev. 7)

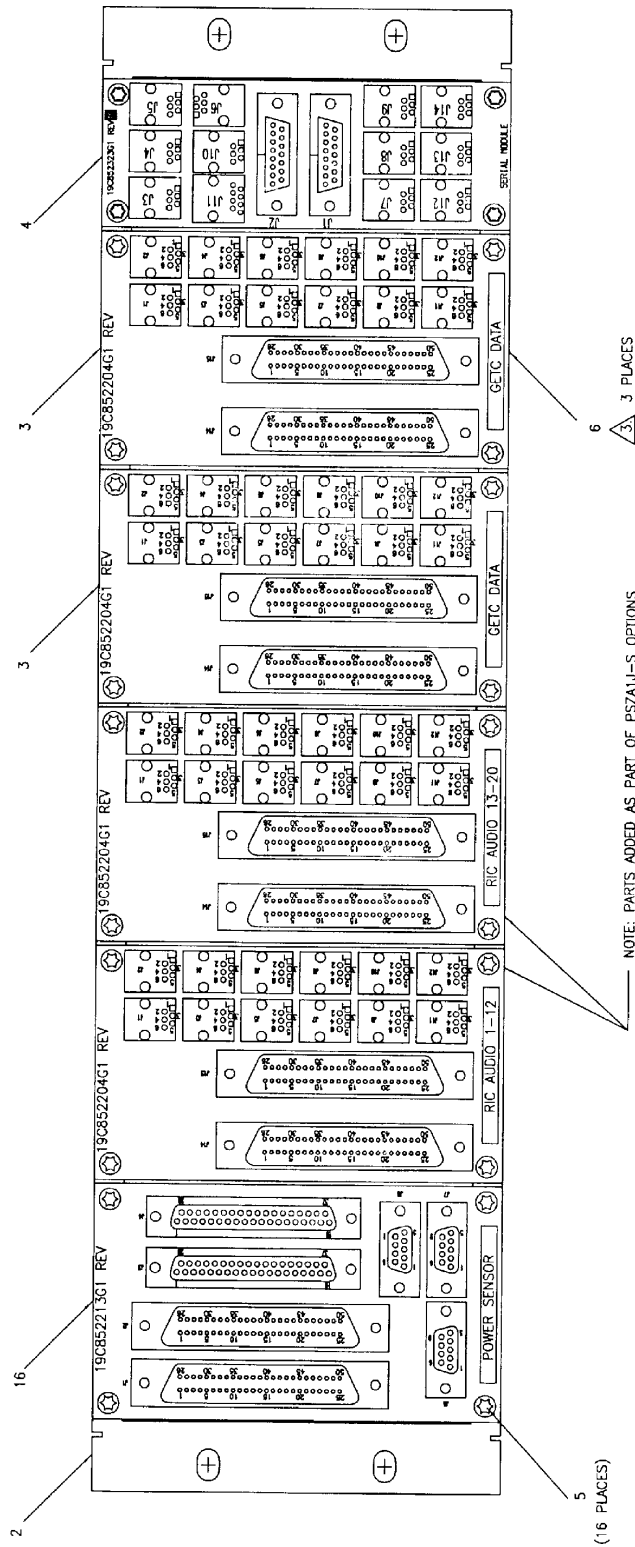

INSTALLATION

1. INSTALL IN REAR OF CABINET/OPEN RACK USING FOUR 7160861P33 SPRING NUTS AND 134011P1 SCREWS. ASSEMBLE 2 RACK UNITS FROM THE TOP OF REAR MOUNTING RAIL IN CABINET AND 3 RU FROM TOP OF OPEN RACK.

120

SITE CONTROLLER -- PDP11

1. BOARD ASSEMBLIES SUPPLIED AS REQUIRED TO CONFORM WITH CABINET CONFIGURATION.
2. MOUNT EACH FUNCTION OF INTERFACE BOARDS IN LOCATION SHOWN, EVEN WHEN SOME FUNCTIONS ARE EXCLUDED.
3. APPLY SUPPLIED LABELS AS SHOWN.

20

EDACS INTERFACE PANEL (G6) – SITE CONTROLLER-PDP11

(Part of 19D904009, Sh. 6, Rev.7)

STATION ASSEMBLY DIAGRAM

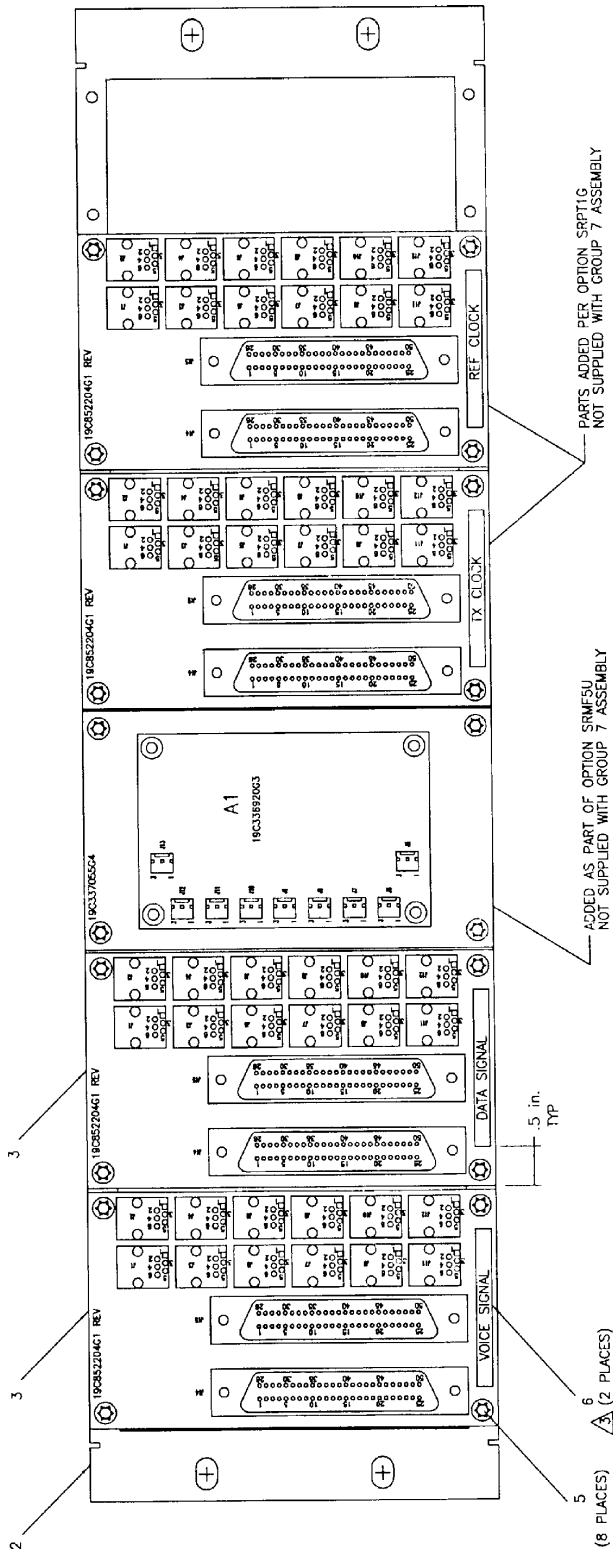

INSTALLATION

1. INSTALL IN REAR OF CABINET/OPEN RACK USING FOUR 7160861P33 SPRING NUTS AND 134011P1 SCREWS. MOUNT 2 RACK UNITS FROM THE TOP OF REAR MOUNTING RAIL IN CABINET AND 3 RU FROM TOP OF OPEN RACK.

137

AUX REC. - MODEM

1. BOARD ASSEMBLIES SUPPLIED AS REQUIRED TO CONFORM WITH CABINET CONFIGURATION.
2. MOUNT EACH FUNCTION OF INTERFACE BOARDS IN LOCATION SHOWN, EVEN WHEN SOME FUNCTIONS ARE EXCLUDED.
3. APPLY SUPPLIED LABELS AS SHOWN.

37

EDACS INTERFACE PANEL (G7) - AUXILIARY RECEIVER - MODEM

(19D904009, Sh. 7, Rev.7)

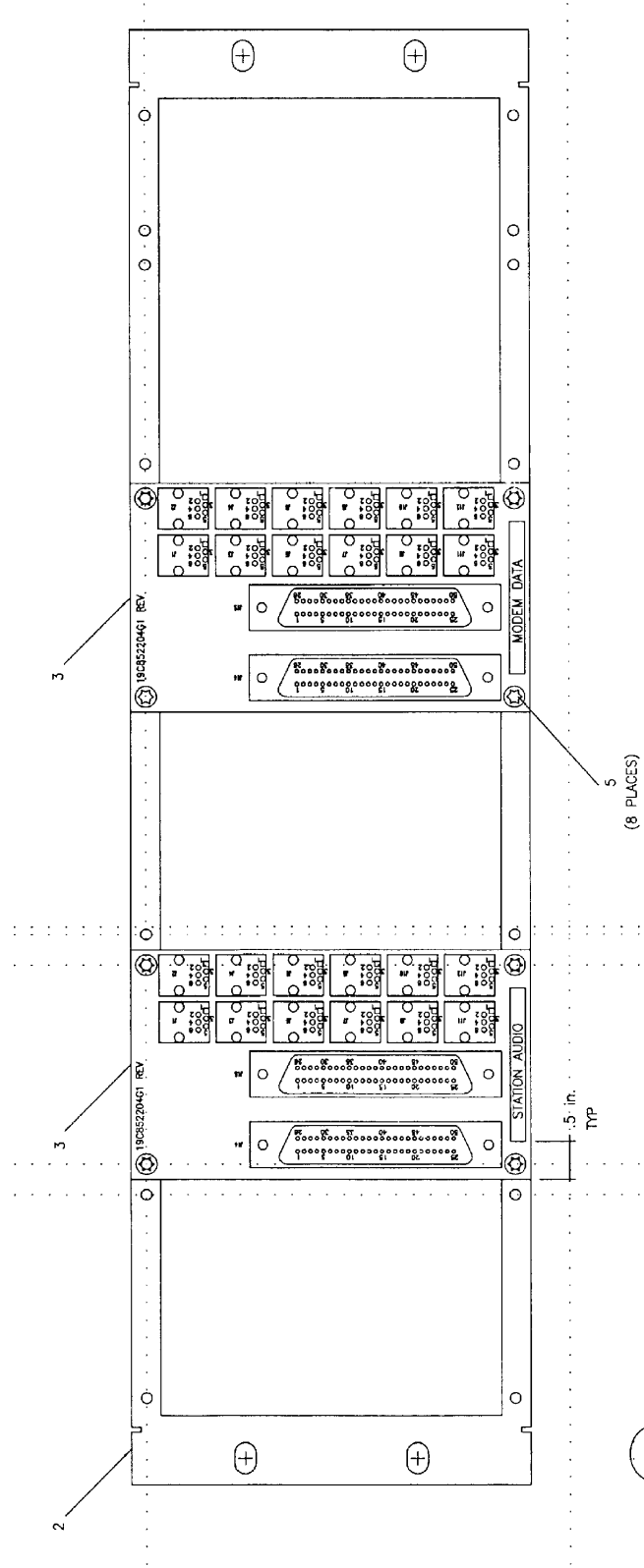

EUROEDACS ASSEMBLY

38

1. BOARD ASSEMBLIES SUPPLIED AS REQUIRED TO CONFORM WITH CABINET CONFIGURATION.
2. MOUNT EACH FUNCTION OF INTERFACE BOARDS IN LOCATION SHOWN, EVEN WHEN SOME FUNCTIONS ARE EXCLUDED.
3. APPLY SUPPLIED LABELS AS SHOWN.

EDACS INTERFACE PANEL (G8) – EURO EDACS ASSEMBLY

(19D904009, Sh. 8, Rev. 7)

STATION ASSEMBLY DIAGRAM

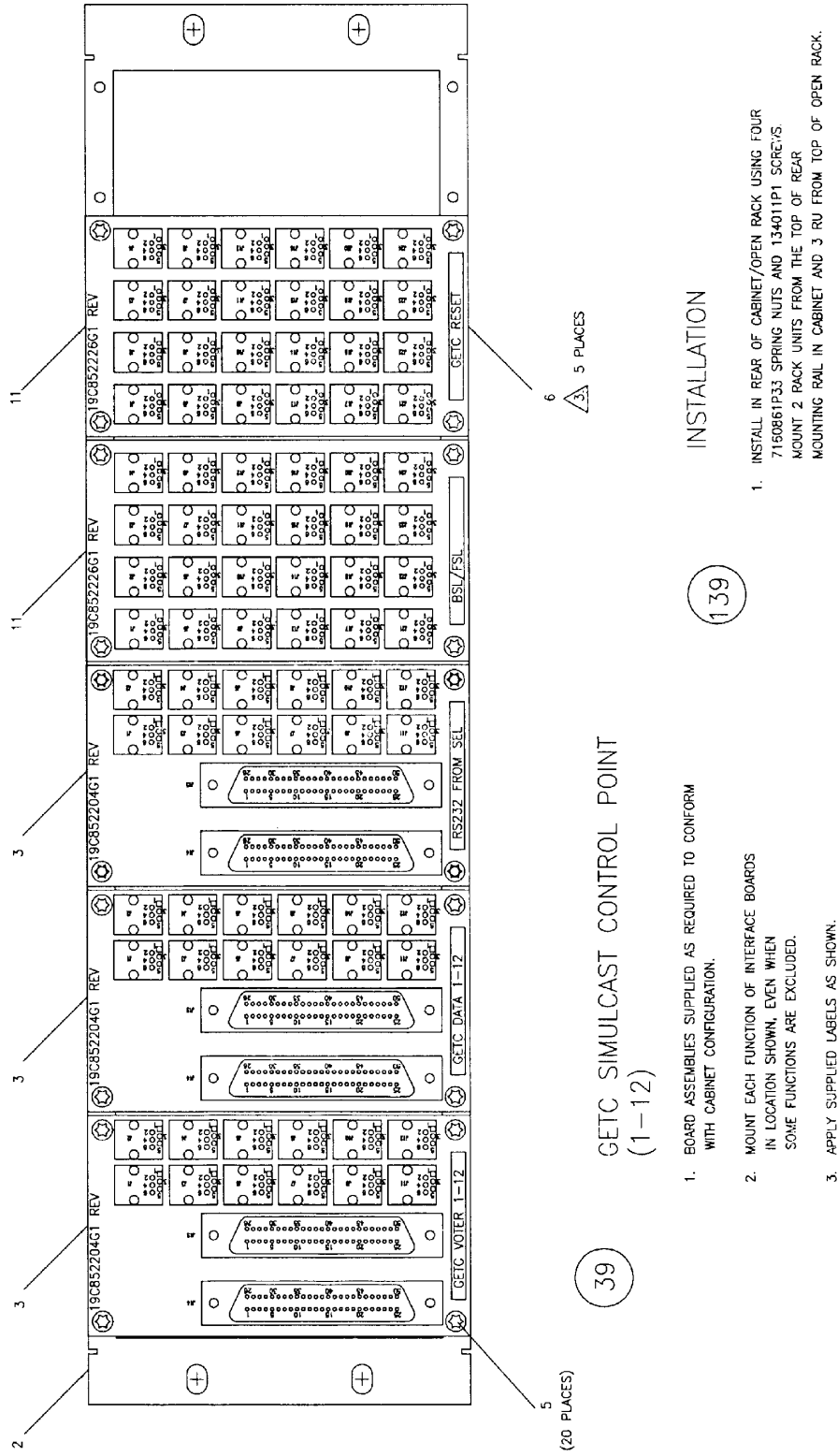

EDACS INTERFACE PANEL (G9) – GETC SIMULCAST CONTROL POINT (1-12)

(19D904009, Sh. 9, Rev.7)

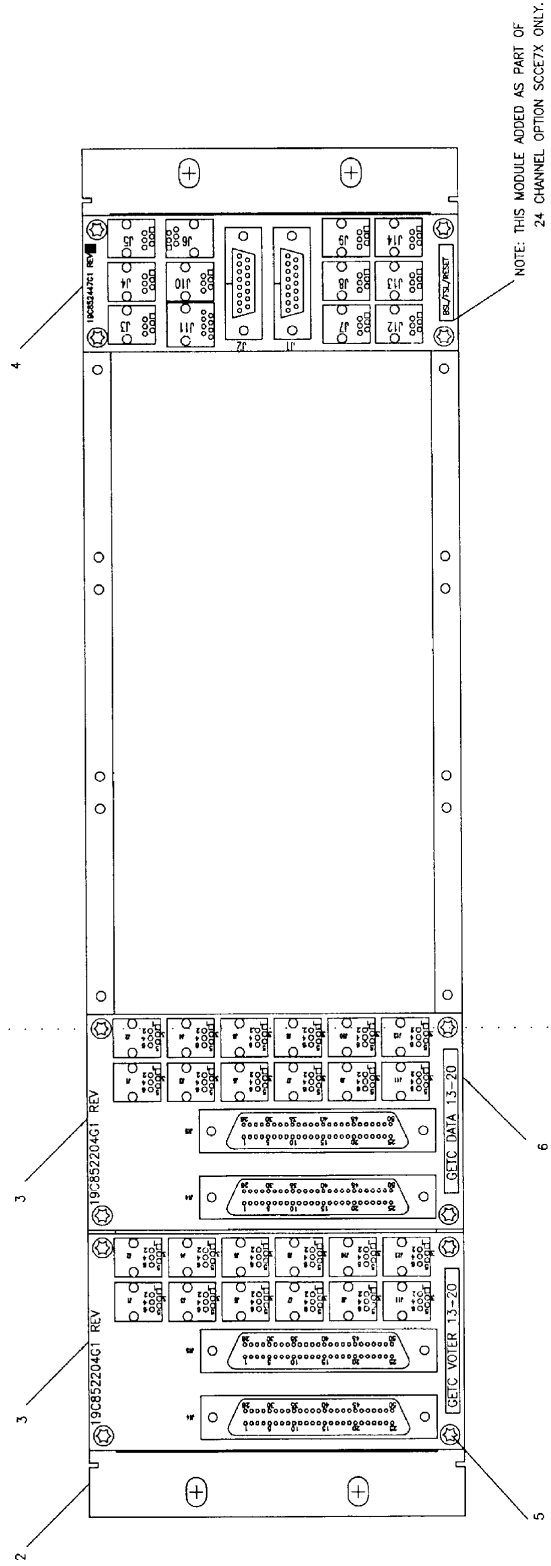

- (40)
- GETC SIMULCAST CONTROL POINT
(13-20)
1. BOARD ASSEMBLIES SUPPLIED AS REQUIRED TO CONFORM WITH CABINET CONFIGURATION.
 2. MOUNT EACH FUNCTION OF INTERFACE BOARDS IN LOCATION SHOWN, EVEN WHEN SOME FUNCTIONS ARE EXCLUDED.
 3. APPLY SUPPLIED LABELS AS SHOWN.

EDACS INTERFACE PANEL (G10) – GETC SIMULCAST CONTROL POINT (13-20)

(19D904009, Sh. 10, Rev. 7)

STATION ASSEMBLY DIAGRAM

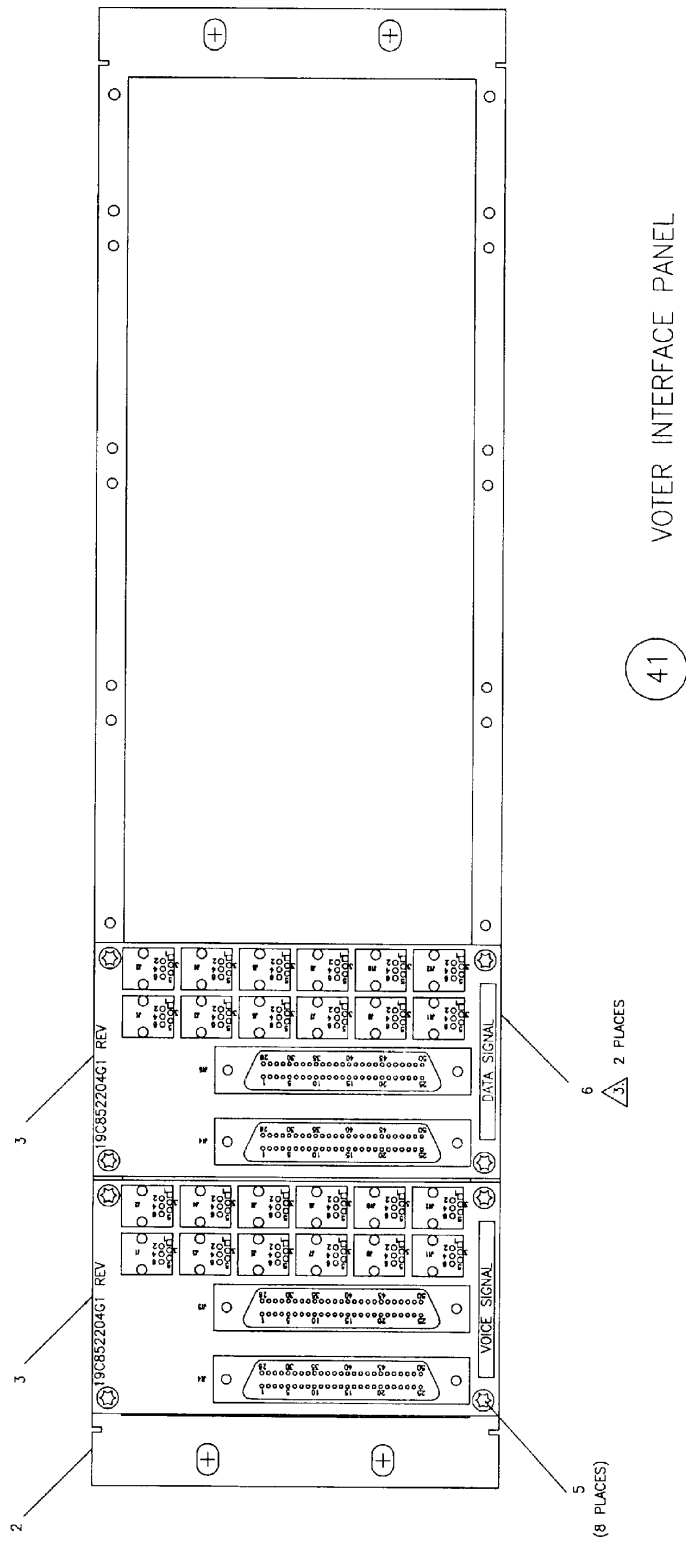

1. BOARD ASSEMBLIES SUPPLIED AS REQUIRED TO CONFORM WITH CABINET CONFIGURATION.
2. MOUNT EACH FUNCTION OF INTERFACE BOARDS IN LOCATION SHOWN, EVEN WHEN SOME FUNCTIONS ARE EXCLUDED.
3. APPLY SUPPLIED LABELS AS SHOWN.

EDACS INTERFACE PANEL (G11) – VOTER INTERFACE PANEL

(19D904009, Sh. 11, Rev.7)

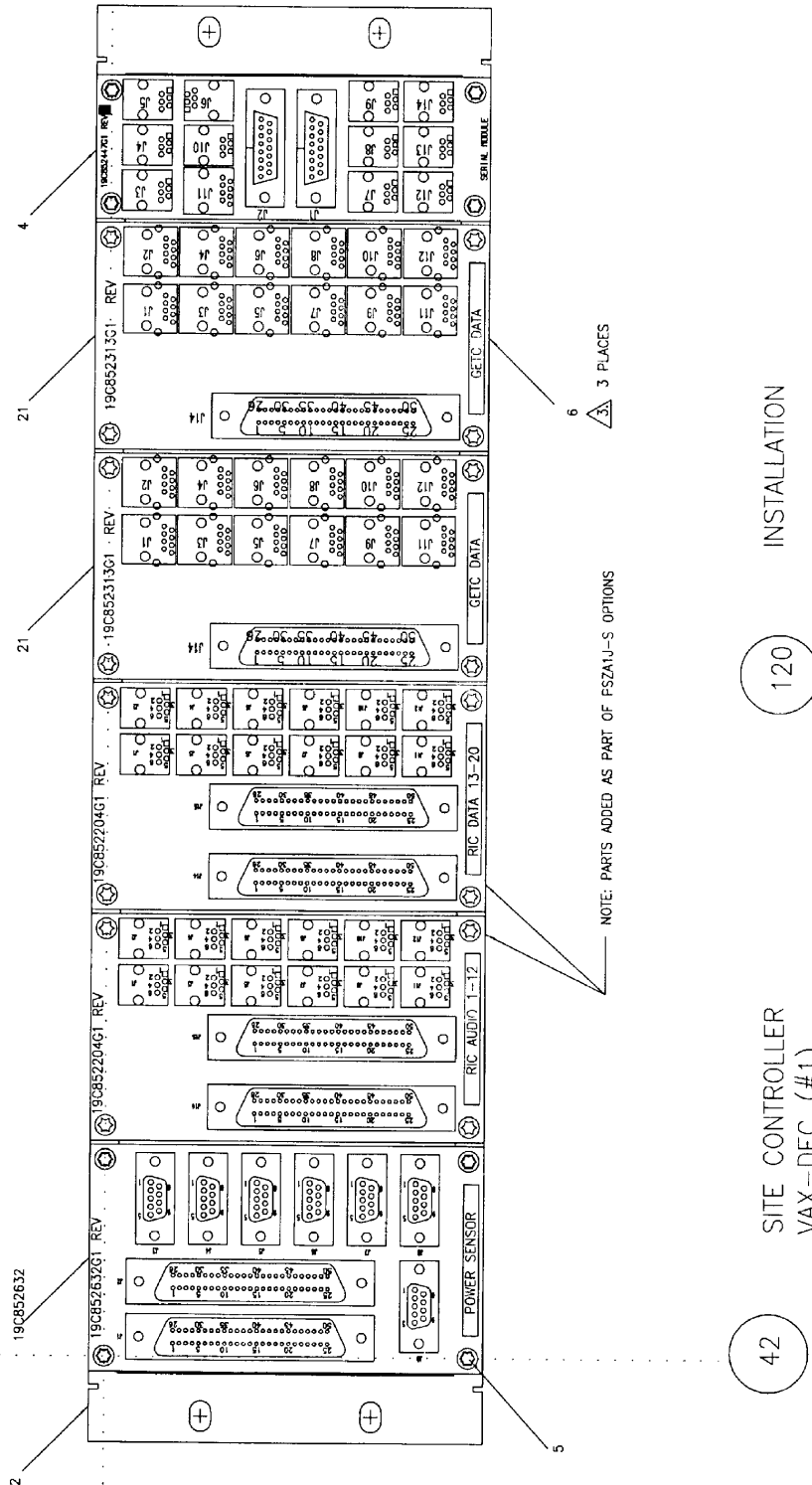

EDACS INTERFACE PANEL (G12) – SITE CONTROLLER VAX-DEC (#1)

(19D904009, Sh. 12, Rev. 7)

STATION ASSEMBLY DIAGRAM

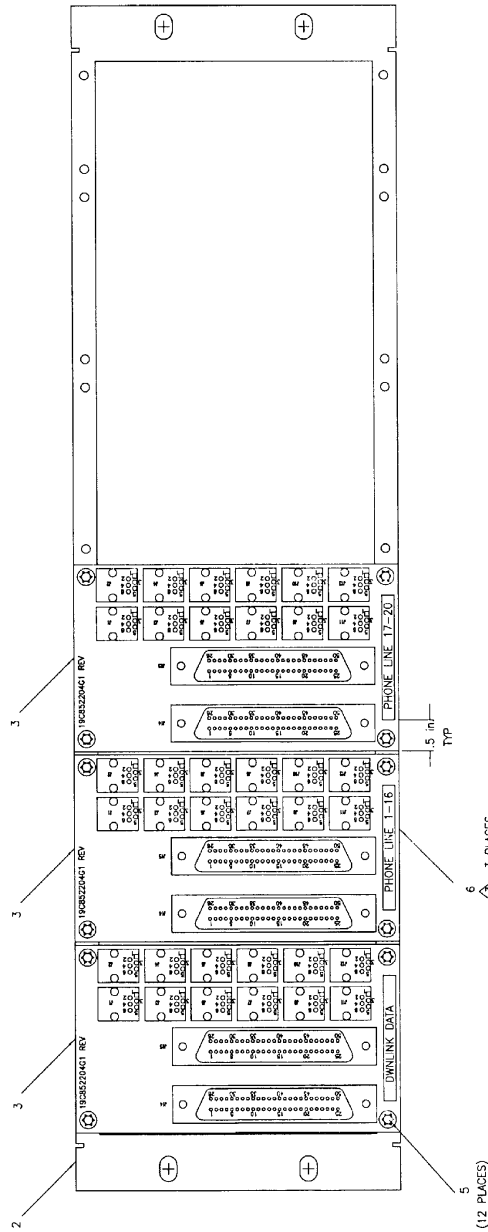

43

SITE CONTROLLER
VAX-DEC (#2)

1. BOARD ASSEMBLIES SUPPLIED AS REQUIRED TO CONFORM WITH CABINET CONFIGURATION.
2. MOUNT EACH FUNCTION OF INTERFACE BOARDS IN LOCATION SHOWN, EVEN WHEN SOME FUNCTIONS ARE EXCLUDED.
3. APPLY SUPPLIED LABELS AS SHOWN.

120

INSTALLATION

1. INSTALL IN REAR OF CABINET/OPEN RACK USING FOUR 71608B1P33 SPRING NUTS AND 134011P1 SCREWS. MOUNT 2 RACK UNITS FROM THE TOP OF REAR MOUNTING RAIL IN CABINET AND 3 RU FROM TOP OF OPEN RACK.

143

INSTALLATION

1. INSTALL IN REAR OF CABINET/OPEN RACK USING FOUR 71608B1P33 SPRING NUTS AND 134011P1 SCREWS. MOUNT 1 RACK UNIT BELOW 190904009 C12 PANEL.

EDACS INTERFACE PANEL (G13) – SITE CONTROLLER VAX-DEC (#2)

(19D904009, Sh. 13, Rev. 7)

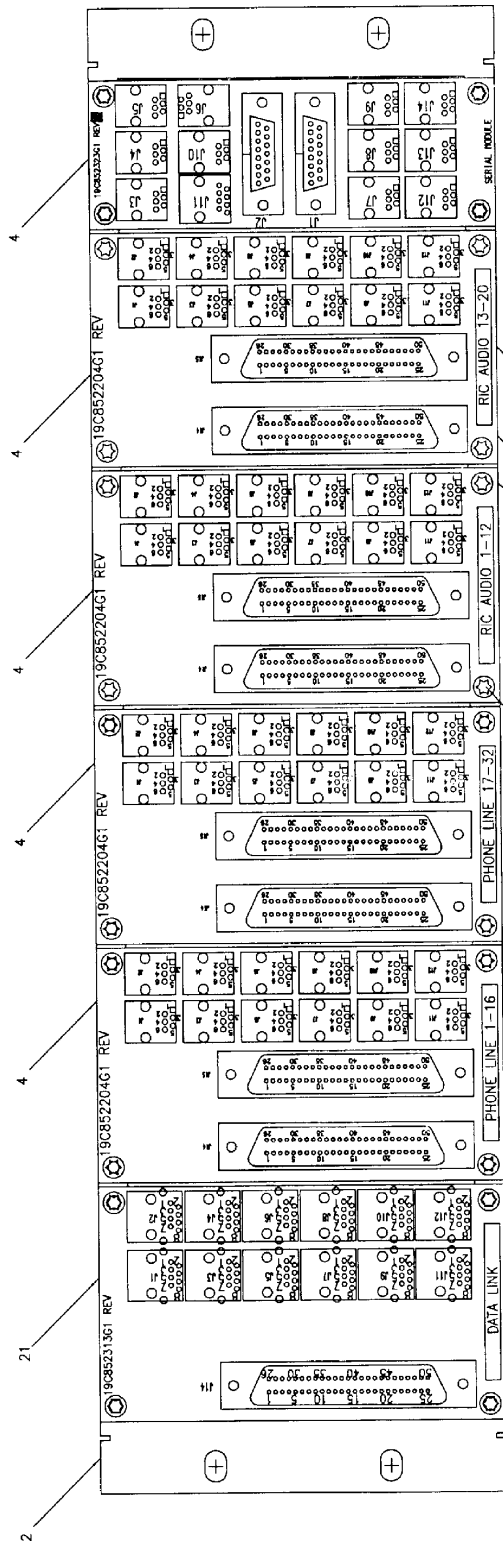

NOTE: PARTS ADDED AS PART OF TELEPHONE OPTION PS2A1J-S.
NOT NORMALLY SUPPLIED WITH GROUP 2 ASSEMBLY

CTIS MAIN COMPUTER

VAX-DEC

1. BOARD ASSEMBLIES SUPPLIED AS REQUIRED TO CONFORM WITH CABINET CONFIGURATION.
2. MOUNT EACH FUNCTION OF INTERFACE BOARDS IN LOCATION SHOWN, EVEN WHEN SOME FUNCTIONS ARE EXCLUDED.
3. APPLY SUPPLIED LABELS AS SHOWN.

107

INSTALLATION

1. INSTALL IN REAR OF CABINET/OPEN RACK USING FOUR 716D861P33 SPRING NUTS AND 134011P1 SCREWS. MOUNT 2 RACK UNITS FROM THE TOP OF REAR MOUNTING RAIL IN CABINET AND 3 RU FROM TOP OF OPEN RACK.

44

EDACS INTERFACE PANEL (G14) – CTIS MAIN COMPUTER VAX-DEC

(19D904009, Sh. 14, Rev. 7

STATION ASSEMBLY DIAGRAM

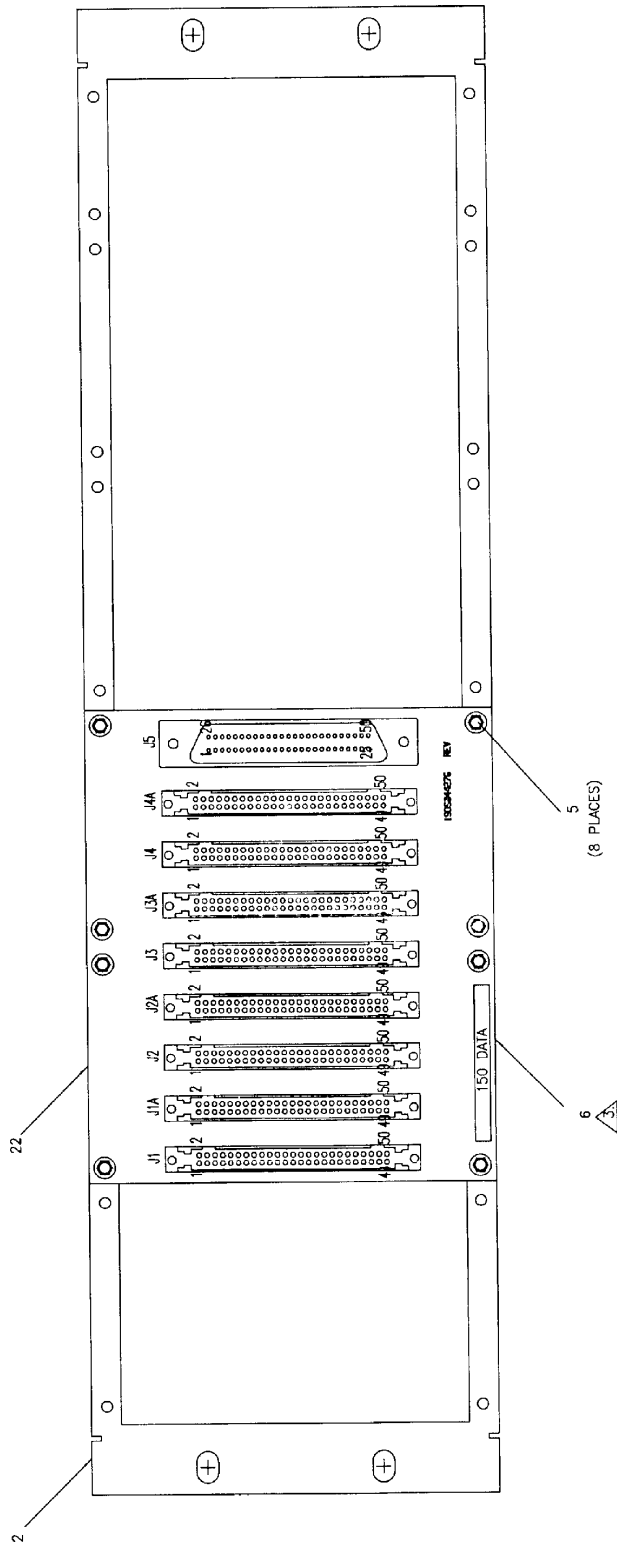

INSTALLATION

1. INSTALL IN REAR OF CABINET/OPEN RACK USING FOUR 7160861P33 SPRING NUTS AND 134011P1 SCREWS. MOUNT 2 RACK UNITS FROM THE TOP OF REAR MOUNTING RAIL IN CABINET AND 3 RU FROM TOP OF OPEN RACK.

145

SIMULCAST CONTROL POINT

1. BOARD ASSEMBLIES SUPPLIED AS REQUIRED TO CONFORM WITH CABINET CONFIGURATION.
2. MOUNT EACH FUNCTION OF INTERFACE BOARDS IN LOCATION SHOWN, EVEN WHEN SOME FUNCTIONS ARE EXCLUDED.
3. APPLY SUPPLIED LABELS AS SHOWN.

45

EDACS INTERFACE PANEL (G15) – SIMULCAST CONTROL POINT

(19D904009, Sh. 15, Rev. 7)

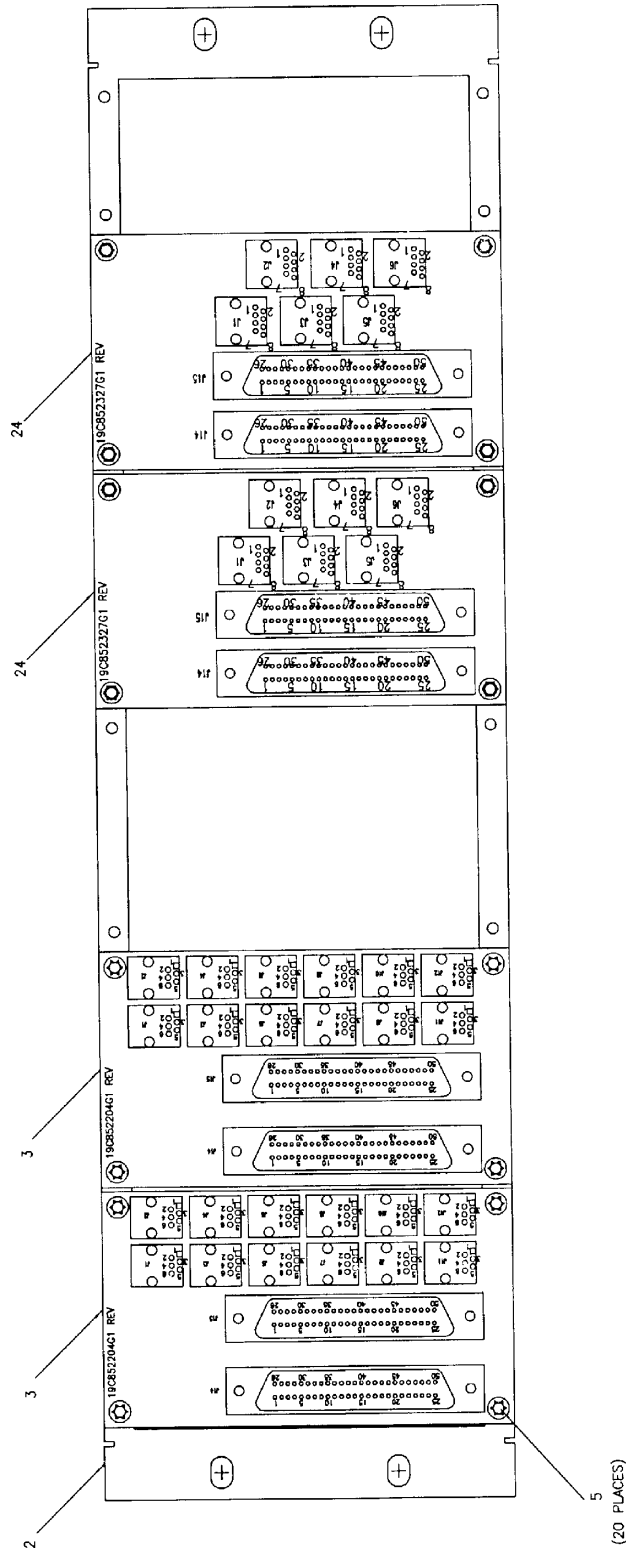

INSTALLATION

146

1. INSTALL IN CABINET/OPEN RACK USING FOUR 7160861P33 SPRING NUTS AND 134011P1 SCREWS. MOUNT AS SHOWN IN LEASED LINE INTERFACE CABINET DRAWING 19D904560.

EUROEDACS LEASE LINE INTERFACE

46

1. BOARD ASSEMBLIES SUPPLIED AS REQUIRED TO CONFORM WITH CABINET CONFIGURATION.
2. MOUNT EACH FUNCTION OF INTERFACE BOARDS IN LOCATION SHOWN, EVEN WHEN SOME FUNCTIONS ARE EXCLUDED.

EDACS INTERFACE PANEL (G16) – EURO EDACS LEASED LINE INTERFACE

(10D904009, Sh. 16, Rev. 7)

STATION ASSEMBLY DIAGRAM

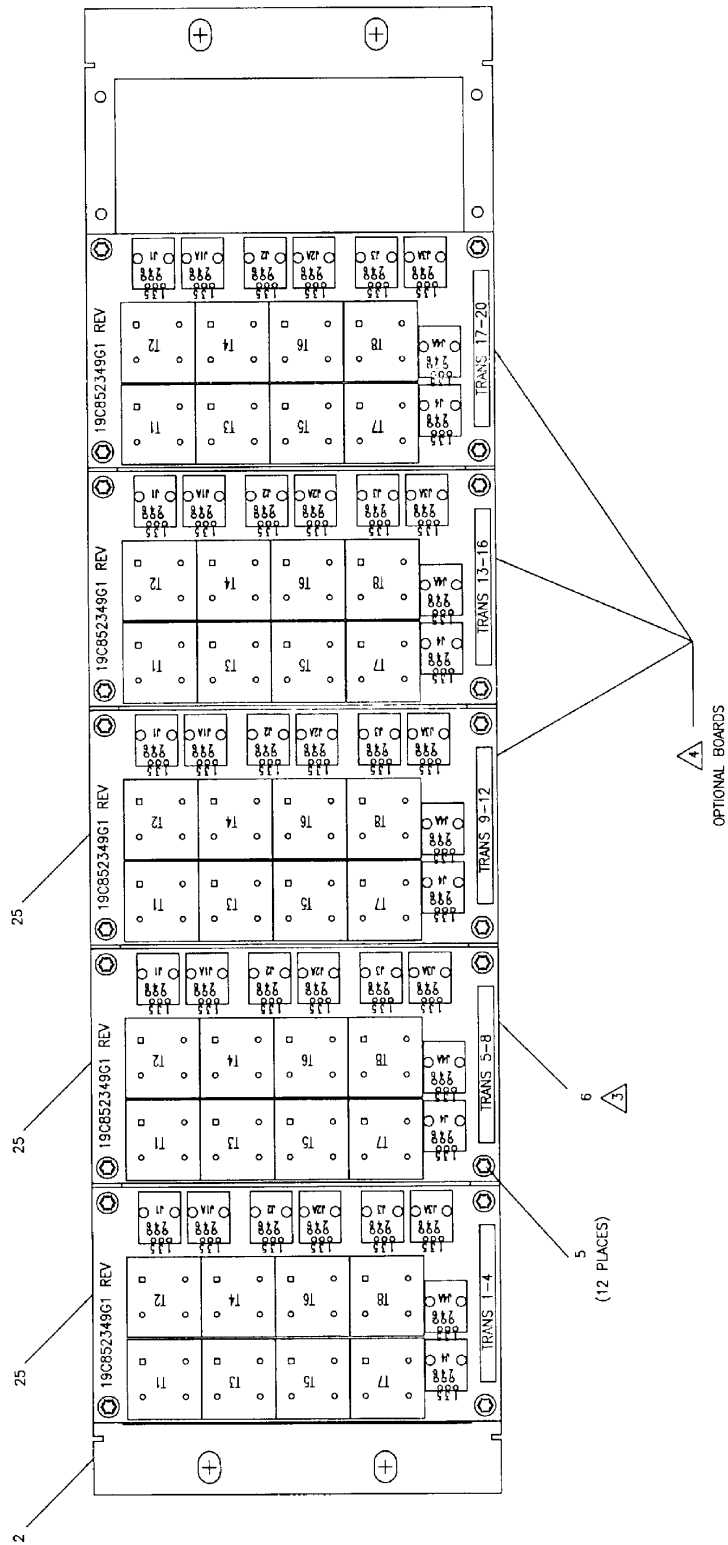

INSTALLATION

1. INSTALL IN REAR OF CABINET/OPEN RACK USING FOUR 7160861P33 SPRING NUTS AND 134011P1 SCREWS. MOUNT DIRECTLY BELOW EXISTING EDACS INTERFACE PANELS.

147

RIC TRANSFORMER PANEL

1. BOARD ASSEMBLIES SUPPLIED AS REQUIRED TO CONFORM WITH CABINET CONFIGURATION.
2. MOUNT EACH FUNCTION OF INTERFACE BOARDS IN LOCATION SHOWN, EVEN WHEN SOME FUNCTIONS ARE EXCLUDED.
3. APPLY SUPPLIED LABELS AS SHOWN.
4. OPTIONAL BOARDS SUPPLIED AND INSTALLED AT CABINET INSTALLATION. INCLUDE UNUSED NAMEPLATES WITH PANEL FOR USE ON OPTIONAL BOARDS.

47

EDACS INTERFACE PANEL (G17) – RIC TRANSFORMER PANEL

(19D904009, Sh. 17, Rev. 7)

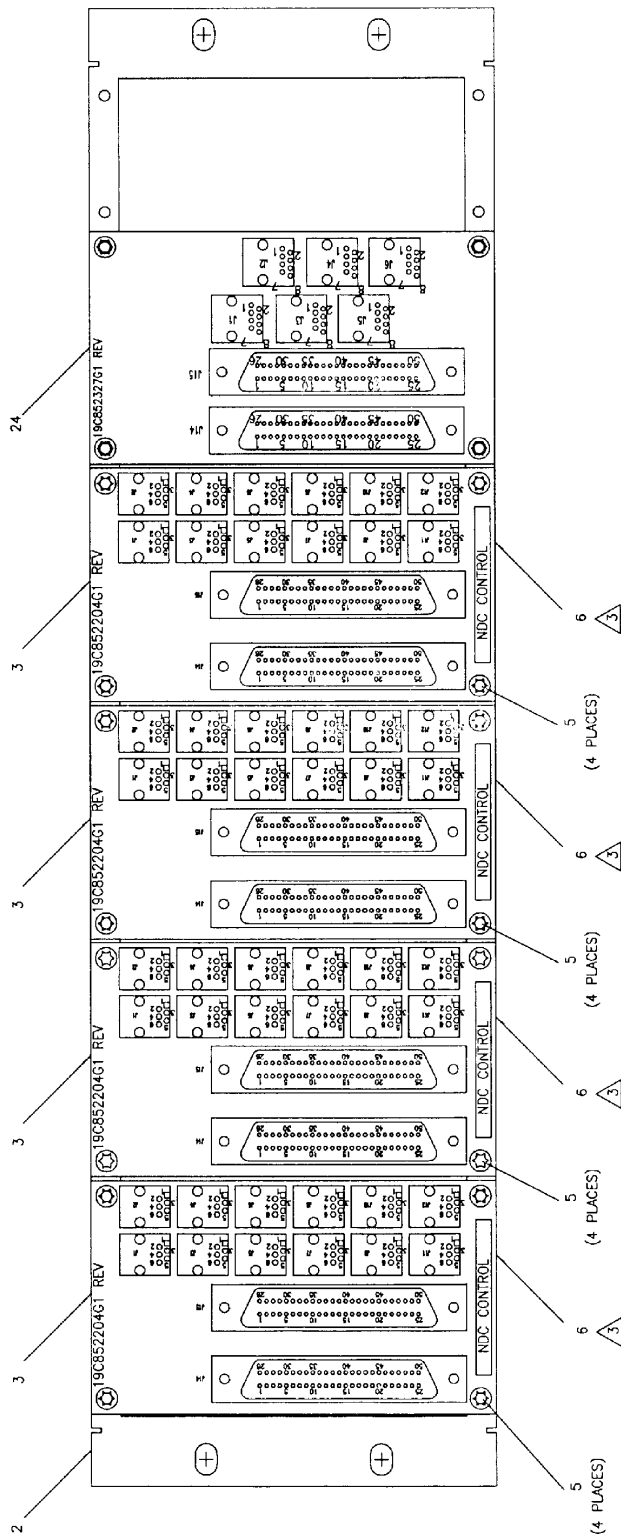

INSTALLATION

148

NDC CONTROL

48

1. BOARD ASSEMBLES SUPPLIED AS REQUIRED TO CONFORM WITH CABINET CONFIGURATION.
 2. MOUNT EACH FUNCTION OF INTERFACE BOARDS IN LOCATION SHOWN, EVEN WHEN SOME FUNCTIONS ARE EXCLUDED.
 3. APPLY SUPPLIED LABELS AS SHOWN.
1. INSTALL IN REAR OF CABINET/OPEN RACK USING FOUR 7160851P33 SPRING NUTS AND 134011P1 SCREWS. MOUNT 2 RACK UNITS FROM THE TOP OF REAR MOUNTING RAIL IN CABINET AND 3 RU FROM TOP OF OPEN RACK.

EDACS INTERFACE PANEL (G18) – JESSICA CONTROL

19D904009, Sh. 18, Rev.7)

STATION ASSEMBLY DIAGRAM

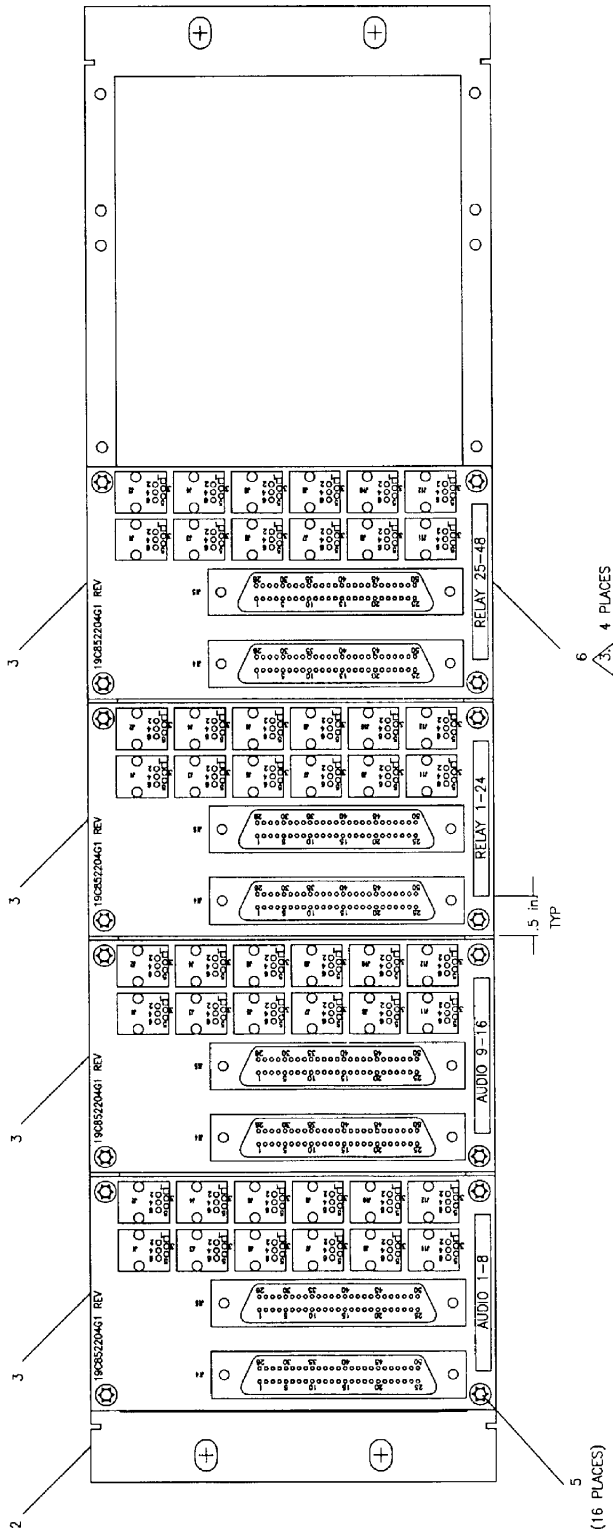

DVIU INTERFACE PANEL

1. BOARD ASSEMBLIES SUPPLIED AS REQUIRED TO CONFORM WITH CABINET CONFIGURATION.
2. MOUNT EACH FUNCTION OF INTERFACE BOARDS IN LOCATION SHOWN, EVEN WHEN SOME FUNCTIONS ARE EXCLUDED.
3. APPLY SUPPLIED LABELS AS SHOWN.

EDACS INTERFACE PANEL (G19) – DVIU INTERFACE PANEL

(19D904009, Sh. 19, Rev. 7)

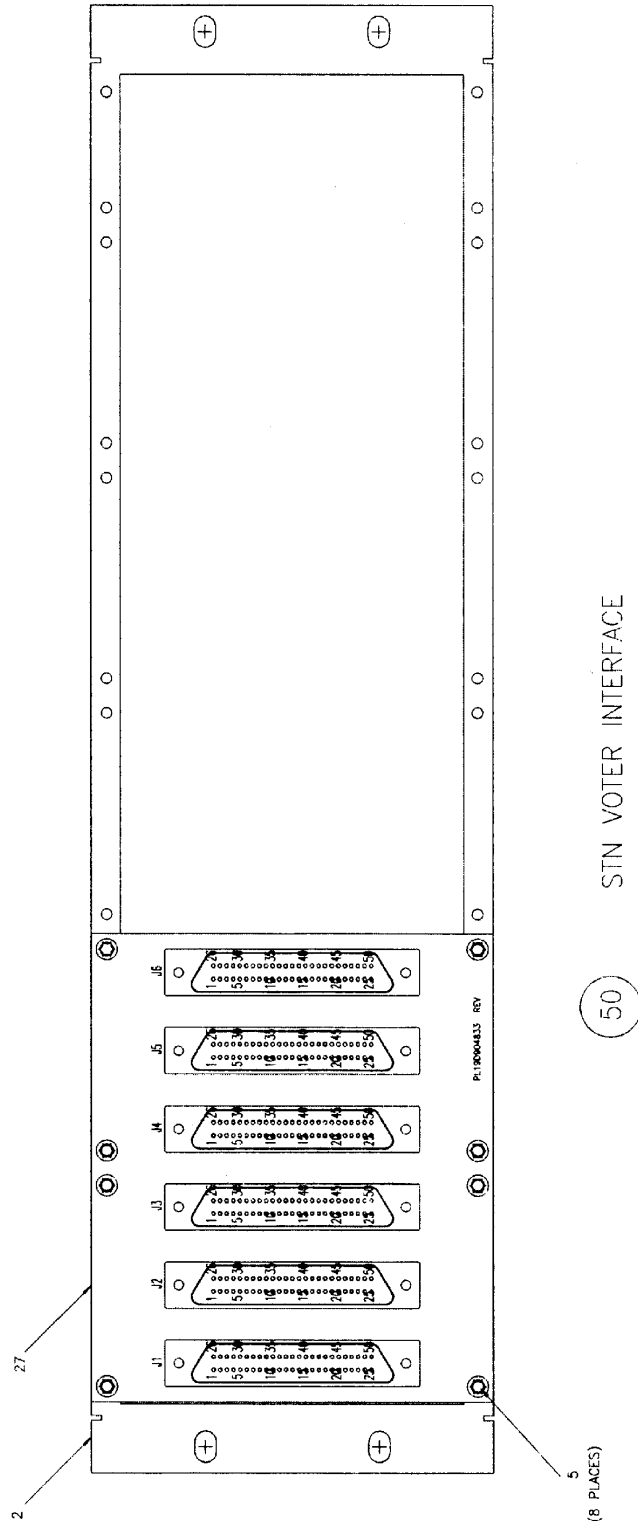

1. BOARD ASSEMBLIES SUPPLIED AS REQUIRED TO CONFORM WITH CABINET CONFIGURATION.
2. MOUNT EACH FUNCTION OF INTERFACE BOARDS IN LOCATION SHOWN, EVEN WHEN SOME FUNCTIONS ARE EXCLUDED.

EDACS INTERFACE PANEL (G20) – STN VOTER INTERFACE

(19D904009, Sh. 20, Rev.7)

STATION ASSEMBLY DIAGRAM

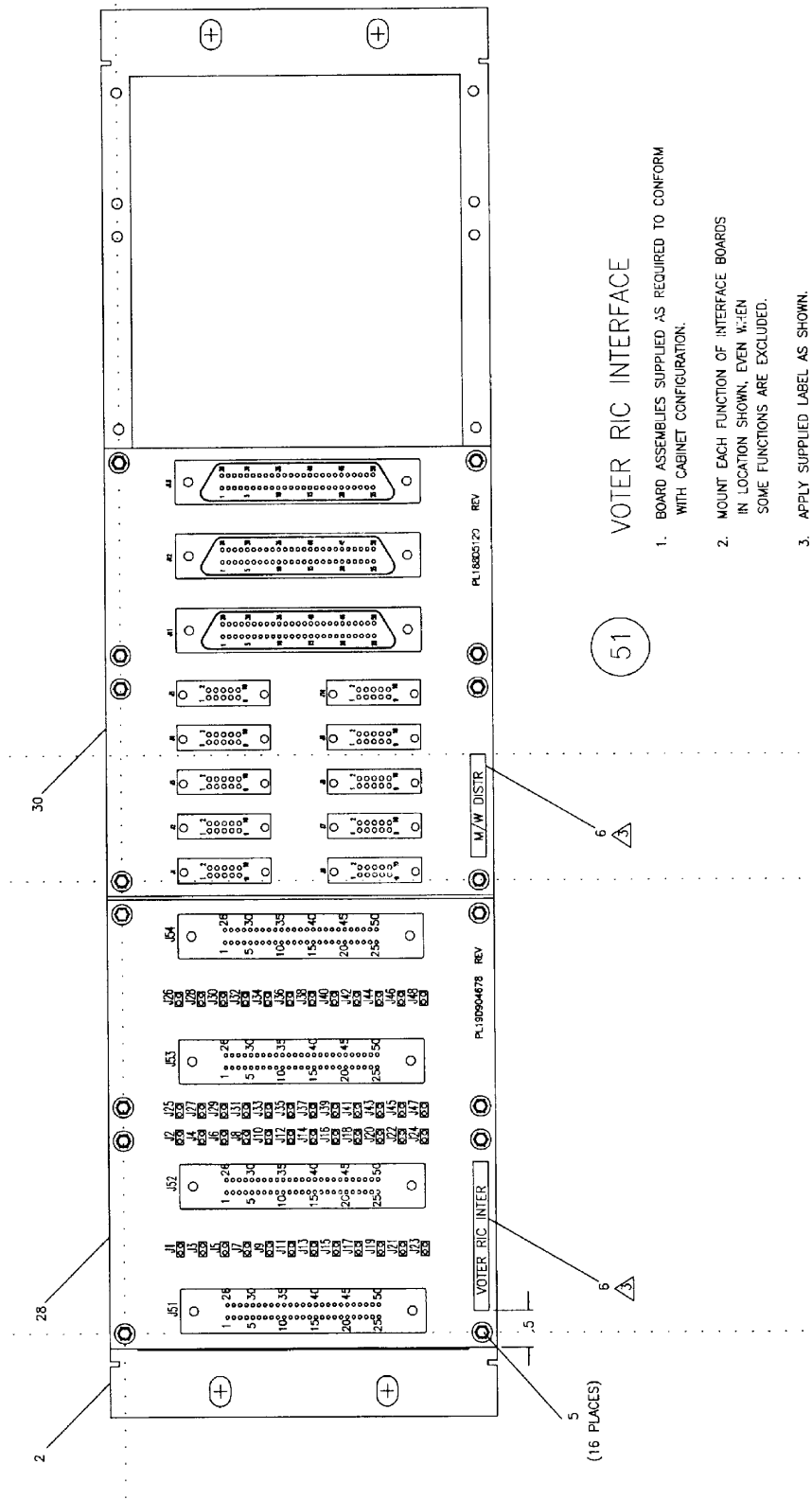

EDACS INTERFACE PANEL (G21) – VOTER RIC INTERFACE

19D904009, Sh. 21, Rev. 7)

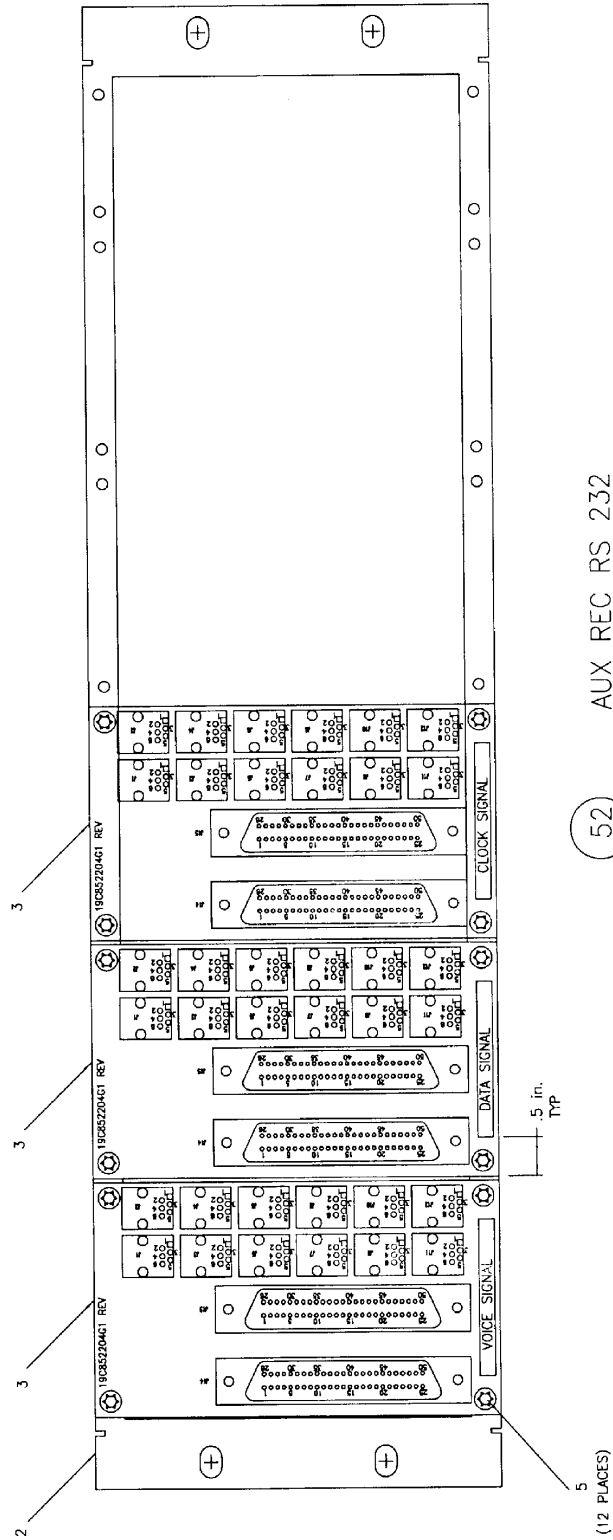

1. BOARD ASSEMBLIES SUPPLIED AS REQUIRED TO CONFORM WITH CABINET CONFIGURATION.
2. MOUNT EACH FUNCTION OF INTERFACE BOARDS IN LOCATION SHOWN, EVEN WHEN SOME FUNCTIONS ARE EXCLUDED.
3. APPLY SUPPLIED LABELS AS SHOWN.

EDACS INTERFACE PANEL (G22) – AUXILIARY RECEIVER RS-232

(19D904009, Sh. 22, Rev. 7)

STATION ASSEMBLY DIAGRAM

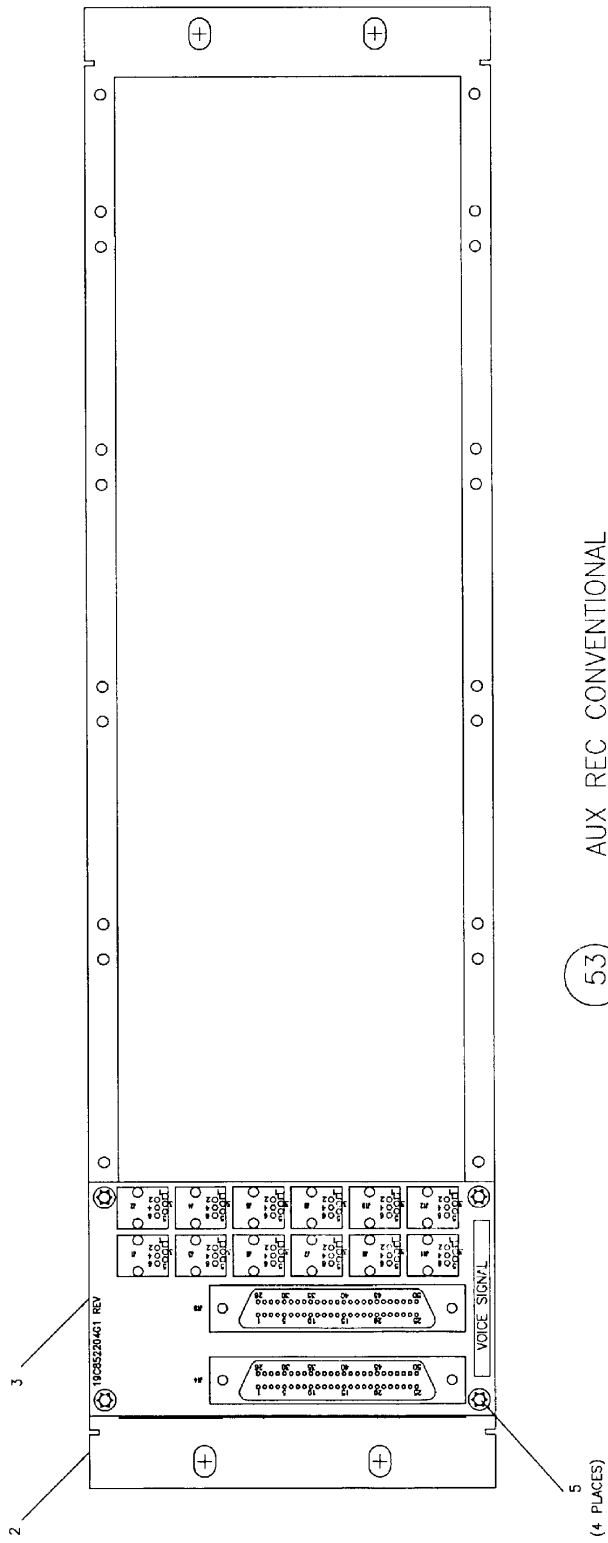

1. BOARD ASSEMBLIES SUPPLIED AS REQUIRED TO CONFORM WITH CABINET CONFIGURATION.
2. MOUNT EACH FUNCTION OF INTERFACE BOARDS IN LOCATION SHOWN, EVEN WHEN SOME FUNCTIONS ARE EXCLUDED.
3. APPLY SUPPLIED LABELS AS SHOWN.

EDACS INTERFACE PANEL (G23) – AUXILIARY RECEIVER CONVENTIONAL

(19D904009, Sh. 23, Rev.7)

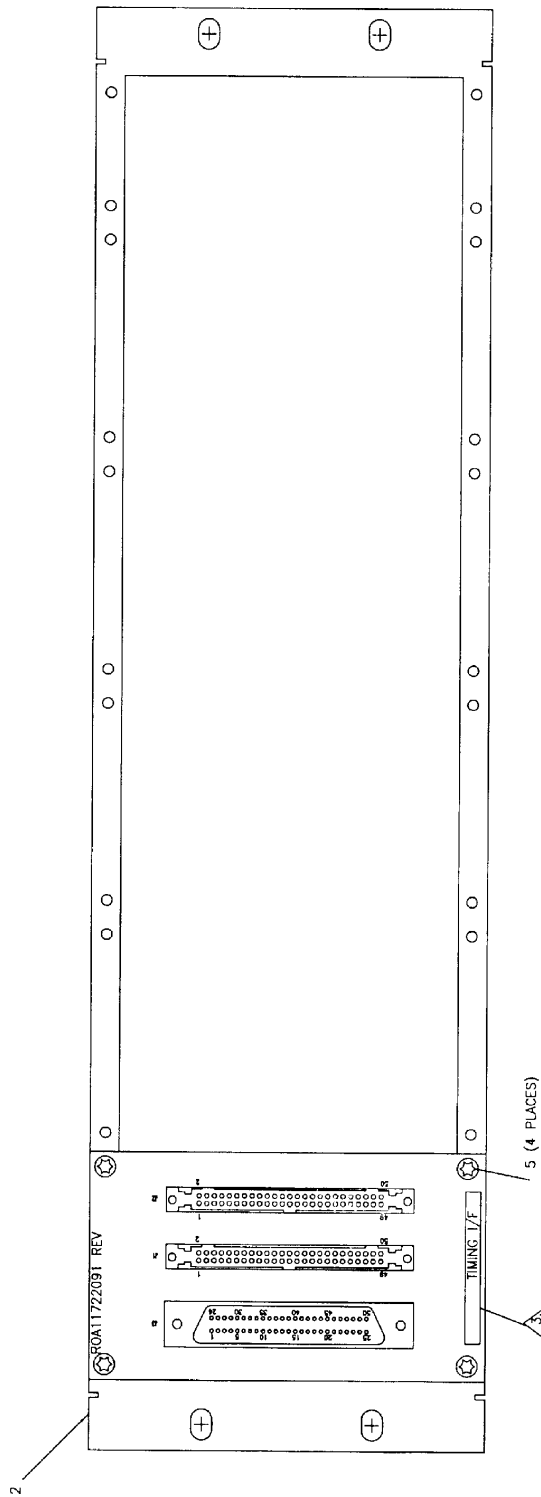

EDACS INTERFACE PANEL (G25) – SIMULCAST TX STE (RS-232 DATA)

(19D904009, Sh. 24, Rev. 7)

INSTALLATION

1. INSTALL IN REAR OF CABINET/OPEN RACK USING FOUR 7160861P33 SPRING NUTS AND 134011P1 SCREWS. MOUNT 2 RACK UNITS FROM THE TOP OF REAR MOUNTING RAIL IN CABINET AND 3 RU FROM TOP OF OPEN RACK.

155

SIMULCAST TX SITE (RS232 DATA)

1. BOARD ASSEMBLIES SUPPLIED AS REQUIRED TO CONFORM WITH CABINET CONFIGURATION.
2. MOUNT EACH FUNCTION OF INTERFACE BOARDS IN LOCATION SHOWN, EVEN WHEN SOME FUNCTIONS ARE EXCLUDED.
3. APPLY SUPPLIED LABELS AS SHOWN.

55

STATION ASSEMBLY DIAGRAM

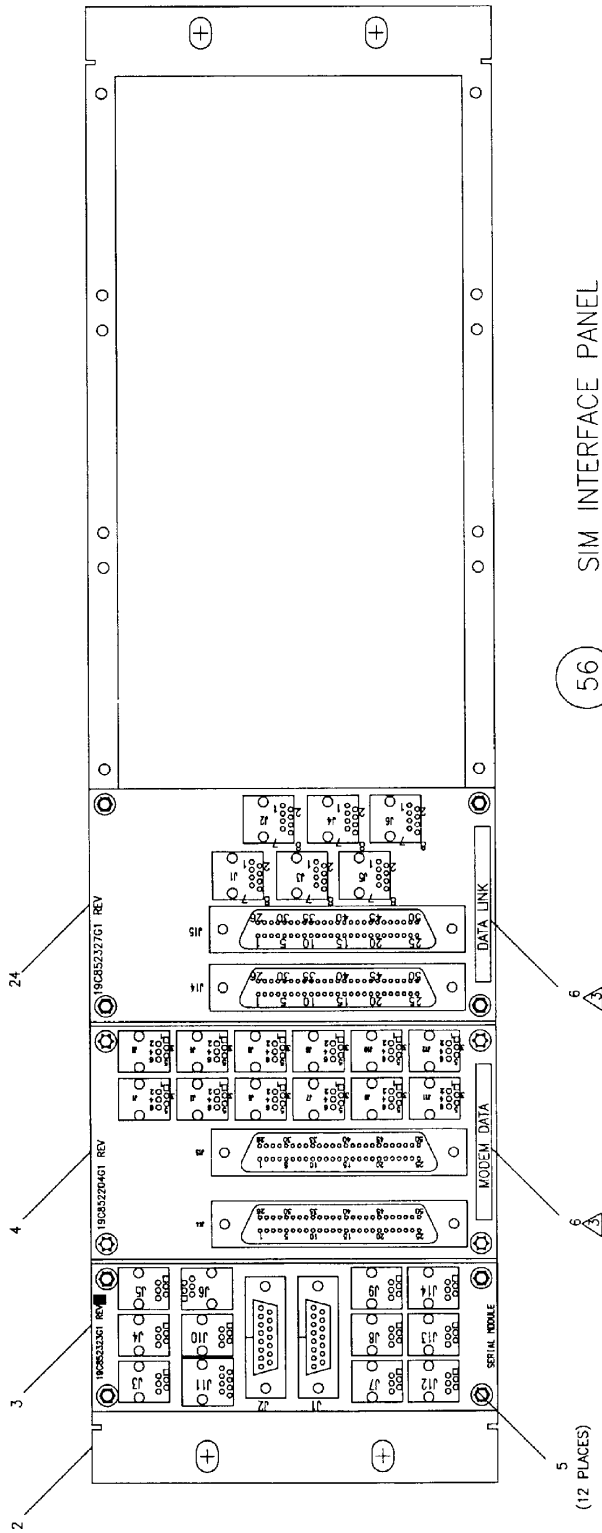

56 SIM INTERFACE PANEL

1. BOARD ASSEMBLIES SUPPLIED AS REQUIRED TO CONFORM WITH CABINET CONFIGURATION.
 2. MOUNT EACH FUNCTION OF INTERFACE BOARDS IN LOCATION SHOWN, EVEN WHEN SOME FUNCTIONS ARE EXCLUDED.
- ▲ APPLY SUPPLIED LABELS AS SHOWN.

INSTALLATION

1. INSTALL IN REAR OF CABINET/OPEN RACK USING FOUR 7160861P33 SPRING NUTS AND 134011P1 SCREWS. MOUNT 2 RACK UNITS FROM THE TOP OF REAR MOUNTING RAIL IN CABINET AND 3 RU FROM TOP OF OPEN RACK.

EDACS INTERFACE PANEL (G26) – SIM INTERFACE PANEL

(19D904009, Sh. 25, Rev.7)

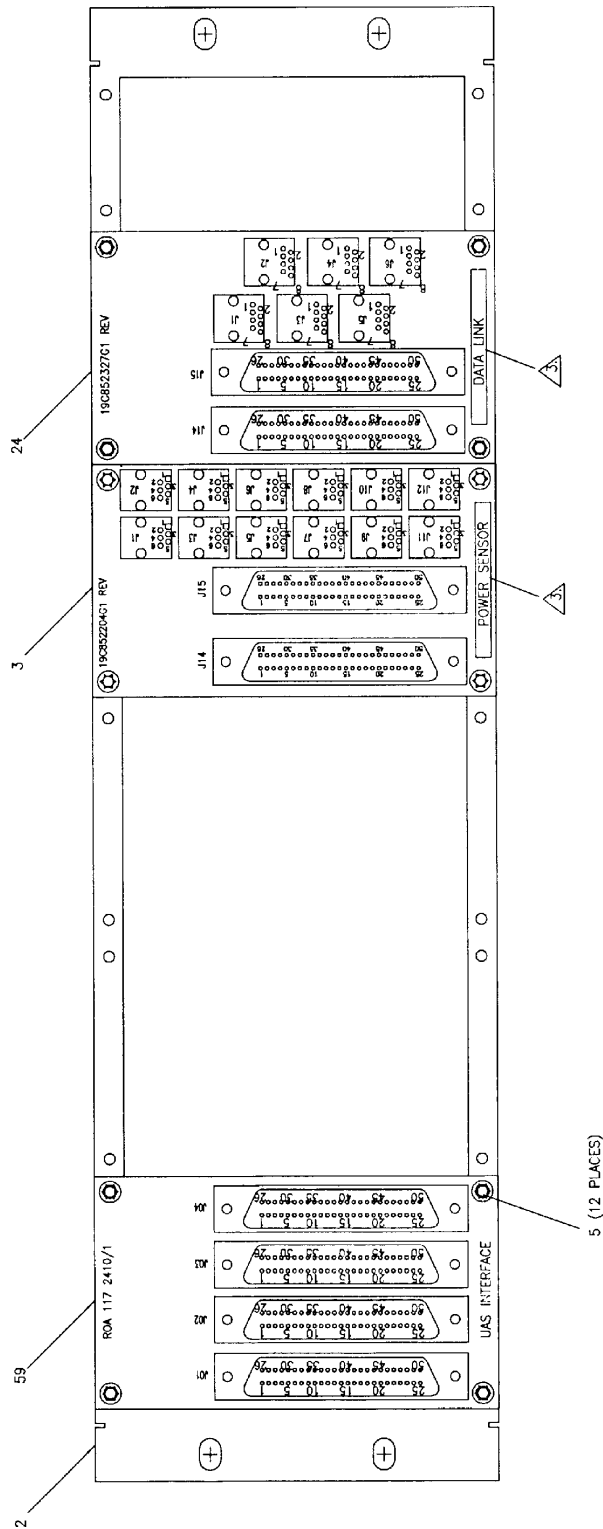

60 SITE SENTRY/ELI/SIM INTERFACE PANEL

160 INSTALLATION

1. INSTALL IN REAR OF CABINET/OPEN RACK USING FOUR 716086P33 SPRING NUTS AND 19A134011P1 SCREWS. MOUNT AS SHOWN IN BASE STATION CABINET DIRECTLY UNDER EXISTING INTERFACE PANEL.

1. BOARD ASSEMBLIES SUPPLIED AS REQUIRED TO CONFORM WITH CABINET CONFIGURATION.
 2. MOUNT EACH FUNCTION OF INTERFACE BOARDS IN LOCATION SHOWN, EVEN WHEN SOME FUNCTIONS ARE EXCLUDED.
- ⚠️ APPLY SUPPLIED LABELS AS SHOWN.

EDACS INTERFACE PANEL (G28) – SITE SENTRY/ELI/SIM (MASTR III)

(19D904009, Sh. 26, Rev.7)

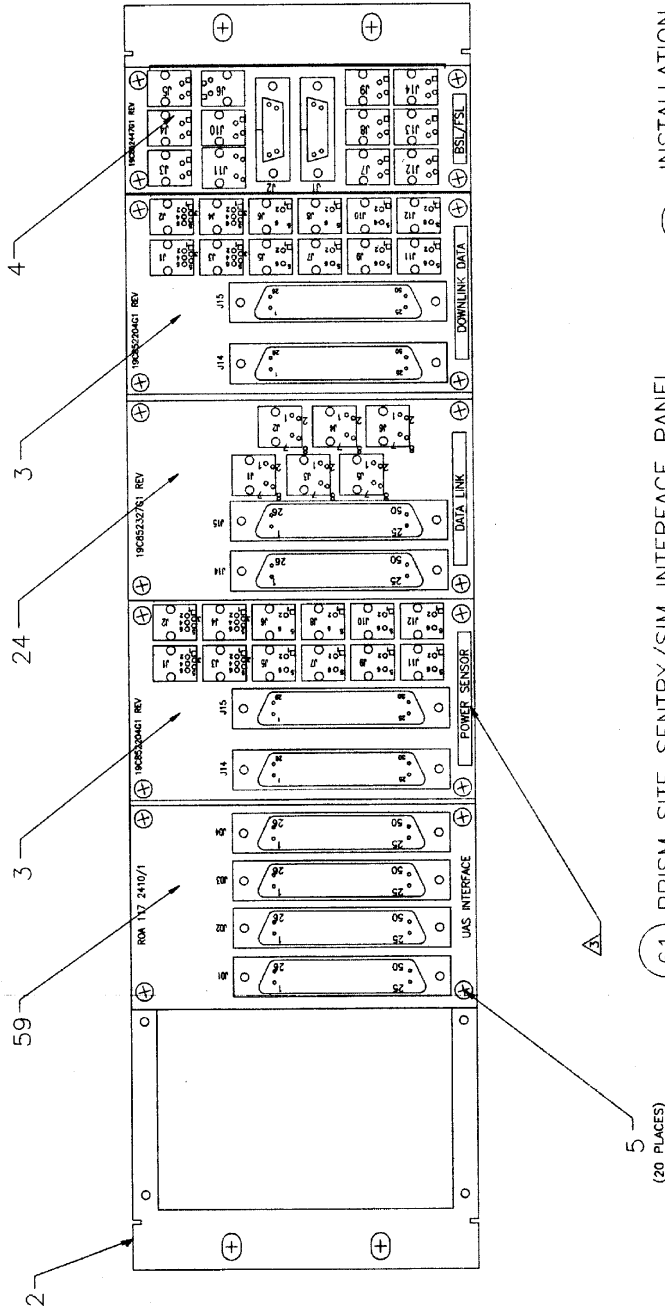

INSTALLATION

161

61 PRISM SITE SENTRY/SIM INTERFACE PANEL

1. INSTALL IN REAR OF CABINET/OPEN RACK USING FOUR 7160861P33 SPRING NUTS AND 19A134011P1 SCREWS. MOUNT AS SHOWN IN SIM/SITE SENTRY CABINET AT TOP

1. BOARD ASSEMBLIES SUPPLIED AS REQUIRED TO CONFORM WITH CABINET CONFIGURATION.

2. MOUNT EACH FUNCTION OF INTERFACE BOARDS IN LOCATION SHOWN, EVEN WHEN SOME FUNCTIONS ARE EXCLUDED.

▲ APPLY SUPPLIED LABELS AS SHOWN. TRIM AS NEEDED TO FIT.

EDACS INTERFACE PANEL (G29) – PRISM SITE SENTRY/SIM

(19D904009, Sh. 27, Rev. 7)

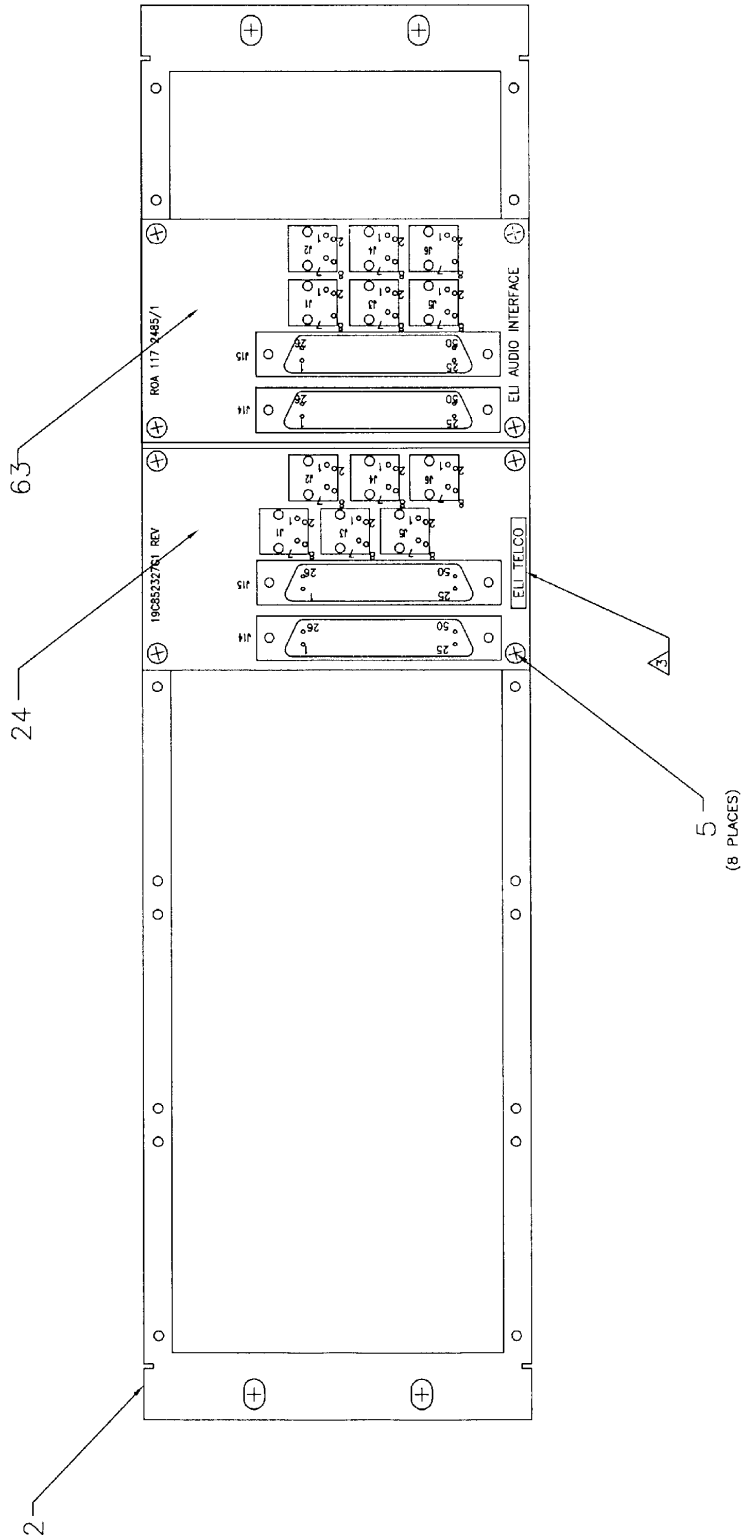

62 PRISM ELI AUDIO INTERFACE PANEL

INSTALLATION

162

- 1. BOARD ASSEMBLIES SUPPLIED AS REQUIRED TO CONFORM WITH CABINET CONFIGURATION.
- 2. MOUNT EACH FUNCTION OF INTERFACE BOARDS IN LOCATION SHOWN, EVEN WHEN SOME FUNCTIONS ARE EXCLUDED.
- 3. APPLY SUPPLIED LABELS AS SHOWN.

- 1. INSTALL IN REAR OF CABINET/OPEN RACK USING FOUR 7160861P33 SPRING NUTS AND 19A134011P1 SCREWS. MOUNT AS SHOWN IN CABINET DIRECTLY UNDER EXISTING INTERFACE PANEL.

EDACS INTERFACE PANEL (G30) – PRISM ELI AUDIO

(19D904009, Sh. 28, Rev. 7)

STATION ASSEMBLY DIAGRAM

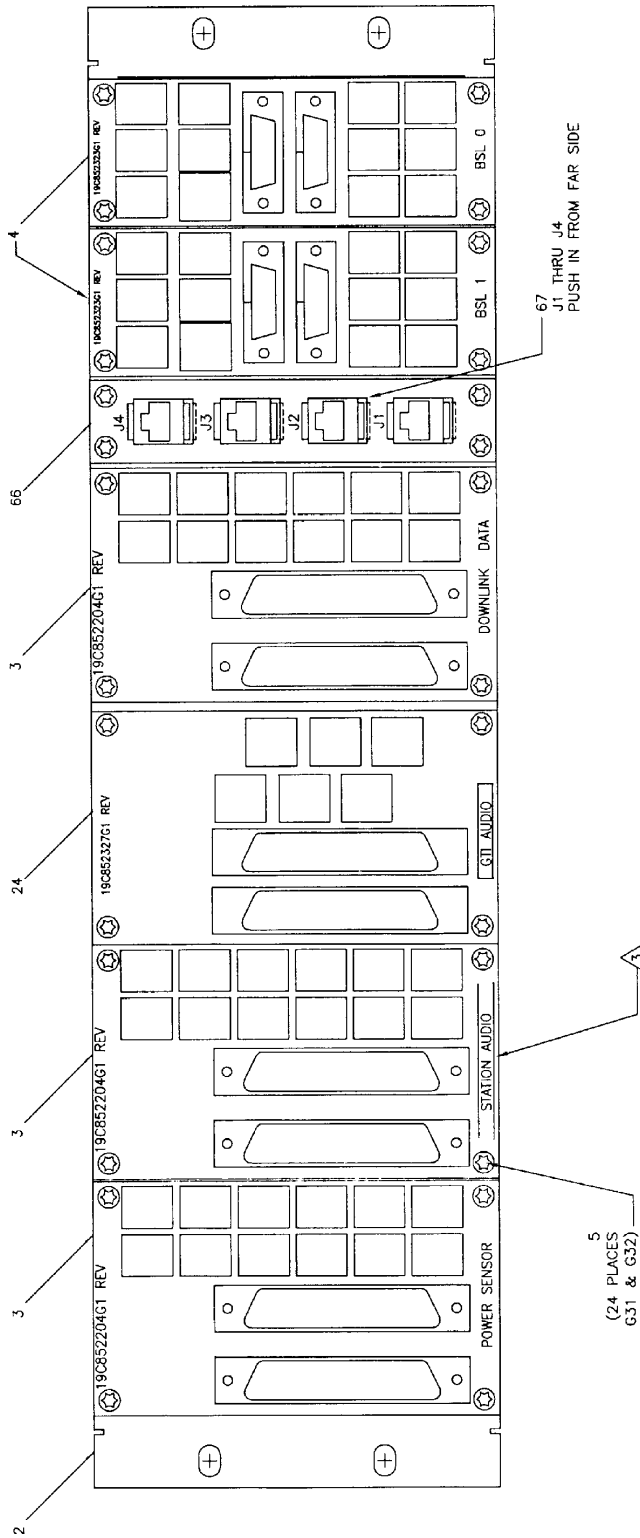

- 64) STATION ASSEMBLY WITH SITEPRO
(ASSEMBLY PART FROM GROUP 31 & 32)
1. BOARD ASSEMBLIES SUPPLIED AS REQUIRED TO CONFORM WITH CABINET CONFIGURATION
 2. MOUNT EACH FUNCTION OF INTERFACE BOARDS IN LOCATION SHOWN, EVEN WHEN SOME FUNCTIONS ARE EXCLUDED.
- △ APPLY SUPPLIED LABELS AS SHOWN.

164) INSTALLATION

1. INSTALL IN REAR OF CABINET/OPEN RACK USING FOUR 7160861P33 SPRING NUTS AND 19A134011P2 SCREWS.
- MOUNT AS SHOWN IN APPLICATION ASSEMBLY

EDACS INTERFACE PANEL (G31 & G32) – STATION ASSEMBLY WITH SITEPRO

(19D904009, Sh. 29, Rev. 7)

(This page intentionally left blank)

