



	<u>Date(s) of Evaluation</u> October 25-26, 2007	<u>Test Report Serial No.</u> 102507OWD-T868a-S90U	<u>Test Report Revision No.</u> Revision 1.0	 Certificate No. 2470.01
	<u>Test Report Issue Date</u> January 08, 2008	<u>Description of Test(s)</u> Specific Absorption Rate	<u>RF Exposure Category</u> Occupational (Controlled)	

SAR TEST REPORT		
RF EXPOSURE EVALUATION	SPECIFIC ABSORPTION RATE	
APPLICANT	M/A-COM, INC.	
PRODUCT	PORTABLE UHF-L PTT RADIO TRANSCEIVER	
MODEL(S)	P7100 (UHF-L)	
FCC IDENTIFIER	OWDTR-0016-E	
IC IDENTIFIER	3636B-0016	
APPLICATION TYPE	Permissive Change - Addition of Alkaline Battery Pack	
STANDARD(S) APPLIED	FCC 47 CFR §2.1093 Health Canada Safety Code 6	
PROCEDURE(S) APPLIED	FCC OET Bulletin 65, Supplement C (01-01) Industry Canada RSS-102 Issue 2	
FCC DEVICE CLASSIFICATION	Licensed Non-Broadcast Transmitter Held to Face (TNF)	
IC DEVICE CLASSIFICATION	Land Mobile Radio Transmitter/Receiver (27.41-960 MHz)	
RF EXPOSURE CATEGORY	Occupational / Controlled	
RF EXPOSURE EVALUATION(S)	Face-held & Body-worn	
DATE(S) OF EVALUATION(S)	October 25-26, 2007	
TEST REPORT SERIAL NO.	102507OWD-T868a-S90U	
TEST REPORT REVISION NO.	Revision 1.0 (Initial Release)	
TEST REPORT ISSUE DATE	January 08, 2008	
TEST REPORT SIGNATORIES	Testing Performed By Sean Johnston Celltech Labs Inc.	Test Report Prepared By Jonathan Hughes Celltech Labs Inc.
	TEST LAB AND LOCATION Celltech Compliance Testing and Engineering Lab 21-364 Lougheed Road, Kelowna, B.C. V1X 7R8 Canada	
TEST LAB CONTACT INFO.	Tel.: 250-765-7650	Fax: 250-765-7645
	info@celltechlabs.com	www.celltechlabs.com
TEST LAB ACCREDITATION(S)	 Certificate No. 2470.01	

Applicant:	M/A-COM, Inc.	FCC ID:	OWDTR-0016-E	IC:	3636B-0016	Freq.:	378 - 430 MHz	
Model(s):	P7100 (UHF-L)	DUT Type:	Portable UHF-L PTT Radio Transceiver with Alkaline Battery Pack					
2008 Celltech Labs Inc.		This document is not to be reproduced in whole or in part without the prior written permission of Celltech Labs Inc.						Page 1 of 33

	<u>Date(s) of Evaluation</u> October 25-26, 2007	<u>Test Report Serial No.</u> 102507OWD-T868a-S90U	<u>Test Report Revision No.</u> Revision 1.0	 Certificate No. 2470.01
	<u>Test Report Issue Date</u> January 08, 2008	<u>Description of Test(s)</u> Specific Absorption Rate	<u>RF Exposure Category</u> Occupational (Controlled)	

DECLARATION OF COMPLIANCE SAR RF EXPOSURE EVALUATION

Test Lab Information	Name	CELLTECH LABS INC.		
	Address	21-364 Lougheed Road, Kelowna B.C. V1X 7R8 Canada		
Company Information	Name	M/A-COM, INC.		
	Address	221 Jefferson Ridge Parkway Lynchburg, VA 24501 United States		
Standard(s) Applied	FCC	47 CFR §2.1093		
	IC	Health Canada Safety Code 6		
Procedure(s) Applied	FCC	OET Bulletin 65, Supplement C (Edition 01-01)		
	IC	RSS-102 Issue 2		
Device Classification	FCC	Licensed Non-Broadcast Transmitter Held to Face (Part 90)		
	IC	Land Mobile Radio Transceiver (RSS-119)		
RF Exposure Category	Occupational / Controlled Environment			
Application Type	Permissive Change - Addition of Alkaline Battery Pack (P/N: BT-013259-001)			
	Original FCC Grant Date: May 21, 2003	Original IC Certification Date: July 9, 2003		
Device Description	Portable UHF-L PTT Radio Transceiver			
Device Model(s)	P7100 (UHF-L)			
FCC IDENTIFIER	OWDTR-0016-E			
IC IDENTIFIER	3636B-0016			
Serial No. Tested	T1-L SAR02			
Frequency Range(s)	378 - 430 MHz			
Antenna Types Tested	Face-held - Helical Coil (P/N: KRE1011219/10)			
	Body-worn - ¼-Wave Whip (P/N: KRE1011223/10)			
Battery Type(s) Tested	Alkaline - 1.5V, 2850mAh Duracell Procell (x6 AA)			
Body-worn Accessories Tested	Metal Belt-Clip (P/N: CC23894)			
Audio Accessories Tested	Speaker-Microphone Non-Antenna Version (P/N: KRY1011617/183)			
Max. SAR Level(s) Evaluated	Face-held	1.75 W/kg	averaged over 1g	50% Duty Cycle
	Body-worn	6.14 W/kg	averaged over 1g	50% Duty Cycle
FCC/IC Spatial Peak SAR Limit(s)	Head/Body	8.0 W/kg	averaged over 1g	Occupational / Controlled Exposure

Celltech Labs Inc. declares under its sole responsibility that this wireless portable device has demonstrated compliance with the Specific Absorption Rate (SAR) RF exposure requirements specified in FCC 47 CFR §2.1093 and Health Canada's Safety Code 6 for the Occupational / Controlled Exposure environment. The device was evaluated in accordance with the measurement standards and procedures specified in FCC OET Bulletin 65, Supplement C (Edition 01-01) and Industry Canada RSS-102 Issue 2. All measurements were performed in accordance with the SAR system manufacturer recommendations.

I attest to the accuracy of data. All measurements were performed by me or were made under my supervision and are correct to the best of my knowledge and belief. I assume full responsibility for the completeness of these measurements and vouch for the qualifications of all persons taking them.

The results and statements contained in this report pertain only to the device(s) evaluated.

This test report shall not be reproduced partially, or in full, without the prior written approval of Celltech Labs Inc.

Test Report Approved By



Sean Johnston

Celltech Labs Inc.



Applicant:	M/A-COM, Inc.	FCC ID:	OWDTR-0016-E	IC:	3636B-0016	Freq.:	378 - 430 MHz	
Model(s):	P7100 (UHF-L)	DUT Type:	Portable UHF-L PTT Radio Transceiver with Alkaline Battery Pack					
2008 Celltech Labs Inc.	This document is not to be reproduced in whole or in part without the prior written permission of Celltech Labs Inc.							Page 2 of 33







	<u>Date(s) of Evaluation</u> October 25-26, 2007	<u>Test Report Serial No.</u> 102507OWD-T868a-S90U	<u>Test Report Revision No.</u> Revision 1.0	  Certificate No. 2470.01
	<u>Test Report Issue Date</u> January 08, 2008	<u>Description of Test(s)</u> Specific Absorption Rate	<u>RF Exposure Category</u> Occupational (Controlled)	

TABLE OF CONTENTS

1.0 INTRODUCTION	4
2.0 SAR MEASUREMENT SYSTEM	4
3.0 SAR MEASUREMENT SUMMARY	5
4.0 DETAILS OF SAR EVALUATION	6
5.0 EVALUATION PROCEDURES	6
6.0 SYSTEM PERFORMANCE CHECK	7
7.0 SIMULATED EQUIVALENT TISSUES	8
8.0 SAR LIMITS	8
9.0 ROBOT SYSTEM SPECIFICATIONS	9
10.0 PROBE SPECIFICATION (ET3DV6)	10
11.0 SIDE PLANAR PHANTOM	10
12.0 VALIDATION PLANAR PHANTOM	10
13.0 DEVICE HOLDER	10
14.0 TEST EQUIPMENT LIST	11
15.0 MEASUREMENT UNCERTAINTIES	12
MEASUREMENT UNCERTAINTIES (Cont.)	13
16.0 REFERENCES	14
APPENDIX A - SAR MEASUREMENT DATA	15
APPENDIX B - SYSTEM PERFORMANCE CHECK DATA	20
APPENDIX C - MEASURED FLUID DIELECTRIC PARAMETERS	23
APPENDIX D - SAR TEST SETUP & DUT PHOTOGRAPHS	26
APPENDIX E - SYSTEM VALIDATION	32
APPENDIX F - PROBE CALIBRATION	33

Applicant:	M/A-COM, Inc.	FCC ID:	OWDTR-0016-E	IC:	3636B-0016	Freq.:	378 - 430 MHz	
Model(s):	P7100 (UHF-L)	DUT Type:	Portable UHF-L PTT Radio Transceiver with Alkaline Battery Pack					
2008 Celltech Labs Inc.		This document is not to be reproduced in whole or in part without the prior written permission of Celltech Labs Inc.						Page 3 of 33

	<u>Date(s) of Evaluation</u> October 25-26, 2007	<u>Test Report Serial No.</u> 102507OWD-T868a-S90U	<u>Test Report Revision No.</u> Revision 1.0	
	<u>Test Report Issue Date</u> January 08, 2008	<u>Description of Test(s)</u> Specific Absorption Rate	<u>RF Exposure Category</u> Occupational (Controlled)	

1.0 INTRODUCTION

This measurement report demonstrates that the M/A-COM Model(s): P7100 UHF-L Portable PTT Radio Transceiver, with the Permissive Change(s) described in this report, continues to comply with the SAR (Specific Absorption Rate) RF exposure requirements specified in FCC 47 CFR §2.1093 (see reference [1]) and Health Canada's Safety Code 6 (see reference [2]) for the Occupational / Controlled Exposure environment. The measurement procedures described in FCC OET Bulletin 65, Supplement C, Edition 01-01 (see reference [3]) and IC RSS-102 Issue 2 (see reference [4]) were employed. A description of the device, operating configuration, detailed summary of the test results, methodology and procedures used in the evaluation, equipment used, and the various provisions of the rules are included within this test report.

2.0 SAR MEASUREMENT SYSTEM

Celltech Labs Inc. SAR measurement facility utilizes the Dosimetric Assessment System (DASY™) manufactured by Schmid & Partner Engineering AG (SPEAG™) of Zurich, Switzerland. The DASY4 measurement system is comprised of the measurement server, robot controller, computer, near-field probe, probe alignment sensor, specific anthropomorphic mannequin (SAM) phantom, and various planar phantoms for brain and/or body SAR evaluations. The robot is a six-axis industrial robot performing precise movements to position the probe to the location (points) of maximum electromagnetic field (EMF). A cell controller system contains the power supply, robot controller, teach pendant (Joystick), and remote control, is used to drive the robot motors. The Staubli robot is connected to the cell controller to allow software manipulation of the robot. A data acquisition electronic (DAE) circuit performs the signal amplification, signal multiplexing, AD-conversion, offset measurements, mechanical surface detection, collision detection, etc. is connected to the Electro-optical coupler (EOC). The EOC performs the conversion from the optical into digital electric signal of the DAE and transfers data to the DASY4 measurement server. The DAE4 utilizes a highly sensitive electrometer-grade preamplifier with auto-zeroing, a channel and gain-switching multiplexer, a fast 16-bit AD-converter and a command decoder and control logic unit. Transmission to the DASY4 measurement server is accomplished through an optical downlink for data and status information and an optical uplink for commands and clock lines. The mechanical probe-mounting device includes two different sensor systems for frontal and sidewise probe contacts. The sensor systems are also used for mechanical surface detection and probe collision detection. The robot uses its own controller with a built in VME-bus computer.

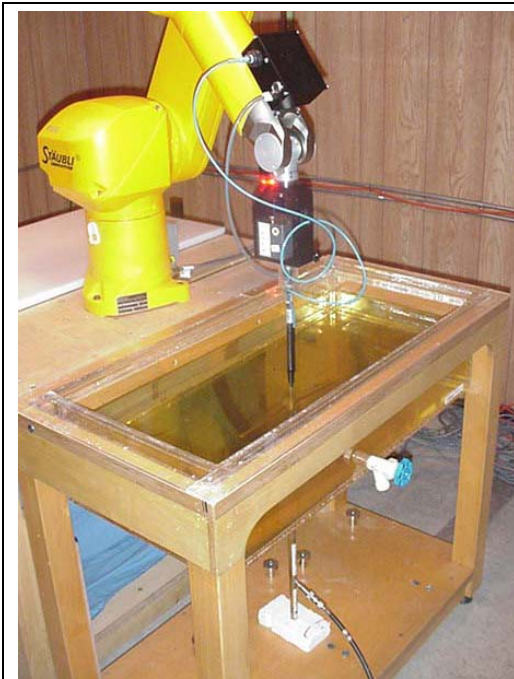



**DASY4 SAR Measurement System
with Plexiglas validation phantom**



**DASY4 SAR Measurement System
with Plexiglas side planar phantom**



Applicant:	M/A-COM, Inc.	FCC ID:	OWDTR-0016-E	IC:	3636B-0016	Freq.:	378 - 430 MHz	
Model(s):	P7100 (UHF-L)	DUT Type:	Portable UHF-L PTT Radio Transceiver with Alkaline Battery Pack					
2008 Celltech Labs Inc.		This document is not to be reproduced in whole or in part without the prior written permission of Celltech Labs Inc.						Page 4 of 33

	<u>Date(s) of Evaluation</u> October 25-26, 2007	<u>Test Report Serial No.</u> 102507OWD-T868a-S90U	<u>Test Report Revision No.</u> Revision 1.0	 Certificate No. 2470.01
	<u>Test Report Issue Date</u> January 08, 2008	<u>Description of Test(s)</u> Specific Absorption Rate	<u>RF Exposure Category</u> Occupational (Controlled)	

3.0 SAR MEASUREMENT SUMMARY

SAR EVALUATION RESULTS														
Test Type	Freq.	Chan.	Test Mode	Antenna Type	Accessories		DUT Position to Planar Phantom	Cond. Power Before Test	Measured SAR 1g (W/kg)		SAR Drift During Test	Scaled SAR 1g (W/kg)		
					Body-worn	Spacing			Duty Cycle			Duty Cycle		
	Audio				Watts				100%	50%		dB	100%	50%
Face-held	403.0000	Mid	CW	Helical Coil	na	2.5 cm	Front Side	4.28	3.48	1.74	-0.028	3.50	1.75	
				na										
Body-worn	403.0000	Mid	CW	¼-wave Whip	Belt-Clip	1.1 cm	Back Side	4.28	12.2	6.10	-0.0310	12.3	6.14	
				Speaker-Mic										
SAR SAFETY LIMIT(S)					BRAIN		BODY		SPATIAL PEAK		RF EXPOSURE CATEGORY			
FCC 47 CFR 2.1093		Health Canada Safety Code 6			8.0 W/kg		8.0 W/kg		averaged over 1 gram		Occupational / Controlled			
Test Date		October 25, 2007			October 26, 2007			Test Date		Oct. 25	Oct. 26	Unit		
Fluid Type		450 MHz Brain			450 MHz Body			Ambient Temperature		22.9	23.0	°C		
Dielectric Constant ϵ_r		IEEE Target		Meas.	Dev.	IEEE Target		Meas.	Dev.	Fluid Temperature		22.8	22.8	°C
		43.5	±5%	43.8	+0.7%	56.7	±5%	58.1	+2.5%	Relative Humidity		31	32	%
Conductivity σ (mho/m)		IEEE Target		Meas.	Dev.	IEEE Target		Meas.	Dev.	Atmospheric Pressure		100.4	100.4	kPa
		0.87	±5%	0.87	0.0%	0.94	±5%	0.94	0.0%	ρ (Kg/m ³)		1000		
Note(s)		1.	The measurement results were obtained with the DUT tested in the conditions described in this report. Detailed measurement data and plots showing the maximum SAR location of the DUT are reported in Appendix A.											
		2.	The test configuration(s) utilized for this Permissive Change evaluation as reported above were determined based on the following previous measurement results: a. maximum face-held SAR level configuration - measured during previous Class II Permissive Change evaluations (please refer to Celltech Test Report Serial No.: 091704OWD-T559-S90U). b. maximum body-worn SAR level configuration - measured during the original certification evaluations (please refer to Celltech Test Report Serial No.: 040403-326OWD).											
		3.	The power droops measured by the DASY4 system for the duration of the SAR evaluations were added to the measured SAR levels to report scaled SAR results as shown in the above test data table.											
		4.	The area scan evaluation was performed with fully charged batteries. After the area scan evaluation was completed the batteries were replaced with fully charged batteries prior to the zoom scan evaluation. Battery Type(s) Evaluated: 1.5V, 2850mAh Duracell Procell Alkaline (x6 AA)											
		5.	The fluid temperature was measured prior to and after the SAR evaluations to ensure the temperature remained within +/-2°C of the fluid temperature reported during the dielectric parameter measurements.											
		6.	The dielectric parameters of the simulated tissue mixtures were measured prior to the SAR evaluations using a Dielectric Probe Kit and a Network Analyzer (see Appendix C).											
		7.	The SAR evaluations were performed within 24 hours of the system performance check.											

Applicant:	M/A-COM, Inc.	FCC ID:	OWDTR-0016-E	IC:	3636B-0016	Freq.:	378 - 430 MHz	
Model(s):	P7100 (UHF-L)	DUT Type:	Portable UHF-L PTT Radio Transceiver with Alkaline Battery Pack					
2008 Celltech Labs Inc.		This document is not to be reproduced in whole or in part without the prior written permission of Celltech Labs Inc.						Page 5 of 33

	<u>Date(s) of Evaluation</u> October 25-26, 2007	<u>Test Report Serial No.</u> 102507OWD-T868a-S90U	<u>Test Report Revision No.</u> Revision 1.0	 Certificate No. 2470.01
	<u>Test Report Issue Date</u> January 08, 2008	<u>Description of Test(s)</u> Specific Absorption Rate	<u>RF Exposure Category</u> Occupational (Controlled)	

4.0 DETAILS OF SAR EVALUATION

The M/A-COM Model(s): P7100 UHF-L Portable PTT Radio Transceiver described in this report was compliant for localized Specific Absorption Rate (Occupational / Controlled Exposure) based on the test provisions and conditions described below. Detailed photographs of the test setup are shown in Appendix D.

Face-held & Body-worn Configurations

- The DUT was tested in a face-held configuration with the front side placed parallel to the outer surface of the planar phantom. A spacing of 2.5 cm was maintained between the front side of the radio and the outer surface of the planar phantom.
- The DUT was tested in a body-worn configuration with the back side placed parallel to the outer surface of the planar phantom. The attached belt-clip was touching the planar phantom and provided a 1.1 cm spacing between the back of the radio and the planar phantom. The body-worn evaluation was performed with the speaker-microphone audio accessory connected to the radio.

Power Level(s) & Test Mode(s)

- The conducted power levels were measured prior to the SAR evaluations at the antenna connector of the DUT using a Gigatronics 8652A Universal Power Meter according to the procedures described in FCC 47 CFR §2.1046 and IC RSS-Gen.
- The area scan evaluation was performed with fully charged batteries. After the area scan evaluation was completed the batteries were replaced with fully charged batteries prior to the zoom scan evaluation.
- The power drift of the DUT during the SAR evaluations was measured by the DASY4 system.
- The DUT was tested in unmodulated continuous transmit operation (Continuous Wave mode at 100% duty cycle) with the transmit key constantly depressed. For a push-to-talk device the 50% duty cycle compensation reported assumes a transmit/receive cycle of equal time base.



Test Conditions

- The fluid temperature was measured prior to and after the SAR evaluations to ensure the temperature remained within +/-2°C of the fluid temperature reported during the dielectric parameter measurements.
- The dielectric parameters of the simulated tissue mixtures were measured prior to the SAR evaluations using a Dielectric Probe Kit and a Network Analyzer (see Appendix C).

5.0 EVALUATION PROCEDURES

- (i) The evaluation was performed in the applicable area of the phantom depending on the type of device being tested. For devices held to the ear during normal operation, both the left and right ear positions were evaluated using the SAM phantom.
(ii) For body-worn and face-held devices a planar phantom was used.
- The SAR was determined by a pre-defined procedure within the DASY4 software. Upon completion of a reference and optical surface check, the exposed region of the phantom was scanned near the inner surface with a grid spacing of 15mm x 15mm.
An area scan was determined as follows:
 - Based on the defined area scan grid, a more detailed grid is created to increase the points by a factor of 10. The interpolation function then evaluates all field values between corresponding measurement points.
 - A linear search is applied to find all the candidate maxima. Subsequently, all maxima are removed that are >2 dB from the global maximum. The remaining maxima are then used to position the cube scans.
A 1 g and 10 g spatial peak SAR was determined as follows:
 - Extrapolation is used to find the points between the dipole center of the probe and the surface of the phantom. This data cannot be measured, since the center of the dipoles is 2.7 mm away from the tip of the probe and the distance between the surface and the lowest measuring point is 1.4 mm (see probe calibration document in Appendix F). The extrapolation was based on trivariate quadratics computed from the previously calculated 3D interpolated points nearest the phantom surface.
 - Interpolated data is used to calculate the average SAR over 1 g and 10 g cubes by spatially discretizing the entire measured cube. The volume used to determine the averaged SAR is a 1mm grid (42875 interpolated points).
 - A zoom scan volume of 32 mm x 32 mm x 30 mm (5 x 5 x 7 points) centered at the peak SAR location determined from the area scan is used for all zoom scans for devices with a transmit frequency < 800 MHz. Depending on the device type under evaluation, zoom scans for frequencies ≥ 800 MHz are typically determined with a scan volume of 30 mm x 30 mm x 30 mm (7 x 7 x 7) to ensure complete capture of the peak spatial-average SAR.

Applicant:	M/A-COM, Inc.	FCC ID:	OWDTR-0016-E	IC:	3636B-0016	Freq.:	378 - 430 MHz	
Model(s):	P7100 (UHF-L)	DUT Type:	Portable UHF-L PTT Radio Transceiver with Alkaline Battery Pack					
2008 Celltech Labs Inc.		This document is not to be reproduced in whole or in part without the prior written permission of Celltech Labs Inc.						Page 6 of 33

	<u>Date(s) of Evaluation</u> October 25-26, 2007	<u>Test Report Serial No.</u> 102507OWD-T868a-S90U	<u>Test Report Revision No.</u> Revision 1.0	 Certificate No. 2470.01
	<u>Test Report Issue Date</u> January 08, 2008	<u>Description of Test(s)</u> Specific Absorption Rate	<u>RF Exposure Category</u> Occupational (Controlled)	

6.0 SYSTEM PERFORMANCE CHECK



Prior to the SAR evaluations a system check was performed using a Plexiglas planar phantom with a 450 MHz dipole (see Appendix B for system performance check test plot). The dielectric parameters of the simulated tissue mixture were measured prior to the system performance check using a Dielectric Probe Kit and a Network Analyzer (see Appendix C for measured fluid dielectric parameters). A forward power of 250 mW was applied to the dipole and the system was verified to a tolerance of $\pm 10\%$ from the system validation target SAR value (see Appendix E for system validation procedures).

SYSTEM PERFORMANCE CHECK EVALUATION

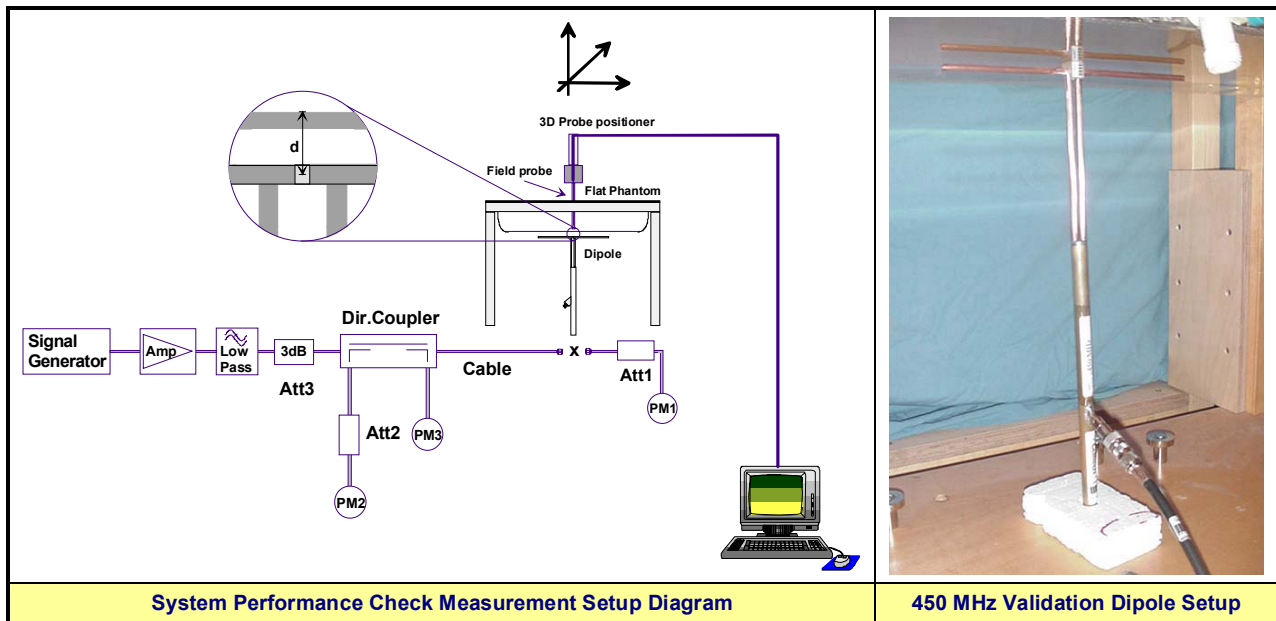
Test Date	Tissue Freq.	SAR 1g (W/kg)			Dielectric Constant ϵ_r			Conductivity σ (mho/m)			ρ (Kg/m ³)	Amb. Temp. (°C)	Fluid Temp. (°C)	Fluid Depth (cm)	Humid. (%)	Barom. Press. (kPa)
	Brain MHz	Sys. Val. Target	Meas.	Dev.	Sys. Val. Target	Meas.	Dev.	Sys. Val. Target	Meas.	Dev.						
	Oct 25	450	1.29 $\pm 10\%$	1.32	+2.4%	43.1 $\pm 5\%$	43.8	+1.7%	0.85 $\pm 5\%$	0.87						
Note(s) <ol style="list-style-type: none"> The target SAR value is referenced from the System Validation procedure performed by Celltech Labs Inc. (see Appendix E). The target dielectric parameters are referenced from the System Validation procedure performed by Celltech Labs Inc. (see Appendix E). The fluid temperature was measured prior to and after the system performance check to ensure the temperature remained within $\pm 2^\circ\text{C}$ of the fluid temperature reported during the dielectric parameter measurements. The SAR evaluations were performed within 24 hours of the system performance check. 																



Applicant:	M/A-COM, Inc.	FCC ID:	OWDTR-0016-E	IC:	3636B-0016	Freq.:	378 - 430 MHz	
Model(s):	P7100 (UHF-L)	DUT Type:	Portable UHF-L PTT Radio Transceiver with Alkaline Battery Pack					
2008 Celltech Labs Inc.		This document is not to be reproduced in whole or in part without the prior written permission of Celltech Labs Inc.						Page 7 of 33

	<u>Date(s) of Evaluation</u> October 25-26, 2007	<u>Test Report Serial No.</u> 102507OWD-T868a-S90U	<u>Test Report Revision No.</u> Revision 1.0	 Certificate No. 2470.01
	<u>Test Report Issue Date</u> January 08, 2008	<u>Description of Test(s)</u> Specific Absorption Rate	<u>RF Exposure Category</u> Occupational (Controlled)	

7.0 SIMULATED EQUIVALENT TISSUES



The simulated tissue mixtures consisted of a viscous gel using hydroxethylcellulose (HEC) gelling agent and saline solution. Preservation with a bactericide was added and visual inspection made to ensure air bubbles were not trapped during the mixing process. The fluid was prepared according to standardized procedures and measured for dielectric parameters (permittivity and conductivity).

SIMULATED TISSUE MIXTURES		
INGREDIENT	450 MHz Brain	450 MHz Body
	System Check & DUT Evaluation	DUT Evaluation
Water	38.56 %	52.00 %
Sugar	56.32 %	45.65 %
Salt	3.95 %	1.75 %
HEC	0.98 %	0.50 %
Bactericide	0.19 %	0.10 %

8.0 SAR LIMITS

SAR RF EXPOSURE LIMITS (W/kg)			
FCC 47 CFR 2.1093	Health Canada Safety Code 6	(General Population / Uncontrolled Exposure)	(Occupational / Controlled Exposure)
Spatial Average (averaged over the whole body)		0.08	0.4
Spatial Peak (averaged over any 1 g of tissue)		1.60	8.0
Spatial Peak (hands/wrists/feet/ankles averaged over 10 g)		4.0	20.0
The Spatial Average value of the SAR averaged over the whole body.			
The Spatial Peak value of the SAR averaged over any 1 gram of tissue (defined as a tissue volume in the shape of a cube) and over the appropriate averaging time.			
The Spatial Peak value of the SAR averaged over any 10 grams of tissue (defined as a tissue volume in the shape of a cube) and over the appropriate averaging time.			
Uncontrolled environments are defined as locations where there is potential exposure of individuals who have no knowledge or control of their potential exposure.			
Controlled environments are defined as locations where there is potential exposure of individuals who have knowledge of their potential exposure and can exercise control over their exposure.			



Applicant:	M/A-COM, Inc.	FCC ID:	OWDTR-0016-E	IC:	3636B-0016	Freq.:	378 - 430 MHz	
Model(s):	P7100 (UHF-L)	DUT Type:	Portable UHF-L PTT Radio Transceiver with Alkaline Battery Pack					
2008 Celltech Labs Inc.		This document is not to be reproduced in whole or in part without the prior written permission of Celltech Labs Inc.						Page 8 of 33

	<u>Date(s) of Evaluation</u> October 25-26, 2007	<u>Test Report Serial No.</u> 102507OWD-T868a-S90U	<u>Test Report Revision No.</u> Revision 1.0	 Certificate No. 2470.01
	<u>Test Report Issue Date</u> January 08, 2008	<u>Description of Test(s)</u> Specific Absorption Rate	<u>RF Exposure Category</u> Occupational (Controlled)	

9.0 ROBOT SYSTEM SPECIFICATIONS

<u>Specifications</u>	
Positioner	Stäubli Unimation Corp. Robot Model: RX60L
Repeatability	0.02 mm
No. of axis	6
<u>Data Acquisition Electronic (DAE) System</u>	
<u>Cell Controller</u>	
Processor	AMD Athlon XP 2400+
Clock Speed	2.0 GHz
Operating System	Windows XP Professional
<u>Data Converter</u>	
Features	Signal Amplifier, multiplexer, A/D converter, and control logic
Software	Measurement Software: DASY4, V4.7 Build 44 Postprocessing Software: SEMCAD, V1.8 Build 171
Connecting Lines	Optical downlink for data and status info.; Optical uplink for commands and clock
<u>DASY4 Measurement Server</u>	
Function	Real-time data evaluation for field measurements and surface detection
Hardware	PC/104 166MHz Pentium CPU; 32 MB chipdisk; 64 MB RAM
Connections	COM1, COM2, DAE, Robot, Ethernet, Service Interface
<u>E-Field Probe</u>	
Model	ET3DV6
Serial No.	1387
Construction	Triangular core fiber optic detection system
Frequency	10 MHz to 6 GHz
Linearity	±0.2 dB (30 MHz to 3 GHz)
<u>Phantom(s)</u>	
<u>Evaluation Phantom</u>	
Type:	Side Planar Phantom
Shell Material	Plexiglas
Bottom Thickness	2.0 mm ± 0.1 mm
Outer Dimensions	75.0 cm (L) x 22.5 cm (W) x 20.5 cm (H); Back Plane: 25.7 cm (H)
<u>Validation Phantom (≤ 450MHz)</u>	
Type	Planar Phantom
Shell Material	Plexiglas
Bottom Thickness	6.2 mm ± 0.1 mm
Outer Dimensions	86.0 cm (L) x 39.5 cm (W) x 21.8 cm (H)

Applicant:	M/A-COM, Inc.	FCC ID:	OWDTR-0016-E	IC:	3636B-0016	Freq.:	378 - 430 MHz	
Model(s):	P7100 (UHF-L)	DUT Type:	Portable UHF-L PTT Radio Transceiver with Alkaline Battery Pack					
2008 Celltech Labs Inc.		This document is not to be reproduced in whole or in part without the prior written permission of Celltech Labs Inc.						Page 9 of 33

	<u>Date(s) of Evaluation</u> October 25-26, 2007	<u>Test Report Serial No.</u> 102507OWD-T868a-S90U	<u>Test Report Revision No.</u> Revision 1.0	 Certificate No. 2470.01
	<u>Test Report Issue Date</u> January 08, 2008	<u>Description of Test(s)</u> Specific Absorption Rate	<u>RF Exposure Category</u> Occupational (Controlled)	

10.0 PROBE SPECIFICATION (ET3DV6)

<p>Construction: Symmetrical design with triangular core Built-in shielding against static charges PEEK enclosure material (resistant to organic solvents, glycol)</p> <p>Calibration: In air from 10 MHz to 2.5 GHz In brain simulating tissue at frequencies of 900 MHz and 1.8 GHz (accuracy $\pm 8\%$)</p> <p>Frequency: 10 MHz to > 6 GHz; Linearity: ± 0.2 dB (30 MHz to 3 GHz)</p> <p>Directivity: ± 0.2 dB in brain tissue (rotation around probe axis) ± 0.4 dB in brain tissue (rotation normal to probe axis)</p> <p>Dynamic Range: 5 μW/g to > 100 mW/g; Linearity: ± 0.2 dB</p> <p>Surface Detect: ± 0.2 mm repeatability in air and clear liquids over diffuse reflecting surfaces</p> <p>Dimensions: Overall length: 330 mm Tip length: 16 mm Body diameter: 12 mm Tip diameter: 6.8 mm Distance from probe tip to dipole centers: 2.7 mm</p> <p>Application: General dosimetry up to 3 GHz Compliance tests of mobile phone</p>	
ET3DV6 E-Field Probe	

11.0 SIDE PLANAR PHANTOM

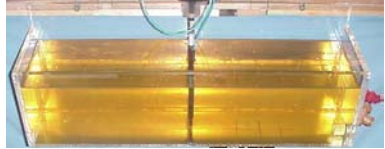
<p>The side planar phantom is constructed of Plexiglas material with a 2.0 mm shell thickness for face-held and body-worn SAR evaluations of portable radio transceivers. The side planar phantom is mounted on the side of the DASY4 compact system table.</p>	
Plexiglas Side Planar Phantom	

12.0 VALIDATION PLANAR PHANTOM

<p>The validation planar phantom is constructed of Plexiglas material with a 6.0 mm shell thickness for system validations at 450 MHz and below. The validation planar phantom is mounted to the table of the DASY4 compact system.</p>	
Plexiglas Validation Planar Phantom	



13.0 DEVICE HOLDER

<p>The DASY4 device holder has two scales for device rotation (with respect to the body axis) and the device inclination (with respect to the line between the ear openings). The plane between the ear openings and the mouth tip has a rotation angle of 65°. The bottom plate contains three pair of bolts for locking the device holder. The device holder positions are adjusted to the standard measurement positions in the three sections.</p>	
Device Holder	

Applicant: M/A-COM, Inc.	FCC ID: OWDTR-0016-E	IC: 3636B-0016	Freq.: 378 - 430 MHz	
Model(s): P7100 (UHF-L)	DUT Type: Portable UHF-L PTT Radio Transceiver with Alkaline Battery Pack			
2008 Celltech Labs Inc.	This document is not to be reproduced in whole or in part without the prior written permission of Celltech Labs Inc.			Page 10 of 33

14.0 TEST EQUIPMENT LIST



TEST EQUIPMENT		ASSET NO.	SERIAL NO.	DATE CALIBRATED		CALIBRATION DUE DATE	
USED	DESCRIPTION						
x	Schmid & Partner DASY4 System	-	-	-	-	-	
x	-DASY4 Measurement Server	00158	1078	N/A	N/A	N/A	
x	-Robot	00046	599396-01	N/A	N/A	N/A	
x	-DAE4	00019	353	10Jul07	10Jul08		
	-DAE3	00018	370	13Mar07	13Mar08		
x	-ET3DV6 E-Field Probe	00016	1387	16Mar07	16Mar08		
	-EX3DV4 E-Field Probe	00213	3600	24Jan07	24Jan08		
	-300 MHz Validation Dipole	00023	135	08Jun07	08Jun08		
x	-450 MHz Validation Dipole	00024	136	30Jul07	30Jul08		
	-835 MHz Validation Dipole	00022	411	Brain	07Jun07	07Jun08	
				Body	07Jun07	07Jun08	
	-900 MHz Validation Dipole	00020	054	Brain	07Jun07	07Jun08	
				Body	07Jun07	07Jun08	
	-1800 MHz Validation Dipole	00021	247	Brain	06Jun07	06Jun08	
				Body	06Jun07	06Jun08	
	-1900 MHz Validation Dipole	00032	151	Brain	06Jun07	06Jun08	
				Body	06Jun07	06Jun08	
	-2450 MHz Validation Dipole	00025	150	Brain	16Jul07	16Jul08	
				Body	08Jun07	08Jun08	
	5GHz Validation Dipole	00126	1031	Body	18May07	18May08	
				-5200 MHz	Body	22May07	22May08
				-5500 MHz	Brain	09May07	09May08
				-5800 MHz	Body	10May07	10May08
	-SAM Phantom V4.0C	00154	1033	N/A	N/A	N/A	
	-Barski Planar Phantom	00155	03-01	N/A	N/A	N/A	
x	-Plexiglas Side Planar Phantom	00156	161	N/A	N/A	N/A	
x	-Plexiglas Validation Planar Phantom	00157	137	N/A	N/A	N/A	
	ALS-PR-DIEL Dielectric Probe Kit	00160	260-00953	N/A	N/A	N/A	
x	HP 85070C Dielectric Probe Kit	00033	US39240170	N/A	N/A	N/A	
x	Gigatronics 8652A Power Meter	00007	1835272	26Mar07	26Mar08		
	Gigatronics 8652A Power Meter	00008	1835267	22Jan07	22Jan08		
x	Gigatronics 80701A Power Sensor	00012	1834350	22Jan07	22Jan08		
x	Gigatronics 80701A Power Sensor	00014	1833699	22Jan07	22Jan08		
	Gigatronics 80701A Power Sensor	00109	1834366	26Mar07	26Mar08		
x	HP 8753ET Network Analyzer	00134	US39170292	20Apr07	20Apr08		
x	HP 8648D Signal Generator	00005	3847A00611	NCR	NCR		
	Rohde & Schwarz SMR20 Signal Generator	00006	100104	NCR	NCR		
x	Amplifier Research 5S1G4 Power Amplifier	00106	26235	NCR	NCR		
	Amplifier Research 10W1000C Power Amplifier	00041	27887	NCR	NCR		
	Nextec NB00383 Microwave Amplifier	00151	0535	NCR	NCR		
	HP E4408B Spectrum Analyzer	00015	US39240170	05Feb07	05Feb08		

	<u>Date(s) of Evaluation</u> October 25-26, 2007	<u>Test Report Serial No.</u> 102507OWD-T868a-S90U	<u>Test Report Revision No.</u> Revision 1.0	 Certificate No. 2470.01
	<u>Test Report Issue Date</u> January 08, 2008	<u>Description of Test(s)</u> Specific Absorption Rate	<u>RF Exposure Category</u> Occupational (Controlled)	

15.0 MEASUREMENT UNCERTAINTIES

UNCERTAINTY BUDGET FOR DEVICE EVALUATION						
Error Description	Uncertainty Value ±%	Probability Distribution	Divisor	ci 1g	Uncertainty Value ±% (1g)	V _i or V _{eff}
Measurement System						
Probe calibration (450 MHz)	8.0	Normal	1	1	8.0	∞
Axial isotropy of the probe	4.7	Rectangular	1.732050808	0.7	1.9	∞
Spherical isotropy of the probe	9.6	Rectangular	1.732050808	0.7	3.9	∞
Spatial resolution	0	Rectangular	1.732050808	1	0.0	∞
Boundary effects	8.2	Rectangular	1.732050808	1	4.7	∞
Probe linearity	4.7	Rectangular	1.732050808	1	2.7	∞
Detection limit	1	Rectangular	1.732050808	1	0.6	∞
Readout electronics	0.3	Normal	1	1	0.3	∞
Response time	0.8	Rectangular	1.732050808	1	0.5	∞
Integration time	2.6	Rectangular	1.732050808	1	1.5	∞
RF ambient conditions	3	Rectangular	1.732050808	1	1.7	∞
Mech. constraints of robot	0.4	Rectangular	1.732050808	1	0.2	∞
Probe positioning	2.9	Rectangular	1.732050808	1	1.7	∞
Extrapolation & integration	1	Rectangular	1.732050808	1	0.6	∞
Test Sample Related						
Device positioning	2.9	Normal	1	1	2.9	12
Device holder uncertainty	3.6	Normal	1	1	3.6	8
Power drift	5	Rectangular	1.732050808	1	2.9	∞
Phantom and Setup						
Phantom uncertainty	4	Rectangular	1.732050808	1	2.3	∞
Liquid conductivity (target)	5	Rectangular	1.732050808	0.64	1.8	∞
Liquid conductivity (measured)	0	Normal	1	0.64	0.0	∞
Liquid permittivity (target)	5	Rectangular	1.732050808	0.6	1.7	∞
Liquid permittivity (measured)	2.5	Normal	1	0.6	1.5	∞
Combined Standard Uncertainty					12.85	
Expanded Uncertainty (k=2)					25.71	
Measurement Uncertainty Table in accordance with IEEE Standard 1528-2003 (see reference [5])						



Applicant:	M/A-COM, Inc.	FCC ID:	OWDTR-0016-E	IC:	3636B-0016	Freq.:	378 - 430 MHz		
Model(s):	P7100 (UHF-L)	DUT Type:	Portable UHF-L PTT Radio Transceiver with Alkaline Battery Pack						
2008 Celltech Labs Inc.		This document is not to be reproduced in whole or in part without the prior written permission of Celltech Labs Inc.					Page 12 of 33		

	<u>Date(s) of Evaluation</u> October 25-26, 2007	<u>Test Report Serial No.</u> 102507OWD-T868a-S90U	<u>Test Report Revision No.</u> Revision 1.0	 Certificate No. 2470.01
	<u>Test Report Issue Date</u> January 08, 2008	<u>Description of Test(s)</u> Specific Absorption Rate	<u>RF Exposure Category</u> Occupational (Controlled)	

MEASUREMENT UNCERTAINTIES (Cont.)

UNCERTAINTY BUDGET FOR SYSTEM VALIDATION						
Error Description	Uncertainty Value ±%	Probability Distribution	Divisor	ci 1g	Uncertainty Value ±% (1g)	V _i or V _{eff}
Measurement System						
Probe calibration (450 MHz)	8	Normal	1	1	8.0	∞
Axial isotropy of the probe	4.7	Rectangular	1.732050808	1	2.7	∞
Spherical isotropy of the probe	0	Rectangular	1.732050808	1	0.0	∞
Spatial resolution	0	Rectangular	1.732050808	1	0.0	∞
Boundary effects	8.2	Rectangular	1.732050808	1	4.7	∞
Probe linearity	4.7	Rectangular	1.732050808	1	2.7	∞
Detection limit	1	Rectangular	1.732050808	1	0.6	∞
Readout electronics	0.3	Normal	1	1	0.3	∞
Response time	0	Rectangular	1.732050808	1	0.0	∞
Integration time	0	Rectangular	1.732050808	1	0.0	∞
RF ambient conditions	3	Rectangular	1.732050808	1	1.7	∞
Mech. constraints of robot	0.4	Rectangular	1.732050808	1	0.2	∞
Probe positioning	2.9	Rectangular	1.732050808	1	1.7	∞
Extrapolation & integration	1	Rectangular	1.732050808	1	0.6	∞
Dipole						
Dipole Positioning	2	Normal	1.732050808	1	1.2	∞
Power & Power Drift	4.7	Normal	1.732050808	1	2.7	∞
Phantom and Setup						
Phantom uncertainty	4	Rectangular	1.732050808	1	2.3	∞
Liquid conductivity (target)	5	Rectangular	1.732050808	0.64	1.8	∞
Liquid conductivity (measured)	2.4	Normal	1	0.64	1.5	∞
Liquid permittivity (target)	5	Rectangular	1.732050808	0.6	1.7	∞
Liquid permittivity (measured)	1.7	Normal	1	0.6	1.0	∞
Combined Standard Uncertainty					11.47	
Expanded Uncertainty (k=2)					22.94	
Measurement Uncertainty Table in accordance with IEEE Standard 1528-2003 (see reference [5])						



Applicant:	M/A-COM, Inc.	FCC ID:	OWDTR-0016-E	IC:	3636B-0016	Freq.:	378 - 430 MHz		
Model(s):	P7100 (UHF-L)	DUT Type:	Portable UHF-L PTT Radio Transceiver with Alkaline Battery Pack						
2008 Celltech Labs Inc.		This document is not to be reproduced in whole or in part without the prior written permission of Celltech Labs Inc.					Page 13 of 33		

	<u>Date(s) of Evaluation</u> October 25-26, 2007	<u>Test Report Serial No.</u> 102507OWD-T868a-S90U	<u>Test Report Revision No.</u> Revision 1.0	 Certificate No. 2470.01
	<u>Test Report Issue Date</u> January 08, 2008	<u>Description of Test(s)</u> Specific Absorption Rate	<u>RF Exposure Category</u> Occupational (Controlled)	

16.0 REFERENCES



- [1] Federal Communications Commission - "Radiofrequency radiation exposure evaluation: portable devices", Rule Part 47 CFR §2.1093: 1999.
- [2] Health Canada - "Limits of Human Exposure to Radiofrequency Electromagnetic Fields in the Frequency Range from 3 kHz to 300 GHz", Safety Code 6: 1999.
- [3] Federal Communications Commission - "Evaluating Compliance with FCC Guidelines for Human Exposure to Radio frequency Electromagnetic Fields", OET Bulletin 65, Supplement C (Edition 01-01), FCC, Washington, D.C.: June 2001.
- [4] Industry Canada - "Radio Frequency Exposure Compliance of Radiocommunication Apparatus (All Frequency Bands)", Radio Standards Specification RSS-102 Issue 2: November 2005.
- [5] IEEE Standard 1528-2003 - "Recommended Practice for Determining the Peak Spatial-Average Specific Absorption Rate (SAR) in the Human Head from Wireless Communications Devices: Measurement Techniques": December 2003.

Applicant:	M/A-COM, Inc.	FCC ID:	OWDTR-0016-E	IC:	3636B-0016	Freq.:	378 - 430 MHz	
Model(s):	P7100 (UHF-L)	DUT Type:	Portable UHF-L PTT Radio Transceiver with Alkaline Battery Pack					
2008 Celltech Labs Inc.		This document is not to be reproduced in whole or in part without the prior written permission of Celltech Labs Inc.						Page 14 of 33

	<u>Date(s) of Evaluation</u> October 25-26, 2007	<u>Test Report Serial No.</u> 102507OWD-T868a-S90U	<u>Test Report Revision No.</u> Revision 1.0	 Certificate No. 2470.01
	<u>Test Report Issue Date</u> January 08, 2008	<u>Description of Test(s)</u> Specific Absorption Rate	<u>RF Exposure Category</u> Occupational (Controlled)	

APPENDIX A - SAR MEASUREMENT DATA

Applicant:	M/A-COM, Inc.	FCC ID:	OWDTR-0016-E	IC:	3636B-0016	Freq.:	378 - 430 MHz	
Model(s):	P7100 (UHF-L)	DUT Type:	Portable UHF-L PTT Radio Transceiver with Alkaline Battery Pack					
2008 Celltech Labs Inc.	This document is not to be reproduced in whole or in part without the prior written permission of Celltech Labs Inc.							Page 15 of 33

	<u>Date(s) of Evaluation</u> October 25-26, 2007	<u>Test Report Serial No.</u> 102507OWD-T868a-S90U	<u>Test Report Revision No.</u> Revision 1.0	 Certificate No. 2470.01
	<u>Test Report Issue Date</u> January 08, 2008	<u>Description of Test(s)</u> Specific Absorption Rate	<u>RF Exposure Category</u> Occupational (Controlled)	

Date Tested: 10/25/2007

Face-Held SAR - P7100 (UHF-L) Radio - Helical Coil Antenna (P/N: KRE1011219/10) - 403 MHz

DUT: M/A-COM Model: P7100 (UHF-L); Type: Portable FM UHF-L PTT Radio Transceiver; Serial: T1-L SAR02

Ambient Temp: 22.9°C; Fluid Temp: 22.8°C; Barometric Pressure: 100.4 kPa; Humidity: 31%

Communication System: FM (CW)
 Frequency: 403 MHz; Duty Cycle: 1:1
 RF Output Power: 4.28 Watts (Conducted)
 9V AA Alkaline Battery Pack (Battery Case P/N: BT-013259-001)
 Medium: HSL450 Medium parameters used: $f = 403 \text{ MHz}$; $\sigma = 0.87 \text{ mho/m}$; $\epsilon_r = 43.8$; $\rho = 1000 \text{ kg/m}^3$

- Probe: ET3DV6 - SN1387; ConvF(7, 7, 7); Calibrated: 16/03/2007
- Sensor-Surface: 4 mm (Mechanical Surface Detection)
- Electronics: DAE4 Sn353; Calibrated: 10/07/2007
- Phantom: Side Planar; Type: Plexiglas; Serial: 161
- Measurement SW: DASY4, V4.7 Build 44; Postprocessing SW: SEMCAD, V1.8 Build 171

Face-Held SAR - 2.5 cm Spacing from Front of DUT to Planar Phantom - Mid Channel - 403 MHz



Area Scan (8x25x1): Measurement grid: dx=15mm, dy=15mm
 Maximum value of SAR (measured) = 3.41 mW/g

Face-Held SAR - 2.5 cm Spacing from Front of DUT to Planar Phantom - Mid Channel - 403 MHz

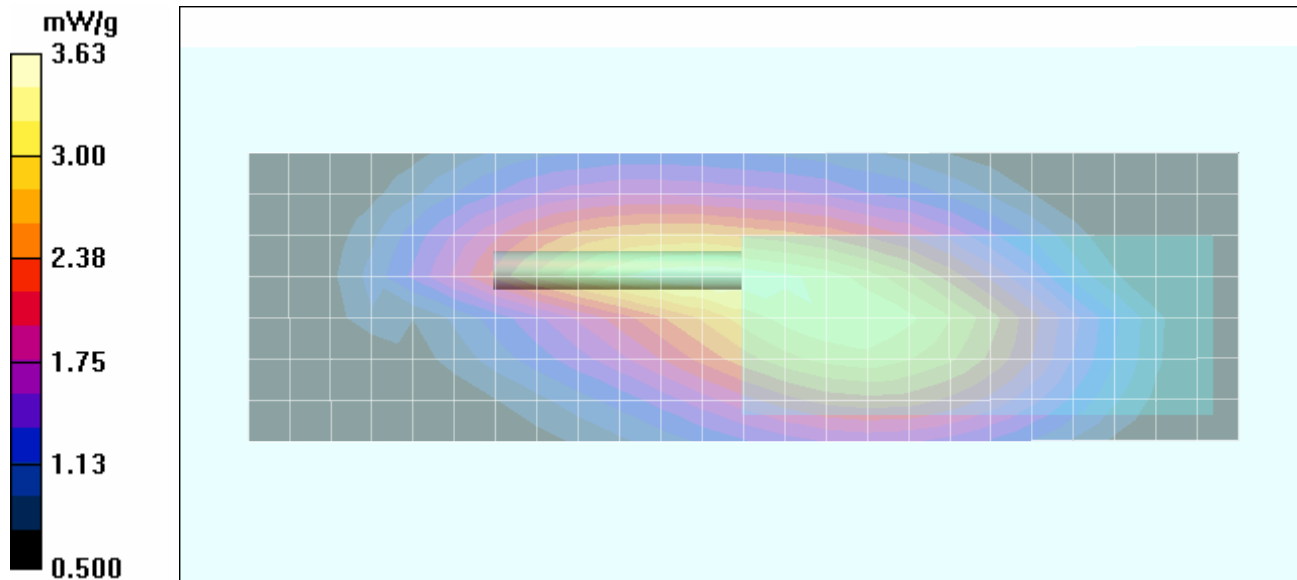
Zoom Scan (5x5x7)/Cube 0: Measurement grid: dx=7.5mm, dy=7.5mm, dz=5mm
 Reference Value = 64.1 V/m; Power Drift = -0.028 dB
 Peak SAR (extrapolated) = 5.39 W/kg
SAR(1 g) = 3.48 mW/g; SAR(10 g) = 2.45 mW/g
 Maximum value of SAR (measured) = 3.63 mW/g





Applicant:	M/A-COM, Inc.	FCC ID:	OWDTR-0016-E	IC:	3636B-0016	Freq.:	378 - 430 MHz	
Model(s):	P7100 (UHF-L)	DUT Type:	Portable UHF-L PTT Radio Transceiver with Alkaline Battery Pack					
2008 Celltech Labs Inc.		This document is not to be reproduced in whole or in part without the prior written permission of Celltech Labs Inc.						Page 16 of 33

	<u>Date(s) of Evaluation</u> October 25-26, 2007	<u>Test Report Serial No.</u> 102507OWD-T868a-S90U	<u>Test Report Revision No.</u> Revision 1.0	  Certificate No. 2470.01
	<u>Test Report Issue Date</u> January 08, 2008	<u>Description of Test(s)</u> Specific Absorption Rate	<u>RF Exposure Category</u> Occupational (Controlled)	

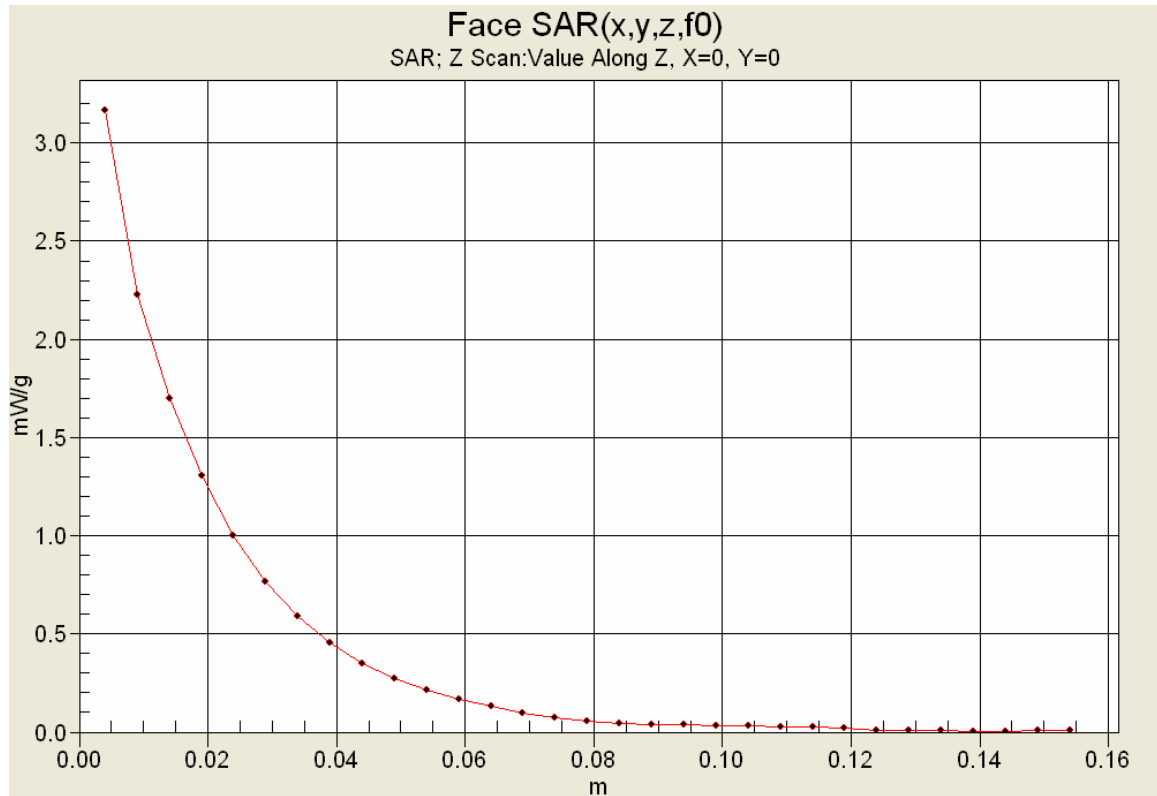
Z-Axis Scan



Applicant:	M/A-COM, Inc.	FCC ID:	OWDTR-0016-E	IC:	3636B-0016	Freq.:	378 - 430 MHz	
Model(s):	P7100 (UHF-L)	DUT Type:	Portable UHF-L PTT Radio Transceiver with Alkaline Battery Pack					
2008 Celltech Labs Inc.		This document is not to be reproduced in whole or in part without the prior written permission of Celltech Labs Inc.						Page 17 of 33

	<u>Date(s) of Evaluation</u> October 25-26, 2007	<u>Test Report Serial No.</u> 102507OWD-T868a-S90U	<u>Test Report Revision No.</u> Revision 1.0	 Certificate No. 2470.01
	<u>Test Report Issue Date</u> January 08, 2008	<u>Description of Test(s)</u> Specific Absorption Rate	<u>RF Exposure Category</u> Occupational (Controlled)	

Date Tested: 10/26/2007

Body-Worn SAR - P7100 (UHF-L) Radio - ¼-Wave Whip Antenna (P/N: KRE1011223/10) - 403 MHz

DUT: M/A-COM Model: P7100 (UHF-L); Type: Portable FM UHF-L PTT Radio Transceiver; Serial: T1-L SAR02

Body-Worn Accessory: Metal Belt-Clip (P/N: CC23894)

Audio Accessory: Speaker-Microphone (P/N: KRY1011617/183)

Ambient Temp: 23.0°C; Fluid Temp: 22.8°C; Barometric Pressure: 100.4 kPa; Humidity: 32%

Communication System: FM (CW)

Frequency: 403 MHz; Duty Cycle: 1:1

RF Output Power: 4.28 Watts (Conducted)

9V AA Alkaline Battery Pack (Battery Case P/N: BT-013259-001)

Medium: M450 Medium parameters used: $f = 403 \text{ MHz}$; $\sigma = 0.94 \text{ mho/m}$; $\epsilon_r = 58.1$; $\rho = 1000 \text{ kg/m}^3$

- Probe: ET3DV6 - SN1387; ConvF(6.9, 6.9, 6.9); Calibrated: 16/03/2007
- Sensor-Surface: 4 mm (Mechanical Surface Detection)
- Electronics: DAE4 Sn353; Calibrated: 10/07/2007
- Phantom: Side Planar; Type: Plexiglas; Serial: 161
- Measurement SW: DASY4, V4.7 Build 44; Postprocessing SW: SEMCAD, V1.8 Build 171

Body-Worn SAR - 1.1 cm Belt-Clip Spacing from Back of DUT to Planar Phantom - Mid Channel - 403 MHz

Area Scan (8x26x1): Measurement grid: $dx=15\text{mm}$, $dy=15\text{mm}$

Maximum value of SAR (measured) = 12.2 mW/g

Body-Worn SAR - 1.1 cm Belt-Clip Spacing from Back of DUT to Planar Phantom - Mid Channel - 403 MHz

Zoom Scan (5x5x7)/Cube 0: Measurement grid: $dx=7.5\text{mm}$, $dy=7.5\text{mm}$, $dz=5\text{mm}$

Reference Value = 113.1 V/m; Power Drift = -0.0310 dB



Peak SAR (extrapolated) = 22.2 W/kg

SAR(1 g) = 12.2 mW/g; SAR(10 g) = 8.2 mW/g

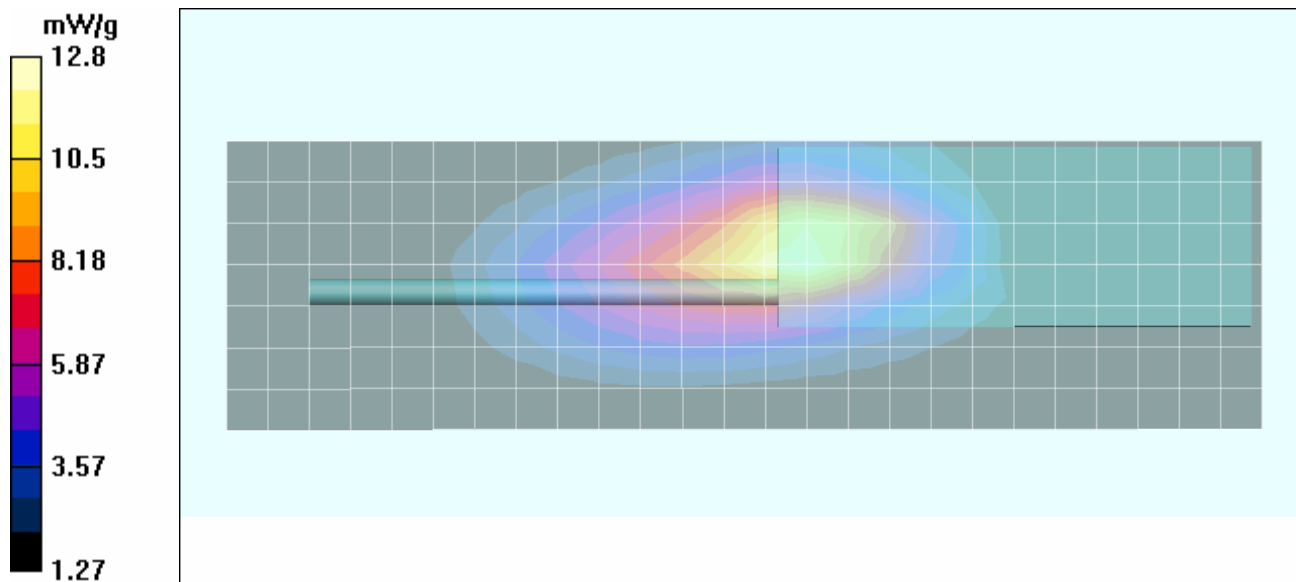
Maximum value of SAR (measured) = 12.8 mW/g





Applicant:	M/A-COM, Inc.	FCC ID:	OWDTR-0016-E	IC:	3636B-0016	Freq.:	378 - 430 MHz	
Model(s):	P7100 (UHF-L)	DUT Type:	Portable UHF-L PTT Radio Transceiver with Alkaline Battery Pack					
2008 Celltech Labs Inc.		This document is not to be reproduced in whole or in part without the prior written permission of Celltech Labs Inc.						Page 18 of 33

	<u>Date(s) of Evaluation</u> October 25-26, 2007	<u>Test Report Serial No.</u> 102507OWD-T868a-S90U	<u>Test Report Revision No.</u> Revision 1.0	 Certificate No. 2470.01
	<u>Test Report Issue Date</u> January 08, 2008	<u>Description of Test(s)</u> Specific Absorption Rate	<u>RF Exposure Category</u> Occupational (Controlled)	

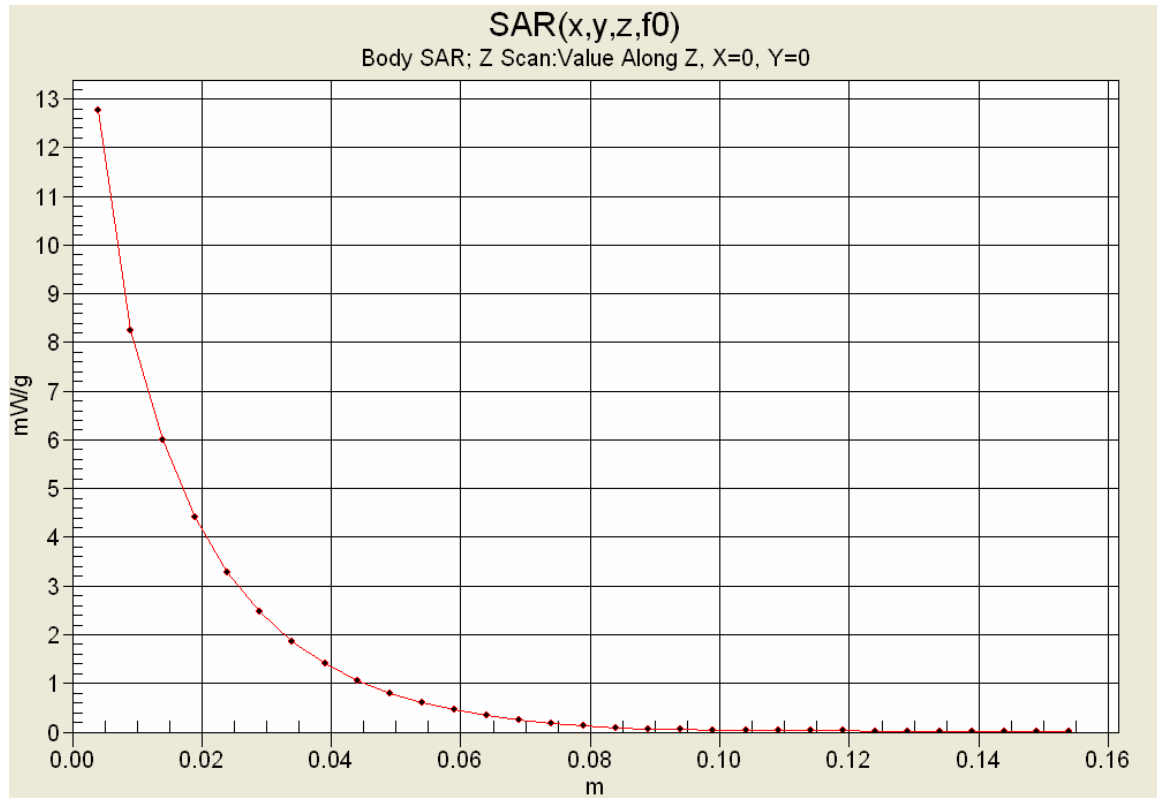
Z-Axis Scan





Applicant:	M/A-COM, Inc.	FCC ID:	OWDTR-0016-E	IC:	3636B-0016	Freq.:	378 - 430 MHz	
Model(s):	P7100 (UHF-L)	DUT Type:	Portable UHF-L PTT Radio Transceiver with Alkaline Battery Pack					
2008 Celltech Labs Inc.		This document is not to be reproduced in whole or in part without the prior written permission of Celltech Labs Inc.						Page 19 of 33

	<u>Date(s) of Evaluation</u> October 25-26, 2007	<u>Test Report Serial No.</u> 102507OWD-T868a-S90U	<u>Test Report Revision No.</u> Revision 1.0	 Certificate No. 2470.01
	<u>Test Report Issue Date</u> January 08, 2008	<u>Description of Test(s)</u> Specific Absorption Rate	<u>RF Exposure Category</u> Occupational (Controlled)	

APPENDIX B - SYSTEM PERFORMANCE CHECK DATA

Applicant:	M/A-COM, Inc.	FCC ID:	OWDTR-0016-E	IC:	3636B-0016	Freq.:	378 - 430 MHz	
Model(s):	P7100 (UHF-L)	DUT Type:	Portable UHF-L PTT Radio Transceiver with Alkaline Battery Pack					
2008 Celltech Labs Inc.	This document is not to be reproduced in whole or in part without the prior written permission of Celltech Labs Inc.							Page 20 of 33

	<u>Date(s) of Evaluation</u> October 25-26, 2007	<u>Test Report Serial No.</u> 102507OWD-T868a-S90U	<u>Test Report Revision No.</u> Revision 1.0	 Certificate No. 2470.01
	<u>Test Report Issue Date</u> January 08, 2008	<u>Description of Test(s)</u> Specific Absorption Rate	<u>RF Exposure Category</u> Occupational (Controlled)	

Date Tested: 10/25/2007

System Performance Check - 450 MHz Dipole - HSL

DUT: Dipole 450 MHz; Asset: 00024; Serial: 136; Validation: 07/30/2007

Ambient Temp: 22.9°C; Fluid Temp: 22.8°C; Barometric Pressure: 100.4 kPa; Humidity: 31%

Communication System: CW

Forward Conducted Power: 250 mW

Frequency: 450 MHz; Duty Cycle: 1:1

Medium: HSL450 Medium parameters used: $f = 450 \text{ MHz}$; $\sigma = 0.87 \text{ mho/m}$; $\epsilon_r = 43.8$; $\rho = 1000 \text{ kg/m}^3$

- Probe: ET3DV6 - SN1387; ConvF(7, 7, 7); Calibrated: 16/03/2007
- Sensor-Surface: 4 mm (Mechanical Surface Detection)
- Electronics: DAE4 Sn353; Calibrated: 10/07/2007
- Phantom: Validation Planar; Type: Plexiglas; Serial: 137
- Measurement SW: DASY4, V4.7 Build 44; Postprocessing SW: SEMCAD, V1.8 Build 171

450 MHz Dipole - System Performance Check/Area Scan (6x11x1):

Measurement grid: $dx=15\text{mm}$, $dy=15\text{mm}$

Maximum value of SAR (measured) = 1.29 mW/g

450 MHz Dipole - System Performance Check/Zoom Scan (5x5x7)/Cube 0:

Measurement grid: $dx=7.5\text{mm}$, $dy=7.5\text{mm}$, $dz=5\text{mm}$

Reference Value = 39.9 V/m; Power Drift = -0.029 dB



Peak SAR (extrapolated) = 2.32 W/kg

SAR(1 g) = 1.32 mW/g; SAR(10 g) = 0.847 mW/g

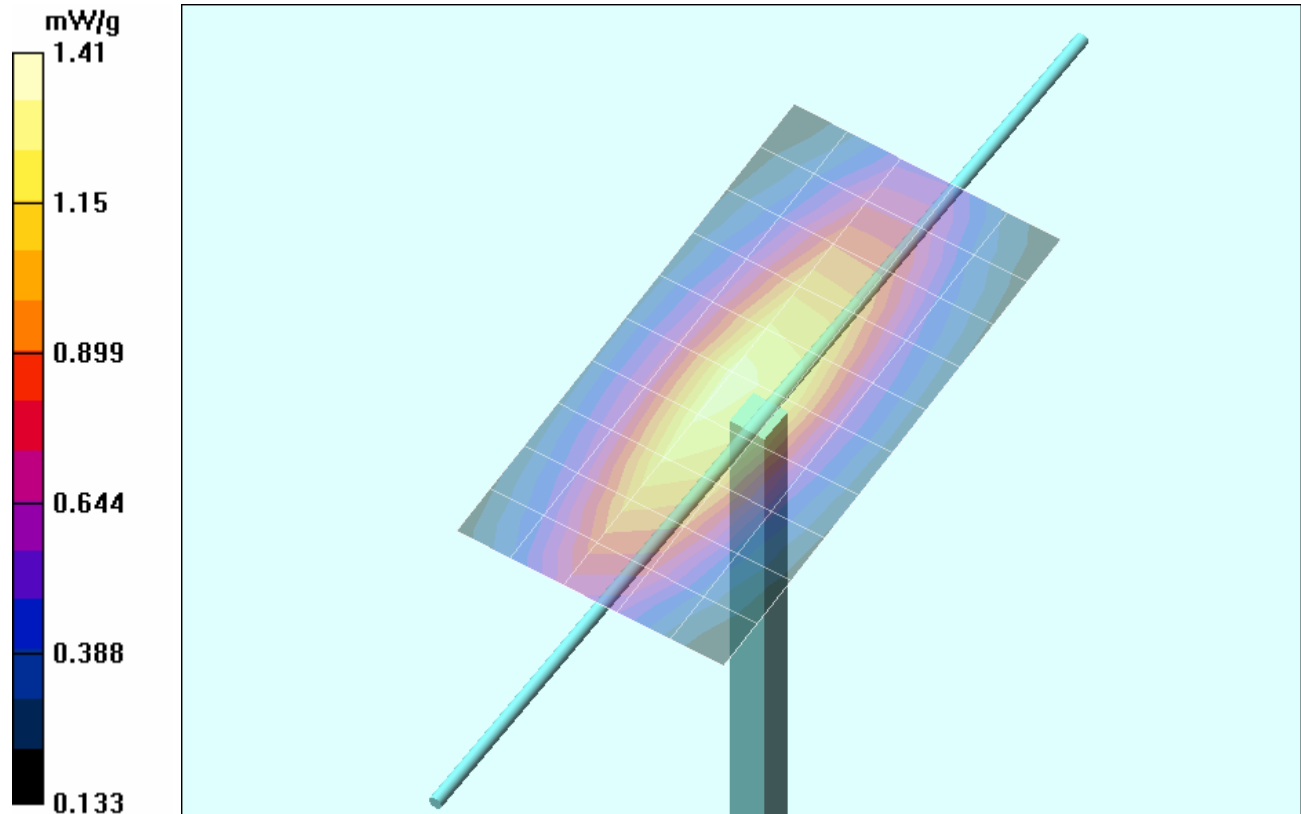
Maximum value of SAR (measured) = 1.41 mW/g





Applicant:	M/A-COM, Inc.	FCC ID:	OWDTR-0016-E	IC:	3636B-0016	Freq.:	378 - 430 MHz	
Model(s):	P7100 (UHF-L)	DUT Type:	Portable UHF-L PTT Radio Transceiver with Alkaline Battery Pack					
2008 Celltech Labs Inc.		This document is not to be reproduced in whole or in part without the prior written permission of Celltech Labs Inc.						Page 21 of 33

	<u>Date(s) of Evaluation</u> October 25-26, 2007	<u>Test Report Serial No.</u> 102507OWD-T868a-S90U	<u>Test Report Revision No.</u> Revision 1.0	  Certificate No. 2470.01
	<u>Test Report Issue Date</u> January 08, 2008	<u>Description of Test(s)</u> Specific Absorption Rate	<u>RF Exposure Category</u> Occupational (Controlled)	

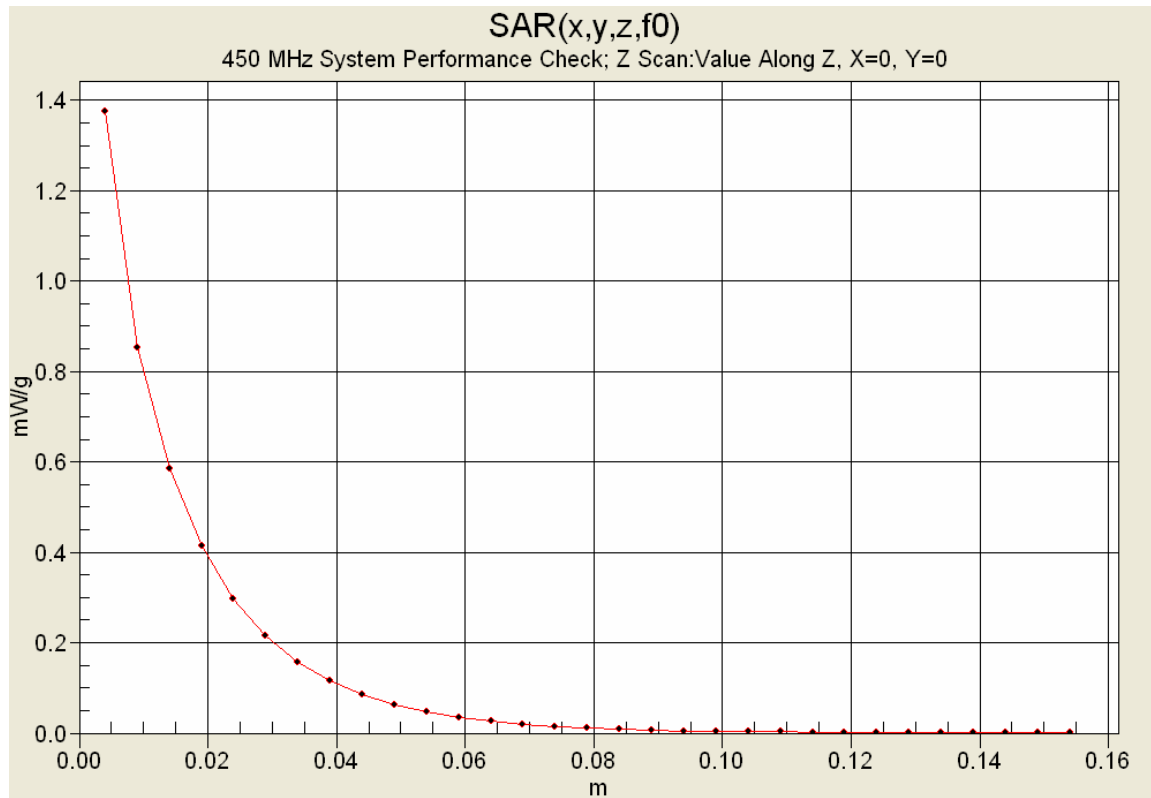
Z-Axis Scan





Applicant:	M/A-COM, Inc.	FCC ID:	OWDTR-0016-E	IC:	3636B-0016	Freq.:	378 - 430 MHz	
Model(s):	P7100 (UHF-L)	DUT Type:	Portable UHF-L PTT Radio Transceiver with Alkaline Battery Pack					
2008 Celltech Labs Inc.		This document is not to be reproduced in whole or in part without the prior written permission of Celltech Labs Inc.						Page 22 of 33

	<u>Date(s) of Evaluation</u> October 25-26, 2007	<u>Test Report Serial No.</u> 102507OWD-T868a-S90U	<u>Test Report Revision No.</u> Revision 1.0	 Certificate No. 2470.01
	<u>Test Report Issue Date</u> January 08, 2008	<u>Description of Test(s)</u> Specific Absorption Rate	<u>RF Exposure Category</u> Occupational (Controlled)	

APPENDIX C - MEASURED FLUID DIELECTRIC PARAMETERS

Applicant:	M/A-COM, Inc.	FCC ID:	OWDTR-0016-E	IC:	3636B-0016	Freq.:	378 - 430 MHz	
Model(s):	P7100 (UHF-L)	DUT Type:	Portable UHF-L PTT Radio Transceiver with Alkaline Battery Pack					
2008 Celltech Labs Inc.	This document is not to be reproduced in whole or in part without the prior written permission of Celltech Labs Inc.							Page 23 of 33



	<u>Date(s) of Evaluation</u> October 25-26, 2007	<u>Test Report Serial No.</u> 102507OWD-T868a-S90U	<u>Test Report Revision No.</u> Revision 1.0	 Certificate No. 2470.01
	<u>Test Report Issue Date</u> January 08, 2008	<u>Description of Test(s)</u> Specific Absorption Rate	<u>RF Exposure Category</u> Occupational (Controlled)	

450 MHz System Performance Check & DUT Evaluation (Brain)

Celltech Labs Inc.
 Test Result for UIM Dielectric Parameter
 Thu 25/Oct/2007
 Frequency (GHz)
 FCC_eHFCC OET 65 Supplement C (June 2001) Limits for Head Epsilon
 FCC_sHFCC OET 65 Supplement C (June 2001) Limits for Head Sigma
 Test_e Epsilon of UIM
 Test_s Sigma of UIM

Freq	FCC_eHFCC_sH	Test_e	Test_s
0.3000	45.30 0.87	47.89	0.75
0.3100	45.18 0.87	47.36	0.75
0.3200	45.06 0.87	47.23	0.77
0.3300	44.94 0.87	46.70	0.77
0.3400	44.82 0.87	46.54	0.78
0.3500	44.70 0.87	46.17	0.79
0.3600	44.58 0.87	46.08	0.80
0.3700	44.46 0.87	45.59	0.81
0.3800	44.34 0.87	45.26	0.81
0.3900	44.22 0.87	45.30	0.82
0.4000	44.10 0.87	44.99	0.83
0.4100	43.98 0.87	44.69	0.84
0.4200	43.86 0.87	44.57	0.85
0.4300	43.74 0.87	44.40	0.86
0.4400	43.62 0.87	44.15	0.87
0.4500	43.50 0.87	43.79	0.87
0.4600	43.45 0.87	43.66	0.88
0.4700	43.40 0.87	43.33	0.89
0.4800	43.34 0.87	43.04	0.89
0.4900	43.29 0.87	42.95	0.91
0.5000	43.24 0.87	42.79	0.91

Applicant:	M/A-COM, Inc.	FCC ID:	OWDTR-0016-E	IC:	3636B-0016	Freq.:	378 - 430 MHz	
Model(s):	P7100 (UHF-L)	DUT Type:	Portable UHF-L PTT Radio Transceiver with Alkaline Battery Pack					
2008 Celltech Labs Inc.		This document is not to be reproduced in whole or in part without the prior written permission of Celltech Labs Inc.						Page 24 of 33



	<u>Date(s) of Evaluation</u> October 25-26, 2007	<u>Test Report Serial No.</u> 102507OWD-T868a-S90U	<u>Test Report Revision No.</u> Revision 1.0	 Certificate No. 2470.01
	<u>Test Report Issue Date</u> January 08, 2008	<u>Description of Test(s)</u> Specific Absorption Rate	<u>RF Exposure Category</u> Occupational (Controlled)	

450 MHz DUT Evaluation (Body)

Celltech Labs Inc.
Test Result for UIM Dielectric Parameter
Fri 26/Oct/2007
Frequency (GHz)
FCC_eH FCC Bulletin 65 Supplement C (June 2001) Limits for Head Epsilon
FCC_sH FCC Bulletin 65 Supplement C (June 2001) Limits for Head Sigma
FCC_eB FCC Limits for Body Epsilon
FCC_sB FCC Limits for Body Sigma
Test_e Epsilon of UIM
Test_s Sigma of UIM



Freq	FCC_eB	FCC_sB	Test_e	Test_s
0.3000	58.20	0.92	60.52	0.84
0.3100	58.10	0.92	59.81	0.84
0.3200	58.00	0.92	59.98	0.85
0.3300	57.90	0.92	59.63	0.85
0.3400	57.80	0.93	59.51	0.86
0.3500	57.70	0.93	59.58	0.87
0.3600	57.60	0.93	59.51	0.87
0.3700	57.50	0.93	59.24	0.88
0.3800	57.40	0.93	58.83	0.89
0.3900	57.30	0.93	59.22	0.90
0.4000	57.20	0.93	58.85	0.90
0.4100	57.10	0.93	58.78	0.91
0.4200	57.00	0.94	58.68	0.92
0.4300	56.90	0.94	58.55	0.93
0.4400	56.80	0.94	58.34	0.93
0.4500	56.70	0.94	58.13	0.94
0.4600	56.66	0.94	58.20	0.94
0.4700	56.62	0.94	58.12	0.96
0.4800	56.58	0.94	57.97	0.96
0.4900	56.54	0.94	57.97	0.97
0.5000	56.51	0.94	57.84	0.98

Applicant:	M/A-COM, Inc.	FCC ID:	OWDTR-0016-E	IC:	3636B-0016	Freq.:	378 - 430 MHz	
Model(s):	P7100 (UHF-L)	DUT Type:	Portable UHF-L PTT Radio Transceiver with Alkaline Battery Pack					
2008 Celltech Labs Inc.		This document is not to be reproduced in whole or in part without the prior written permission of Celltech Labs Inc.						Page 25 of 33

	<u>Date(s) of Evaluation</u> October 25-26, 2007	<u>Test Report Serial No.</u> 102507OWD-T868a-S90U	<u>Test Report Revision No.</u> Revision 1.0	 Certificate No. 2470.01
	<u>Test Report Issue Date</u> January 08, 2008	<u>Description of Test(s)</u> Specific Absorption Rate	<u>RF Exposure Category</u> Occupational (Controlled)	

APPENDIX D - SAR TEST SETUP & DUT PHOTOGRAPHS

Applicant:	M/A-COM, Inc.	FCC ID:	OWDTR-0016-E	IC:	3636B-0016	Freq.:	378 - 430 MHz	
Model(s):	P7100 (UHF-L)	DUT Type:	Portable UHF-L PTT Radio Transceiver with Alkaline Battery Pack					
2008 Celltech Labs Inc.		This document is not to be reproduced in whole or in part without the prior written permission of Celltech Labs Inc.						Page 26 of 33

	<u>Date(s) of Evaluation</u> October 25-26, 2007	<u>Test Report Serial No.</u> 102507OWD-T868a-S90U	<u>Test Report Revision No.</u> Revision 1.0	 Certificate No. 2470.01
	<u>Test Report Issue Date</u> January 08, 2008	<u>Description of Test(s)</u> Specific Absorption Rate	<u>RF Exposure Category</u> Occupational (Controlled)	

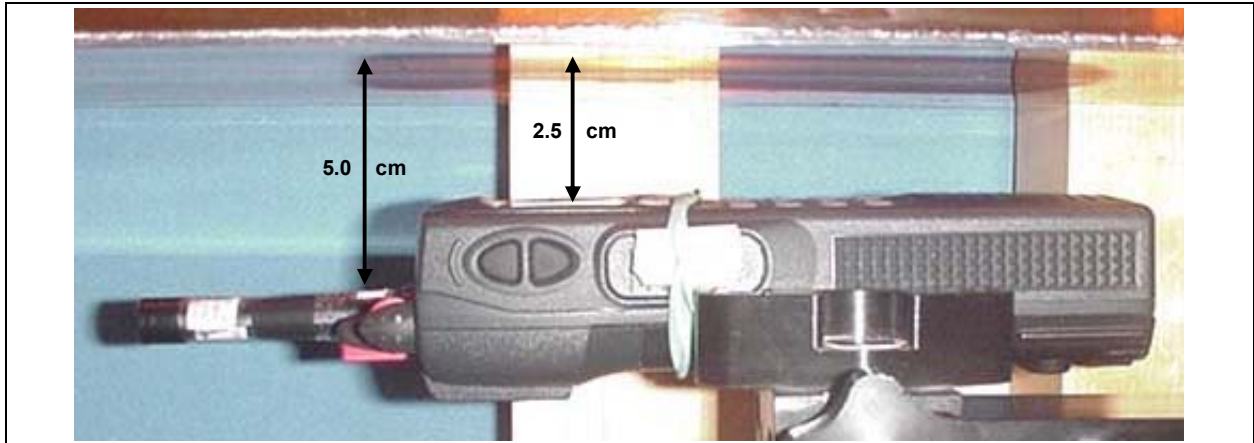

SAR TEST SETUP PHOTOGRAPHS

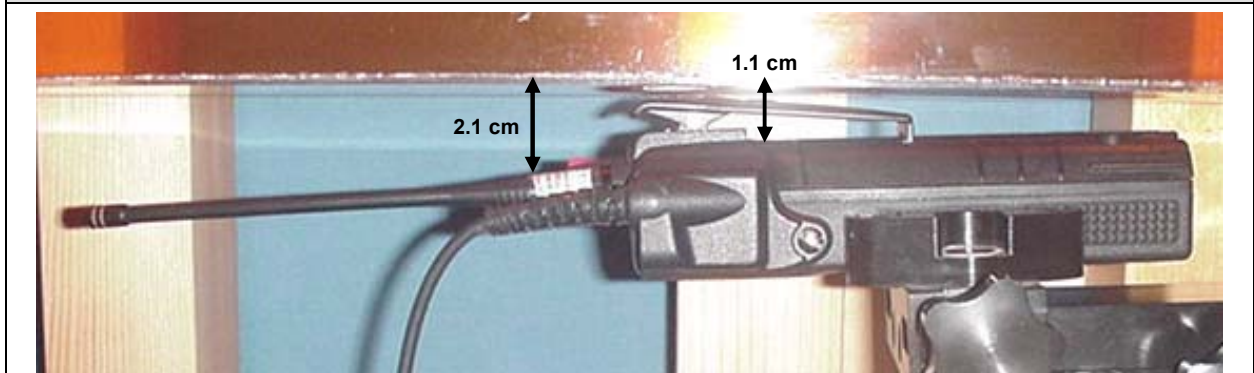

DUT with Helical Coil Antenna (P/N: KRE1011219/10) - 2.5 cm Spacing from Front of DUT to Planar Phantom



DUT with 1/4-Wave Whip Antenna (P/N: KRE1011223/10) - 1.1 cm Belt-Clip Spacing from Back of DUT to Planar Phantom

	<u>Date(s) of Evaluation</u> October 25-26, 2007	<u>Test Report Serial No.</u> 102507OWD-T868a-S90U	<u>Test Report Revision No.</u> Revision 1.0	 Certificate No. 2470.01
	<u>Test Report Issue Date</u> January 08, 2008	<u>Description of Test(s)</u> Specific Absorption Rate	<u>RF Exposure Category</u> Occupational (Controlled)	

DUT PHOTOGRAPHS



Front of DUT





Back of DUT with Alkaline Battery Pack



DUT Battery Compartment

Applicant:	M/A-COM, Inc.	FCC ID:	OWDTR-0016-E	IC:	3636B-0016	Freq.:	378 - 430 MHz	
Model(s):	P7100 (UHF-L)	DUT Type:	Portable UHF-L PTT Radio Transceiver with Alkaline Battery Pack					
2008 Celltech Labs Inc.		This document is not to be reproduced in whole or in part without the prior written permission of Celltech Labs Inc.						Page 28 of 33

	<u>Date(s) of Evaluation</u> October 25-26, 2007	<u>Test Report Serial No.</u> 102507OWD-T868a-S90U	<u>Test Report Revision No.</u> Revision 1.0	 Certificate No. 2470.01
	<u>Test Report Issue Date</u> January 08, 2008	<u>Description of Test(s)</u> Specific Absorption Rate	<u>RF Exposure Category</u> Occupational (Controlled)	

DUT PHOTOGRAPHS



Left Side of DUT with Alkaline Battery Pack





Right Side of DUT with Alkaline Battery Pack





Bottom end of DUT with Alkaline Battery Pack

Applicant:	M/A-COM, Inc.	FCC ID:	OWDTR-0016-E	IC:	3636B-0016	Freq.:	378 - 430 MHz	
Model(s):	P7100 (UHF-L)	DUT Type:	Portable UHF-L PTT Radio Transceiver with Alkaline Battery Pack					
2008 Celltech Labs Inc.		This document is not to be reproduced in whole or in part without the prior written permission of Celltech Labs Inc.						Page 29 of 33

	<u>Date(s) of Evaluation</u> October 25-26, 2007	<u>Test Report Serial No.</u> 102507OWD-T868a-S90U	<u>Test Report Revision No.</u> Revision 1.0	 Certificate No. 2470.01
	<u>Test Report Issue Date</u> January 08, 2008	<u>Description of Test(s)</u> Specific Absorption Rate	<u>RF Exposure Category</u> Occupational (Controlled)	

DUT PHOTOGRAPHS



		
DUT with Alkaline Battery Pack & Metal Belt-Clip (P/N: CC23894)	Front of Metal Belt-Clip (P/N: CC23894)	Back of Metal Belt-Clip (P/N: CC23894)

	<u>Date(s) of Evaluation</u> October 25-26, 2007	<u>Test Report Serial No.</u> 102507OWD-T868a-S90U	<u>Test Report Revision No.</u> Revision 1.0	
	<u>Test Report Issue Date</u> January 08, 2008	<u>Description of Test(s)</u> Specific Absorption Rate	<u>RF Exposure Category</u> Occupational (Controlled)	

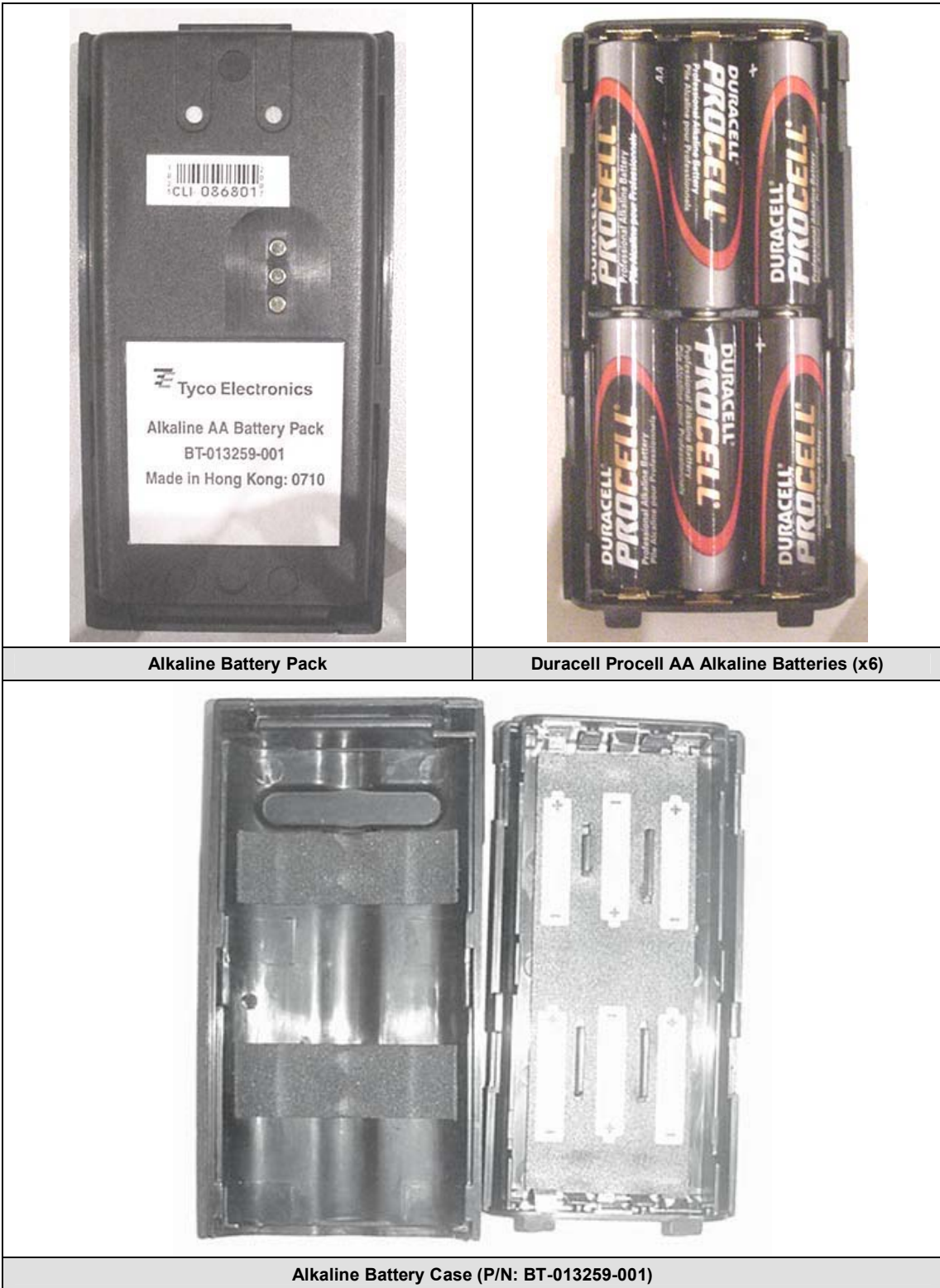
DUT PHOTOGRAPHS



Applicant: M/A-COM, Inc.	FCC ID: OWDTR-0016-E	IC: 3636B-0016	Freq.: 378 - 430 MHz	
Model(s): P7100 (UHF-L)	DUT Type: Portable UHF-L PTT Radio Transceiver with Alkaline Battery Pack			
2008 Celltech Labs Inc.	This document is not to be reproduced in whole or in part without the prior written permission of Celltech Labs Inc.			Page 31 of 33

	<u>Date(s) of Evaluation</u> October 25-26, 2007	<u>Test Report Serial No.</u> 102507OWD-T868a-S90U	<u>Test Report Revision No.</u> Revision 1.0	 Certificate No. 2470.01
	<u>Test Report Issue Date</u> January 08, 2008	<u>Description of Test(s)</u> Specific Absorption Rate	<u>RF Exposure Category</u> Occupational (Controlled)	

APPENDIX E - SYSTEM VALIDATION

Applicant:	M/A-COM, Inc.	FCC ID:	OWDTR-0016-E	IC:	3636B-0016	Freq.:	378 - 430 MHz	
Model(s):	P7100 (UHF-L)	DUT Type:	Portable UHF-L PTT Radio Transceiver with Alkaline Battery Pack					
2008 Celltech Labs Inc.	This document is not to be reproduced in whole or in part without the prior written permission of Celltech Labs Inc.							Page 32 of 33

	Date of Evaluation:	July 30, 2007	Document Serial No.:	SV450B-073007-R1.2	
	Evaluation Type:	System Validation	Validation Dipole:	450 MHz	Fluid Type:

450 MHz SYSTEM VALIDATION

Type:

450 MHz Validation Dipole

Asset Number:

00024

Serial Number:

136

Place of Validation:

Celltech Labs Inc.

Date of Validation:

July 30, 2007

Celltech Labs Inc. certifies that the 450 MHz System Validation was performed on the date indicated above.

Validated by:

Cheri Frangiadakis

Approved by:

Sean Johnston

	Date of Evaluation:	July 30, 2007	Document Serial No.:	SV450B-073007-R1.2
	Evaluation Type:	System Validation	Validation Dipole:	450 MHz
				Fluid Type: Brain

1. Dipole Construction & Electrical Characteristics

The validation dipole was constructed in accordance with the requirements specified in IEEE Standard 1528-2003 and International Standard IEC 62209-1:2005. The electrical properties were measured using an HP 8753ET Network Analyzer. The network analyzer was calibrated to the validation dipole N-type connector feed point using an HP85032E Type N calibration kit. The dipole was placed parallel to a planar phantom at a separation distance of 15.0mm from the simulating fluid using a loss-less dielectric spacer. The measured input impedance is:

Feed point impedance at 450 MHz $\text{Re}\{Z\} = 55.109\Omega$
 $\text{Im}\{Z\} = 6.2617\Omega$

Return Loss at 450 MHz -22.210dB

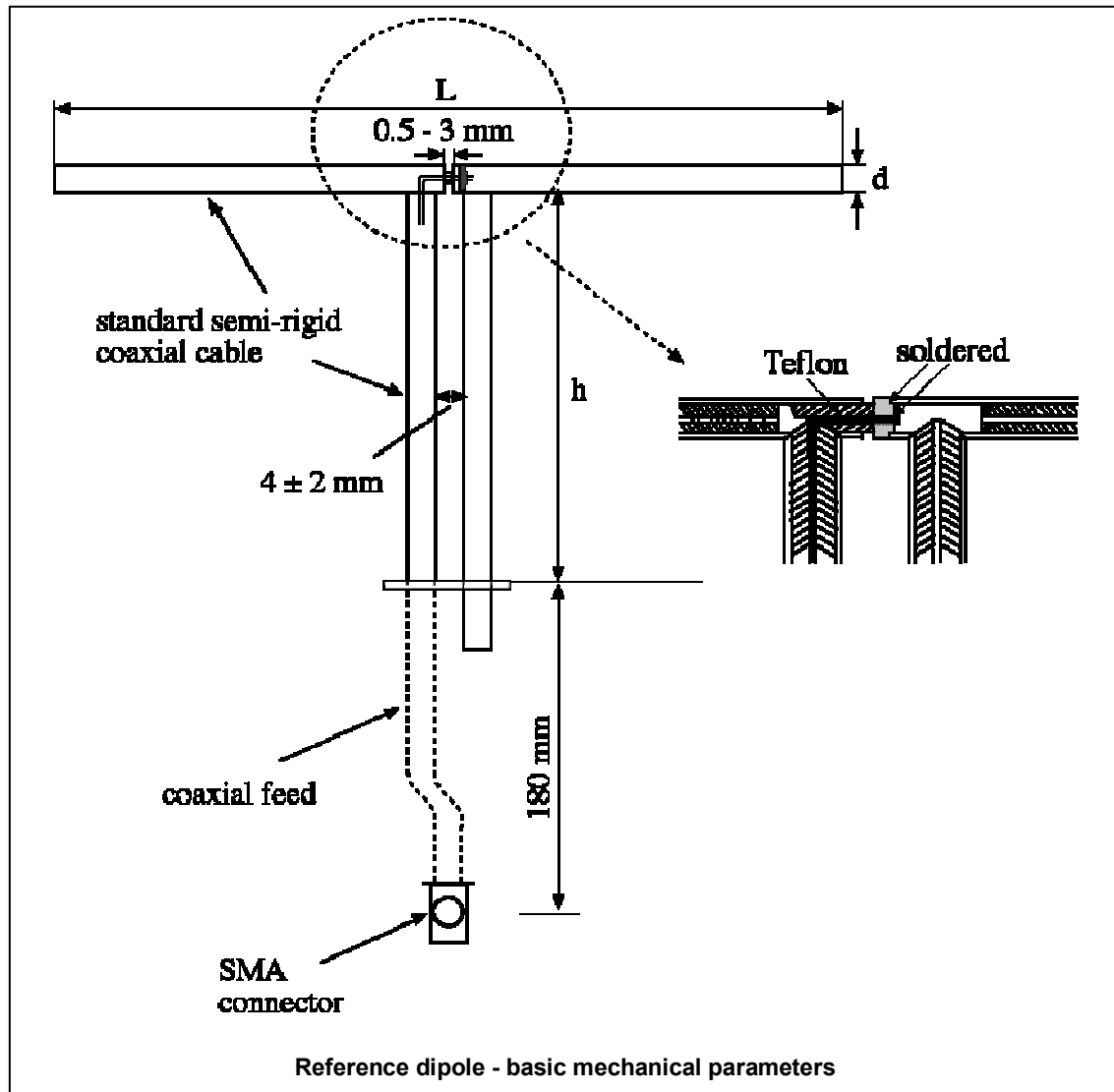

2. Validation Dipole VSWR Data

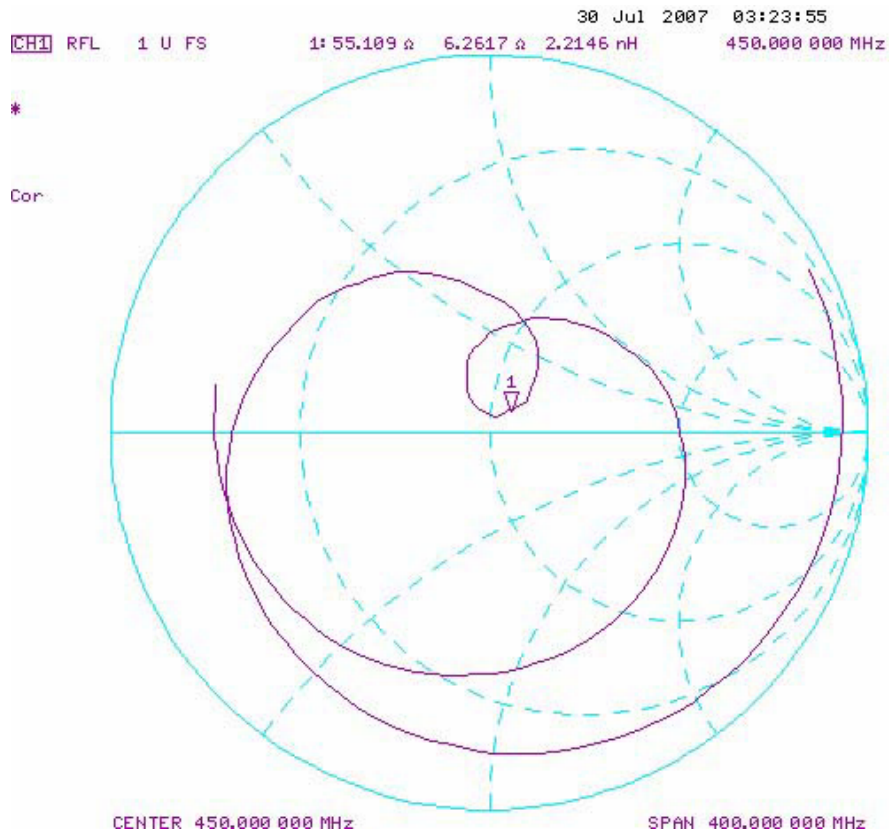
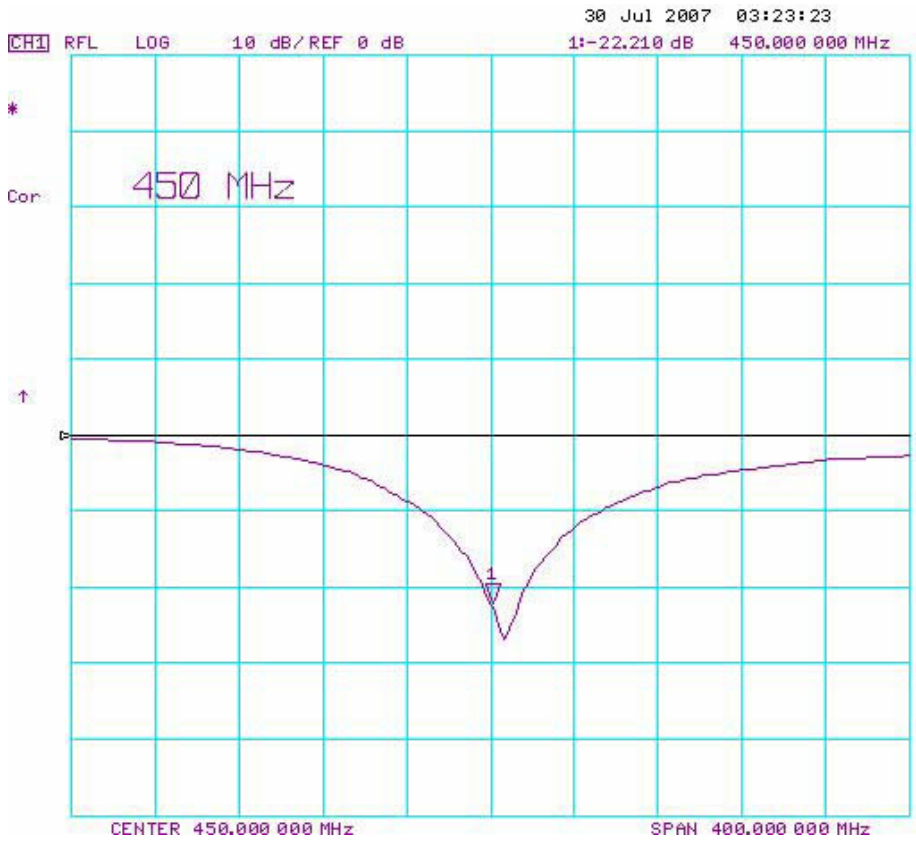

3. Validation Dipole Dimensions

Frequency (MHz)	L (mm)	h (mm)	d (mm)
300	396.0	250.0	6.0
450	270.0	167.0	6.0
835	161.0	89.8	3.6
900	149.0	83.3	3.6
1450	89.1	51.7	3.6
1800	72.0	41.7	3.6
1900	68.0	39.5	3.6
2000	64.5	37.5	3.6
2450	51.5	30.4	3.6
3000	41.5	25.0	3.6

4. Validation Phantom

The validation phantom (planar) was constructed using relatively low-loss tangent Plexiglas material.

The inner dimensions of the validation phantom are as follows:

Length: 83.5 cm
Width: 36.9 cm
Height: 21.8 cm

The bottom section of the validation phantom is constructed of 6.2 ± 0.1 mm Plexiglas.

5. Test Equipment List

TEST EQUIPMENT	ASSET NO.	SERIAL NO.	DATE OF CAL.	CAL. DUE DATE
SPEAG DASY4 Measurement Server	00158	1078	N/A	N/A
SPEAG Robot	00046	599396-01	N/A	N/A
SPEAG DAE4	00019	353	10Jul07	10Jul08
SPEAG ET3DV6 E-Field Probe	00016	1387	16Mar07	16Mar08
450 MHz Validation Dipole	00024	136	30Jul07	30Jul08
Plexiglas Validation Planar Phantom	00157	137	N/A	N/A
HP 85070C Dielectric Probe Kit	00033	US39240170	N/A	N/A
Gigatronics 8652A Power Meter	00007	1835272	26Mar07	26Mar08
Gigatronics 80701A Power Sensor	00014	1833699	22Jan07	22Jan08
Gigatronics 80701A Power Sensor	00109	1834366	26Mar07	26Mar08
HP 8753ET Network Analyzer	00134	US39170292	20Apr07	20Apr08
HP 8648D Signal Generator	00005	3847A00611	NCR	NCR
Amplifier Research 5S1G4 Power Amplifier	00106	26235	NCR	NCR

6. Dimensions of Plexiglas Planar Phantom

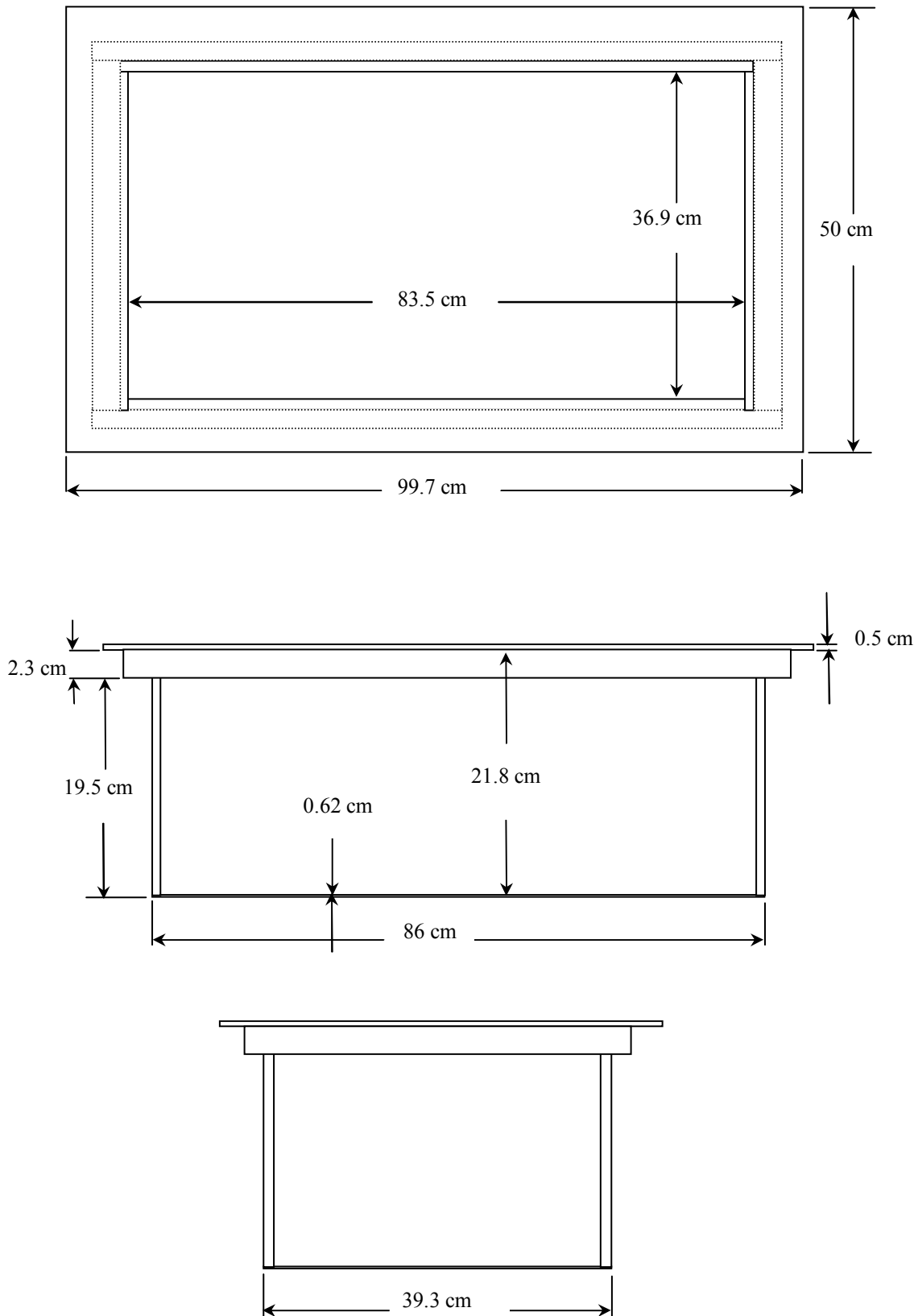

7. 450 MHz System Validation Setup



8. 450 MHz Validation Dipole Setup



9. SAR Measurement

Measurements were made using a dosimetric E-field probe ET3DV6 (S/N: 1387, Conversion Factor 7.0). The SAR measurement was performed with the E-field probe in mechanical detection mode only. The setup and determination of the forward power into the dipole was performed using the procedures described below.

First the power meter PM1 (including attenuator Att1) is connected to the cable to measure the forward power at the location of the dipole connector (X). The signal generator is adjusted for the desired forward power at the dipole connector (taking into account the attenuation of Att1) as read by power meter PM2. After connecting the cable to the dipole, the signal generator is readjusted for the same reading at power meter PM2. If the signal generator does not allow adjustment in 0.01dB steps, the remaining difference at PM2 must be taken into consideration. PM3 records the reflected power from the dipole to ensure that the value is not changed from the previous value. The reflected power should be 20dB below the forward power.

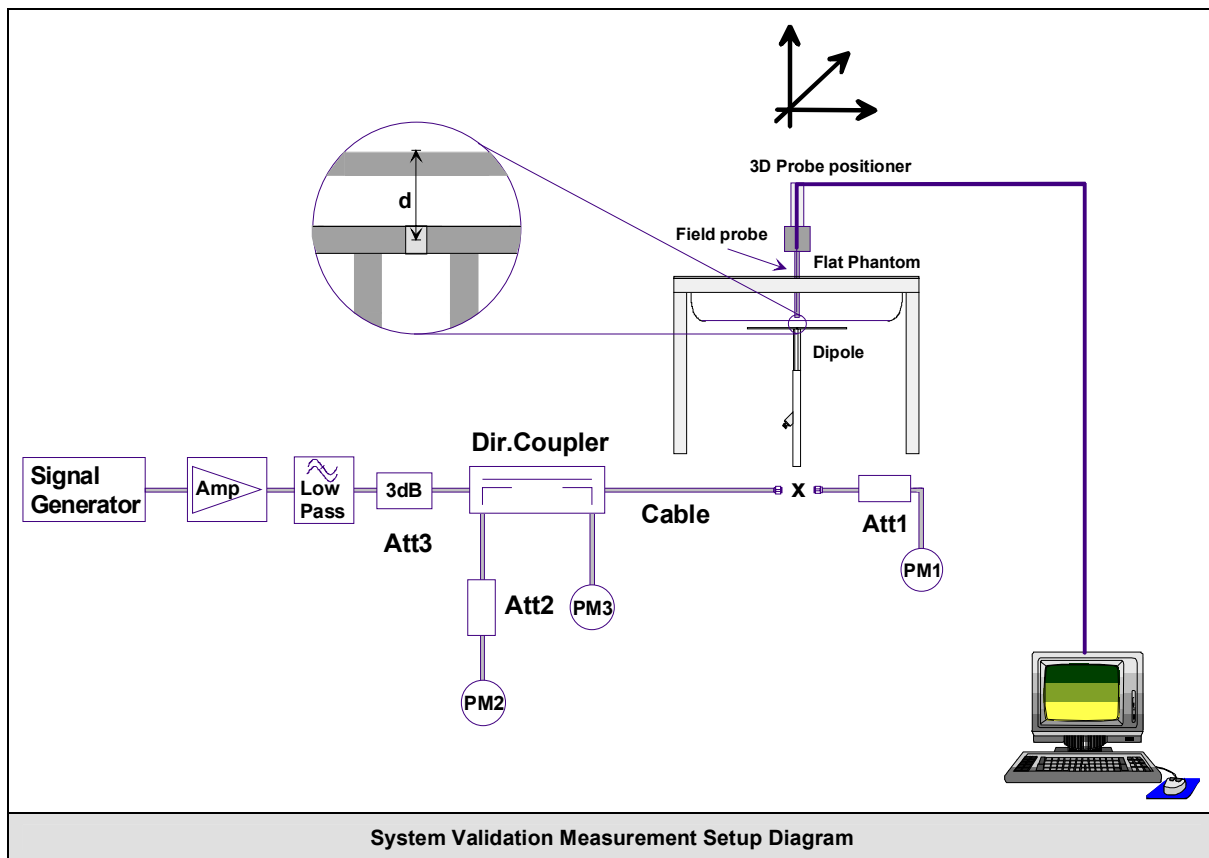

10. Measurement Conditions

The validation phantom was filled with 450 MHz Brain tissue simulant.

Relative Permittivity: 43.1 (-0.9% deviation from target)
 Conductivity: 0.85 mho/m (-2.3% deviation from target)
 Fluid Temperature: 23.1°C (Start of Test) / 23.3°C (End of Test)
 Fluid Depth: ≥ 15.0 cm

Environmental Conditions:

Ambient Temperature: 24.5°C
 Barometric Pressure: 101.1 kPa
 Humidity: 31%

The 450 MHz Brain tissue simulant consisted of the following ingredients:

Ingredient	Percentage by weight	
Water	38.56%	
Sugar	56.32%	
Salt	3.95%	
HEC	0.98%	
Dowicil 75	0.19%	
IEEE Target Dielectric Parameters:	$\epsilon_r = 43.5$ (+/- 5%)	$\sigma = 0.87$ S/m (+/- 5%)

11. System Validation SAR Results

SAR @ 0.25W Input averaged over 1g (W/kg)				SAR @ 1W Input averaged over 1g (W/kg)			
IEEE/IEC Target		Measured	Deviation	IEEE/IEC Target		Measured	Deviation
1.23	+/- 10%	1.29	+4.9%	4.9	+/- 10%	5.16	+5.3%
SAR @ 0.25W Input averaged over 10g (W/kg)				SAR @ 1W Input averaged over 10g (W/kg)			
IEEE/IEC Target		Measured	Deviation	IEEE/IEC Target		Measured	Deviation
0.825	+/- 10%	0.832	+0.8%	3.3	+/- 10%	3.33	+1.0%
Frequency (MHz)	1 g SAR	10 g SAR	Local SAR at surface (above feed-point)	Local SAR at surface (y = 2 cm offset from feed-point) ²			
300	3.0	2.0	4.4	2.1			
450	4.9	3.3	7.2	3.2			
835	9.5	6.2	4.1	4.9			
900	10.8	6.9	16.4	5.4			
1450	29.0	16.0	50.2	6.5			
1800	38.1	19.8	69.5	6.8			
1900	39.7	20.5	72.1	6.6			
2000	41.1	21.1	74.6	6.5			
2450	52.4	24.0	104.2	7.7			
3000	63.8	25.7	140.2	9.5			
Numerical reference SAR values for reference dipole and flat phantom normalized to 1 W (IEEE 1528-2003; IEC 62209-1:2005)							

	Date of Evaluation:	July 30, 2007	Document Serial No.:	SV450B-073007-R1.2
	Evaluation Type:	System Validation	Validation Dipole:	450 MHz
			Fluid Type:	Brain

System Validation - 450 MHz Dipole - July 30, 2007 - HSL

DUT: Dipole 450 MHz; Asset: 00024; Serial: 136; Validation: 07/30/2007

Ambient Temp: 24.5°C; Fluid Temp: 23.1°C; Barometric Pressure: 101.1 kPa; Humidity: 31%

Communication System: CW

Forward Conducted Power: 250 mW

Frequency: 450 MHz; Duty Cycle: 1:1

Medium: HSL450 Medium parameters used: $f = 450 \text{ MHz}$; $\sigma = 0.85 \text{ mho/m}$; $\epsilon_r = 43.1$; $\rho = 1000 \text{ kg/m}^3$

- Probe: ET3DV6 - SN1387; ConvF(7, 7, 7); Calibrated: 16/03/2007
- Sensor-Surface: 4 mm (Mechanical Surface Detection)
- Electronics: DAE4 Sn353; Calibrated: 10/07/2007
- Phantom: Validation Planar; Type: Plexiglas; Serial: 137
- Measurement SW: DASY4, V4.7 Build 44; Postprocessing SW: SEMCAD, V1.8 Build 171

450 MHz Dipole - System Validation/Area Scan (6x11x1):

Measurement grid: $dx=15\text{mm}$, $dy=15\text{mm}$

Maximum value of SAR (measured) = 1.35 mW/g

450 MHz Dipole - System Validation/Zoom Scan (5x5x7)/Cube 0:

Measurement grid: $dx=7.5\text{mm}$, $dy=7.5\text{mm}$, $dz=5\text{mm}$

Reference Value = 39.3 V/m; Power Drift = 0.042 dB

Peak SAR (extrapolated) = 2.24 W/kg

SAR(1 g) = 1.29 mW/g; SAR(10 g) = 0.832 mW/g

Maximum value of SAR (measured) = 1.37 mW/g

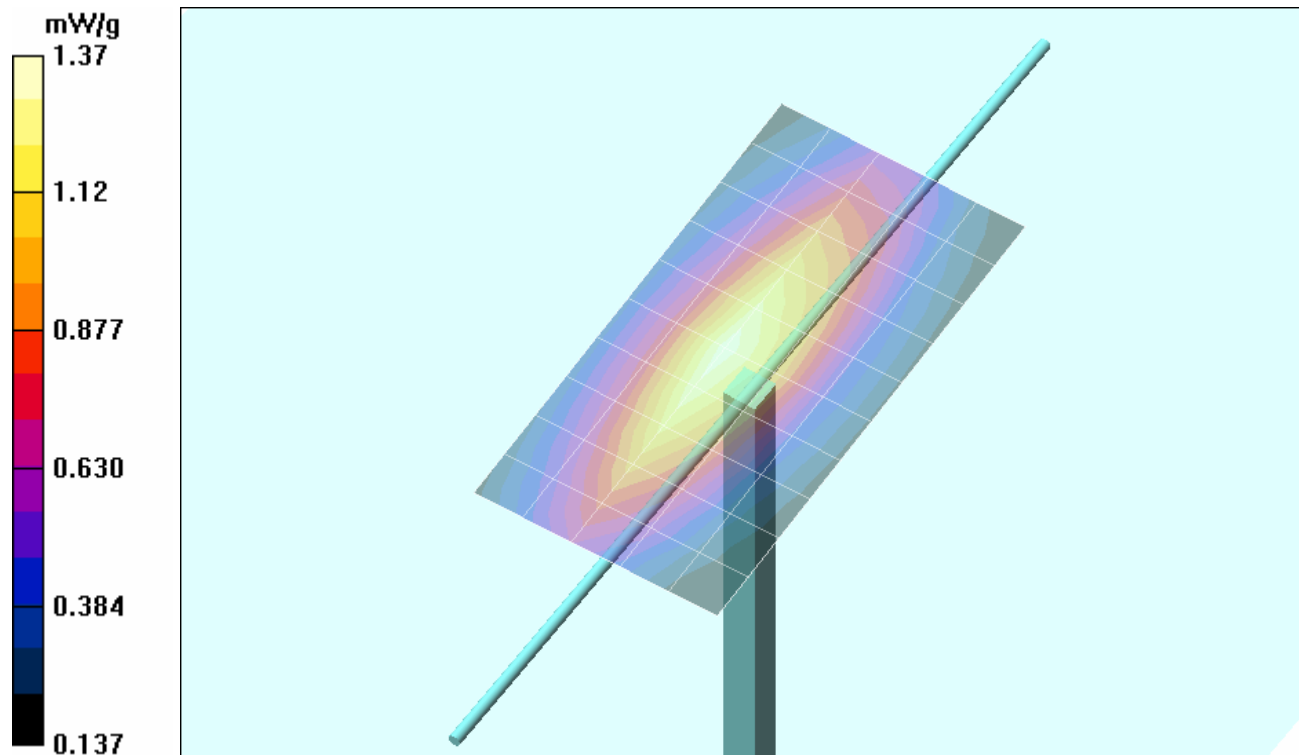

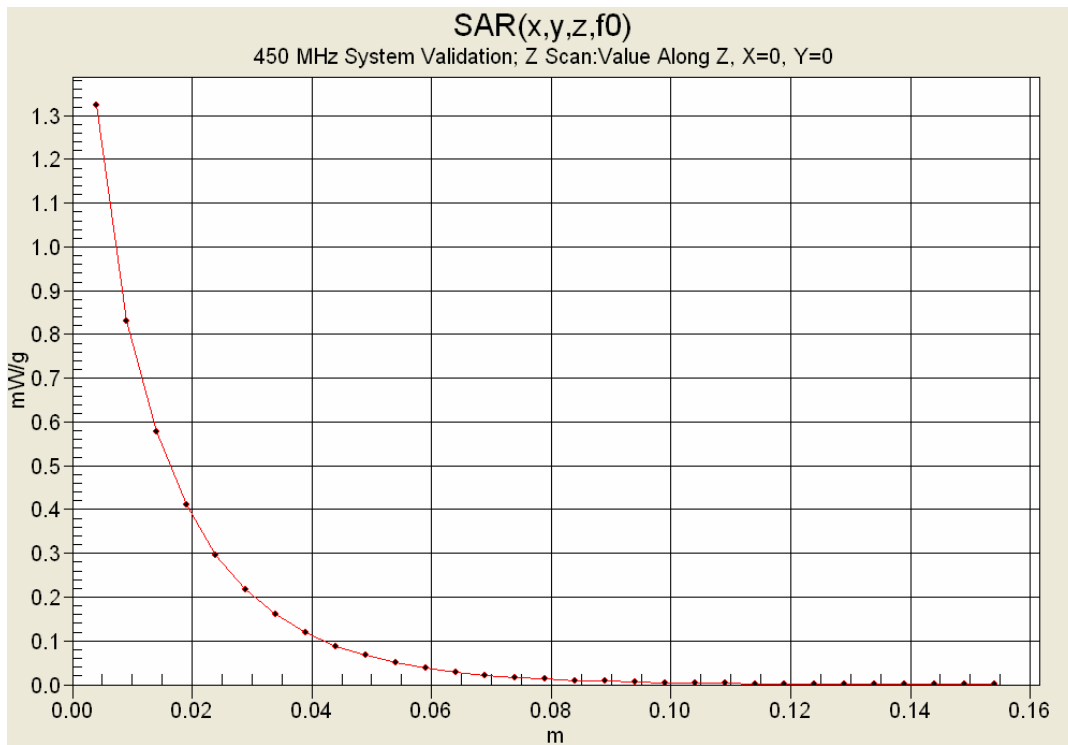

12. Measured Fluid Dielectric Parameters

System Validation - 450 MHz (Brain)

Celltech Labs Inc.

Test Result for UIM Dielectric Parameter

Mon 30/Jul/2007

Frequency (GHz)

FCC_eH FCC OET 65 Supplement C (June 2001) Limits for Head Epsilon

FCC_sH FCC OET 65 Supplement C (June 2001) Limits for Head Sigma

Test_e Epsilon of UIM

Test_s Sigma of UIM

Freq	FCC_eH	FCC_sH	Test_e	Test_s
0.3500	44.70	0.87	45.67	0.76
0.3600	44.58	0.87	45.22	0.77
0.3700	44.46	0.87	45.13	0.78
0.3800	44.34	0.87	44.88	0.79
0.3900	44.22	0.87	44.58	0.80
0.4000	44.10	0.87	44.42	0.81
0.4100	43.98	0.87	44.21	0.82
0.4200	43.86	0.87	43.93	0.82
0.4300	43.74	0.87	43.66	0.83
0.4400	43.62	0.87	43.15	0.84
0.4500	43.50	0.87	43.09	0.85
0.4600	43.45	0.87	42.96	0.86
0.4700	43.40	0.87	42.63	0.87
0.4800	43.34	0.87	42.72	0.87
0.4900	43.29	0.87	42.45	0.89
0.5000	43.24	0.87	42.18	0.90
0.5100	43.19	0.87	42.03	0.90
0.5200	43.14	0.88	41.77	0.91
0.5300	43.08	0.88	41.78	0.92
0.5400	43.03	0.88	41.42	0.93
0.5500	42.98	0.88	41.19	0.93

13. Measurement Uncertainties

UNCERTAINTY BUDGET FOR SYSTEM VALIDATION						
Error Description	Uncertainty Value $\pm\%$	Probability Distribution	Divisor	c_i 1g	Uncertainty Value $\pm\%$ (1g)	V_i or V_{eff}
Measurement System						
Probe calibration (450 MHz)	8	Normal	1	1	8.0	∞
Axial isotropy of the probe	4.7	Rectangular	1.732050808	1	2.7	∞
Spherical isotropy of the probe	0	Rectangular	1.732050808	1	0.0	∞
Spatial resolution	0	Rectangular	1.732050808	1	0.0	∞
Boundary effects	8.2	Rectangular	1.732050808	1	4.7	∞
Probe linearity	4.7	Rectangular	1.732050808	1	2.7	∞
Detection limit	1	Rectangular	1.732050808	1	0.6	∞
Readout electronics	0.3	Normal	1	1	0.3	∞
Response time	0	Rectangular	1.732050808	1	0.0	∞
Integration time	0	Rectangular	1.732050808	1	0.0	∞
RF ambient conditions	3	Rectangular	1.732050808	1	1.7	∞
Mech. constraints of robot	0.4	Rectangular	1.732050808	1	0.2	∞
Probe positioning	2.9	Rectangular	1.732050808	1	1.7	∞
Extrapolation & integration	1	Rectangular	1.732050808	1	0.6	∞
Dipole						
Dipole Positioning	2	Normal	1.732050808	1	1.2	∞
Power & Power Drift	4.7	Normal	1.732050808	1	2.7	∞
Phantom and Setup						
Phantom uncertainty	4	Rectangular	1.732050808	1	2.3	∞
Liquid conductivity (target)	5	Rectangular	1.732050808	0.64	1.8	∞
Liquid conductivity (measured)	2.3	Normal	1	0.64	1.5	∞
Liquid permittivity (target)	5	Rectangular	1.732050808	0.6	1.7	∞
Liquid permittivity (measured)	1	Normal	1	0.6	0.6	∞
Combined Standard Uncertainty					11.43	
Expanded Uncertainty (k=2)					22.87	
Measurement Uncertainty Table in accordance with IEEE 1528-2003 and IEC 62209-1:2005						