

Hearing Aid Compatibility T-Coil

FCC 47 CFR section 20.19 Test Report

Single-Band CDMA Cellular Phone with Bluetooth

FCC ID: OVFKWC- M1000-2J0

Model: M1000-2J0

STATEMENT OF CERTIFICATION

The data, data evaluation and equipment configuration represented herein are a true and accurate representation of the measurements of the sample's HAC T-Coil characteristics as of the dates and at the times of the test under the conditions herein specified.

STATEMENT OF COMPLIANCE

This product was tested in accordance with the measurement procedures specified in ANSI C63.19-2006 and has been shown to be capable of compliance with the technical requirements of FCC 47 CFR section 20.19.

Test Location:	Kyocera Wireless Corp. 10300 Campus Point Drive, San Diego CA 92121, USA		
Test performed by:	Yohannes Ghebrehiwet Test Technician	Date of Test:	06/06/07
Report Prepared by:	Ngoc-Thi Nguyen Regulatory Engineer	Date of Report:	06/11/07
Report Reviewed by:	C. K. Li Hardware Engineer, Principal	Date of Review:	06/12/07

TABLE OF CONTENTS

1	Introduction.....	3
2	Equipment Under Test (EUT).....	3
3	Summary of Test Results.....	4
4	Test conditions.....	5
4.1	Environmental Conditions.....	5
4.2	RF characteristics of the test site.....	5
4.3	Ambient Noise of the test site.....	5
4.4	Test Signal, Frequencies and Output Power.....	5
4.4.1	CDMA2000 Test conditions.....	5
4.5	EUT Operating Conditions.....	6
5	Description of the test equipment.....	6
5.1	Test Equipment Used.....	6
5.2	HAC T-Coil Measurement System.....	7
5.3	Audio Magnetic Probe.....	8
5.4	Audio Magnetic Measuring Instrument (AMMI).....	8
5.5	Audio Magnetic Calibration Coil (AMCC).....	8
6	System Validation & Calibration.....	9
6.1	Input Channel Calibration.....	9
6.2	Probe Calibration.....	9
6.3	Reference Input Level.....	10
6.3.1	CMU200 Audio Codec Calibration.....	10
6.3.2	AMMI Signal Verification.....	10
7	Test Procedure.....	11
7.1	Test Positions.....	12
7.2	Audio Signals.....	12
7.3	Scan Procedures.....	14
7.3.1	Signal Strength and SNR.....	14
7.3.2	Frequency Response.....	14
8	Measurement Uncertainty.....	15
9	T-Coil Requirements and Category.....	16
9.1	RF Emissions.....	16
9.2	Axial Field Intensity.....	16
9.3	Signal Quality.....	16
9.4	Frequency Response.....	17
10	T-Coil Test Results.....	18
10.1	Field Strength and Signal Quality.....	18
10.2	Frequency Response.....	19
11	Appendix A1: Probe Calibration Certification.....	22
12	Appendix A2: DAE4 Calibration Certification.....	23
13	Appendix B2: Ambient Noise Plots, 1900 MHz.....	24
14	Appendix C: System Calibration Results.....	25
15	Appendix D: ABM and SNR Test Results/Plots.....	26
16	Appendix E: Photo Test Setup.....	26

1 Introduction

This test report describes the Hearing Aid Compatibility (HAC) measurement of a wireless portable device manufactured by Kyocera Wireless Corp. (KWC). These measurements were performed for compliance with the rules and regulations of the U.S. Federal Communications Commission (FCC). The testing was performed in accordance with ANSI C63.19-2006.

This report covers test and data on:

	RF Emissions	ANSI C63.19 Clause 4
X	T-Coil	ANSI C63.19 Clause 6

2 Equipment Under Test (EUT)

Product:	Single-Band CDMA Cellular Phone with Bluetooth
FCC ID:	OVFKWC-M1000-2J0
Model Number:	M1000-2J0
EUT Serial Number:	FFMK0000001447
Type:	[x] Identical Prototype [] Pre-Production [] Production
Device Category:	Portable
RF Exposure Environment:	General Population / Uncontrolled
T-Coil Location:	Same as speaker location
Antenna:	Internal Antenna
Detachable Antenna:	No
External Input:	Audio/Digital Data
Quantity:	Quantity production is planned
Modes:	1900 CDMA
Multiple Access Scheme:	CDMA
TX Frequency (MHz):	1850 - 1910
Rated RF Conducted Output Power (dBm)	22.5

3 Summary of Test Results

ANSI C63.19 (2006)				
Section 6 T-coil				
Mode	Test	Test Results	T-Rating	Verdict
CDMA 1900	Min. Axial Field Strength, dB A/m	-4.05459	T4	Pass
	Min. Radial Field Strength, dB A/m	-11.4299	T4	Pass
	Min. Signal Quality (ABM1/ABM2), dB	32.22	T4	Pass
	Frequency Response @ Axial position			Pass
Overall T-Rating :		T4		
M-Rating* :		M3		
HAC Category Rating :		M3, T4		

* M-rating obtained from HAC RF report.

4 Test conditions

4.1 Environmental Conditions

All tests were performed under the following environmental conditions:

Ambient Temperature:	23 ± 2 Degrees C
Relative Humidity (RH):	0% <RH < 80%
Atmospheric Pressure:	101.3kPa + 10 to -5 kPa

4.2 RF characteristics of the test site

All HAC measurements were performed inside a shielded room that provide isolation from external EM fields, with the RF ambient at least 20 dB below the intended measurement limits.

4.3 Ambient Noise of the test site

The test site's ambient magnetic level were determined and found to be at least 10dB below the measurement data ABM2, unless a very low level of AMB2. Measurement of the ambient level was performed for each probe orientation and results are shown in Appendix B.

4.4 Test Signal, Frequencies and Output Power

During tests, the EUT was put in in-call mode and controlled by a CDMA simulator to generate the required signal and power.

4.4.1 CDMA2000 Test conditions

The device supports CDMA2000 in 1X (Phase I, Protocol revision 6) mode only. CDMA2000 1X includes TIA/EIA-95B as a subset and was approved for publishing in July 1999. It provides voice and data capabilities within a standard 1.25 MHz CDMA channel. This RF bandwidth is identical to the legacy IS-95 B system standard.

Maximum average conducted powers were measured to ensure worst case power configuration was tested.

CONFIGURATION	CONDUCTED POWER (dBm)		
	CDMA 1900		
	Ch 25	Ch 600	Ch 1175
	Avg	Avg	Avg
SO2, RC1 Full Rate	22.43	22.78	22.85
SO2, RC3 Full Rate	22.50	22.82	22.88
SO3, RC1 Full Rate	22.63	22.80	22.84
SO3, RC3 Full Rate	22.59	22.68	22.81
SO17, RC2 Full Rate	22.52	22.73	22.78
SO17, RC 54 Full Rate	22.59	22.71	22.80
SO55, RC1 Full Rate	22.49	22.81	22.86
SO55, RC3 Full Rate	22.51	22.85	22.90
TDSO SO32, RC3 (FCH +SCH) Full Rate	22.00	22.71	22.40
TDSO SO32, RC3 (FCH) Full Rate	22.50	22.78	22.11

Table 4.4.1 Conducted RF output power measured vs RC's

The following configuration was chosen:

Protocol:	6 (IS-2000)
Radio Configuration:	1
Power Control:	All Up Bits
Service Option:	3
Vocoder:	8K Enhanced (low)
Data Rate:	Full

The measurement system measures power drift during HAC testing by comparing field strength in the same location at the beginning and at the end of measurement. These records were used to monitor stability of power output during tests. Conducted RF power measurements were also performed before and after each HAC measurements to confirm the output power.

4.5 EUT Operating Conditions

The EUT was tested with the follow configurations and conditions, if applicable:

<input checked="" type="checkbox"/>	Fully charged standard battery as supplied with the handset
<input checked="" type="checkbox"/>	Closed configurations, at ear use position ¹
<input type="checkbox"/>	Both retracted and extended antenna positions
<input checked="" type="checkbox"/>	Back-light always ON
<input checked="" type="checkbox"/>	LCD Contrast High
<input type="checkbox"/>	Simultaneous transmission with Bluetooth transmitter ON ²
<input checked="" type="checkbox"/>	Volume setting at maximum
<input checked="" type="checkbox"/>	Microphone muted

Note

1: Phone operates at head position at closed configuration only.

2: The Bluetooth transmitter was not enable during tests, since the intended use of the CDMA transmitter does not include support simultaneous operation when held to ear.

5 Description of the test equipment

5.1 Test Equipment Used

Below is a list of the calibrated equipment used for the measurements:

Description	Manufacturer	Model Number	Serial Number	Cal Due Date
Power Meter	Giga-tronics	8541C	1831306	07/11/07
Radio Communication Tester	Rohde & Schwarz	CMU200	101328	03/01/08
Data Acq	Speag	DAE4	527	09-19-07
Audio Band Magnetic Probe	Speag	AM1DV2	1045	09-26-07
Audio Band Magnetic Measuring Instrument	Speag	AMMI	1035	N/A
Helmholtz Coil	Speag	AMCC	--	N/A
Test Arch	Speag	--	1015	N/A

The calibration certificates of Probe and Helmholtz Coil are attached in Appendix A.

5.2 HAC T-Coil Measurement System

The measurements were performed with Dasy4 automated near-field scanning system comprised of high precision robot, robot controller, computer, Magnetic probe, probe alignment sensor, non-conductive phone positioner, Test Arch and software extension. Figure 5.2 shows the setup and cabling. The overall expanded uncertainty (K=2) of the measurement system is $\pm 12.3\%$. The measurement uncertainty budget is given in section 8.



Figure 5.2a T-Coil setup with Helmholtz Coil

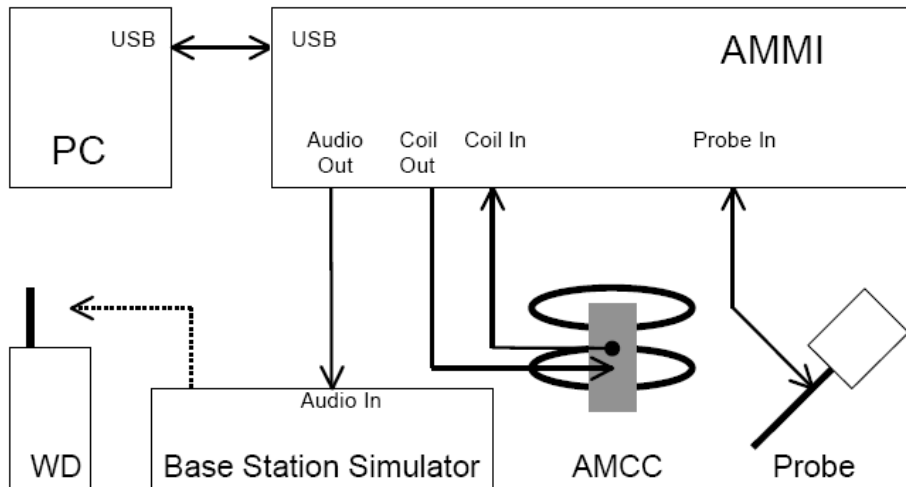

Figure 5.2b Setup Cabling

5.3 Audio Magnetic Probe

Model:	▪ AM1D
Application:	▪ Active single sensor probe for both axial and radial measurement scans
Construction:	<ul style="list-style-type: none"> ▪ Fully RF shielded ▪ Rounded tip of 6 mm diameter incorporating a pickup coil with its center offset 3mm from the tip and the sides ▪ Compatible with DAE, with adapted probe cup
Frequency Response:	▪ ± 0.5 dB of ideal differentiator from 100 Hz to 10 kHz
Linearity:	▪ < 0.1 dB from 5 dB below limitation to 16 dB above noise level
Dynamic Range:	▪ Max 21 dB A/m @ 1 kHz, Noise level typ. -70 dB A/m @ 1kHz, ABM2 typ. -60 dB A/m
Sensitivity:	▪ Typ. -24 dBV / A./m @ 1kHz at probe output
RF Shielding:	▪ Immunity to AM (1 kHz, 80%) modulation RF signal

5.4 Audio Magnetic Measuring Instrument (AMMI)

Model:	▪ AMMI
Application:	AMMI is a desktop 19-inch unit containing a sampling unit, a waveform generator for test and calibration signals and a USB interface.
Connection:	<p>Front connectors</p> <ul style="list-style-type: none"> ▪ Audio Out - audio signal to the base station simulator ▪ Coil Out - test and calibration signal to the AMCC ▪ Coil In - monitor signal from the AMCC BNO connector ▪ Probe In - probe signal

5.5 Audio Magnetic Calibration Coil (AMCC)

Model:	▪ AMCC
Application:	The Audio Magnetic Calibration coil is a Helmholtz Coil designed according to ANSI C63.19-2006 section D.9, for calibration of the AM1D probe. The two horizontal coils generate a homogeneous magnetic field in the z direction. The DC input resistance is adjusted to approximately 50 Ohm by a series resistor, and a shunt resistor of 10 Ohm allows monitoring the current with a scale of 1:10.
Connection:	<ul style="list-style-type: none"> ▪ Coil In ▪ Coil Monitor

6 System Validation & Calibration

At the beginning of the HAC T-coil measurement, a 3-phase calibration was performed per Speag instruction to ensure accurate measurement of the voltages and ABM field. Reference input level was also validated and calibrated per C63.19.

6.1 Input Channel Calibration

Phase 1: The AMMI audio output was switched off, and a 200 mV_{pp} symmetric rectangular signal of 1 kHz was generated and internally connected directly to both channels of the sampling unit (coil in, probe in).

Phase 2: The AMMI audio output was off, and a 20 mV_{pp} symmetric 100 Hz signal was internally connected.

The signals during phases 1 and 2 were available at the output on the rear panel of the AMMI. The output must however not be loaded in order not to influence the calibration. After the first two phases, the two input channels were both calibrated for absolute measurements of voltages. The resulting factors were displayed above the multimeter window.

After phases 1 and 2, the input channels were calibrated to measure exact voltages.

6.2 Probe Calibration

Phase 3: a multisine signal covering each third-octave band from 50 Hz to 5 kHz was generated and applied to both audio outputs. The probe was positioned in the center of the AMCC (user point “coil center”) and aligned in the z-direction, the field orientation of the AMCC. The Coil In channel was measuring the voltage over the AMCC internal shunt, which was proportional to the magnetic field in the AMCC. At the same time, the probe in channel samples the amplified signal picked up by the probe coil. The ratio of the two voltages – in each third-octave filter – leads to the calibration factor of the probe over the frequency band of interest for the spectral representation.

The calibration result is shown in Appendix C. The internal calibration factors of the coil and probe channel are listed. The graphics represent the values (applying the calibration factors from the previous steps) for the probe and coil channel in dB V for each third-octave filter from 100 Hz to 5 kHz. The single values are interconnected with a blue line for the probe and a green line for the coil channel.

The probe sensitivity in V / (A/m) at 1 kHz is calculated from the values in the chart. -20 dBV in the coil channel corresponds approx. to 1 A/m. For the AM1DV2 probe, the lines typically cross at 1.5 kHz and a level of -28 dBV.

Calibration Factors	Measured Value
Probe Sensitivity, V/(A/m)	0.065926
Probe calibration factor, V	1.15669
Coil calibration factor, V	2.37856

6.3 Reference Input Level

ANSI C63.19 requires the use of reference input level of -18dBm0 that correlate to a normal speech input level for CDMA air interface. In order to create the correct level the CMU200 audio codec and the AMMI output were calibrated.

6.3.1 CMU200 Audio Codec Calibration

The CMU200 0dBm0 input reference was determined utilizing the build-in functions of “Decoder Cal” and “Encoder Cal”. The verification results are shown in the table 6.3a below. All the measured parameters were within the specification.

Equipment:	CMU200 (S/N: 101328)	
Test Date:	May 03, 2007	
Item	Description	Level
1	Decoder Cal Value (dBV)	-2.53
2	Encoder Cal Value w/ AMMI gain = 10 (dBV)	-20.05
3	C63.19 CDMA Reference Input Level (dBm0)	-18
4	CMU200 0dBm0 Input Reference Value (dBV)	3.14
5	Desired signal level for -18dBm0	-23.67
6	AMMI output required to generate a signal level in ⑤	-20.49

Where 5 = 3 - 4 + 1

Table 6.3a Reference Input Level

6.3.2 AMMI Signal Verification

Verification of AMMI output level was performed before the compliance measurement. The measured results are showed in Table 6.3b

Date	Measured AMMI Output (dBm0)	Target Reference Input (dBm0)	Delta (dB)
June 6, 2007	-20.5150	-20.49	0.0250

Table 6.3b Measured Output Level

7 Test Procedure

The device was positioned and setup according to ANSI C63.19-2006. Figure 7.0 shows the T-Coil Signal measurement flowchart:

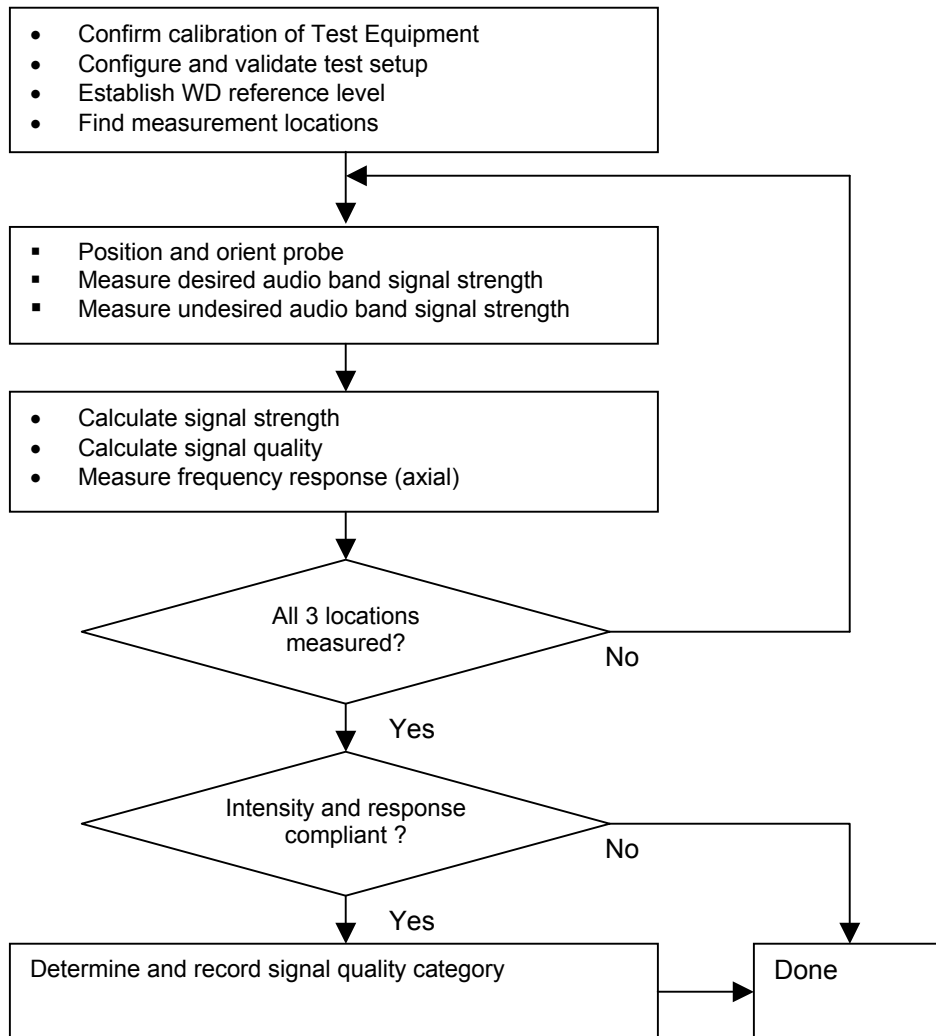

Figure 7.0 T-Coil measurement flowchart

7.1 Test Positions

The device was placed on a non-conductive phone positioner under the Test Arch. The acoustic output of the EUT was aligned with the center point of the area formed by the dielectric wire and the middle bar of the arch's top frame. Please refer to Appendix E for the test setup photos.

7.2 Audio Signals

During tests signal was fed to the EUT via communication Test set. Proper gain setting was used in software to ensure correct signal level fed to communication test set speech input.

The following audio signals were pre-defined by DASY4 and used for calibration and measurements:

1.025 kHz sine wave (duration 10 s): used alternatively instead of 1 kHz, according to ANSI C63.19 section 6.3.1 step 2, if the internal 1.0 kHz signal would cause interferences inside the WD. The bandwidth is suited for signal quality or signal level measurements if not suppressed in the WD codec. Peak to RMS ratio: 3.0 dB. The spectrum is shown in a practical measurement in fig. 7.2a.

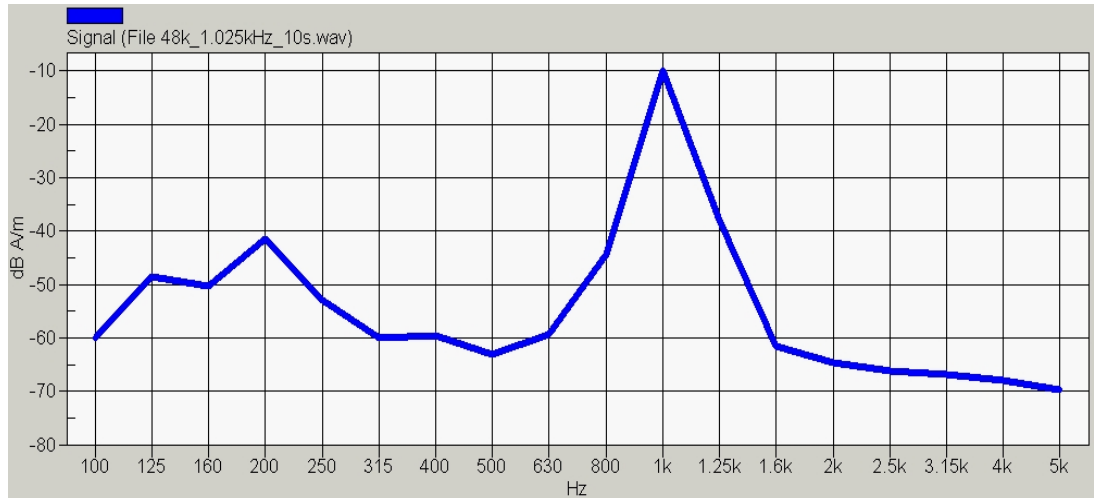

Figure 7.2a 1.025 KHz Voice signal spectrum

Multisine signal 50 Hz – 5 kHz (duration 10 s): Signal with carrier centered in each third-octave band, as used during the calibration. Suited for frequency response measurements. Peak to RMS ratio: 11.1 dB.

48k_voice_300-3000 (duration 2 s): The signal is voice like and has been processed to have a duration of 2 seconds for fast measurement. At the same time, it has a flat spectrum across all third-octave band filters between 300 Hz to 3 kHz and is vanishing at the beginning and end in order to allow longer measurement sequences without transients. It has bandwidth sufficient for frequency response measurements. The spectrum is shown in a practical measurement in fig. 7.2b. The measurement window length of this signal must be set to a multiple of 2 s in order to integrate over the full voice sample. Peak to RMS ratio: 21.6 dB.

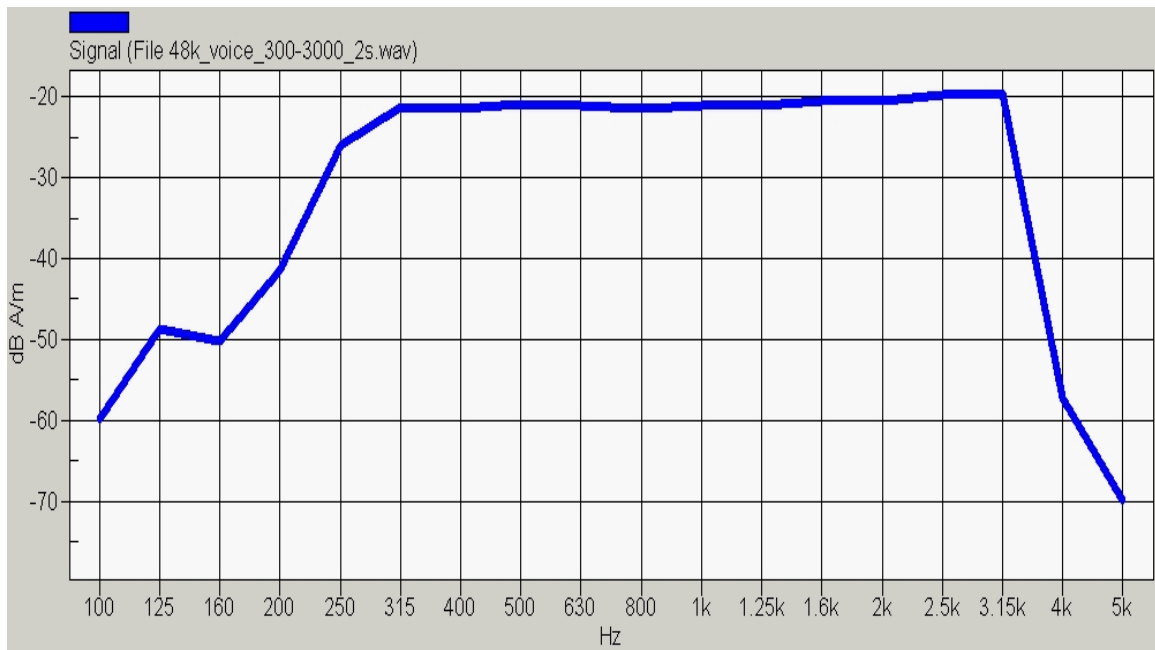
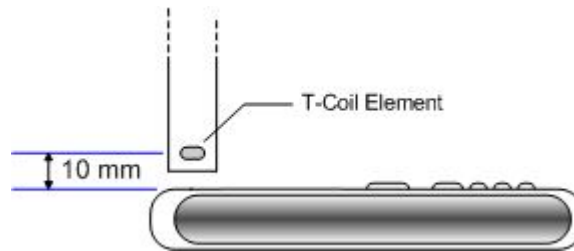

Figure 7.2b Broadband signal spectrum

7.3 Scan Procedures

7.3.1 Signal Strength and SNR

- a) A 50mm x 50mm (10mm step) coarse axial scan was performed to search for the “optimal points” and spatial distribution of ABM1.
- b) Base on the coarse scan results, a 16mm x 16mm (4mm step) fine scan in axial, a 24mmx16mm (4mm step) fine scan in radial_L, and a 16mmx24mm (4mm step) fine scan in radial-T coil orientation were performed for both ABM1and ABM2.



7.3.2 Frequency Response

Base on the coarse axial scan results, a point axial scan was performed.

8 Measurement Uncertainty

Table 8.1 shows the uncertainty budget for HAC Audio Band Magnetic Field (AMB) assessment according to ANSI C63.19-2006. The budget is valid for the DASY4 system and represents a worst-case analysis. For specific tests and configurations, the uncertainty could be smaller.

Uncertainty Description	Uncert. Value (± %)	Prob. Dist.	Div.	C _i (ABM1)	C _i (ABM2)	Stand. Uncert (ABM1) (±%)	Stand. Uncert (ABM2) (±%)
PROBE SENSITIVITY							
Reference level	3.0	N	1.0	1	1	3.0	3.0
AMCC geometry	0.4	R	1.7	1	1	0.2	0.2
AMCC current	0.6	R	1.7	1	1	0.4	0.4
Probe positioning during calibration	0.1	R	1.7	1	1	0.1	0.1
Noise contribution	0.7	R	1.7	0.0143	1	0	0.4
Frequency slope	5.9	R	1.7	1	1	0.3	3.5
PROBE SYSTEM							
Repeatability / Drift	1.0	R	1.7	1	1	0.6	0.6
Linearity / Dynamic range	0.6	R	1.7	1	1	0.4	0.4
Acoustic noise	1.0	R	1.7	0.1	1	0.1	0.6
Probe angle	2.3	R	1.7	1	1	1.4	1.4
Spectral processing	0.9	R	1.7	1	1	0.5	0.5
Integration time	0.6	N	1.0	1	5	0.6	3.0
Field distribution	0.2	R	1.7	1	1	0.1	0.1
TEST SIGNAL							
Reference signal spectral response	0.6	R	1.7	0	1	0	0.4
POSITIONING							
Probe positioning	1.9	R	1.7	1	1	1.1	1.1
Phantom thickness	0.9	R	1.7	1	1	0.5	0.5
DUT positioning	1.9	R	1.7	1	1	1.1	1.1
EXTERNAL CONTRIBUTIONS							
RF interference	0	R	1.7	1	1	0	0
Test signal variation	2.0	R	1.7	1	1	1.2	1.2
COMBINED UNCERTAINTY							
Combined Standard Uncertainty (ABM):						4.1	6.1
Extended Standard Uncertainty (k=2) [%]:						8.1	12.3

N: Normal
R: Rectangular

Table 8.1 Worst-Case uncertainty budget for HAC ABM assessment

9 T-Coil Requirements and Category

9.1 RF Emissions

EUT has to fulfill RF emission requirements at the axial measurement location.

9.2 Axial Field Intensity

Table 9.2 shows the minimum limits for ABM1 field intensity:

Component	ABN1 Magnetic Field dB(A/m)	Condition
Axial (z)	≥-13	1 kHz, in 1/3 octave band filter
Radial (x, y)	≥-18	

Table 9.2 ABM1 Intensity Requirements

9.3 Signal Quality

Table 9.3 provides the signal quality requirement for the intended T-Coil signal from a Wireless Device. The worst Signal Quality of the axial and radial components of the magnetic field was used to determined the T-Coil category.

Category	Signal Quality (Signal+Noise to Noise) [dB]
T1	-20 to -10
T2	-10 to 0
T3	0 to 10
T4	> 10
AWF=0	

Table 9.3 T-coil Signal Quality Categories

9.4 Frequency Response

The frequency response of the axial component must follow the frequency curve specified in ANSI C63.19-2006 section 7.3.2, over the frequency range 300-3000 Hz (Figure 9.4).

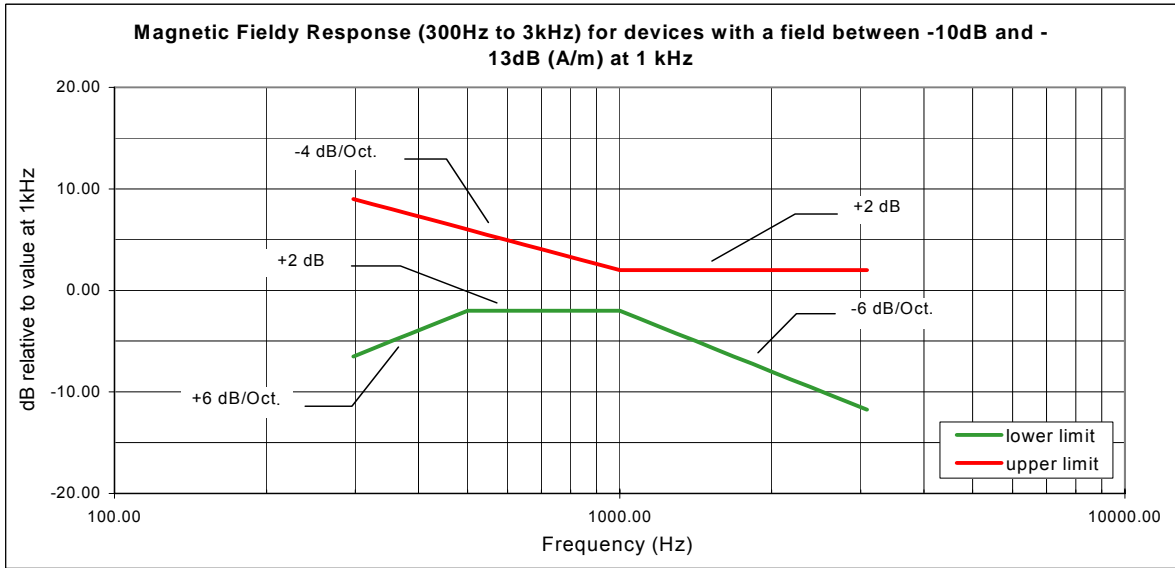

Figure 9.4a Magnetic Field Response (300Hz to 3kHz) for devices with a field between -10dB and -13dB (A/m) at 1 kHz

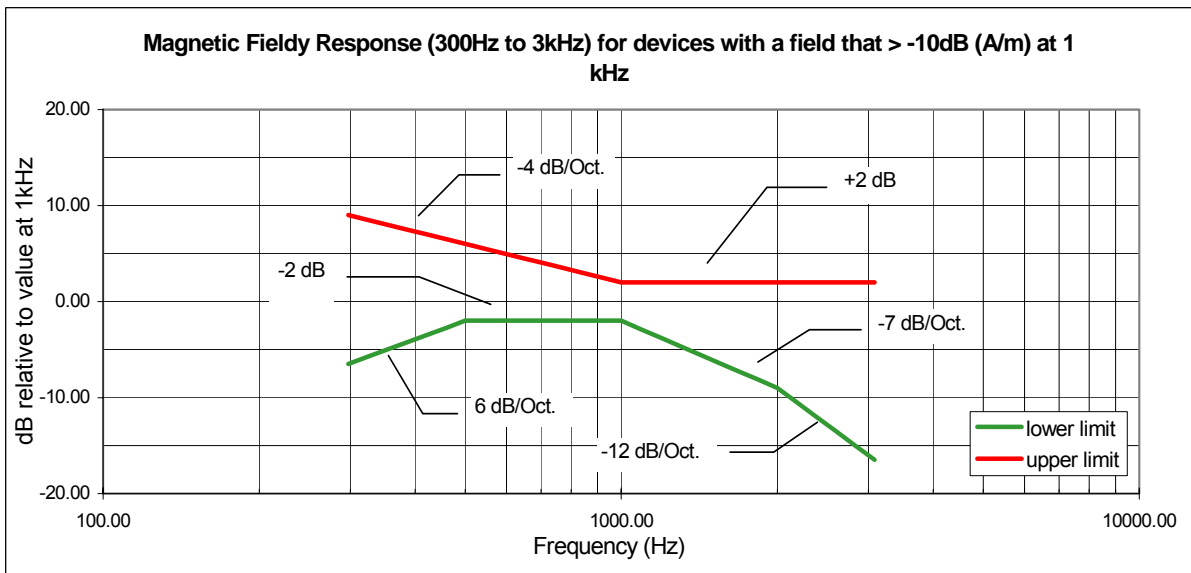

Figure 9.4b Magnetic Field Response (300Hz to 3kHz) for devices with a field that exceeds -10dB (A/m) at 1 kHz

10 T-Coil Test Results

10.1 Field Strength and Signal Quality

ANSI C63.19 (2006)							
Section 6 T-coil							
Field Strength and Signal Quality							
Mode	Ch	Probe Position	Ambient Noise (dB A/m)	ABM1 (dB A/m)	ABM2 (dB A/m)	Signal Quality (dB)	T-Rating
CDMA 1900	25	Axial (z)	-57.35	-0.763884	-41.6844	40.92	4
		Radial_L (x)	-55.76	-8.83613	-42.1329	33.30	4
		Radial_T (y)	-59.30	-8.99229	-52.2529	43.26	4
	600	Axial (z)	-57.35	-0.775526	-41.6205	40.84	4
		Radial_L (x)	-55.76	-9.24366	-42.0262	32.78	4
		Radial_T (y)	-59.30	-8.89037	-53.6057	44.72	4
	1175	Axial (z)	-57.35	-4.05459	-44.2699	40.22	4
		Radial_L (x)	-55.76	-9.69747	-41.9217	32.22	4
		Radial_T (y)	-59.30	-11.4299	-57.06	45.63	4

Note:

- Minimum Limit: ABM1_Axial ≥ -13 dB A/m; ABM1_Radial ≥ -18 dB A/m
- Signal Quality = ABM1/ABM2
- Bold Number = worst case at each frequency band
- Data plots are showed in Appendix D

10.2 Frequency Response

ANSI C63.19 (2006)			
Section 6 T-coil			
Frequency Response			
Mode	Probe Position	Signal Type	Result
CDMA 1900	Axial	Voice	Pass

Figure 10.2 show the frequency response of the axial component of the magnetic field.

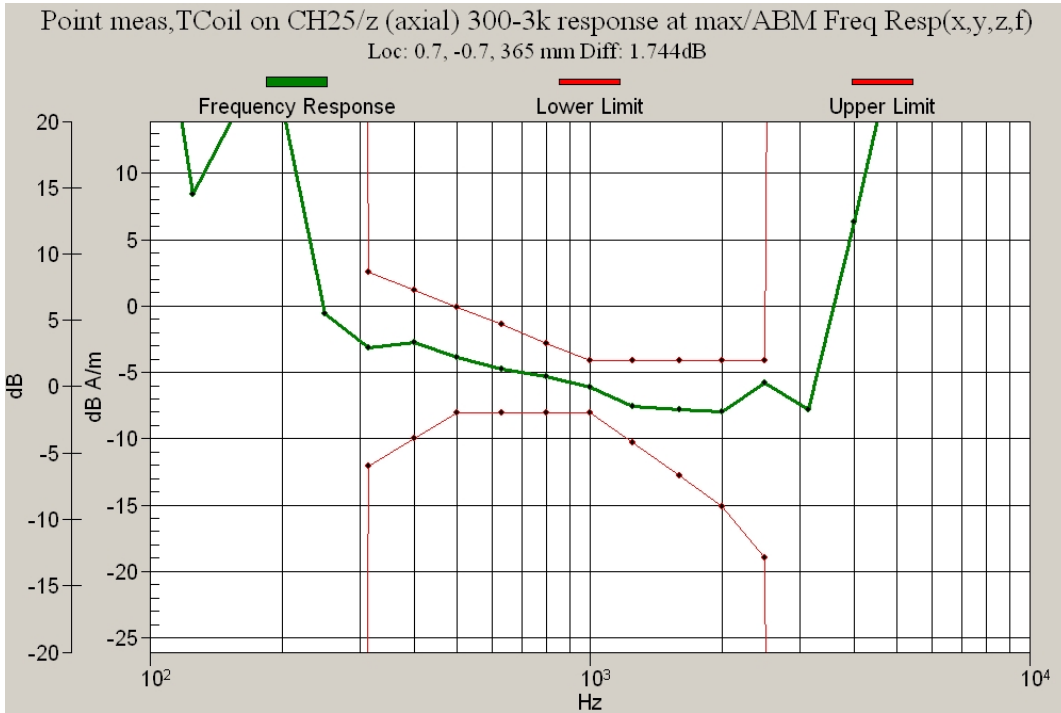

Figure 10.2d CDMA 1900 Channel 25 Frequency Response

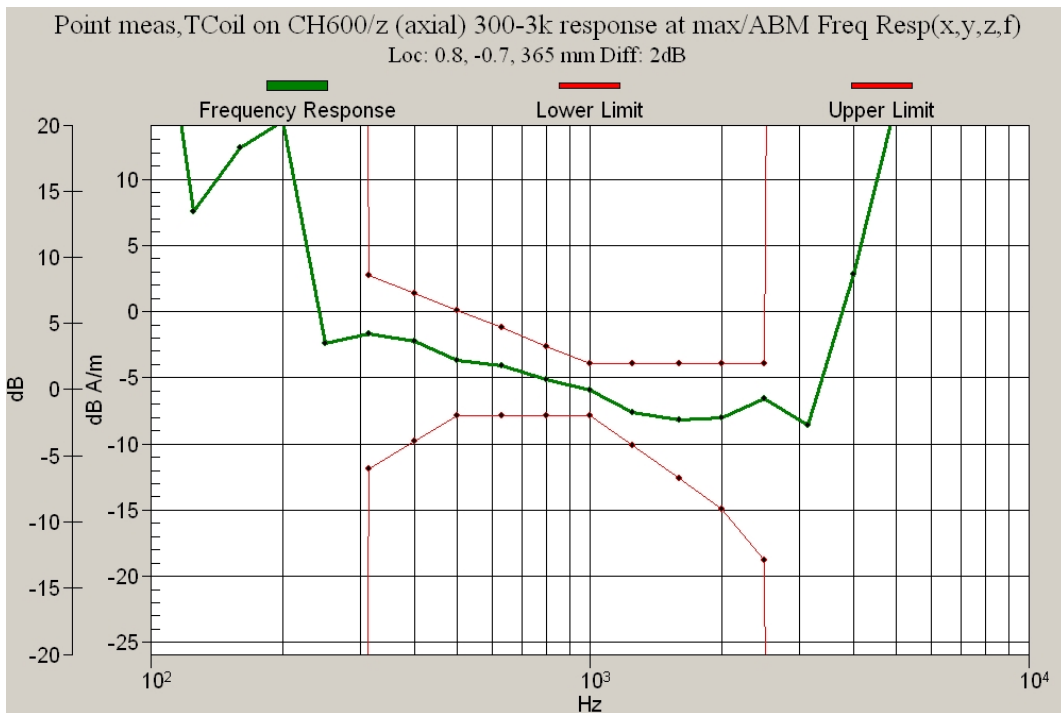

Figure 10.2e CDMA 1900 Channel 600 Frequency Response

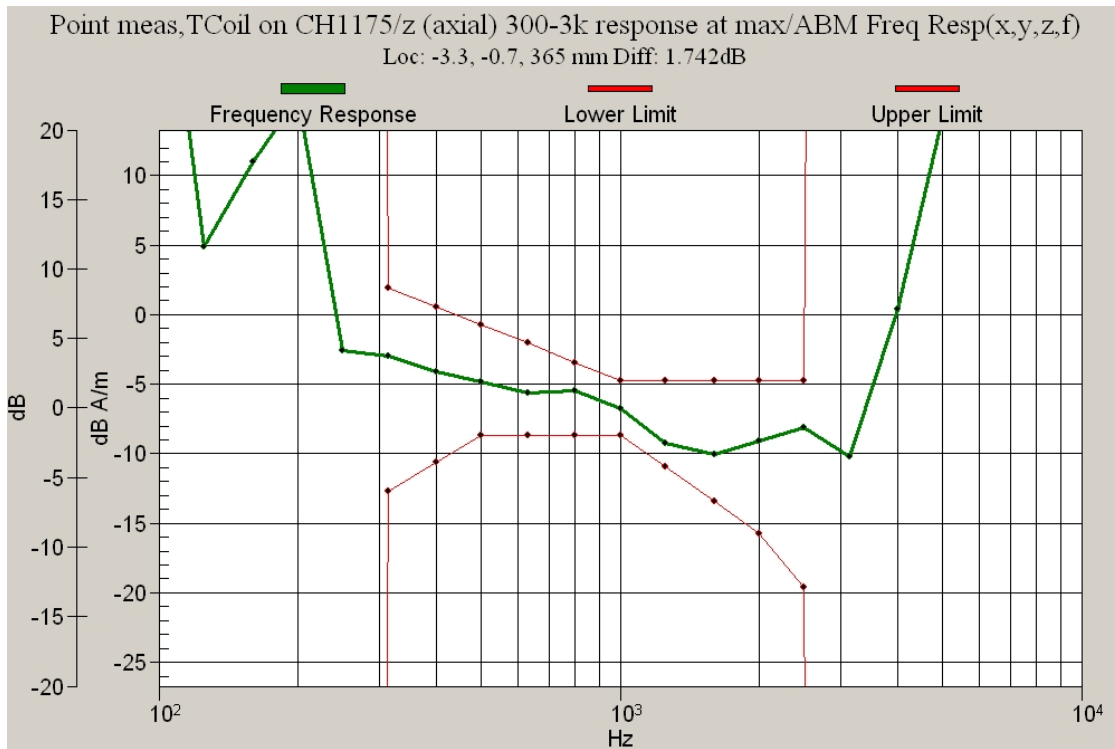

Figure 10.2e CDMA 1900 Channel 1175 Frequency Response

11 Appendix A1: Probe Calibration Certification

Schmid & Partner Engineering AG

s p e a g

Zeughausstrasse 43, 8004 Zurich, Switzerland
 Phone +41 1 245 9700, Fax +41 1 245 9779
 info@speag.com, http://www.speag.com

Client



Certificate of test and configuration

Item	Audio Magnetic 1D Field Probe AM1DV2
Type No	SP AM1 001 AF
Series No	1045
Manufacturer / Origin	Schmid & Partner Engineering AG Zurich, Switzerland

Description of the item

The Audio Magnetic Field Probe is a fully shielded magnetic field probe for the frequency range from 100 Hz to 20 kHz. The pickup coil is compliant with the dimensional requirements of [1]. The probe includes a symmetric 40dB low noise amplifier for the signal available at the shielded 3 pin connector at the side. Power is supplied via the same connector (phantom power supply) and monitored via the LED near the connector. The 7 pin connector at the end of the probe does not carry any signals, but determines the angle of the sensor when mounted on the DAE. The probe supports mechanical detection of the surface. The single sensor in the probe is arranged in a tilt angle allowing measurement of 3 orthogonal field components when rotating the probe by 120° around its axis. It is aligned with the perpendicular component of the field, if the probe axis is tilted 35.3° above the measurement plane, using the connector rotation and Sensor angle stated below.

The probe is fully RF shielded when operated with the matching signal cable (shielded) and allows measurement of audio magnetic fields in the close vicinity of RF emitting wireless devices according to [1] without additional shielding.

Handling of the item

The probe is manufactured from stainless steel. In order to maintain the performance and calibration of the probe, it must not be opened. The probe is designed for operation in air and shall not be exposed to humidity or liquids. For proper operation of the surface detection and emergency stop functions in the DASY4 system, the probe must be operated with the special probe cup provided (larger diameter).

Functional test

The probe configuration data were evaluated after a functional test including amplification, dynamic range and RF immunity.

DASY4 configuration data for the probe

Configuration item	Condition	Configuration Data	Dimension
Overall length	mounted on DAE in DASY4 system	296	mm
Tip diameter	at the cylindrical part	6	mm
Sensor offset	center of sensor, from tip	3	mm
Connector rotation	Evaluated in homogeneous 1 kHz magnetic field generated with AMCC Helmholtz Calibration Coil	282.0	°
Sensor angle		-1.05	°
Sensitivity	typical, at 1 kHz	0.0653	V / (A/m)

Standards

[1] ANSI-C63.19-2006

Date 26.09.2006

Signature



12 Appendix A2: DAE4 Calibration Certification

039873

**Calibration Laboratory of
Schmid & Partner
Engineering AG**
Zeughausstrasse 43, 8004 Zurich, Switzerland



S Schweizerischer Kalibrierdienst
C Service suisse d'étalonnage
S Servizio svizzero di taratura
S Swiss Calibration Service

Accredited by the Swiss Federal Office of Metrology and Accreditation
The Swiss Accreditation Service is one of the signatories to the EA
Multilateral Agreement for the recognition of calibration certificates

Accreditation No.: **SCS 108**

Client **Kyocera USA**

Certificate No: **DAE4-527_Sep06**

CALIBRATION CERTIFICATE

Object: **DAE4 - SD 000 D04 BA - SN: 527**

Calibration procedure(s): **QA CAL-06.v12
Calibration procedure for the data acquisition electronics (DAE)**

Calibration date: **September 19, 2006**

Condition of the calibrated item: **In Tolerance**

This calibration certificate documents the traceability to national standards, which realize the physical units of measurements (SI).
The measurements and the uncertainties with confidence probability are given on the following pages and are part of the certificate.

All calibrations have been conducted in the closed laboratory facility: environment temperature (22 ± 3)°C and humidity < 70%.

Calibration Equipment used (M&TE critical for calibration)

Primary Standards	ID #	Cal Date (Calibrated by, Certificate No.)	Scheduled Calibration
Fluke Process Callibrator Type 702	SN: 6295803	7-Oct-05 (Sintrel, No.E-050073)	Oct-06
Secondary Standards	ID #	Check Date (In house)	Scheduled Check
Callibrator Box V1.1	SE UMS 006 AB, 1002	15-Jun-06 (SPEAG, in house check)	In house check Jun-07

	Name	Function	Signature
Calibrated by:	Eric Halnfeld	Technician	
Approved by:	Fin Bornholt	R&D Director	

Issued: September 19, 2006

This calibration certificate shall not be reproduced except in full without written approval of the laboratory.

13 Appendix B2: Ambient Noise Plots, 1900 MHz

Ambient Noise Spectrum Plot
Axial (z)

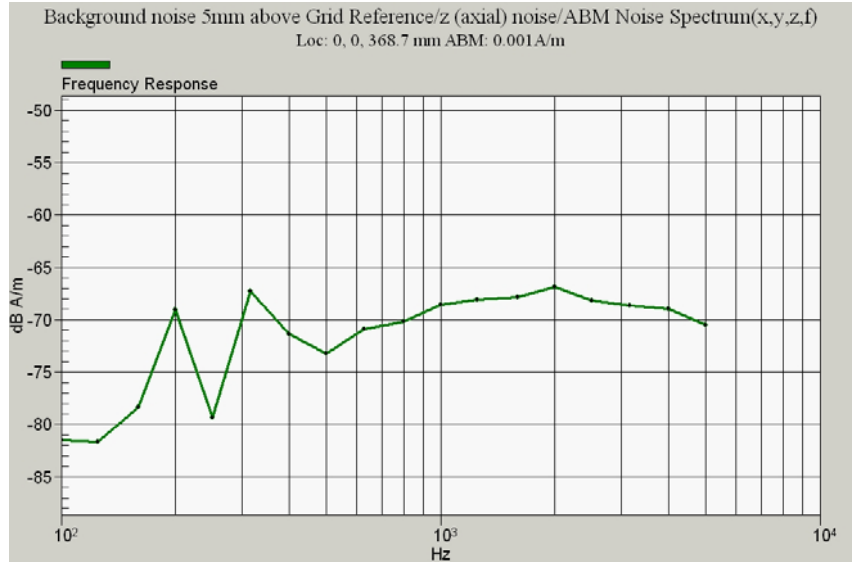

Ambient Noise Spectrum Plot
Radial_Longitudinal (x)

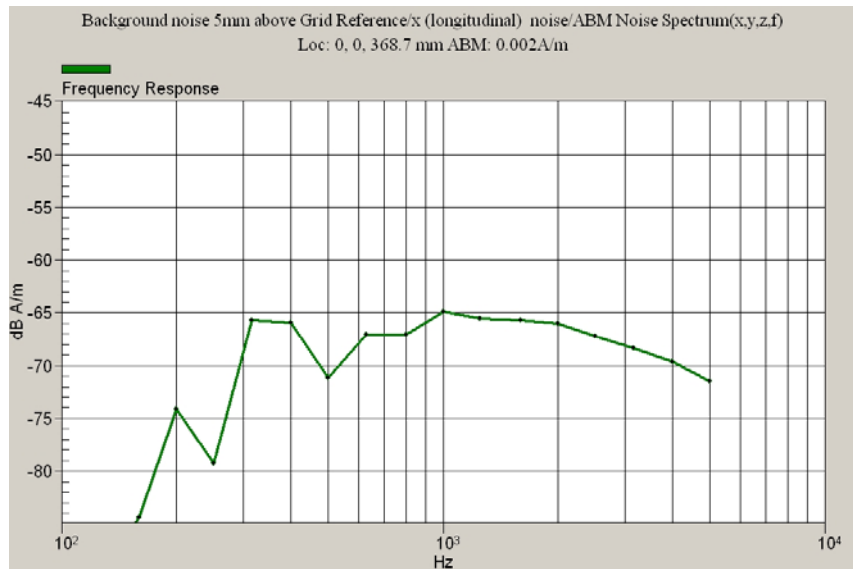

Ambient Noise Spectrum Plot
Radial_Transversal (y)

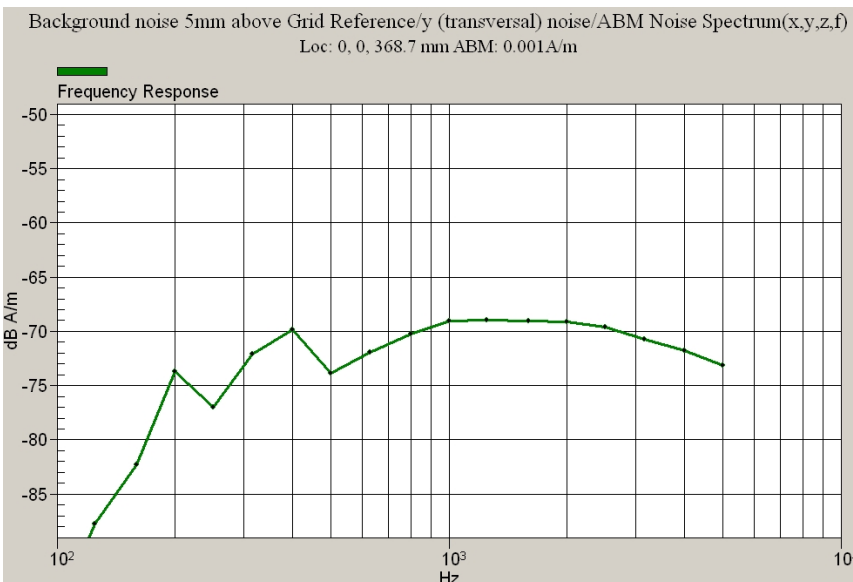

14 Appendix C: System Calibration Results

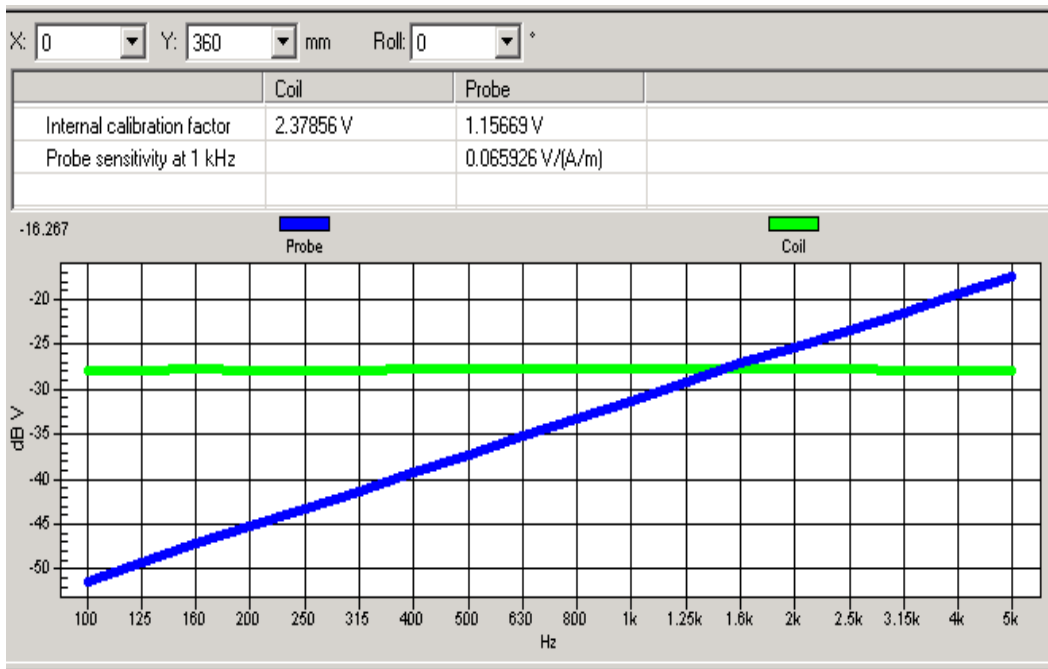

15 Appendix D: ABM and SNR Test Results/Plots

(See attachment)

16 Appendix E: HAC Photo Test Setup

(see Appendix 12D – HAC Photo Test Setup)