



# **Hearing Aid Compatibility (HAC) Test Report**

**In accordance with the requirements of ANSI-PC63.19**

**For**

**Dual-Band Tri-mode AMPS/CDMA Cellular Phone**

**Model: KX1**

**FCC ID: OVFKWC-KX1**

**Report Number: 05U3578-1B**

**Issue Date: November 1, 2005**

Prepared for

**Kyocera Wireless Corp.**

**10300 Campus Point Drive**

**San Diego, CA 92121**

**United States**

Prepared by

**Compliance Certification Services**

**561F Monterey Road**

**Morgan Hill, CA 95037**

**United States**

Revision History

Rev.	Issued date	Revisions	Revised By
A	8/18/05	Initial issue	MH
B	November 1, 2005	<ol style="list-style-type: none"><li>1. Re-evaluated probe modulation factor (PMF)</li><li>2. Re-evaluated HAC test data</li><li>3. Updated Attachments 2-1 &amp; 2-1 with contour plots without data cut.</li><li>4. Updated performance check parameters</li></ol>	HS

**HEARING AID COMPATIBILITY (HAC) CERTIFICATE**

Date of testing: July 27-28, 2005

FCC ID:	OVFKWC-KX1
Applicant:	Kyocera Wireless Corp.
Address:	10300 Campus Point Drive San Diego, CA 92121 United States
Application Type:	Class II Permissive Change (Adding HAC Rating)

Model:	KX1
Serial No.:	20-M4004-01B
TX Frequency:	824.7 – 848.31 MHz for CDMA Cellular Band 1851.25 – 1908.75 MHz for CDMA PCS Band
Max E-Field Emission:	@ channel 1013, 824.70 MHz = 84.1 V/m (Category M3)
Max H-Field Emission:	@ channel 1013, 824.70 MHz = 0.108 A/m (Category M4)

**Hearing Aid Near-Field Categories: Category M3**

This wireless portable device has been shown to be compatible with hearing aids under the above rated category, specified in ANSI/IEEE Std. PC63.19 and had been tested in accordance with the specified measurement procedures. Hearing Aid Compatibility is based on the assumption that all production units will be designed electrically identical to the device tested in this report.

Note: The results documented in this report apply only to the tested sample, under the conditions and modes of operation as described herein. This document may not be altered or revised in any way unless done so by Compliance Certification Services and all revisions are duly noted in the revisions section. Any alteration of this document not carried out by Compliance Certification Services will constitute fraud and shall nullify the document. No part of this report may be used to claim product certification, approval, or endorsement by any government agency.

Approved & Released For CCS By:

Tested By:

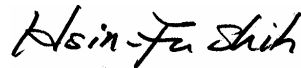
Mike Heckrotte  
Engineering Manager  
Compliance Certification Services

Hsin Fu Shih  
Senior Engineer  
Compliance Certification Services

Table of Contents

1. Facilities and Accreditation ..... 5

2. Equipment under Test (EUT) Description ..... 5

3. System Specifications ..... 6

4. Performance Test..... 8

5. Probe Modulation Factor ..... 10

6. RF Emissions Test Procedure ..... 15

7. Procedures Used to Establish Test Signal ..... 18

8. Summary of Results ..... 19

9. Test Equipment List..... 21

10. Measurement Uncertainty ..... 22

11. Attachment ..... 23

## 1. Facilities and Accreditation

The test sites and measurement facilities used to collect data are located at 561F Monterey Road, Morgan Hill, California, USA. The sites are constructed in conformance with the requirements of ANSI C63.4, ANSI C63.7 and CISPR Publication 22. All receiving equipment conforms to CISPR Publication 16-1, "Radio Interference Measuring Apparatus and Measurement Methods." The CCS test facilities are listed with the Federal Communications Commission.

No part of this report may be used to claim product certification, approval, or endorsement by any government agency.

## 2. Equipment under Test (EUT) Description

The wireless device is described as follows:

FCCID: OVFKWC-KX1

Model: KX1

Trade Name: Kyocera Wireless Corp

Product: This product is a slide telephone, Dual-Band Tri-mode AMPS/CDMA Cellular and CDMA PCS Band.

Type: Pre-production

Battery: Rechargeable Lithium ion Battery, model TXBAT10050, rating: 3.7 Vdc, 810 mAh. The battery was fully charged in accordance with manufacture's instructions prior to HAC measurements.



### 3. System Specifications

E-field and H-field measurements are performed using the DASY4 automated dosimetric assessment system. The DASY4 is made by Schmid & Partner Engineering AG (SPEAG) in Zurich, Switzerland.

The DASY4 HAC Extension consists of the following parts:

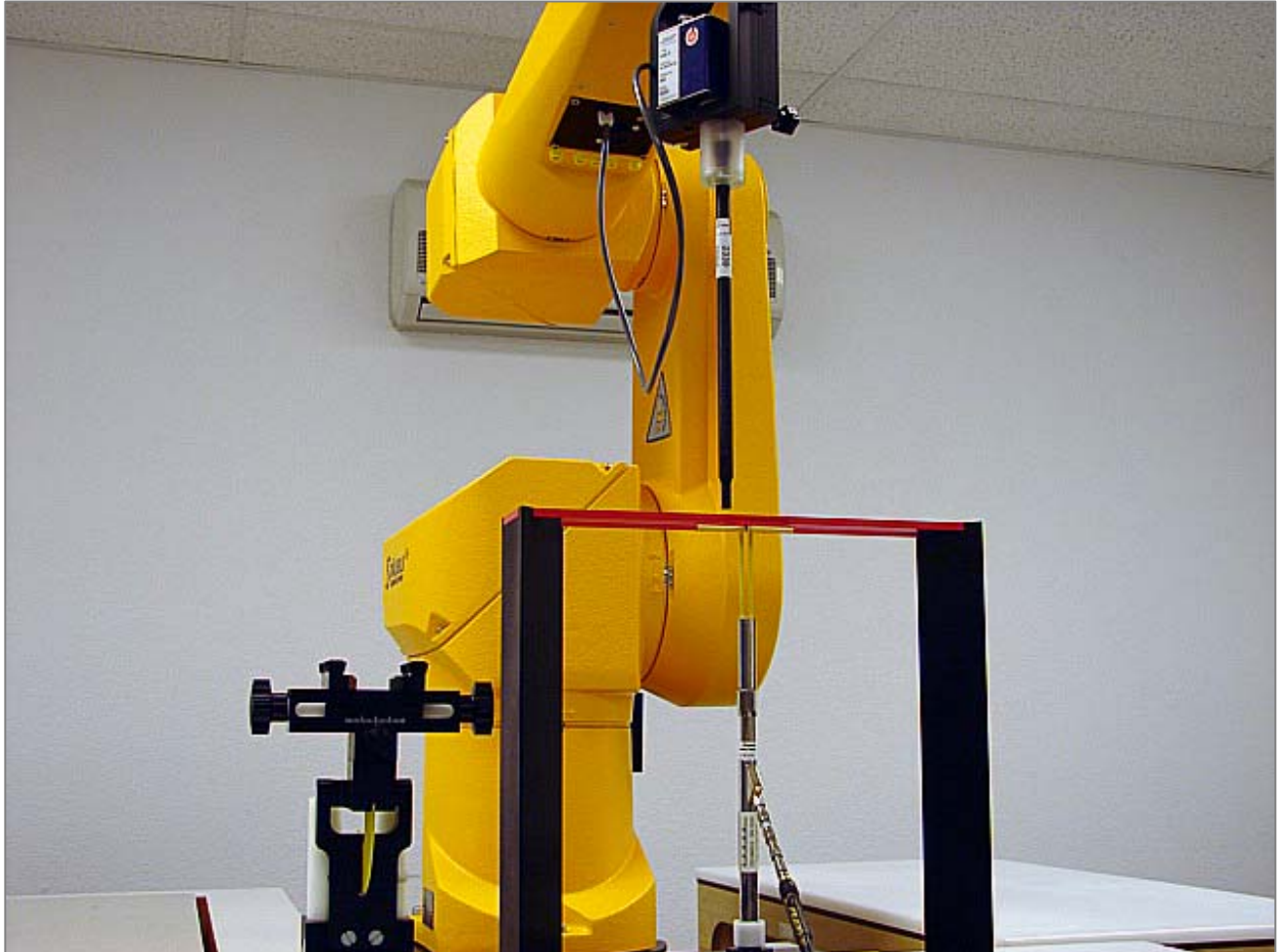

#### Test Arch phantom

The specially designed Test Arch allows high precision positioning of both the device and any of the validation dipoles.

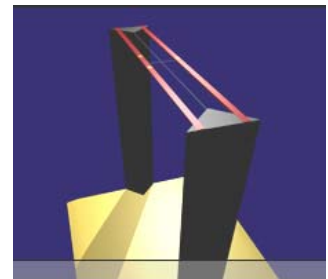

**ER3DV6 Isotropic E-Field Probe**

Construction:	One dipole parallel, two dipoles normal to probe axis Built-in shielding against static charges PEEK enclosure material (resistant to organic solvents, e.g., glycoether)
Calibration:	In air from 100 MHz to 3.0 GHz (absolute accuracy $\pm 6.0\%$ , $k=2$ )
Frequency:	100 MHz to > 6 GHz; Linearity: $\pm 0.2$ dB (100 MHz to 3 GHz)
Directivity:	$\pm 0.2$ dB in air (rotation around probe axis) $\pm 0.4$ dB in air (rotation normal to probe axis)
Dynamic Range:	2 V/m to > 1000 V/m; Linearity: $\pm 0.2$ dB
Dimensions:	Overall length: 330 mm (Tip: 16 mm) Tip diameter: 8 mm (Body: 12 mm) Distance from probe tip to dipole centers: 2.5 mm The closest part of the sensor element is 1.1 mm closer to the tip
Application:	General near-field measurements up to 6 GHz Field component measurements

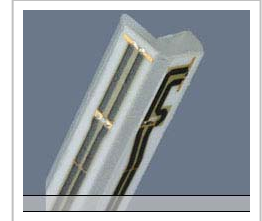
**H3DV6 3-Dimensional H-Field Probe**

Construction:	Three concentric loop sensors with 3.8 mm loop diameters resistively loaded detector diodes for linear response Built-in shielding against static charges PEEK enclosure material (resistant to organic solvents, e.g., glycoether)
Frequency:	200 MHz to 3 GHz (absolute accuracy $\pm 6.0\%$ , $k=2$ ); Output linearized
Directivity:	$\pm 0.25$ dB (spherical isotropy error)
Dynamic Range:	10 mA/m to 2 A/m at 1 GHz
E-Field Interference:	< 10% at 3 GHz (for plane wave)
Dimensions:	Overall length: 330 mm (Tip: 40 mm) Tip diameter: 6 mm (Body: 12 mm) Distance from probe tip to dipole centers: 3 mm The closest part of the sensor element is 1.9 mm closer to the tip
Application:	General magnetic near-field measurements up to 3 GHz Field component measurements Surface current measurements Measurements in air or liquids Low interaction with the measured field

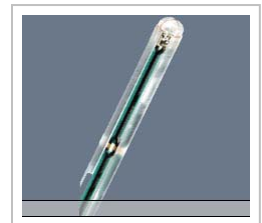

### 4. Performance Test

The test setup was validated when configured and prior to each test to ensure proper function. The procedure provided in this section is the validation procedure using dipole antennas for which the field levels were computed by FDTD modeling.

#### Performance Test Procedure

Place a dipole antenna meeting the requirements given in ANSI-PC63.19 in the position normally occupied by the WD. The dipole antenna serves as a known source for an electrical and magnetic output. Position the E-field and H-field probes so that:

Scan the length of the dipole with both E-field and H-field probes and record the maximum values for each. Compare the readings to expected values.

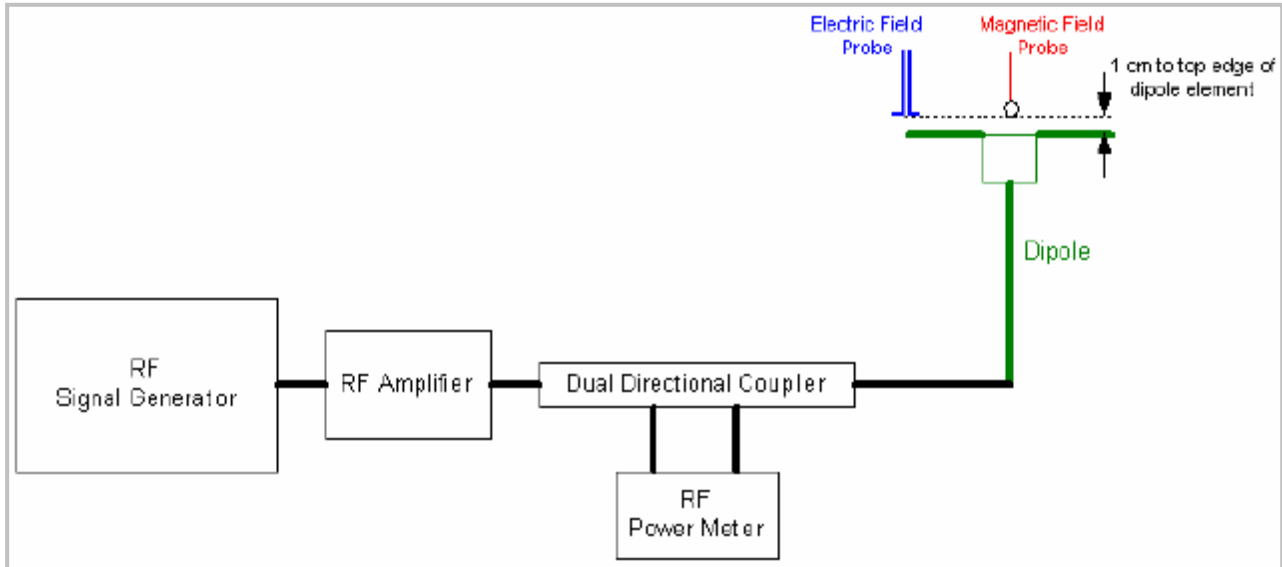

Figure 1

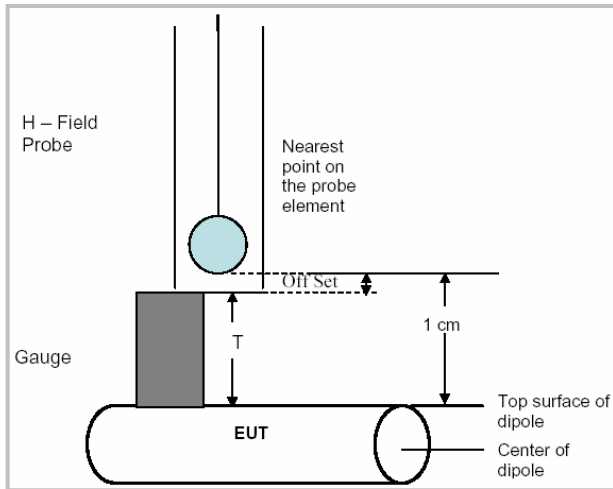

Figure 2

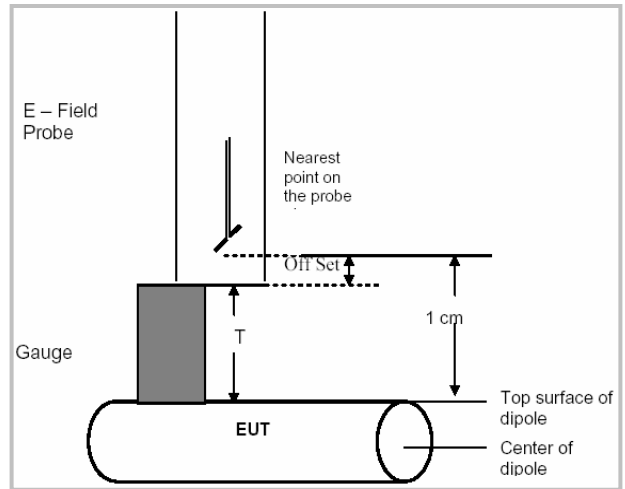

Figure 3

The probe is positioned over the illuminated dipole at 10 mm distance from the nearest point on the probe sensor element to the top surface (edge) of the dipole element.



**Performance Test Results**

Validation Dipoles CD835V3 SN: 1014 and CD1880V3 SN: 1010 with CW Signals

E-field Scan - Probe (ER3DV6 SN: 2339) center 10 mm above dipoles								
Signal Type	f (MHz)	Input Power (mW)	Power Drift (dB)	Max. measured from		Average max. above arm (V/m)	E-field Target Values (V/m) (From SPEAG)	Deviation <sup>1)</sup> (%)
				above high end (V/m)	above low end (V/m)			
CW	835	100	0.0356	183.0	181.10	182.05	163.3	11.48
CW	1880	100	-0.0209	138.8	137.10	137.95	136.7	0.91

H-field Scan - Probe (H3DV6 SN: 6157) center 10 mm above dipoles						
Signal Type	f (MHz)	Input Power (mW)	Power Drift (dB)	Measured H-field (A/m)	H-field Target Values (A/m) (From SPEAG)	Deviation <sup>1)</sup> (%)
CW	835	100	0.0152	0.469	0.446	5.16
CW	1880	100	0.0075	0.467	0.450	3.78

## Notes:

- 1) Delta (Deviation) % = 100 \* (Measured value minus Target value) divided by the Target value. Deltas within  $\pm 25\%$  are acceptable, of which 12% is deviation and 13% is measurement uncertainty.
- 2) The maximum E-field or H-field were evaluated and compared to the target values provided by SPEAG in the calibration certificate of specific dipoles.
- 3) Please refer to the attachment for detailed measurement data and plots.

## 5. Probe Modulation Factor

### Purpose

The HAC Standard requires measurement of the peak envelope E- and H-fields of the wireless device (WD). Para. 4.1.2.1, and C.3.1 of the standard describes the Probe Modulation Response Factor that shall be applied to convert the probe reading to Peak Envelope Field.

### Definitions

The Probe Modulation Factor (PMF) is defined as the ratio of the field readings for a CW and a modulated signal with the equivalent Field Envelope Peak as defined in the Standard (Chapter C.3.1).

### Evaluation Procedure for Unknown PMF (DASY4 Application note, Section 28.8)

The proposed measurement setup corresponds to the procedure as required in the Standard, Chapter C.3.1.

1. Install a calibration dipole for the appropriate frequency band under the Test Arch Phantom and select the proper phantom section according to the probe type installed (E- or H-field). Move the probe to the field reference point. (Do not move the probe between the subsequent CW and modulated measurements.)
2. Install the field probe in the setup.
3. The signal to the dipole must be monitored to record peak amplitude. Set a CW signal to the same level (e.g., with a directional coupler and a spectrum analyzer in zero span mode set to the operating frequency). (Resolution bandwidth > signal bandwidth; keep the same bandwidth and attenuation for CW and modulated signals.)
4. Define a DASY4 document and set the procedure properties (frequency, modulation frequency and crest factor) according to the measured signal. Define a multimeter job for the field reading.
5. Define a second procedure for the evaluation of the CW signal (frequency set as above, modulation frequency = 0, crest factor = 1) and a multimeter job.

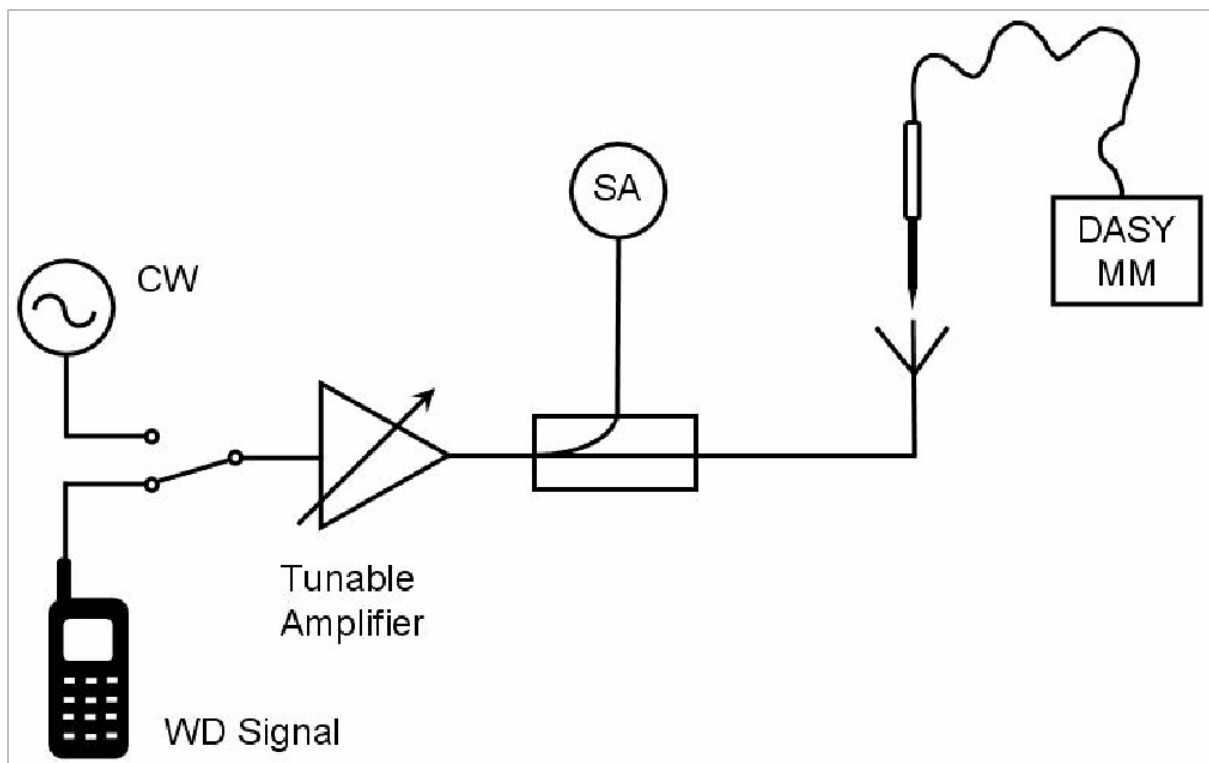

Figure 6 – PMF measurement setup

**The HAC measurement procedure is as follows:**

- a) Modulated signals (WD and 80% AM) measurement:
- 1) Connect the modulated signal using the appropriate frequency via the cable to the dipole.
  - 2) The signal to the dipole must be monitored to record peak amplitude with a directional coupler and a spectrum analyzer.
  - 3) Run the multimeter job in the procedure with the corresponding modulation setting in continuous mode.
  - 4) Read the envelope peak on the monitor in order to adjust the CW signal later to the same level.
- b) CW signal measurement:
- 1) Change the signal to CW at the same center frequency, without touching or moving the dipole and probe in the setup.
  - 2) Adjust the CW signal amplitude to the same peak level on the spectrum analyzer (keep the same bandwidth and attenuation for CW and modulated signals).
  - 3) Run the multimeter job in the CW procedure in continuous mode.
  - 4) Read the multimeter total field display and note it together with modulation type and frequency.
  - 5) Calculate the Probe Modulation Factor as the ratio between the CW multimeter field reading and the reading for the applicable modulation. I.e.,  $PMF = \frac{E_{cw}}{E_{mod}}$  and similar for H.

**Probe Modulation Factor (PMF)**

## E-Field

Frequency (MHz)	Type of signal	Input power (dBm)	Measured E-field V/m <sup>1)</sup>	PMF <sup>2)</sup>
835	WD	20	43.6	0.97
	80%AM		27.5	1.54
	CW		42.3	1.00
1880	WD	20	37.9	0.90
	80%AM		21.5	1.58
	CW		33.9	1.00

## H-Field

Frequency (MHz)	Type of signal	Input power (dBm)	Measured E-field V/m <sup>1)</sup>	PMF <sup>2)</sup>
835	WD	20	0.164	0.96
	80%AM		0.104	1.53
	CW		0.158	1.00
1880	WD	20	0.172	0.89
	80%AM		0.097	1.58
	CW		0.153	1.00

## Notes:

- 1) Total field reading from DASY4 Multimeter job.
- 2) PMF: Probe Modulation Factor

0 Span Analyzer Plots

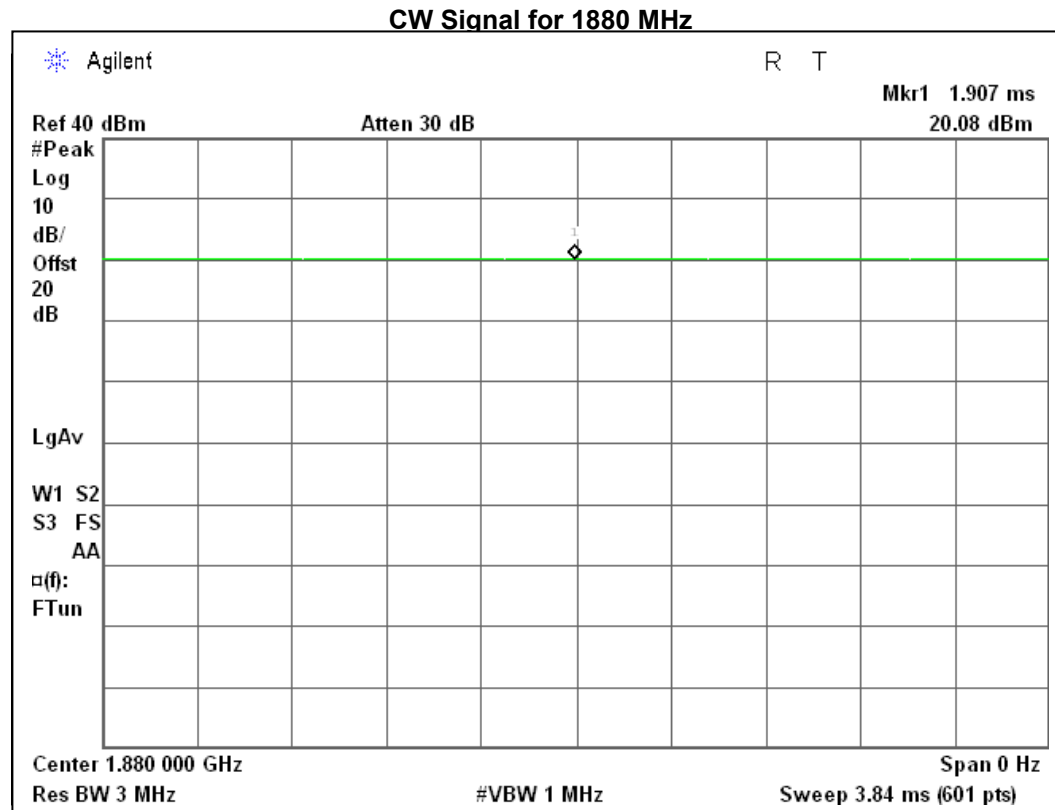
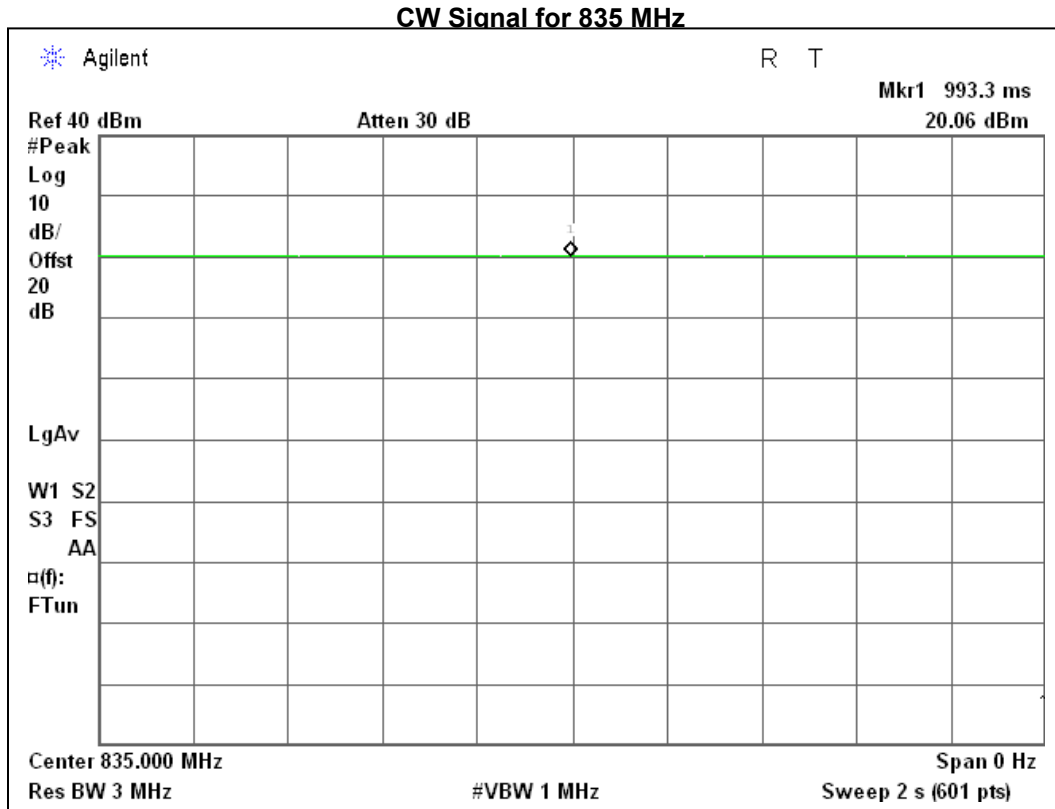

### WD Signal for 835 MHz

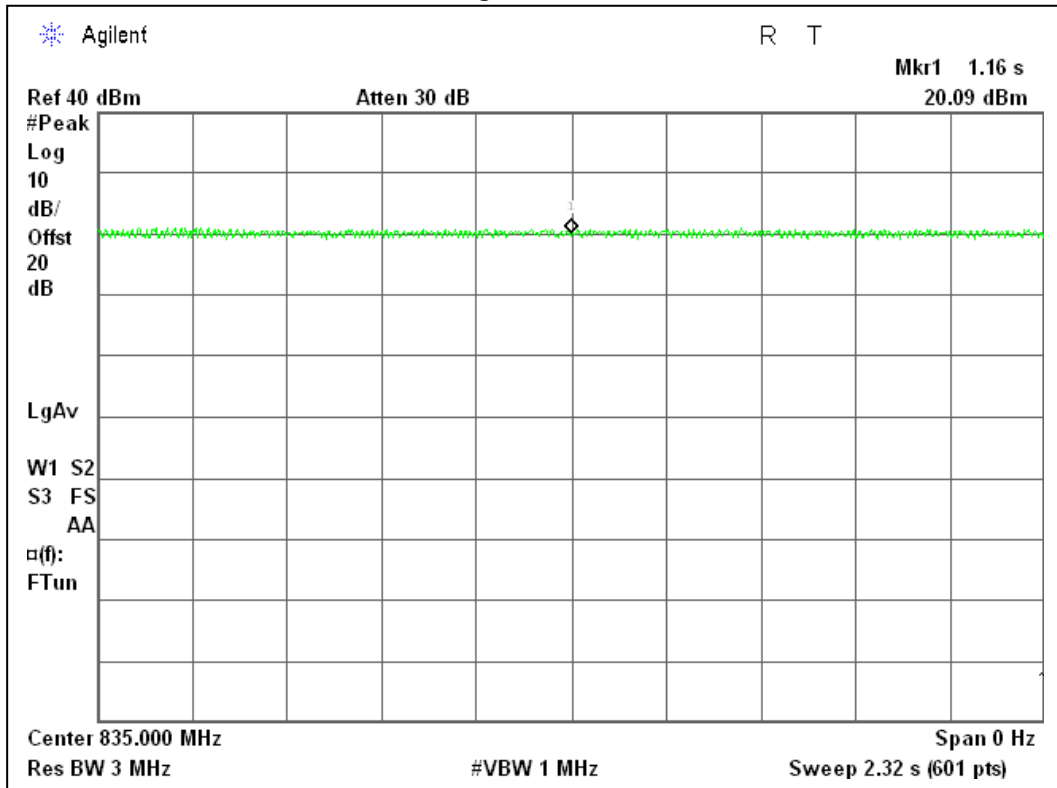

### WD Signal for 1880 MHz

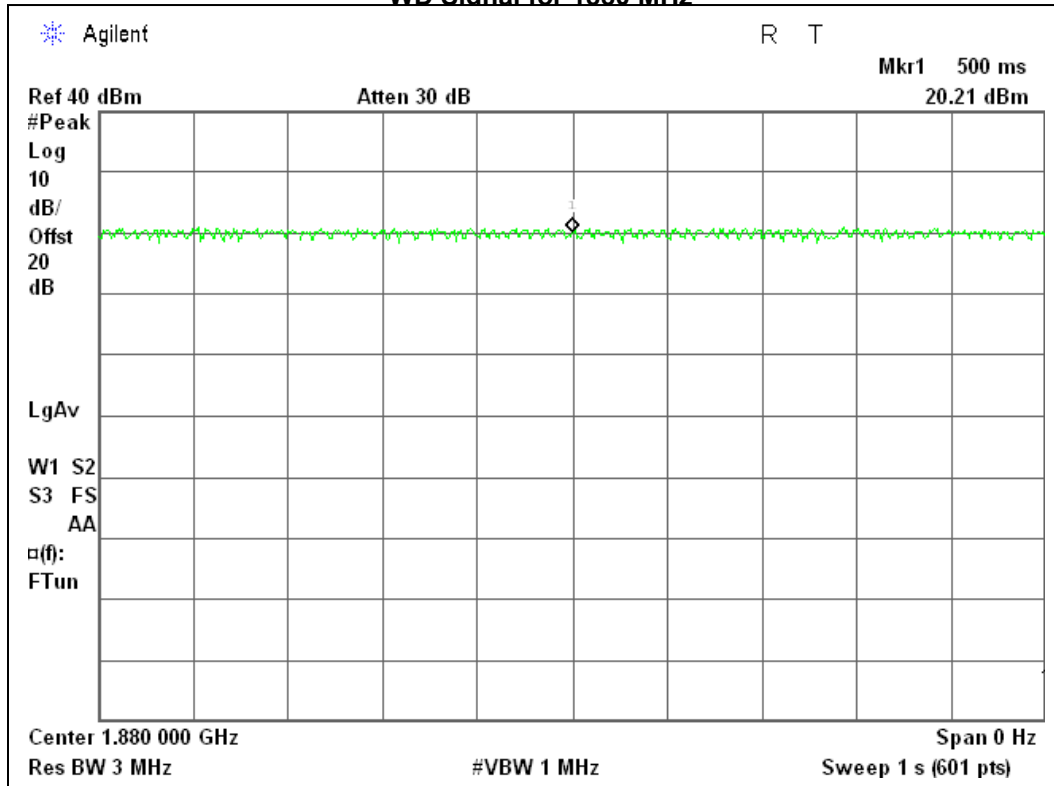

### 80% AM Signal for 835 MHz

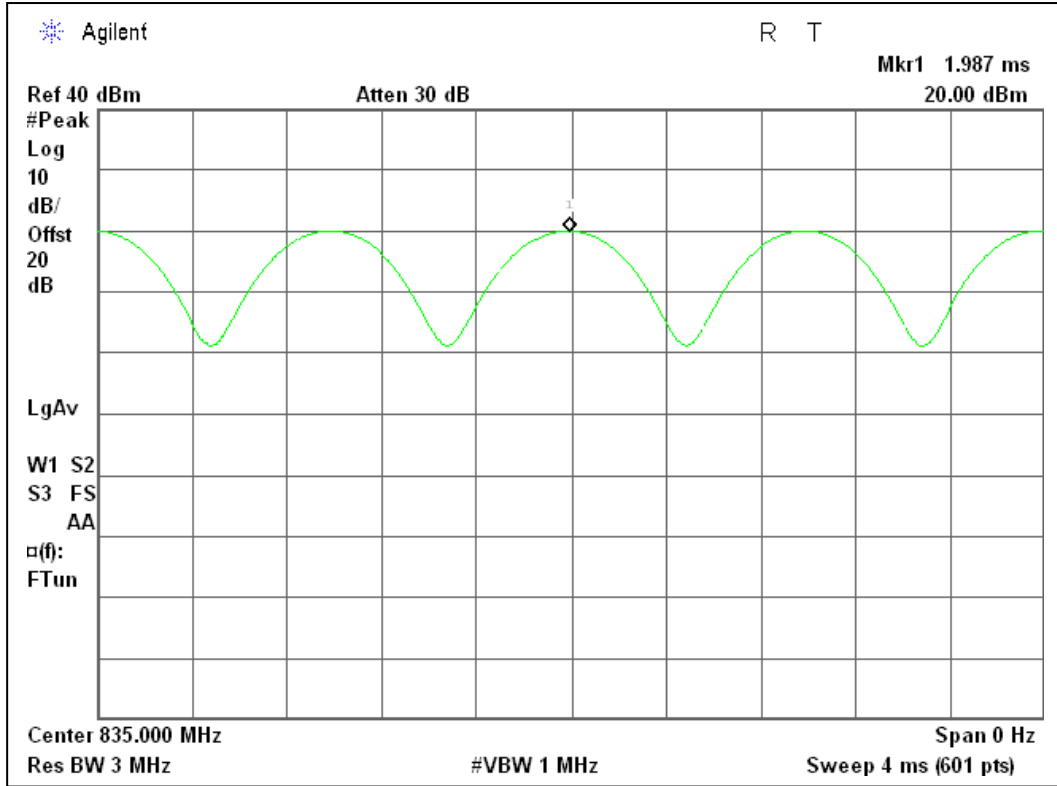

### 80% AM Signal for 1880 MHz

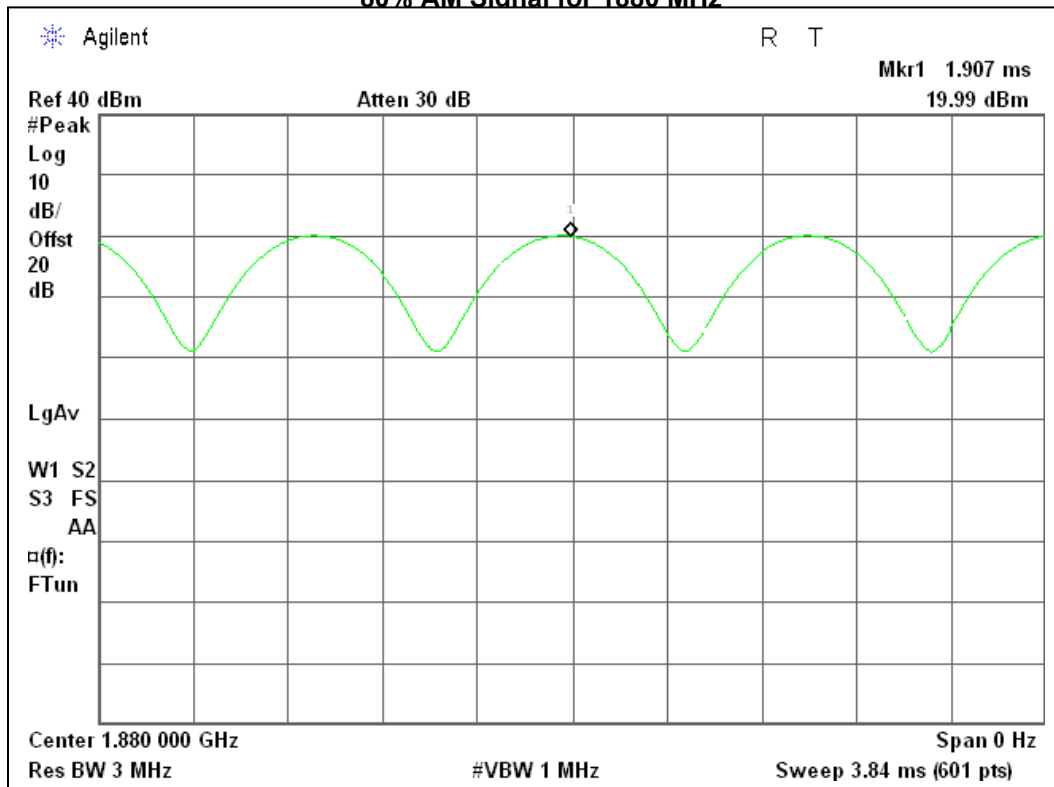

## 6. RF Emissions Test Procedure

Per ANSI-PC63.19-2005:

### Test Instructions

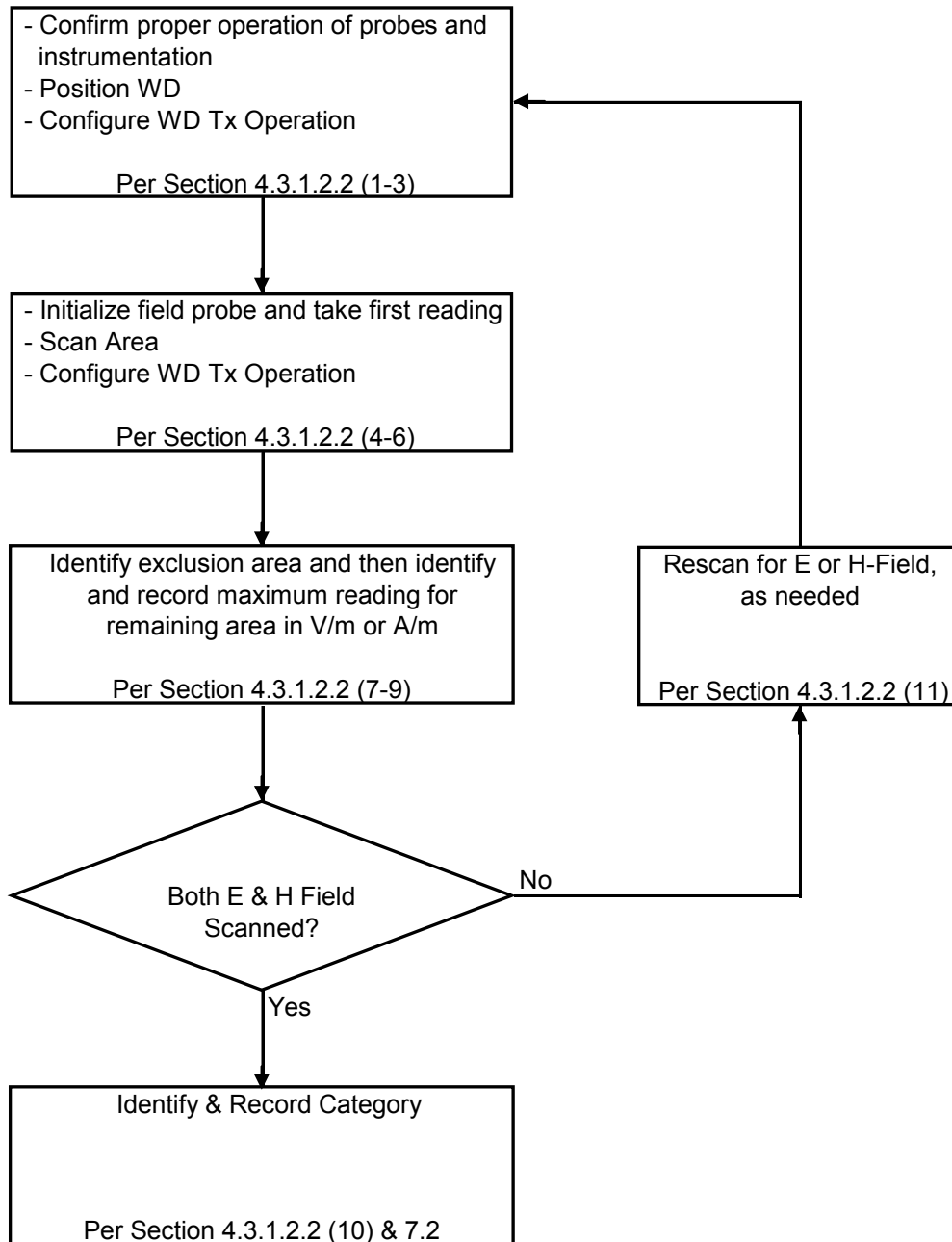

Figure 4 - WD near-field emission automated test flowchart

**RF Emissions Test Procedure:**

The following are step-by-step test procedures.

1. Confirm proper operation of the field probe, probe measurement system and other instrumentation and the positioning system.
2. Position the WD in its intended test position.
3. Configure the WD normal operation for maximum rated RF output power, at the desired channel and other operating parameters, (e.g. test mode) as intended for the test.
4. The center sub-grid shall be centered on the center of the WD output (acoustic or T-coil output), as appropriate. Locate the field probe at the initial test position in the 5 x 5 cm grid, which is contained in the measurement plane, see illustrated in Figure 5.
5. Record the reading.
6. Scan the entire 5 x 5 cm region in equally spaced increments and record the reading at each measurement point. The distance between measurement points shall be sufficient to assure the identification of the peak reading.
7. Identify the five contiguous sub-grids around the center sub-grid with the lowest maximum strength readings. Thus the 6 areas to be used to determine the WD's peak emissions are identified and outlined for the final manual scan. Please note that a maximum of five blocks can be excluded for both E- and H-field measurements for the WD output being measured. State another way, the center sub-grid and 3 other must be common to both the E- and H-field measurements.
8. Identify the highest field reading within the non-excluded sub-grids identified in step 7.
9. Convert the highest field reading within identified in step 8 to peak V/m or A/m, as appropriate.
10. Repeat steps 1-10 for both the E- and H-field measurements.
11. Compare this reading to the categories in ANSI-PC63.19 and record the resulting category. The lowest category number listed in ANSI-PC63.19 obtained in step 10 for either E or H field determines the M category for the audio coupling mode assessment. Record the WD category rating.

**Near Field Compliance Criteria (Per ANSI-PC63.19-2005)**

The EUT must meet the following M3 or M4 category:

Category	AWF (dB)	Limits for E-Field Emissions (V/m)	Limits for H-Field Emissions (A/m)
M1	0	199.5 - 354.8	0.6 - 1.07
	-5	149.6 - 266.1	0.45 - 0.8
M2	0	112.2 - 199.5	0.34 - 0.6
	-5	84.1 - 149.6	0.25 - 0.45
M3	0	<b>63.1 - 112.2</b>	<b>0.19 - 0.34</b>
	-5	<b>47.3 - 84.1</b>	<b>0.15 - 0.25</b>
M4	0	<b>&lt;63.1</b>	<b>&lt;0.19</b>
	-5	<b>&lt;47.3</b>	<b>&lt;0.15</b>

Telephone Near-field Categories in Linear Units.



**WD RF Emission Measurements Reference and Plane**

Figure 5 illustrate the references and reference plane that shall be used in the WD emissions

- The grid is 5 cm by 5 cm area that is divided into 9 evenly sized blocks or sub-grids.
- The grid is centered on the audio frequency output transducer of the WD (speaker or T-coil).
- The grid is in a reference plane, which is defined as the planar area that contains the highest point in the area of the phone that normally rests against the user’s ear. It is parallel to the centerline of the receiver area of the phone and is defined by the points of the receiver-end of the WD handset, which, in normal handset use, rest against the ear.
- The measurement plane is parallel to, and 1.0 cm in front of, the reference plane.

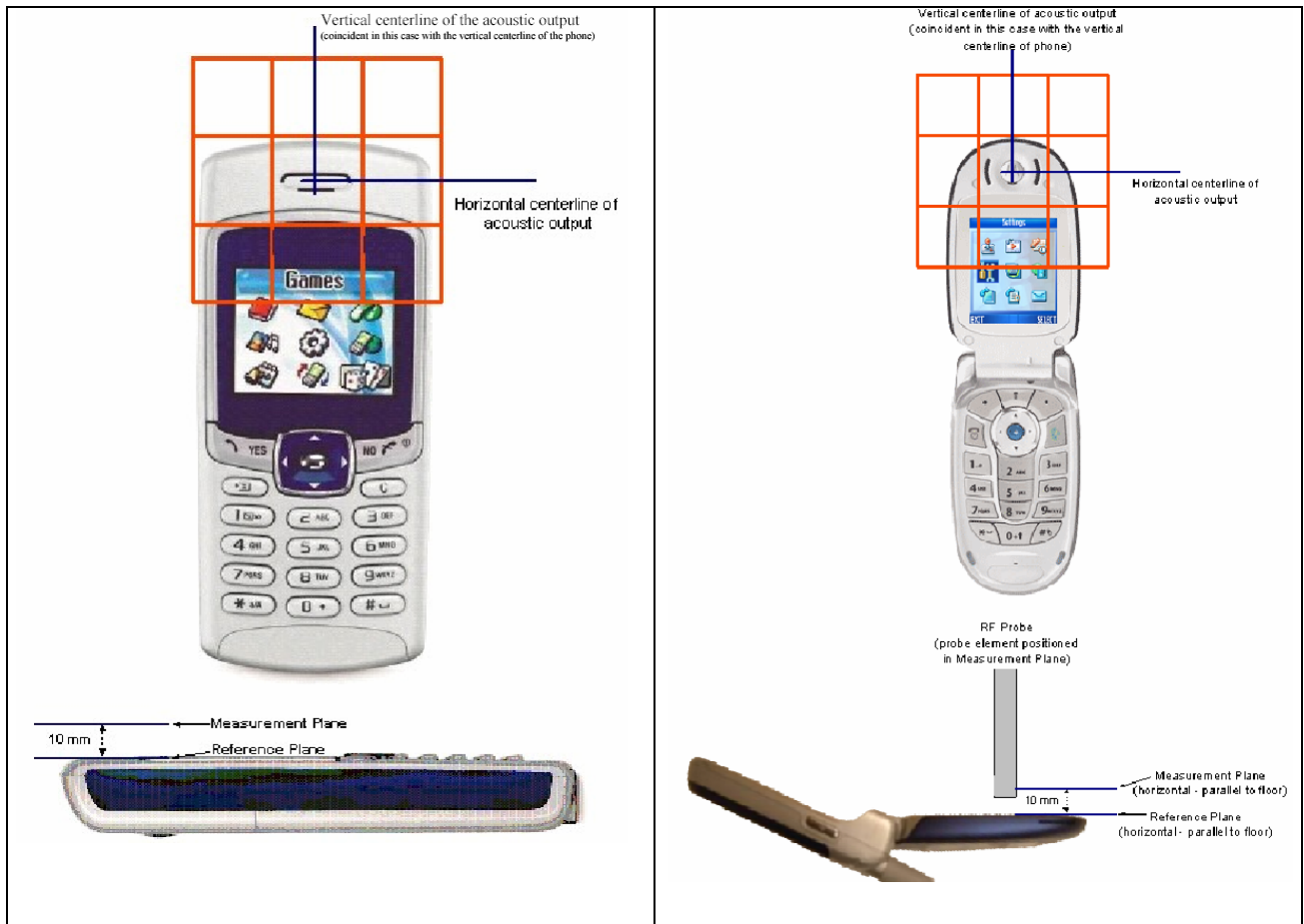

Figure 5 - WD reference and plane for RF emission measurements

## 7. Procedures Used to Establish Test Signal

The following settings were used to configure the Wireless Communications Test Set, Agilent 8960 Series 10 E5515C. The Wireless Communications Test Set was set as follows to establish maximum power from the EUT:



Call Params	Cell band	
	US Cellular	US PCS
Operation mode	Active Cell	Active Cell
Protocol Rev	6 (IS-2000-0)	6 (IS-2000-0)
Radio Config (RC)	(Fwd3, Rvs3)	(Fwd3, Rvs3)
FCH Service Option (SO)	SO55 (Loopback)	SO55 (Loopback)
Rvs Power Ctrl	All Up Bits	All Up Bits
Power Ctrl Size	1.0 dBm	1.0 dBm
Traffic Dada Rate	Full	Full
Rcvr Power Ctrl	Manual	Manual
Meas Frequency	Auto	Auto
Voice SO Mode	Voice Echo	Voice Echo
Echo Delay	Medium	Medium

## 8. Summary of Results

### CDMA Cellular band

Table below shows the results of the near electric (E-Field) and magnetic (H-Field) fields generated by wireless communications devices (WD). The worst case result is highlighted.

<b>Model: KX1</b>								
<b>E-Field Emission Test</b>								
Operating Mode	Channel	f (MHz)	Conducted Power (dBm)	Power drift (dB)	Backlight	AWF	Measured E-field Emissions (V/m)	Category M-Rating
CDMA Cellular Band	1013	824.70	25.09	-0.092	on	0	<b>84.10</b>	M3
	383	836.49	25.12	0.104	on	0	78.80	M3
	777	848.31	25.10	-0.171	on	0	74.30	M3
CDMA Cellular Band	1013	824.70	25.10	0.040	off	0	83.20	M3
	383	836.49	25.12	-0.034	off	0	75.90	M3
	777	848.31	25.10	-0.094	off	0	73.50	M3
<b>H-Field Emission Test</b>								
Operating Mode	Channel	f (MHz)	Conducted Power (dBm)	Power drift (dB)	Backlight	AWF	Measured E-field Emissions (A/m)	Category M-Rating
CDMA Cellular Band	1013	824.70	25.09	0.041	on	0	0.107	M4
	383	836.49	25.12	-0.070	on	0	0.103	M4
	777	848.31	25.10	-0.260	on	0	0.101	M4
CDMA Cellular Band	1013	824.70	25.10	-0.011	off	0	<b>0.108</b>	M4
	383	836.49	25.12	0.044	off	0	0.102	M4
	777	848.31	25.10	0.002	off	0	0.104	M4
<b>Overall M-Rating:</b>								<b>M3</b>

**CDMA PCS band**

Table below shows the results of the near electric (E-Field) and magnetic (H-Field) fields generated by wireless communications devices (WD). The worst case result is highlighted.

<b>Model: KX1</b>								
<b>E-Field Emission Test</b>								
Operating Mode	Channel	f (MHz)	Conducted Power (dBm)	Power drift (dB)	Backlight	AWF	Measured E-field Emissions (V/m)	Category M-Rating
CDMA PCS Band	25	1851.25	23.80	-0.037	on	0	44.70	M4
	600	1880	23.16	0.090	on	0	44.00	M4
	1175	1908.75	23.50	-0.183	on	0	39.30	M4
CDMA PCS Band	25	1851.25	23.80	0.042	off	0	44.10	M4
	600	1880	23.16	-0.044	off	0	43.70	M4
	1175	1908.75	23.50	0.069	off	0	40.30	M4
<b>H-Field Emission Test</b>								
Operating Mode	Channel	f (MHz)	Conducted Power (dBm)	Power drift (dB)	Backlight	AWF	Measured E-field Emissions (A/m)	Category M-Rating
CDMA PCS Band	25	1851.25	23.80	0.122	on	0	0.074	M4
	600	1880	23.16	0.143	on	0	0.081	M4
	1175	1908.75	23.50	-0.054	on	0	0.079	M4
CDMA PCS Band	25	1851.25	23.80	0.185	off	0	0.075	M4
	600	1880	23.16	0.113	off	0	0.084	M4
	1175	1908.75	23.50	0.003	off	0	0.081	M4
<b>Overall M-Rating:</b>								<b>M4</b>



## 9. Test Equipment List

<u>Name of Equipment</u>	<u>Manufacturer</u>	<u>Type/Model</u>	<u>Serial Number</u>	<u>Cal. Due date</u>
Robot - Six Axes	Stäubli	RX90BL	N/A	N/A
Robot Remote Control	Stäubli	CS7MB	3403-91535	N/A
DASY4 Measurement Server	SPEAG	SEUMS001BA	1041	N/A
Probe Alignment Unit	SPEAG	LB (V2)	261	N/A
Data Acquisition Electronics	SPEAG	DAE3 V1	500	2/7/06
E-Field Probe	SPEAG	ER3DV6	2339	3/11/06
H-Field Probe	SPEAG	H3DV6	6157	3/11/06
Calibration Dipole	SPEAG	CD1880V3	1014	2/23/07
Calibration Dipole	SPEAG	CD835V3	1014	2/24/07
Signal Generator	R&H	SMP 04	DE34210	6/2/06
Signal Generator	HP	8648C	3623A03025	7/5/06
Power Meter	Giga-tronics	8651A	8651404	12/17/06
Power Sensor	Giga-tronics	80701A	1834588	12/17/06
Amplifier	Mini-Circuits	ZHL-42W	D072701-5	N/A
Radio Communication Tester	R & S	CMU 200	838114/032	12/17/06
Wireless Communication Test Set	Agilent	E5515C	GB44051333	5/5/06

## 10. Measurement Uncertainty

HAC Uncertainty Budget According to ANSI PC63.19							
Error Description	Uncertainty value (±%)	Probe Dist.	Div.	(Ci) E	(Ci) H	Std. Unc.(±%)	
						E	H
<b>Measurement System</b>							
Probe Calibration	5.10	N	1	1	1	5.1	5.1
Axial Isotropy	4.70	R	1.732	1	1	2.7	2.7
Sensor Displacement	16.50	R	1.732	1	0.145	9.5	1.4
Boundary Effects	2.40	R	1.732	1	1	1.4	1.4
Linearity	4.70	R	1.732	1	1	2.7	2.7
Scaling to Peak Envelope Power	2.00	R	1.732	1	1	1.2	1.2
System Detection Limit	1.00	R	1.732	1	1	0.6	0.6
Readout Electronics	0.30	N	1	1	1	0.3	0.3
Response Time	0.80	R	1.732	1	1	0.5	0.5
Integration Time	2.60	R	1.732	1	1	1.5	1.5
RF Ambient Conditions	3.00	R	1.732	1	1	1.7	1.7
RF Reflections	12.00	R	1.732	1	1	6.9	6.9
Probe Positioner	1.20	R	1.732	1	0.67	0.7	0.5
Probe Positioning	4.70	R	1.732	1	0.67	2.7	1.8
Extrapolation and Interpolation	1.00	R	1.732	1	1	0.6	0.6
<b>Test sample Related</b>							
Test Positioning Vertical	4.70	R	1.732	1	0.67	2.7	1.8
Test Positioning Lateral	1.00	R	1.732	1	1	0.6	0.6
Device Holder and Phantom	2.40	R	1.732	1	1	1.4	1.4
Power Drift	5.00	R	1.732	1	1	2.9	2.9
<b>Phantom and Setup Related</b>							
Phantom Thickness	2.40	R	1.732	1	0.67	1.4	0.9
Combined Std. Uncertainty						14.7	10.9
<b>Expanded Std. Uncertainty on Power</b>						<b>29.4</b>	<b>21.8</b>
<b>Expanded Std. Uncertainty on Field</b>						<b>14.7</b>	<b>10.9</b>
Notes for table							
1. N - Nomal							
2. R - Rectangular							
3. Div. - Divisor used to obtain standard uncertainty							
4. Ci - is te sensitivity coefficient							

Table above Worst-Case uncertainty budget for HAC free field assessment according to ANSIC63.19. The budget is valid for the frequency range 800 MHz - 3 GHz and represents a worstcase analysis. For specific tests and configurations, the uncertainty could be considerably smaller. Some of the parameters are dependent on the user situations and need adjustment according to the actual laboratory conditions.

**11. Attachment**

No.	Contents	No. of page (s)
1	Validation Dipole Check Data	8
2-1	HAC_E-Scan test data	24
2-2	HAC_H-Scan test data	24
3	Certificate of E-filed Probe ER3DV6 SN 2339	9
4	Certificate of H-filed Probe H3DV6 SN 6157	8
5	Certificate of Validation Dipole CD835V3 SN 1014	6
6	Certificate of System Validation Dipole CD1880V3 SN 1010	6

**END OF REPORT**