



Hearing Aid Compatibility (HAC) Test Report

In accordance with the requirements of ANSI-PC63.19

For

Dual-Band Tri-mode AMPS/CDMA Cellular Phone

Model: KX1

FCC ID: OVFKWC-KX1

Report Number: 05U3578-1

Issue Date: August 18, 2005

Prepared for

Kyocera Wireless Corp.

10300 Campus Point Drive

San Diego, CA 92121

United States

Prepared by

Compliance Certification Services

561F Monterey Road

Morgan Hill, CA 95037

United States

Revision History

<u>Rev.</u>	<u>Issued date</u>	<u>Revisions</u>	<u>Revised By</u>
A	8/18/05	Initial issue	MH

HEARING AID COMPATIBILITY (HAC) CERTIFICATE

Date of testing: July 27-28, 2005

FCC ID:	OVFKWC-KX1
Applicant:	Kyocera Wireless Corp.
Address:	10300 Campus Point Drive San Diego, CA 92121 United States
Application Type:	Class II Permissive Change (Adding HAC Rating)

Model:	KX91
Serial No.:	20-M4004-01B
TX Frequency:	824.7 – 848.31 MHz for CDMA Cellular Band 1851.25 – 1908.75 MHz for CDMA PCS Band
Max E-Field Emission:	@ channel 1013, 824.70 MHz = 97.1 V/m (Category M3)
Max H-Field Emission:	@ channel 1013, 824.70 MHz = 0.120 A/m (Category M4)

Hearing Aid Near-Field Categories: Category M3

This wireless portable device has been shown to be compatible with hearing aids under the above rated category, specified in ANSI/IEEE Std. PC63.19 and had been tested in accordance with the specified measurement procedures. Hearing Aid Compatibility is based on the assumption that all production units will be designed electrically identical to the device tested in this report.

Note: The results documented in this report apply only to the tested sample, under the conditions and modes of operation as described herein. This document may not be altered or revised in any way unless done so by Compliance Certification Services and all revisions are duly noted in the revisions section. Any alteration of this document not carried out by Compliance Certification Services will constitute fraud and shall nullify the document. No part of this report may be used to claim product certification, approval, or endorsement by any government agency.

Approved & Released For CCS By:



Mike Heckrotte
Engineering Manager
Compliance Certification Services

Tested By:

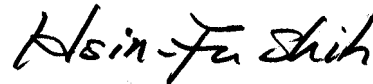

Hsin Fu Shih
Senior Engineer
Compliance Certification Services

Table of Contents

1. Facilities and Accreditation5

2. Equipment Under Test (EUT) Description5

3. System Specifications6

4. Validation Dipole Check8

5. Probe Modulation Factor10

6. RF Emissions Test Procedure.....11

7. Procedures Used to Establish Test Signal14

8. Summary of Results15

9. Test Equipment List17

10. Measurement Uncertainty18

11. Attachment.....19

1. Facilities and Accreditation

The test sites and measurement facilities used to collect data are located at 561F Monterey Road, Morgan Hill, California, USA. The sites are constructed in conformance with the requirements of ANSI C63.4, ANSI C63.7 and CISPR Publication 22. All receiving equipment conforms to CISPR Publication 16-1, "Radio Interference Measuring Apparatus and Measurement Methods." The CCS test facilities are listed with the Federal Communications Commission.

No part of this report may be used to claim product certification, approval, or endorsement by any government agency.

2. Equipment under Test (EUT) Description

The wireless device is described as follows:

FCCID: OVFKWC-KX1

Model: KX1

Trade Name: Kyocera Wireless Corp

Product: This product is a slide telephone, Dual-Band Tri-mode AMPS/CDMA Cellular and CDMA PCS Band.

Type: Pre-production

Battery: Rechargeable Lithium ion Battery, model TXBAT10050, rating: 3.7 Vdc, 810 mAh. The battery was fully charged in accordance with manufacture's instructions prior to HAC measurements.



3. System Specifications

E-field and H-field measurements are performed using the DASY4 automated dosimetric assessment system. The DASY4 is made by Schmid & Partner Engineering AG (SPEAG) in Zurich, Switzerland.

The DASY4 HAC Extension consists of the following parts:

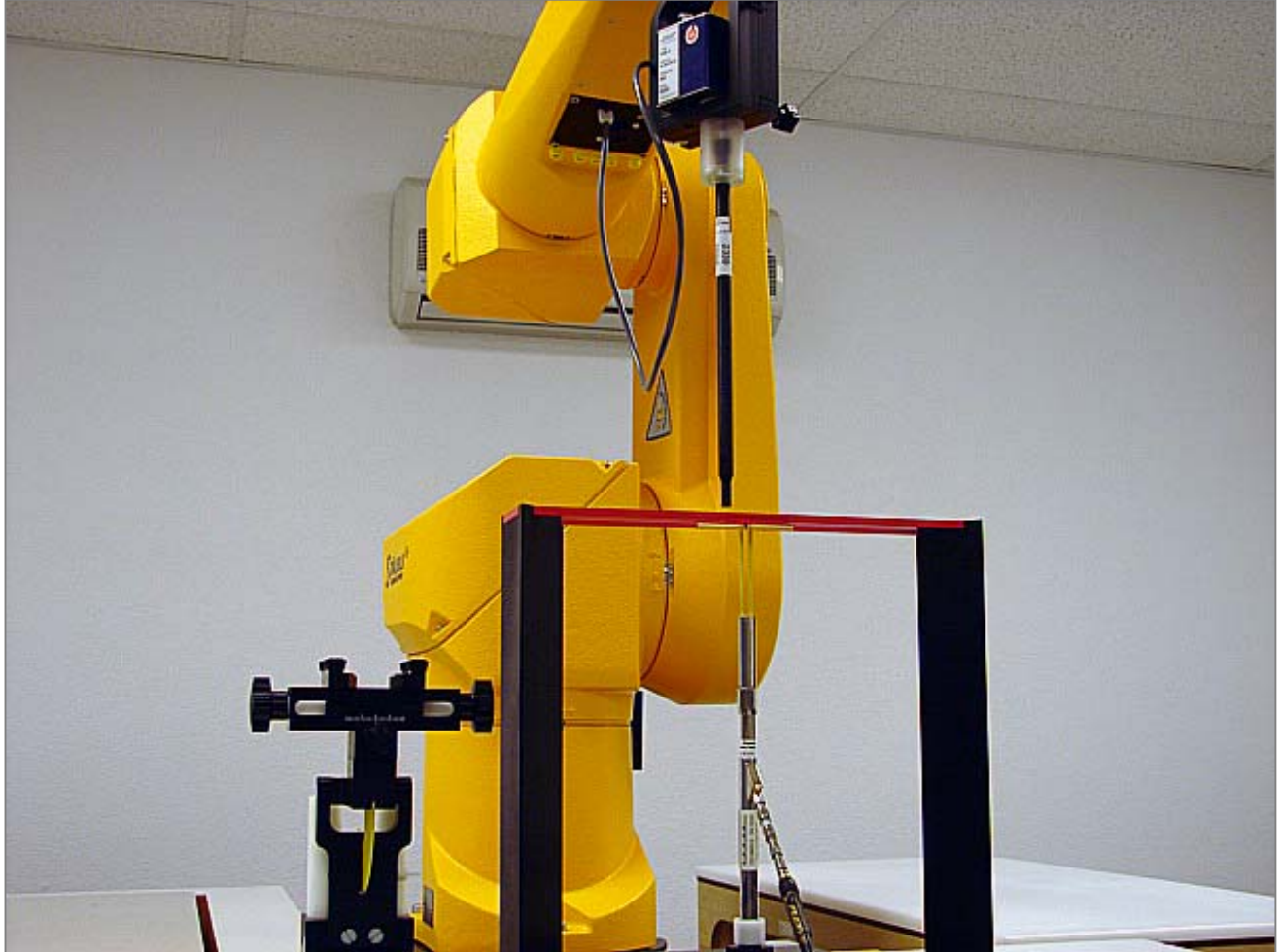

Test Arch phantom

The specially designed Test Arch allows high precision positioning of both the device and any of the validation dipoles.

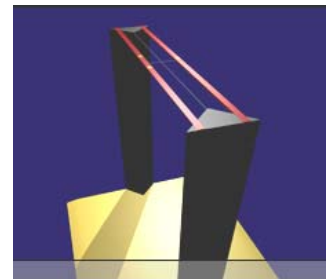

ER3DV6 Isotropic E-Field Probe

Construction:	One dipole parallel, two dipoles normal to probe axis Built-in shielding against static charges PEEK enclosure material (resistant to organic solvents, e.g., glycoether)
Calibration:	In air from 100 MHz to 3.0 GHz (absolute accuracy $\pm 6.0\%$, $k=2$)
Frequency:	100 MHz to > 6 GHz; Linearity: ± 0.2 dB (100 MHz to 3 GHz)
Directivity:	± 0.2 dB in air (rotation around probe axis) ± 0.4 dB in air (rotation normal to probe axis)
Dynamic Range:	2 V/m to > 1000 V/m; Linearity: ± 0.2 dB
Dimensions:	Overall length: 330 mm (Tip: 16 mm) Tip diameter: 8 mm (Body: 12 mm) Distance from probe tip to dipole centers: 2.5 mm The closest part of the sensor element is 1.1 mm closer to the tip
Application:	General near-field measurements up to 6 GHz Field component measurements

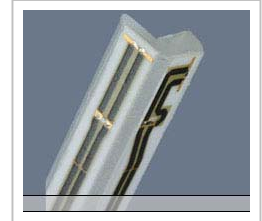
**H3DV6 3-Dimensional H-Field Probe**

Construction:	Three concentric loop sensors with 3.8 mm loop diameters resistively loaded detector diodes for linear response Built-in shielding against static charges PEEK enclosure material (resistant to organic solvents, e.g., glycoether)
Frequency:	200 MHz to 3 GHz (absolute accuracy $\pm 6.0\%$, $k=2$); Output linearized
Directivity:	± 0.25 dB (spherical isotropy error)
Dynamic Range:	10 mA/m to 2 A/m at 1 GHz
E-Field Interference:	< 10% at 3 GHz (for plane wave)
Dimensions:	Overall length: 330 mm (Tip: 40 mm) Tip diameter: 6 mm (Body: 12 mm) Distance from probe tip to dipole centers: 3 mm The closest part of the sensor element is 1.9 mm closer to the tip
Application:	General magnetic near-field measurements up to 3 GHz Field component measurements Surface current measurements Measurements in air or liquids Low interaction with the measured field

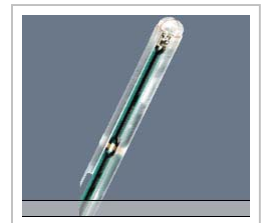

4. Validation Dipole Check

The test setup was validated when confabulated and verified periodically thereafter to ensure proper function. The procedure provided in this section is a validation procedure using dipole antennas for which the field levels were computed by FDTD modeling.

Validation Dipole Check Procedure

Place a dipole antenna meeting the requirements given in ANSI-PC63.19 in the normally occupied by the WD. The dipole antenna serves as a known source for an electrical and magnetic output. Position the E-field and H-field probes so that:

Scan the length of the dipole with both E-field and H-field probes and record the maximum values for each. Compare the readings to expected values.

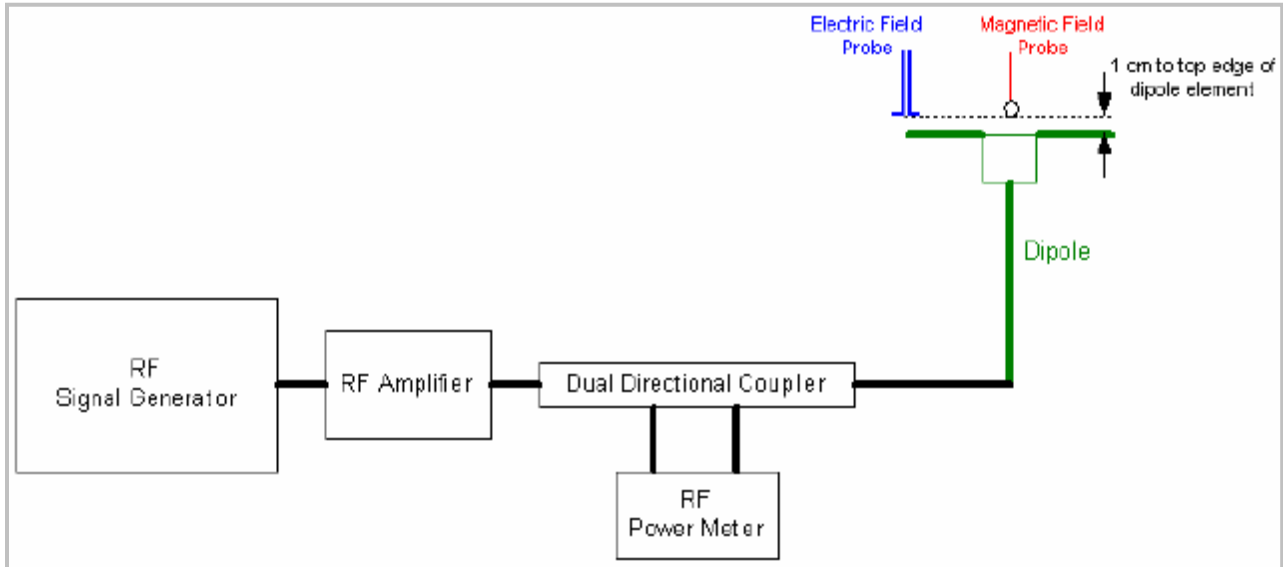

Figure 1

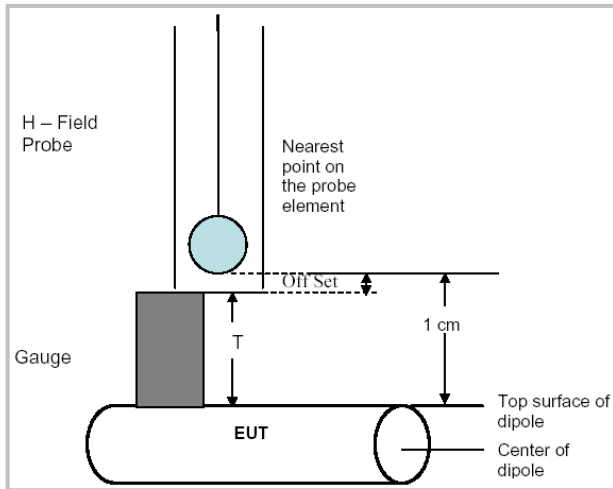

Figure 2

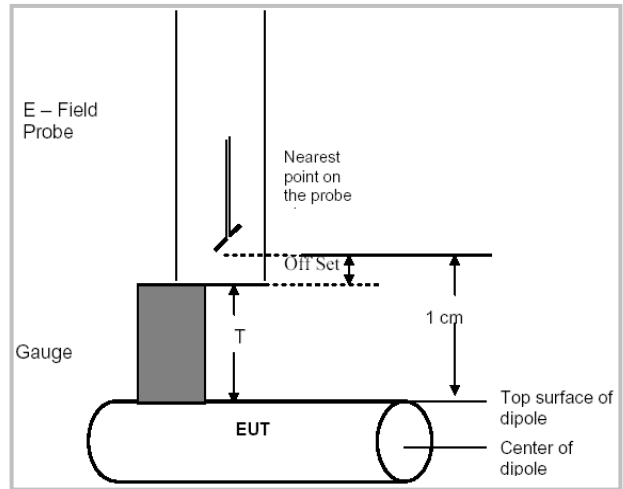

Figure 3

The probe is positioned over the illuminated dipole at 10 mm distance from the nearest point on the probe sensor element to the top surface (edge) of the dipole element.

Validation Dipole Check Results

Validation Dipoles CD835V3 SN: 1014 and CD1880V3 SN: 1010 with CW Signals

E-field Scan - Probe (ER3DV6 SN: 2339) center 10 mm above dipole							
Signal Type	f (MHz)	Input Power (mW)	Power Drift (dB)	Measured		E-field Calculated Peak (V/m) [ANSI-PC63.19]	Deviation ¹⁾ (%)
				E-field (V/m)	E-field ²⁾ Peak (V/m)		
CW	835	100	0.0356	183.0	258.80	265	-2.34
CW	1880	100	-0.0209	138.8	196.29	211	-6.97

H-field Scan- Probe (H3DV6 SN: 6157) center 10 mm above dipole							
Signal Type	f (MHz)	Input Power (mW)	Power Drift (dB)	Measured		H-field Calculated Peak (A/m) [ANSI-PC63.19]	Deviation ¹⁾ (%)
				H-field (A/m)	H-field ²⁾ Peak (A/m)		
CW	835	100	0.0152	0.469	0.663	0.673	-1.45
CW	1880	100	0.0075	0.467	0.660	0.645	2.39

Notes:

- 1) Delta (Deviation) % = 100 * (Measured Peak minus Calculated) divided by Calculated. Values within $\pm 25\%$ are acceptable, of which 12% is deviation and 13% is measurement uncertainty. Values independently validated for the dipole actually used in the measurements should be used, when available.
- 2) The antenna was scanned over the appropriate size area to cover the dipole from end to end. Field strength measurements were made when the probe is stationary. Since the dipole was calibrated to RMS values, the final result was multiplied by the inverse RMS factor of $\sqrt{2}$ to compare with the mathematical targets in ANSI-PC63.19.
- 3) Please refer to the attachment for detailed measurement data and plots.

5. Probe Modulation Factor

In consideration of the measurement probes' responses to the RF power envelope employed by the WD, a probe modulation conversion factor must be applied to the E- and H-field probe readings from many typical probes used for these measurements, in order to accurately determine the field strength. The procedure to determine RF modulation response is provided in ANSI-PC63.19 Section C.3.1.

A calibration was made of the modulation response of the probe and its instrumentation chain. This calibration was performed with the field probe, attached to its instrumentation. The response of the probe system to a CW field at the frequency of interest is compared to its response to a modulated signal with equal peak amplitude. The field level of the test signals was more than 10 dB above the ambient level and the noise floor of the instrumentation being used. The ratio of the CW reading to that taken with a modulated reading was applied to the EUT measurement.

This was done using the following procedure:

1. Fixing the probe in a set location relative to a field generating device, such as a reference dipole antenna, as illustrated in Figure 6.
2. Illuminate the probe with a CW signal at the intended measurement frequency.
3. Record the reading of the probe measurement system of the CW signal.
4. Determine the level of the CW signal being used to drive the field generating device.
5. Substitute a signal using the same modulation as that used by the intended WD for the CW signal.
6. Set the amplitude during transmission of the modulated signal to equal the amplitude of the CW signal.
7. Record the reading of the probe measurement system of the modulated signal.
8. Repeat steps 1-7 for both the E- and H-field.
9. The ratio of the CW to modulated signal reading is the modulation factor.

Modulation and Crest Factors:

Signal Type	f (MHz)	Input Power (mW)	E-field Measured Values (V/m)	Modulation Factor ¹⁾	Crest Factor ^{2)*}
CW	835	100	183	1.04	1.08
WD_CDMA	835.02	100	175.9		
CW	1880	100	138.8	1.01	1.02
WD_CDMA	1880	100	137.2		
Signal Type	f (MHz)	Input Power (mW)	H-field Measured Values (A/m)	Modulation Factor ¹⁾	Crest Factor ^{2)*}
CW	835	100	0.469	0.96	0.92
WD_CDMA	835.02	100	0.488		
CW	1880	100	0.467	0.97	0.93
WD_CDMA	1880	100	0.484		

Notes: 1). Modulation Factor (MF) = CW / WD_CDMA

2). Crest Factor (CF) = (MF)².

* Crest factor 1.0 was used since the DAY4 program does not allow CFs less than 1.0.

3). Please refer to the attachment for detailed measurement data and plots.

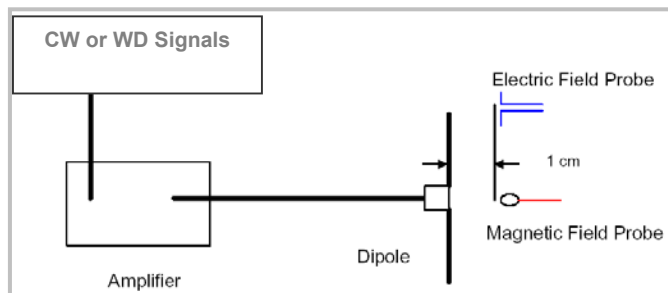

Figure 6 - Dipole Calibration

6. RF Emissions Test Procedure

Per ANSI-PC63.19-2005:

Test Instructions

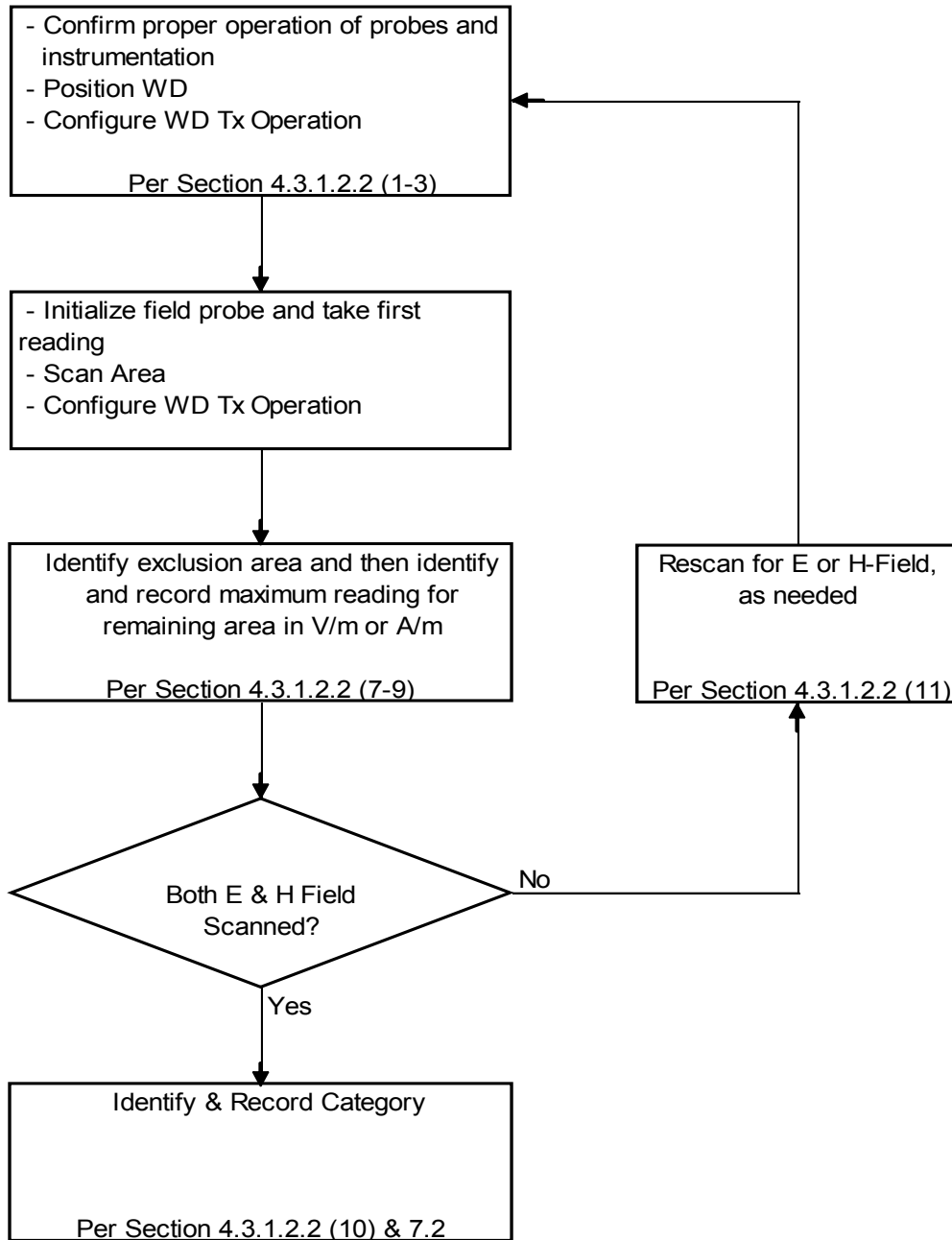

Figure 4 - WD near-field emission automated test flowchart

RF Emissions Test Procedure:

The following are step-by-step test procedures.

1. Confirm proper operation of the field probe, probe measurement system and other instrumentation and the positioning system.
2. Position the WD in its intended test position.
3. Configure the WD normal operation for maximum rated RF output power, at the desired channel and other operating parameters, (e.g. test mode) as intended for the test.
4. The center sub-grid shall be centered on the center of the WD output (acoustic or T-coil output), as appropriate. Locate the field probe at the initial test position in the 5 x 5 cm grid, which is contained in the measurement plane, see illustrated in Figure 5.
5. Record the reading.
6. Scan the entire 5 x 5 cm region in equally spaced increments and record the reading at each measurement point. The distance between measurement points shall be sufficient to assure the identification of the peak reading.
7. Identify the five contiguous sub-grids around the center sub-grid with the lowest maximum strength readings. Thus the 6 areas to be used to determine the WD's peak emissions are identified and outlined for the final manual scan. Please note that a maximum of five blocks can be excluded for both E- and H-field measurements for the WD output being measured. State another way, the center sub-grid and 3 other must be common to both the E- and H-field measurements.
8. Identify the highest field reading within the non-excluded sub-grids identified in step 7.
9. Convert the highest field reading within identified in step 8 to peak V/m or A/m, as appropriate.
10. Repeat steps 1-10 for both the E- and H-field measurements.
11. Compare this reading to the categories in ANSI-PC63.19 and record the resulting category. The lowest category number listed in ANSI-PC63.19 obtained in step 10 for either E or H field determines the M category for the audio coupling mode assessment. Record the WD category rating.

Near Field Compliance Criteria (Per ANSI-PC63.19-2005)

The EUT must meet the following M3 or M4 category:

Category	AWF (dB)	Limits for E-Field Emissions (V/m)	Limits for H-Field Emissions (A/m)
M1	0	199.5 - 354.8	0.6 - 1.07
	-5	149.6 - 266.1	0.45 - 0.8
M2	0	112.2 - 199.5	0.34 - 0.6
	-5	84.1 - 149.6	0.25 - 0.45
M3	0	63.1 - 112.2	0.19 - 0.34
	-5	47.3 - 84.1	0.15 - 0.25
M4	0	<63.1	<0.19
	-5	<47.3	<0.15

Telephone Near-field Categories in Linear Units.

WD RF Emission Measurements Reference and Plane

Figure 5 illustrate the references and reference plane that shall be used in the WD emissions

- The grid is 5 cm by 5 cm area that is divided into 9 evenly sized blocks or sub-grids.
 - The grid is centered on the audio frequency output transducer of the WD (speaker or T-coil).
 - The grid is in a reference plane, which is defined as the planar area that contains the highest point in the area of the phone that normally rests against the user's ear. It is parallel to the centerline of the receiver area of the phone and is defined by the points of the receiver-end of the WD handset, which, in normal handset use, rest against the ear.
- The measurement plane is parallel to, and 1.0 cm in front of, the reference plane.

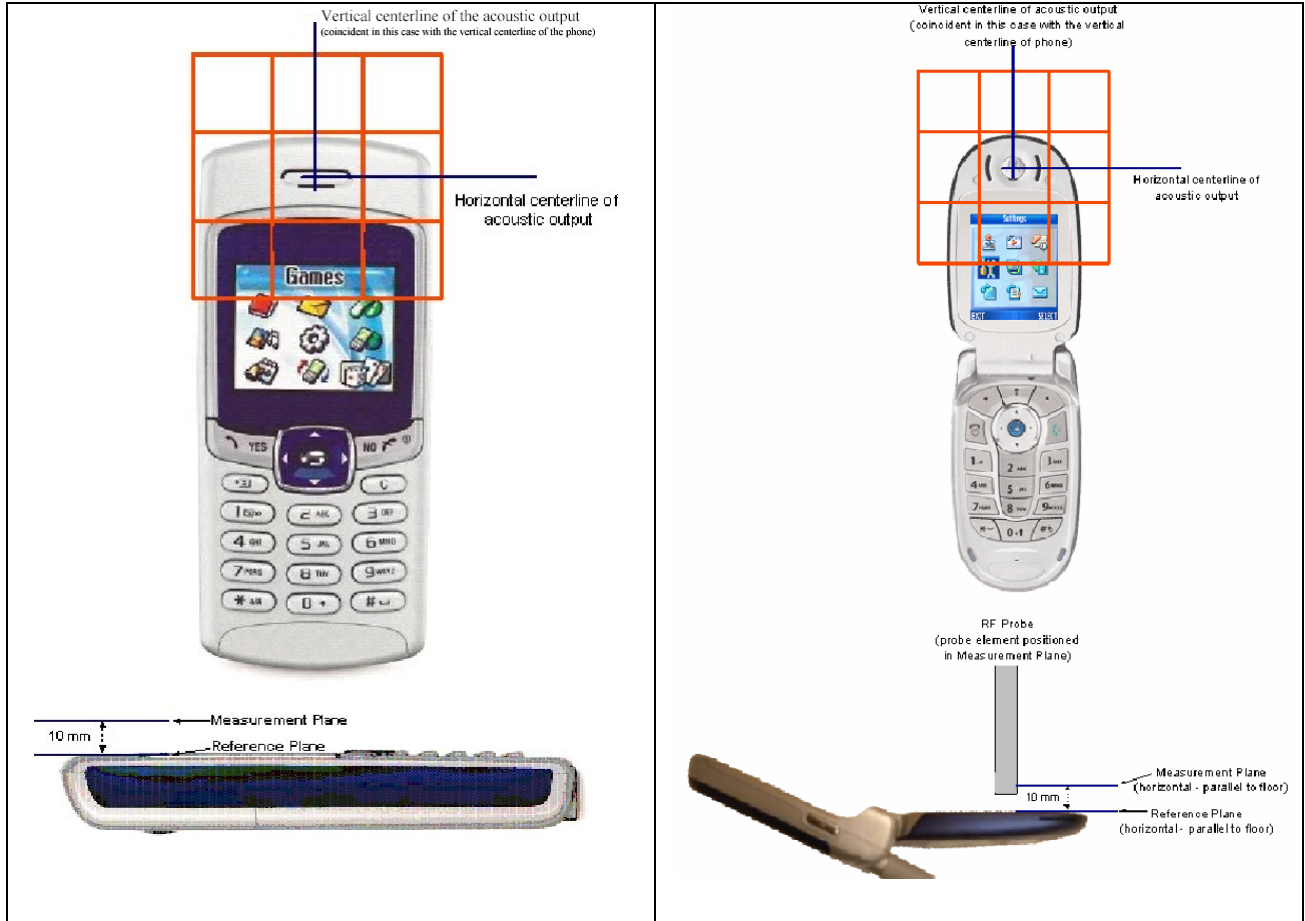

Figure 5 - WD reference and plane for RF emission measurements

7. Procedures Used to Establish Test Signal

The following settings were used to configure the Wireless Communications Test Set, Agilent 8960 Series 10, E5515C.

Operation Mode: Active Cell

System Mode: IS-2000

Call Parm	Cell band	
	US Cellular	US PCS
Channel	1013 / 383 / 777	25 / 600 / 1175
Protocol Rev	6 (IS-2000-0)	6 (IS-2000-0)
Radio Config	(Fwd3, Rvs3), S055 (Loopback)	(Fwd3, Rvs3), S055 (Loopback)
Rvs Power Ctrl	All Up Bits	All Up Bits
Power Ctrl Size	1.0 dBm	1.0 dBm
Call Drop Timer	Off	Off
Call Limit Mode	Off	Off
Traffic Dada Rate	Full	Full
Rcvr Power Ctrl	Manual	Manual
Meas Frequency	Auto	Auto
Voice SO Mode	Voice Echo	Voice Echo
Echo Delay	Medium	Medium

8. Summary of Results

CDMA Cellular band

Table below shows the results of the near electric (E-Field) and magnetic (H-Field) fields generated by wireless communications devices (WD). The worst case result is highlighted.

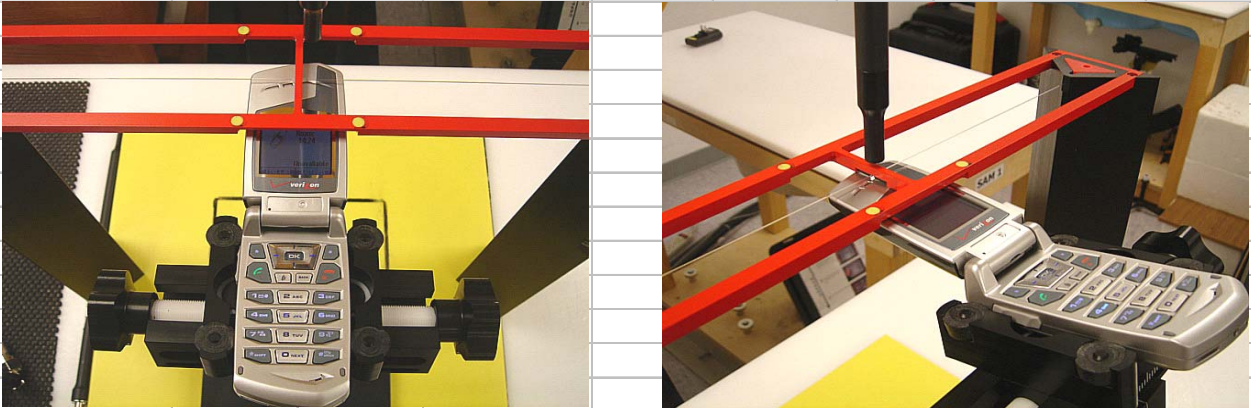
Model: KX1								
E-Field Emission Test								
Operating Mode	Channel	f (MHz)	Conducted Power (dBm)	Power drift (dB)	Backlight	AWF	Measured E-field Emissions (V/m)	Category M-Rating
CDMA Cellular Band	1013	824.70	25.09	-0.093	on	0	97.10	M3
	383	836.49	25.12	-0.104	on	0	91.00	M3
	777	848.31	25.10	-0.135	on	0	85.80	M3
CDMA Cellular Band	1013	824.70	25.10	0.040	off	0	96.00	M3
	383	836.49	25.12	-0.034	off	0	87.60	M3
	777	848.31	25.10	-0.094	off	0	84.90	M3
H-Field Emission Test								
Operating Mode	Channel	f (MHz)	Conducted Power (dBm)	Power drift (dB)	Backlight	AWF	Measured E-field Emissions (A/m)	Category M-Rating
CDMA Cellular Band	1013	824.70	25.09	0.041	on	0	0.119	M4
	383	836.49	25.12	-0.070	on	0	0.114	M4
	777	848.31	25.10	-0.126	on	0	0.113	M4
CDMA Cellular Band	1013	824.70	25.10	-0.011	off	0	0.120	M4
	383	836.49	25.12	0.044	off	0	0.113	M4
	777	848.31	25.10	0.002	off	0	0.116	M4
Overall M-Rating:								M3
								

CDMA PCS band

Table below shows the results of the near electric (E-Field) and magnetic (H-Field) fields generated by wireless communications devices (WD). The worst case result is highlighted.

Model: KX1								
E-Field Emission Test								
Operating Mode	Channel	f (MHz)	Conducted Power (dBm)	Power drift (dB)	Backlight	AWF	Measured E-field Emissions (V/m)	Category M-Rating
CDMA PCS Band	25	1851.25	23.80	-0.037	on	0	46.30	M4
	600	1880	23.16	0.090	on	0	45.50	M4
	1175	1908.75	23.50	-0.187	on	0	40.80	M4
CDMA PCS Band	25	1851.25	23.80	0.042	off	0	45.60	M4
	600	1880	23.16	-0.044	off	0	45.30	M4
	1175	1908.75	23.50	0.067	off	0	41.70	M4
H-Field Emission Test								
Operating Mode	Channel	f (MHz)	Conducted Power (dBm)	Power drift (dB)	Backlight	AWF	Measured E-field Emissions (A/m)	Category M-Rating
CDMA PCS Band	25	1851.25	23.80	-0.122	on	0	0.077	M4
	600	1880	23.16	-0.143	on	0	0.083	M4
	1175	1908.75	23.50	-0.055	on	0	0.082	M4
CDMA PCS Band	25	1851.25	23.80	-0.105	off	0	0.077	M4
	600	1880	23.16	-0.103	off	0	0.087	M4
	1175	1908.75	23.50	0.003	off	0	0.084	M4
Overall M-Rating:								M4

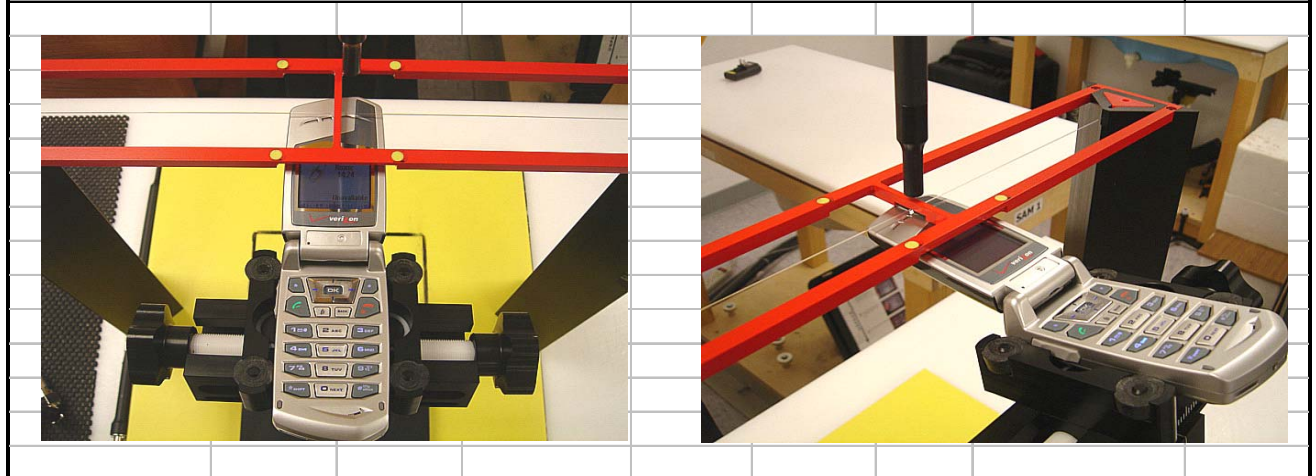

9. Test Equipment List

<u>Name of Equipment</u>	<u>Manufacturer</u>	<u>Type/Model</u>	<u>Serial Number</u>	<u>Cal. Due date</u>
Robot - Six Axes	Stäubli	RX90BL	N/A	N/A
Robot Remote Control	Stäubli	CS7MB	3403-91535	N/A
DASY4 Measurement Server	SPEAG	SEUMS001BA	1041	N/A
Probe Alignment Unit	SPEAG	LB (V2)	261	N/A
Data Acquisition Electronics	SPEAG	DAE3 V1	500	2/7/06
E-Field Probe	SPEAG	ER3DV6	2339	3/11/06
H-Field Probe	SPEAG	H3DV6	6157	3/11/06
Calibration Dipole	SPEAG	CD1880V3	1014	2/23/07
Calibration Dipole	SPEAG	CD835V3	1014	2/24/07
Signal Generator	R&H	SMP 04	DE34210	6/2/06
Signal Generator	HP	8648C	3623A03025	7/5/06
Power Meter	Giga-tronics	8651A	8651404	9/16/05
Power Sensor	Giga-tronics	80701A	1834588	9/16/05
Amplifier	Mini-Circuits	ZHL-42W	D072701-5	N/A
Radio Communication Tester	R & S	CMU 200	838114/032	12/17/06
Wireless Communication Test Set	Agilent	E5515C	GB44051333	5/5/06

10. Measurement Uncertainty

HAC Uncertainty Budget According to ANSI PC63.19							
Error Description	Uncertainty value (±%)	Probe Dist.	Div.	(Ci) E	(Ci) H	Std. Unc.(±%)	
						E	H
Measurement System							
Probe Calibration	5.10	N	1	1	1	5.1	5.1
Axial Isotropy	4.70	R	1.732	1	1	2.7	2.7
Sensor Displacement	16.50	R	1.732	1	0.145	9.5	1.4
Boundary Effects	2.40	R	1.732	1	1	1.4	1.4
Linearity	4.70	R	1.732	1	1	2.7	2.7
Scaling to Peak Envelope Power	2.00	R	1.732	1	1	1.2	1.2
System Detection Limit	1.00	R	1.732	1	1	0.6	0.6
Readout Electronics	0.30	N	1	1	1	0.3	0.3
Response Time	0.80	R	1.732	1	1	0.5	0.5
Integration Time	2.60	R	1.732	1	1	1.5	1.5
RF Ambient Conditions	3.00	R	1.732	1	1	1.7	1.7
RF Reflections	12.00	R	1.732	1	1	6.9	6.9
Probe Positioner	1.20	R	1.732	1	0.67	0.7	0.5
Probe Positioning	4.70	R	1.732	1	0.67	2.7	1.8
Extrapolation and Interpolation	1.00	R	1.732	1	1	0.6	0.6
Test sample Related							
Test Positioning Vertical	4.70	R	1.732	1	0.67	2.7	1.8
Test Positioning Lateral	1.00	R	1.732	1	1	0.6	0.6
Device Holder and Phantom	2.40	R	1.732	1	1	1.4	1.4
Power Drift	5.00	R	1.732	1	1	2.9	2.9
Phantom and Setup Related							
Phantom Thickness	2.40	R	1.732	1	0.67	1.4	0.9
Combined Std. Uncertainty						14.7	10.9
Expanded Std. Uncertainty on Power						29.4	21.8
Expanded Std. Uncertainty on Field						14.7	10.9
Notes for table							
1. N - Nomal							
2. R - Rectangular							
3. Div. - Divisor used to obtain standard uncertainty							
4. Ci - is te sensitivity coefficient							

Table above Worst-Case uncertainty budget for HAC free field assessment according to ANSIC63.19. The budget is valid for the frequency range 800 MHz - 3 GHz and represents a worstcase analysis. For specific tests and configurations, the uncertainty could be considerably smaller. Some of the parameters are dependent on the user situations and need adjustment according to the actual laboratory conditions.

11. Attachment

No.	Contents	No. of page (s)
1	Validation Dipole Check Data	8
2	Modulation Signal Test Data	8
3-1	HAC_E-Device Cell & PCS bands test data	24
3-3	HAC_H-Device Cell & PCS bands test data	24
4	Certificate of E-filed Probe ER3DV6 SN 2339	9
5	Certificate of H-filed Probe H3DV6 SN 6157	8
6	Certificate of Validation Dipole CD835V3 SN 1014	6
7	Certificate of System Validation Dipole CD1880V3 SN 1010	6

END OF REPORT