

## Test Report

From

**Kyocera Wireless Corp**

**PCS CDMA Cellular Phone**

<b>FCC Part 24 Certification IC RSS 133</b>	
FCC ID:	<b>OVFKWC-KE423</b>
Models:	<b>KE423 and KX423</b>

<b>STATEMENT OF CERTIFICATION</b>			
<p><i>The data, data evaluation and equipment configuration represented herein are a true and accurate representation of the measurements of the sample's radio frequency interference emissions characteristics as of the dates and at the times of the test under the conditions herein specified.</i></p>			
<b>STATEMENT OF COMPLIANCE</b>			
<p><i>This product has been shown to be capable of compliance with the applicable technical standards as indicted in the measurement report and was tested in accordance with the measurement procedures specified in §2.947.</i></p>			
Test performed by:	Patrick Bowen Staff Engineer	Date of Test:	01/14/05 - 01/14/05
Report Prepared by:	Patrick Bowen Staff Engineer	Date of Report:	01/17/05
Report Reviewed by:	C. K. Li Engineer, Senior Staff/Manager	Date of Review:	01/17/05
<p>Tests that required an OATS site were performed by Nemko San Diego, California.</p>			

**TABLE OF CONTENTS**

1	General Information .....	3
2	Product Description .....	4
3	Electronic Serial Numbers (ESN) Protection .....	5
4	FCC Compliance Emergency 911 .....	5
5	TTY compliance .....	5
6	Transmitter RF Power Output.....	6
6.1	Conducted Power .....	6
6.2	Radiated Power .....	7
7	Occupied Bandwidth.....	8
8	Spurious Emissions At Antenna Terminals .....	11
9	Transmitter Radiated Spurious Emissions Measured Data.....	15
10	Receiver Spurious Emissions .....	15
11	Transmitter RF Carrier Frequency Stability .....	15
11.1	CDMA 1900 Mode .....	16
12	Exposure of Humans to RF Fields (SAR) .....	17
13	Test Equipment .....	17

**1 General Information**

<b>Applicant:</b>	Kyocera Wireless Corp 10300 Campus Point Drive San Diego CA 92121
<b>FCC ID:</b>	OVFKWC-KE423
<b>Product:</b>	PCS CDMA Cellular Phone
<b>Model Numbers:</b>	KE423 and KX423
<b>EUT Serial Number:</b>	GM-T----15L7GB (model KE423)
<b>Type:</b>	<input type="checkbox"/> Prototype, <input checked="" type="checkbox"/> Pre-Production, <input type="checkbox"/> Production
<b>Device Category:</b>	Portable
<b>RF Exposure Environment:</b>	General Population / Uncontrolled
<b>Antenna:</b>	Fixed Stubby
<b>Detachable Antenna:</b>	Yes
<b>External Input:</b>	Audio/Digital Data
<b>Quantity:</b>	Quantity production is planned
<b>FCC Rule Parts:</b>	§24E
<b>Modes:</b>	1900 CDMA
<b>Multiple Access Scheme:</b>	CDMA
<b>TX Frequency (MHz):</b>	1850 - 1910
<b>Emission Designators:</b>	1M25F9W
<b>Max. Output Power (W)</b>	0.324 EIRP

## 2 Product Description

The phones in the OVFKWC-KE423 filing are PCS 1XRTT products. Models have integrated Assisted GPS software feature enabled to meet the emergency location requirements of the FCC's E911 Phase II mandate. The PCS architecture is defined as 1900MHz (PCS CDMA).

All models included in the OVFKWC-KE423 filing use the same antenna and have identical PCB layouts in regards to the RF Circuitry, Basic Frequency Determining and Stabilization Circuitry, Basic Modulator Circuit, Transmitter Active Devices, and Tuning Targets. The only differences between models are the choice of color or greyscale LCD, and the software applications supported (GPS, Brew, WAP, etc.). See product matrix in Figure 1 below.

The phone is designed in compliance with the technical specifications for compatibility of mobile and base stations in the Cellular Radio telephone service contained in "Cellular System Mobile Station -Land Station Compatibility Specification" as specified in OET Bulletin 53 and TIA Standards

The phone will support certain CDMA2000 radio-configurations (RC) as describes in Exhibit 1 (operation description).

	
	Blade
KWC PCS/ Greyscale	KE4 23
KWC PCS/ Color/ Brew	KX4 23

**Figure 2 OVFKWC-KE423 Product Matrix**

### 3 Electronic Serial Numbers (ESN) Protection

The PCS Phone, FCC ID: OVFKWC-KE423 uses ESN. The ESN is a unique identification number to each phone, which is contained in the Numeric Assignment Module and is automatically transmitted to the base station whenever a call is placed. The ESN is stored in an EPROM and is isolated from fraudulent contact and tampering. Any attempt to change the ESN will render the portable phone inoperative.

The phone complies with all requirements for ESN under Part 22.919.

### 4 FCC Compliance Emergency 911

<b>FCC § 22.921</b>
When an emergency 911 call is originated by the user, the mobile will attempt to acquire any available system and originate the emergency call on that system, disregarding restrictions set by the roaming list. The FCC NPRM WT99-13, CC94-102 automatic analog A/B roaming option has been implemented for 911 emergency calls. The models have Global Positioning System (GPS) support.

### 5 TTY compliance

<b>FCC § 255 of the Telecom Act</b>
The OVFKWC-KE423 phone models have been designed for TTY Compliance with Cellular Compatibility Standard.

## 6 Transmitter RF Power Output

### 6.1 Conducted Power

<b>FCC:</b> § 2.1046	<b>IC:</b> RSS-133 §6.2
<b>Measurement Procedures:</b>	
<p>The RF output power was measured using a Giga-tronics 8541C Universal Power Meter and HP 8594E Spectrum Analyzer that has the CDMA personality option. Terminated to a resistive coaxial load of 50 ohms.</p>	

Mode	Frequency (MHz)	Channel	Power (dBm)
CDMA 1900	1851.25	25	23.02
	1880.00	600	23.05
	1908.75	1175	23.03

## 6.2 Radiated Power

<b>FCC:</b> § 24.232	<b>IC:</b> RSS-133 §6.2
----------------------	-------------------------

**Measurement Procedures:**

The EUT was positioned on a 2-axis non-conductive positioner inside an anechoic chamber.

The EUT conducted power was set by the phone control software. During tests, the phone was rotated 360 degree in azimuth and elevation by an automated antenna measurement workstation. Maximum radiated power was recorded using a Giga-tronics 8541C Universal Power Meter. All measurement results are EIRP in dBm.

Anechonic Chamber

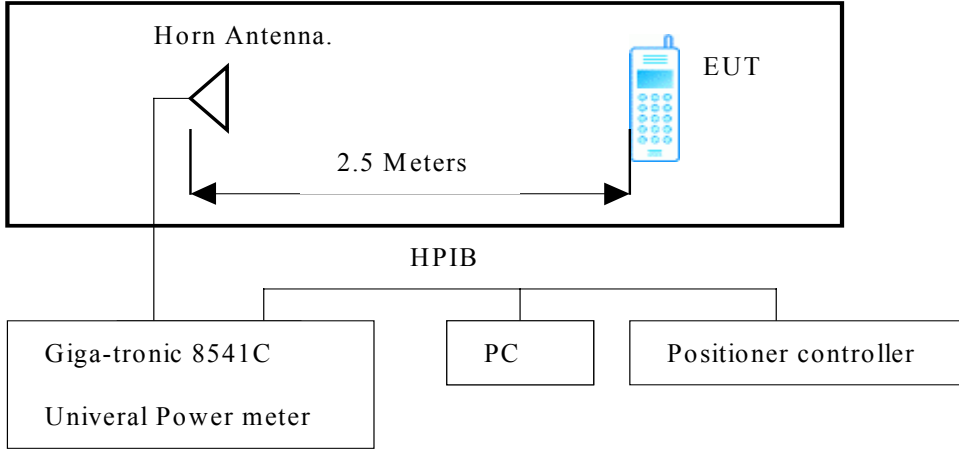

Mode	Frequency (MHz)	Channel	Max. Power (dBm)	Ref.
CDMA 1900	1851.25	25	24.8	EIRP
	1880.00	600	24.7	
	1908.75	1175	25.1	

## 7 Occupied Bandwidth

<b>FCC:</b> § 2.1049, § 24.238	<b>IC:</b> RSS-133 §6.3
<b>Measurement Procedures:</b>	
The RF output of the EUT was connected to the input of the spectrum analyzer with sufficient attenuation. The spectrum with no modulation was recorded.	
For Digital: Modulate with full rate.	

### List of Figures

Figure	Mode	Description
7-1	CDMA 1900	CDMA at RC1
7-2		CDMA 1X, at RC3
7-3		Lower Band Edge @ CH 25
7-4		Upper Band Edge @ CH 1175

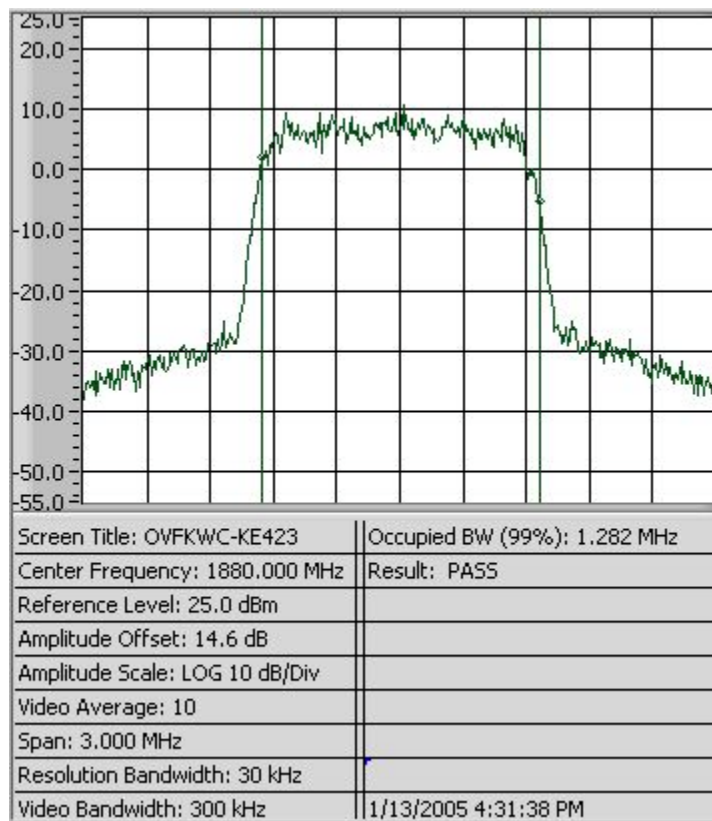

Figure 7-1 CDMA 1900 at RC1



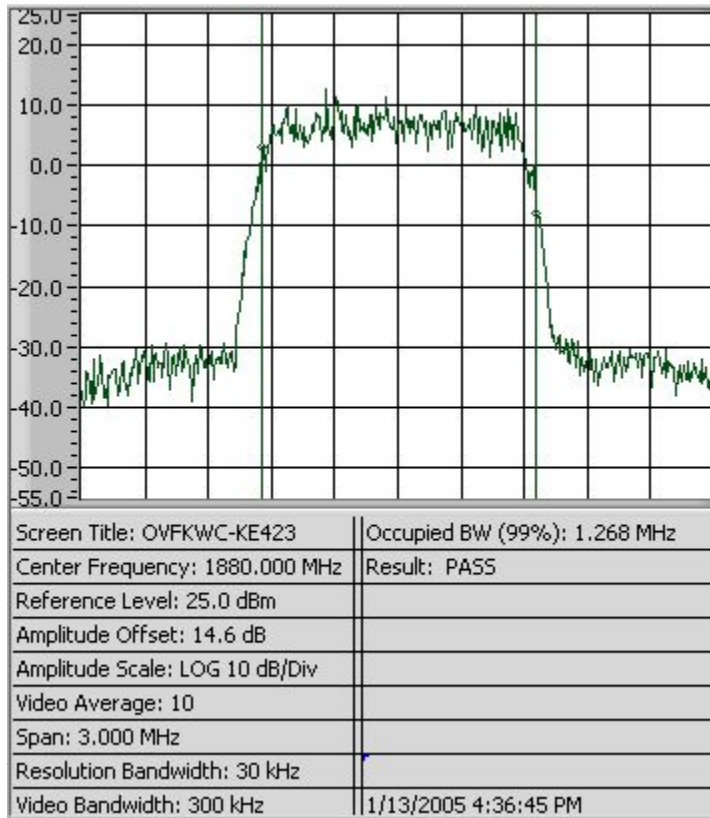

Figure 7-2 CDMA 1900 1X at RC3

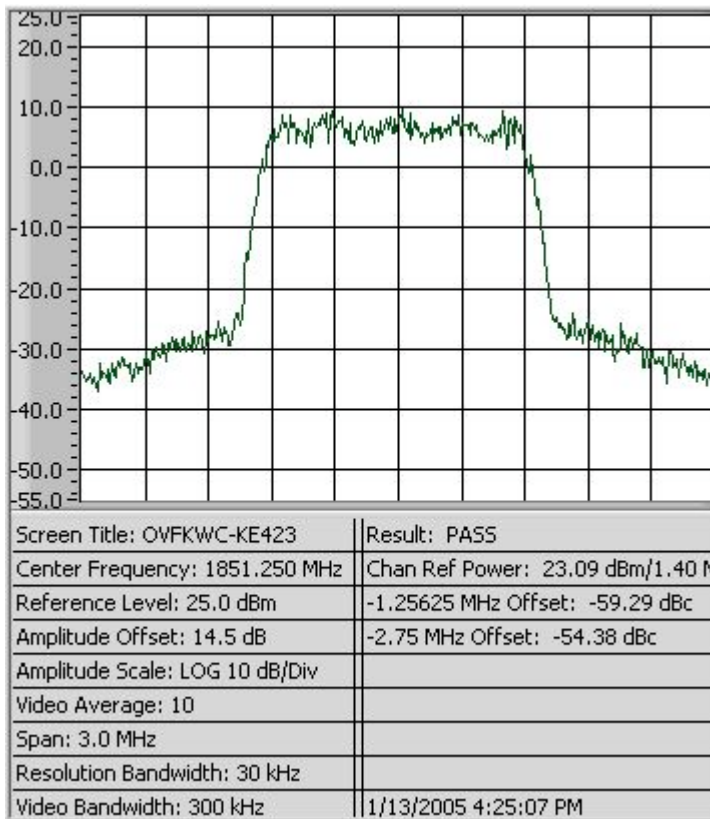
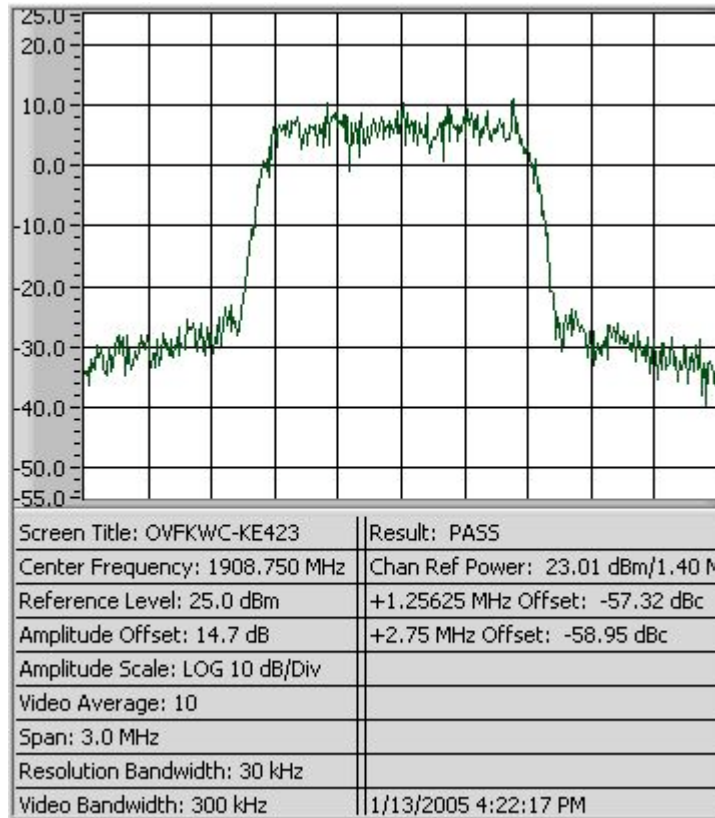

Figure 7-3 CDMA 1900 Lower Band Edge



**Figure 7-4 CDMA 1900 Upper Band Edge**

## 8 Spurious Emissions At Antenna Terminals

<b>FCC:</b> § 2.1051, § 24.238	<b>IC:</b> RSS-133 §6.3
<b>Measurement Procedures:</b>	
<p><u>Out of Band:</u> The RF output of the EUT was connected to the input of the spectrum analyzer with sufficient attenuation. The modulating signal was applied accordingly. The frequency spectrum was investigated from the lowest frequency signal generated up to at least the tenth harmonic of the fundamental.</p>	

**List of Figures:**

Figure	Mode	Channel	Plot Description
9-1	CDMA 1900	25	Conducted spurious emissions, 9kHz to 20GHz
9-2		600	Conducted spurious emissions, 9kHz to 20GHz
9-3		1175	Conducted spurious emissions, 9kHz to 20GHz

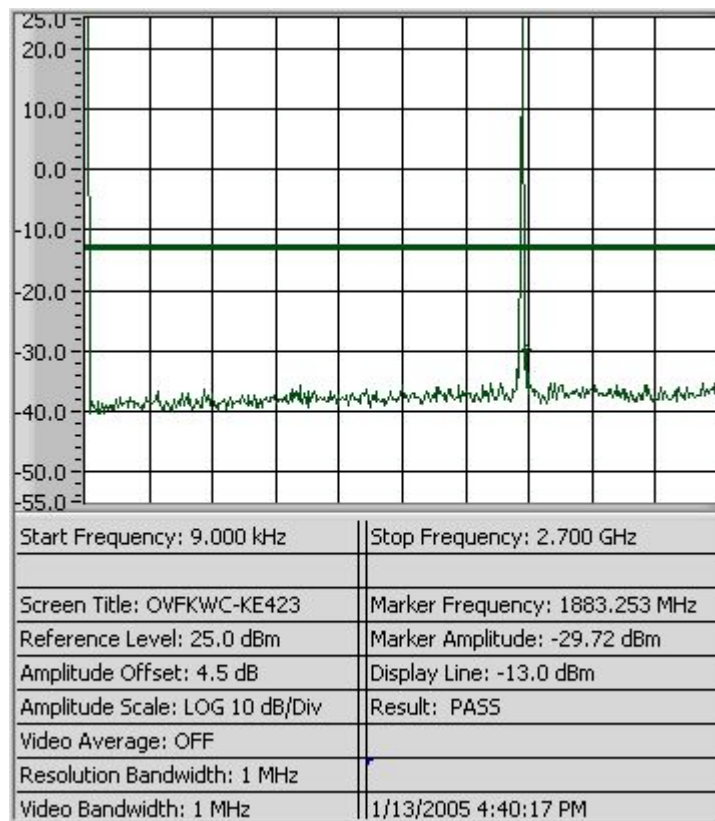

**Figure 8-1a CDMA 1900 - Conducted Spurious Emission (CH 25)**

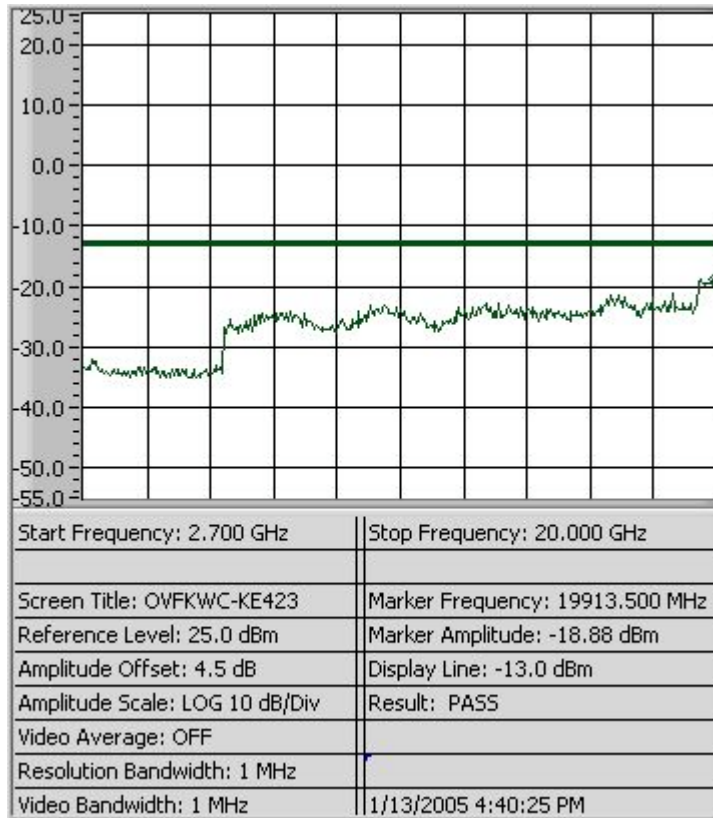

Figure 8-1b CDMA 1900 - Conducted Spurious Emission (CH 25)

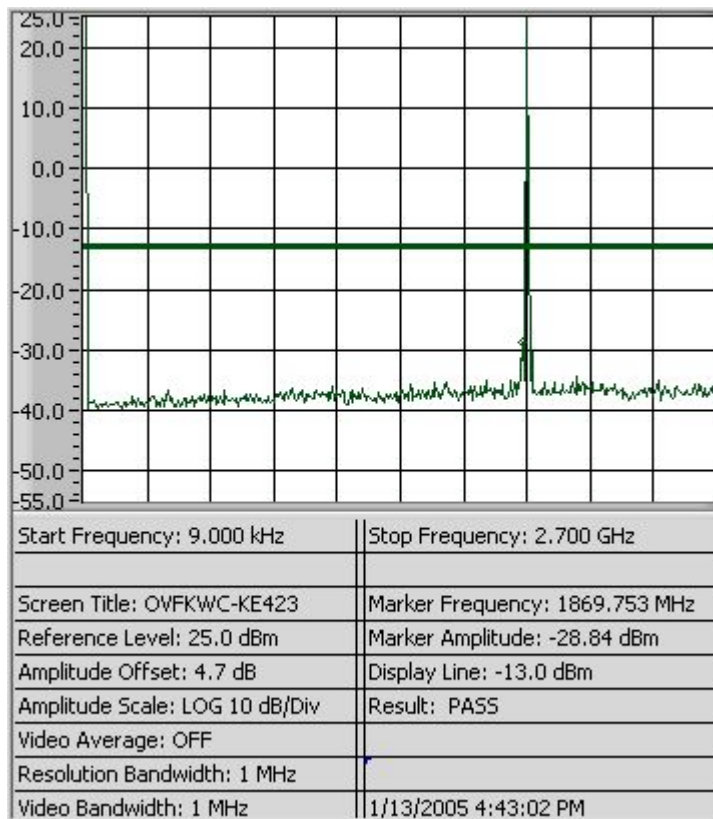

Figure 8-2a CDMA 1900 - Conducted Spurious Emission (CH 600)

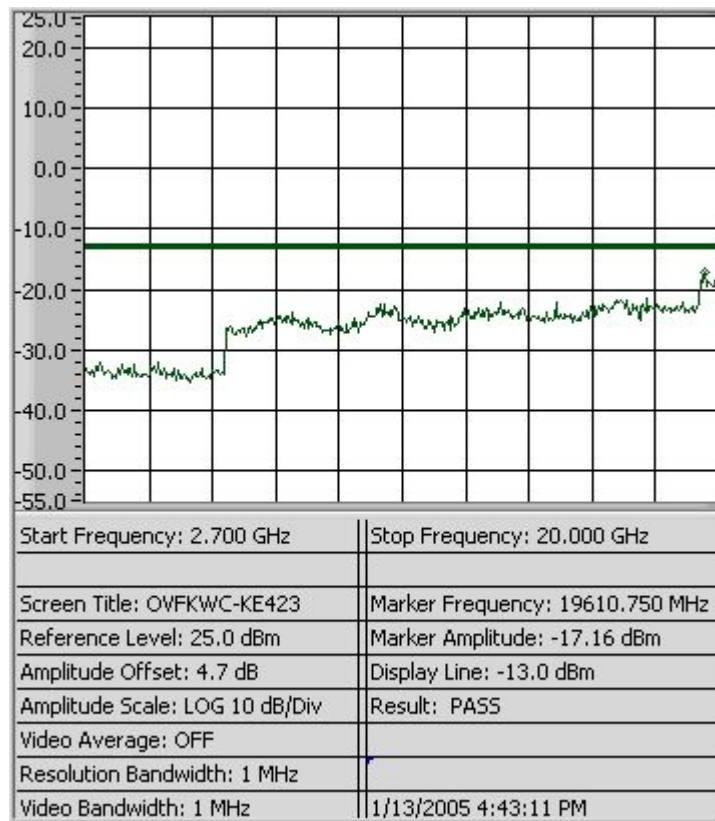

Figure 8-2b CDMA 1900 - Conducted Spurious Emission (CH 600)

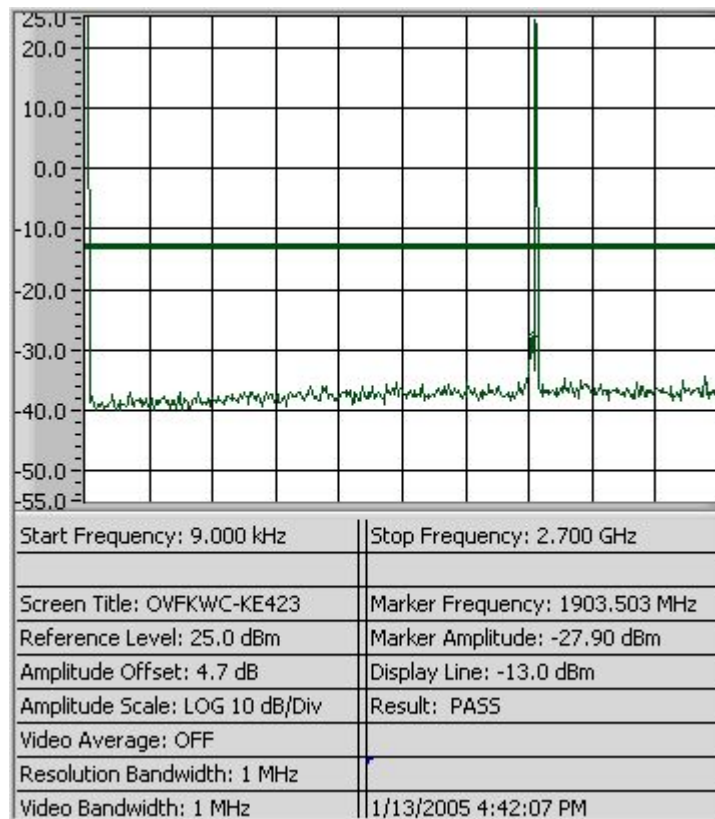

Figure 8-3a CDMA 1900 - Conducted Spurious Emission (CH 1175)

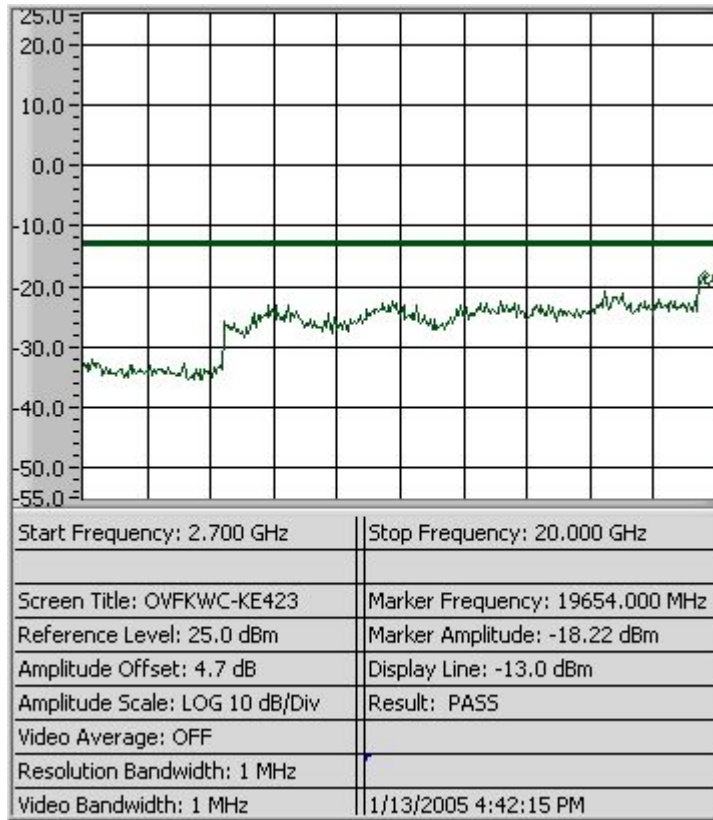

Figure 8-3b CDMA 1900 - Conducted Spurious Emission (CH 1175)

**9 Transmitter Radiated Spurious Emissions Measured Data**

<b>FCC:</b> § 2.1053, § 24.238	<b>IC:</b> RSS-133 §6.3
<b>Measurement Procedures:</b>  The radiated spurious emission test was performed at Nemko in San Diego, California. The test report is attached in a separate attachment.	

**10 Receiver Spurious Emissions**

<b>FCC:</b> § 15.109	<b>IC:</b> RSS-133 §9
<b>Measurement Procedures:</b>  The receiver radiated spurious emission test was performed at Nemko in San Diego, California. The test report is attached in a separate attachment.	

**11 Transmitter RF Carrier Frequency Stability**

<b>FCC:</b> § 2.1055, § 24.235	<b>IC:</b> RSS-133 §7
<b>Measurement Procedures:</b>  The EUT was placed in an environmental chamber. The RF output of the EUT was connected to Agilent 8960 Series 10 E5515C. A power supplier was connected as primary voltage supply.	

11.1 CDMA 1900 Mode

<b>Tx Frequency:</b> 1880.00 MHz	<b>Voltage :</b> 3.7V
<b>Tolerance:</b> +/- 2.5 Ppm (+/-4700 Hz)	<b>Channel:</b> 600

Temperature (°C)	Deviation of Carrier (Hz)			Specification (Hz)	
	3.2V (Battery endpoint)	3.7V	4.26V (115%)	Lower limit	Upper limit
-30		1.43		-4700	4700
-20		2.48		-4700	4700
-10		3.15		-4700	4700
0		2.64		-4700	4700
10		0.68		-4700	4700
20	-0.73	2.88	2.92	-4700	4700
30		1.65		-4700	4700
40		2.84		-4700	4700
50		2.24		-4700	4700
60		2.65		-4700	4700

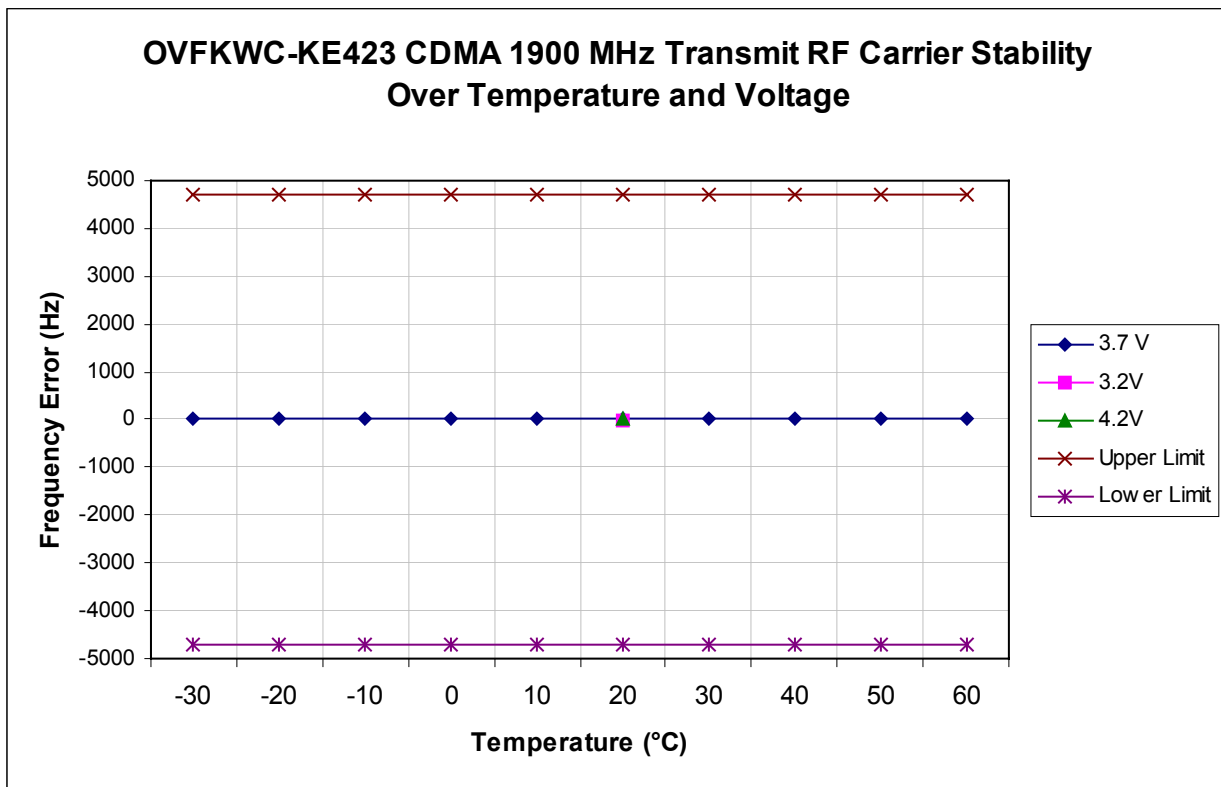



## 12 Exposure of Humans to RF Fields (SAR)

The SAR Test Report is showed in a separate attachment as Exhibit 9.

## 13 Test Equipment

Description	Manufacturer	Model Number	Serial Number	Cal Due Date
Power Meter	Giga-tronics	8541C	1833156	02/24/05
Power Meter Sensor	Giga-tronics	80601A	1831770	04/12/05
Spectrum Analyzer	Hewlett Packard	8593EM	3710A00203	04/30/05
Wireless Communications Test Set	Agilent	8960	US41070147	04/06/06
Temperature Chamber	CSZ	Z2033	Z9343034	04/02/05