

Appendix D:
Dipole Calibration Parameters



Accredited by the Swiss Accreditation Service (SAS)
The Swiss Accreditation Service is one of the signatories to the EA
Multilateral Agreement for the recognition of calibration certificates

Accreditation No.: **SCS 108**

Client **Kyocera USA**

Certificate No. **D835V2-467_Sep08**

CALIBRATION CERTIFICATE

Object **D835V2 - SN: 467**

Calibration procedure(s) **QA CAL-05.v7
Calibration procedure for dipole validation kits**

Calibration date: **September 16, 2008**

Condition of the calibrated item **In Tolerance**

This calibration certificate documents the traceability to national standards, which realize the physical units of measurements (SI).
The measurements and the uncertainties with confidence probability are given on the following pages and are part of the certificate.

All calibrations have been conducted in the closed laboratory facility: environment temperature (22 ± 3)°C and humidity < 70%.

Calibration Equipment used (M&TE critical for calibration)

| Primary Standards | ID # | Cal Date (Certificate No.) | Scheduled Calibration |
|-----------------------------|--------------------|-----------------------------------|------------------------|
| Power meter EPM-442A | GB37480704 | 04-Oct-07 (No. 217-00736) | Oct-08 |
| Power sensor HP 8481A | US37292783 | 04-Oct-07 (No. 217-00736) | Oct-08 |
| Reference 20 dB Attenuator | SN: 5086 (20g) | 01-Jul-08 (No. 217-00864) | Jul-09 |
| Type-N mismatch combination | SN: 5047.2 / 06327 | 01-Jul-08 (No. 217-00867) | Jul-09 |
| Reference Probe ES3DV2 | SN: 3025 | 28-Apr-08 (No. ES3-3025_Apr08) | Apr-09 |
| DAE4 | SN: 601 | 14-Mar-08 (No. DAE4-601_Mar08) | Mar-09 |
| Secondary Standards | ID # | Check Date (in house) | Scheduled Check |
| Power sensor HP 8481A | MY41092317 | 18-Oct-02 (in house check Oct-07) | In house check: Oct-09 |
| RF generator R&S SMT-06 | 100005 | 4-Aug-99 (in house check Oct-07) | In house check: Oct-09 |
| Network Analyzer HP 8753E | US37390585 S4206 | 18-Oct-01 (in house check Oct-07) | In house check: Oct-08 |

| | Name | Function | Signature |
|----------------|---------------|-----------------------|-----------|
| Calibrated by: | Marcel Fehr | Laboratory Technician | |
| Approved by: | Katja Pokovic | Technical Manager | |

Issued: September 16, 2008

This calibration certificate shall not be reproduced except in full without written approval of the laboratory.



Accredited by the Swiss Accreditation Service (SAS)
The Swiss Accreditation Service is one of the signatories to the EA
Multilateral Agreement for the recognition of calibration certificates

Accreditation No.: **SCS 108**

Glossary:

| | |
|-------|---------------------------------|
| TSL | tissue simulating liquid |
| ConvF | sensitivity in TSL / NORM x,y,z |
| N/A | not applicable or not measured |

Calibration is Performed According to the Following Standards:

- IEEE Std 1528-2003, "IEEE Recommended Practice for Determining the Peak Spatial-Averaged Specific Absorption Rate (SAR) in the Human Head from Wireless Communications Devices: Measurement Techniques", December 2003
- IEC 62209-1, "Procedure to measure the Specific Absorption Rate (SAR) for hand-held devices used in close proximity to the ear (frequency range of 300 MHz to 3 GHz)", February 2005
- Federal Communications Commission Office of Engineering & Technology (FCC OET), "Evaluating Compliance with FCC Guidelines for Human Exposure to Radiofrequency Electromagnetic Fields; Additional Information for Evaluating Compliance of Mobile and Portable Devices with FCC Limits for Human Exposure to Radiofrequency Emissions", Supplement C (Edition 01-01) to Bulletin 65

Additional Documentation:

- DASY4/5 System Handbook

Methods Applied and Interpretation of Parameters:

- Measurement Conditions:* Further details are available from the Validation Report at the end of the certificate. All figures stated in the certificate are valid at the frequency indicated.
- Antenna Parameters with TSL:* The dipole is mounted with the spacer to position its feed point exactly below the center marking of the flat phantom section, with the arms oriented parallel to the body axis.
- Feed Point Impedance and Return Loss:* These parameters are measured with the dipole positioned under the liquid filled phantom. The impedance stated is transformed from the measurement at the SMA connector to the feed point. The Return Loss ensures low reflected power. No uncertainty required.
- Electrical Delay:* One-way delay between the SMA connector and the antenna feed point. No uncertainty required.
- SAR measured:* SAR measured at the stated antenna input power.
- SAR normalized:* SAR as measured, normalized to an input power of 1 W at the antenna connector.
- SAR for nominal TSL parameters:* The measured TSL parameters are used to calculate the nominal SAR result.

Measurement Conditions

DASY system configuration, as far as not given on page 1.

| | | |
|-------------------------------------|---------------------------|-------------|
| DASY Version | DASY5 | V5.0 |
| Extrapolation | Advanced Extrapolation | |
| Phantom | Modular Flat Phantom V4.9 | |
| Distance Dipole Center - TSL | 15 mm | with Spacer |
| Zoom Scan Resolution | dx, dy, dz = 5 mm | |
| Frequency | 835 MHz ± 1 MHz | |

Head TSL parameters

The following parameters and calculations were applied.

| | Temperature | Permittivity | Conductivity |
|---|-----------------|--------------|------------------|
| Nominal Head TSL parameters | 22.0 °C | 41.5 | 0.90 mho/m |
| Measured Head TSL parameters | (22.0 ± 0.2) °C | 41.2 ± 6 % | 0.88 mho/m ± 6 % |
| Head TSL temperature during test | (22.0 ± 0.2) °C | — | — |

SAR result with Head TSL

| SAR averaged over 1 cm³ (1 g) of Head TSL | Condition | |
|---|--------------------|-----------------------------------|
| SAR measured | 250 mW input power | 2.35 mW / g |
| SAR normalized | normalized to 1W | 9.40 mW / g |
| SAR for nominal Head TSL parameters ¹ | normalized to 1W | 9.35 mW / g ± 17.0 % (k=2) |

| SAR averaged over 10 cm³ (10 g) of Head TSL | condition | |
|---|--------------------|-----------------------------------|
| SAR measured | 250 mW input power | 1.54 mW / g |
| SAR normalized | normalized to 1W | 6.16 mW / g |
| SAR for nominal Head TSL parameters ¹ | normalized to 1W | 6.12 mW / g ± 16.5 % (k=2) |

¹ Correction to nominal TSL parameters according to d), chapter "SAR Sensitivities"

Body TSL parameters

The following parameters and calculations were applied.

| | Temperature | Permittivity | Conductivity |
|----------------------------------|-----------------|--------------|------------------|
| Nominal Body TSL parameters | 22.0 °C | 55.2 | 0.97 mho/m |
| Measured Body TSL parameters | (22.0 ± 0.2) °C | 53.3 ± 6 % | 1.01 mho/m ± 6 % |
| Body TSL temperature during test | (21.7 ± 0.2) °C | --- | --- |

SAR result with Body TSL

| SAR averaged over 1 cm ³ (1 g) of Body TSL | Condition | |
|---|--------------------|-----------------------------------|
| SAR measured | 250 mW input power | 2.49 mW / g |
| SAR normalized | normalized to 1W | 9.96 mW / g |
| SAR for nominal Body TSL parameters ² | normalized to 1W | 9.49 mW / g ± 17.0 % (k=2) |

| SAR averaged over 10 cm ³ (10 g) of Body TSL | condition | |
|---|--------------------|-----------------------------------|
| SAR measured | 250 mW input power | 1.64 mW / g |
| SAR normalized | normalized to 1W | 6.56 mW / g |
| SAR for nominal Body TSL parameters ² | normalized to 1W | 6.34 mW / g ± 16.5 % (k=2) |

² Correction to nominal TSL parameters according to d), chapter "SAR Sensitivities"

Appendix

Antenna Parameters with Head TSL

| | |
|--------------------------------------|-------------------------------|
| Impedance, transformed to feed point | 47.3 Ω -1.7 j Ω |
| Return Loss | - 29.6 dB |

Antenna Parameters with Body TSL

| | |
|--------------------------------------|-------------------------------|
| Impedance, transformed to feed point | 45.3 Ω -5.1 j Ω |
| Return Loss | - 22.8 dB |

General Antenna Parameters and Design

| | |
|----------------------------------|----------|
| Electrical Delay (one direction) | 1.363 ns |
|----------------------------------|----------|

After long term use with 100W radiated power, only a slight warming of the dipole near the feedpoint can be measured.

The dipole is made of standard semirigid coaxial cable. The center conductor of the feeding line is directly connected to the second arm of the dipole. The antenna is therefore short-circuited for DC-signals.

No excessive force must be applied to the dipole arms, because they might bend or the soldered connections near the feedpoint may be damaged.

Additional EUT Data

| | |
|-----------------|-----------------|
| Manufactured by | SPEAG |
| Manufactured on | August 27, 2002 |

Test Laboratory: SPEAG, Zurich, Switzerland

DUT: Dipole 835 MHz; Type: D835V2; Serial: D835V2 - SN:467

Communication System: CW-835; Frequency: 835 MHz; Duty Cycle: 1:1

Medium: HSL 900 MHz

Medium parameters used: $f = 835$ MHz; $\sigma = 0.9$ mho/m; $\epsilon_r = 41.2$; $\rho = 1000$ kg/m³

Phantom section: Flat Section

Measurement Standard: DASY5 (IEEE/IEC)

DASY5 Configuration:

- Probe: ES3DV2 - SN3025; ConvF(5.97, 5.97, 5.97); Calibrated: 28.04.2008
- Sensor-Surface: 3.4mm (Mechanical Surface Detection)
- Electronics: DAE4 Sn601; Calibrated: 14.03.2008
- Phantom: Flat Phantom 4.9L; Type: QD000P49AA; Serial: 1001
- Measurement SW: DASY5, V5.0 Build 119; SEMCAD X Version 13.2 Build 87

Pin=250mW; dip=15mm; dist=3.4mm/Zoom Scan (7x7x7)/Cube 0:

Measurement grid: dx=5mm, dy=5mm, dz=5mm

Reference Value = 55.6 V/m; Power Drift = 0.018 dB

Peak SAR (extrapolated) = 3.44 W/kg

SAR(1 g) = 2.35 mW/g; SAR(10 g) = 1.54 mW/g

Maximum value of SAR (measured) = 2.65 mW/g

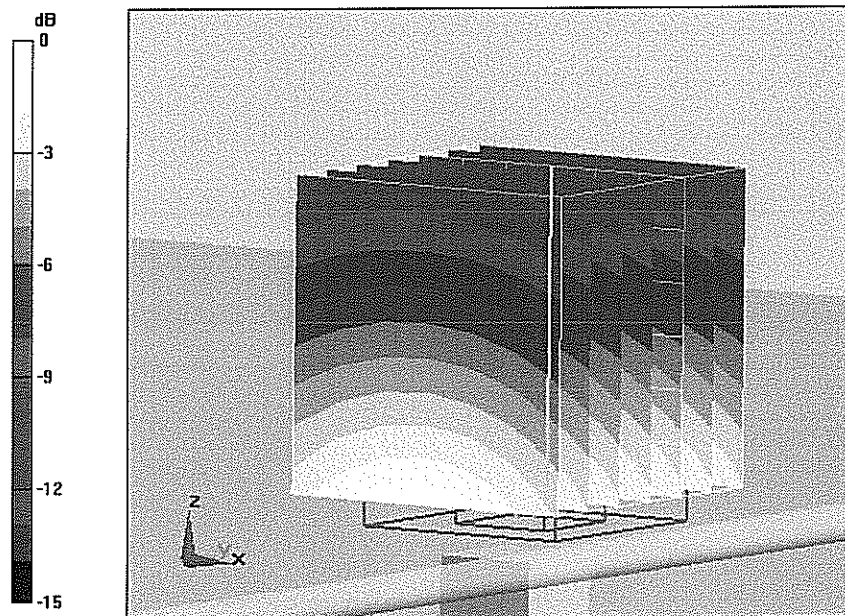

0 dB = 2.65mW/g

Impedance Measurement Plot for Head TSL

12 Sep 2008 08:54:47

CH1 S11 1 U FS 1: 47.260 Ω -1.6895 Ω 112.82 pF 835.000 000 MHz

*
Del
Cor

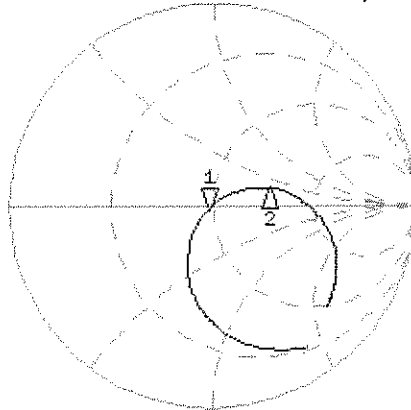

CH1 Markers
2: 85.566 Ω
15.328 Ω
900.000 MHz

Avg
16

↑

CH2 S11 LOG 5 dB/REF -20 dB 1: -29.633 dB 835.000 000 MHz

Cor

Avg
16

↑

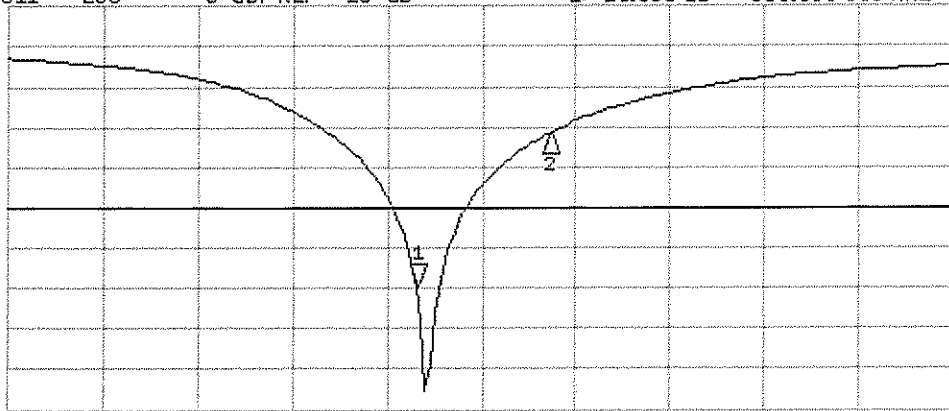

CH2 Markers
2: -10.854 dB
900.000 MHz

START 635.000 000 MHz

STOP 1 100.000 000 MHz

DASY5 Validation Report for Body TSL

Date/Time: 16.09.2008 10:27:28

Test Laboratory: SPEAG, Zurich, Switzerland

DUT: Dipole 835 MHz; Type: D835V2; Serial: D835V2 - SN:467

Communication System: CW; Frequency: 835 MHz; Duty Cycle: 1:1

Medium: MSL900

Medium parameters used: $f = 835 \text{ MHz}$; $\sigma = 1.01 \text{ mho/m}$; $\epsilon_r = 53.3$; $\rho = 1000 \text{ kg/m}^3$

Phantom section: Flat Section

Measurement Standard: DASY5 (IEEE/IEC)

DASY5 Configuration:

- Probe: ES3DV2 - SN3025; ConvF(5.9, 5.9, 5.9); Calibrated: 28.04.2008
- Sensor-Surface: 3.4mm (Mechanical Surface Detection)
- Electronics: DAE4 Sn601; Calibrated: 14.03.2008
- Phantom: Flat Phantom 4.9L; Type: QD000P49AA; Serial: 1001
- Measurement SW: DASY5, V5.0 Build 119; SEMCAD X Version 13.2 Build 87

Pin = 250mW, d = 15mm/Zoom Scan (7x7x7)/Cube 0:

Measurement grid: $dx=5\text{mm}$, $dy=5\text{mm}$, $dz=5\text{mm}$

Reference Value = 53.9 V/m; Power Drift = 0.046 dB

Peak SAR (extrapolated) = 3.61 W/kg

SAR(1 g) = 2.49 mW/g; SAR(10 g) = 1.64 mW/g

Maximum value of SAR (measured) = 2.79 mW/g

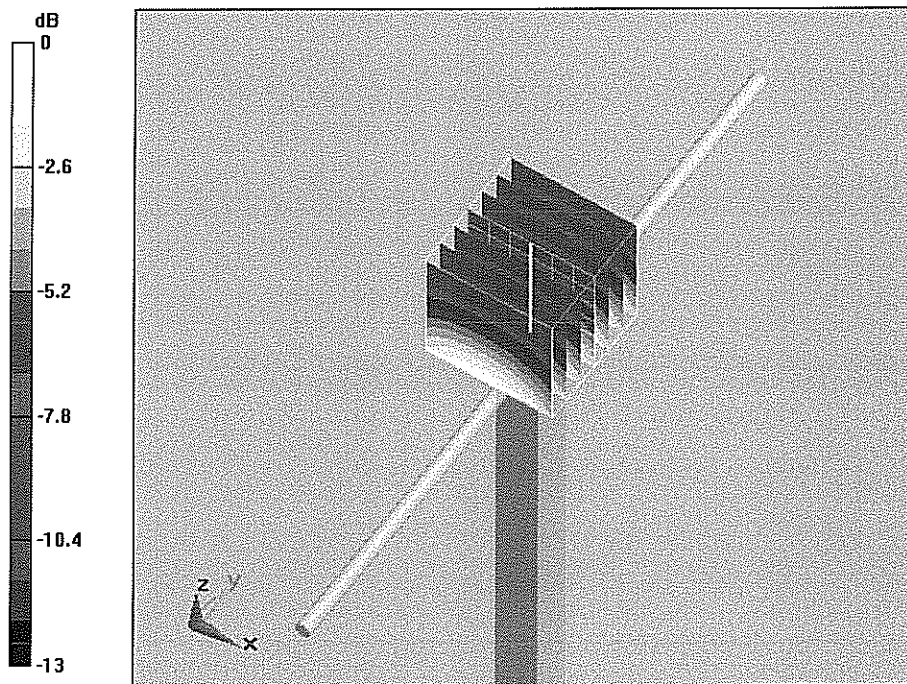

0 dB = 2.79mW/g

Impedance Measurement Plot for Body TSL

16 Sep 2008 09:01:56

[CH1] S11 1 U FS 1: 45.273 Ω -5.0977 Ω 37.391 μ F 835.000 000 MHz

*
De1
Cor

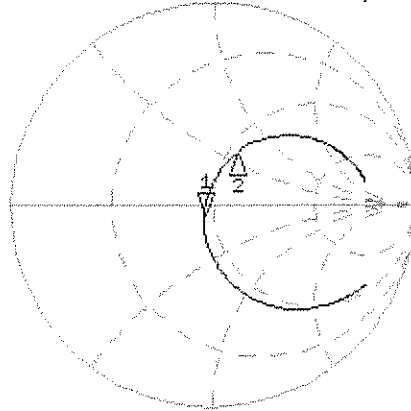

CH1 Markers
2: 54.469 Ω
23.291 Ω
900.000 MHz

Avg
15

↑

CH2 S11 LOG 5 dB/REF -20 dB 1: -22.753 dB 835.000 000 MHz

Cor

Avg
15

↑

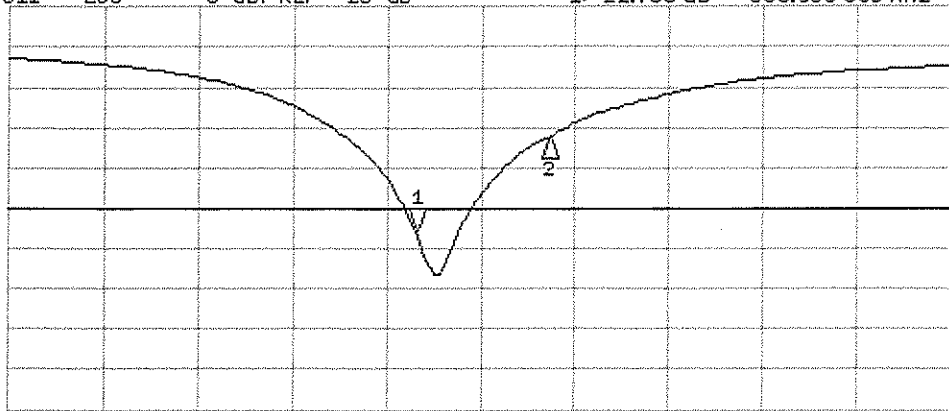

CH2 Markers
2: -11.275 dB
900.000 MHz

START 635.000 000 MHz

STOP 1 100.000 000 MHz



Accredited by the Swiss Accreditation Service (SAS)
The Swiss Accreditation Service is one of the signatories to the EA
Multilateral Agreement for the recognition of calibration certificates

Accreditation No.: **SCS 108**

Client **Kyocera USA**

Certificate No. **D1800V2-220_Nov07**

CALIBRATION CERTIFICATE

Object **D1800V2 - SN: 220**

Calibration procedure(s) **QA CAL-05.v7
Calibration procedure for dipole validation kits**

Calibration date: **November 13, 2007**

Condition of the calibrated item **In Tolerance**

This calibration certificate documents the traceability to national standards, which realize the physical units of measurements (SI).
The measurements and the uncertainties with confidence probability are given on the following pages and are part of the certificate.

All calibrations have been conducted in the closed laboratory facility: environment temperature (22 ± 3)°C and humidity < 70%.

Calibration Equipment used (M&TE critical for calibration)

| Primary Standards | ID # | Cal Date (Calibrated by, Certificate No.) | Scheduled Calibration |
|-----------------------------|------------------|---|------------------------|
| Power meter EPM-442A | GB37480704 | 04-Oct-07 (METAS, No. 217-00736) | Oct-08 |
| Power sensor HP 8481A | US37292783 | 04-Oct-07 (METAS, No. 217-00736) | Oct-08 |
| Reference 20 dB Attenuator | SN: 5086 (20g) | 07-Aug-07 (METAS, No 217-00718) | Aug-08 |
| Reference 10 dB Attenuator | SN: 5047.2 (10r) | 07-Aug-07 (METAS, No 217-00718) | Aug-08 |
| Reference Probe ET3DV6 (HF) | SN: 1507 | 26-Oct-07 (SPEAG, No. ET3-1507_Oct07) | Oct-08 |
| DAE4 | SN 601 | 30-Jan-07 (SPEAG, No. DAE4-601_Jan07) | Jan-08 |
| Secondary Standards | ID # | Check Date (in house) | Scheduled Check |
| Power sensor HP 8481A | MY41092317 | 18-Oct-02 (SPEAG, in house check Oct-07) | In house check: Oct-08 |
| RF generator R&S SMT-06 | 100005 | 4-Aug-99 (SPEAG, in house check Oct-07) | In house check: Oct-09 |
| Network Analyzer HP 8753E | US37390585 S4206 | 18-Oct-01 (SPEAG, in house check Oct-07) | In house check: Oct-08 |

Calibrated by: **Claudio Leubler** **Laboratory Technician** *[Signature]*

Approved by: **Katja Pokovic** **Technical Manager** *[Signature]*

Issued: November 15, 2007

This calibration certificate shall not be reproduced except in full without written approval of the laboratory.



Accredited by the Swiss Accreditation Service (SAS)
The Swiss Accreditation Service is one of the signatories to the EA
Multilateral Agreement for the recognition of calibration certificates

Accreditation No.: **SCS 108**

Glossary:

| | |
|-------|---------------------------------|
| TSL | tissue simulating liquid |
| ConvF | sensitivity in TSL / NORM x,y,z |
| N/A | not applicable or not measured |

Calibration is Performed According to the Following Standards:

- IEEE Std 1528-2003, "IEEE Recommended Practice for Determining the Peak Spatial-Averaged Specific Absorption Rate (SAR) in the Human Head from Wireless Communications Devices: Measurement Techniques", December 2003
- IEC 62209-1, "Procedure to measure the Specific Absorption Rate (SAR) for hand-held devices used in close proximity to the ear (frequency range of 300 MHz to 3 GHz)", February 2005
- Federal Communications Commission Office of Engineering & Technology (FCC OET), "Evaluating Compliance with FCC Guidelines for Human Exposure to Radiofrequency Electromagnetic Fields; Additional Information for Evaluating Compliance of Mobile and Portable Devices with FCC Limits for Human Exposure to Radiofrequency Emissions", Supplement C (Edition 01-01) to Bulletin 65

Additional Documentation:

- DASY4 System Handbook

Methods Applied and Interpretation of Parameters:

- Measurement Conditions:** Further details are available from the Validation Report at the end of the certificate. All figures stated in the certificate are valid at the frequency indicated.
- Antenna Parameters with TSL:** The dipole is mounted with the spacer to position its feed point exactly below the center marking of the flat phantom section, with the arms oriented parallel to the body axis.
- Feed Point Impedance and Return Loss:** These parameters are measured with the dipole positioned under the liquid filled phantom. The impedance stated is transformed from the measurement at the SMA connector to the feed point. The Return Loss ensures low reflected power. No uncertainty required.
- Electrical Delay:** One-way delay between the SMA connector and the antenna feed point. No uncertainty required.
- SAR measured:** SAR measured at the stated antenna input power.
- SAR normalized:** SAR as measured, normalized to an input power of 1 W at the antenna connector.
- SAR for nominal TSL parameters:** The measured TSL parameters are used to calculate the nominal SAR result.

Measurement Conditions

DASY system configuration, as far as not given on page 1.

| | | |
|------------------------------|---------------------------|-------------|
| DASY Version | DASY4 | V4.7 |
| Extrapolation | Advanced Extrapolation | |
| Phantom | Modular Flat Phantom V5.0 | |
| Distance Dipole Center - TSL | 10 mm | with Spacer |
| Zoom Scan Resolution | dx, dy, dz = 5 mm | |
| Frequency | 1800 MHz \pm 1 MHz | |

Head TSL parameters

The following parameters and calculations were applied.

| | Temperature | Permittivity | Conductivity |
|----------------------------------|---------------------|----------------|----------------------|
| Nominal Head TSL parameters | 22.0 °C | 40.0 | 1.40 mho/m |
| Measured Head TSL parameters | (22.0 \pm 0.2) °C | 38.8 \pm 6 % | 1.39 mho/m \pm 6 % |
| Head TSL temperature during test | (22.2 \pm 0.2) °C | — | — |

SAR result with Head TSL

| SAR averaged over 1 cm ³ (1 g) of Head TSL | condition | |
|---|--------------------|--|
| SAR measured | 250 mW input power | 9.57 mW /g |
| SAR normalized | normalized to 1W | 38.3 mW /g |
| SAR for nominal Head TSL parameters ¹ | normalized to 1W | 37.8 mW / g \pm 17.0 % (k=2) |

| SAR averaged over 10 cm ³ (10 g) of Head TSL | condition | |
|---|--------------------|--|
| SAR measured | 250 mW input power | 5.07 mW /g |
| SAR normalized | normalized to 1W | 20.3 mW /g |
| SAR for nominal Head TSL parameters ¹ | normalized to 1W | 20.1 mW / g \pm 16.5 % (k=2) |

¹ Correction to nominal TSL parameters according to d), chapter "SAR Sensitivities"

Body TSL parameters

The following parameters and calculations were applied.

| | Temperature | Permittivity | Conductivity |
|----------------------------------|-----------------|--------------|------------------|
| Nominal Body TSL parameters | 22.0 °C | 53.3 | 1.52 mho/m |
| Measured Body TSL parameters | (22.0 ± 0.2) °C | 53.6 ± 6 % | 1.47 mho/m ± 6 % |
| Body TSL temperature during test | (21.5 ± 0.2) °C | — | — |

SAR result with Body TSL

| SAR averaged over 1 cm ³ (1 g) of Body TSL | condition | |
|---|--------------------|-----------------------------------|
| SAR measured | 250 mW input power | 9.50 mW /g |
| SAR normalized | normalized to 1W | 38.0 mW /g |
| SAR for nominal Body TSL parameters ² | normalized to 1W | 38.8 mW / g ± 17.0 % (k=2) |

| SAR averaged over 10 cm ³ (10 g) of Body TSL | condition | |
|---|--------------------|-----------------------------------|
| SAR measured | 250 mW input power | 5.12 mW /g |
| SAR normalized | normalized to 1W | 20.5 mW /g |
| SAR for nominal Body TSL parameters ² | normalized to 1W | 20.7 mW / g ± 16.5 % (k=2) |

² Correction to nominal TSL parameters according to d), chapter "SAR Sensitivities"

Appendix

Antenna Parameters with Head TSL

| | |
|--------------------------------------|----------------------------------|
| Impedance, transformed to feed point | 46.7 j Ω - 3.1 j Ω |
| Return Loss | - 26.6 dB |

Antenna Parameters with Body TSL

| | |
|--------------------------------------|----------------------------------|
| Impedance, transformed to feed point | 42.4 j Ω - 4.0 j Ω |
| Return Loss | - 20.7 dB |

General Antenna Parameters and Design

| | |
|----------------------------------|----------|
| Electrical Delay (one direction) | 1.181 ns |
|----------------------------------|----------|

After long term use with 100W radiated power, only a slight warming of the dipole near the feedpoint can be measured.

The dipole is made of standard semirigid coaxial cable. The center conductor of the feeding line is directly connected to the second arm of the dipole. The antenna is therefore short-circuited for DC-signals.

No excessive force must be applied to the dipole arms, because they might bend or the soldered connections near the feedpoint may be damaged.

Additional EUT Data

| | |
|-----------------|-------------------|
| Manufactured by | SPEAG |
| Manufactured on | December 01, 1997 |

Test Laboratory: SPEAG, Zurich, Switzerland

DUT: Dipole 1800 MHz; Type: D1800V2; Serial: SN:220

Communication System: CW; Frequency: 1800 MHz; Duty Cycle: 1:1

Medium: HSL U10 BB;

Medium parameters used: $f = 1800$ MHz; $\sigma = 1.39$ mho/m; $\epsilon_r = 38.7$; $\rho = 1000$ kg/m³

Phantom section: Flat Section

Measurement Standard: DASY4 (High Precision Assessment)

DASY4 Configuration:

- Probe: ET3DV6 - SN1507 (HF); ConvF(4.99, 4.99, 4.99); Calibrated: 26.10.2007
- Sensor-Surface: 4mm (Mechanical Surface Detection)
- Electronics: DAE4 Sn601; Calibrated: 30.01.2007
- Phantom: Flat Phantom 5.0 (front); Type: QD000P50AA; ;
- Measurement SW: DASY4, V4.7 Build 55; Postprocessing SW: SEMCAD, V1.8 Build 172

Pin = 250 mW; d = 10 mm/Zoom Scan (7x7x7)/Cube 0:

Measurement grid: dx=5mm, dy=5mm, dz=5mm

Reference Value = 93.2 V/m; Power Drift = 0.029 dB

Peak SAR (extrapolated) = 16.6 W/kg

SAR(1 g) = 9.57 mW/g; SAR(10 g) = 5.07 mW/g

Maximum value of SAR (measured) = 10.7 mW/g

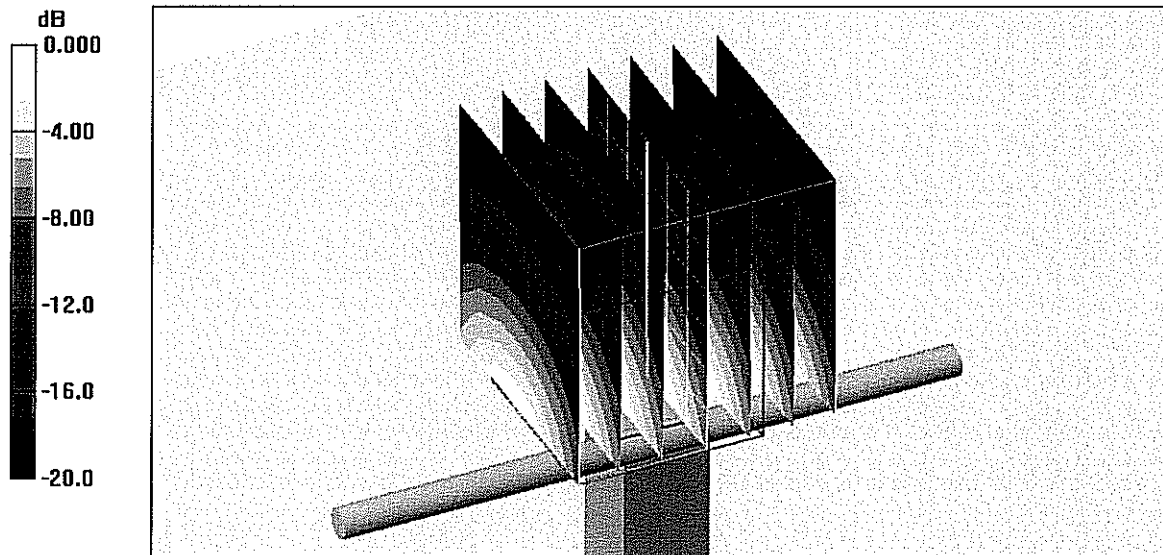

0 dB = 10.7mW/g

Impedance Measurement Plot for Head TSL

5 Nov 2007 11:44:57

CH1 S11 1 U FS 1: 46.709 Ω -3.0684 Ω 28.817 pF 1 800.000 000 MHz

*

De1

Ca

Avg
16

↑

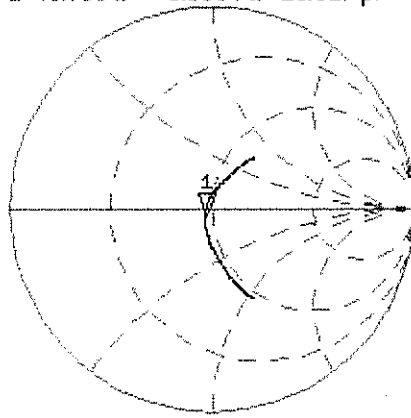

CH2 S11 LOG 5 dB/REF -20 dB 1:-26.649 dB 1 800.000 000 MHz

Ca

Avg
16

↑

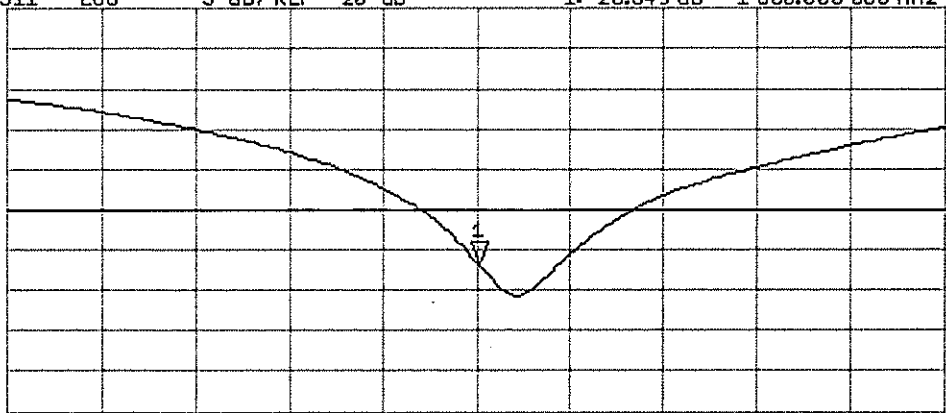

CENTER 1 800.000 000 MHz

SPAN 400.000 000 MHz

Test Laboratory: SPEAG, Zurich, Switzerland

DUT: Dipole 1800 MHz; Type: D1800V2; Serial: D1800V2 - SN:220

Communication System: CW; Frequency: 1800 MHz; Duty Cycle: 1:1

Medium: MSL U10 BB;

Medium parameters used: $f = 1800$ MHz; $\sigma = 1.47$ mho/m; $\epsilon_r = 53.6$; $\rho = 1000$ kg/m³

Phantom section: Flat Section

Measurement Standard: DASY4 (High Precision Assessment)

DASY4 Configuration:

- Probe: ET3DV6 - SN1507 (HF); ConvF(4.56, 4.56, 4.56); Calibrated: 26.10.2007
- Sensor-Surface: 4mm (Mechanical Surface Detection)
- Electronics: DAE4 Sn601; Calibrated: 30.01.2007
- Phantom: Flat Phantom 5.0 (back); Type: QD000P50AA; ;
- Measurement SW: DASY4, V4.7 Build 55; Postprocessing SW: SEMCAD, V1.8 Build 172

Pin = 250 mW; d = 10 mm/Zoom Scan (7x7x7)/Cube 0:

Measurement grid: dx=5mm, dy=5mm, dz=5mm

Reference Value = 91.8 V/m; Power Drift = -0.026 dB

Peak SAR (extrapolated) = 16.1 W/kg

SAR(1 g) = 9.5 mW/g; SAR(10 g) = 5.12 mW/g

Maximum value of SAR (measured) = 10.8 mW/g

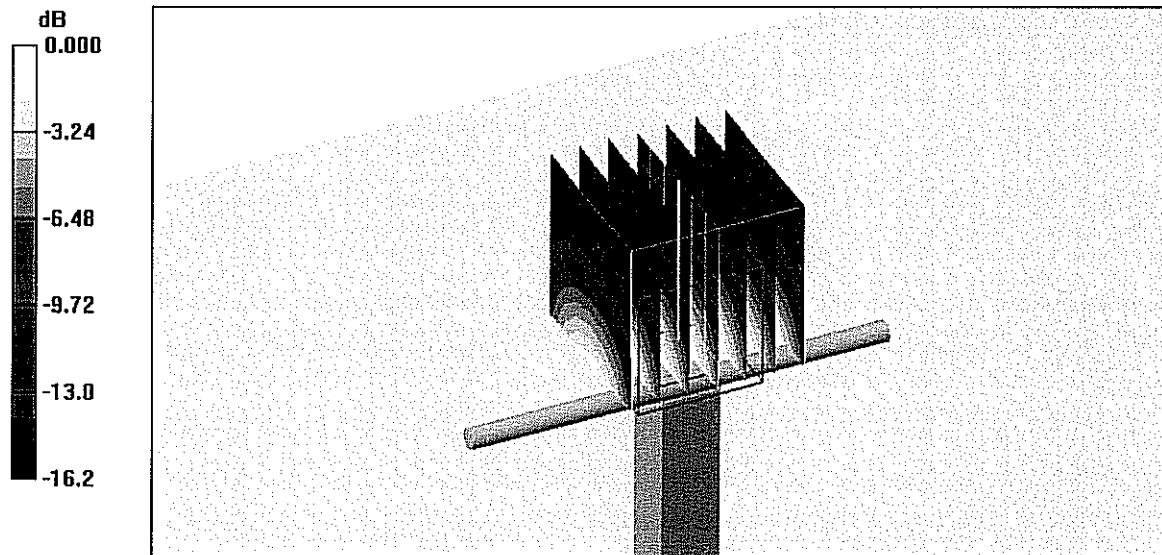

0 dB = 10.8mW/g

Impedance Measurement Plot for Body TSL

13 Nov 2007 10:21:32

CH1 S11 1 U FS 1: 42.412 Ω -3.9707 Ω 22.268 pF 1 800.000 000 MHz

*
De1
Cor
Avg
16
↑

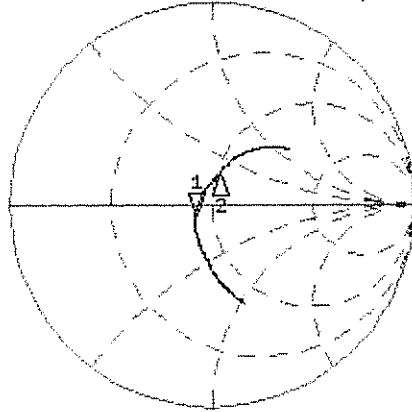

CH1 Markers
2: 51.301 Ω
14.910 Ω
1.90000 GHz

CH2 S11 LOG 5 dB/REF -20 dB 1:-20.670 dB 1 800.000 000 MHz

Cor
Avg
16
↑

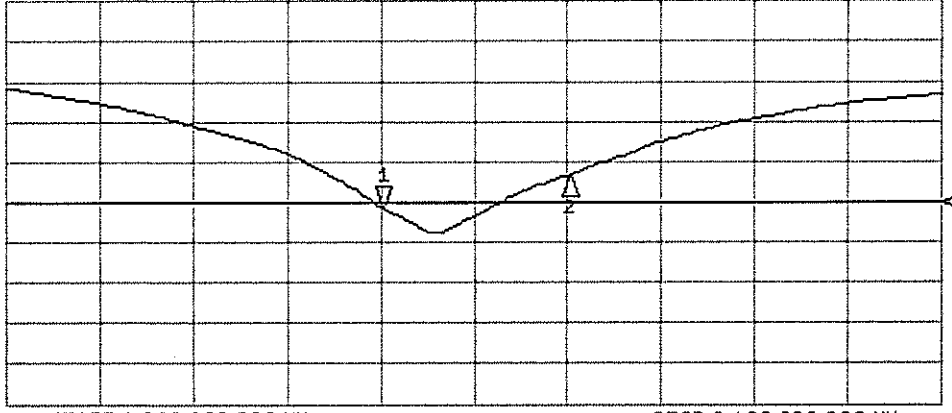

CH2 Markers
2:-16.702 dB
1.90000 GHz



Accredited by the Swiss Accreditation Service (SAS)
 The Swiss Accreditation Service is one of the signatories to the EA
 Multilateral Agreement for the recognition of calibration certificates

Accreditation No.: **SCS 108**

Client **Kyocera USA**

Certificate No: **D1900V2-5d016-Sep08**

CALIBRATION CERTIFICATE

Object **D1900V2 - SN: 5d016**

Calibration procedure(s) **QA CAL-05.v7
 Calibration procedure for dipole validation kits**

Calibration date: **September 15, 2008**

Condition of the calibrated item **In Tolerance**

This calibration certificate documents the traceability to national standards, which realize the physical units of measurements (SI).
 The measurements and the uncertainties with confidence probability are given on the following pages and are part of the certificate.

All calibrations have been conducted in the closed laboratory facility: environment temperature (22 ± 3)°C and humidity < 70%.

Calibration Equipment used (M&TE critical for calibration)

| Primary Standards | ID # | Cal Date (Calibrated by, Certificate No.) | Scheduled Calibration |
|-----------------------------|--------------------|---|------------------------|
| Power meter EPM-442A | GB37480704 | 04-Oct-07 (No. 217-00736) | Oct-08 |
| Power sensor HP 8481A | US37292783 | 04-Oct-07 (No. 217-00736) | Oct-08 |
| Reference 20 dB Attenuator | SN: 5086 (20g) | 01-Jul-08 (No. 217-00864) | Jul-09 |
| Type-N mismatch combination | SN: 5047.2 / 06327 | 01-Jul-08 (No. 217-00867) | Jul-09 |
| Reference Probe ES3DV2 | SN: 3025 | 28-Apr-08 (No. ES3-3025_Apr08) | Apr-09 |
| DAE4 | SN: 601 | 14-Mar-08 (No. DAE4-601_Mar08) | Mar-09 |
| Secondary Standards | ID # | Check Date (in house) | Scheduled Check |
| Power sensor HP 8481A | MY41092317 | 18-Oct-02 (in house check Oct-07) | In house check: Oct-09 |
| RF generator R&S SMT-06 | 100005 | 4-Aug-99 (in house check Oct-07) | In house check: Oct-09 |
| Network Analyzer HP 8753E | US37390585 S4206 | 18-Oct-01 (in house check Oct-07) | In house check: Oct-08 |

Calibrated by: **Jeton Kastrati** (Name), **Laboratory Technician** (Function), *[Signature]* (Signature)

Approved by: **Katja Pokovic** (Name), **Technical Manager** (Function), *[Signature]* (Signature)

Issued: September 17, 2008

This calibration certificate shall not be reproduced except in full without written approval of the laboratory.



Accredited by the Swiss Accreditation Service (SAS)
The Swiss Accreditation Service is one of the signatories to the EA
Multilateral Agreement for the recognition of calibration certificates

Accreditation No.: **SCS 108**

Glossary:

| | |
|-------|---------------------------------|
| TSL | tissue simulating liquid |
| ConvF | sensitivity in TSL / NORM x,y,z |
| N/A | not applicable or not measured |

Calibration is Performed According to the Following Standards:

- IEEE Std 1528-2003, "IEEE Recommended Practice for Determining the Peak Spatial-Averaged Specific Absorption Rate (SAR) in the Human Head from Wireless Communications Devices: Measurement Techniques", December 2003
- CENELEC EN 50361, "Basic standard for the measurement of Specific Absorption Rate related to human exposure to electromagnetic fields from mobile phones (300 MHz - 3 GHz), July 2001
- Federal Communications Commission Office of Engineering & Technology (FCC OET), "Evaluating Compliance with FCC Guidelines for Human Exposure to Radiofrequency Electromagnetic Fields; Additional Information for Evaluating Compliance of Mobile and Portable Devices with FCC Limits for Human Exposure to Radiofrequency Emissions", Supplement C (Edition 01-01) to Bulletin 65

Additional Documentation:

- DASY4/5 System Handbook

Methods Applied and Interpretation of Parameters:

- Measurement Conditions:* Further details are available from the Validation Report at the end of the certificate. All figures stated in the certificate are valid at the frequency indicated.
- Antenna Parameters with TSL:* The dipole is mounted with the spacer to position its feed point exactly below the center marking of the flat phantom section, with the arms oriented parallel to the body axis.
- Feed Point Impedance and Return Loss:* These parameters are measured with the dipole positioned under the liquid filled phantom. The impedance stated is transformed from the measurement at the SMA connector to the feed point. The Return Loss ensures low reflected power. No uncertainty required.
- Electrical Delay:* One-way delay between the SMA connector and the antenna feed point. No uncertainty required.
- SAR measured:* SAR measured at the stated antenna input power.
- SAR normalized:* SAR as measured, normalized to an input power of 1 W at the antenna connector.
- SAR for nominal TSL parameters:* The measured TSL parameters are used to calculate the nominal SAR result.

Measurement Conditions

DASY system configuration, as far as not given on page 1.

| | | |
|-------------------------------------|---------------------------|-------------|
| DASY Version | DASY5 | V5.0 |
| Extrapolation | Advanced Extrapolation | |
| Phantom | Modular Flat Phantom V5.0 | |
| Distance Dipole Center - TSL | 10 mm | with Spacer |
| Zoom Scan Resolution | dx, dy, dz = 5 mm | |
| Frequency | 1900 MHz \pm 1 MHz | |

Head TSL parameters

The following parameters and calculations were applied.

| | Temperature | Permittivity | Conductivity |
|---|---------------------|----------------|----------------------|
| Nominal Head TSL parameters | 22.0 °C | 40.0 | 1.40 mho/m |
| Measured Head TSL parameters | (22.0 \pm 0.2) °C | 40.7 \pm 6 % | 1.47 mho/m \pm 6 % |
| Head TSL temperature during test | (21.5 \pm 0.2) °C | --- | --- |

SAR result with Head TSL

| SAR averaged over 1 cm³ (1 g) of Head TSL | condition | |
|---|--------------------|--|
| SAR measured | 250 mW input power | 10.3 mW / g |
| SAR normalized | normalized to 1W | 41.2 mW / g |
| SAR for nominal Head TSL parameters ¹ | normalized to 1W | 40.6 mW / g \pm 17.0 % (k=2) |

| SAR averaged over 10 cm³ (10 g) of Head TSL | Condition | |
|---|--------------------|--|
| SAR measured | 250 mW input power | 5.37 mW / g |
| SAR normalized | normalized to 1W | 21.5 mW / g |
| SAR for nominal Head TSL parameters ¹ | normalized to 1W | 21.4 mW / g \pm 16.5 % (k=2) |

¹ Correction to nominal TSL parameters according to d), chapter "SAR Sensitivities"

Body TSL parameters

The following parameters and calculations were applied.

| | Temperature | Permittivity | Conductivity |
|----------------------------------|-----------------|--------------|-----------------|
| Nominal Body TSL parameters | 22.0 °C | 53.3 | 1.52 mho/m |
| Measured Body TSL parameters | (22.0 ± 0.2) °C | 52.1 ± 6 % | 1.6 mho/m ± 6 % |
| Body TSL temperature during test | (21.5 ± 0.2) °C | --- | --- |

SAR result with Body TSL

| SAR averaged over 1 cm ³ (1 g) of Body TSL | Condition | |
|---|--------------------|-----------------------------------|
| SAR measured | 250 mW input power | 10.2 mW / g |
| SAR normalized | normalized to 1W | 40.8 mW / g |
| SAR for nominal Body TSL parameters ² | normalized to 1W | 39.1 mW / g ± 17.0 % (k=2) |

| SAR averaged over 10 cm ³ (10 g) of Body TSL | condition | |
|---|--------------------|-----------------------------------|
| SAR measured | 250 mW input power | 5.31 mW / g |
| SAR normalized | normalized to 1W | 21.2 mW / g |
| SAR for nominal Body TSL parameters ² | normalized to 1W | 20.8 mW / g ± 16.5 % (k=2) |

² Correction to nominal TSL parameters according to d), chapter "SAR Sensitivities"

Appendix

Antenna Parameters with Head TSL

| | |
|--------------------------------------|-----------------------------|
| Impedance, transformed to feed point | $51.9 \Omega + 4.5 j\Omega$ |
| Return Loss | - 26.4 dB |

Antenna Parameters with Body TSL

| | |
|--------------------------------------|-----------------------------|
| Impedance, transformed to feed point | $47.0 \Omega + 4.8 j\Omega$ |
| Return Loss | - 24.7 dB |

General Antenna Parameters and Design

| | |
|----------------------------------|----------|
| Electrical Delay (one direction) | 1.195 ns |
|----------------------------------|----------|

After long term use with 100W radiated power, only a slight warming of the dipole near the feedpoint can be measured.

The dipole is made of standard semirigid coaxial cable. The center conductor of the feeding line is directly connected to the second arm of the dipole. The antenna is therefore short-circuited for DC-signals.

No excessive force must be applied to the dipole arms, because they might bend or the soldered connections near the feedpoint may be damaged.

Additional EUT Data

| | |
|-----------------|---------------|
| Manufactured by | SPEAG |
| Manufactured on | June 04, 2002 |

DASY5 Validation Report for Head TSL

Date/Time: 11.09.2008 14:48:18

Test Laboratory: SPEAG, Zurich, Switzerland

DUT: Dipole 1900 MHz; Type: D1900V2; Serial: D1900V2 - SN:5d016

Communication System: CW; Frequency: 1900 MHz; Duty Cycle: 1:1

Medium: HSL U10 BB

Medium parameters used: $f = 1900$ MHz; $\sigma = 1.47$ mho/m; $\epsilon_r = 40.7$; $\rho = 1000$ kg/m³

Phantom section: Flat Section

Measurement Standard: DASY5 (IEEE/IEC)

DASY5 Configuration:

- Probe: ES3DV2 - SN3025; ConvF(4.9, 4.9, 4.9); Calibrated: 28.04.2008
- Sensor-Surface: 3.4mm (Mechanical Surface Detection)
- Electronics: DAE4 Sn601; Calibrated: 14.03.2008
- Phantom: Flat Phantom 5.0 (front); Type: QD000P50AA; Serial: 1001
- Measurement SW: DASY5, V5.0 Build 119; SEMCAD X Version 13.2 Build 87

Pin = 250 mW; dip = 10 mm, scan at 3.4mm/Zoom Scan (dist=3.4mm, probe 0deg)

(7x7x7)/Cube 0: Measurement grid: dx=5mm, dy=5mm, dz=5mm

Reference Value = 93.2 V/m; Power Drift = 0.00747 dB

Peak SAR (extrapolated) = 19 W/kg

SAR(1 g) = 10.3 mW/g; SAR(10 g) = 5.37 mW/g

Maximum value of SAR (measured) = 12.2 mW/g

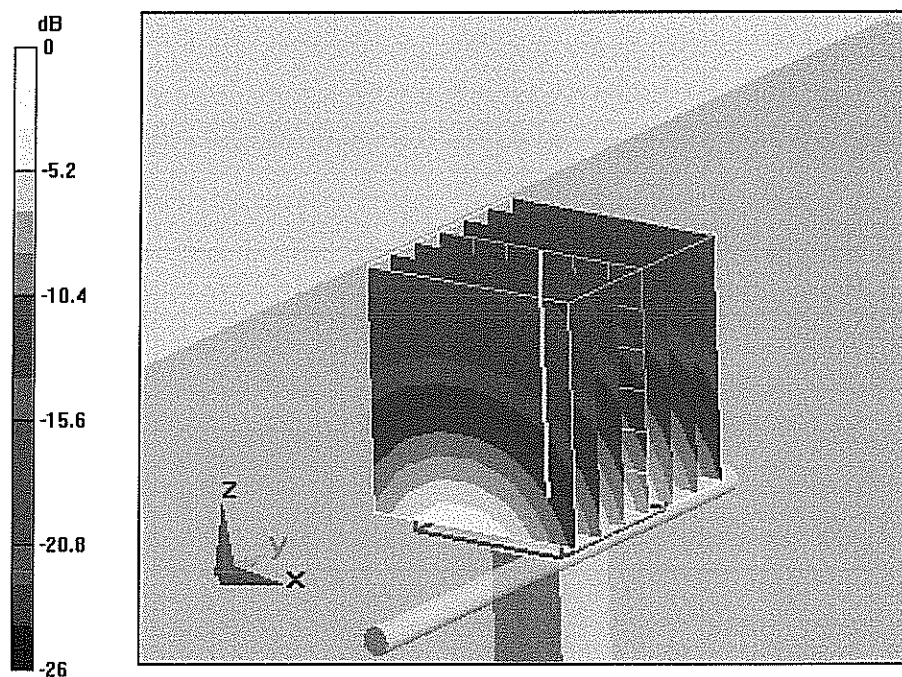

0 dB = 12.2mW/g

Impedance Measurement Plot for Head TSL

11 Sep 2008 11:06:53

CH1 S11 1 U FS 2: 51.904 Ω 4.5098 Ω 377.76 μH 1 900.000 000 MHz

*
De1
Cor

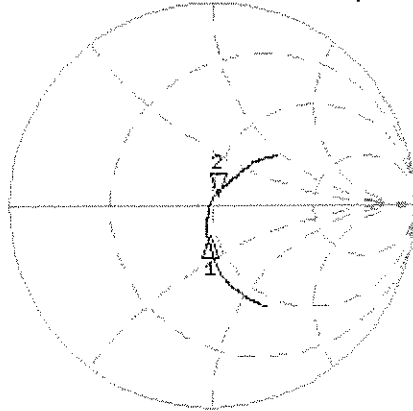

CH1 Markers
1: 46.000 Ω
-15.488 Ω
1.80000 GHz

Avg
16

↑

CH2 S11 LOG 5 dB/REF -20 dB 2: -26.355 dB 1 900.000 000 MHz

Cor

Avg
16

↑

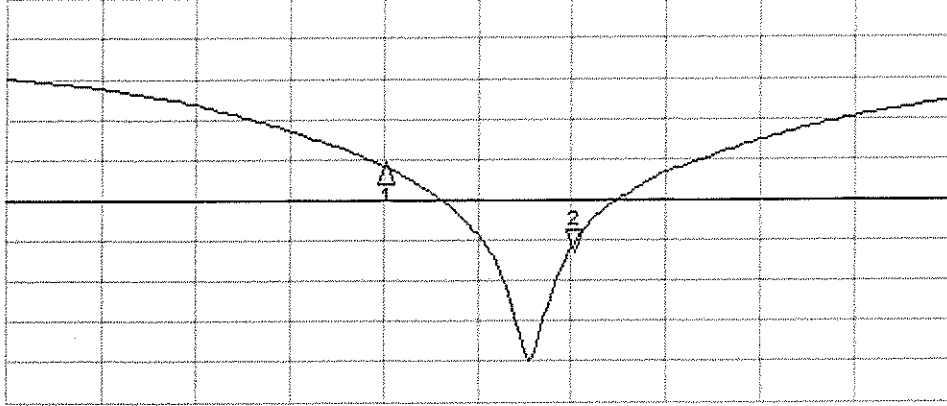

CH2 Markers
1: -15.678 dB
1.80000 GHz

START 1 600.000 000 MHz

STOP 2 100.000 000 MHz

DASY5 Validation Report for Body TSL

Date/Time: 15.09.2008 14:13:19

Test Laboratory: SPEAG, Zurich, Switzerland

DUT: Dipole 1900 MHz; Type: D1900V2; Serial: D1900V2 - SN:5d016

Communication System: CW; Frequency: 1900 MHz; Duty Cycle: 1:1

Medium: MSL U10 BB

Medium parameters used: $f = 1900$ MHz; $\sigma = 1.6$ mho/m; $\epsilon_r = 52.1$; $\rho = 1000$ kg/m³

Phantom section: Flat Section

Measurement Standard: DASY5 (IEEE/IEC)

DASY5 Configuration:

- Probe: ES3DV2 - SN3025; ConvF(4.5, 4.5, 4.5); Calibrated: 28.04.2008
- Sensor-Surface: 3.4mm (Mechanical Surface Detection)
- Electronics: DAE4 Sn601; Calibrated: 14.03.2008
- Phantom: Flat Phantom 5.0 (back); Type: QD000P50AA; Serial: 1002
- Measurement SW: DASY5, V5.0 Build 119; SEMCAD X Version 13.2 Build 87

Pin = 250 mW; dip = 10 mm, scan at 3.4mm/Zoom Scan (dist=3.4mm, probe 0deg)

(7x7x7)/Cube 0: Measurement grid: dx=5mm, dy=5mm, dz=5mm

Reference Value = 91.3 V/m; Power Drift = 0.00376 dB

Peak SAR (extrapolated) = 18.3 W/kg

SAR(1 g) = 10.2 mW/g; SAR(10 g) = 5.31 mW/g

Maximum value of SAR (measured) = 12.5 mW/g

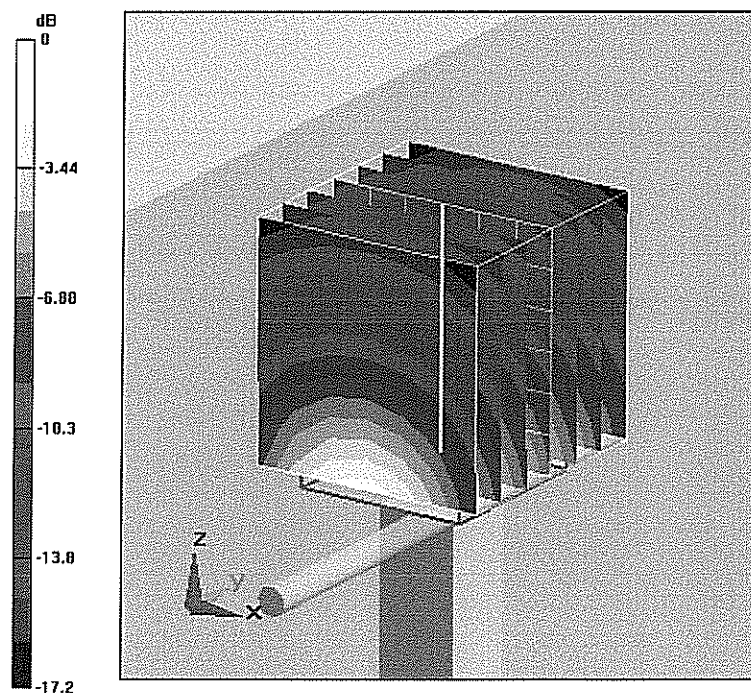

0 dB = 12.5mW/g

Impedance Measurement Plot for Body TSL

15 Sep 2008 10:28:12

CH1 S11 1 U FS 2: 47.039 Ω 4.8457 Ω 405.90 μ H 1 900.000 000 MHz

*
Del
Cor

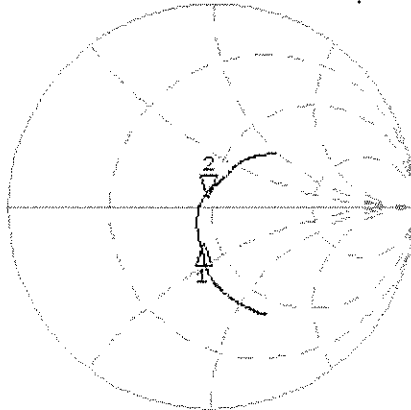

CH1 Markers
1: 47.418 Ω
-15.305 Ω
1.00000 GHz

Avg
16

↑

CH2 S11 LOG 5 dB/ REF -20 dB 2: -24.662 dB 1 900.000 000 MHz

Cor

Avg
16

↑

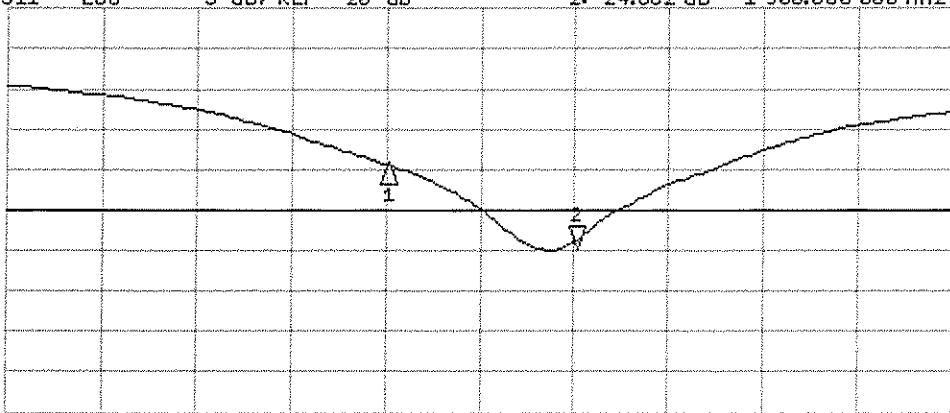

CH2 Markers
1: -14.352 dB
1.00000 GHz

START 1 600.000 000 MHz

STOP 2 100.000 000 MHz



Accredited by the Swiss Accreditation Service (SAS)
The Swiss Accreditation Service is one of the signatories to the EA
Multilateral Agreement for the recognition of calibration certificates

Accreditation No.: **SCS 108**

Client **Kyocera USA**

Certificate No: **D2450V2-776_Aug08**

CALIBRATION CERTIFICATE

Object **D2450V2 - SN: 776**

Calibration procedure(s) **QA CAL-05.v7
Calibration procedure for dipole validation kits**

Calibration date: **August 20, 2008**

Condition of the calibrated item **In Tolerance**

This calibration certificate documents the traceability to national standards, which realize the physical units of measurements (SI).
The measurements and the uncertainties with confidence probability are given on the following pages and are part of the certificate.

All calibrations have been conducted in the closed laboratory facility: environment temperature (22 ± 3)°C and humidity < 70%.

Calibration Equipment used (M&TE critical for calibration)

| Primary Standards | ID # | Cal Date (Certificate No.) | Scheduled Calibration |
|-----------------------------|--------------------|--------------------------------|-----------------------|
| Power meter EPM-442A | GB37480704 | 04-Oct-07 (No. 217-00736) | Oct-08 |
| Power sensor HP 8481A | US37292783 | 04-Oct-07 (No. 217-00736) | Oct-08 |
| Reference 20 dB Attenuator | SN: S5086 (20g) | 01-Jul-08 (No. 217-00864) | Jul-09 |
| Type-N mismatch combination | SN: 5047.2 / 06327 | 01-Jul-08 (No. 217-00867) | Jul-09 |
| Reference Probe ES3DV2 | SN: 3025 | 28-Apr-08 (No. ES3-3025_Apr08) | Apr-09 |
| DAE4 | SN: 601 | 14-Mar-08 (No. DAE4-601_Mar08) | Mar-09 |

| Secondary Standards | ID # | Check Date (in house) | Scheduled Check |
|---------------------------|------------------|-----------------------------------|------------------------|
| Power sensor HP 8481A | MY41092317 | 18-Oct-02 (in house check Oct-07) | In house check: Oct-09 |
| RF generator R&S SMT-06 | 100005 | 4-Aug-99 (in house check Oct-07) | In house check: Oct-09 |
| Network Analyzer HP 8753E | US37390585 S4206 | 18-Oct-01 (in house check Oct-07) | In house check: Oct-08 |

Calibrated by: **Jeton Kastrati** Laboratory Technician

Approved by: **Katja Pokovic** Technical Manager

Signature
[Handwritten signatures]

Issued: August 26, 2008

This calibration certificate shall not be reproduced except in full without written approval of the laboratory.



Accredited by the Swiss Accreditation Service (SAS)
The Swiss Accreditation Service is one of the signatories to the EA
Multilateral Agreement for the recognition of calibration certificates

Accreditation No.: **SCS 108**

Glossary:

| | |
|-------|---------------------------------|
| TSL | tissue simulating liquid |
| ConvF | sensitivity in TSL / NORM x,y,z |
| N/A | not applicable or not measured |

Calibration is Performed According to the Following Standards:

- IEEE Std 1528-2003, "IEEE Recommended Practice for Determining the Peak Spatial-Averaged Specific Absorption Rate (SAR) in the Human Head from Wireless Communications Devices: Measurement Techniques", December 2003
- IEC 62209-1, "Procedure to measure the Specific Absorption Rate (SAR) for hand-held devices used in close proximity to the ear (frequency range of 300 MHz to 3 GHz)", February 2005
- Federal Communications Commission Office of Engineering & Technology (FCC OET), "Evaluating Compliance with FCC Guidelines for Human Exposure to Radiofrequency Electromagnetic Fields; Additional Information for Evaluating Compliance of Mobile and Portable Devices with FCC Limits for Human Exposure to Radiofrequency Emissions", Supplement C (Edition 01-01) to Bulletin 65

Additional Documentation:

- DASY4/5 System Handbook

Methods Applied and Interpretation of Parameters:

- Measurement Conditions:** Further details are available from the Validation Report at the end of the certificate. All figures stated in the certificate are valid at the frequency indicated.
- Antenna Parameters with TSL:** The dipole is mounted with the spacer to position its feed point exactly below the center marking of the flat phantom section, with the arms oriented parallel to the body axis.
- Feed Point Impedance and Return Loss:** These parameters are measured with the dipole positioned under the liquid filled phantom. The impedance stated is transformed from the measurement at the SMA connector to the feed point. The Return Loss ensures low reflected power. No uncertainty required.
- Electrical Delay:** One-way delay between the SMA connector and the antenna feed point. No uncertainty required.
- SAR measured:** SAR measured at the stated antenna input power.
- SAR normalized:** SAR as measured, normalized to an input power of 1 W at the antenna connector.
- SAR for nominal TSL parameters:** The measured TSL parameters are used to calculate the nominal SAR result.

Measurement Conditions

DASY system configuration, as far as not given on page 1.

| | | |
|-------------------------------------|---------------------------|-------------|
| DASY Version | DASY5 | V5.0 |
| Extrapolation | Advanced Extrapolation | |
| Phantom | Modular Flat Phantom V5.0 | |
| Distance Dipole Center - TSL | 10 mm | with Spacer |
| Zoom Scan Resolution | dx, dy, dz = 5 mm | |
| Frequency | 2450 MHz \pm 1 MHz | |

Body TSL parameters

The following parameters and calculations were applied.

| | Temperature | Permittivity | Conductivity |
|---|---------------------|----------------|----------------------|
| Nominal Body TSL parameters | 22.0 °C | 52.7 | 1.95 mho/m |
| Measured Body TSL parameters | (22.0 \pm 0.2) °C | 51.4 \pm 6 % | 2.01 mho/m \pm 6 % |
| Body TSL temperature during test | (22.0 \pm 0.2) °C | --- | --- |

SAR result with Body TSL

| SAR averaged over 1 cm³ (1 g) of Body TSL | Condition | |
|---|--------------------|--|
| SAR measured | 250 mW input power | 12.6 mW / g |
| SAR normalized | normalized to 1W | 50.4 mW / g |
| SAR for nominal Body TSL parameters ¹ | normalized to 1W | 49.0 mW / g \pm 17.0 % (k=2) |

| SAR averaged over 10 cm³ (10 g) of Body TSL | condition | |
|---|--------------------|--|
| SAR measured | 250 mW input power | 5.87 mW / g |
| SAR normalized | normalized to 1W | 23.5 mW / g |
| SAR for nominal Body TSL parameters ¹ | normalized to 1W | 23.1 mW / g \pm 16.5 % (k=2) |

¹ Correction to nominal TSL parameters according to d), chapter "SAR Sensitivities"

Appendix

Antenna Parameters with Body TSL

| | |
|--------------------------------------|-----------------------------|
| Impedance, transformed to feed point | $50.5 \Omega + 9.9 j\Omega$ |
| Return Loss | - 20.2 dB |

General Antenna Parameters and Design

| | |
|----------------------------------|----------|
| Electrical Delay (one direction) | 1.158 ns |
|----------------------------------|----------|

After long term use with 100W radiated power, only a slight warming of the dipole near the feedpoint can be measured.

The dipole is made of standard semirigid coaxial cable. The center conductor of the feeding line is directly connected to the second arm of the dipole. The antenna is therefore short-circuited for DC-signals.

No excessive force must be applied to the dipole arms, because they might bend or the soldered connections near the feedpoint may be damaged.

Additional EUT Data

| | |
|-----------------|----------------|
| Manufactured by | SPEAG |
| Manufactured on | April 04, 2005 |

DASY5 Validation Report for Body TSL

Date/Time: 20.08.2008 15:08:14

Test Laboratory: SPEAG, Zurich, Switzerland

DUT: Dipole 2450 MHz; Type: D2450V2; Serial: D2450V2 - SN:776

Communication System: CW; Frequency: 2450 MHz; Duty Cycle: 1:1

Medium: MSL U10 BB

Medium parameters used: $f = 2450$ MHz; $\sigma = 2.01$ mho/m; $\epsilon_r = 51.4$; $\rho = 1000$ kg/m³

Phantom section: Flat Section

Measurement Standard: DASY5 (IEEE/IEC)

DASY5 Configuration:

- Probe: ES3DV2 - SN3025; ConvF(4.07, 4.07, 4.07); Calibrated: 28.04.2008
- Sensor-Surface: 3.4mm (Mechanical Surface Detection)
- Electronics: DAE4 Sn601; Calibrated: 14.03.2008
- Phantom: Flat Phantom 5.0 (back); Type: QD000P50AA; Serial: 1002
- Measurement SW: DASY5, V5.0 Build 119; SEMCAD X Version 13.2 Build 87

Pin = 250 mW; d = 10 mm/Zoom Scan (7x7x7)/Cube 0: Measurement grid: dx=5mm, dy=5mm, dz=5mm

Reference Value = 91.3 V/m; Power Drift = 0.016 dB

Peak SAR (extrapolated) = 25.2 W/kg

SAR(1 g) = 12.6 mW/g; SAR(10 g) = 5.87 mW/g

Maximum value of SAR (measured) = 15.8 mW/g

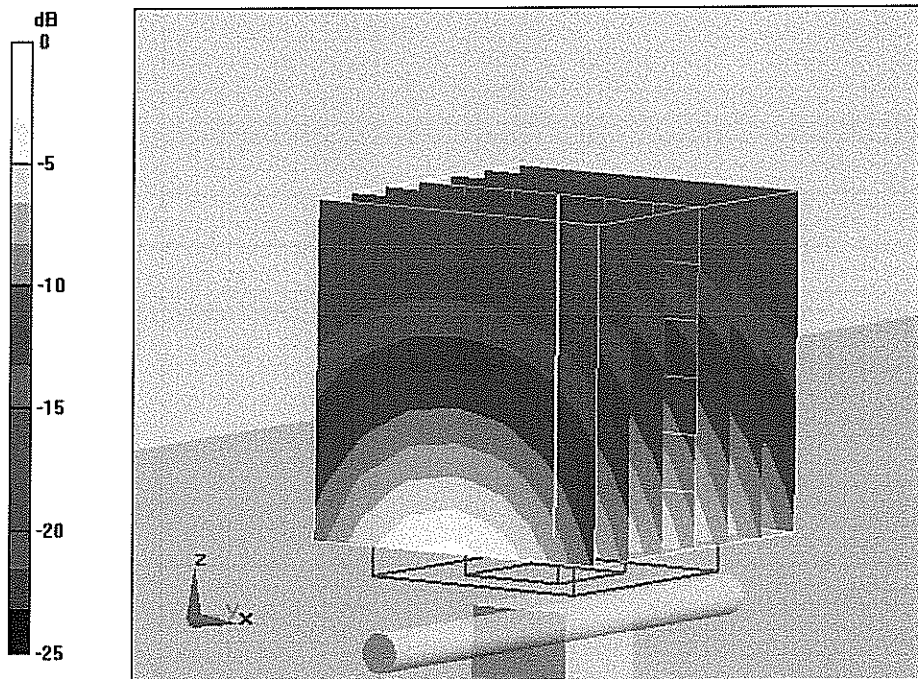

0 dB = 15.8mW/g

Impedance Measurement Plot for Body TSL

20 Aug 2008 13:00:58

CH1 S11 1 U FS 1: 50.514 Ω 9.2750 Ω 641.49 μH 2 450.000 000 MHz

*
De1
Cor
Avg
16

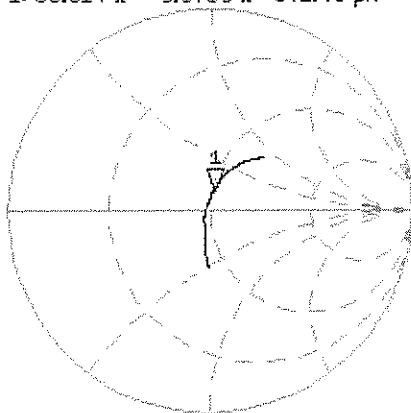

CH2 S11 LOG 5 dB/REF -20 dB 1:-20.183 dB 2 450.000 000 MHz

Cor
Avg
16

