

Hearing Aid Compatibility

FCC 47 CFR section 20.19 Test Report

Tri-Band CDMA Cellular Phone with Bluetooth	
FCC ID:	OVFKWC-K3802
Model:	K38-02

STATEMENT OF CERTIFICATION			
<i>The data, data evaluation and equipment configuration represented herein are a true and accurate representation of the measurements of the sample's HAC RF emissions characteristics as of the dates and at the times of the test under the conditions herein specified.</i>			
STATEMENT OF COMPLIANCE			
<i>This product was tested in accordance with the measurement procedures specified in ANSI C63.19-2006 and has been shown to be capable of compliance with the technical requirements of FCC 47 CFR section 20.19.</i>			
Test Location:	Kyocera Wireless Corp. 10300 Campus Point Drive, San Diego, CA 92121 USA		
Test performed by:	Binh Thai Test Technician	Date of Test:	07/11/08 – 08/25/08
Report Prepared by:	Thuy To Regulatory Engineer	Date of Report:	08/25/08 – 08/27/08
Report Reviewed by:	C. K. Li Director of Regulatory Engineering	Date of Review:	08/27/08

TABLE OF CONTENTS

1 Introduction 3

2 Equipment Under Test (EUT)..... 3

3 Summary of Test Results..... 3

4 Test conditions 4

 4.1 Ambient Conditions 4

 4.2 RF characteristics of the test site 4

 4.3 Test Signal, Frequencies and Output Power 4

 4.4 EUT Operating Conditions..... 5

5 Description of the test equipment 5

 5.1 Test Equipment Used 5

 5.2 Near Field Measurement System..... 6

 5.3 Isotropic E-Field Probe 6

 5.4 Isotropic H-Field Probe 7

6 System Validation 8

7 Description Of The Test Procedure 9

 7.1 Test Positions 9

 7.2 RF Emission Measurements Reference and Plane 9

 7.3 RF Emissions Measurement Procedures..... 10

 7.4 Probe Modulation Factor (PMF) 11

 7.4.1 Measurement Procedures..... 11

 7.4.2 PMF Test Results..... 12

 7.4.3 PMF Peak Power Measurement Plots 13

8 Emission Data Extraction and Post processing..... 16

9 Measurement Uncertainty 17

10 RF Emissions Tests..... 18

 10.1 Emission Limits..... 18

 10.2 CDMA 800 Test Results 19

 10.3 CDMA 1700 Test Results 20

 10.4 CDMA 1900 Test Results 21

 10.4 Worst-Case Configuration Evaluation 22

 10.4.1 Peak Reading 360° Probe Rotation at Azimuth axis..... 22

11 Appendix A: Probe Calibration Certification 23

12 Appendix B: System Validation Plots..... 25

13 Appendix C: Test Results/Plots 25

14 Appendix D: Photo Test Setup..... 25

1 Introduction

This test report describes the Hearing Aid Compatibility (HAC) measurement of a wireless portable device manufactured by Kyocera Wireless Corp. (KWC). These measurements were performed for compliance with the rules and regulations of the U.S. Federal Communications Commission (FCC). The testing was performed in accordance with ANSI C63.19-2006.

This report covers test and data on:

X	RF Emissions	ANSI C63.19 Clause 4
	T-Coil	ANSI C63.19 Clause 6

2 Equipment Under Test (EUT)

Product:	Tri Band CDMA Cellular Phone with Bluetooth		
FCC ID:	OVFKWC-K3802		
Model Number:	K38-02		
EUT Serial Number:	FFLM0000003752		
Type:	[] Prototype, [X] Pre-Production, [] Production		
Device Category:	Portable		
RF Exposure Environment:	General Population / Uncontrolled		
Antenna:	Internal Antenna		
Detachable Antenna:	No		
External Input:	Audio/Digital Data		
Quantity:	Quantity production is planned		
Modes:	800 CDMA	1700 CDMA	1900 CDMA
Multiple Access Scheme:	CDMA	CDMA	CDMA
TX Frequency (MHz):	824 – 849	1710-1755	1850 - 1910
Rated RF Conducted Output Power (dBm)	24.5	23.00	23.00

3 Summary of Test Results

ANSI C63.19 (2005)		
Section 4 RF Emissions		
Test	Test Results	Overall Category
E-Field Emissions	M3	M3
H-Field Emissions	M4	

4 Test conditions

4.1 Ambient Conditions

All tests were performed under the following environmental conditions:

Ambient Temperature:	23 ± 2 Degrees C
Tissue simulating liquid temperature:	22 ± 1 Degrees C
Relative Humidity (RH):	0% <RH < 80%
Atmospheric Pressure:	101.3kPa + 10 to -5kPa

4.2 RF characteristics of the test site

All HAC measurements were performed inside a shielded room that provide isolation from external EM fields, with the RF ambient at least 20 dB below the intended measurement limits.

4.3 Test Signal, Frequencies and Output Power

Peak and Average conducted power were measured for each mode for comparison. RC3 SO55 was chosen for worst-case power configuration.

CONFIGURATION	CONDUCTED POWER (dBm)					
	CDMA 800		CDMA 1700		CDMA 1900	
	Ch 383		Ch 450		Ch600	
	Peak	Average	Peak	Average	Peak	Average
SO2, RC1 Full Rate	29.41	24.91	28.54	23.18	28.44	23.42
SO2, RC3 Full Rate	28.99	24.92	27.96	23.31	28.28	23.35
SO55, RC1 Full Rate	29.29	24.93	28.84	23.27	28.41	23.45
SO55, RC3 Full Rate	29.63	24.96	29.07	23.36	29.19	23.47
TDSO SO32, RC3 (FCH +SCH) Full Rate	28.83	24.75	27.53	23.16	28.02	23.31
TDSO SO32, RC3 (-SCH) Full Rate	28.96	24.88	28.01	23.19	28.10	23.41

During tests, the EUT was put in in-call mode and controlled by a CDMA simulator to generate the required signal and power using the configuration below.

Protocol:	6 (IS-2000)
Radio Configuration:	3
Power Control:	All Up Bits
Service Option:	55
Data Rate:	Full

In all operating modes, the phone was set to rate maximum RF power level and the measurements were performed on low, mid and high channels.

The measurement system measures power drift during HAC testing by comparing E/H-field in the same location at the beginning and at the end of measurement. These records were used to monitor stability of power output during tests. Conducted RF power measurements were also performed before and after each HAC measurements to confirm the output power.

4.4 EUT Operating Conditions

The EUT was tested with the following configurations and conditions, if applicable:

<input checked="" type="checkbox"/>	Fully charged standard as supplied with the handset
<input checked="" type="checkbox"/>	At ear use position.
<input type="checkbox"/>	Both retracted and extended antenna positions
<input checked="" type="checkbox"/>	Back-light tested ON and OFF
<input checked="" type="checkbox"/>	Simultaneous transmission with Bluetooth transmitter ON

5 Description of the test equipment

5.1 Test Equipment Used

Below is a list of the calibrated equipment used for the measurements:

Description	Manufacturer	Model Number	Serial Number	Cal Due Date
Power Meter	Giga-tronics	8541C	1831306	03/26/09
Signal Generator	Hewlett Packard	E4421B	US38440337	07/14/09
Radio Communication Tester	Rohde & Schwarz	CMU200	101328	03/10/09
Data Acq	Speag	DAE4	603	10/15/08
E-field Probe	Speag	ER3DV6	2341	04/17/09
H-field Probe	Speag	H3DV6	6123	09/14/08
Dipole Antenna (835MHz)	Speag	CD835V3	1020	04/26/09
Dipole Antenna (1880MHz)	Speag	CD1880V3	1015	04/26/09
Spectrum Analyzer	Hewlett Packard	8594E	3710A04899	02/27/10

The calibration certificates of E-field and H-field probes are attached in Appendix A.

5.2 Near Field Measurement System

The measurements were performed with Dasy4 automated near-field scanning system comprised of high precision robot, robot controller, computer, near-field probe, probe alignment sensor, non-conductive phone positioner, Test Arch and software extension. The overall expanded uncertainty (K=2) of the measurement system is $\pm 10.9\%$ and $\pm 14.7\%$ for H-field and E-field resp. The measurement uncertainty budget is given in section 6.

5.3 Isotropic E-Field Probe

Model	<ul style="list-style-type: none"> ▪ ER3DV6
Construction	<ul style="list-style-type: none"> ▪ One dipole parallel, two dipoles normal to probe axis ▪ Built-in shielding against static charges ▪ PEEK enclosure material (resistant to organic solvents, e.g., glycoether)
Calibration	<ul style="list-style-type: none"> ▪ In air from 100 MHz to 3.0 GHz (absolute accuracy $\pm 6\%$; k=2)
Frequency	<ul style="list-style-type: none"> ▪ 100MHz to 6 GHz ▪ Linearity: $\pm 0.2\text{dB}$ (100MHz to 3GHz)
Directivity	<ul style="list-style-type: none"> ▪ $\pm 0.2\text{ dB}$ in air (rotation around probe axis) ▪ $\pm 0.4\text{ dB}$ in air (rotation normal to probe axis)
Dynamic Range	<ul style="list-style-type: none"> ▪ 2 V/m to > 1000 V/m ▪ Linearity: $\pm 0.2\text{ dB}$
Dimensions	<ul style="list-style-type: none"> ▪ Overall length: 330 mm (Tip: 16 mm) ▪ Tip diameter: 8 mm (Body: 12 mm) ▪ Distance from probe tip to dipole centers: 2.5 mm
Application	<ul style="list-style-type: none"> ▪ General near-field measurements up to 6 GHz ▪ Field component measurements ▪ Fast automatic scanning in phantoms

5.4 Isotropic H-Field Probe

Model	<ul style="list-style-type: none"> ▪ H3DV6
Construction	<ul style="list-style-type: none"> ▪ Three concentric loop sensors with 3.8 mm loop diameters ▪ Resistively loaded detector diodes for linear response ▪ Built-in shielding against static charges ▪ PEEK enclosure material (resistant to organic solvents, e.g., glycolether)
Frequency	<ul style="list-style-type: none"> ▪ 200 MHz to 3 GHz ($\pm 6.0\%$, $k=2$); Output linearized
Directivity	<ul style="list-style-type: none"> ▪ ± 0.25 dB (spherical isotropy error)
Dynamic Range	<ul style="list-style-type: none"> ▪ 10 mA/m to 2 A/m at 1 GHz
E-Field Interference	<ul style="list-style-type: none"> ▪ $< 10\%$ at 3 GHz (for plane wave)
Dimensions	<ul style="list-style-type: none"> ▪ Overall length: 330 mm (Tip: 40 mm) ▪ Tip diameter: 6 mm (Body: 12 mm) ▪ Distance from probe tip to dipole centers: 3 mm
Application	<ul style="list-style-type: none"> ▪ General magnetic near-field measurements up to 3 GHz ▪ Field component measurements ▪ Surface current measurements ▪ Measurements in air or liquids ▪ Low interaction with the measured field

6 System Validation

The manufacturer calibrates the probes annually. The HAC measurements of the device were done within 24 hours of system accuracy verification, which was done using calibration dipoles. Unmodulated continuous wave of power level of 20dBm was supplied to a dipole antenna placed under Test Arch. The measurement probes are positioned over the illuminated dipole at 10mm distance from the top surface of the dipole element to the calibration reference point of the sensor, defined by the probe manufacturer.

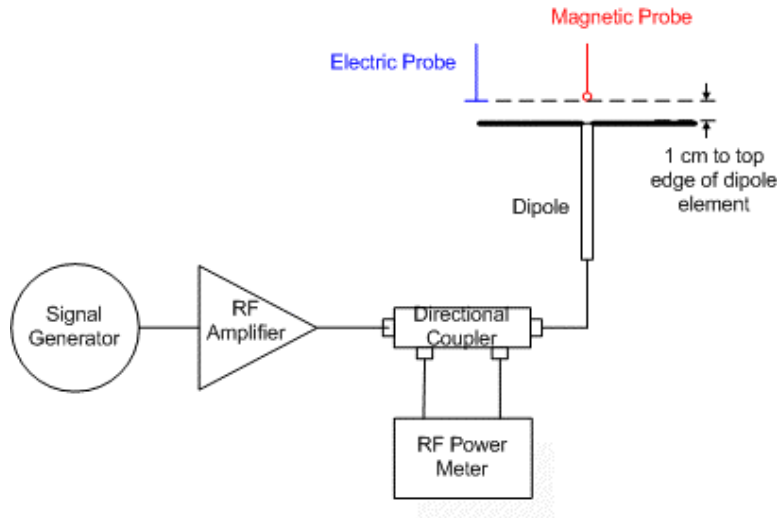

Figure 6 - System Check Setup

The length of the dipole was scanned with both E and H-field probes and the maximum values for each were recorded. The validation results are in the table below and printouts of the validation test are attached in Appendix B. All the measured parameters were within the specification.

Freq. (MHz)	Parameter	Target, SPEAG	Measured	Delta (%)	Limit (%)	Test date
836.49	E dB(V/m)	165.2	170.9	3.45	± 25	7/11/08
	H dB(A/m)	0.447	0.473	5.82	± 25	7/11/08
1732	E dB(V/m)	134.5	138.7	3.12	± 25	8/25/08
	H dB(A/m)	0.461	0.441	-4.30	± 25	8/25/08
1880	E dB(V/m)	134.5	146.4	8.85	± 25	7/11/08
	H dB(A/m)	0.461	0.499	8.20	± 25	7/11/08

7 Description Of The Test Procedure

The device was positioned and setup according to ANSI C63.19-2006.

7.1 Test Positions

The device was placed on a non-conductive phone positioner under the Test Arch.

7.2 RF Emission Measurements Reference and Plane

Figure 7.2 illustrates the references and reference plane that shall be used in the EUT emissions measurement:

- The grid is 5 cm by 5 cm area that is divided into 9 evenly sized blocks or sub-grids.
- The grid is centered on the audio frequency output transducer (speaker) of the EUT.
- The grid is in a reference plane, which is defined as the planar area that contains the highest point in the area of the phone that normally rests against the user's ear. It is parallel to the centerline of the receiver of the EUT and is defined by the points of the receiver-end of the EUT, which, in normal handset use, rest against the ear.
- The measurement plane is parallel to, and 1.0 cm in front of, the reference plane.

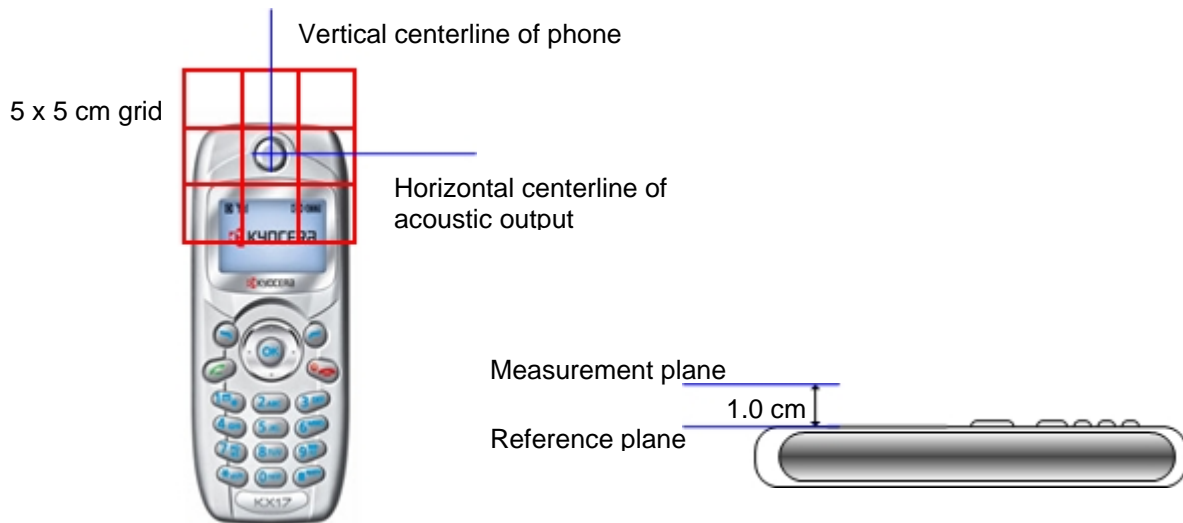

Figure 7.2 – Measurement Reference and Plane

7.3 RF Emissions Measurement Procedures

Figure 7.6 shows the near field emission measurement flowchart:

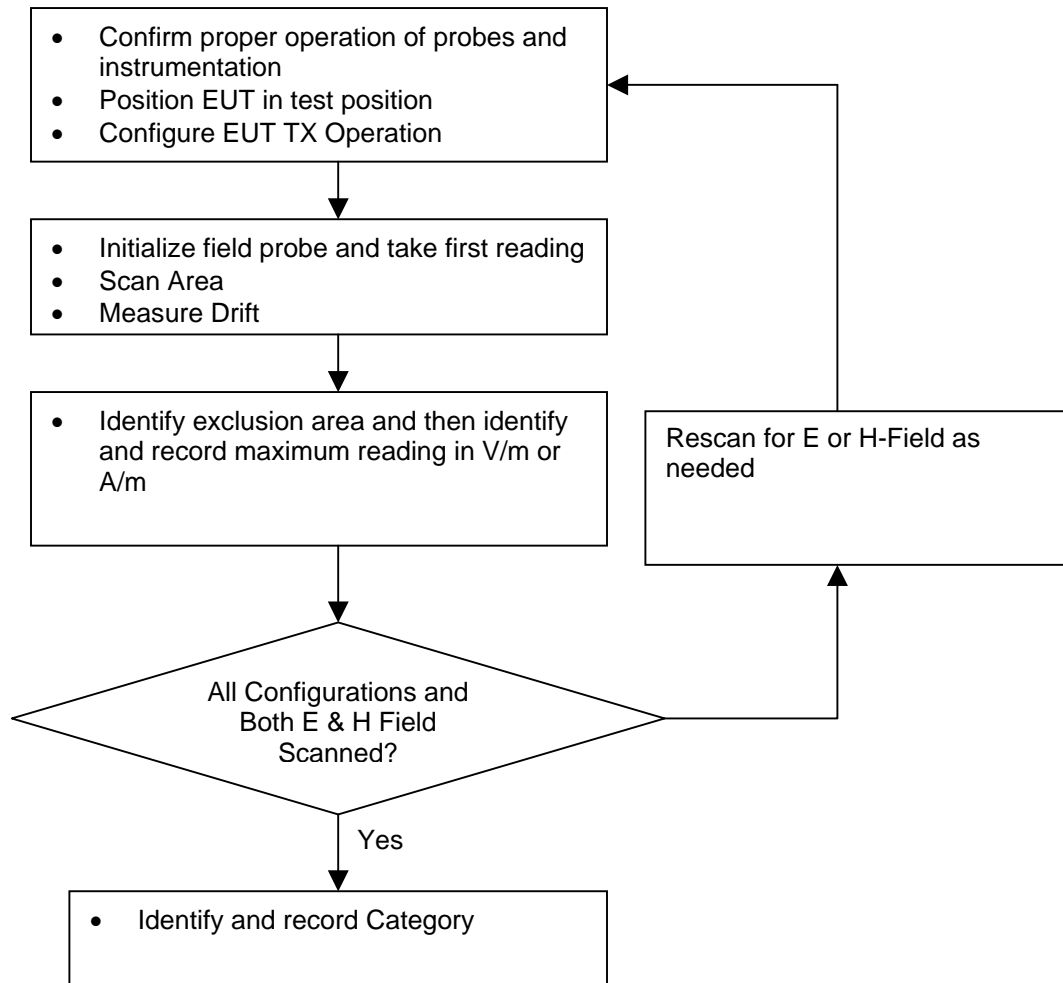

Figure 7.3 - Near field emission measurement flowchart

1. The center of the probe was scanning to the edges of the grid. Accordingly the total area covered by the outside edge of the probe was the 5 cm by 5 cm area, increased by half ($\frac{1}{2}$) the probe diameter on all sides.
2. The nearest point on the probe measurement element(s) was held 1.0 cm from the EUT reference plane.
3. The probe element is that portion of the probe that is designed to receive and sense the field being measured.
4. The physical body of the probe housing was not used when setting this 1.0 cm distance as this would place the sensing elements at an indeterminate distance from the reference plane.
5. The step size of the scan is set to 5 mm or less.
6. Up to three blocks were excluded for each field measurement.
 - The center block containing the EUT output was not excluded.
 - A maximum of five blocks were excluded for both E- and H-field measurements for the EUT output being measured. Stated differently, the center sub-grid or block and 3 other blocks were common to both the E- and H-field measurements for a given grid.

7.4 Probe Modulation Factor (PMF)

7.4.1 Measurement Procedures

A calibration was made of the modulation response of the probe and its instrumentation chain. This calibration was performed with the field probe, attached to its instrumentation. The response of the probe system to a CW field at the frequency of interest is compared to its response to a modulated signal with equal peak amplitude to that of a CW signal. The field level of the test signals shall be more than 10 dB above the ambient level and the noise floor of the instrumentation being used. The ratio of the CW reading to that taken with a modulated reading was applied to the DUT measurements. The measurement procedures are as following:

1. Fix the field probe in a set location relative to the dipole antenna, as illustrated in Figure 7.4.
2. Setup the wireless device (EUT) with intended signal at the intended measurement frequency.
3. Record the reading of the probe measurement system.
4. Replace the wireless device with a RF signal generator producing an unmodulated CW signal and set to the wireless device operating frequency.
5. Set the peak power of the unmodulated signal to equal that recorded from the wireless device
6. Record the reading of the probe measurement system of the unmodulated CW signal.
7. The ratio of probe reading (CW) in step 6 to the probe reading (EUT) in step 3 is the modulation factor.

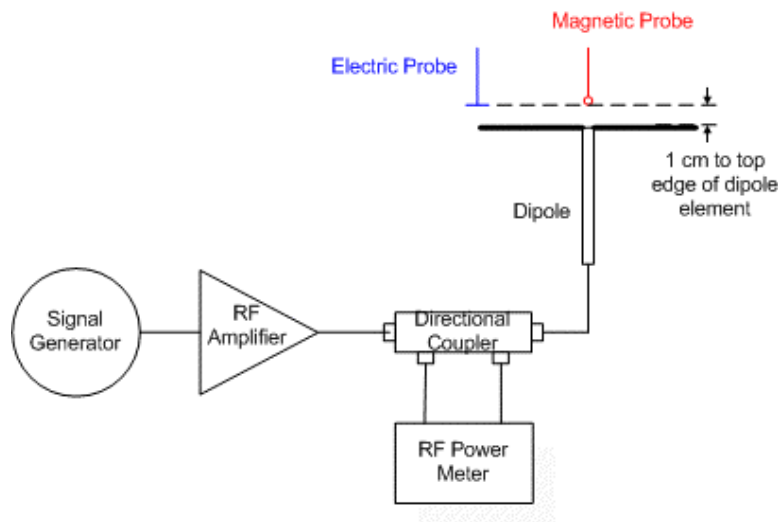

Figure 7.4 - Probe Modulation Setup

The modulation factors obtained by above method shall be applied to readings taken of the actual WD, in order to obtain an accurate peak field reading.

7.4.2 PMF Test Results

E-Field					
Frequency (MHz)	Peak Power (dBm)	Protocol	Protocol Reading (V/m)	PMF Ratio	PMF (dB)
836.49	24.60	CW	109.1		
	24.59	CDMA	112.4	0.97	-0.3
	24.57	AM	67.79	1.61	4.1
1732.5	20.22	CW	51.32		
	20.20	CDMA	58.87	0.87	-1.192
	20.22	AM	32.91	1.56	3.859
1880	21.59	CW	57.65		
	21.57	CDMA	58.24	0.99	-0.088
	21.59	AM	36.91	1.56	3.873
H-Field					
Frequency (MHz)	Peak Power (dBm)	Protocol	Protocol Reading (A/m)	PMF Ratio	PMF (dB)
836.49	24.70	CW	0.3417		
	24.71	CDMA	0.3529	0.97	-0.3
	24.69	AM	0.2215	1.54	3.8
1732.5	20.35	CW	0.2014		
	20.33	CDMA	0.2072	0.97	-0.2
	20.32	AM	0.1287	1.56	3.9
1880	21.45	CW	0.227		
	21.44	CDMA	0.239	0.95	-0.5
	21.43	AM	0.147	1.54	3.8

7.4.3 PMF Peak Power Measurement Plots

CDMA-800

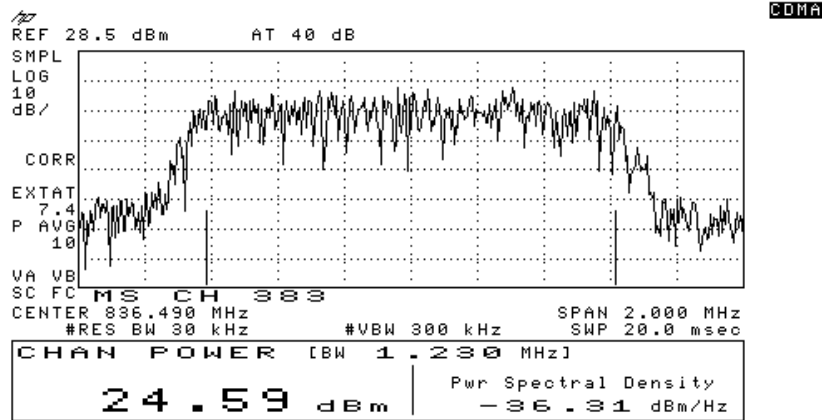

CDMA-1700

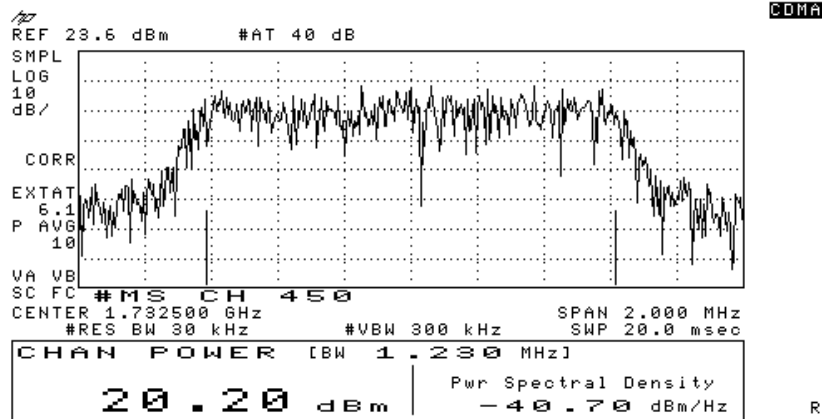

CDMA-1900

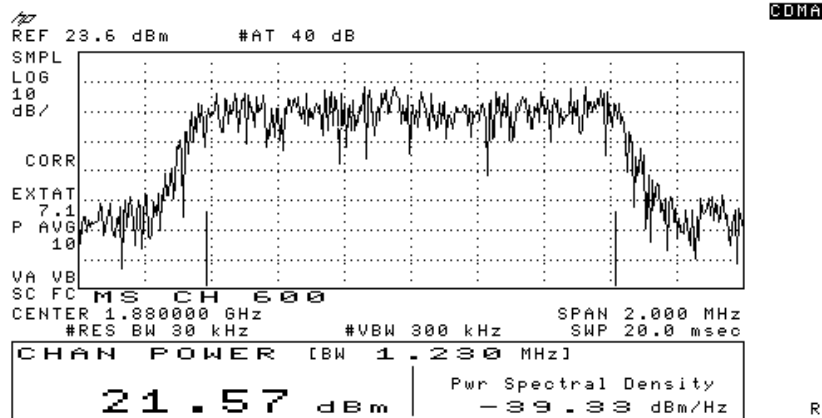

CW - 800

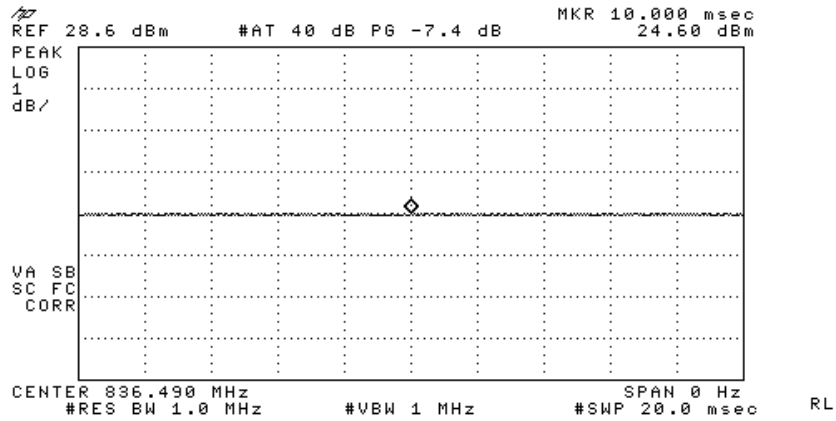

CW-1700

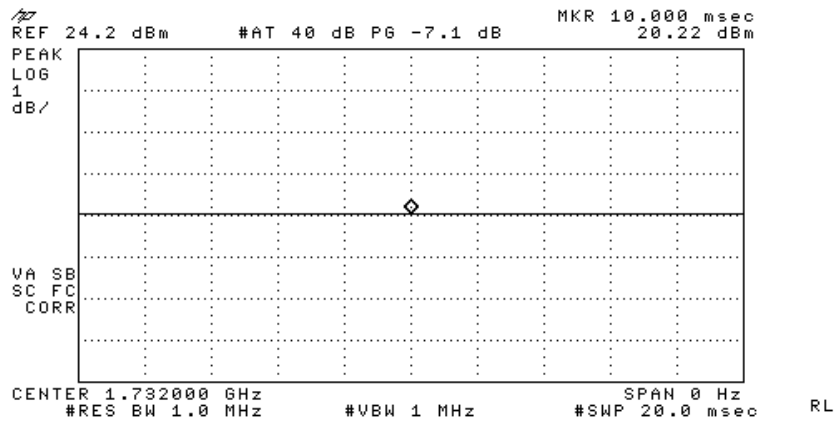

CW-1900

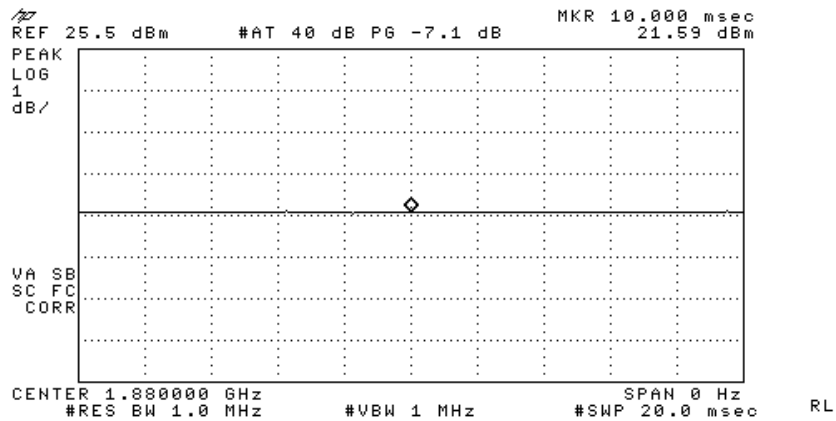

80%AM - 800

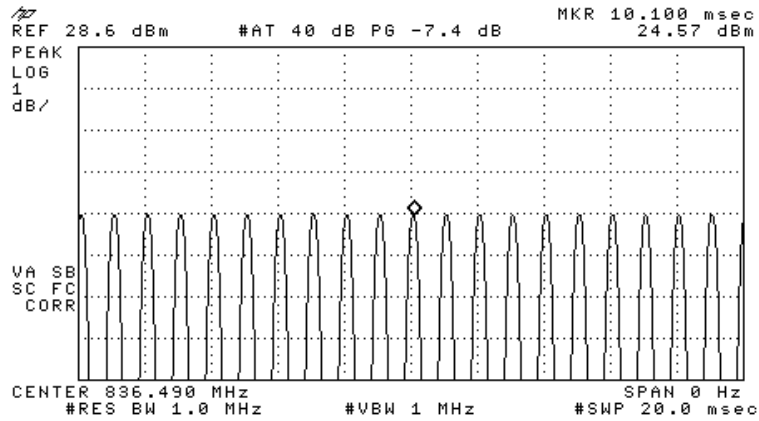

RL

80%AM - 1700

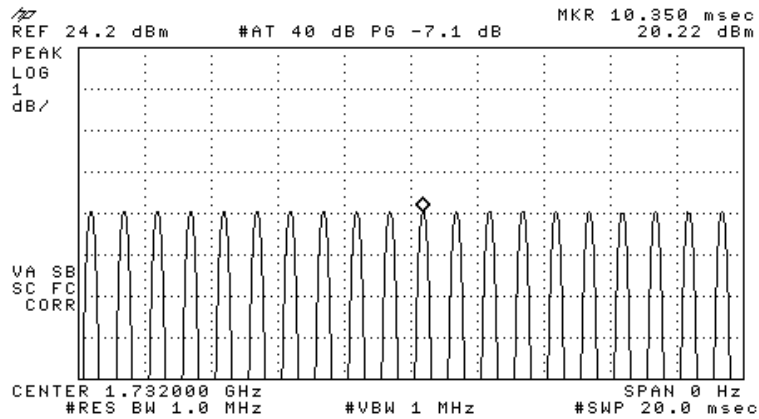

RL

80%AM - 1900

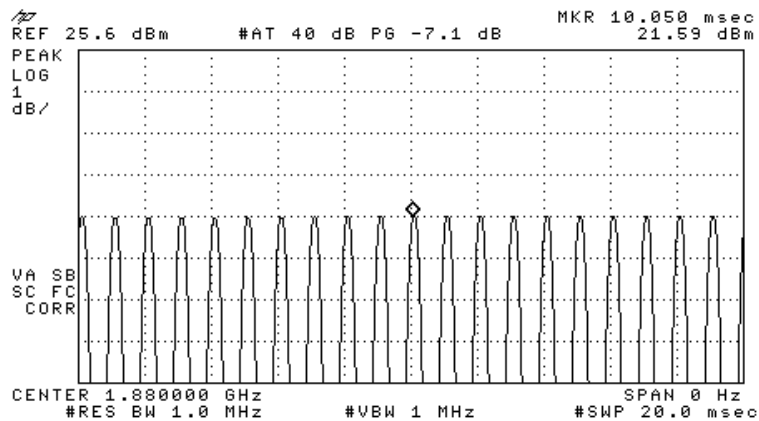

RL

8 Emission Data Extraction and Post processing

At the end of the measurements, the DASY4 system automatically evaluates the slot-averaged results, exclusion of the three highest sub-grid, application of the AWF factor per ANSI-C63.19 requirements.

The following AWF factors were used for the standard transmission protocols:

Standard	Technology	AWF
TIA/EIA/IS-2000	CDMA	0
TIA/EIA-136	TDMA (50 Hz)	0
J-STD-007	GSM (217)	-5
T1/T1P1/3GPP	UMTS (WCDMA)	0
iDEN™	TDMA(22 and 11 Hz)	0

Table 7.5a - Articulation Weighting Factor (AWF)

All DASY4 measurements are in RMS values. The Dasy4 system incorporates the crest factor of the signal in the computation of the RMS values. Although the software also has the capability to estimate the peak field by applying a square root of the crest factor value to the readings, the probe modulation factor was applied manually instead per ANSI C63.19 in the measurement tables in this report using equation:

$$\text{Peak Field} = (\text{DASY4 reading}) \times \text{PMF}$$

where DASY4 reading = measurement from DASY4 in V/m or A/m
 PMF = Probe Modulation Factor in linear unit

9 Measurement Uncertainty

Table 9 shows the uncertainty budget for HAC free field assessment according to ANSI C63.19-2006. The budget is valid for the frequency range 800 MHz - 3 GHz and represents a worst-case analysis. For specific tests and configurations, the uncertainty could be smaller.

Uncertainty Description	Uncert. Value (± %)	Prob. Dist.	Div.	C _i (E)	C _i (H)	Stand. Uncert (E) (±%)	Stand. Uncert (H) (±%)
Measurement system							
Probe calibration	5.1	N	1	1	1	5.1	5.1
Axial isotropy of the probe	4.7	R	√3	1	1	2.7	2.7
Sensor displacement	16.5	R	√3	1	0.145	9.5	1.4
Boundary effects	2.4	R	√3	1	1	1.4	1.4
Probe linearity	4.7	R	√3	1	1	2.7	2.7
Scaling to Peak Envelope Power	2.0	R	√3	1	1	1.2	1.2
System Detection limit	1.0	R	√3	1	1	0.6	0.6
Readout electronics	0.3	N	1	1	1	0.3	0.3
Response time	0.8	R	√3	1	1	0.5	0.5
Integration time	2.6	R	√3	1	1	1.5	1.5
RF ambient conditions	3.0	R	√3	1	1	1.7	1.7
RF Reflections	12	R	√3	1	1	6.9	6.9
Probe Positioner	1.2	R	√3	1	0.67	0.7	0.5
Probe positioning	4.7	R	√3	1	0.67	2.7	1.8
Extrap. and integration	1.0	R	√3	1	1	0.6	0.6
Test Sample Related							
Device positioning vertical	4.7	R	√3	1	0.67	2.7	1.8
Device Positioning Lateral	1.0	R	√3	1	1	0.6	0.6
Device Holder and Phantom	2.4	R	√3	1	1	1.4	1.4
Power drift	5.0	R	√3	1	1	2.9	2.9
Phantom and Setup Related							
Phantom thickness	2.4	R	√3	1	0.67	1.4	0.9
Combined Standard Uncertainty:						14.7	10.9
Extended Standard Uncertainty on Power (k=2):						29.4	21.8
Extended Standard Uncertainty on Field (k=2):						14.7	10.9

N: Normal
R: Rectangular

Table 9 - Worst-Case uncertainty budget for HAC free field assessment

10 RF Emissions Tests

10.1 Emission Limits

Table 10.1 shows the M-rating criteria from ANSCI C63.19. All digital transmission modes in all frequency bands contained in a HAC phone must meet M3 or M4 levels.

Near Field	Wireless Device RF Parameters [AWF = 0]			
	E-Field Emissions		H-Field Emissions	
Category	dB(V/m) Peak	V/m Peak	dB(A/m) Peak	V/m Peak
Freq < 960 MHz				
M1	56.0 to 61.0	631.0 to 1122.0	5.6 to 10.6	1.91 to 3.39
M2	51.0 to 56.0	354.8 to 631.0	0.6 to 5.6	1.07 to 1.91
M3	46.0 to 51.0	199.5 to 354.8	-4.4 to 0.6	0.60 to 1.07
M4	< 46.0	< 199.5	< -4.4	< 0.60
Freq > 960 MHz				
M1	46.0 to 51.0	199.5 to 354.8	-4.4 to 0.6	0.60 to 1.07
M2	41.0 to 46.0	112.2 to 199.5	-9.4 to -4.4	0.34 to 0.60
M3	36.0 to 41.0	63.1 to 112.2	-14.4 to -9.4	0.19 to 0.34
M4	< 36.0	< 63.1	< -14.4	< 0.19

Table 10.1 - RF Emission Limits

10.2 CDMA 800 Test Results

CDMA 800 E-Field									
Configuration:		At ear position				Antenna		Internal	
Ch.	Back light	Battery	BT	Power before Test	Power after Test	Dasy4 Reading	PMF	Peak Field	Category
#				dBm	dBm	V/m		V/m	M
1013	ON	Standard	OFF	24.40	24.34	74.10	1.00	74.10	4
383	ON	Standard	OFF	25.09	25.22	89.10	1.00	89.10	4
777	ON	Standard	OFF	24.43	24.22	89.80	1.00	89.80	4
777	OFF	Standard	OFF	24.43	24.22	90.60	1.00	90.60	4
777 (360°)	OFF	Standard	OFF	24.43	24.22	88.30	1.00	88.30	4
777 (Bluetooth)	OFF	Standard	ON	24.43	24.22	89.00	1.00	89.00	4

Data plots are shown in Appendix C

CDMA 800 H-Field									
Configuration:		At ear position				Antenna		Internal	
Ch.	Back light	Battery	BT	Power before Test	Power after Test	Dasy4 Reading	PMF	Peak Field	Category
#				dBm	dBm	A/m		A/m	M
1013	ON	Standard	OFF	24.40	24.34	0.128	1.00	0.128	4
383	ON	Standard	OFF	25.09	25.22	0.146	1.00	0.146	4
777	ON	Standard	OFF	24.43	24.22	0.141	1.00	0.141	4
777	OFF	Standard	OFF	24.43	24.22	0.144	1.00	0.144	4
777 (360°)	OFF	Standard	OFF	24.43	24.22	0.139	1.00	0.139	4
777 (Bluetooth)	OFF	Standard	ON	24.43	24.22	0.145	1.00	0.145	4

Data plots are shown in Appendix C

10.3 CDMA 1700 Test Results

CDMA 1700 E-Field									
Configuration:		At ear position				Antenna		Internal	
Ch.	Back Light	Battery	BT	Power before Test	Power after Test	Dasy4 Reading	PMF	Peak Field	Category
#				dBm	dBm	V/m		V/m	M
25	ON	Standard	OFF	23.30	23.12	42.20	1.00	42.20	4
450	ON	Standard	OFF	23.66	23.51	48.20	1.00	48.20	4
875	ON	Standard	OFF	23.72	23.75	55.90	1.00	55.90	4
875	OFF	Standard	OFF	23.72	23.75	53.30	1.00	53.30	4
875 (360°)	ON	Standard	OFF	23.72	23.75	51.60	1.00	51.60	4
875 (BTooth)	ON	Standard	ON	23.72	23.75	56.10	1.00	56.10	4

Data plots are shown in Appendix C

CDMA 1700 H-Field									
Configuration:		At ear position				Antenna		Internal	
Ch.	Back light	Battery	BT	Power before Test	Power after Test	Dasy4 Reading	PMF	Peak Field	Category
#				dBm	dBm	A/m			M
25	ON	Standard	OFF	23.30	23.12	0.102	1.00	0.102	4
450	ON	Standard	OFF	23.66	23.51	0.119	1.00	0.119	4
875	ON	Standard	OFF	23.72	23.75	0.116	1.00	0.116	4
875	OFF	Standard	OFF	23.72	23.75	0.124	1.00	0.124	4
875 (360°)	ON	Standard	OFF	23.72	23.75	0.122	1.00	0.122	4
875 (BTooth)	ON	Standard	ON	23.72	23.75	0.121	1.00	0.121	4

Data plots are shown in Appendix C

10.4 CDMA 1900 Test Results

CDMA 1900 E-Field									
Configuration:		At ear position				Antenna		Internal	
Ch.	Back Light	Battery	BT	Power before Test	Power after Test	Dasy4 Reading	PMF	Peak Field	Category
#				dBm	dBm	V/m		V/m	M
25	ON	Standard	OFF	23.20	23.15	56.20	1.00	56.20	4
600	ON	Standard	OFF	23.74	23.71	66.10	1.00	66.10	3
1175	ON	Standard	OFF	22.95	22.81	43.90	1.00	43.90	4
600	OFF	Standard	OFF	23.74	23.71	64.70	1.00	64.70	3
600 (360°)	ON	Standard	OFF	23.74	23.71	65.10	1.00	65.10	3
600 (Bluetooth)	ON	Standard	ON	23.74	23.71	65.30	1.00	65.30	3

Data plots are shown in Appendix C

CDMA 1900 H-Field									
Configuration:		At ear position				Antenna		Internal	
Ch.	Back light	Battery	BT	Power before Test	Power after Test	Dasy4 Reading	PMF	Peak Field	Category
#				dBm	dBm	A/m			M
25	ON	Standard	OFF	23.20	23.15	0.157	1.00	0.157	4
600	ON	Standard	OFF	23.74	23.71	0.187	1.00	0.187	4
1175	ON	Standard	OFF	22.95	22.81	0.111	1.00	0.111	4
600	OFF	Standard	OFF	23.74	23.71	0.179	1.00	0.179	4
600 (360°)	ON	Standard	OFF	23.74	23.71	0.175	1.00	0.175	4
600 (Bluetooth)	ON	Standard	ON	23.74	23.71	0.180	1.00	0.180	4

Data plots are shown in Appendix C

10.4 Worst-Case Configuration Evaluation

10.4.1 Peak Reading 360° Probe Rotation at Azimuth axis

The probe was rotated 360° in the worst-case configuration. The rotation was performed at the location of maximum field strength in the included blocks.

CDMA 800 E-Field							
Configuration:		At ear position		Antenna:		Internal	
Ch.	Backlight	Battery	Conducted Power	Peak Field	PMF	Peak Field	Category
#			dBm	V/m		V/m	M
777	OFF	Standard	24.43	88.30	1.0	88.30	4

CDMA 1700 E-Field							
Configuration:		At ear position		Antenna:		Internal	
Ch.	Backlight	Battery	Conducted Power	Peak Field	PMF	Peak Field	Category
#			dBm	V/m		V/m	M
875	ON	Standard	23.72	51.60	1.0	51.60	4

CDMA 1900 E-Field							
Configuration:		At ear position		Antenna:		Internal	
Ch.	Backlight	Battery	Conducted Power	Peak Field	PMF	Peak Field	Category
#			dBm	V/m		V/m	M
600	ON	Standard	23.74	65.10	1.0	65.10	3

Data plots are shown in Appendix C

11 Appendix A: Probe Calibration Certification

**Calibration Laboratory of
Schmid & Partner
Engineering AG**
Zeughausstrasse 43, 8004 Zurich, Switzerland



S Schweizerischer Kalibrierdienst
C Service suisse d'étalonnage
S Servizio svizzero di taratura
S Swiss Calibration Service

Accredited by the Swiss Accreditation Service (SAS)
The Swiss Accreditation Service is one of the signatories to the EA
Multilateral Agreement for the recognition of calibration certificates

Accreditation No.: **SCS 108**

Client: **Kyocera USA**

Certificate No.: **ER3-2341_Apr08**

CALIBRATION CERTIFICATE

Object: **ER3DV6 - SN:2341**

Calibration procedure(s): **QA-CAL-02 v5
Calibration procedure for E-field probes optimized for close near field
evaluations in air**

Calibration date: **April 17, 2008**

Condition of the calibrated item: **In Tolerance**

This calibration certificate documents the traceability to national standards, which realize the physical units of measurements (SI).
The measurements and the uncertainties with confidence probability are given on the following pages and are part of the certificate.

All calibrations have been conducted in the closed laboratory facility: environment temperature (22 ± 3)°C and humidity < 70%.

Calibration Equipment used (M&TE critical for calibration)

Primary Standards	ID #	Cal Date: (Certificate No.)	Scheduled Calibration
Power meter E4419B	GB41293874	1-Apr-08 (No. 217-00788)	Apr-09
Power sensor E4412A	MY41495277	1-Apr-08 (No. 217-00788)	Apr-09
Power sensor E4412A	MY41498067	1-Apr-08 (No. 217-00788)	Apr-09
Reference 3 dB Attenuator	SN: S5054 (3c)	8-Aug-07 (No. 217-00719)	Aug-08
Reference 20 dB Attenuator	SN: S5085 (20b)	31-Mar-08 (No. 217-00787)	Apr-09
Reference 30 dB Attenuator	SN: S5129 (30b)	8-Aug-07 (No. 217-00720)	Aug-08
Reference Probe ES3DV2	SN: 3013	2-Jan-08 (No. ES3-3013_Jan08)	Jan-09
DAE4	SN: 654	20-Apr-07 (No. DAE4-654_Apr07)	Apr-08
Secondary Standards	ID #	Check Date (In house)	Scheduled Check
RF generator HP 8648C	US3842U01700	4-Aug-99 (in house check Oct-07)	In house check: Oct-09
Network Analyzer HP 8753E	US37380585	18-Oct-01 (in house check Oct-07)	In house check: Oct-08

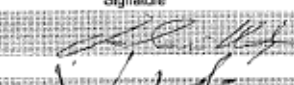
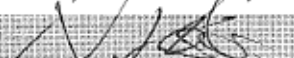
	Name	Function	Signature
Calibrated by:	Katja Pokovic	Technical Manager	
Approved by:	Niels Kuster	Quality Manager	

Issued: April 17, 2008

This calibration certificate shall not be reproduced except in full without written approval of the laboratory.

**Calibration Laboratory of
Schmid & Partner
Engineering AG**
Zeughausstrasse 43, 8004 Zurich, Switzerland



S Schweizerischer Kalibrierdienst
C Service suisse d'étalonnage
S Servizio svizzero di taratura
S Swiss Calibration Service

Accredited by the Swiss Federal Office of Metrology and Accreditation
The Swiss Accreditation Service is one of the signatories to the EA
Multilateral Agreement for the recognition of calibration certificates

Accreditation No.: **SCS 108**

Client **Kyocera USA**

Certificate No: **H3-6123_Sep07**

CALIBRATION CERTIFICATE

Object: **H3DV6 SN:6123**

Calibration procedure(s): **QA-CAL-03.v5
Calibration procedure for H-field probes optimized for close near field
evaluations in air**

Calibration date: **September 14, 2007**

Condition of the calibrated item: **In Tolerance**

This calibration certificate documents the traceability to national standards, which realize the physical units of measurements (SI).
The measurements and the uncertainties with confidence probability are given on the following pages and are part of the certificate.

All calibrations have been conducted in the closed laboratory facility: environment temperature (22 ± 3)°C and humidity < 70%.

Calibration Equipment used (M&TE critical for calibration)

Primary Standards	ID #	Cal Date (Calibrated by, Certificate No.)	Scheduled Calibration
Power meter E4419B	GB41293874	29-Mar-07 (METAS, No. 217-00670)	Mar-08
Power sensor E4412A	MY41495277	29-Mar-07 (METAS, No. 217-00670)	Mar-08
Power sensor E4412A	MY41498087	29-Mar-07 (METAS, No. 217-00670)	Mar-08
Reference 3 dB Attenuator	SN: S5054 (3c)	8-Aug-07 (METAS, No. 217-00718)	Aug-08
Reference 20 dB Attenuator	SN: S5086 (20b)	29-Mar-07 (METAS, No. 217-00671)	Mar-08
Reference 30 dB Attenuator	SN: S5129 (30b)	8-Aug-07 (METAS, No. 217-00720)	Aug-08
Reference Probe H3DV6	SN: 6182	2-Oct-06 (SPEAG, No. H3-6182_Oct06)	Oct-07
DAE4	SN: 654	20-Apr-07 (SPEAG, No. DAE4-654_Apr07)	Apr-08

Secondary Standards	ID #	Check Date (in house)	Scheduled Check
RF generator HP 8648C	US3842U01700	4-Aug-99 (SPEAG, in house check Nov-05)	In house check: Nov-07
Network Analyzer HP 8753E	US37390566	18-Oct-01 (SPEAG, in house check Oct-06)	In house check: Oct-07

	Name	Function	Signature
Calibrated by:	Katja Pokovic	Technical Manager	
Approved by:	Niels Kuster	Quality Manager	

Issued: September 14, 2007

This calibration certificate shall not be reproduced except in full without written approval of the laboratory.

12 Appendix B: System Validation Plots

(See attachment)

13 Appendix C: Test Results/Plots

(See attachment)

14 Appendix D: Photo Test Setup

(see attachment)