



HAC T-COIL Evaluation Report

IN ACCORDANCE WITH THE REQUIREMENTS OF
ANSI-PC63.19-2001 REVISION DRAFT 3.12, JANUARY 18, 2006

FOR

DUAL-BAND DUAL-MODE CDMA CELLULAR PHONE

MODEL: K27T

FCC ID: OVFKWC-K27

REPORT NUMBER: 06U10723-1B

ISSUE DATE: JANUARY 17, 2007

Prepared for

**KYOCERA WIRELESS CORP.
10300 CAMPUS POINT DRIVE,
SAN DIEGO, CA 92121 USA**

Prepared by

**COMPLIANCE CERTIFICATION SERVICES
561F MONTEREY ROAD,
MORGAN HILL, CA 95037, USA
TEL: (408) 463-0885**



NVLAP LAB CODE 200065-0

Revision History

Rev.	Issued date	Revisions	Revised By
--	January 15, 2007	Initial issue	HS
B	January 17, 2007	Corrected some typos	HS

CERTIFICATE OF COMPLIANCE (HAC T-COIL EVALUATION)**DATES OF TEST:** December 19, 20, 21, 2006

APPLICANT: ADDRESS:	Kyocera Wireless Corp. 10300 Campus Point Drive, San Diego, CA 92121 USA
FCC ID: MODEL:	OVFKWC-K27 K27T
DEVICE CATEGORY: EXPOSURE CATEGORY:	Portable Device General Population/Uncontrolled Exposure



Dual-Band Dual-Mode CDMA Cellular Phone has T-coil capability.	
Test Sample is a:	Production unit
Frequency Band	Frequency Range [MHz]
Cell Band	824.7-848.31
PCS Band	1851.25-1908.75
Hearing Aid T-Coil Category: T4	
<p>This wireless portable device has been shown to be compatible with hearing aids under the above rated category, specified in ANSI-PC63.19-2001 REVISION DRAFT 3.12, JANUARY 18, 2006 and had been tested in accordance with the specified measurement procedures. Hearing Aid Compatibility is based on the assumption that all production units will be designed electrically identical to the device tested in this report.</p> <p>Note: The results documented in this report apply only to the tested sample, under the conditions and modes of operation as described herein. This document may not be altered or revised in any way unless done so by Compliance Certification Services and all revisions are duly noted in the revisions section. Any alteration of this document not carried out by Compliance Certification Services will constitute fraud and shall nullify the document. No part of this report may be used to claim product certification, approval, or endorsement by NVLAP, NIST, or any government agency.</p>	
Approved & Released For CCS By:	Tested By:
	
Hsin Fu Shih Engineer Supervisor Compliance Certification Services	Ninous Davoudi EMC Engineer Compliance Certification Services

TABLE OF CONTENTS

1	EQUIPMENT UNDER TEST (EUT) DESCRIPTION.....	5
2	FACILITIES AND ACCREDITATION	6
3	SYSTEM DESCRIPTION	7
3.1	DASY4 SYSTEM.....	7
3.2	HAC T-COIL EXTENSION.....	8
3.3	MEASUREMENT SETUP	9
4	CALIBRATION.....	10
4.1	CALIBRATION RESULTS	10
5	BACKGROUND NOISE CHECK.....	12
6	INPUT REFERENCE LEVEL	13
7	BANDWIDTH COMPENSATION FACTOR.....	15
8	T-COIL MEASUREMENT PROCEDURE.....	16
8.1	CONCEPT AND STRATEGY	16
8.2	PREDEFINED PROCEDURES	17
8.3	T-COIL MEASUREMENT POINTS AND REFERENCE PLANE.....	18
9	PROCEDURE USED TO ESTABLISH TEST SIGNAL	19
10	T-COIL MEASUREMENT RESULTS	22
10.1	FREQUENCY RESPONSE	22
10.2	T-COIL RATING.....	23
10.3	CELL BAND	24
10.4	PCS BAND.....	25
11	MEASUREMENT UNCERTAINTY OF AUDIO BAND MAGNETIC MEASUREMENTS	26
12	EQUIPMENT LIST AND CALIBRATION.....	27
13	PHOTOS	28
14	ATTACHMENTS.....	30

1 EQUIPMENT UNDER TEST (EUT) DESCRIPTION

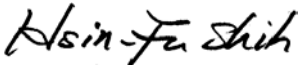
Dual-Band Dual-Mode CDMA Cellular Phone has T-coil capability.	
Normal operation:	Head Position
T-Coil Location:	T-Coil location is same as speaker location
Power supply:	Kyocera Lithium Ion, Model TXBAT10133, 3.7V, 900mAh

2 FACILITIES AND ACCREDITATION

The test sites and measurement facilities used to collect data are located at 561F Monterey Road, Morgan Hill, California, USA. The sites are constructed in conformance with the requirements of ANSI C63.4, ANSI C63.7 and CISPR Publication 22. All receiving equipment conforms to CISPR Publication 16-1, "Radio Interference Measuring Apparatus and Measurement Methods."



NVLAP LAB CODE 200065-0

CCS is accredited by NVLAP, Laboratory Code 200065-0. The full scope of accreditation can be viewed at <http://www.ccsemc.com>.

No part of this report may be used to claim product certification, approval, or endorsement by NVLAP, NIST, or any government agency.

3 SYSTEM DESCRIPTION

3.1 DASY4 SYSTEM

DASY4 system consists of the following items:

- A standard high precision 6-axis robot (Stäubli RX family) with controller, teach pendant and software. An arm extension for accommodating the data acquisition electronics (DAE).
- A dosimetric probe, i.e., an isotropic E-field probe optimized and calibrated for usage in tissue simulating liquid. The probe is equipped with an optical surface detector system.
- A data acquisition electronics (DAE) which performs the signal amplification, signal multiplexing, AD-conversion, offset measurements, mechanical surface detection, collision detection, etc. The unit is battery powered with standard or rechargeable batteries. The signal is optically transmitted to the EOC.
- The function of the measurement server is to perform the time critical tasks such as signal filtering, control of the robot operation and fast movement interrupts.
- A probe alignment unit which improves the (absolute) accuracy of the probe positioning.
- A computer operating Windows 2000 or Windows XP.
- DASY4 software.
- Remote controls with teach pendant and additional circuitry for robot safety such as warning lamps, etc.
- The SAM twin phantom enabling testing left-hand and right-hand usage.
- The device holder for handheld mobile phones.
- Tissue simulating liquid mixed according to the given recipes.
- Validation dipole kits allowing to validate the proper functioning of the system.

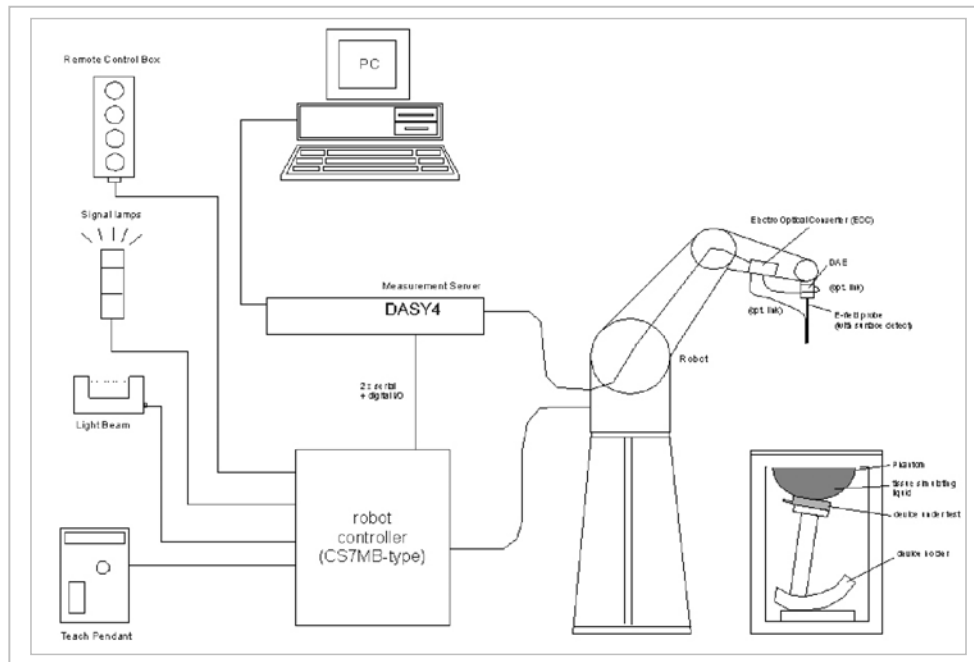

3.2 HAC T-Coil Extension

Audio Band Magnetic measurements are performed using DASY4 system with HAC T-Coil Extension kit. The DASY4 HAC T-Coil Extension consists of the following parts:

- The Test Arch phantom (from HAC RF Extension)
- Audio Magnetic Calibration Coil - AMCC
- Audio Magnetic one- dimensional probe - AM1D probe
- Audio Magnetic Measuring Instrument – AMMI
- DUT holder
- HAC test software

Test Arch phantom

The specially designed Test Arch allows high precision positioning of both the device and any of the validation dipoles.

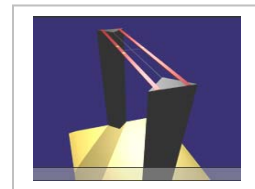

AMCC

The Audio Magnetic Calibration coil is a Helmholtz Coil for calibration of the AM1D probe. The two horizontal coils generate a homogeneous magnetic field in the z direction. The DC input resistance is adjusted to approximately 50 Ohm by a series resistor, and a shunt resistor of 10 Ohm allows monitoring the current with a scale of 1:10.

Signal	Connector	Resistance
Coil In	BNC	50 Ohm typ.
Coil Monitor	BNO	10 Ohm +/- 1% (100mV corresponding to 1

Note: Consider influence of the input resistance of the attached instrumentation when verifying the Coil Monitor signal with external instruments.

AM1D Probe

The AM1D probe is an active probe with a single sensor and it is fully RF shielded and has a rounded tip of 6 mm diameter incorporating a pickup coil with its center offset 3mm from the tip and the sides. The symmetric signal preamplifier in the probe signal is fed via the shielded symmetric output cable from the AMMI with a 48V "phantom" voltage supply.



AMMI

The Audio Magnetic Measuring Instrument (AMMI) is a desktop 19-inch unit containing a sampling unit, a waveform generator for test and calibration signals and a USB interface.

3.3 MEASUREMENT SETUP

The following is diagram of the measurement setup.

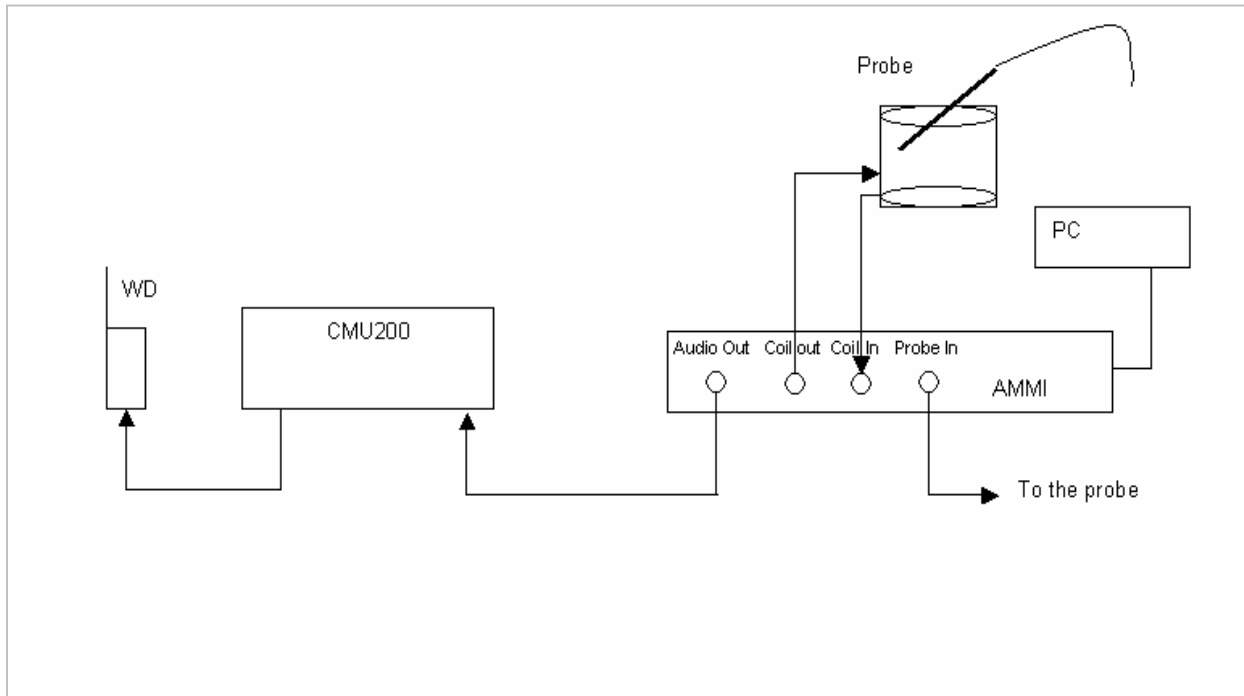

4 CALIBRATION

For correct and calibrated measurement of the voltages and ABM field, DAS4 requires a calibration job at the beginning of each procedure. When the “Calibration” signal is selected in the T-Coil measurement job, a 3-phase calibration is performed.

In phase 1, the audio output is switched off, and a 200 mV_{pp} symmetric rectangular signal of 1 kHz is generated and internally connected directly to both channels of the sampling unit (coil in, probe in).

In phase 2, the audio output is off, and a 20 mV_{pp} symmetric 100 Hz signal is internally connected.

In phase 3, a multisine signal covering each third-octave band from 50 Hz to 5 kHz is generated and applied to both audio outputs. The probe should be positioned in the center of the AMCC (user point “coil center”) and aligned in the z-direction, the field orientation of the AMCC. The Coil In channel is measuring the voltage over the AMCC internal shunt, which is proportional to the magnetic field in the AMCC. At the same time, the probe in channel samples the amplified signal picked up by the probe coil. The ratio of the two voltages in each third-octave filter, leads to the calibration factor of the probe over the frequency band of interest for the spectral representation.

4.1 CALIBRATION RESULTS

The graphics shown below represent the values (applying the calibration factors from the previous steps) for the probe and coil channel in dB V for each third-octave filter from 100 Hz to 5 kHz. The single values are interconnected with a blue line for the probe and a green line for the coil channel. The probe sensitivity in V / (A/m) at 1 kHz is calculated from the values in the chart. -20 dBV in the coil channel corresponds approx. to 1 A/m. For the AM1DV2 probe, the lines typically cross at 1.5 kHz and a level of -28 dBV.

Probe Calibration in AMCC

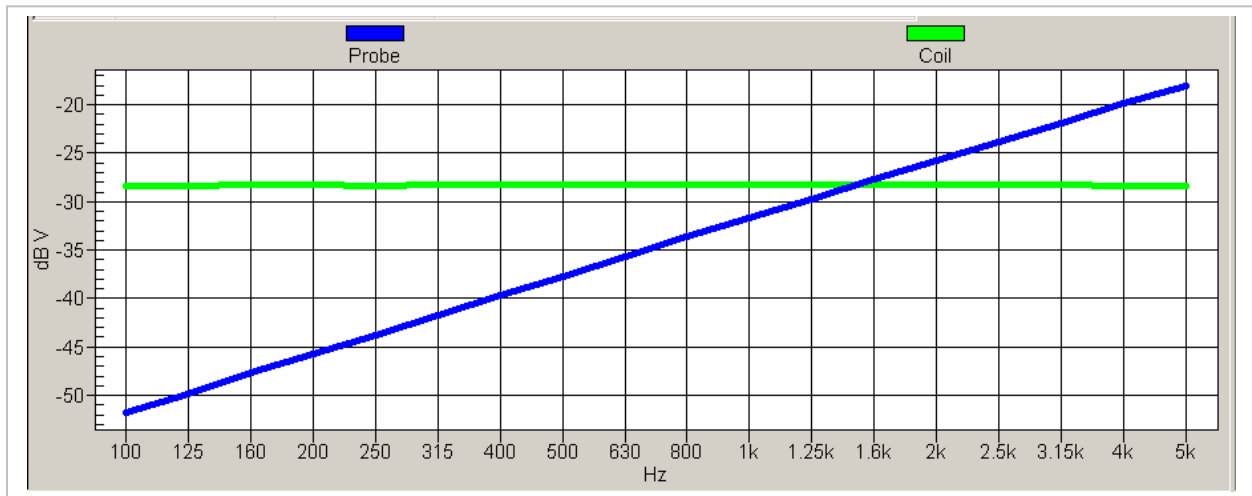

Voice 1 kHz in AMCC

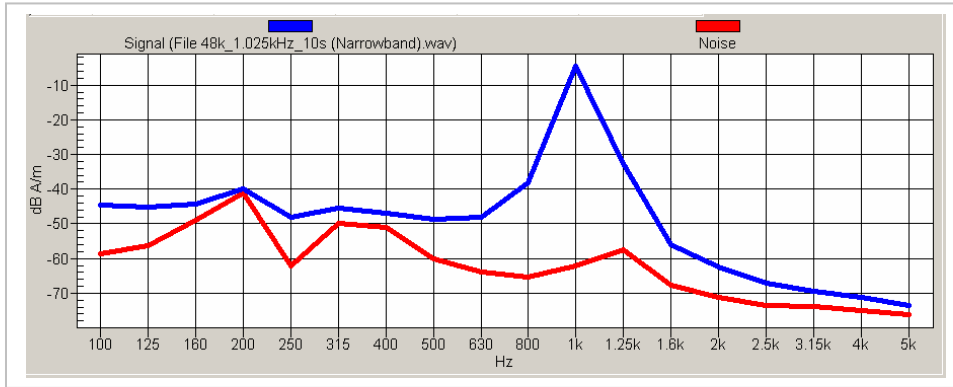

Voice 300 Hz - 3 kHz in AMCC

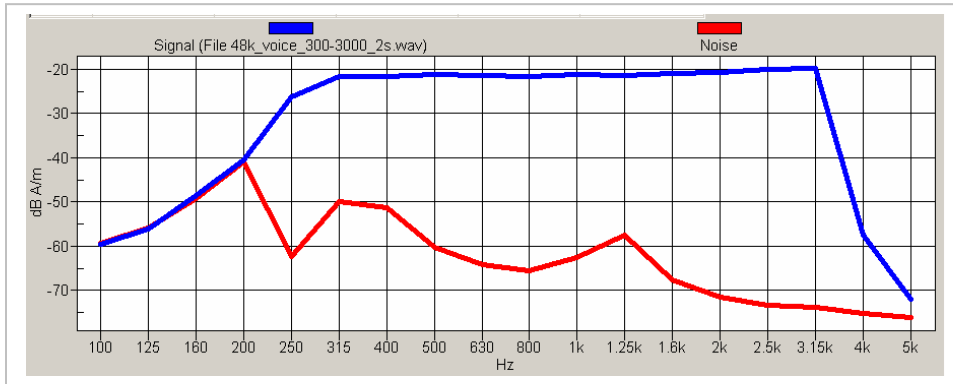

5 BACKGROUND NOISE CHECK

Background noise check is performed prior to test with a predefined DASY4 procedure to make sure the noise levels from the background in the area of the test are low. To ensure the background noise is not affected by the RF radiations, a dipole for each band of frequency with input power of 100mW is used as a source of RF in the location of the wireless device and results are compared with case without wireless device.

Direction	ABM background noise (dB A/M)	ABM background noise with 835MHz dipole (dB A/M)	ABM background noise with 1880MHz dipole (dB A/M)
x	-52.7277	-52.2308	-51.3102
y	-47.1913	-47.0819	-46.8512
z	-53.9736	-53.4783	-53.1469

6 INPUT REFERENCE LEVEL

The input reference can be determined as the ratio (in dB) of 1kHz signal out of AMMI to 1kHz signal out CM200. The following procedure is used to set input level of the CMU200 before testing. First step is to find the U_{ref} , which is 1kHz signal output of the CMU200. Following figure shows the setup to measure U_{ref} .

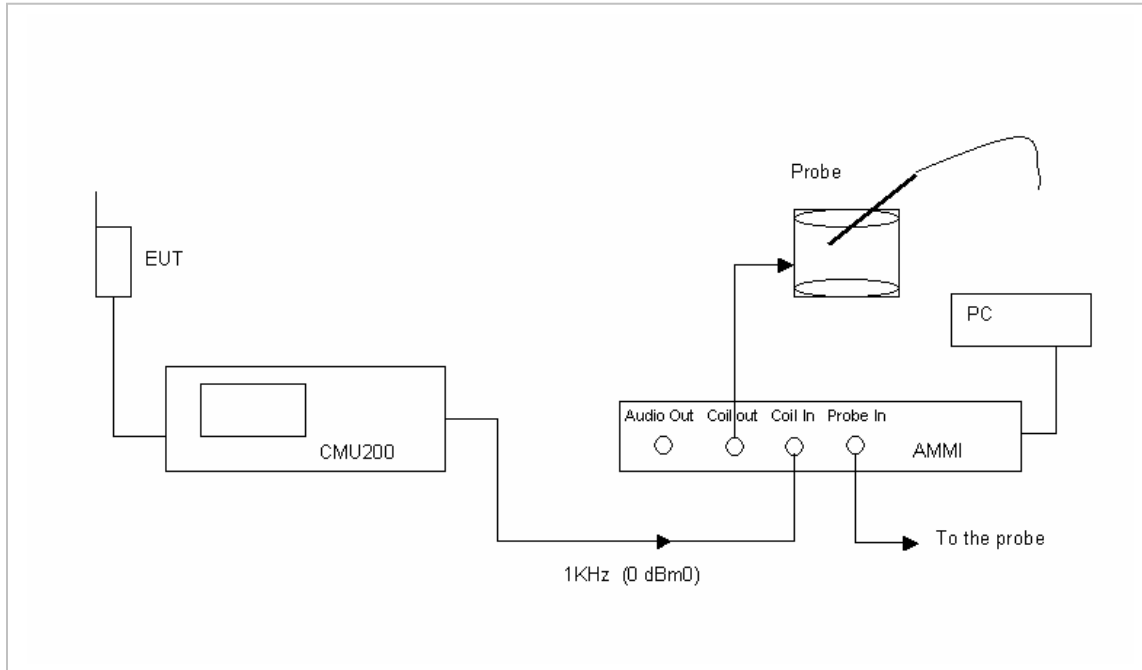

Next step is to measure U, which is the signal from AMMI to the CMU200 during testing. The following setup is used to measure U.

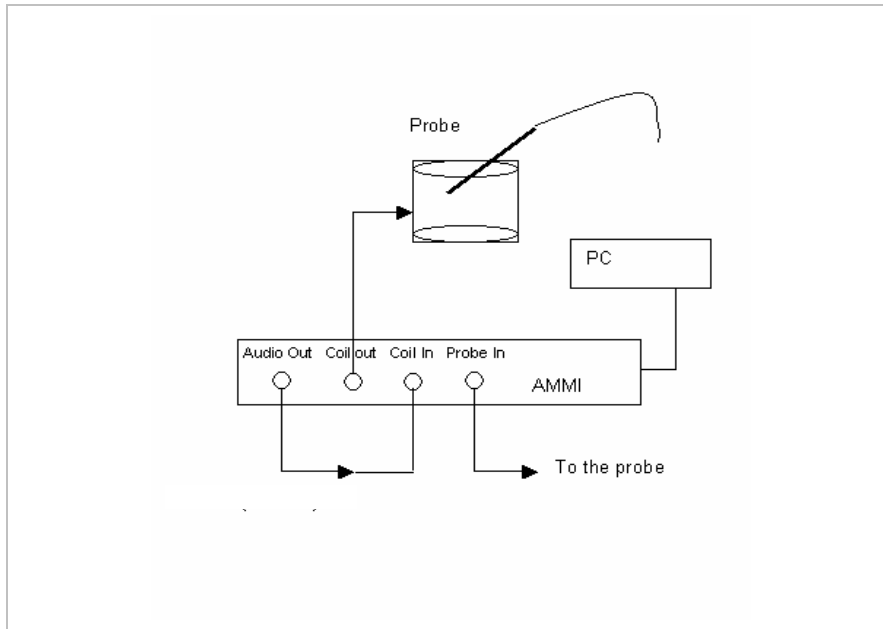

Measured Input Level is calculated as follows:

$$Measured_Input_Level = 20 * \text{Log} \left(\frac{U}{U_{ref}} \right)$$

1.025 kHz Signal

Applied Signal	RMS V	Measured Input Level (dBm0)	Reference Input Level (dBm0)	
U	0.094	-18.0	CDMA	-18.0
U _{ref}	0.752		GSM	-16.0

300 Hz-3 kHz Signal

Applied Signal	RMS V	Measured Input Level (dBm0)	Reference Input Level (dBm0)	
U	0.094	-18.0	CDMA	-18.0
U _{ref}	0.752		GSM	-16.0

7 BANDWIDTH COMPENSATION FACTOR

Bandwidth Compensation Factor is a dB figure representing the total spectral power compared to the power in the 1 kHz third-octave sub-band. The default value is calculated from the reference signal. 0dB means that it is a narrow band 1 kHz signal, and the full signal power is contained in the ABM1 measurement.

The proposed value is calculated as the ratio of (power sum of third-octave filters from 100 Hz to 5 kHz) / (ABM1 in 1 kHz third-octave filter). This factor leads to the "ABM1 bandwidth compensated" which is an estimation of the signal level of a narrowband ABM1 signal with same input amplitude. The estimated value may however differ from a measurement with a narrowband signal due to nonlinearity effects or contribution of noise and interference available during the reference measurement.

References

[1] Dasy4 Manual-Hearing Aid Compatibility (HAC) T-Coil Extension

8 T-COIL MEASUREMENT PROCEDURE

The WD [Wireless Device] is mounted on the Test Arch phantom (provided with the HAC RF extension). Its acoustic center is centered and represents the reference for the combination of ABM and RF field evaluation. The ABM fields of the WD (frequency range < 20 kHz) are scanned with a fully RF-shielded active 1-D probe. The probe axis is oriented in space diagonal to the three orthogonal axes, and its single sensor can be oriented to the axes by 120° rotation. The probe signal is evaluated by an Audio Magnetic Measurement Instrument (AMMI) which is interfaced to the DASY4 computer via USB. The AMMI also provides test and calibration signals and interfaces to the Helmholtz Audio Magnetic Calibration Coil (AMCC). Predefined or user-definable audio signals for injection into the WD during the test are available at a connector of the AMMI.

8.1 CONCEPT AND STRATEGY

For the T-Coil classification of a WD according to [1], the following parameters are relevant:

Signal level (ABM1 for a signal limited to the 1kHz third-octave band)

Signal quality (ABM1 / ABM2), class depending on noise spectrum

Frequency response (at axial position only), limits depending on signal level

In addition, RF E- and H-field at the location of the T-Coil measurement are relevant. The measured values available from the RF scans are evaluated for this purpose in the DASY4 postprocessor.

If the relevant points (axial, radial longitudinal, radial transversal) for the T-Coil signals of a WD are known exactly, the measurement of the T-Coil performance is fast, because it is limited to point measurements. However, if the “optimal points” of a WD are not known in advance, scanning and evaluation is necessary. The standard [1] selects the “optimal point” for the measurement. The optimum is a superposition of the above criteria, which is a combination of

2 limiting criteria:

Signal level ABM1

Frequency response

and 3 classification criteria:

Signal quality ABM1 / ABM2

RF E-field

RF H-field.

Depending on the desired class and the margin available, searching for the “optimal” point should be fast. For searching, a fast voice like signal passing many WD codecs is proposed. It allows one measurement per second for signal level measurement, and with the noise measurement also the signal quality. Due to the bandwidth limitation to the 1 kHz band, no relevant bandwidth compensation is required. In case the narrowband signal would not pass, a wideband voice like signal of 2 seconds duration can be used. The broadband nature of this signal gives a lower ABM1 compared to a narrowband signal. In the post processing, a bandwidth compensation factor can be applied to determine the ABM1 value that could be expected from a narrowband measurement. Independent of this compensation scaling, relative measurements allow display of a relative distribution, even with a limited signal to noise ratio.

With the wideband signal, the frequency slope can be represented by comparing the output signal with the reference (input) signal. The frequency slope generated from a speaker coil should be the same for all field levels and orientations. The result depends however on the noise and interference level at the specific position. Only one measurement of the slope at the axial position with highest S/N is necessary.

The strategy to search the "optimum" point bases on an axially positioned source in the WD (e.g. a speaker planar below the surface). The expected field has a maximum z (axial) component in its center, and two radial maxima with lower amplitude approx. 10mm from the center in the relevant direction x (longitudinal) or y (radial transversal). Based on this arrangement, the following structure is proposed:

- Coarse resolution z scan with fast narrowband signal
- Move to the optimum (S/N) point of the coarse scan z
- Fine scan z centered around optimum z S/N, with fast narrowband signal
- Fine scan x extended in x, centered around optimum z S/N, with fast narrowband signal
- Fine scan y extended in y, centered around optimum z S/N, with fast narrowband signal
- Point measurement z at optimum fine scan z S/N, with wideband signal
- Point measurement z at optimum fine scan z S/N, with slower narrowband signal
- Point measurement x at optimum fine scan x S/N, with slower narrowband signal
- Point measurement y at optimum fine scan y S/N, with slower narrowband signal
- Based on this measurement strategy, the predefined procedures have been assembled.

8.2 PREDEFINED PROCEDURES

A number of procedures with jobs have been predefined to allow a fast start into T-Coil WD emission measurements. They are structured according to the measurement strategy above and cover all required preparation. Depending on the user requirements, the scans should be adapted according to actual needs.

The procedures are structured as follows:

- Geometry & signal check
- (Probe and phantom alignment, check of accuracy, signal amplitude setting)
- Background noise measurement in the area of the WD
- Scans (determine spatial distribution of ABM1, S/N)
- Point Scan (determine ABM1, S/N and frequency response)

8.3 T-COIL MEASUREMENT POINTS AND REFERENCE PLANE

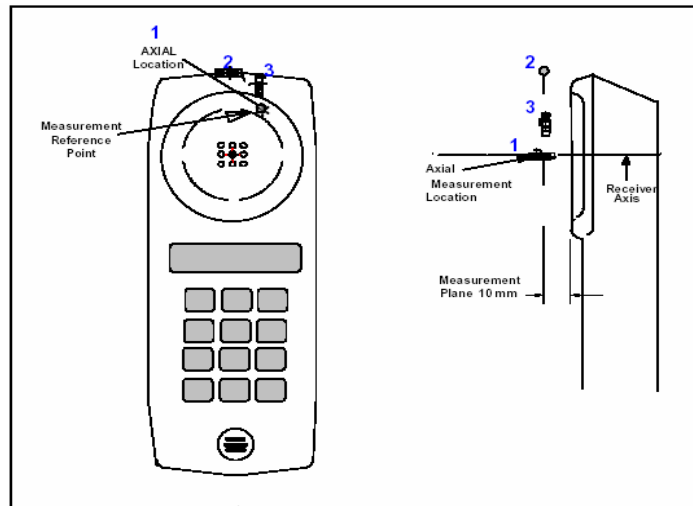

Figure A-5 - Axis & planes for WD audio frequency magnetic field measurements

NOTE: For reference purposes the grid used for Clause 4 testing of the WD in T-Coil mode has been added to this Graphic.

Figure A-5 illustrates the three standard probe orientations. Position 1 is the axial orientation of the probe coil; orientations 2-3 are radial orientations. The space between the measurement positions is not fixed. It is recommended that a scan of the WD be done for each probe coil orientation and that the maximum level recorded be used as the reading for that orientation of the probe coil.

1) The reference plane is the planar area that contains the highest point in the area of the phone that normally rests against the user's ear. It is parallel to the centerline of the receiver area of the phone and is defined by the points of the receiver-end of the WD handset, which, in normal handset use, rest against the ear.

2) The measurement plane is parallel to, and 1.0 cm in front of, the reference plane.

3) The reference axis is normal to the reference plane and passes through the center of the receiver speaker section (or the center of the hole array); or may be centered on a secondary inductive source. The actual location of the measurement point shall be noted in the test report as the measurement reference point.

4) The measurement points may be located where the axial and radial field intensity measurements are optimum with regard to the requirements. However, the measurement points should be near the acoustic output of the WD and shall be located in the same half of the phone as the WD receiver. In a WD handset with a centered receiver and a circularly symmetrical magnetic field, the measurement axis and the reference axis would coincide.

5) The relative spacing of each measurement orientation is not fixed. The axial and two radial orientations should be chosen to select the optimal position.

References

- [1] ANSI-PC63.19-2001, Revision Draft 3.12, January 18, 2006
- [2] Dasy4 Manual-Hearing Aid Compatibility (HAC) T-Coil Extension

9 PROCEDURE USED TO ESTABLISH TEST SIGNAL

The following Table shows the device capabilities.

Device Capability

Radio Configuration (RC)	Service Option (SO)	Description	Device Capability	Tested modes
RC1	1 (Voice)	Basic Variable Rate Voice Service (8 kbps)		
	2 (Loopback)	Mobile Station Loopback (8 kbps), Traffic Data Rate: Full	X	
	3 (Voice)	Enhanced Variable Rate Voice Service (8 kbps)	X	X
	55 (Loopback)	Loopback Service Option (LSO)	X	
RC2	9 (Loopback)	Mobile Station Loopback (13 kbps), Traffic Data Rate: Full	X	
	17 (Voice)*	High Rate Voice Service (13 kbps)	X	X
	55 (Loopback)	Loopback Service Option (LSO), Traffic Data Rate: Full	X	
	32768 (Voice)	Proprietary Service Option (Qualcomm Inc.)		
RC3	1 (Voice)	Basic Variable Rate Voice Service (8 kbps)		
	2 (Loopback)	Mobile Station Loopback (8 kbps), Traffic Data Rate: Full	X	
	3 (Voice)	Enhanced Variable Rate Voice Service (8 kbps)	X	X
	55 (Loopback)	Loopback Service Option (LSO), Traffic Data Rate: Full	X	
	32 (+ F-SCH)	Test Data Service Option (TDSO)	X	
	32 (+ SCH)	Test Data Service Option (TDSO)	X	
RC43	1 (Voice)	Basic Variable Rate Voice Service (8 kbps)		
	2 (Loopback)	Mobile Station Loopback (8 kbps), Traffic Data Rate: Full	X	
	3 (Voice)	Enhanced Variable Rate Voice Service (8 kbps)	X	X
	55 (Loopback)	Loopback Service Option (LSO), Traffic Data Rate: Full	X	
	32 (+ F-SCH)	Test Data Service Option (TDSO)		
	32 (+ SCH)	Test Data Service Option (TDSO)		
RC54	9 (Loopback)	Mobile Station Loopback (13 kbps), Traffic Data Rate: Full	X	
	17 (Voice)*	High Rate Voice Service (13 kbps)	X	X
	55 (Loopback)	Loopback Service Option (LSO), Traffic Data Rate: Full	X	
	32768 (Voice)	Proprietary Service Option (Qualcomm Inc.)		

Note: *SO17 is currently not used/supported by customers

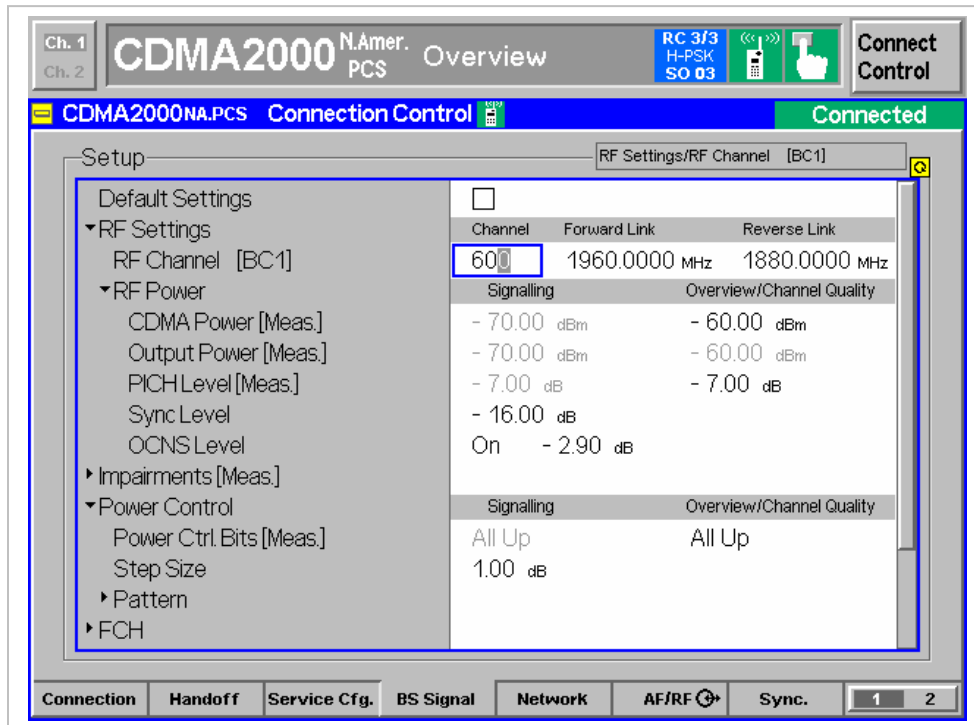
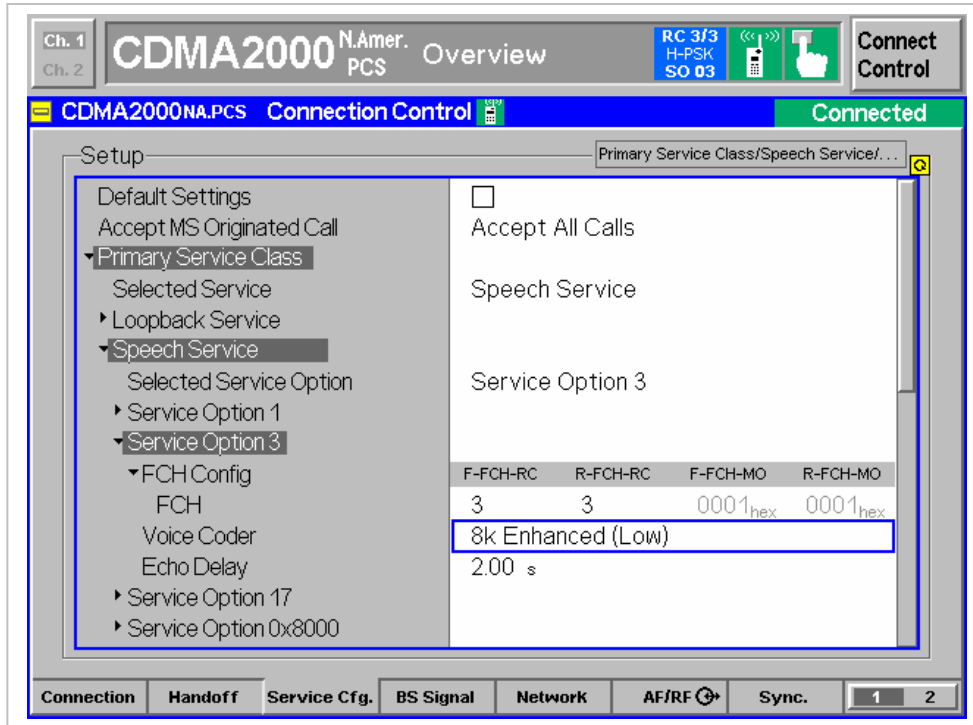

10 T-COIL MEASUREMENT RESULTS

10.1 FREQUENCY RESPONSE

The frequency response of the axial component of the magnetic field, measured in 1/3 octave bands, shall follow the response curve specified in this section, over the frequency range 300-3000 Hz. These response curves are for true field strength measurements of the T-Coil signal. Thus the 6 dB/octave probe response has been corrected from the raw readings.

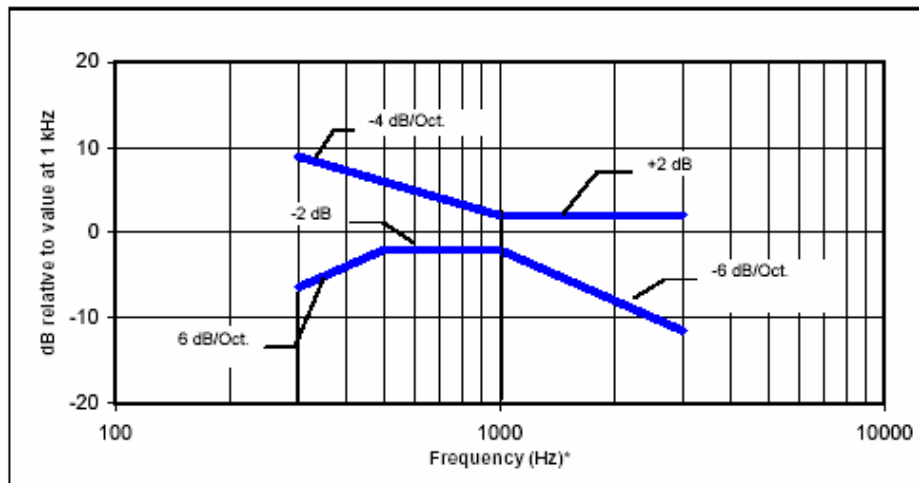

Figure 7-1 - Magnetic field frequency response for WDs with a field between -10 to -13 dB (A/m) at 1 kHz

* Note: Frequency response is between 300 and 3000 Hz

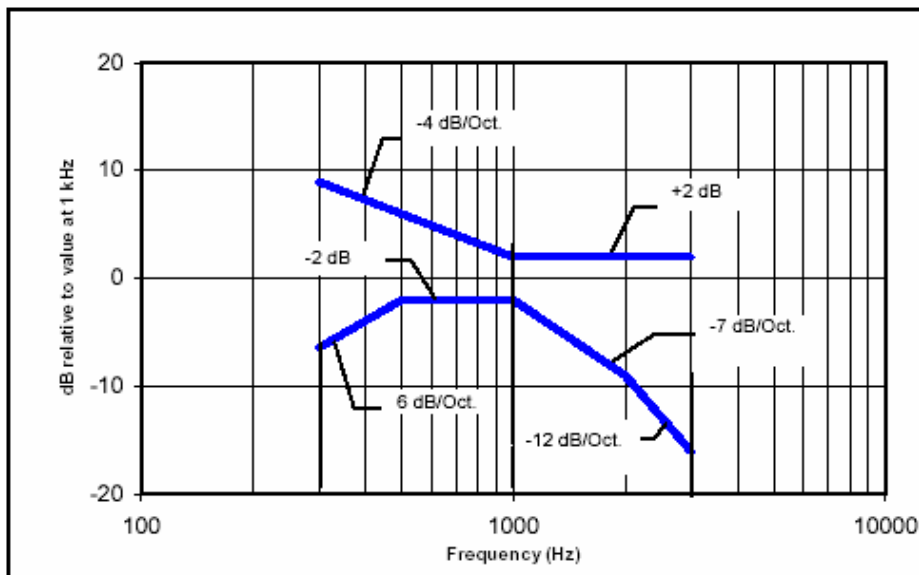

Figure 7-2 - Magnetic field frequency response for WDs with a field that exceeds -10 dB(A/m) at 1 kHz

* Note: Frequency response is between 300 and 3000 Hz

10.2 T-COIL RATING

The following table shows the T category for wireless devices.

Category	ABM1 / ABM2	
	AWF = 0	AWF =-5
Category T1	-20 to -10 dB	-15 to -5 dB
Category T2	-10 to 0 dB	-5 to 5 dB
Category T3	0 to 10 dB	5 to 15 dB
Category T4	> 10 dB	> 15 dB

References

[1] ANSI-PC63.19-2001, Revision Draft 3.12, January 18, 2006

10.3 CELL BAND

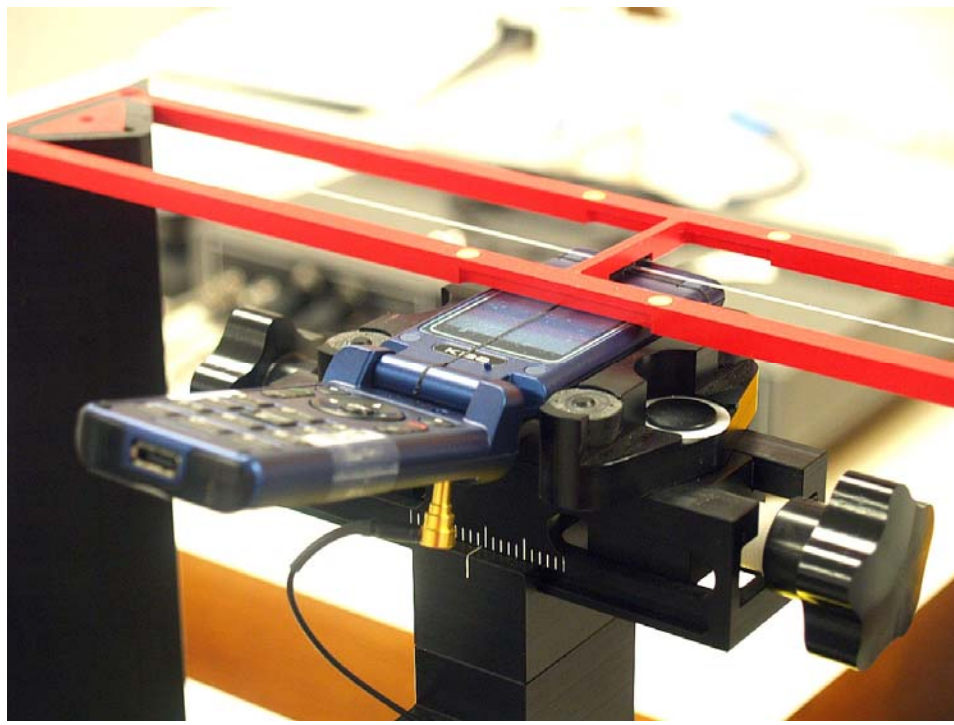

RC Config.	Service Option	Voice Coder	Ch	Frequency Reponse	ABM1/ ABM2	T Rating
RC1	SO3	8K EN ²⁾ Low	1013	PASS	47.49	T4
			383	PASS	45.44	T4
			777	PASS	48.17	T4
RC3	SO3	8K EN Low	383	PASS	46.68	T4
RC43	SO3	8K EN Low	383	PASS	47.42	T4

Notes:

- 1) Please see attachments for the detailed measurements & plots.
- 2) EN stands for Enhanced.
- 3) Volume is set to max and backlight is off during T-coil measurements.

10.4 PCS BAND

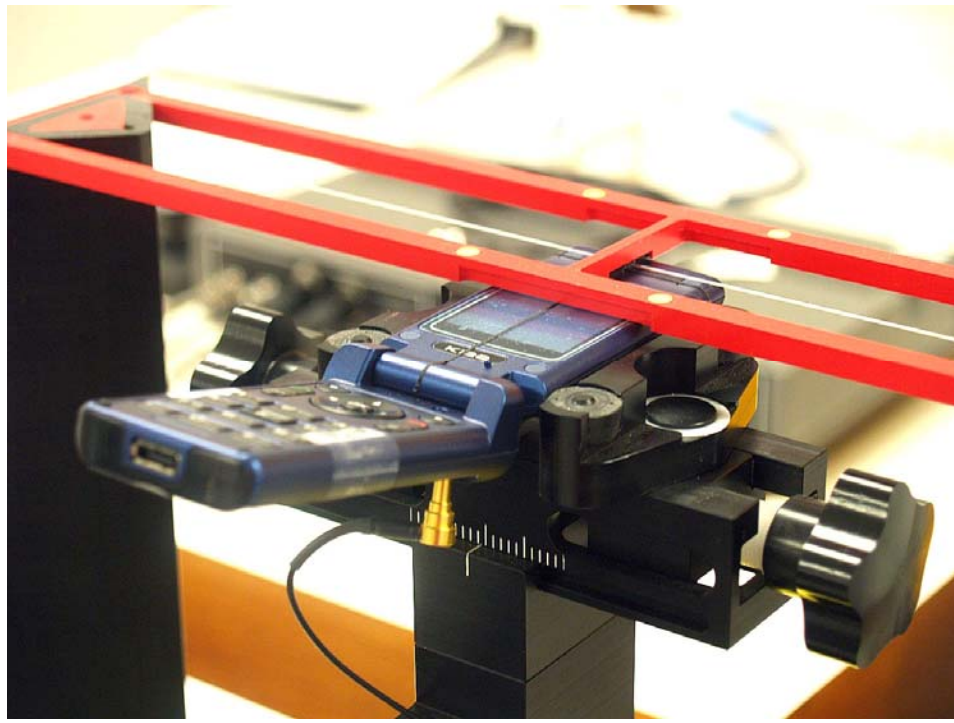

RC Config.	Service Option	Voice Coder	Ch	Frequency Reponse	ABM1/ABM2	T Rating
RC1	SO3	8K EN ²⁾ Low	600	PASS	49.13	T4
RC3	SO3	8K EN Low	25	PASS	47.85	T4
			600	PASS	46.53	T4
			1175	PASS	48.04	T4
RC43	SO3	8K EN Low	600	PASS	47.92	T4

Notes:

- 1) Please see attachments for the detailed measurements & plots.
- 2) EN stands for Enhanced.
- 3) Volume is set to max and backlight is off during T-coil measurements.

11 MEASUREMENT UNCERTAINTY OF AUDIO BAND MAGNETIC MEASUREMENTS

Error Description	Uncertainty values (%)	Probe Dist.	Div.	c AMB1	c AMB2	Std. Unc.	
						AMB1 (%)	AMB2 (%)
Probe Sensitivity							
Reference level	3.0	N	1	1.00	1.00	3.00	3.00
AMCC geometry	0.4	R	1.73	1.00	1.00	0.23	0.23
AMCC current	0.6	R	1.73	1.00	1.00	0.35	0.35
Probe positioning during calibration	0.1	R	1.73	1.00	1.00	0.06	0.06
Noise contribution	0.7	R	1.73	0.01	1.00	0.01	0.40
Frequency slope	5.9	R	1.73	0.10	1.00	0.34	3.41
Probe System							
Repeatability / drift	1.0	R	1.73	1.00	1.00	0.58	0.58
Linearity / Dynamic range	0.6	R	1.73	1.00	1.00	0.35	0.35
Acoustic noise	1.0	R	1.73	0.10	1.00	0.06	0.58
Probe angle	2.3	R	1.73	1.00	1.00	1.33	1.33
Spectral processing	0.9	R	1.73	1.00	1.00	0.52	0.52
Integration time	0.6	N	1.00	1.00	5.00	0.60	3.00
Field disturbance	0.2	R	1.73	1.00	1.00	0.12	0.12
Test Signal							
Reference signal spectral response	0.6	R	1.73	0.00	1.00	0.00	0.35
Positioning							
Probe positioning	1.9	R	1.73	1.00	1.00	1.10	1.10
Phantom positioning	0.9	R	1.73	1.00	1.00	0.52	0.52
EUT positioning	1.9	R	1.73	1.00	1.00	1.10	1.10
External Contributions							
RF interference	0.0	R	1.73	1.00	1.00	0.00	0.00
Test signal variation	2.0	R	1.73	1.00	1.00	1.15	1.15
Combined Std. Uncertainty (ABM field)						4.02	6.08
Expanded Std. Uncertainty (%)						8.04	12.15
Notes for table 1. N - Normal 2. R - Rectangular 3. Div. - Divisor used to obtain standard uncertainty							

12 EQUIPMENT LIST AND CALIBRATION

Name of Equipment	Manufacturer	Type/Model	Serial Number	Cal. Due date		
				MM	DD	Year
Robot - Six Axes	Stäubli	RX90BL	N/A			N/A
Robot Remote Control	Stäubli	CS7MB	3403-91535			N/A
DASY4 Measurement Server	SPEAG	SEUMS001BA	1041			N/A
Probe Alignment Unit	SPEAG	LB (V2)	261			N/A
Audio Magnetic Measuring Ins.l	SPEAG	AMMI	1016			N/A
Coordinating SystemI	SPEAG	AMCC	N/A			N/A
S-Parameter Network Analyzer	Agilent	8753ES-6	US39173569	2	9	2007
ABM Probe	SPEAG	AM1DV2	1012	7	21	2007
Data Acquisition Electronics	SPEAG	DAE3 V1	427	11	16	2007
Data Acquisition Electronics	SPEAG	DAE4	558	1	20	2007
Dipole 835MHz	SPEAG	CD835V3	SN1014	2	24	2007
Dipole 1880MHz	SPEAG	CD1880V3	SN1010	2	23	2007
Power Meter	Agilent	E4416A	GB41291160	12	2	2007
Amplifier	Mini-Circuits	ZHL-42W	D072701-5			N/A
Radio Communication Tester	R &S	CMU 200	838114/032	3	21	2007
Digital Oscilloscope	Tektronics	TDS210	B052990	1	18	2008
Signal Generator	HP	83732B	US34490599	10	5	2008

13 PHOTOS

DUT



DUT



14 ATTACHMENTS

No.	Contents	No. Of Pages
1	Background Noise Plots	9
2-1	ABM Signal Plots	10
2-2	SNR Plots	10
2-3	Frequency Response Plots	10
3	Certificate of E-Field Probe - AM1DV2SN1012	1
4	Certificate of Calibration Dipole (CD835V3SN1014)	6
5	Certificate of Calibration Dipole (CD1880V3SN1010)	6

END OF REPORT