



**EMC TEST REPORT**

**Kyocera Wireless Corp.**

**K24 Dual Band Tri-Mode Cell Phone with Bluetooth Capability**

Model: **K323**

RADIATED EMISSIONS

FCC, PART 2.1053

FCC, PART 22 SUBPART H

FCC, PART 24 SUBPART E

INDUSTRY CANADA, RSS-129

INDUSTRY CANADA, RSS-133

TEST REPORT # 2006 040299 K323 PART22/24

26-299-KYO

NEMKO USA, INC.  
11696 SORRENTO VALLEY ROAD SUITE F  
SAN DIEGO, CA 92121  
PHONE: 858-755-5525

<b><i>Nemko USA, Inc.</i></b>		11696 Sorrento Valley Road, Suite F, San Diego, CA 92121 Phone (858) 755-5525 Fax (858) 452-1810	
<b>DATE</b>	<b>DOCUMENT NAME</b>	<b>DOCUMENT #</b>	<b>PAGE</b>
May 5, 2006	Kyocera Wireless Corp. K323 FCC Part 22/24 Test Report	2006 040299 K323 Part22/24	2 of 31

**TABLE OF CONTENTS**

1. DESCRIPTION OF TESTING METHODS ..... 7  
2. TEST RESULTS..... 12

**TEST SETUP DIAGRAMS**

FIGURE 1. GENERAL EUT TEST SETUP PICTURE ..... 9  
FIGURE 2. RADIATED EMISSIONS TEST SETUP DIAGRAM ..... 11

**TEST CONFIGURATION PHOTOGRAPHS**

PHOTOGRAPH 1. K323, K24 DUAL BAND TRI MODE CELLULAR PHONE WITH BLUETOOTH..... 8  
PHOTOGRAPH 2. FCC, PART 22/24 RADIATED EMISSIONS TEST CONFIGURATION..... 22

**APPENDICES**

A. RADIATED EMISSIONS MEASUREMENT UNCERTAINTIES ..... 23  
B. NEMKO USA, INC. TEST EQUIPMENT & FACILITIES CALIBRATION PROGRAM ..... 25  
C. NVLAP ACCREDITATION / NEMKO AUTHORIZATION ..... 27

<b>Nemko USA, Inc.</b>		11696 Sorrento Valley Road, Suite F, San Diego, CA 92121 Phone (858) 755-5525 Fax (858) 452-1810	
<b>DATE</b>	<b>DOCUMENT NAME</b>	<b>DOCUMENT #</b>	<b>PAGE</b>
May 5, 2006	Kyocera Wireless Corp. K323 FCC Part 22/24 Test Report	2006 040299 K323 Part22/24	3 of 31

**EMC Test Report**  
**For**  
**Kyocera Wireless Corp.**

Test Number : 26-299-KYO

Product Name : K24 Dual band Tri-mode Cell Phone with Bluetooth Capability

Regulation : FCC, Part 22, Subpart H, Part 24, Subpart E  
: Industry Canada, RSS-129, RSS-133

Date : May 5, 2006

Report Reviewed

Accepted by:

\_\_\_\_\_

Kyocera Wireless Corp.  
10300 Campus Point Drive  
San Diego, CA 92121  
Phone: 858 882-1631  
Fax: 619 330-4977

Report Issued By: *F. R. Fluery*

F. R. Fluery, Frontline Manager

Tested By:

*Mike Krumweide*  
Mike Krumweide, EMC Test Engineer

<b><i>Nemko USA, Inc.</i></b>		11696 Sorrento Valley Road, Suite F, San Diego, CA 92121 Phone (858) 755-5525 Fax (858) 452-1810	
<b>DATE</b>	<b>DOCUMENT NAME</b>	<b>DOCUMENT #</b>	<b>PAGE</b>
May 5, 2006	Kyocera Wireless Corp. K323 FCC Part 22/24 Test Report	2006 040299 K323 Part22/24	4 of 31

## Administrative Data

Regulation : FCC, Part 22, Subpart H, Part 24, Subpart E  
: Industry Canada, RSS-129, RSS-133

Test Method : ANSI C63.4 – 2004  
: CSA C108. - M1983  
: TIA/EIA 603B

Test Type : Certification  
Manufacturer : Kyocera Wireless  
EUT Type : K24 Dual band Tri-mode Cell Phone with Bluetooth Capability  
Model # : K323  
Date(s) of Test : April 25 to May 5, 2006  
Customer Personnel : Christy, Le

Nemko Personnel : Mike Krumweide, EMC Test Engineer  
:

Test Location : OPEN Area Test Site  
Nemko USA, Inc.  
11696 Sorrento Valley Road, Suite F  
San Diego, CA 92121

<b>Nemko USA, Inc.</b>		11696 Sorrento Valley Road, Suite F, San Diego, CA 92121 Phone (858) 755-5525 Fax (858) 452-1810	
<b>DATE</b>	<b>DOCUMENT NAME</b>	<b>DOCUMENT #</b>	<b>PAGE</b>
May 5, 2006	Kyocera Wireless Corp. K323 FCC Part 22/24 Test Report	2006 040299 K323 Part22/24	5 of 31

## EUT Description

The K323 is a K24 Dual band Tri-mode Cell Phone with Bluetooth Capability. Its function is to provide communication for mobile phone users. The EUT was exercised in CDMA (Cell), FM (Amps), and PCS Transmit modes in open and closed configurations for radiated emissions.

<b>DEVICE</b>	<b>MANUFACTURER</b>		<b>POWER CABLE</b>
	<b>MODEL #</b>	<b>SERIAL #</b>	
EUT - K24 Dual Band Tri-Mode Cell Phone with Bluetooth Capability	Kyocera Wireless Corp. Model: K323 SN: F000000002678		N/A

<b>CONNECTION</b>	<b>I/O CABLE</b>
No connections	

### REASON FOR TEST

The EUT was tested to qualify for FCC Part 22 and Part 24, RSS-129 and RSS-133.

### CHANGES MADE DURING TEST

The following design modifications were made to the EUT during testing.

No design modifications were made to the EUT during testing

### DEVIATIONS FROM STANDARD TEST METHOD

None

<b><i>Nemko USA, Inc.</i></b>		11696 Sorrento Valley Road, Suite F, San Diego, CA 92121 Phone (858) 755-5525 Fax (858) 452-1810	
<b>DATE</b>	<b>DOCUMENT NAME</b>	<b>DOCUMENT #</b>	<b>PAGE</b>
May 5, 2006	Kyocera Wireless Corp. K323 FCC Part 22/24 Test Report	2006 040299 K323 Part22/24	6 of 31

## CERTIFICATION AND TEST SUMMARY

<i>Test Type</i>	<i>In Accordance with Document</i>	<i>Frequency Range Investigated</i>	<i>EUT Complies</i>
Radiated Spurious Emissions	FCC, Part 22, Subpart H, Part 24, Subpart E Industry Canada, RSS-129, RSS-133	824 – 19990 MHz	PASS

The K24 Dual band Tri-mode Cell Phone with Bluetooth Capability complied with FCC Part 22 and Part 24; Industry Canada, RSS129 and RSS-133 when tested in the system configuration defined herein.

<b><i>Nemko USA, Inc.</i></b>		11696 Sorrento Valley Road, Suite F, San Diego, CA 92121 Phone (858) 755-5525 Fax (858) 452-1810	
<b>DATE</b>	<b>DOCUMENT NAME</b>	<b>DOCUMENT #</b>	<b>PAGE</b>
May 5, 2006	Kyocera Wireless Corp. K323 FCC Part 22/24 Test Report	2006 040299 K323 Part22/24	7 of 31

## **DESCRIPTION OF TEST SITE AND EQUIPMENT**

### Description of Test Site

The test site is located at 11696 Sorrento Valley Road, Suite F, San Diego, CA 92121. The site is physically located 18 miles Northwest of downtown San Diego. The general area is a valley 1.5 miles east of the Pacific Ocean. This particular part of the valley tends to minimize ambient levels, i.e. radio and TV broadcast stations and land mobile communications. The three and ten-meter Open Area Test Site (OATS) is located behind the office/lab building. It conforms to the normalized site attenuation limits and construction specifications as set in the EN 55022 (1998), A1(2000), A2(2003), CISPR 16 (2003) and ANSI C63.4 (2004) documents. The OATS normalized site attenuation characteristics are verified for compliance every year. The facility is NAVLAP accredited.

## **1. DESCRIPTION OF TESTING METHODS**

### **1.1. Introduction**

As required in 47 CFR, Parts 2 and 15, the methods employed to test the radiated and conducted emissions (as applicable) of the EUT are those contained within the American National Standards Institute document ANSI C63.4 (2004), titled "Methods of Measurement of Radio-Noise Emissions from Low-Voltage Electrical and Electronic Equipment in the Range of 9 kHz to 40 GHz." All applicable FCC Rule Sections that provide further guidance for performance of such testing are also observed.

For General Test Configuration please refer to Figure 1 on the following page.

Digital devices sold in Canada are required to comply with the Interference Causing Equipment Standard for Digital Apparatus, ICES-003. These test methods and limits are specified in the Canadian Standards Association's (CSA) Standard C108.8-M1983 (1-1-94 version) and are "essentially equivalent" with FCC, Part 15 and CISPR 22 (EN55022) rules for unintentional radiators per EMCAB-3, Issue 3 (May 1998). No further testing is required for compliance to ICES-003.

<i>Nemko USA, Inc.</i>		11696 Sorrento Valley Road, Suite F, San Diego, CA 92121 Phone (858) 755-5525 Fax (858) 452-1810	
DATE	DOCUMENT NAME	DOCUMENT #	PAGE
May 5, 2006	Kyocera Wireless Corp. K323 FCC Part 22/24 Test Report	2006 040299 K323 Part22/24	8 of 31

**Photograph 1. K323, K24 Dual Band Tri Mode Cellular Phone with Bluetooth**





<i>Nemko USA, Inc.</i>		11696 Sorrento Valley Road, Suite F, San Diego, CA 92121 Phone (858) 755-5525 Fax (858) 452-1810	
DATE	DOCUMENT NAME	DOCUMENT #	PAGE
May 5, 2006	Kyocera Wireless Corp. K323 FCC Part 22/24 Test Report	2006 040299 K323 Part22/24	9 of 31

**Figure 1. General EUT Test Setup Picture**



**CONFIGURATION LEGEND**

1. EUT: K323, K24 Dual band Tri-mode Cell Phone with Bluetooth Capability
2. 80cm Non-Conductive Support Table

<b>Nemko USA, Inc.</b>		11696 Sorrento Valley Road, Suite F, San Diego, CA 92121 Phone (858) 755-5525 Fax (858) 452-1810	
<b>DATE</b>	<b>DOCUMENT NAME</b>	<b>DOCUMENT #</b>	<b>PAGE</b>
May 5, 2006	Kyocera Wireless Corp. K323 FCC Part 22/24 Test Report	2006 040299 K323 Part22/24	10 of 31

## 1.2. Configuration and Methods of Measurements for Radiated Emissions

Section 8 of ANSI C63.4 determines the general configuration and procedures for measuring the radiated emissions of equipment under test. Initially, the primary emission frequencies are identified inside the test lab by positioning a broadband receive antenna one meter from the EUT to locate frequencies of significant radiation. Next, the EUT and associated system are placed on a turntable on a ten meter open area test site (registered with the FCC in accord with its Rules and ANSI C63.4) and the receive antenna is located at a distance of three meters from the EUT.

The EUT and associated system are configured to operate continuously, representing a “normally operating” mode. All significant radiated emissions are recorded when maximum radiation on each frequency is observed, in accordance with part 8 of ANSI C63.4 and Section 15.33 of the FCC Rules. To ensure that the maximum emission at each discrete frequency of interest is observed, the receive antenna is varied in height from one to four meters and rotated to horizontal and vertical polarities, and the turntable is also rotated to determine the worst emitting configuration. The numerical results of the test are included herein to demonstrate compliance.

The numerical results that are applied to the emissions limits are arrived at by the following method:

Example:  $A = RR + CL + AF$

A = Amplitude dBuV/M

RR = Receiver Reading dBuV

CL = cable loss dB

AF = antenna factor dBm-1

Example Frequency = 110MHz

18.5 dBuV (spectrum analyzer reading)

+3.0 dB (cable loss @ frequency)

21.5 dBuV

+15.4 dBm-1 (antenna factor @ frequency)

36.9 dBuV/M Final adjusted value

The final adjusted value is then compared to the appropriate emission limit to determine compliance.

For Radiated Emissions Test Configuration please refer to Figure 4 on the following page.

<b>Nemko USA, Inc.</b>		11696 Sorrento Valley Road, Suite F, San Diego, CA 92121 Phone (858) 755-5525 Fax (858) 452-1810	
<b>DATE</b>	<b>DOCUMENT NAME</b>	<b>DOCUMENT #</b>	<b>PAGE</b>
May 5, 2006	Kyocera Wireless Corp. K323 FCC Part 22/24 Test Report	2006 040299 K323 Part22/24	11 of 31

**Figure 2. Radiated Emissions Test Setup Diagram**

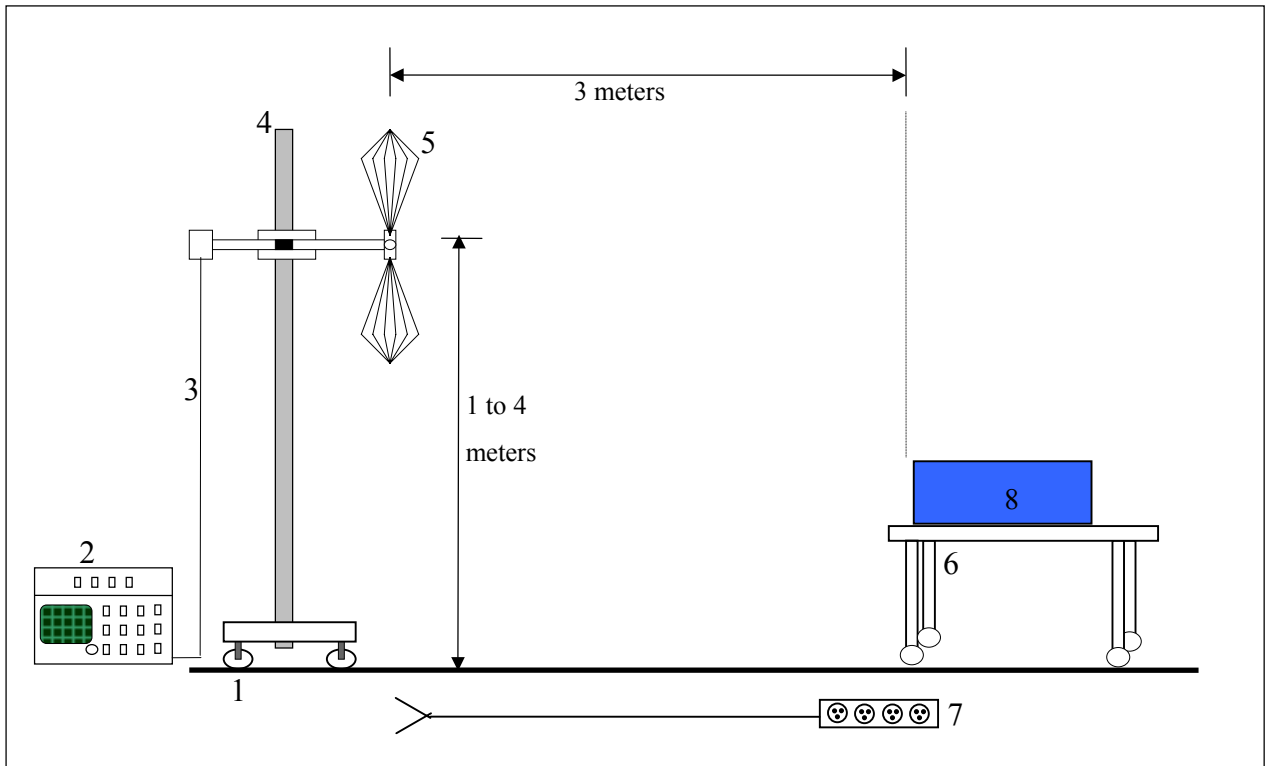

*NOT TO SCALE*

**CONFIGURATION LEGEND**

1. Ground plane (11 X 17 meters)
2. Spectrum Analyzer with Quasi-Peak Adapter
3. Coax interconnect from Receive Antenna to Spectrum Analyzer
4. Antenna Mast with motorized mounting assembly
5. Receive Antenna (basic relative position)
6. Non-Conducting table 80 cm above ground plane
7. AC power for devices
8. EUT: K24 Dual band Tri-mode Cell Phone with Bluetooth Capability

Radiated emissions were measured on three orthogonal axes. Only the maximum emissions of the three axes are stated in this report.

<b><i>Nemko USA, Inc.</i></b>		11696 Sorrento Valley Road, Suite F, San Diego, CA 92121 Phone (858) 755-5525 Fax (858) 452-1810	
<b>DATE</b>	<b>DOCUMENT NAME</b>	<b>DOCUMENT #</b>	<b>PAGE</b>
May 5, 2006	Kyocera Wireless Corp. K323 FCC Part 22/24 Test Report	2006 040299 K323 Part22/24	12 of 31

## 2. Test Results

### 2.1 Radiated Emissions Test Data

FCC Part 2, 22 & 24 Emissions Substitution

- 1) Methodology Used: TIA/EIA603 (see attached excerpt).
- 2) The Substitution Method is used for fundamental power levels and spurious emissions when RF emission signals are measured within 20 dB of the limit.
- 3) Formula Used to calculate the values:
  - a) Measured value + antenna factor + cable loss - preamplifier = Max Level
  - b) Margin = Max level - Limit
  - c) Signal Generator power level - cable loss + antenna gain = ERP Part 22 or EIRP Part 24
  - d) Substituted Margin = ERP (or EIRP) - Limit

*Note: gain for dipole = 0; antenna factor is not the same as antenna gain*

Note: The signal generator power level is the power required when transmitting into the substituting antenna to duplicate the Measured Value. Substituted margin is reported in 731 forms pertaining to certification grants and Class II Permissive Changes when a direct conducted power reading cannot be performed.

Note: Per FCC Part 2:1051 the FCC does not require reporting of Spurious Emissions when they are more than 20dB below the permissible limit, therefore no signal substitution measurements will be performed on these signals.

DATE	DOCUMENT NAME	DOCUMENT #	PAGE
May 5, 2006	Kyocera Wireless Corp. K323 FCC Part 22/24 Test Report	2006 040299 K323 Part22/24	13 of 31

**Radiated Emissions Data**

Job #: 26-299-KYO Test #: 1  
Page 1 of 1

Client Name : Kyocera Wireless Corp.  
 EUT Name : K24 Dual Band Tri-Mode Cellular Phone with Bluetooth  
 EUT Model # : K323  
 EUT Serial # : FM00000002678  
 EUT Config. : FM TX Harmonics  
Open  
 Specification : FCC Part 22 Reference : \_\_\_\_\_  
 Rod. Ant. # : \_\_\_\_\_ Temp. (°C) : 14 Date : 04/25/06  
 Bicon Ant.#: \_\_\_\_\_ Humidity (%) : 65 Staff : Mike Krumweide  
 Log Ant.#: \_\_\_\_\_ EUT Voltage : NA Peak Bandwidth: 1 MHz  
 DRG Ant. # 877 EUT Frequency : NA Video Bandwidth 1 MHz  
 Dipole Ant.#: \_\_\_\_\_ Phase: NA  
 Cable#: 40ft Location: RN # 329550-01  
 Preamp#: 842 Distance: 3m  
 Spec An.#: 835 ERP conversion factor 7

Meas. Freq. (MHz)	Vertical (dBuV) pk	Horizontal (dBuV) pk	CF (db)	Max Level (dBm) pk	Spec. Limit (ERP) (dBm) pk	Margin dB pk	EUT Rotation	Ant. Height	Pass Fail Unc.	Comment
Maximum of 3 Axes										
1648.08	64.9	65.9	-22.3	-53.7	-13.0	-40.7		1.0	Pass	*
2472.12	64.2	65.7	-15.8	-47.4	-13.0	-34.4		2.0	Pass	*
3296.16	67.3	69.8	-10.3	-37.8	-13.0	-24.8		1.0	Pass	*
4120.20	55.2	56.6	-5.0	-45.6	-13.0	-32.6		1.3	Pass	*
4944.24	47.8	47.5	-4.3	-53.7	-13.0	-40.7		1.0	Pass	*
5768.28	50.3	50.1	-0.9	-47.8	-13.0	-34.8		1.0	Pass	*
6592.32	48.7	48.7	1.0	-47.6	-13.0	-34.6			Pass	NF
7416.36	47.8	47.8	3.9	-45.6	-13.0	-32.6			Pass	NF
8240.40	47.1	47.1	5.4	-44.8	-13.0	-31.8			Pass	NF
9064.44	45.6	45.6	9.2	-42.5	-13.0	-29.5			Pass	NF
1672.98	66.3	66.9	-22.3	-52.7	-13.0	-39.7		1.0	Pass	*
2509.47	64.9	66.5	-15.0	-45.8	-13.0	-32.8		2.0	Pass	*
3345.96	66.6	70.7	-10.3	-36.9	-13.0	-23.9		1.0	Pass	*
4182.45	56.7	56.4	-5.0	-45.5	-13.0	-32.5		1.5	Pass	*
5018.94	48	47.3	-0.2	-49.4	-13.0	-36.4		1.2	Pass	*
5855.43	50	49.4	-0.9	-48.1	-13.0	-35.1		1.0	Pass	*
6691.92	48.1	48.1	1.0	-48.2	-13.0	-35.2			Pass	NF
7528.41	47.6	47.6	4.1	-45.6	-13.0	-32.6			Pass	NF
8364.90	47.2	47.2	5.4	-44.7	-13.0	-31.7			Pass	NF
9201.39	46	46	9.2	-42.1	-13.0	-29.1			Pass	NF
1697.94	67.0	67.1	-22.3	-52.5	-13.0	-39.5		1.0	Pass	*
2546.91	68.1	69.0	-15.0	-43.3	-13.0	-30.3		1.5	Pass	*
3395.88	64.1	69.1	-10.3	-38.5	-13.0	-25.5		1.3	Pass	*
4244.85	57.4	56.3	-5.0	-44.8	-13.0	-31.8		1.0	Pass	*
5093.82	50.5	50.3	-0.2	-46.9	-13.0	-33.9		1.4	Pass	*
5942.79	50.3	50.2	-0.9	-47.8	-13.0	-34.8		1.2	Pass	*
6791.76	47.8	47.8	1.0	-48.5	-13.0	-35.5			Pass	NF
7640.73	47.5	47.5	4.1	-45.7	-13.0	-32.7			Pass	NF
8489.70	47.8	47.8	5.4	-44.1	-13.0	-31.1			Pass	NF
9338.67	46.2	46.2	9.2	-41.9	-13.0	-28.9			Pass	NF

\* = Signal Measured NF = Noise Floor, no signal observed, even at lower RBW.

DATE	DOCUMENT NAME	DOCUMENT #	PAGE
May 5, 2006	Kyocera Wireless Corp. K323 FCC Part 22/24 Test Report	2006 040299 K323 Part22/24	14 of 31

**Radiated Emissions Data**

Job #: 26-299-KYO Test #: 2  
Page 1 of 1

Client Name : Kyocera Wireless Corp.  
 EUT Name : K24 Dual Band Tri-Mode Cellular Phone with Bluetooth  
 EUT Model # : K323  
 EUT Serial # : FM00000002678  
 EUT Config. : FM TX Harmonics  
Closed  
 Specification : FCC Part 22 Reference : \_\_\_\_\_  
 Rod. Ant. # : \_\_\_\_\_ Temp. (°C) : 14 Date : 04/25/06  
 Bicon Ant.#: \_\_\_\_\_ Humidity (%) : 65 Staff : Mike Krumweide  
 Log Ant.#: \_\_\_\_\_ EUT Voltage : NA Peak Bandwidth: 1 MHz  
 DRG Ant. # 877 EUT Frequency : NA Video Bandwidth 1 MHz  
 Dipole Ant.#: \_\_\_\_\_ Phase: NA  
 Cable#: 40ft Location: RN # 329550-01  
 Preamp#: 842 Distance: 3m  
 Spec An.#: 835 ERP conversion factor 7

Meas. Freq. (MHz)	Vertical (dBuV) pk	Horizontal (dBuV) pk	CF (db)	Max Level (dBm) pk	Spec. Limit (ERP) (dBm) pk	Margin dB pk	EUT Rotation	Ant. Height	Pass Fail Unc.	Comment
Maximum of 3 Axes										
1648.08	61.7	65.9	-22.3	-53.7	-13.0	-40.7		1.0	Pass	*
2472.12	65.2	67.4	-15.8	-45.7	-13.0	-32.7		2.2	Pass	*
3296.16	64.9	64.9	-10.3	-42.7	-13.0	-29.7		1.7	Pass	*
4120.20	56.4	57.8	-5.0	-44.4	-13.0	-31.4		1.5	Pass	*
4944.24	46.9	47.1	-4.3	-54.4	-13.0	-41.4		1.5	Pass	*
5768.28	50.4	50.3	-0.9	-47.7	-13.0	-34.7		1.3	Pass	*
6592.32	48.7	48.7	1.0	-47.6	-13.0	-34.6			Pass	NF
7416.36	47.8	47.8	3.9	-45.6	-13.0	-32.6			Pass	NF
8240.40	47.1	47.1	5.4	-44.8	-13.0	-31.8			Pass	NF
9064.44	45.6	45.6	9.2	-42.5	-13.0	-29.5			Pass	NF
1672.98	59.6	64.4	-22.3	-55.2	-13.0	-42.2		1.0	Pass	*
2509.47	65.4	66.0	-15.0	-46.3	-13.0	-33.3		1.7	Pass	*
3345.96	67.8	69.9	-10.3	-37.7	-13.0	-24.7		1.0	Pass	*
4182.45	56.3	57.2	-5.0	-45.0	-13.0	-32.0		1.2	Pass	*
5018.94	47.4	48	-0.2	-49.4	-13.0	-36.4		2.0	Pass	*
5855.43	50	50.7	-0.9	-47.4	-13.0	-34.4		1.4	Pass	*
6691.92	48.1	48.1	1.0	-48.2	-13.0	-35.2			Pass	NF
7528.41	47.6	47.6	4.1	-45.6	-13.0	-32.6			Pass	NF
8364.90	49.5	49.5	5.4	-42.4	-13.0	-29.4			Pass	NF
9201.39	46	46	9.2	-42.1	-13.0	-29.1			Pass	NF
1697.94	60.2	63.8	-22.3	-55.8	-13.0	-42.8		1.0	Pass	*
2546.91	62.7	63.6	-15.0	-48.7	-13.0	-35.7		1.0	Pass	*
3395.88	63.5	65.3	-10.3	-42.3	-13.0	-29.3		1.2	Pass	*
4244.85	54.2	54.8	-5.0	-47.4	-13.0	-34.4		1.5	Pass	*
5093.82	48.6	48.6	-0.2	-48.8	-13.0	-35.8		1.0	Pass	*
5942.79	49.8	49.5	-0.9	-48.3	-13.0	-35.3		1.0	Pass	*
6791.76	47.8	47.8	1.0	-48.5	-13.0	-35.5			Pass	NF
7640.73	47.5	47.5	4.1	-45.7	-13.0	-32.7			Pass	NF
8489.70	47.8	47.8	5.4	-44.1	-13.0	-31.1			Pass	NF
9338.67	46.2	46.2	9.2	-41.9	-13.0	-28.9			Pass	NF

\* = Signal Measured NF = Noise Floor, no signal observed, even at lower RBW.

<b>Nemko USA, Inc.</b>		11696 Sorrento Valley Road, Suite F, San Diego, CA 92121 Phone (858) 755-5525 Fax (858) 452-1810	
<b>DATE</b>	<b>DOCUMENT NAME</b>	<b>DOCUMENT #</b>	<b>PAGE</b>
May 5, 2006	Kyocera Wireless Corp. K323 FCC Part 22/24 Test Report	2006 040299 K323 Part22/24	15 of 31

### Radiated Emissions Data

Job # : 26-299-KYO      Test # : 3  
Page 1                      of 1

Client Name :	Kyocera Wireless Corp.		
EUT Name :	K24 Dual Band Tri-Mode Cellular Phone with Bluetooth		
EUT Model # :	K323		
EUT Serial # :	FM000000002678		
EUT Config. :	CDMA TX Harmonics		
	Open		
Specification :	FCC Part 22		Reference :
Rod. Ant. #:	_____	Temp. (°C) :	<u>14</u>
Bicon Ant.#:	_____	Humidity (%) :	<u>65</u>
Log Ant.#:	_____	EUT Voltage :	<u>NA</u>
DRG Ant. #	<u>877</u>	EUT Frequency :	<u>NA</u>
Dipole Ant.#:	_____	Phase:	<u>NA</u>
Cable#:	<u>40ft</u>	Location:	<u>RN # 329550-01</u>
Preamp#:	<u>842</u>	Distance:	<u>3m</u>
Spec An.#:	<u>835</u>	ERP conversion factor	<u>7</u>
		Date :	<u>04/25/06</u>
		Staff :	<u>Mike Krumweide</u>
		Peak Bandwidth:	<u>1 MHz</u>
		Video Bandwidth	<u>1 MHz</u>

Meas. Freq. (MHz)	Vertical (dBuV) pk	Horizontal (dBuV) pk	CF (db)	Max Level (dBm) pk	Spec. Limit (ERP) (dBm) pk	Margin dB pk	EUT Rotation	Ant. Height	Pass Fail Unc.	Comment
										Maximum of 3 Axes
1649.40	69.8	68.4	-22.34	-49.8	-13.0	-36.8		1.2	Pass	*
2474.10	63.7	65.3	-15.8	-47.8	-13.0	-34.8		1.8	Pass	*
3298.80	68.3	71.7	-10.34	-35.9	-13.0	-22.9		1.0	Pass	*
4123.50	56.9	56.2	-4.952	-45.3	-13.0	-32.3		1.5	Pass	*
4948.20	47.7	47.7	-4.252	-53.8	-13.0	-40.8			Pass	*
5772.90	50.2	50.2	-0.871	-47.9	-13.0	-34.9			Pass	NF
6597.60	49.1	49.1	0.9822	-47.2	-13.0	-34.2			Pass	NF
7422.30	48.7	48.7	3.9067	-44.7	-13.0	-31.7			Pass	NF
8247.00	48.3	48.3	5.3678	-43.6	-13.0	-30.6			Pass	NF
9071.70	47.2	47.2	9.1989	-40.9	-13.0	-27.9			Pass	NF
1672.98	73.0	70.7	-22.34	-46.6	-13.0	-33.6		1.0	Pass	*
2509.47	63.5	65.7	-15	-46.6	-13.0	-33.6		1.8	Pass	*
3345.96	67.0	71.8	-10.34	-35.8	-13.0	-22.8		1.0	Pass	*
4182.45	57.5	57.5	-4.952	-44.7	-13.0	-31.7		1.3	Pass	*
5018.94	47.9	47.9	-0.171	-49.5	-13.0	-36.5			Pass	NF
5855.43	48.2	48.2	-0.871	-49.9	-13.0	-36.9			Pass	NF
6691.92	48	48	0.9822	-48.3	-13.0	-35.3			Pass	NF
7528.41	47.8	47.8	4.1067	-45.4	-13.0	-32.4			Pass	NF
8364.90	47.9	47.9	5.3678	-44.0	-13.0	-31.0			Pass	NF
9201.39	46.2	46.2	9.1989	-41.9	-13.0	-28.9			Pass	NF
1696.62	73.6	72.0	-22.34	-46.0	-13.0	-33.0		1.0	Pass	*
2544.93	66.2	67.4	-15	-44.9	-13.0	-31.9		1.6	Pass	*
3393.24	63.9	68.4	-10.34	-39.2	-13.0	-26.2		1.0	Pass	*
4241.55	56.9	55.0	-4.952	-45.3	-13.0	-32.3		1.5	Pass	*
5089.86	50.3	50.3	-0.171	-47.1	-13.0	-34.1			Pass	NF
5938.17	49.8	49.8	-0.871	-48.3	-13.0	-35.3			Pass	NF
6786.48	48.3	48.3	0.9822	-48.0	-13.0	-35.0			Pass	NF
7634.79	47.7	47.7	4.1067	-45.5	-13.0	-32.5			Pass	NF
8483.10	47.4	47.4	5.3678	-44.5	-13.0	-31.5			Pass	NF
9331.41	46.9	46.9	9.1989	-41.2	-13.0	-28.2			Pass	NF

\* = Signal Measured      NF = Noise Floor, no signal observed, even at lower RBW.

DATE	DOCUMENT NAME	DOCUMENT #	PAGE
May 5, 2006	Kyocera Wireless Corp. K323 FCC Part 22/24 Test Report	2006 040299 K323 Part22/24	16 of 31

**Radiated Emissions Data**

Job # : 26-299-KYO      Test # : 4  
Page 1                      of 1

Client Name :	Kyocera Wireless Corp.		
EUT Name :	K24 Dual Band Tri-Mode Cellular Phone with Bluetooth		
EUT Model # :	K323		
EUT Serial # :	FM000000002678		
EUT Config. :	CDMA TX Harmonics		
	Closed		
Specification :	FCC Part 22		Reference :
Rod. Ant. #:	_____	Temp. (°C) :	<u>14</u>
Bicon Ant.#:	_____	Humidity (%) :	<u>65</u>
Log Ant.#:	_____	EUT Voltage :	<u>NA</u>
DRG Ant. #	<u>877</u>	EUT Frequency :	<u>NA</u>
Dipole Ant.#:	_____	Phase:	<u>NA</u>
Cable#:	<u>40ft</u>	Location:	<u>RN # 329550-01</u>
Preamp#:	<u>842</u>	Distance:	<u>3m</u>
Spec An.#:	<u>835</u>	ERP conversion factor	<u>7</u>
		Date :	<u>04/25/06</u>
		Staff :	<u>Mike Krumweide</u>
		Peak Bandwidth:	<u>1 MHz</u>
		Video Bandwidth	<u>1 MHz</u>

Meas. Freq. (MHz)	Vertical (dBuV) pk	Horizontal (dBuV) pk	CF (db)	Max Level (dBm) pk	Spec. Limit (ERP) (dBm) pk	Margin dB pk	EUT Rotation	Ant. Height	Pass Fail Unc.	Comment
										Maximum of 3 Axes
1649.40	72.9	64.2	-22.34	-46.7	-13.0	-33.7		1.2	Pass	*
2474.10	67.4	68.9	-15.8	-44.2	-13.0	-31.2		1.7	Pass	*
3298.80	65.7	67.2	-10.34	-40.4	-13.0	-27.4		1.2	Pass	*
4123.50	56.7	58.3	-4.952	-43.9	-13.0	-30.9		1.4	Pass	*
4948.20	49.3	49.3	-4.252	-52.2	-13.0	-39.2			Pass	NF
5772.90	50.2	50.2	-0.871	-47.9	-13.0	-34.9			Pass	NF
6597.60	49.1	49.1	0.9822	-47.2	-13.0	-34.2			Pass	NF
7422.30	48.7	48.7	3.9067	-44.7	-13.0	-31.7			Pass	NF
8247.00	48.3	48.3	5.3678	-43.6	-13.0	-30.6			Pass	NF
9071.70	47.2	47.2	9.1989	-40.9	-13.0	-27.9			Pass	NF
1672.98	71.3	65.4	-22.34	-48.3	-13.0	-35.3		1.1	Pass	*
2509.47	65.3	67.7	-15	-44.6	-13.0	-31.6		1.5	Pass	*
3345.96	72.4	66.1	-10.34	-35.2	-13.0	-22.2		1.0	Pass	*
4182.45	57.2	57.9	-4.952	-44.3	-13.0	-31.3		1.0	Pass	*
5018.94	47.9	47.9	-0.171	-49.5	-13.0	-36.5			Pass	NF
5855.43	48.2	48.2	-0.871	-49.9	-13.0	-36.9			Pass	NF
6691.92	48	48	0.9822	-48.3	-13.0	-35.3			Pass	NF
7528.41	47.8	47.8	4.1067	-45.4	-13.0	-32.4			Pass	NF
8364.90	47.9	47.9	5.3678	-44.0	-13.0	-31.0			Pass	NF
9201.39	46.2	46.2	9.1989	-41.9	-13.0	-28.9			Pass	NF
1696.62	70.8	67.8	-22.34	-48.8	-13.0	-35.8		1.1	Pass	*
2544.93	62.7	65.4	-15	-46.9	-13.0	-33.9		1.2	Pass	*
3393.24	59.2	63.7	-10.34	-43.9	-13.0	-30.9		1.2	Pass	*
4241.55	54.3	53.9	-4.952	-47.9	-13.0	-34.9		1.2	Pass	*
5089.86	50.3	50.3	-0.171	-47.1	-13.0	-34.1			Pass	NF
5938.17	49.8	49.8	-0.871	-48.3	-13.0	-35.3			Pass	NF
6786.48	48.3	48.3	0.9822	-48.0	-13.0	-35.0			Pass	NF
7634.79	47.7	47.7	4.1067	-45.5	-13.0	-32.5			Pass	NF
8483.10	47.4	47.4	5.3678	-44.5	-13.0	-31.5			Pass	NF
9331.41	46.9	46.9	9.1989	-41.2	-13.0	-28.2			Pass	NF

\* = Signal Measured      NF = Noise Floor, no signal observed, even at lower RBW.



DATE	DOCUMENT NAME	DOCUMENT #	PAGE
May 5, 2006	Kyocera Wireless Corp. K323 FCC Part 22/24 Test Report	2006 040299 K323 Part22/24	17 of 31

**Radiated Emissions Data**

Job # : 26-299-KYO Test # : 5  
Page 1 of 1

Client Name : Kyocera Wireless Corp.  
 EUT Name : K24 Dual Band Tri-Mode Cellular Phone with Bluetooth  
 EUT Model # : K323  
 EUT Serial # : FM000000002678  
 EUT Config. : PCS TX Harmonics  
Open  
 Specification : FCC Part 24 Reference : \_\_\_\_\_  
 Rod. Ant. # : \_\_\_\_\_ Temp. (°C) : 14 Date : 04/25/06  
 Bicon Ant.# : \_\_\_\_\_ Humidity (%) : 65 Staff : Mike Krumweide  
 Log Ant.# : \_\_\_\_\_ EUT Voltage : NA Peak Bandwidth: 1 MHz  
 DRG Ant. # : 877 EUT Frequency : NA Video Bandwidth 1 MHz  
 Dipole Ant.# : \_\_\_\_\_ Phase : NA  
 Cable# : 40ft Location: RN # 329550-01  
 Preamp# : 842 Distance: 3m  
 Spec An.# : 835 EIRP conversion factor 5.5

Meas. Freq. (MHz)	Vertical (dBuV) pk	Horizontal (dBuV) pk	CF (db)	Max Level (dBm) pk	Spec. Limit (ERIP) (dBm) pk	Margin dB pk	EUT Rotation	Ant. Height	Pass Fail Unc.	Comment
										Maximum of 3 Axes
3702.50	71.8	72.1	-9.5	-32.7	-13.0	-19.7		1.5	Pass	*
5553.75	72.4	73.9	-0.9	-22.2	-13.0	-9.2		1.2	Pass	*
7405.00	70.8	68.5	3.9	-20.6	-13.0	-7.6		1.7	Pass	*
9256.25	54.9	57.9	9.2	-28.2	-13.0	-15.2		1.5	Pass	*
11107.50	49.2	49.7	14.8	-30.8	-13.0	-17.8		1.0	Pass	*
12958.75	44.1	44.1	17.6	-33.5	-13.0	-20.5			Pass	NF
14810.00	41	41	20.7	-33.6	-13.0	-20.6			Pass	NF 500kHz RBW
16661.25	36.4	36.4	25.4	-33.5	-13.0	-20.5			Pass	NF 500kHz RBW
18512.50	22.6	22.6	37.8	-34.8	-13.0	-21.8			Pass	NF 30kHz RBW
20363.75	19.2	19.2	38.5	-39.5	-13.0	-26.5			Pass	NF 30kHz RBW
3760.00	74.8	76.4	-9.5	-28.4	-13.0	-15.4		1.0	Pass	*
5640.00	71.3	72.7	-0.9	-23.4	-13.0	-10.4		1.2	Pass	*
7520.00	65.4	64.5	4.1	-25.8	-13.0	-12.8		1.5	Pass	*
9400.00	52.4	54.9	9.2	-31.2	-13.0	-18.2		1.5	Pass	*
11280.00	47.6	48.1	14.8	-32.4	-13.0	-19.4		1.2	Pass	*
13160.00	40.1	40.4	20.5	-34.4	-13.0	-21.4			Pass	NF 500kHz RBW
15040.00	39.9	39.9	21.3	-34.0	-13.0	-21.0			Pass	NF 500kHz RBW
16920.00	36.8	36.8	25.4	-33.1	-13.0	-20.1			Pass	NF 500kHz RBW
18800.00	22.4	22.4	37.9	-34.9	-13.0	-21.9			Pass	NF 30kHz RBW
20690	19	19	38.6	-39.6	-13.0	-26.6			Pass	NF 30kHz RBW
3817.50	76.6	76.7	-9.5	-28.1	-13.0	-15.1		1.3	Pass	*
5726.25	71.5	71.9	-0.9	-24.2	-13.0	-11.2		1.1	Pass	*
7635.00	63.2	61.8	4.1	-28.0	-13.0	-15.0		1.4	Pass	*
9543.75	55.3	54.4	9.4	-30.6	-13.0	-17.6		1.3	Pass	*
11452.50	52.1	49.7	14.8	-28.4	-13.0	-15.4		1.7	Pass	*
13361.25	41.4	41.4	20.5	-33.4	-13.0	-20.4			Pass	NF 500kHz RBW
15270.00	36.9	36.9	21.3	-37.0	-13.0	-24.0			Pass	NF 500kHz RBW
17178.75	26.5	26.5	30.8	-38.0	-13.0	-25.0			Pass	NF 100kHz RBW
19087.50	20.7	20.7	38.0	-36.5	-13.0	-23.5			Pass	NF 30kHz RBW
20996.25	18.8	18.8	39.1	-37.3	-13.0	-24.3			Pass	NF 30kHz RBW

\* = Signal Measured NF = Noise Floor, no signal observed, even at lower RBW.

DATE	DOCUMENT NAME	DOCUMENT #	PAGE
May 5, 2006	Kyocera Wireless Corp. K323 FCC Part 22/24 Test Report	2006 040299 K323 Part22/24	18 of 31

**Radiated Emissions Data**

Job #: 26-299-KYO Test #: 6  
Page 1 of 1

Client Name :	Kyocera Wireless Corp.		
EUT Name :	K24 Dual Band Tri-Mode Cellular Phone with Bluetooth		
EUT Model # :	K323		
EUT Serial # :	FM000000002678		
EUT Config. :	PCS TX Harmonics		
	Closed		
Specification :	FCC Part 24	Reference :	
Rod. Ant. #:		Temp. (°C) :	14
Bicon Ant.#:		Humidity (%) :	65
Log Ant.#:		EUT Voltage :	NA
DRG Ant. #	877	EUT Frequency :	NA
Dipole Ant.#:		Phase:	NA
Cable#:	40ft	Location:	RN # 329550-01
Preamp#:	842	Distance:	3m
Spec An.#:	835	EIRP conversion factor	5.5
		Date :	04/25/06
		Staff :	Mike Krumweide
		Peak Bandwidth:	1 MHz
		Video Bandwidth	1 MHz

Meas. Freq. (MHz)	Vertical (dBuV) pk	Horizontal (dBuV) pk	CF (db)	Max Level (dBm) pk	Spec. Limit (ERIP) (dBm) pk	Margin dB pk	EUT Rotation	Ant. Height	Pass Fail Unc.	Comment
										Maximum of 3 Axes
3702.50	71.7	73.6	-9.5	-31.2	-13.0	-18.2		1.7	Pass	*
5553.75	72.2	74.3	-0.9	-21.8	-13.0	-8.8		1.0	Pass	*
7405.00	71.9	68.6	3.9	-19.5	-13.0	-6.5		1.0	Pass	*
9256.25	54.3	55.3	9.2	-30.8	-13.0	-17.8		1.4	Pass	*
11107.50	51.9	48.4	14.8	-28.6	-13.0	-15.6		1.0	Pass	*
12958.75	44.1	44.1	17.6	-33.5	-13.0	-20.5			Pass	NF
14810.00	41	41	20.7	-33.6	-13.0	-20.6			Pass	NF 500kHz RBW
16661.25	36.4	36.4	25.4	-33.5	-13.0	-20.5			Pass	NF 500kHz RBW
18512.50	22.6	22.6	37.8	-34.8	-13.0	-21.8			Pass	NF 30kHz RBW
20363.75	19.2	19.2	38.5	-39.5	-13.0	-26.5			Pass	NF 30kHz RBW
3760.00	69.9	74.3	-9.5	-30.5	-13.0	-17.5		1.2	Pass	*
5640.00	64.5	73.7	-0.9	-22.4	-13.0	-9.4		1.3	Pass	*
7520.00	65.3	66.9	4.1	-24.3	-13.0	-11.3		2.0	Pass	*
9400.00	49.2	51.6	9.2	-34.5	-13.0	-21.5		2.0	Pass	*
11280.00	48.9	48.6	14.8	-31.6	-13.0	-18.6		1.1	Pass	*
13160.00	40.1	40.1	20.5	-34.7	-13.0	-21.7			Pass	NF 500kHz RBW
15040.00	39.9	39.9	21.3	-34.0	-13.0	-21.0			Pass	NF 500kHz RBW
16920.00	36.8	36.8	25.4	-33.1	-13.0	-20.1			Pass	NF 500kHz RBW
18800.00	22.4	22.4	37.9	-34.9	-13.0	-21.9			Pass	NF 30kHz RBW
20690	19	19	38.6	-39.6	-13.0	-26.6			Pass	NF 30kHz RBW
3817.50	70.6	73.9	-9.5	-30.9	-13.0	-17.9		1.0	Pass	*
5726.25	72.1	73.9	-0.9	-22.2	-13.0	-9.2		1.0	Pass	*
7635.00	59.7	61	4.1	-30.2	-13.0	-17.2		2.0	Pass	*
9543.75	50.3	49.7	9.4	-35.6	-13.0	-22.6		1.2	Pass	*
11452.50	46.7	44.7	14.8	-33.8	-13.0	-20.8		1.1	Pass	*
13361.25	41.4	41.4	20.5	-33.4	-13.0	-20.4			Pass	NF 500kHz RBW
15270.00	36.9	36.9	21.3	-37.0	-13.0	-24.0			Pass	NF 500kHz RBW
17178.75	26.5	26.5	30.8	-38.0	-13.0	-25.0			Pass	NF 100kHz RBW
19087.50	20.7	20.7	38.0	-36.5	-13.0	-23.5			Pass	NF 30kHz RBW
20996.25	18.8	18.8	39.1	-37.3	-13.0	-24.3			Pass	NF 30kHz RBW

\* = Signal Measured NF = Noise Floor, no signal observed, even at lower RBW.

<b>Nemko USA, Inc.</b>		11696 Sorrento Valley Road, Suite F, San Diego, CA 92121 Phone (858) 755-5525 Fax (858) 452-1810	
<b>DATE</b>	<b>DOCUMENT NAME</b>	<b>DOCUMENT #</b>	<b>PAGE</b>
May 5, 2006	Kyocera Wireless Corp. K323 FCC Part 22/24 Test Report	2006 040299 K323 Part22/24	19 of 31

## 2.2 Substitution Method Test Data

Substitution Method For Radiated Emissions			
Complete	<u>  X  </u>	Job # :	<u>26-299-KYO</u>
Preliminary	<u>          </u>	Page	<u>  1  </u>
		Test # :	<u>  7  </u>
		of	<u>  1  </u>
Client Name : <u>Kyocera Wireless Corp.</u>			
EUT Name : <u>K24 Dual Band Tri-Mode Cellular Phone with Bluetooth</u>			
EUT Model # : <u>K323</u>			
EUT Part # : <u>FM00000002678</u>			
EUT Serial # : <u>                          </u>			
EUT Config. : <u>OPEN Configuration</u>			
Specification : <u>FCC Part 24</u>		Reference :	
Rod. Ant. # :	<u>NA</u>	Temp. (deg. C) :	<u>18</u>
Bicon Ant. # :	<u>NA</u>	Humidity (%) :	<u>67</u>
Log Ant. # :	<u>110</u>	EUT Voltage :	<u>NA</u>
DRG Ant. # :	<u>529</u>	EUT Frequency :	<u>NA</u>
Dipole Ant. # :	<u>NA</u>	Phase :	<u>NA</u>
Cable# :	<u>60ft</u>	Location :	<u>RN# 329550-01</u>
Preamp# :	<u>842</u>	Distance :	<u>3m</u>
Spec An. # :	<u>835</u>		
QP # :	<u>NA</u>		
PreSelect# :	<u>NA</u>		
		Date :	<u>5/5/2006</u>
		Time :	<u>          </u>
		Staff :	<u>M. Krumweide</u>
		Photo ID :	<u>          </u>
		Peak Bandwidth :	<u>RBW-1MHz, VBW-1MHz</u>

### Part 24 Substitution

Target Frequency MHz	Target Level dBuV/m	Horn Gain dBi	Cable loss dB	Signal Generator dBm	Total (EIRP) dBm	Spec dBm	Margin dBm
3702.50	72.1	9.9	6.96	-35.40	-32.46	-13	-19.5
5553.75	73.9	11.0	8.82	-29.00	-26.78	-13	-13.8
7405.00	70.8	11.3	10.59	-23.90	-23.19	-13	-10.2
9256.25	57.9	12.1	12.03	-29.70	-29.63	-13	-16.6
11107.50	49.7	12.6	13.9	-34.60	-35.93	-13	-22.9
3760.00	76.4	9.9	6.96	-30.45	-27.53	-13	-14.5
5640.00	72.7	11.2	8.82	-29.00	-26.63	-13	-13.6
7520.00	65.4	11.3	10.59	-25.40	-24.68	-13	-11.7
9400.00	54.9	12.1	12.03	-32.60	-32.53	-13	-19.5
11280.00	48.1	12.5	13.9	-35.60	-36.98	-13	-24.0
3817.50	76.7	9.9	6.96	-30.40	-27.46	-13	-14.5
5726.25	71.9	11.3	8.82	-28.60	-26.09	-13	-13.1
7635.00	63.2	11.3	10.59	-27.50	-26.79	-13	-13.8
9543.75	55.3	12.1	12.03	-30.20	-30.13	-13	-17.1
11452.50	52.1	12.5	13.9	-29.90	-31.34	-13	-18.3

<b>Nemko USA, Inc.</b>		11696 Sorrento Valley Road, Suite F, San Diego, CA 92121 Phone (858) 755-5525 Fax (858) 452-1810	
<b>DATE</b>	<b>DOCUMENT NAME</b>	<b>DOCUMENT #</b>	<b>PAGE</b>
May 5, 2006	Kyocera Wireless Corp. K323 FCC Part 22/24 Test Report	2006 040299 K323 Part22/24	20 of 31

### Substitution Method For Radiated Emissions

Complete <u>  X  </u>	Job # : <u>26-299-KYO</u>	Test # : <u>  8  </u>
Preliminary <u>          </u>	Page <u>  1  </u>	of <u>  1  </u>
Client Name : <u>Kyocera Wireless Corp.</u>		
EUT Name : <u>K24 Dual Band Tri-Mode Cellular Phone with Bluetooth</u>		
EUT Model # : <u>K323</u>		
EUT Part # : <u>FM000000002678</u>		
EUT Serial # : <u>                  </u>		
EUT Config : <u>CLOSED Configuration</u>		
Specification : <u>FCC Part 24</u>		Reference : <u>                  </u>
Rod. Ant. # : <u>  NA  </u>	Temp. (deg. C) : <u>  18  </u>	Date : <u>5/5/2006</u>
Bicon Ant.# : <u>  NA  </u>	Humidity (%) : <u>  67  </u>	Time : <u>                  </u>
Log Ant.# : <u>  110  </u>	EUT Voltage : <u>  NA  </u>	Staff : <u>M. Krumweide</u>
DRG Ant. # : <u>  529  </u>	EUT Frequency : <u>  NA  </u>	Photo ID : <u>                  </u>
Dipole Ant.# : <u>  NA  </u>	Phase : <u>  NA  </u>	Peak Bandwidth : <u>RBW-1MHz, VBW-1MHz</u>
Cable# : <u>  60ft  </u>	Location : <u>RN# 329550-01</u>	
Preamp# : <u>  842  </u>	Distance : <u>  3m  </u>	
Spec An.# : <u>  835  </u>		
QP # : <u>  NA  </u>		
PreSelect# : <u>  NA  </u>		

### Part 24 Substitution

Target Frequency MHz	Target Level dBuV/m	Horn Gain dBi	Cable loss dB	Signal Generator dBm	Total (EIRP) dBm	Spec dBm	Margin dBm
3702.50	73.6	9.9	6.96	-33.90	-30.96	-13	-18.0
5553.75	74.3	11.0	8.82	-28.60	-26.38	-13	-13.4
7405.00	71.9	11.3	10.59	-22.80	-22.09	-13	-9.1
9256.25	55.3	12.1	12.03	-32.30	-32.23	-13	-19.2
11107.50	51.9	12.6	13.9	-32.40	-33.73	-13	-20.7
3760.00	74.3	9.9	6.96	-32.55	-29.63	-13	-16.6
5640.00	73.7	11.2	8.82	-28.00	-25.63	-13	-12.6
7520.00	66.9	11.3	10.59	-23.90	-23.18	-13	-10.2
9400.00	51.6	12.1	12.03	-35.90	-35.83	-13	-22.8
11280.00	48.9	12.5	13.9	-34.80	-36.18	-13	-23.2
3817.50	73.9	9.9	6.96	-33.20	-30.26	-13	-17.3
5726.25	73.9	11.3	8.82	-26.60	-24.09	-13	-11.1
7635.00	61	11.3	10.59	-29.70	-28.99	-13	-16.0
9543.75	50.3	12.1	12.03	-35.20	-35.13	-13	-22.1
11452.50	46.7	12.5	13.9	-35.30	-36.74	-13	-23.7

<b>Nemko USA, Inc.</b>		11696 Sorrento Valley Road, Suite F, San Diego, CA 92121 Phone (858) 755-5525 Fax (858) 452-1810	
<b>DATE</b>	<b>DOCUMENT NAME</b>	<b>DOCUMENT #</b>	<b>PAGE</b>
May 5, 2006	Kyocera Wireless Corp. K323 FCC Part 22/24 Test Report	2006 040299 K323 Part22/24	21 of 31

## RADIATED EMISSIONS AND SUBSTITUTION METHOD

### TEST EQUIPMENT

Client	Kyocera Wireless Corp.	EUT Name	K24 Dual band Tri-mode Cell Phone with Bluetooth Capability		
PAN #	26-299-KYO	EUT Model	K323		
<i>Device Type</i>		<i>Model #</i>	<i>Asset #</i>	<i>Cal Done</i>	<i>Cal Due</i>
<b><i>Pre-Amplifier</i></b>					
High-Frequency		Nemko	842	5/19/05	5/19/06
<b><i>Antenna</i></b>					
Antenna, Ridged Guide		3115	877	4/19/05	6/19/06 Verified
Antenna, Ridged Guide		3115	529	4/13/05	6/13/06 Verified
<b><i>Spectrum Analyzer / Receiver</i></b>					
Spectrum Analyzer, R&S		RHDFSEK	835	1/18/06	1/18/07
Signal Generator, Agilent		E8254A	836	12/5/05	12/5/06
Signal Generator, HP		8648B	746	10/30/05	10/31/06

<i>Nemko USA, Inc.</i>		11696 Sorrento Valley Road, Suite F, San Diego, CA 92121 Phone (858) 755-5525 Fax (858) 452-1810	
DATE	DOCUMENT NAME	DOCUMENT #	PAGE
May 5, 2006	Kyocera Wireless Corp. K323 FCC Part 22/24 Test Report	2006 040299 K323 Part22/24	22 of 31

## Photograph 2. FCC, Part 22/24 Radiated Emissions Test Configuration



<b>Nemko USA, Inc.</b>		11696 Sorrento Valley Road, Suite F, San Diego, CA 92121 Phone (858) 755-5525 Fax (858) 452-1810	
<b>DATE</b>	<b>DOCUMENT NAME</b>	<b>DOCUMENT #</b>	<b>PAGE</b>
May 5, 2006	Kyocera Wireless Corp. K323 FCC Part 22/24 Test Report	2006 040299 K323 Part22/24	23 of 31

## APPENDIX A

### A. Radiated Emissions Measurement Uncertainties

#### 1. Introduction

ISO/IEC 17025:1999 and ANSI/NCSL Z540-1-1994 require that all measurements contained in a test report be “traceable”. “Traceability” is defined in the *International Vocabulary of Basic and General Terms in Metrology* (ISO: 1993) as: “the property of the result of a measurement... whereby it can be related to stated references, usually national or international standards, through an unbroken chain of comparisons, *all having stated uncertainties*”.

The purposes of this Appendix are to “state the *Measurement Uncertainties*” of the conducted emissions and radiated emissions measurements contained in Section 5 of this Test Report, and to provide a practical explanation of the meaning of these measurement uncertainties.

#### 2. Statement of the Worst-Case Measurement Uncertainties for the Conducted and Radiated Emissions Measurements Contained in This Test Report

**Table 1: Worst-Case Expanded Uncertainty "U" of Measurement for a k=2 Coverage Factor**

<b>Radiated Emissions Measurement Detection Systems</b>	<b>Applicable Frequency Range</b>	<b>"U" for a k=2 Coverage Factor</b>
HP8568B Spectrum Analyzer with QPA & HP8447F Preamplifier	30 MHz - 200 MHz	+4.0 dB, -4.1 dB
HP8568B Spectrum Analyzer with QPA & HP8447F Preamplifier	200 MHz-1000 MHz	+/- 3.5 dB
HP8566B Spectrum Analyzer with QPA & Preselector	30 MHz - 200 MHz	+3.9 dB, -4.0 dB
HP8566B Spectrum Analyzer with QPA & Preselector	200 MHz-1000 MHz	+/- 3.4 dB
HP8566B Spectrum Analyzer with QPA & HP 8449A Preamplifier	1 GHz - 18 GHz	+2.5 dB, -2.6 dB
HP8566B Spectrum Analyzer with QPA & HP8449A Preamplifier	18 GHz - 40 GHz	+/- 3.4 dB
NOTES:		
1. Applies to 3 and 10 meter measurement distances		
2. Applies to all valid combinations of Transducers (i.e. LISNs, Line Voltage Probes, and Antennas, as appropriate)		
3. Excludes the Repeatability of the EUT		

<b>Nemko USA, Inc.</b>		11696 Sorrento Valley Road, Suite F, San Diego, CA 92121 Phone (858) 755-5525 Fax (858) 452-1810	
<b>DATE</b>	<b>DOCUMENT NAME</b>	<b>DOCUMENT #</b>	<b>PAGE</b>
May 5, 2006	Kyocera Wireless Corp. K323 FCC Part 22/24 Test Report	2006 040299 K323 Part22/24	24 of 31

### 3. Practical Explanation of the Meaning of Radiated Emissions Measurement Uncertainties

In general, a “Statement of Measurement Uncertainty” means that with a certain (specified) confidence level, the “true” value of a measurand will be between a (stated) upper bound and a (stated) lower bound.

In the specific case of EMC Measurements in this test report, the measurement uncertainties of the conducted emissions measurements and the radiated emissions measurements have been calculated in accordance with the method detailed in the following documents:

- *ANSI Z540.2 (2002) Guide to the Expression of Uncertainty in Measurement*
- NIS 81:1994, *The Treatment of Uncertainty in EMC Measurements* (NAMAS, 1994)
- NIST Technical Note 1297(1994), *Guidelines for Evaluating and Expressing the Uncertainty of NIST Measurement Results* (NIST, 1994)

The calculation method used in these documents requires that the stated uncertainty of the measurements be expressed as an “*expanded uncertainty*”, *U*, with a *k=2 coverage factor*. The practical interpretation of this method of expressing measurement uncertainty is shown in the following example:

EXAMPLE: Assume that at 39.51 MHz, the (measured) radiated emissions level was equal to +26.5 dBuV/m, and that the +/- 2 standard deviations (i.e. 95% confidence level) measurement uncertainty was +/- 3.4 dB.

In the example above, the phrase “*k = 2 Coverage Factor*” simply means that the measurement uncertainty is stated to cover +/-2 standard deviations (i.e. a 95% confidence interval) about the measurand. The measurand is the radiated emissions measurement of +26.5 dBuV/m at 39.51 MHz, and the 95% bounds for the uncertainty are -3.4 dB to + 3.4 dB. One can thus be 95% confident that the “true” value of the radiated emissions measurement is between +23.1 dBuV/m and +29.5 dBuV/m. *In effect, this means that in the above example there is only a 2.5% chance that the “true” radiated emissions value exceeds +29.5 dBuV/m.*



<b>Nemko USA, Inc.</b>		11696 Sorrento Valley Road, Suite F, San Diego, CA 92121 Phone (858) 755-5525 Fax (858) 452-1810	
<b>DATE</b>	<b>DOCUMENT NAME</b>	<b>DOCUMENT #</b>	<b>PAGE</b>
May 5, 2006	Kyocera Wireless Corp. K323 FCC Part 22/24 Test Report	2006 040299 K323 Part22/24	25 of 31

## APPENDIX B

### B. Nemko USA, Inc. Test Equipment & Facilities Calibration Program

Nemko USA, Inc. operates a comprehensive Periodic Calibration Program in order to ensure the validity of all test data. Nemko USA's Periodic Calibration Program is fully compliant to the requirements of NVLAP Policy Guide PG-1-1988, ANSI/NCSL Z540-1-1994, ISO 10012: 2003, ISO/IEC 17025:1999, and ISO-9000: 2000. Nemko USA, Inc.'s calibrations program therefore meets or exceeds the US national commercial and military requirements [N.B. ANSI/NCSL Z540-1-1994 replaces MIL-STD-45662A].

Specifically, all of Nemko USA's *primary reference standard devices* (e.g. vector voltmeters, multimeters, attenuators and terminations, RF power meters and their detector heads, oscilloscope mainframes and plug-ins, spectrum analyzers, RF preselectors, quasi-peak adapters, interference analyzers, impulse generators, signal generators and pulse/function generators, field-strength meters and their detector heads, etc.) and certain *secondary standard devices* (e.g. RF Preamplifiers used in CISPR 11/22 and FCC Part 15/18 tests) are periodically recalibrated by:

- A Nemko USA-approved independent (third party) metrology laboratory that uses NIST-traceable standards and that is ISO Guide 25-accredited as a calibration laboratories by NIST; or,
- A Nemko USA-approved independent (third party) metrology laboratory that uses NIST-traceable standards and that is ISO Guide 25-accredited as a calibration laboratory by another accreditation body (such as A2LA) that is mutually recognized by NIST; or,
- A manufacturer of Measurement and Test Equipment (M&TE), if the manufacturer uses NIST-traceable standards and is ISO Guide 25-accredited as calibration laboratory either by NIST or by another accreditation body (such as A2LA) that is mutually recognized by NIST; or
- A manufacturer of M&TE (or by a Nemko USA-approved independent third party metrology laboratory) that is not ISO Guide 25-accredited. (In these cases, Nemko USA conducts an annual audit of the manufacturer or metrology laboratory for the purposes of proving traceability to NIST, ensuring that adequate and repeatable calibration procedures are being applied, and verifying conformity with the other requirements of ISO Guide 25).

<b><i>Nemko USA, Inc.</i></b>		11696 Sorrento Valley Road, Suite F, San Diego, CA 92121 Phone (858) 755-5525 Fax (858) 452-1810	
<b>DATE</b>	<b>DOCUMENT NAME</b>	<b>DOCUMENT #</b>	<b>PAGE</b>
May 5, 2006	Kyocera Wireless Corp. K323 FCC Part 22/24 Test Report	2006 040299 K323 Part22/24	26 of 31

In all cases, the entity performing the Calibration is required to furnish Nemko USA with a calibration test report and/or certificate of calibration, and a “calibration sticker” on each item of M&TE that is successfully calibrated.

Calibration intervals are normally one year, except when the manufacture advises a shorter interval (e.g. the HP 8568B Spectrum Analyzer is recalibrated every six months) or if US Government directives or client requirements demand a shorter interval. Items of instrumentation/related equipment which fail during routine use, or which suffer visible mechanical damage (during use or while in transit), are sidelined pending repair and recalibration. (Repairs are carried out either in-house [if minor] or by a Nemko USA-approved independent [third party] metrology laboratory, or by the manufacturer of the item of M&TE).

Each antenna used for CISPR 11 and CISPR 22 and FCC Part 15 and Part 18 radiated emissions testing (and for testing to the equivalent European Norms) is calibrated annually by either a NIST (or A2LA) ISO Standard 17025-Accredited third-party Antenna Calibration Laboratory or by the antenna’s OEM if the OEM is NIST or A2LA ISO Standard 17025-accredited as an antenna calibration laboratory. The antenna calibrations are performed using the methods specified in Annex G.5 of CISPR 16-1(2003) or ANSI C63.5-2004, including the “Three-Antenna Method”. Certain other kinds of antennas (e.g. magnetic-shielded loop antennas) are calibrated annually by either a NIST (or A2LA) ISO Standard 17025-accredited third-party antenna calibration laboratory, or by the antenna’s OEM if the OEM is NIST or A2LA ISO Standard 17025-accredited as an antenna calibration laboratory using the procedures specified in the latest version of SAE ARP-958.

In accordance with FCC and other regulations, Nemko USA recalibrates its suite of antennas used for radiated emissions tests on an annual basis. These calibrations are performed as a precursor to the FCC-required annual revalidation of the Normalized Site Attenuation properties of Nemko USA’s Open Area Test Site. Nemko USA, Inc. uses the procedures given in both Sub clause 16.6 and Annex G.2 of CISPR 16-1 (2003), and, ANSI C63.4-2004 when performing the normalized site attenuation measurements.

<i>Nemko USA, Inc.</i>		11696 Sorrento Valley Road, Suite F, San Diego, CA 92121 Phone (858) 755-5525 Fax (858) 452-1810	
DATE	DOCUMENT NAME	DOCUMENT #	PAGE
May 5, 2006	Kyocera Wireless Corp. K323 FCC Part 22/24 Test Report	2006 040299 K323 Part22/24	27 of 31

**APPENDIX C**

**C. NVLAP Accreditation / Nemko Authorization**

United States Department of Commerce  
National Institute of Standards and Technology



**Certificate of Accreditation to ISO/IEC 17025:1999**

---

NVLAP LAB CODE: 200116-0

**Nemko USA, Inc. - San Diego EMC Division**  
San Diego, CA

*is recognized by the National Voluntary Laboratory Accreditation Program for conformance with criteria set forth in  
NIST Handbook 150:2001 and all requirements of ISO/IEC 17025:1999.  
Accreditation is granted for specific services, listed on the Scope of Accreditation, for:*

**ELECTROMAGNETIC COMPATIBILITY AND TELECOMMUNICATIONS**

2006-01-01 through 2006-12-31

*Effective dates*



*C. D. Fain*

*For the National Institute of Standards and Technology*

<b>Nemko USA, Inc.</b>		11696 Sorrento Valley Road, Suite F, San Diego, CA 92121 Phone (858) 755-5525 Fax (858) 452-1810	
<b>DATE</b>	<b>DOCUMENT NAME</b>	<b>DOCUMENT #</b>	<b>PAGE</b>
May 5, 2006	Kyocera Wireless Corp. K323 FCC Part 22/24 Test Report	2006 040299 K323 Part22/24	28 of 31

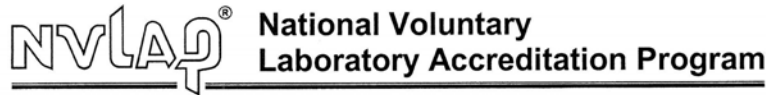

**SCOPE OF ACCREDITATION TO ISO/IEC 17025:1999**

**Nemko USA, Inc. - San Diego EMC Division**  
 11696 Sorrento Valley Road, Suite F  
 San Diego, CA 92121  
 Ms. Rhonda Saxon  
 Phone: 858-755-5525 x226 Fax: 858-793-9914  
 E-Mail: rhonda.saxon@nemko.com  
 URL: http://www.nemko.com

**ELECTROMAGNETIC COMPATIBILITY  
 AND TELECOMMUNICATIONS**

**NVLAP LAB CODE 200116-0**

*NVLAP Code Designation / Description*

**Emissions Test Methods:**

- 12/CIS14 CISPR 14-1 (March 30, 2000): Limits and Methods of Measurement of Radio interference Characteristics of Household Electrical Appliances, Portable Tools and Similiar Electrical Apparatus - Part 1: Emissions
- 12/CIS14a EN 55014-1 (1993), A1 (1997), A2 (1999):
- 12/CIS14b AS/NZS 1044 (1995):
- 12/CIS14c CNS 13783-1: Electromagnetic Compatibility Requirements for household appliances, electric tools and similar apparatus - Part 1: Emissions
- 12/CIS15b CNS 13439 (2000) + A1 (2001): Limits and methods of measurement of radio disturbance characteristics of electrical lighting and similar equipment
- 12/CIS22 IEC/CISPR 22 (1997) & EN 55022 (1998) + A1(2000): Limits and methods of measurement of radio disturbance characteristics of information technology equipment
- 12/CIS22a IEC/CISPR 22 (1993) and EN 55022 (1994): Limits and methods of measurement of radio disturbance characteristics of information technology equipment, Amendment 1 (1995) and Amendment 2 (1996)
- 12/CIS22b CNS 13438 (1997): Limits and Methods of Measurement of Radio Interference Characteristics of Information Technology Equipment

2006-01-01 through 2006-12-31

*Effective dates*

*For the National Institute of Standards and Technology*

<b>Nemko USA, Inc.</b>		11696 Sorrento Valley Road, Suite F, San Diego, CA 92121 Phone (858) 755-5525 Fax (858) 452-1810	
<b>DATE</b>	<b>DOCUMENT NAME</b>	<b>DOCUMENT #</b>	<b>PAGE</b>
May 5, 2006	Kyocera Wireless Corp. K323 FCC Part 22/24 Test Report	2006 040299 K323 Part22/24	29 of 31

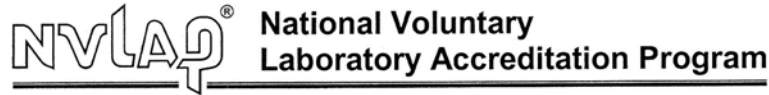

**ELECTROMAGNETIC COMPATIBILITY  
AND TELECOMMUNICATIONS**

**NVLAP LAB CODE 200116-0**

**NVLAP Code Designation / Description**

- 12/EM02a IEC 61000-3-2, Edition 2.1 (2001-10), EN 61000-3-2 (2000), and AS/NZS 2279.1 (2000): Electromagnetic compatibility (EMC) Part 3-2: Limits - Limits for harmonic current emissions (equipment input current <= 16 A)
- 12/EM03b IEC 61000-3-3, Edition 1.1(2002-03) & EN 61000-3-3, A1(2001): EMC - Part 3-3: Limits - Limitations of voltage changes, voltage fluctuations and flicker, in public low-voltage supply-systems, for equipment with rated current <=16 A per phase and not subject to conditional connections
- 12/F18 FCC OST/MP-5 (1986): FCC Methods of Measurement of Radio Noise Emissions for ISM Equipment (cited in FCC Method 47 CFR Part 18 - Industrial, Scientific, and Medical Equipment)
- 12/T51a AS/NZS CISPR 22 (2004): Information technology equipment - Radio disturbance characteristics - Limits and methods of measurement

**Immunity Test Methods:**

- 12/I01 IEC 61000-4-2, Ed. 1.2 (2001) + A1, A2; EN 61000-4-2: Electrostatic Discharge Immunity Test
- 12/I02 IEC 61000-4-3, Ed. 2.0 (2002-03); EN 61000-4-3 (2002): Radiated Radio-Frequency Electromagnetic Field Immunity Test
- 12/I03 IEC 61000-4-4(1995), A1(2000), A2(2001); EN 61000-4-4: Electromagnetic compatibility (EMC) - Part 4-4: Testing and measurement techniques - Electrical Fast Transient/Burst Immunity Test
- 12/I04 IEC 61000-4-5, Ed. 1.1 (2001-04); EN 61000-4-5: Electromagnetic compatibility (EMC) - Part 4-5: Testing and measurement techniques - Surge immunity test
- 12/I05 IEC 61000-4-6, Ed. 2.0 (2003-05); EN 61000-4-6: Electromagnetic compatibility (EMC) - Part 4-6: Testing and measurement techniques - Immunity to conducted disturbances, induced by radio-frequency fields
- 12/I06 IEC 61000-4-8, Ed. 1.1 (2001); EN 61000-4-8: Electromagnetic compatibility (EMC) - Part 4-8: Testing and measurement techniques - Power frequency magnetic field immunity test

2006-01-01 through 2006-12-31

*Effective dates*

*For the National Institute of Standards and Technology*

<i>Nemko USA, Inc.</i>		11696 Sorrento Valley Road, Suite F, San Diego, CA 92121 Phone (858) 755-5525 Fax (858) 452-1810	
DATE	DOCUMENT NAME	DOCUMENT #	PAGE
May 5, 2006	Kyocera Wireless Corp. K323 FCC Part 22/24 Test Report	2006 040299 K323 Part22/24	30 of 31

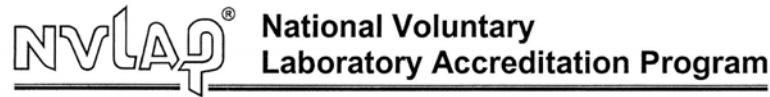

**ELECTROMAGNETIC COMPATIBILITY  
AND TELECOMMUNICATIONS**

**NVLAP LAB CODE 200116-0**

***NVLAP Code    Designation / Description***

12/I07            IEC 61000-4-11, Ed. 1.1 (2001-03); EN 61000-4-11: Voltage Dips, Short Interruptions and Voltage Variations Immunity Tests

**MIL-STD-462 : Conducted Emissions:**

12/A13            MIL-STD-462 Version D Method CE101  
12/A14            MIL-STD-462 Version D Method CE102  
12/A15            MIL-STD-462 Version D Method CE106  
12/A16            MIL-STD-461 Version E Method CE101  
12/A17            MIL-STD-461 Version E Method CE102  
12/A18            MIL-STD-461 Version E Method CE106

**MIL-STD-462 : Conducted Susceptibility:**

12/B12            MIL-STD-462 Version D Method CS101  
12/B13            MIL-STD-462 Version D Method CS103  
12/B14            MIL-STD-462 Version D Method CS104  
12/B15            MIL-STD-462 Version D Method CS105  
12/B16            MIL-STD-462 Version D Method CS109  
12/B17            MIL-STD-462 Version D Method CS114  
12/B18            MIL-STD-462 Version D Method CS115  
12/B19            MIL-STD-462 Version D Method CS116  
12/B20            MIL-STD-461 Version E Method CS101  
12/B21            MIL-STD-461 Version E Method CS103  
12/B22            MIL-STD-461 Version E Method CS104

2006-01-01 through 2006-12-31

*Effective dates*

*For the National Institute of Standards and Technology*

<i>Nemko USA, Inc.</i>		11696 Sorrento Valley Road, Suite F, San Diego, CA 92121 Phone (858) 755-5525 Fax (858) 452-1810	
DATE	DOCUMENT NAME	DOCUMENT #	PAGE
May 5, 2006	Kyocera Wireless Corp. K323 FCC Part 22/24 Test Report	2006 040299 K323 Part22/24	31 of 31

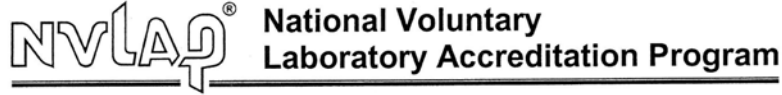

**ELECTROMAGNETIC COMPATIBILITY  
AND TELECOMMUNICATIONS**

NVLAP LAB CODE 200116-0

<i>NVLAP Code</i>	<i>Designation / Description</i>
12/B23	MIL-STD-461 Version E Method CS105
12/B24	MIL-STD-461 Version E Method CS109
12/B25	MIL-STD-461 Version E Method CS114
12/B26	MIL-STD-461 Version E Method CS115
12/B27	MIL-STD-461 Version E Method CS116

**MIL-STD-462 : Radiated Emissions:**

12/D04	MIL-STD-462 Version D Method RE101
12/D05	MIL-STD-462 Version D Method RE102
12/D06	MIL-STD-462 Version D Method RE103
12/D07	MIL-STD-461 Version E Method RE101
12/D08	MIL-STD-461 Version E Method RE102
12/D09	MIL-STD-461 Version E Method RE103

**MIL-STD-462 : Radiated Susceptibility:**

12/E08	MIL-STD-462 Version D Method RS101
12/E09	MIL-STD-462 Version D Method RS103
12/E10	MIL-STD-462 Version D Method RS105
12/E11	MIL-STD-461 Version E Method RS101
12/E12	MIL-STD-461 Version E Method RS103
12/E13	MIL-STD-461 Version E Method RS105

2006-01-01 through 2006-12-31

*Effective dates*

*For the National Institute of Standards and Technology*