



DRAFT

K325

user guide

DRAFT

User Guide for the K325 Phone

This manual is based on the production version of the Kyocera K325 phone. Software changes may have occurred after this printing. Kyocera reserves the right to make changes in technical and product specifications without prior notice. The products and equipment described in this documentation are manufactured under license from QUALCOMM Incorporated under one or more of the following U.S. patents:

4,901,307 5,056,109 5,101,501 5,109,390 5,228,054
5,267,261 5,267,262 5,337,338 5,414,796 5,416,797
5,490,165 5,504,773 5,506,865 5,511,073 5,535,239
5,544,196 5,568,483 5,600,754 5,657,420 5,659,569
5,710,784 5,778,338

The Kyocera Wireless Corp. ("KWC") products described in this manual may include copyrighted KWC and third party software stored in semiconductor memories or other media. Laws in the United States and other countries preserve for KWC and third party software providers certain exclusive rights for copyrighted software, such as the exclusive rights to distribute or reproduce the copyrighted software. Accordingly, any copyrighted software contained in the KWC products may not be modified, reverse engineered, distributed or reproduced in any manner not permitted by law. Furthermore, the purchase of the KWC products shall not be deemed to grant either directly or by implication, estoppel, or otherwise, any license under the copyrights, patents or patent applications of KWC or any third party software provider, except for the normal, non-exclusive royalty-free license to use that arises by operation of law in the sale of a product.

Kyocera is a registered trademark and Strobe is a trademark of Kyocera Corporation. QUALCOMM is a registered trademark of QUALCOMM Incorporated. Openwave is a trademark of Openwave Systems Incorporated. eZiText is a registered trademark of Zi Corporation. TransFlash is a trademark of SanDisk Corporation.

All other trademarks are the property of their respective owners.

Carrier, the Carrier signature, and the Carrier trademark and logo are registered trademarks of Carrier Enterprises Ltd.

AOL is a registered trademark of America Online, Inc. AIM is a registered trademark of America Online, Inc.

Copyright © 2006 Kyocera Wireless Corp.
All rights reserved. Ringer Tones Copyright
© 2000-2002 Kyocera Wireless Corp.

82-G1631-1EN, Rev. X1

FCC Notice

This device complies with part 15 of the FCC rules. Operation is subject to the following two conditions:

(1) This device may not cause harmful interference, and (2) this device must accept any interference received, including interference that may cause undesired operation. To maintain compliance with FCC RF exposure guidelines, if you wear a handset on your body, use Kyocera Wireless Corp. (KWC) supplied and approved accessories.

Other accessories used with this device for body-worn operations must not contain any metallic components and must provide at least 15 mm separation distance including the antenna and the user's body.

THIS MODEL PHONE MEETS THE GOVERNMENT'S REQUIREMENTS FOR EXPOSURE TO RADIO WAVES.

Your wireless phone is a radio transmitter and receiver. It is designed and manufactured not to exceed the emission limits for exposure to radio frequency (RF) energy set by the Federal Communications Commission of the U.S. Government. These limits are part of comprehensive guidelines and establish permitted levels of RF energy for the general population.

The guidelines are based on standards that were developed by independent scientific organizations through periodic and thorough evaluation of scientific studies. The standards include a substantial safety margin designed to assure the safety of all persons, regardless of age and health.

The exposure standard for wireless mobile phones employs a unit of measurement known as the Specific Absorption Rate, or SAR. The SAR limit set by the FCC is 1.6 W/kg.*

Tests for SAR are conducted using standard operating positions specified by the FCC with the phone transmitting at its highest certified power level in all tested frequency bands.

Although the SAR is determined at the highest certified power level, the actual SAR level of the phone while operating can be well below the maximum value.

This is because the phone is designed to operate at multiple power levels so as to use only the power required to reach the network. In general, the closer you are to a wireless base station antenna, the lower the power output.

Before a phone model is available for sale to the public, it must be tested and certified to the FCC that it does not exceed the limit established by the government-adopted requirement for safe exposure. The tests are performed in positions and locations (e.g., at the ear and worn on the body) as required by the FCC for each model.

Body-worn measurements differ among phone models, depending upon availability of accessories and FCC requirements. While there may be differences between the SAR levels of various phones and at various positions, they all meet the government requirement for safe exposure.

The FCC has granted an Equipment Authorization for this model phone with all reported SAR levels evaluated as in compliance with the FCC RF emission guidelines. SAR information on this model phone is on file with the FCC and can be found under the Display Grant section <http://www.fcc.gov/oet/fccid> after searching on the FCC ID: OVFKWC-K24-2J0.

Additional information on SAR can be found on the Cellular Telecommunications and Internet Association (CTIA) web-site at <http://www.wow-com.com>.

* In the United States and Canada, the SAR limit for mobile phones used by the public is 1.6 watts/kg (W/kg) averaged over one gram of tissue. The standard incorporates a substantial margin of safety to give additional protection for the public and to account for any variations in measurements.

Caution

The user is cautioned that changes or modifications not expressly approved by the party responsible for compliance could void the warranty and user's authority to operate the equipment.

Optimize your phone's performance

Use the guidelines on [page 7](#) to learn how to optimize the performance and life of your phone and battery.

Air bags

If your vehicle has an air bag, DO NOT place installed or portable phone equipment or other objects over the air bag or in the air bag deployment area. If equipment is not properly installed, you and your passengers risk serious injury.

Medical devices

Pacemakers—Warning to pacemaker wearers: Wireless phones, when in the ‘on’ position, have been shown to interfere with pacemakers. The phone should be kept at least six (6) inches away from the pacemaker to reduce risk.

The Health Industry Manufacturers Association and the wireless technology research community recommend that you follow these guidelines to minimize the potential for interference.

- Always keep the phone at least six inches (15 centimeters) away from your pacemaker when the phone is turned on.
- Do not carry your phone near your heart.
- Use the ear opposite the pacemaker.
- If you have any reason to suspect that interference is taking place, turn off your phone immediately.

Hearing aids—Some digital wireless phones may interfere with hearing aids. In the event of such interference, you may want to consult Carrier or call the customer service line to discuss alternatives.

Other medical devices—If you use any other personal medical device, consult the manufacturer of the device to determine if it is adequately shielded from external RF energy. Your physician may be able to help you obtain this information.

In health care facilities—Turn your phone off in health care facilities when instructed. Hospitals and health care facilities may be using equipment that is sensitive to external RF energy.

Potentially unsafe areas

Posted facilities—Turn your phone off in any facility when posted notices require you to do so.

Aircraft—FCC regulations prohibit using your phone on a plane that is in the air. Turn your phone off or switch it to Airplane Mode before boarding aircraft.

Vehicles—RF signals may affect improperly installed or inadequately shielded electronic systems in motor vehicles. Check with the manufacturer of the device to determine if it is adequately shielded from external RF energy.

Blasting areas—Turn off your phone where blasting is in progress. Observe restrictions, and follow any regulations or rules.

Potentially explosive atmospheres—Turn off your phone when you are in any area with a potentially explosive atmosphere. Obey all signs and instructions. Sparks in such areas could cause an explosion or fire, resulting in bodily injury or death.

Areas with a potentially explosive atmosphere are often, but not always, clearly marked.

They include:

- fueling areas such as gas stations
- below deck on boats
- transfer or storage facilities for fuel or chemicals
- vehicles using liquefied petroleum gas, such as propane or butane
- areas where the air contains chemicals or particles such as grain, dust, or metal powders
- any other area where you would normally be advised to turn off your vehicle engine

Use with care

Use only in normal position (to ear). Avoid dropping, hitting, bending, or sitting on the phone.

Keep phone dry

If the phone gets wet, turn the power off immediately and contact your dealer. Water damage may not be covered under warranty.

Resetting the phone

If the screen seems frozen and the keypad does not respond to keypresses, reset the phone by completing the following steps:

1. Remove the battery door.
2. Remove and replace the battery.

If the problem persists, return the phone to the dealer for service.

Accessories

Use only Kyocera-approved accessories with Kyocera phones. Use of any unauthorized accessories may be dangerous and will invalidate the phone warranty if said accessories cause damage or a defect to the phone.

Radio Frequency (RF) energy

Your telephone is a radio transmitter and receiver. When it is on, it receives and sends out RF energy. Carrier's network controls the power of the RF signal. This power level can range from 0.006 to 0.6 watts.

In August 1996, the U.S. Federal Communications Commission (FCC) adopted RF exposure guidelines with safety levels for hand-held wireless phones. These guidelines are consistent with the safety standards previously set by both U.S. and international standards bodies in the following reports:

- ANSI C95.1 (American National Standards Institute, 1992)
- NCRP Report 86 (National Council on Radiation Protection and Measurements, 1986)
- ICNIRP (International Commission on Non-Ionizing Radiation Protection, 1996)

Your phone complies with the standards set by these reports and the FCC guidelines.

E911 mandates

Where service is available, this handset complies with the Phase I and Phase II E911 Mandates issued by the FCC.

Hearing-Aid Compatibility (HAC) Features of this Phone

This phone has been certified as receiving an M4 rating for hearing aid-compatibility performance. While there is no guarantee, digital wireless phones that receive a minimum of an M3 rating should provide acceptable performance with most hearing aids. Hearing loss and hearing aids are highly individualized, however, so optimal performance cannot be guaranteed. Other factors, such as type of hearing aid device or degree of hearing loss, also can affect a phone's performance for a particular user.

Hearing Aids and Wireless Phones

A hearing aid uses a microphone to collect and convert sound waves to electrical signals. The hearing aid then amplifies and converts the electrical signals back to audible sounds for the hearing aid user to hear. Radiofrequency (RF) emissions generated by digital wireless phones often interfere with the operation of a hearing aid's microphone, distorting the amplified audible sound. In addition, hearing aid microphones tend to collect ambient noise and amplify these sounds, interfering with the desired audio transmission.

ANSI Standard

To diminish interference between wireless phones and hearing aids, the FCC requires wireless carriers to offer phones that meet the American National Standards Institute (ANSI) C63.19 standard for reduced RF emissions. Wireless phones that comply with the FCC's hearing aid-compatibility (HAC) regulations must receive a minimum rating of "M3" for RF emissions under the ANSI C63.19 standard. The "M" rating refers to the phone's RF emissions level for use with hearing aids operating in the microphone setting. The higher the phone's "M" rating, the more

likely the phone is compatible with a hearing aid operating in the microphone setting. Hearing aids also have ratings similar to wireless phones. Most newer hearing aid models receive at least an M2 rating.

To determine the level of compatibility between your hearing aid and this carrier HAC-certified phone, combine the M rating of your hearing aid and the M4 rating of this phone. For example, if you pair an M3 hearing aid with this M4 phone, you will achieve a combined rating of seven.

- Any combined rating equal to or greater than 6 provides excellent performance.
- Any combined rating equal to 5 offers good performance.

Any combined rating equal to 4 offers acceptable performance.

Battery and charger specifications

| Charger | Input | Output |
|---------------------------|-------------------------|--------------|
| CV90-G2968-01 | 120VAC 60Hz 7W | 5.2VDC 400mA |
| CV90-G2588-01 | 100-240VAC 50/60Hz 0.2A | 4.2VDC 0.6A |
| CV90-G2589-01 | 100-240VAC 50/60Hz 0.3A | 4.5VDC 1.2A |
| Standard Battery: | | |
| CV90-P3031-01 3.7V 900mAh | | |
| Extended Battery: | | |
| CV90-P3032-03 1800mAh | | |

Kyocera Wireless Corp.
 10300 Campus Point Drive, San Diego, CA 92121
 U.S.A.
 Visit us at www.kyocera-wireless.com

CONTENTS

| | | | | | |
|-----------|--|-----------|-----------|---|-----------|
| 1 | Getting Started | 1 | 11 | Customizing Your Phone | 39 |
| | Finding your phone's serial number | 1 | | Silencing all sounds | 39 |
| | Activating your Carrier account | 2 | | Setting ringtones | 40 |
| | Getting to know your phone | 3 | | Setting sounds for your phone | 40 |
| 2 | My Account | 9 | | Personalizing the screen | 42 |
| | Checking your account balance | 9 | | Creating a secure environment | 44 |
| | Top-Up your account | 9 | | Connecting to a TTY/TDD device | 45 |
| 3 | Making and Answering Calls | 11 | | Setting position location | 45 |
| | Phone calls | 11 | 12 | Using Voice Recognition | 46 |
| | Recent calls | 12 | | Setting up voice dialing | 46 |
| | Speed dialing | 13 | | Making a call using voice tags | 46 |
| | 1-Touch dialing | 14 | | Making a call using digit dialing | 47 |
| | Voicemail | 14 | | Training voice recognition | 48 |
| 4 | Entering Text | 16 | 13 | Using the Camera | 49 |
| 5 | Storing Contacts | 20 | | Accessing picture mode | 49 |
| | Creating a new contact | 20 | | Taking a picture | 51 |
| | Customizing your contacts | 20 | 14 | Using Tools | 52 |
| | Finding contact information | 23 | | Voice memo | 52 |
| 6 | Text Messaging | 25 | | Scheduler | 52 |
| | Sending text messages | 25 | | Alarm clock | 53 |
| | Receiving text messages | 28 | | Tip calculator | 54 |
| | Customizing message settings | 30 | | Calculator | 54 |
| 7 | Multimedia Messaging | 31 | | Timer | 55 |
| | Sending multimedia messages | 31 | | Stopwatch | 55 |
| | Receiving multimedia messages | 33 | 15 | Getting Help | 56 |
| 8 | AIM® | 35 | 16 | Consumer Limited Warranty | 57 |
| 9 | CarrierXL | 36 | | Index | 59 |
| 10 | My stuff | 37 | | | |
| | My ringtones | 37 | | | |
| | My games | 37 | | | |
| | My other stuff | 37 | | | |
| | My graphics | 38 | | | |
| | My sounds | 38 | | | |

1 GETTING STARTED

Finding your phone's serial number

To activate your Carrier account, you need your phone's serial number. To locate the number:

1. Turn your phone off.
2. Hold your phone face down in your hand.
3. Place your thumb on the ribs at the top of the battery door and slide the battery door downward to remove it.
4. Remove the battery by pulling back tab at the top edge of the battery.
5. Your phone's serial number (the ESN) is located just below the first barcode inside the phone, next to the letter "D." It is an 11-digit number.
6. Write down the ESN.

Installing the battery

Your K325 phone comes with a removable lithium ion (LiIon) battery. Fully charge the battery before using the phone.

To install the battery:

1. Hold the phone face down.
1. Place your thumb on the ribs at the top of the

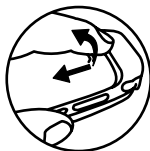

battery door and slide the battery door downward to remove it

2. Place the battery in the phone casing with the metal contacts facing towards the bottom end of the phone.



3. Replace the battery door by sliding the notches into the openings at the bottom and outside edges of the battery casing.

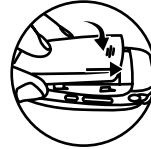

4. Slide the door up to secure the cover into place.

Charging the battery

You must have at least a partial charge in the battery to make or receive calls.

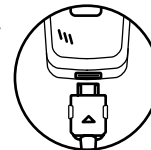

To charge the battery:

1. Connect the AC adapter to the jack on the bottom of the phone. Do not force the AC adapter into the jack. Make sure the arrow is face up as shown.



2. Plug the adapter into a wall outlet.

The battery icon in the upper right corner of the screen tells you whether the phone is:

- Charging (the icon is animated)
- Partially charged 
- Fully charged 

Note: The battery will not charge if you use the phone while it is connected to an AC adapter.

Note: You must use a Kyocera-authenticated battery in your phone. If you attempt to use a battery that has not been authenticated you will receive a security warning. Contact Carrier to obtain a Kyocera-authenticated battery.

Activating your Carrier account







Before you can start talking, messaging, or downloading, you need to activate service with Carrier.

You need your phone's serial number (ESN) to activate your Carrier Mobile account. See ["Finding your phone's serial number" on page 1](#).

Activate your account online by going to www.xxxxx.com and clicking on Activate. Or call your Carrier At Your Service at 1-xxx-xxx-xxx.

Programming your phone

Once your account is activated, you will receive MDN and MSID/Network ID numbers. These are used to program your phone. When you are ready, follow these steps to program your phone:

1. Turn on your phone. Program your phone using the external number keypad.
2. Using the external number keypad, dial ##xxxxx(##xxxxx). Press  to select Service.
3. Highlight Edit and press .
4. The prompt "Edit MDN - enter 10 digits..." is displayed. If any numbers appear on this screen, press  to clear the screen.
5. Enter the 10-digit MDN number.
6. Press  to select .
7. The prompt "Edit MSID - enter 10 digits..." is displayed. If any numbers appear on this screen, press  to clear the screen.
8. Enter the 10-digit MSID/Network ID number. Drop any zeros at the beginning and enter only the last 10-digits.
9. Press  to select Done.
10. A message saying your programming is complete is displayed. The phone turns off and then on by itself.

That's it - you are done! Nice work. It might take a couple of hours to get you set up on our network, but we will send a text message to your phone to let you know you can start talking. Also, it may take up to 4 hours for xxxxx, voicemail, and Top-Up features to come online.

Getting to know your phone

Keypad

The phone is shown here in open position. When the phone is closed, the keys are locked to prevent accidental key presses.

- ① Home screen.
- ② Speakerphone key activates the speakerphone and answers incoming calls.
- ③ Left softkey accesses menus and functions.
- ④ Send/Talk key starts or answers a call. Press once to activate voice dialing, twice to display the Recent Calls list, and three times to redial the last number dialed.
- ⑤ Keypad for entering numbers, letters, or symbols.
- ⑥ *Shift key changes the text mode in text entry.
- ⑦ 0/Next key cycles through word choices during text entry.
- ⑧ Right softkey accesses the Contacts directory and other menu options.
- ⑨ Navigation key scrolls through lists and text entry fields and accesses shortcuts from the home screen.
- ⑩ OK key selects a menu item or option.
- ⑪ End/Power key turns the phone on and off, ends a call or browser session, and returns you to the home screen.

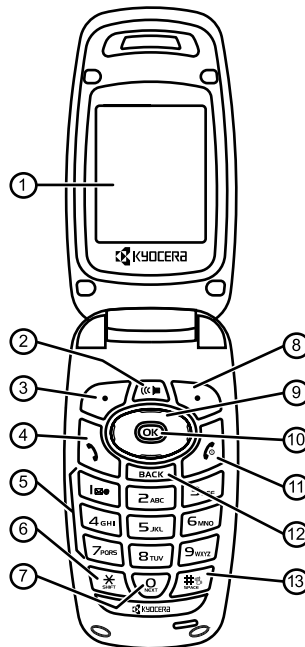



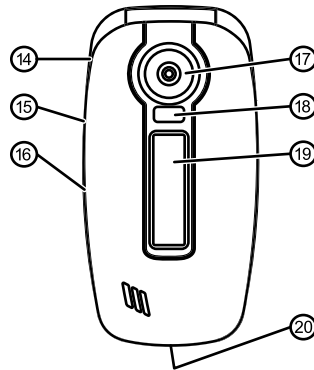





















- ⑫ BACK key erases characters in text entry and returns you to the previous screen.
- ⑬ Space/# key enters a space during text entry. Press and hold to activate or deactivate Silent mode.
- ⑭ ⚠ Jack for Hands-free Headset only (sold separately).
- ⑮ Volume key to raise or lower ringtone volume.
- ⑯ Camera key activates Camera mode. To activate Camera mode, press and hold until you hear two beeps.
- ⑰ Camera lens.
- ⑱ Camera Flash/Message Indicator Light light flashes when taking a picture or lights when you have a message or missed call.
- ⑲ External screen displays time, caller ID, signal and battery strength.
- ⑳ ⚠ Jack for AC adapter (included) and data cable (sold separately).
- ⚠ Warning: Inserting an accessory into the incorrect jack will damage the phone.



Understanding screen icons

These icons may appear on your phone's screen.

- | | | | |
|---|---|---|--|
|  | The phone is operating in IS95 digital mode. |  | New photo, voice and text message. |
|  | The phone is receiving a signal. You can make and receive calls. Fewer bars indicate a weaker signal. |  | The battery is fully charged. The more black bars, the greater the charge. |
|  | A call is in progress. |  | The phone is set to vibrate or to vibrate and then ring. |
|  | The phone is not receiving a signal. You cannot make or receive calls. |  | Speaker phone |
|  | High-speed data service is available and active on your phone. |  | Auto Answer |
|  | (blinking) The phone is sending high-speed data. |  | Position location is sent to Carrier and to emergency services. |
|  | (blinking) The phone is receiving high-speed data. |  | Position location is set to emergency services only. |
|  | High-speed data service is available, but the phone is dormant. |  | The phone is in picture mode. |
|  | The alarm clock is set. |  | Camera flash mode is ready. |
|  | The phone is in privacy mode or is accessing a secure Web site. | | |
|  | You have a text or multimedia message. | | |
|  | You have a voicemail. | | |
|  | New voice and text message. | | |
|  | New photo message. | | |
|  | New photo and voice message. | | |
|  | New photo and text message. | | |

















Navigation key shortcuts

From the main screen, press and hold  to access the following shortcuts:

- Up: Access My Account
- Down: Access Recent calls lists
- Left: Launch xxxXL
- Right: Access text messaging

Performing basic functions

Note: The phone must be powered ON to perform the following functions.







| To... | From the external screen... |
|--|--|
| Turn the phone on | Press  and wait until the phone beeps. |
| Turn the phone off | Press and hold  until the phone beeps. |
| Make a call | Enter the number and press  . |
| End a call | Press  . |
| Answer a call | Press  . |
| Adjust volume during a call | Press side volume keys  up or down. |
| Acknowledge an alert | Press  when you see OK. |
| Access menus | Press the left softkey  once. |
| Scroll menus | Press  up or down. |
| Select menus | Highlight a menu or option and press  once. |
| Access Recent calls list | Press  down. |
| Activate Picture mode | Press and hold the camera key. |
| Take a picture | Press and hold the side camera key  . Focus on the image and select Capture to take a picture. |
| Access voicemail | Press and hold  . Follow the system prompts. |
| Verify your phone number | Select Menu → Settings → Phone Info → Build info. |
| Silence the ringtone on an incoming call | Press  then  to answer. |
| Activate voice dialing | Press and hold  to initiate voice dialing. Contact must have voice tag assigned (see page 46). |

Using menus

The contents of the main menu are as follows:

| | | | | |
|-------------------|-----------------------|------------------|--------------------|--------------|
| Messaging | My Account | Pictures | Recent calls | Settings |
| Send text msg | Allows you to view | Take a picture | All calls | Sounds |
| Inbox | your balance and | My pictures | Incoming calls | Display |
| Send IM | Top-Up your account. | Send picture msg | Outgoing calls | Convenience |
| Send Email | CarrierXL | Help | Missed calls | Call options |
| Send picture msg | Launches CarrierXL | Contacts | Erase call lists | Messaging |
| Squawker | and provides access | View all | Recent Calls Timer | Camera |
| Voicemail | to exclusive content. | Add new | All calls timer | Security |
| Carrier Alerts | My stuff | Find name | Tools | Network |
| Outbox | My ringtones | Groups | Voice memo | Accessories |
| Saved | My games | Speed dial list | Scheduler | Game Keypad |
| Drafts | My other stuff | Voice dial list | Alarm clock | Phone info |
| Msg settings | My graphics | My Phone # | Tip calculator | |
| Erase msgs | My sounds | Information | Calculator | |
| IM | | | Timer | |
| Launches the AOL® | | | Stopwatch | |
| Instant | | | | |
| Messenger™. | | | | |

Accessing menu items

- From the main screen, press  to select Menu.
- Press  to select Contacts.
- Press  left, right, up, or down to see menus and options.
- Press  to select a menu item.
- Press  to back up a menu level.
- Press  to return to the main screen.

In this guide, an arrow → tells you to select an option from a menu.

For example, Menu → Settings means select Menu, then select the Settings option.

Note: To change the way the menus appear, see “Choosing a menu style” on page 42 for details.

Caring for the battery

Recharging the battery

You can safely recharge the battery at any time, even if it has a partial charge.

Note: Before removing the battery, make sure the phone is powered off.

General safety guidelines

- Do not take apart, puncture, or short-circuit the battery.
- If you have not used the battery for more than a month, recharge it before using your phone.
- Avoid exposing the battery to extreme temperatures, direct sunlight, or high humidity.
- Never dispose of any battery in or near a fire. It could explode.

Common causes of battery drain

- Playing games or using the Web.
- Keeping backlighting on.
- Operating in digital mode when far away from a base station or cell site.
- Using data cables or accessories.
- Operating when service is unavailable, or service is available intermittently.
- High earpiece and ringtone volume settings.
- Repeating sound, vibration, or light alerts.

Purchasing accessories

To purchase accessories for your new phone, such as a hands-free headset, carrying case, or car power adapter, please visit www.xxxxxxxx.com.

2 MY ACCOUNT

You can manage your Carrier account directly from your phone. The basic tasks are summarized in this chapter. For more information about your account, go to www.xxxxxxxxx.com.

Checking your account balance

You can check your Carrier account status in one of two ways



(additional charges may apply):

- From the main screen, press  up.
 - or -
 - Select Menu → My Account.
 - Your current account information is sent to your phone and appears on your screen.
 - When your account is low or empty, you receive a notification to Top-Up.







Top-Up your account

Top-Up is how you increase your Carrier account balance. You can Top-Up your Carrier account right from your phone. First, buy a Top-Up card at the thousands of retailers that carry them, or register your debit card, credit card, or Paypal account at www.xxxxx.com.

When your balance is low, you can Top-Up your account from your phone as follows:







1. Select Menu → My Account.
2. Use the navigation key  to scroll down to the Top-Up link and press .
3. Scroll down and select either Top-Up Card, Credit Card, or Pay-Pal.

Top-Up with a Top-Up card

1. Enter your vKey and press .
2. Scroll down to select Login and press .
3. Enter your Top-Up card's PIN number and press .
4. Scroll down to select Top-Up Now and press .
5. At the confirmation screen, select Yes by pressing .
6. At the Approved screen, press .
7. Press  to exit. You're topped up!

Top Up with a Debit Card, Credit Card, or Pay Pal account

Before you can Top Up from your phone with a debit card, credit card, or Paypal account, you need to register the credit/debit card or Paypal account at www.xxxxxxx.com or by calling Carrier At Your Service at 1-888-322-xxxx.

1. Enter your vKey and press .
2. Scroll down to select Login and press .
3. Enter the amount you want to Top-Up and press . You can Top-Up in amounts of \$20, \$30, \$50, or \$90.
4. Scroll down to select Top-Up Now and press .
5. Your phone validates the amount you want to Top-Up. Scroll down to select Yes and press .
6. That's it. Your phone announces that You're Topped-Up! Press .
7. Press  to exit to exit.

To find a store near you that sells Top-Up cards, select Find a Store from the Top-Up menu.

Note: You can also Top-Up over the Web at www.xxxxxxx.com.

For more information

To learn more about your Carrier account and Carrier's service options, visit www.xxxxxxx.com.



3 MAKING AND ANSWERING CALLS

Phone calls

Making a call



Make sure you are in an area where a signal can be received. Look for the  symbol on the main screen. The more bars you see in this symbol, the stronger the signal. If there are no bars, move to where the signal strength is better. When the phone has been idle for a time, it changes to power save mode. When you see your phone's screen dim, press any key to return to normal operating mode.

Entering a number

1. Enter the phone number and press .
2. Press  to end the call.

Using voice dialing



Voice dialing requires that a contact be saved with a voice tag. See [page 46](#).

1. Press  to initiate voice dialing.
2. Say the name of the contact when prompted. The phone places the call.
3. Press  to end the call.

Answering a call

When a call comes in, the phone rings, vibrates, or lights up, and an animated icon appears. The phone number of the caller also appears if it

is not restricted. If the number is stored in your Contacts directory, the contact name appears.

- Press  to answer the incoming call.
- or -
- Press  to answer the incoming call and turn on the speakerphone.

Adjusting the volume during a call



- To adjust the earpiece volume during a call, press the side volume key  up or down.

Silencing an incoming call

- Press  or  to select Silence.



Note: In the absence of voicemail, this feature drops the call.

- or -

- Press  then press  to answer the call.

This action silences the current call only. The next call rings as normal.



Redialing a number

- To redial a recent call, press  twice to open your Recent calls list. Highlight a phone number or name and press .

Tip: To redial the last number called, received, or missed, press  three times.



Calling a saved number

If you have already saved a phone number, you can use the Contacts list to find it quickly.

1. From the main screen, press  to select Contacts.
2. Scroll down the list to find the contact you want to call.
3. Highlight the name and press  to dial the number.

Using the speakerphone

Your K325 phone has a built-in speakerphone.

- To turn on the speakerphone, press . If you press  during an incoming call alert, you answer the call.

The  icon at the top of the phone screen indicates that the speakerphone is on.

- To turn off the speakerphone, press .

Setting the phone to hold calls

The Hold Call feature allows you to place incoming calls on hold until you are ready to answer them.

1. Select Menu → Settings → Convenience → Hold call → Enabled.
 - If you have not recorded a hold message, you are prompted to record one, such as “Please hold. I’ll answer in a minute.”
2. Record the message twice, as prompted.
3. Select Save or Options (Play, Re-Record, or Exit).

The next time a call comes in, you have the option of placing it on hold.

Placing a call on hold

You can place a call on hold once you have enabled this feature.

Note: If you are already on a call and you receive another call, you cannot place the incoming call on hold. It goes to voicemail.

1. When a call comes in, press  to select Options → Hold call. The caller is placed on hold and hears your recorded hold message.
2. To speak to the caller, select Answer.

- or -

To hang up without speaking to the caller, select End Call.

Changing the hold message





1. Select Menu → Settings → Convenience → Hold call → Re-Record msg and follow the prompts.
2. Record the message twice.
3. Select Save or Options (Play, Re-Record, or Exit).

Recent calls

Dealing with missed calls

When you have missed a call, “Missed Call” appears on your screen unless the caller leaves a voicemail.

- To clear the screen, press  to select OK.

- To return the call, press  to select Calls then press .
- To view details of the call, press  to select Calls then press  to select Details.

Setting missed call alerts

You can set an alert to beep every five minutes after you have missed a call.

1. Select Menu → Settings → Sounds → Alerts → Missed call alert.
2. Select an option and press .

Viewing recent call details

Details on the last 60 calls you made, received, or missed are stored in the Recent calls list and are identified by the following icons:

 Outgoing call  Incoming call

 Missed call



Viewing recent calls

1. Select Menu → Recent calls.
2. Select either All calls, Incoming calls, Outgoing calls, or Missed calls.
3. Select a recent call item and press  to select Options:
 - Save adds the phone number to the Contacts list.
 - Send text msg sends a text message to the contact.

- Send picture msg sends a picture message to the contact.
- Erase record erases the selected call record.

Note: If the phone number is classified as “secret,” you must enter your four-digit lock code to view or edit it. For information on the lock code, see [“Changing your lock code” on page 44](#). To classify a phone number as secret, see [“Customizing your contacts” on page 20](#).

Calling recent calls

1. Press  down or select Menu → Recent Calls.
2. Select an option and press .
3. Highlight the number you want to call and press .

Erasing recent calls

1. Select Menu → Recent calls → Erase call lists.
2. Select either All calls, Incoming calls, Outgoing calls, or Missed calls.
3. Press  to select Yes.

Speed dialing

Before you can use speed dialing, you must save a phone number as a contact and assign a speed dial location to it.

- To add a speed dial location to a saved or new contact, see “Customizing a phone number” on page 22.

To call a contact that has a speed dial location:

- From the main screen, enter the one- or two-digit speed dialing location and press .

1-Touch dialing

1-Touch dialing is the fastest way to speed dial a contact that has a speed dial location.



Note: You must (1) enable 1-Touch dialing on your phone and (2) have a speed dial location assigned to a contact. See “1-Touch dialing” on this page.

Enabling 1-Touch dialing

- Select Menu → Settings → Convenience → 1-Touch dialing → Enabled.

Using 1-Touch dialing

To call a contact that has a speed dial location:

- From the main screen, press and hold the speed dialing number. If it is a two-digit number, press the first digit briefly, then press and hold the second digit. For example, if the speed dialing location is 15, press  briefly, then press and hold .

Voicemail

Setting up voicemail

Before your phone can receive voicemail messages, you must set up a 4-10 digit passcode and record a personal voicemail greeting. When you have set up your voicemail, all unanswered calls to your phone are automatically transferred to voicemail, even if your phone is in use or turned off.



1. From the main screen, press and hold  to dial into your voicemail.
2. Follow the system prompts to record a greeting and complete the system setup.

Note: If you are having trouble accessing your voicemail, contact Carrier.

Checking voicemail messages

When a voice message is received, your screen displays “New Messages” along with the  symbol at the top of your screen. Standard airtime charges apply.

If you see “New Messages”

1. Press  to select Call, which initiates a call to your voicemail number.
 2. Follow the prompts to retrieve the message.
- To clear the screen without checking messages:
- Press  to select Ignore.

If you see only the  symbol

1. Press and hold  to initiate a call to your voicemail number.
 2. Follow the prompts to retrieve the message.
- You can set the phone to beep or vibrate every five minutes to remind you that you have voicemail. See “[Setting sound alerts](#)” on [page 41](#).

Emergency services



Note: Regardless of your 3-digit emergency code (911, 111, 999, 000, etc.), your phone operates as described below.

- Dial your 3-digit emergency code and press .

You can call the code even if your phone is locked or your account is restricted. When you call, your phone enters Emergency mode. This enables the emergency service exclusive access to your phone to call you back, if necessary. To make or receive regular calls after dialing the code, you must exit this mode.

Exiting Emergency mode

When you have completed the emergency call:

1. Press  to select Exit.
2. Press  again to confirm your choice.

Note: To determine who has access to your location, see “[Setting position location](#)” on [page 45](#).

Tracking calls

You can track the number and duration of calls made and received on your phone.

- Select Menu → Recent calls → All calls timer.
- This timer cannot be reset.

Timing your calls

You can set your phone to beep 10 seconds before each minute passes when you are on a call.

- Select Menu → Settings → Sounds → Minute alert → Enabled.

4 ENTERING TEXT

You can enter letters, numbers, and symbols in contacts, text messages, and your banner.

Understanding screen

The current entry mode (and capitalization setting, when applicable) are indicated by icons.

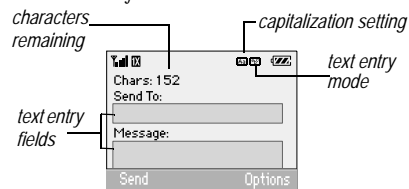

Text entry modes

There are six text entry modes:

| | | | |
|------|--------------|-----|-------------|
| A>a | Case change | eZi | Rapid Entry |
| 123 | Numbers only | &?! | Add Symbol |
| a_bC | Normal alpha | ☺ | Add Smiley |

Note: The mode you start in depends on the task you are doing. For example, when entering a phone number, you're in number mode. When entering a name for a contact, you're in normal text mode. See [“Changing modes” on page 17](#).

123 Entering numbers

- To enter a number while in 123 mode, press a number key once.
- To enter a number while in a_bC or eZi mode, press and hold a number key until the number appears on the screen.

a_bC Entering words letter by letter

- Press a key once for the first letter, twice for the second letter, and so on.
- Wait for the cursor to move right and enter the next letter.

Note: To enter a space, press .

eZi Entering words quickly

When you press a series of keys using eZi mode, eZi checks its dictionary of common words and guesses at the word you are trying to spell.

- For each letter of the word you want, press the key once. For example, to enter the word “any” press → → .
- If the word doesn't match what you want, press to look at other word matches.
- When you see the word you want, press .

&?! Entering symbols



While entering text in **aBc** mode, you can enter symbols by pressing  until you see the symbol you want. Using this method, you have access to the following symbols:

. @ ? ! - , & : ' 1

To access the full set of symbols:

1. From the text entry screen, select **Options**.
2. Select **&?! Add Symbol**.
3. Press  down to view the list of symbols.
4. Press the number key corresponding to the symbol you want.

Entering smileys

1. From the text entry screen, select **Options**.
2. Select  **Add Smiley**.
3. Press  down to view the list of smileys.
4. Press the number key corresponding to the smiley you want.

Switching default text entry modes

You can change the default text entry mode when creating a text message. This setting applies only to the message body screen, not the "To" screen.

1. Select **Menu** → **Messaging** → **Msg settings** → **Text entry**.
2. Select **Normal alpha** or **Rapid mode**.

Changing modes

Sometimes you need to change modes. For example, to enter numbers in an email address while in **aBc** mode, you must change to **123** mode, enter the numbers, and then change back to **aBc** mode to complete the address.

To change text entry modes:













- Press and hold  until the icon for the mode you want appears.
- or -
- Select **Options** and then select a different mode.

Capitalization settings

You can change capitalization at any time while entering text. Simply press  to choose upper or lower case while in **aBc Normal alpha** mode.

Quick reference to text entry





This table gives general instructions for entering letters, numbers, and symbols.

| For keypad | |
|-----------------------------------|--|
| To... | Do this... |
| Enter a letter | Use a _b c mode and press a key, see “Text entry modes” on page 16 . |
| Enter a number | Use 1 ₂₃ mode and press a key. For more options, see “Text entry modes” on page 16 . |
| Enter a symbol | Use &?! mode and press a key. For more options, see “Text entry modes” on page 16 . |
| Enter a smiley | Use 😄 mode and press a key once to enter its number. For more options, see “Text entry modes” on page 16 . |
| Enter a space | Press  . |
| Erase a character | Press  . |
| Erase all characters | Press and hold  . |
| Move the cursor right or left | Press  right or left. |
| Move the cursor up or down | Press  up or down. |
| Change text entry modes | Press and hold  . |
| Capitalize any letter | In a _b c mode, press  . Choose A. |
| Lowercase any letter | In a _b c mode, press  . Choose a. |
| Change to Initial Caps | In a _b c mode, press  . Choose  . |
| Select soft options on the screen | Press  or  . |

5 STORING CONTACTS





Use your phone's Contacts directory to store information about a person or company. Each contact entry can have up to six phone numbers, two email addresses, two Web addresses, two street addresses, and a space for notes.

Creating a new contact

1. From the main screen, enter the phone number you want to save, including the area code.
2. Press  to select Save.
3. Press  to select Save new contact.
4. Enter a name for the contact.
 - If you need to learn how to enter letters, see [page 16](#).
 - To add a symbol or smiley to the contact name, or to change the text entry mode, press  to select Options.
5. Either save now or add more contact information.
 - To save now, press  to select Save.
 - To enter additional phone numbers, email and Web addresses, or notes, press  down repeatedly. For help switching between numbers and letters for email or Web addresses, see [“Changing modes” on page 17](#).

Adding a code or extension



When you save the phone number of an automated service, you may include a pause to stop dialing, for example, where you would wait to dial an extension.

1. From the main screen, enter the phone number.
2. Press  to select Options.
3. Select a type of pause:
 -  Time pause causes the phone to stop dialing for two seconds.
 -  Hard pause causes the phone to stop dialing until you select Options → Release while making the call.
4. Enter the remaining numbers.
5. Press  to select Save.

Customizing your contacts

You can customize each contact in your Contacts directory by assigning ringtones, pictures, and number types, or by classifying your contacts as Personal or Business.

Assigning ringtones

1. Press  to select Contacts.
2. Highlight a contact and press .

3. Highlight the contact name and press to select Options.
4. Select Ringer → Assign ringer.
5. Scroll down the list to hear the different ringtones or press to assign a ringer from your Saved Sounds folder.
6. Press to assign the selected ringer.

Assigning pictures

1. Press to select Contacts.
2. Highlight a contact and press .
3. Highlight the contact name and press to select Options.
4. Select Picture → Assign picture → My pictures.
Tip: To take a new picture, select Picture → Assign picture → Take picture now.
5. Scroll through the list to view your pictures and press to assign it to your contact.

Assigning number types

When you assign a number type, an icon is placed in front of a contact number to specify the type of number, such as work, home, or mobile.

1. Press to select Contacts.
2. Highlight a contact and press .
3. Highlight a contact number and press the to select Edit.
4. Press down once and press .

5. Highlight an option to designate the number as General, Work, Home, Mobile, Pager, or Fax and press . The associated icon appears next to the number in your Contacts directory and Recent calls list.

| | |
|---------|----------------|
| general | email address |
| work | street address |
| home | Web page URL |
| mobile | note |
| pager | |
| fax | |

6. Press to select Save.





Editing a contact

1. Press to select Contacts.
2. Highlight a contact and press .
3. Highlight the contact name or number and press to select Edit.
4. Enter your changes and press to select Save.

Erasing a contact

1. Press to select Contacts.
2. Highlight the contact to erase and press .
3. Press to select Options.
4. Highlight Erase contact and press .
5. Press to confirm.

Customizing a phone number





1. Press  to select Contacts.
2. Highlight the contact to edit and press .
3. Press  down to highlight the phone number.
4. Press  to select Options.
5. Highlight an option and press :
 - Call to call the contact.
 - Send text msg brings you to the text messaging screen.
 - Send picture msg brings you to the picture messaging screen.
 - Add speed dial assigns or removes the speed dial location.
 - View number to see the selected phone number.
 - Erase number erases the number from the contact.
 - Secret makes the number secret so that it does not appear on the screen until the lock code is entered. Secret numbers can be called without a lock code. (For more information, see “Erasing all contacts” on page 45.)
 - Primary number makes this number the first one that shows up when you open the contact.
 - Add to Group... adds the number to a group. For more information, see page 46.

- Add voice dial to record a voice tag so you can call a contact using voice recognition (VR). For more information, see page 46.
 - Erase voice dial erases the voice tag associated with the number.
 - Edit voice dial records a new voice tag.
6. Enter the new information and follow the prompts.
 7. Select Save, if necessary.

Using groups

You can create and save a list of multiple recipients. Your K325 phone stores five group lists with up to 10 recipients per list.

Creating Groups

1. Select Menu → Contacts → Groups.
2. Press  to select New.
3. Enter a name for the group. For help entering text, see page 19.
4. Press  to select Next.
5. Highlight a contact and press  to select Add to check the box. Repeat for each contact you wish to add.
6. Press  to select Done.

Customizing a group

1. Select Menu → Contacts → Groups.
2. Highlight the group name and press  to select Options.

3. Highlight an option and press :
 - View to see the contact in the group.
 - Edit to change the name of the group and to add and remove contacts.
 - Erase erases the group.
 - Send text msg brings you to the text messaging screen.
 - Send picture msg brings you to the picture messaging screen.
4. Enter the new information and follow the prompts.
5. Select Save, if necessary.

Finding contact information

To find a phone number or contact, you can (1) check the Frequent list, (2) search the Contacts directory, or (3) use Fast Find.

Checking the Frequent list

From the main screen, press  select Contacts. The last 15 of your most frequently called contacts appear when the Frequent list is enabled. Scroll past the double line to view the All Contacts list.

To enable the Frequent list setting

- Select Menu → Settings → Convenience → Frequent list → Enabled.

Searching the Contacts directory

1. Press  to select Contacts for a list of all contacts. To quickly go through the list, enter

the first letter of the contact. The menu skips to that letter of the alphabet.

- or -

Select Menu → Contacts.

2. Select a search method:

- View all lists all saved contacts.
- Find name locates a specific name. Enter part of the contact name then select Find.
- Speed dial list or Voice dial list selects a contact from the specified list.

3. Highlight a contact and press .

- To call the contact, highlight the number and press .

Setting Fast find

With Fast find, you press one or two number keys to view close matches of the number you are looking for.

To enable the Fast find setting

- Select Menu → Settings → Convenience → Fast find → Enabled.

Using Fast find

1. From the main screen, press the number keys corresponding to the letters of the name you want to find. A matching contact or speed dial entry appears.
2. Press  down to scroll through matching entries.

3. Highlight the name you want then press  to call the number.

6 TEXT MESSAGING

This chapter describes how to send, receive, and erase text messages from your phone. For information on voicemail messages, see [“Voicemail” on page 14](#).

Important: The features and menus described in this chapter may vary depending on services available in your area. Check with Carrier for details and pricing.

Sending text messages

You can send text messages to phones that are capable of receiving them or to email addresses. Charges apply. See [www.xxxx.com](#) for pricing.

Creating a text message

1. Select Menu → Messaging → Send text msg.

Tip: Press  right to access a shortcut to the text message screen.

2. Enter a recipient's phone number or email address manually

- or -

Press  to select Options and then select Recent list or Contacts.

Select a contact and press .

Highlight the number field and press .



For more about group lists, see [“Creating and editing prewritten messages \(auto text\)” on page 30](#).

To learn how to enter symbols, see [“Entering symbols” on page 17](#).

To add multiple recipients:

- Enter a space after the first number then enter another recipient.

- or -

- Press  to select Options then select Recent list, Contacts, or Groups. Highlight a contact and press .

Note: You can send a message to a maximum of 10 recipients. The messages are sent one at a time, once to each recipient. Standard text messaging charges apply for each recipient.

3. When you are done entering addresses, press  twice.

4. Enter the message



- or -

Add auto text, symbols, or smiley's in your message. See [“Including prewritten text and symbols” on page 26](#) for information.

5. Press  to select Send. See [“Setting sending options” on page 26](#) for information about how and when you want the message to be received.

Including prewritten text and symbols

During text entry, you can insert auto text, symbols, or smiley's in your message.



1. From the text entry screen, select Options.
2. Select an option and press 
 - Insert auto text to scroll through the list of options and press  to select one.
 - Add symbol to scroll through the list and press the corresponding number key or letter key to select it.
 - Add smiley to scroll through the list and press the corresponding number or letter key to select it.
3. When you have finished your message, select Send. See [“Setting sending options” on page 26](#) for information about how and when you want the message to be received.



Setting sending options

When you are ready to send a message, you have several options for how and when you want the message to be received.

1. Once you have completed the message, select Options:
 - Add address returns to the “Send To” screen to add another recipient without losing the message. Enter a recipient manually or select Options to access your Recent list, Contacts, or Groups and

press .

Select a contact and press . Highlight the number field and press .

- Save message saves the message in your Drafts folder. This prevents the message from being deleted if you have activated Auto-Erase and enables you to send the message to others.
 - Save as auto text saves the message you have just entered as a prewritten message then returns to the message entry screen so you can send the message.
 - Settings allows you to choose from the following after pressing 
 - Callback number includes a callback number with the message to let recipients know at what number they can call you back. Select OK to include your own number or enter a different callback number then select OK.
 - Validity period defines expiration period limit for a message.
2. When you have finished setting options, press  to return to the message window.
 3. Press  to select Send.

Adding a signature

The signature you create is included at the end of all outgoing messages and is counted as characters in your messages; however, it does not appear in the message creation screen.

To create a signature:

1. Select Menu → Settings → Messaging → Signature.
2. Enter your signature in the text field.
3. Select OK to save the setting.

Note: The characters in the signature are included in the total character count of the message. See “Creating a text message” on page 25.

If you cannot send messages

You may not be able to send or receive messages if your phone’s memory is nearly full, or if digital service is not available at the time. To free up memory, erase old messages. See “Erasing messages” on page 29.

Receiving incoming calls while creating messages

- To answer the call, press . Your message is saved to the Drafts folder. To return to the message, select Menu → Messaging → Drafts. Choose a message and press to select Edit.
- If you don’t wish to answer the call, press to select Options and then press to select Ignore or press to select Silence then press to answer.

Viewing your sent messages

To save your outgoing messages, you must first enable this feature.

To enable the Save to outbox setting

1. Select Menu → Messaging → Msg settings → Save to outbox.
2. Select an option and press .
 - Prompt allows you to choose whether or not to save your message when you send it.
 - Enabled automatically saves all successfully sent messages in the Sent folder.

To view successfully sent messages:

1. Select Menu → Messaging → Outbox.
2. Press up or down through the list of messages. One of the following symbols appears next to each message:

The scheduled message will be sent at the scheduled time. You cannot cancel delivery of the message.

The scheduled message was sent and delivered as scheduled. You cannot cancel delivery of the message.

The message has been sent to more than one recipient.

The message was never sent or not sent since it was last modified. You can cancel delivery of the message.

Viewing failed or pending messages

Failed or pending messages are stored in your Outbox.

To view your Outbox:

1. Select Menu → Messaging → Outbox. A list of all failed or pending messages appears.
2. Scroll through the list of messages and press  to read one.



 The message is pending and will be sent when possible. You can cancel delivery of the message.

 The message cannot be sent because service is not available. An alert appears on your phone if the message cannot be sent.

Receiving text messages

When a text message is received, your screen displays “New Message(s)” with the  symbol at the top of your screen. The symbol flashes if the message is urgent.

If you see the “New Messages” note

- To view the message, press  to select InBox, highlight the message, and press  to select View.
- To ignore the message, press .

Note: If you receive a new message while you are reading a message, the one you are reading will

be replaced by the new one. You can find the older message in the InBox:



- Select Menu → Messaging → InBox.

If you see the  symbol

1. Select Menu → Messaging → InBox. A list of all your received messages appears.
2. Scroll through the list of messages and press  to read one.

Reading the message

The options available to you may vary. Check with Carrier.

1. If the text message is long, press  down to view the entire message.
2. When you are finished, you can press  to Reply to the sender or press  to set additional Options for the message:
 - Forward to forward the message.
 - Erase to erase the message.
 - Lock msg to protect the message from being accidentally deleted.
 - Reply with copy to reply to the message with a copy of the original attached.
 - Save message to save the message.

- Save as auto text to save the text from the message as auto text, which you can insert into other messages. Graphics and sound are not saved as part of auto text. (For more about auto text, see [page 30](#).)
- View Sender information.

Note: The  symbol indicates that a graphic did not come through. It may be too large or incorrectly formatted.

Setting message alerts





You can set your phone to alert you of incoming text messages or pages. For more information, see [“Setting sound alerts” on page 41](#).

Erasing messages

It is a good idea to erase old messages to free up memory in your phone.

You have the option of erasing text messages and pages as you send or read them, erasing them one at a time from the list in the Outbox or Inbox, or erasing them all at once.

Erasing single messages

1. Select Menu → Messaging.
2. Select the type of text message you want to erase and press : Inbox, Outbox, Saved, or Drafts.
3. Highlight the message to erase and press .
4. Press  to select Options.
5. Select Erase and press  to erase the message. A notification appears: “Erase this message?”
6. Select Yes to erase the message.

Note: You can erase a scheduled message from the Outbox, but you cannot cancel delivery of the message.

Erasing all messages

1. Select Menu → Messaging → Erase msgs.
2. Select a folder from which to erase all messages: Inbox, Outbox, Saved folder, Drafts folder, or All messages. To erase messages from all folders, select All messages.
3. A message appears: “Erase all messages?” Select Yes to erase messages or No to cancel.

Erasing messages automatically

Use this setting to have old messages automatically erased from the Inbox when memory is low.

- Select Menu → Messaging → Msg settings → Auto-Erase → Inbox msgs.





Older messages are erased as new messages are received.

Customizing message settings

To make messaging easier, you can customize settings for sending and receiving messages.

Creating groups

You can create and save a list of multiple recipients. Your K325 phone stores five group lists with up to 10 recipients per list.



1. Select Menu → Settings → Messaging → Groups → Create new.
2. Enter a name for the list. For help entering text, see [page 19](#).
3. Press  to select Next.
4. To enter the first phone number or email address, select an option:
 - Recent list to select numbers from your Recent List.
 - Enter from scratch to enter the phone number or email address manually.
 - Contacts list to select numbers from your phone book.
5. Locate the contact number and press  twice.
6. To add additional recipients, press  to select Options → Recent list or Contacts.
7. Locate the contact you want to add to the group and press  twice.

Repeat step 6. and 7. to add recipients.

8. When finished, press  to select Done.
9. To send a message to your new group, see [“Sending text messages” on page 25](#).

Creating and editing prewritten messages (auto text)

Your phone comes with pre-written (auto text) messages, such as “Please call me,” which you can insert into the body of a text message. You can edit these messages and create new ones. Your phone stores up to 40 auto text messages, with up to 100 characters per message.

1. Select Menu → Settings → Messaging → Auto text.
2. Highlight an auto text message and press  to select Edit to edit the pre-written message.
- or -
To create a new pre-written message, press  to select New msg.
3. Enter the text and press  to select Save.
For help entering text, see [page 17](#).

Note: You can also save a message you have written or received as auto text. See [“Setting sending options” on page 26](#) or [“Reading the message” on page 28](#).





7 MULTIMEDIA MESSAGING

Sending multimedia messages

You can send multimedia messages to phones that are capable of receiving them or to email addresses. For details and pricing, check with Carrier.







Note: Size limits may apply to multimedia message files. Visit www.xxxxxxx.com for details.

Creating a multimedia message

1. If you do not have pictures stored in your picture folder, select Menu → Messaging → Send picture msg and then continue at step 3.
If you have pictures stored in your picture folder, select Menu → Messaging → Send picture msg and then continue at step 2.
2. Press  left, right, up, or down to highlight a picture and press  to select it.
3. Enter the recipient's phone number or email address in the To field.
4. To add additional recipients:
Enter a space after the first phone number or email address, then enter another recipient manually
- or -
Press  to select Options. Then select Contacts or Group Lists. Highlight a contact and press  twice to select it.







Note: You can send one multimedia message to a maximum of 10 recipients.

You can choose to send a copy or blind copy.

5. Press  down to enter a recipient in the CC or BCC fields.
6. Press  down to enter a message in the Subject field. Choose a method:
 - Enter the subject text manually, or
 - Press  to select Options.
7. Press  down to enter a brief text message in the Text field.
 - Enter the text manually, or
 - Press  to select Options.
8. Press  down once to enter a image in the Image field.
9. Press  to select Options:



Note: You may add only one picture per multimedia message.

- Take a picture to instantly take a new photo and attach it to your message.
- My graphics to access all graphic files in the phone.
 - My pictures displays your photos taken in a table/thumbnail view.
 - CarrierXL graphics displays stored images on the phone.

- Highlight an image and press  to choose Select to attach it to your message.
10. Press  down once to enter sound and press  to select Options:
- Note: You may add only one new or stored sound per multimedia message sent.
- Record sound to instantly record a new sound and attach it to your message.
 - My sounds to display a list of categories that contain saved or downloaded sounds and voice memos.
 - Saved sounds displays sound clips saved on the phone.
 - Voice memos lists your saved voice memos.
 - Highlight a sound and Press  to choose Select to attach it to your message.
11. Before sending your message, press  to select additional Options:
- Preview message plays your multimedia message prior to sending.
 - Save message allows you to save your multimedia message to the Drafts Folder and send it later.
 - Add address allows you to add additional addresses to your multimedia message prior to sending it.
 - Message Priority allows you to label the message as Urgent.
12. Press  to select Send. This sends your multimedia message.

Receiving multimedia messages



When a multimedia message is received, your screen displays the picture alert “New Message(s)” along with the question “Retrieve Now?” Charges apply. See www.xxxxxxxxxxxxx.com for pricing.



- To download the message, press  to select Yes. If you view the picture alert from the Inbox, select Get Now.
- To download the message at a later time, press  to select Options → Retrieve Later.
- To erase the message without viewing it, press  to select Options → Erase.

Note: If a multimedia message is received during a call, then the phone screen displays the alert “New Message(s)” after the call ends.

Viewing multimedia messages

After you have downloaded a multimedia message, a  appears on your phone's screen and remains until all messages are viewed. The message is stored in the Inbox until the full message is received, regardless of the auto receive or prompt setting.

1. Press  to View the multimedia message. If the message is long, press  down to view the entire multimedia message.

2. Press  to select Options. Press  down to highlight additional options for the multimedia message:

Note: The options available to you may vary. Check with Carrier.

- Forward launches the message creation screen, allowing you to forward the multimedia message. The original address is not shown, nor the graphic, sound, and text fields.
- Erase allows you to delete the currently displayed multimedia message.
- Message info displays multimedia message information (priority, sender, subject, time sent and received, and message size).
- Replay allows you to replay the message.
- Mute silences the embedded sounds in the multimedia message.
- Sender displays sender information.
- Call initiates call to sender of multimedia message.
- Save picture saves the currently viewed picture embedded in the multimedia message.
- Save sound saves the current sound embedded in the multimedia message.
- Save address extracts email addresses, phone numbers, and/or URLs from the sender info and multimedia message body.

- Save as auto text saves the text in the multimedia message to the auto text list.
 - Save message saves the multimedia message to the Saved Folder on the phone.
 - Launch Browser to access a Web site.
3. When you are finished viewing the multimedia message, select Reply or press .

While viewing a message, press  to view all numbers, Web sites, and links associated with the message.

8 AIM®

Accessing the AIM service

Now you can access the AOL® Instant Messenger™ (AIM) service from your K325 phone. Check Carrier's Web site at www.xxxxxxxxxx.com for availability and pricing.



To launch AIM, select Menu → AIM.



Note: You cannot receive incoming calls during a AIM session. All incoming calls are automatically sent to your voicemail.

Ending an IM client session

Press  from any AIM page.

Navigating AIM

- Press  up or down to scroll through items and to highlight one.
- Press  to select an AIM menu item or option.
- Press  to go back one screen.

Note: A scroll bar on the right side of the screen indicates that there is more text. Press  down to go to the next screen of text. Press  to move back one screen.

Send IM message

Select Menu → Messaging → Send AIM to access AIM and send an instant message.

9 CARRIERXL

Accessing CarrierXL

With CarrierXL, you can access a variety of exclusive music, entertainment, and information services from your K325 phone. Download the latest games, ringtones, wallpapers, screen savers, and other content; surf the web; and more. New xxxxxXL features are added all the time. Check Carrier's Web site at www.xxxxxxxxx.com for availability and pricing, or check directly from your phone using xXL. Charges apply.

To launch CarrierXL:

- From the main screen, press  left.

- or -



Select Menu → CarrierXL.



Note: You cannot receive incoming calls during a CarrierXL session. All incoming calls are automatically sent to your voicemail.

Ending a CarrierXL session

- Press  from any CarrierXL page.

Navigating CarrierXL

- Press  up or down to scroll through items and to highlight one.
- Press  to select a CarrierXL menu item or option.
- Press  to go back one screen.

Note: A scroll bar on the right side of the screen indicates that there is more text. Press  down to go to the next screen of text. Press  to move back one screen.

10 MY STUFF

My ringtones

The My ringtones folder stores your preloaded and downloaded ringtones. You can download the latest ringtones to your K325 from the Carrier Web site at www.xxxxxx.com or directly from your phone using xxxxXL.

Select Menu → My stuff → My ringtones → Get more ringtones. Charges apply.

Downloading ringtones

Note: If you don't have enough money in your account, you will need to Top-Up before downloading.

1. Press  left to launch CarrierXL and then search for ringtones.
2. Follow the prompts to purchase and download the selected ringtone.

Downloaded ringtones are stored in the My stuff → My ringtones folder in your phone in order of newest to oldest.

Assigning downloaded ringtones

1. Select Menu → My stuff → My ringtones.
2. Select a downloaded ringtone and press  to select Options → Set Default.

Note: The downloaded ringtone is also listed in the Ringtones folder and available to assign to individual contacts or as the Personal or Business ringtone. See [“Creating a new contact” on page 20](#) and [“Assigning ringtones” on page 20](#).

My games

You can download the latest games to your K325 from the Carrier Web site at www.xxxxxx.com or directly from your phone using xxxxXL. Select Menu → My stuff → My games → Get more games. Charges apply.

Note: If you don't have enough money in your account, you will need to Top-Up before downloading.

1. Press  left to launch CarrierXL and then search for games.
2. Follow the prompts to purchase and download the selected game.

Downloaded games are stored in the My stuff → My games folder in your phone.

My other stuff

You can download the latest applications to your K325 from the Carrier Web site at www.xxxxxx.com or directly from your phone using CarrierXL. Select Menu → My stuff → My other stuff → Get more stuff. Charges apply.

Note: If you don't have enough money in your account, you will need to Top-Up before downloading.



1. Press  left to launch CarrierXL and then search for applications.
2. Follow the prompts to purchase and download the selected application.

The downloaded application is stored in the My stuff → My other stuff folder in your phone.

My graphics

The My graphics folder stores your downloaded graphics. Download the latest wallpapers and screensavers to your K325 from the Carrier Web site at www.xxxxxx.com or directly from your phone using CarrierXL. Select Menu → My stuff → My graphics → Get more graphics. Charges apply.



Note: If you don't have enough money in your account, you will need to Top-Up before downloading.

1. Press  left to launch CarrierXL and then search for graphics.
2. Follow the prompts to purchase and download the selected graphic.
3. Press  to return to the main screen.

The downloaded graphic will be stored in the My stuff → My graphics folder in your phone.



Note: Downloaded graphics are stored in order of newest to oldest and can be assigned as either screensavers or wallpaper.

Assigning downloaded graphics

1. Select Menu → My stuff → My graphics.
2. Select My pictures, CarrierXL graphics, Wallpapers, Screensavers or Caller IDs, and press .
3. Scroll to the graphic you want to assign and press  to select Options.
4. Highlight Set Default or Assign and press .

My sounds

You can record and save voice memos and all received attached sound files to My sounds. To listen to saved sounds or recorded voice memos:

1. Select Menu → My stuff → My sounds.
2. Select Saved sounds or Voice memos and press .
3. Scroll through the lists to listen to the saved sounds.
4. Highlight a sound and press  to select Options.
5. Highlight Record New, Erase, Lock, Rename, Details, or Erase All and press .

11 CUSTOMIZING YOUR PHONE

The contents of the Settings menu are as follows:

| | | | |
|--------------------|------------------|--------------------|-------------------|
| Sounds | Display | Call options | Security |
| Ringtone volume | Greeting banner | Add voice dial | Lock phone |
| Ringtones | Menu style | Erase voice dial | Change lock code |
| Business ringtones | Color themes | Voice training | Emergency numbers |
| Personal ringtones | Wallpaper | Voice wake-up | Erase contacts |
| Flip open | Screensavers | Voice answer | Network |
| Flip closed | Backlight | Expert mode | Privacy alert |
| Pwr on/off sound | Auto-Hyphen | Messaging | Location |
| Key volume | Time/Date format | Alerts | Accessories |
| Key length | Contrast | Groups | Pwr backlighting |
| Alerts | Brightness | Auto text | Headset ringing |
| Smart sound | Convenience | Text entry | Auto-Answer |
| Minute alert | Open to answer | Signature | TTY |
| Earpiece volume | Fast find | Save to outbox | Gamepad Keymap |
| Spkrphone volume | Frequent list | Auto-Erase | Phone Info |
| | Hold call | Callback number | Build Info |
| | 1-Touch dialing | Camera | Icon Keys |
| | Any key | Resolution | |
| | | Picture quality | |
| | | Shutter sound | |
| | | Viewfinder display | |

Silencing all sounds

Your phone is set to make sounds when you receive calls, press keys, navigate through menus, and receive alerts (such as new messages). You can silence all sounds and set the phone to vibrate when you receive calls and alerts.

Setting the phone to vibrate

- Press and hold .

Turning sounds back on

- Press and hold .

Setting ringtones

Changing your default ringtone

Your K325 phone has multiple ringtones you can choose to use for incoming calls.

1. Select Menu → Settings → Sounds → Ringtones.
2. Scroll down the list to hear the different rings and press **OK** to select one.

Changing your business ringtone

Your K325 phone has multiple ringtones you can choose to use for incoming calls from your Business group.

1. Select Menu → Settings → Sounds → Business ringtones.
2. Scroll down the list to hear the different rings and press **OK** to select one or press **Back** to select Saved sounds.

Note: Downloaded ringtones are added to the end of the standard list of ringtones.

Changing your personal ringtone

Your K325 phone has multiple ringtones you can choose to use for incoming calls from your Personal group.

1. Select Menu → Settings → Sounds → Personal ringtones.
2. Scroll down the list to hear the different rings and press **OK** to select one or press **Back** to select Saved sounds.

Setting sounds for your phone

You can set your phone to sound tones when you open and close the flip and when you turn the phone on and off. Sounds will not occur during an incoming call, if you are in a call, or if a headset or car kit is attached to your phone.

Set sound when flip opens

1. Select Menu → Settings → Sounds → Flip open.
2. Scroll through the list to hear the sounds and press **OK** to select one.

Set sound when flip closes

1. Select Menu → Settings → Sounds → Flip closed.
2. Scroll through the list to hear the sounds and press **OK** to select one.



Set sound when phone powers on or off

- Select Menu → Settings → Sounds → Pwr on/off sound → Enabled.
 - To deselect this sound, select Disabled.

Adjusting volume



You can adjust the earpiece, speakerphone, and ringtone volume as well as key tones.

Adjusting the ringtone volume

1. Select Menu → Settings → Sounds → Ringtone volume.
2. Press  right to increase the volume, or left to decrease the volume.
3. Press  to select Save.

Adjusting key tone volume

You can change the volume of the tones the phone makes when you press the keys.

1. Select Menu → Settings → Sounds → Key volume.
2. Press  right to increase the volume, or left to decrease the volume.
3. Press  to select Save.

Setting key length

You can change the duration of the tones the phone makes when you press the keys.

1. Select Menu → Settings → Sounds → Key length.
2. Choose Normal or Long and press .

Setting sound alerts

You can choose how you want be alerted of incoming voicemail, pages, text messages or missed calls.

1. Select Menu → Settings → Sounds → Alerts.



2. Select the type of alert: Message alert, Page alert, Voicemail alert, Missed call alert or Reminder.
3. Select an option and press .

Using smart sound



You can set a baseline volume that the phone uses to automatically adjust the earpiece volume when there is a change in the amount of noise around you or the caller's voice.

- Select Menu → Settings → Sounds → Smart sound → Enabled.



Adjusting the earpiece volume

To adjust the earpiece volume manually during a call, press  or  up or down.

To set the earpiece volume:

1. Select Menu → Settings → Sounds → Earpiece volume.
2. Press  right to increase the volume, or left to decrease the volume.
3. Press  to select Save.



Adjusting speakerphone volume

1. Select Menu → Settings → Sounds → Spkrphone volume.
2. Press  right to increase the volume, or left to decrease the volume.
3. Press  to select Save.

Personalizing the screen



Changing your banner

The banner is the personal label for your phone. It appears on the main screen above the time and date. The banner can be up to 14 characters long.

1. Select Menu → Settings → Display → Greeting banner.
2. Press  to select Edit.
3. Press  to clear the screen.
4. Enter your new text.
5. Press  to select Save.

Choosing a menu style

Three menu styles are available: Wheel, Graphic, and List.

1. Select Menu → Settings → Display → Menu style.
2. Select an option and press 
 - Graphic displays icons of each menu item, with its name at the bottom of the screen.
 - List displays a list of each menu item.
3. Press  to return to the main screen. The next time you select Menu, you see the menu style you selected.

Selecting a color theme

You can select a color theme for the display background of your phone.

1. Select Menu → Settings → Display → Color themes.
2. Scroll through the options to view the color themes and press  to select one.

Selecting wallpaper

Wallpaper appears on the main screen.



1. Select Menu → Settings → Display → Wallpaper.
2. Highlight a wallpaper design and press  - or -

Press  to access Options:

Take a Picture - take a picture and select it as a wallpaper.

My Pictures - allows you to select a picture from your picture folder.





My Graphics - allows you to select a graphic from your media folder.

3. Press  to assign the wallpaper.
4. Press  to return to the main screen.

Note: Downloaded wallpapers are saved in Menu → My stuff → My graphics → Wallpapers.

Selecting a screensaver

Screensavers appear on the main screen when the flip is open or closed and are activated 10 seconds after the last keypress. Incoming calls and alerts override screensavers.

1. Select Menu → Settings → Display → Screensavers.
 2. Highlight a screensaver and press . The image displays.
- or -
Press  to access Options:
Take a Picture - take a picture and select it as a screensaver.
My Pictures - allows you to select a picture from your picture folder.
My Graphics - allows you to select a graphic from your media folder.
 3. Press  to assign the screensaver.
 4. Press  to return to the main screen and wait 10 seconds to view the screensaver you chose.
- Note: Downloaded screensavers are saved in Menu → My stuff → My graphics → Screensavers.

Adjusting the backlighting

Your screen lights up while you are in a call or when you press a key on the keypad. However, you can set the length of time that bright backlighting remains on.

1. Select Menu → Settings → Display → Backlight → Duration.
2. Select an option and press .

- 7 seconds, 15 seconds, or 30 seconds— (Default) Turn backlighting on for 5, 10, or 30 seconds after your last keypress.
- 7 sec. & in call, 15 sec. & in call, or 30 sec. & in call—Turn backlighting on for the duration of a call, and for 5, 10, or 30 seconds after your last keypress.
- Disabled—Turns off backlighting.

Note: The “in call” settings drain the battery more quickly.

Using power save mode

You can conserve battery life by activating Power save mode to dim the backlight set in the procedure above. The backlighting appears for the selected duration but is less bright than with Power save off.

- Select Menu → Settings → Display → Backlight → Pwr save mode → On.

Setting power backlighting

You can set backlighting to remain on when an external power source, such as the AC adapter, is used with the phone.

Note: Power backlighting may not be available with the optional desktop charger or other accessories.

1. Select Menu → Settings → Accessories → Pwr backlighting.
2. Select Always On to keep backlighting on.

Note: The battery charges slower when power backlighting is on.

Setting numbers to auto-hyphenate

Auto-hyphenation, when enabled, automatically inserts hyphens into your phone numbers to be consistent with the U.S. dialing plan. For example, 1-222-333-4444.

- Select Menu → Settings → Display → Auto-Hyphen → Enabled.

Choosing a different time/date format

1. Select Menu → Settings → Display → Time/Date format.
2. Highlight an option and press .

Changing the display contrast

1. Select Menu → Settings → Display → Contrast.
2. Press  left or right to adjust the brightness and select Save.

Changing the display brightness

1. Select Menu → Settings → Display → Brightness.
2. Press  left or right to adjust the contrast and select Save.

Creating a secure environment

This section describes all the features involved in securing your phone and preventing access to

personal information. All security features are shielded by a four-digit lock code.

Locking your phone

When your phone is locked, you can call only emergency numbers or Carrier's customer service number. You can still receive incoming calls.

1. Select Menu → Settings → Security.
2. Enter your four-digit lock code.
3. Select Lock phone.
4. Highlight an option and press 
 - Never does not lock the phone.
 - On power up locks the phone every time you turn it on.
 - Now locks the phone immediately.

Unlocking the phone

1. From the main screen,  to select Unlock.
2. Enter your four-digit lock code.

Changing your lock code

The lock code is typically 0000 or the last 4 digits of your phone number.

1. Select Menu → Settings → Security.
2. Enter your four-digit lock code
3. Select Change lock code. A message appears: "Change Code?"
4. Press  to select Yes and enter a new four-digit code.
5. Enter your new lock code again.

Designating emergency numbers

The emergency numbers feature allows you to specify three personal phone numbers that can be called when the phone is locked.

1. Select Menu → Settings → Security.
2. Enter your four-digit lock code.
3. Select Emergency numbers.
4. Select an Unassigned slot.
5. Enter the phone number, including the area code. Do not enter 1 before the area code.
6. Press  to select Done.

Note: To make a call to an emergency number from a locked phone, you must dial the number (including area code) exactly as it was stored in Emergency Numbers.

Erasing all contacts

You can erase all entries from your Contacts directory.

1. Select Menu → Settings → Security.
2. Enter your four-digit lock code.
3. Select Erase contacts.
4. Select Yes to erase all contacts. A message appears: “Erase ALL Contacts?”
5. Press  to select Yes to erase all contacts.

Connecting to a TTY/TDD device

You can connect the phone to a TTY device for the hearing impaired. **Note:** Enable TTY only when using the phone with a TTY device.

1. Connect the TTY device to the phone.
2. Enter ##889 from your keypad.
3. Press  to select the TTY option.

Setting position location

This setting allows you to share your location information with network services other than emergency services (For example: 911, 111, 999, and 000) in markets where service is implemented.

Note: This feature works only when your phone is in digital mode. You do not have the option of turning off the locator to emergency services.

1. Select Menu → Settings → Network → Location.
2. Select 911 Only or Location on.
 - 911 Only (default) shares your position information only with emergency services when you call your 3-digit emergency code (911, 000, 111, etc.).
 - Location on shares your position information with Carrier’s network, in addition to emergency services.





12 USING VOICE RECOGNITION

Voice recognition allows you to make and answer calls by speaking commands into the phone's microphone.

Setting up voice dialing

To make or receive calls using voice dialing, contacts must be saved with associated voice tags.

Creating a voice tag for a contact

1. Press  to select Contacts.
2. Highlight the contact and press .
3. Press  down to highlight the number.
4. Press  to select Options.
5. Highlight Add Voice Dial and press .
6. Follow the voice prompts. You will need to say the name twice.

Viewing entries with voice tags

- Select Menu → Contacts → Voice dial list.
A list of all contacts with assigned voice tags appears.

Editing a voice tag

1. Select Menu → Contacts → Voice dial list.
2. Highlight the contact to edit and press .
3. Highlight the phone number and select Options.

4. Select Add voice dial, Edit voice dial, or Erase voice dial.
5. Follow the prompts.

Making a call using voice tags

1. If you haven't already done so, record a voice tag for the person you wish to call.
2. From the main screen, press . The phone responds: "Say a name."
3. Say the name of the person you want to call.
4. If the name you said matches a contact in the Voice Dial List, the phone responds: "Calling (Name)." Remain silent to make the call, or say No to cancel.

Note: If the phone finds multiple voice tags that sound like the name you said, you are asked to verify which name you want to call. Say Yes when you hear the correct name. Say No when you hear an incorrect name.

5. When you are finished with the call, press .

Erasing voice tags

To erase all voice name dial recordings in your phone:

1. Menu → Settings → Call options → Erase voice dial.
2. Select Yes.

Making a call using digit dialing

When using digit dialing, you speak digits to dial a phone number.

Note: You cannot speak a string of digits. You must speak one digit at a time and wait for the prompt.

1. From the main screen, press . The phone responds: "Say a name or say Dial."
2. Say "Dial". The phone responds: "Speak a digit."
3. Speak the first digit of the phone number you want to call. Once the phone repeats the digit, you can speak the next digit.

If you pause, the phone prompts you with the following five options. After the prompt, speak an option.

- Say "Clear" to erase the last digit entered. The phone responds: "Digit cleared." To clear the entire phone number, say "Clear" again. When the phone prompts you with "Clear entire phone number?", say "Yes" to clear or "No" to cancel.
- Say "Call" to dial the number.

- Say "Verify" to cause phone to repeat the set of digits that you input.
- Say "Cancel" to exit voice recognizer and return to the main screen.
- Speak a digit to enter the next digit. Once the phone repeats the digit, you can speak the next digit or pause to hear the prompt.

Using voice features with hands-free headset

You can use voice commands to make a phone call or to answer the phone only if your phone is connected to a hands-free headset (sold separately).

Note: The following features apply only to hands-free headsets unless noted.

To shop for hands-free headsets, visit www.xxxxxxx.com.

Waking up the phone

If your phone is connected to a hands-free headset, you can use the voice command to activate the phone to make a phone call.

To activate the Voice Wake-up setting:

1. Select Menu → Settings → Call options → Voice wake-up → With accessory.

To wake up the phone:

1. Say "Wake Up" and listen for a tone.
2. Say "Wake Up" again until you hear two tones.

If the phone does not recognize your “Wake up” command, see [“Training voice recognition” on page 48](#).

Answering the phone

You can set your hands-free headset to (1) answer automatically or (2) answer using a voice command.

Answering automatically

You can set your phone to answer automatically.

Note: This setting also works with the portable hands-free headset.

- Select Menu → Settings → Accessories → Auto answer → After 5 seconds.

Answering using voice commands

If Auto-Answer is turned off, you can use a voice command to answer an incoming call using the installed hands-free headset.

- Select Menu → Settings → Accessories → Auto answer → Disabled.

To activate the Voice Answer setting:

1. Select Menu → Settings → Call options → Voice answer.
2. Highlight Enabled and press .

To answer a call:

When you receive an incoming call, the phone responds: “Incoming call, answer?” If the caller is recognized as a contact entry in your phone, then the phone says “Incoming call from (Name), answer?”

- Say “Yes” or press any key except .

Ignoring an incoming call

To ignore an incoming call, do one of the following:

- Say “No” and press  to silence the alert.
- Remain silent. The voice alert repeats twice and the phone rings once, then returns to the main screen.

Training voice recognition

If your phone is having trouble recognizing your voice, you can train it with the commands Yes, No, and Wake up.

1. Select Menu → Settings → Call options.
2. Select Voice training.
3. Read the message and press  to select OK and continue. Cancel returns you to the previous screen.
4. Select Train All or the item you want to train.
5. Follow the prompts for each word until training is complete.

13 USING THE CAMERA





Tips before operating your camera

- You cannot activate the camera while on a call.
- Once the camera is active, the main screen acts as the viewfinder.
- If you get a “Low memory” error, check your resolution and quality compression settings. See “Setting up the camera” on this page.
- If there is no activity within 45 seconds after you turn your camera on, the camera quits and returns to the previous screen.

Accessing picture mode

1. Flip open
2. Press and hold  until you hear two beeps to activate picture mode.

Camera settings

1. Press and hold  to activate picture mode.
2. Press  to select Options.
3. Press  to select Settings.
4. Highlight an option and press :
 - Flash options are Off, On, or Automatic.
 - Resolution options are 640 x 480, 320 x 240 (best for sending to email), and 160 x 120.
 - Low Light Mode brightens the picture for low light environments.
 - Self Timer options are Off (default) or 3, 5, or 10 second pauses. When set, the camera beeps from 3 seconds down to the time the shutter snaps the picture automatically. Self Timer is not available when Multishot mode is activated.
 - Multishot allows you to take up to six multiple pictures while the camera key is pressed and held. A tone plays each time a picture is taken. A second tone plays when the final picture is taken.
 - Shutter Sound sets the sound used when the camera takes a picture.
 - White Balance allows the camera to adjust for different lighting. Options are

Automatic, Fluorescent, Incandescent, or Daylight.

- Color Tone allows you to capture pictures with different coloring. Options are Normal, Black & White, Negative, and Sepia.
- Quality sets the picture compression. The higher the compression, the better the detail of the picture (higher pixel rate). Options are Low, Medium, or High (default). When set to High, the picture file size is larger, using more memory.
- LED flashes a light to indicate a picture has been taken. Options are Off (default) and On.
- Viewfinder Display options are Fullscreen and Actual.

Restoring camera menu settings



The following settings revert to the default setting each time you enter and exit the camera application:

- Low Light Mode, Self Timer, MultiShot, Color Tone, and Viewfinder.

The following settings remain at the setting you selected each time you enter and exit the camera application:

- Flash, Resolution, Shutter Sound, White Balance, Quality, and LED.





Menu options for picture mode

1. Press and hold  to activate picture mode.
2. Select Options.
3. Press  up or down to scroll through the options on the vertical menu bar:
 - Settings displays available camera settings you may set up prior to taking a picture.
 - Brightness allows you to adjust the brightness of the image in the main screen LCD.
 - My pictures displays all pictures taken and stored.
 - Last Picture displays the most recently taken picture.
 - Frames allows you to add a frame or a stamp to your picture. A frame or stamp cannot be removed once it is used in a picture.



Note: The picture resolution changes to 160 x 120 while taking pictures with frames. The resolution returns to the original setting once Frames is disabled.



Picture mode indicators and icons

The picture mode displays the following onscreen indicators and icons:







| Icon | Description |
|---|-------------------------------|
|  | Flash on |
|  | Picture mode |
| Top right hand corner numbers | Number of snapshots remaining |
|  | Zoom level |
| Bottom left hand numbers | Resolution setting |
|  | Multishot |
|  | Self Timer |

Taking a picture

1. Press and hold  to activate picture mode
- or -
Select Menu → Pictures → Take a picture.
2. Focus on the image using the phone's display as a viewfinder.
3. Take the picture using one of two methods:
 - Press  or  to select Capture.

4. Press  to select Send or  to select Erase.
5. Press  when finished taking pictures.

Camera key map

| Key | Camera | Menu Screen |
|--|--------------------------------|---------------------------|
|  | Take picture | Dismiss menu options |
|  Left softkey | Select Capture to take picture | Select OK |
|  Right softkey | Select Options | Cancel, dismisses menu |
|  Up | Zoom in | Scroll menu options right |
|  Down | Zoom out | Scrolls menu options left |
|  | Take a picture | Select menu option |

14 USING TOOLS

Voice memo



The Voice Memo tool allows you to record and play back audio memos.

Recording a voice memo

1. Select Menu → Tools → Voice memo → Record new.
2. Record your memo and press  to select Stop.
3. Select Save to save your memo.

Note: If an incoming call is received while you're recording a memo, the memo is saved and the incoming call screen appears.

Playing or reviewing a voice memo

1. Select Menu → Tools → Voice memo → Recorded memos.
2. Highlight the voice memo to review and press  to select Play.
3. Press  right and left to select a function and press  to perform it:





Play 

Stop 

Pause 

Mute 

Naming a saved voice memo

1. Select Menu → Tools → Voice memo → Recorded memos.
2. Highlight the memo and press  to select Options.
3. Select Rename and press .
4. Press and hold  to clear the default name.
5. Use the keypad to enter a name for the memo.
6. Press  to select Save.

Erasing a saved voice memo

1. Select Menu → Tools → Voice memo → Recorded memos.
2. Highlight the memo and select Options.
3. Select Erase and press . The prompt "Erase file?" appears.
4. Select Yes or No.

Scheduler

The Scheduler allows you to schedule events and set reminder alerts.

Creating an event

1. Select Menu → Tools → Scheduler → Add new event.

2. Enter a name for the event and press **C** down. For help entering text, see [page 16](#).
3. Select Options and classify the type of event and press **OK**: Meeting, Phone Call, Birthday, Anniversary, Vacation, Medical, or Other.
4. Press **OK** to change the date of the event (the current date is the default date).
 - Press **C** left or right to move between the month, day, and year fields.
 - Press **C** up or down to change the month, day, or year.
 - Press **OK** to save your changes.
5. Press **OK** to set the time of the event.
 - Press **C** left or right to move between the hour, minute, and AM/PM fields.
 - Press **C** up or down to change the hour, minute, or AM/PM.
 - Press **OK** to save your changes.
6. Press **OK** to set the duration of the event.
 - Press **C** left or right to move between the hour and minute fields.
 - Press **C** up or down to change the hour and minute.
 - Press **OK** to save your changes.
7. Press **OK** to set a reminder of the event.
 - Select an option and press **OK**.
8. Press **OK** to set the reminder sound.
 - Select an option and press **OK**.
9. Press **OK** to select a Silent Mode setting
 - Select No or During event and press **OK**.
10. Press **OK** to select whether or not this is a recurring event.
 - Select an option and press **OK**: No, Daily, Weekly, Monthly, or Annually.
11. Press **OK** to select Save.

Editing, erasing, or sending an event

1. Select Menu → Tools → Scheduler → View all events.
2. Press **C** up or down to highlight the event and press **✓** to select View.
3. Press **⌵** to select Options.
4. Select Edit or Erase and press **OK**.
5. Follow the prompts and then press **OK** to select Save.

Alarm clock

You can set up to four alerts with your phone's three alarm clocks and one quick alarm.

Note: The alert occurs only if the phone is on.

Setting an alarm

1. Select Menu → Tools → Alarm clock.
2. Highlight one of the alarms and select Set.
3. Use the phone keypad to enter numbers and **C** to switch between AM and PM.
 - Press **C** left or right to move between hours, minutes, and AM/PM fields.

- Press up or down to change the hours, minutes, and AM/PM options.
- 4. Press to set the time of the alarm.
- 5. Select Options to set the alarm sound.
- 6. Highlight an option and press .
- 7. Select Options to set the recurring time.
- 8. Highlight an option and press .
- 9. Enter a note for the alarm and press .
- 10. Press to select Save and set the alarm(s).
- 11. When the alarm rings, select Off to turn off the alarm or Snooze to silence the alarm for 10 minutes.

Note: Opening the flip turns off the alarm.

Setting the QuickAlarm

1. Select Menu → Tools → Alarm Clock.
2. Highlight QuickAlarm and select Set.
3. Select an option and press : 5 Minutes, 15 Minutes (default), 30 Minutes, or 60 Minutes. A message appears telling you the QuickAlarm is On.
4. When the alarm rings, select Off to turn off the alarm or Reset to set the QuickAlarm again.

Tip calculator

The Tip calculator helps you calculate how much tip to include with a bill.

1. Select Menu → Tools → Tip calculator.
2. Enter the amount of your bill.

3. Press to select Next.
4. Select the amount you want to include as a tip (10%, 15%, 18%, 20%, Other) and press . Your total bill appears, including tip.
5. To split the bill, press to select Split.
6. Press to clear the default of 2 guests.
7. Enter the number of guests and to select Next. The amount each guest pays is calculated.
8. Select Done.

Calculator



Use the calculator for basic mathematical equations.



1. Select Menu → Tools → Calculator.
 2. Use the keypad to enter numbers.
 3. Use to select mathematical operations:
 Left \times (multiply) Up $+$ (add)
 Right \div (divide) Down $-$ (subtract)
 4. Press to calculate the result.
 Example: Enter 5, press left to select X, enter 2, then press to obtain the result of 10.
 5. Press to return to the main screen.
 - or -
 Press to clear the screen.
- Options

- M+ Adds displayed digit to the value stored in memory.
- MR Displays currently stored value on screen.
- MC Clears value currently stored in memory.

Timer

This timer counts down for a specified amount of time. It beeps when that amount of time has elapsed.

1. Select Menu → Tools → Timer.
2. Select Set.
 - Press  to move the cursor left or right.
 - Press  up or down to set the hours, minutes, and seconds.
3. Select Start to begin the countdown. Select Stop to pause the countdown. Select Reset to clear the timer.

4. Select Sound, highlight an alarm sound and press  to select the alarm.
5. Press  to silence the alarm.

Stopwatch

1. Select Menu → Tools → Stopwatch.
2. Select Start to begin counting. Select Stop to stop counting. Select Reset to clear the counter.

15 GETTING HELP

Customer support

To contact Carrier's customer support department for information about your phone, account history, call coverage area, and specific features available to you, such as call forwarding or voicemail:

- Go to www.xxxxxxxx.com.
- Dial *VM from your Carrier phone. Airtime charges may apply.
- Dial 888-xxx-xxxx from any phone.

For questions about the phone features, refer to the materials provided with your phone, or visit www.xxxxxxxx.com.

For additional questions, you may contact the Kyocera Wireless Corp. Customer Care Center in any of the following ways:

- Web site: www.kyocera-wireless.com.
- Email: phone-help@kyocera-wireless.com.
- Telephone: 1-800-349-4478 (U.S. and Canada) or 1-858-882-1401.

Before requesting support, please try to reproduce and isolate the problem. When you contact the Customer Care Center, be ready to provide the following information:

- The name of your service provider: Carrier.

- The actual error message or problem you are experiencing.
- The steps you took to reproduce the problem.
- The phone's electronic serial number (ESN).
To locate the ESN, select Menu → Settings → Phone Info.

Qualified service

If the problem with your phone persists, return the phone with all accessories and packaging to the dealer for qualified service.

Become a product evaluator

To participate in the testing and evaluation of Kyocera Wireless Corp. products, including cellular or PCS phones, visit beta.kyocera-wireless.com.

16 CONSUMER LIMITED WARRANTY

Kyocera Wireless Corp. (“KYOCERA”) offers you a limited warranty that the enclosed product or products (the “Product”) will be free from defects in material and workmanship for a period that expires one year from the date of sale of the Product to you, provided that you are the original end-user purchaser of the Product and provided that your purchase was made from an authorized supplier. Transfer or resale of a Product will automatically terminate warranty coverage with respect to that Product. This limited warranty is not transferable to any third party, including but not limited to any subsequent purchaser or owner of the Product.

KYOCERA shall, at its sole and absolute discretion, either repair or replace a Product (which unit may use refurbished parts of similar quality and functionality) if found by KYOCERA to be defective in material or workmanship, or if KYOCERA determines that it is unable to repair or replace such Product, KYOCERA shall refund the purchase price for such Product, provided that the subject Product (i) is returned, with transportation prepaid, to a KYOCERA authorized service center within the one year warranty period, and (ii) is accompanied by a proof of purchase in the form of a bill of sale or receipted invoice which evidences that the subject Product is within the one year warranty period (“Proof of Purchase”).

After the one year warranty period, you must pay all shipping, parts and labor charges.

This limited warranty does not cover and is void with respect to the following: (i) any Product which has been improperly installed, repaired, maintained or modified; (ii) any Product which has been subjected to misuse (including any Product used in conjunction with hardware electrically or mechanically incompatible or used with accessories not approved by KYOCERA), abuse, accident, physical damage, abnormal operation, improper handling, neglect, exposure to fire, water or excessive moisture or dampness or extreme changes in climate or temperature; (iii) any Product operated outside published maximum ratings; (iv) cosmetic damage; (v) any Product on which warranty stickers or Product serial numbers have been removed, altered, or rendered illegible; (vi) cost of installation, removal or reinstallation; (vii) signal reception problems (unless caused by defects in material and workmanship); (viii) damage the result of fire, flood, acts of God or other acts which are not the fault of KYOCERA and which the Product is not specified to tolerate, including damage caused by mishandling, shipping and blown fuses; (ix) consumables (such as fuses); or (x) any Product which has been opened, repaired, modified or altered by anyone other than KYOCERA or a KYOCERA authorized service center.

USE ONLY KYOCERA APPROVED ACCESSORIES WITH KYOCERA PHONES. USE OF ANY UNAUTHORIZED ACCESSORIES MAY BE DANGEROUS AND WILL INVALIDATE THE PHONE WARRANTY IF SAID ACCESSORIES CAUSE DAMAGE OR A DEFECT TO THE PHONE.

KYOCERA SPECIFICALLY DISCLAIMS LIABILITY FOR ANY AND ALL DIRECT, INDIRECT, SPECIAL, GENERAL, PUNITIVE, EXEMPLARY, AGGRAVATED, INCIDENTAL OR CONSEQUENTIAL DAMAGES, EVEN IF ADVISED OF THE POSSIBILITY THEREOF, WHETHER FORESEEABLE OR UNFORESEEABLE OF ANY KIND WHATSOEVER, INCLUDING BUT NOT LIMITED TO LOSS OF PROFITS, UNANTICIPATED BENEFITS OR REVENUE, ANTICIPATED PROFITS ARISING OUT OF USE OF OR INABILITY TO USE ANY PRODUCT (FOR EXAMPLE, WASTED AIRTIME CHARGES DUE TO THE MALFUNCTION OF A PRODUCT) OR CONTRIBUTION OR INDEMNITY IN RESPECT OF ANY CLAIM RELATED TO A PRODUCT.

REPAIR OR REPLACEMENT OF A DEFECTIVE PRODUCT OR REFUND OF THE PURCHASE PRICE RELATING TO A DEFECTIVE PRODUCT, AS PROVIDED UNDER THIS WARRANTY, ARE YOUR SOLE AND EXCLUSIVE REMEDIES FOR BREACH OF THE LIMITED WARRANTY, AND SUBJECT TO THIS WARRANTY, THE PRODUCTS ARE APPROVED AND ACCEPTED BY YOU "AS IS". KYOCERA MAKES NO OTHER WARRANTIES, REPRESENTATIONS OR CONDITIONS OF ANY KIND, ORAL OR VERBAL, EXPRESS OR IMPLIED, STATUTORY OR OTHERWISE, WITH RESPECT TO

THE PRODUCTS, INCLUDING BUT NOT LIMITED TO ANY IMPLIED WARRANTY OR CONDITION OF MERCHANTABILITY OR FITNESS FOR A PARTICULAR PURPOSE OR AGAINST INFRINGEMENT OR ANY IMPLIED WARRANTY OR CONDITION ARISING OUT OF TRADE USAGE OR OUT OF A COURSE OF DEALING OR COURSE OF PERFORMANCE. NO DEALER, DISTRIBUTOR, AGENT OR EMPLOYEE IS AUTHORIZED TO MAKE ANY MODIFICATION OR ADDITION TO THIS WARRANTY.

Some jurisdictions do not allow the exclusion or limitation of incidental or consequential damages, or allow limitations on how long an implied warranty lasts, so the above limitations or exclusions may not apply to you.

This limited warranty gives you specific legal rights, and you may also have other rights which vary from jurisdiction to jurisdiction.

For warranty service information, please call the following telephone number from anywhere in the continental United States and Canada: 1-800-349-4478 or 858-882-1401; or contact KYOCERA at the following address: 10300 Campus Point Drive, San Diego, California, 92121-1582, USA, Attention: Technical Support.

DO NOT RETURN YOUR PRODUCTS TO THE ABOVE ADDRESS. Please call or write for the location of the Kyocera Wireless Corp. authorized service center nearest you and for procedures for obtaining warranty service.

INDEX

Numerics

1-Touch dialing, 14

A

accessories, 8

alarm clock, 5, 53

alerts

 for messages, 41

 for missed calls, 13

auto text, 26, 29, 30

auto-hyphenation, 44

B

banner, 42

battery, 1

blocking outgoing calls, 45

brightness, 44

C

calculator, 54

call counters, 15

callback number, 26

calls

 answering, 11

 missed, 12

 redialing, 11

camera

 menu options, 50

 sending a picture, 50

 setting up, 51

 taking a picture, 51

color themes, 42

contacts directory, 20

contrast, 44

countdown timer, 55

D

digital mode, 5

display brightness, 44

display contrast, 44

E

emergency

 calls, 15

 emergency mode, 15

 exit emergency mode, 15

 position location, 5, 45

erasing

 contact entries, 21, 45

 phone numbers, 22

 text messages, 29

F

fast find, 23

finding contact information, 23

flashlight, 55

frequent contacts, 23

G

games

 downloading, 37

graphics

 assigning, 38

 downloading, 38

H

hands-free headset

 answering using voice, 48

 jack, 4

hard pause, 20

hearing-impaired usage, v

I

icons, 5

 contacts, 21

 messages, 28

Inbox, 28

L

limiting calls out, 45

lock code, 44

locking

 phone, 44

M

memory

 saving, 29

menu style, 42

N

number mode, 16

O

Outbox, 28

P

phone numbers

 erasing, 22

 verifying your own, 6

phone, unlocking, 44

position location, 5, 45

programming your phone, 2

Q

QuickAlarm, 54

R

recent call icons, 13

resetting the phone, v

ringtones

- choosing types, 40
- downloading, 37
- for contacts, 20
- silencing, 6
- volume, 41

S

- scheduler, 52
- screen brightness, 44
- screen contrast, 44
- screen icons, 5, 16, 27, 28
- screensavers, 42
- secret contacts, 13, 22
- security, 44
- sent messages, 27
- silent mode, 5, 39
- smart sound, 41
- smiley mode, 17
- speed dialing, 22
- stopwatch, 55
- symbol mode, 17

T

- text entry, 16
 - quick reference, 18
- text messages, 25
- time format, 44
- timer, 55
- timing calls, 15
- tip calculator, 54
- Top-Up, 9
- TTY/TDD, 45

U

- unlocking the phone, 44

V

- vibrate, 5

- Accessing, 36
 - navigating, 36
- Voice Answer, 48
- voice dialing, 46
- voice memo
 - erasing, 52
 - naming, 52
 - recording, 52
- voicemail, 15
 - setting up, 6
- volume
 - earpiece, 11, 41
 - key beep, 41
 - ringtone, 41

W

- wallpaper, 42
- warranty, 57

DRAFT



Kyocera Wireless Corp.
10300 Campus Point Drive
San Diego, California 92121 USA
www.kyocera-wireless.com

82-G1631-1EN Rev. X1