

Cover Letter

Federal Communications Commission
Authorization and Evaluation Division

Re: Application for Cellular and PCS Transceiver Type Acceptance

Kyocera Wireless Corporation (KWC) herein submits the Application for Equipment Authorization (FCC Form 731) and Exhibits for Type Acceptance of a Cellular & PCS Transceiver, FCC ID: OVFKWC-3245.

Applicant: Kyocera Wireless Corporation
10300 Campus Point Drive
San Diego, CA 92121-1522

Manufacture: Kyocera Wireless Corporation
10300 Campus Point Drive
San Diego, California 92121

The equipment, KWC model # KWC-3245, is for mobile station cellular and PCS system use. The KWC-3245 is in full compliance with all parts of EIA/TIA/IS-98-B&D Mobile Station-Land Station Compatibility Specification, issue July 2000 and March 2001, and also in full compliance with all parts of ANSI J-STD-018, Recommended Minimum Performance Requirements for 1.8 to 2 GHz Code Division Multiple Access (CDMA) Personal Stations, issue July 1996. The KWC-3245 has E911 Phase II GPS capability.

Information concerning how the ESN protection requirements are met is provided in Exhibit 3.

Kyocera Wireless Corporation

Lin Lu
EMC Engineer, senior staff

Request of Confidentiality

Federal Communications Commission
Authorization and Evaluation Division

Re: Request of Confidentiality

Pursuant to Sections 0.457 and 0.459 of the Commission's Rules, the Applicant hereby requests confidential treatment of information accompanying this Application as outlined below:

All schematics/block diagrams
All parts lists

The above materials contain trade secrets and proprietary information not customarily released to the public. The public disclosure of these matters might be harmful to the Applicant and provide unjustified benefits to its competitors.

The Applicant understands that pursuant to Rule 0.457, disclosure of this Application and all accompanying documentation will not be made before the date of the Grant for this Application.

Kyocera Wireless Corporation

Lin Lu
EMC Engineer, senior staff

List of Exhibits

| <u>Exhibit</u> | <u>Description</u> | <u>FCC Reference</u> |
|----------------|---|----------------------------------|
| 1 | Certification of Test Data | 2.911 |
| 2 | Operation Description | 2.1033(c), 2.1061, |
| 3 | ESN Protection | 22.919 |
| 4 | RF Output Power Measured Data - Cellular | 2.1046 |
| 5 | RF Output Power Measured Data - PCS | 2.1046, 24.232 |
| 6 | Modulation Audio Response Measured Data | 2.1047(a) |
| 7 | Modulation Limiting Measured Data | 2.1047(b), 22.917 |
| 8 | Occupied Bandwidth and Spurious Emission Measured Data - Cellular | 2.1049, 22.917 |
| 9 | Occupied Bandwidth and Spurious Emission Measured Data - PCS | 2.1049, 24.238 |
| 10 | Conducted Harmonics Emissions Measured Data - Cellular | 2.1051, 22.917, 22.901(d) |
| 11 | Conducted Harmonics Emissions Measured Data - PCS | 2.1051, 24.238 |
| 12 | Radiated Spurious and Harmonics Emissions Measured Data | 2.1053 |
| 13 | Frequency Stability vs. Temperature and Voltage Measured Data - Cellular | 2.1055 |
| 14 | Frequency Stability vs. Temperature and Voltage Measured Data - PCS | 2.1055, 24.235 |
| 15 | Measurement Procedures and Techniques | |
| 16 | List of Semiconductor Devices | 2.1033(c) |
| 17 | Circuit Diagram | 2.1033(c) |
| 18 | Identification (Labels) Information | 2.1033(c) |
| 19 | Photographs | 2.1033(c) |
| 20 | User's Manual | 2.1033(c) |
| 21 | Statement of SAR compliance and SAR test data | 2.1093 |
| 22 | FCC Compliance Emergency 911 | 22.921 |
| 23 | FCC TTY Compliance Statement | Section 255 |
| 24 | Occupied Bandwidth and Spurious Emission Measured Data - CDMA mode when operating in a P-REV 6 or above | 2.1049, 22.917, 24.238, IS98D |

Exhibit 1

Certification of Test Data

The data, data evaluation and equipment configuration represented herein are a true and accurate representation of the measurements of the sample's radio frequency interference emissions characteristics as of the dates and at the times of the test under the conditions herein specified. This applies to all tests that were performed that did not require an Open Area Test Site (OATS). Tests that required an OATS site were performed by TUV Product Services.

Equipment Tested: KWC-3245

Dates of Test: June 25 – July 12 2002

Test Performed by:

EMC Engineer, Senior Staff: Lin Lu

Exhibit 2

General Information – operation description

See a separate attachment.

Exhibit 3

ELECTRONIC SERIAL NUMBERS (ESN) Protection

The KWC-3245 Trimode Phone, FCC ID: OVFKWC-3245 uses ESN. The ESN is a unique identification number to each phone which is contained in the Numeric Assignment Module and is automatically transmitted to the base station whenever a call is placed. The ESN is stored in an EPROM and is isolated from fraudulent contact and tampering. Any attempt to change the ESN will render the portable phone inoperative.

The phone complies with all requirements for ESN under Part 22.919.

Exhibit 4**Transmitter RF Power Output - FCC part 2, Paragraph 2.1046**

6/28/2002

Conducted Power --

The RF output power was measured using a Giga-tronics 8541C Universal Power Meter and HP 8594E Spectrum Analyzer that has the CDMA personality option. Terminated to a resistive coaxial load of 50 ohms.

| carrier frequency (MHz) | channel | RF output power (dBm) - Cellular | |
|----------------------------|---------|----------------------------------|----------|
| | | Measured | |
| | | FM | CDMA |
| 824.04 | 991 | 25.45dBm | |
| 824.7 | 1013 | | 24.53dBm |
| 836.49 | 383 | 25.56dBm | 24.53dBm |
| 848.31 | 777 | | 24.53dBm |
| 848.97 | 799 | 25.56dBm | |

Radiated Power --

The RF output power (ERP) was measured in the antenna range (anechonic chamber). The test procedures and technique are stated in Exhibit 15.

| carrier frequency (MHz) | channel | RF output power ERP (dBm) – Cellular | |
|----------------------------|---------|--------------------------------------|-----------|
| | | Measured | |
| | | FM | CDMA |
| 824.04 | 991 | 26.51 dBm | |
| 824.7 | 1013 | | 25.91 dBm |
| 836.49 | 383 | 26.84 dBm | 26.08 dBm |
| 848.31 | 777 | | 26.37 dBm |
| 848.97 | 799 | 27.39 dBm | |

Exhibit 5

Transmitter RF Power Output - FCC part 24, Paragraph 2.1046, 24.232 (b)

6/28/2002

Conducted power --

The RF output power was measured using a HP 8594 Spectrum Analyzer that has the CDMA personality option. Terminated to a resistive coaxial load of 50 ohms.

| carrier frequency (MHz) | channel | RF output power (dBm) - PCS | |
|-------------------------|---------|-----------------------------|--|
| | | CDMA | |
| | | measured | |
| 1851.25 | 25 | 22.15dBm | |
| 1880 | 600 | 21.97dBm | |
| 1908.75 | 1175 | 22.14dBm | |

Radiated power --

The RF output power (EIRP) was measured in the antenna range (anechonic chamber). The test procedures and technique are stated in Exhibit 15.

| carrier frequency (MHz) | channel | RF output power EIRP (dBm) - PCS | |
|-------------------------|---------|----------------------------------|--|
| | | CDMA | |
| | | measured | |
| 1851.25 | 25 | 25.47 dBm | |
| 1880 | 600 | 26.05 dBm | |
| 1908.75 | 1175 | 25.25 dBm | |

Exhibit 6**Transmitter Modulation Requirement - FCC part 2, Paragraph 2.1047 (a), FCC part 22, Paragraph 22.917**

Measured with HP8920 RF communication test set & HP 3588A spectrum analyzer. The test procedures and technique are stated in Exhibit 15.

Audio Frequency Response (<3 kHz)

| | Audio freq (Hz) | dB relative to 1 kHz | Lower limit | Upper limit |
|----|-----------------|----------------------|-------------|-------------|
| 1 | 100 | -27.60 | -23.00 | -19.00 |
| 2 | 126 | -23.59 | -20.99 | -16.99 |
| 3 | 158 | -19.93 | -19.03 | -15.03 |
| 4 | 200 | -15.58 | -16.98 | -12.98 |
| 5 | 251 | -12.61 | -15.01 | -11.01 |
| 6 | 300 | -10.46 | -13.46 | -9.46 |
| 7 | 398 | -7.50 | -11.00 | -7.00 |
| 8 | 501 | -5.90 | -9.00 | -5.00 |
| 9 | 631 | -3.80 | -7.00 | -3.00 |
| 10 | 794 | -2.00 | -5.00 | -1.00 |
| 11 | 1000 | 0.00 | -3.00 | 1.00 |
| 12 | 1259 | 2.20 | -1.00 | 3.00 |
| 13 | 1585 | 4.50 | 1.00 | 5.00 |
| 14 | 1995 | 6.50 | 3.00 | 7.00 |
| 15 | 2512 | 8.60 | 5.00 | 9.00 |
| 16 | 2700 | 8.63 | 5.63 | 9.63 |
| 17 | 2800 | 8.54 | 5.94 | 9.94 |
| 18 | 3000 | 7.34 | 6.54 | 10.54 |
| 19 | 3100 | 6.23 | 6.83 | 10.83 |
| 20 | 3200 | 4.90 | 7.10 | 11.10 |
| 21 | 3300 | 3.07 | 7.37 | 11.37 |
| 22 | 3500 | -3.82 | 7.88 | 11.88 |
| 23 | 3700 | -6.14 | 8.36 | 12.36 |

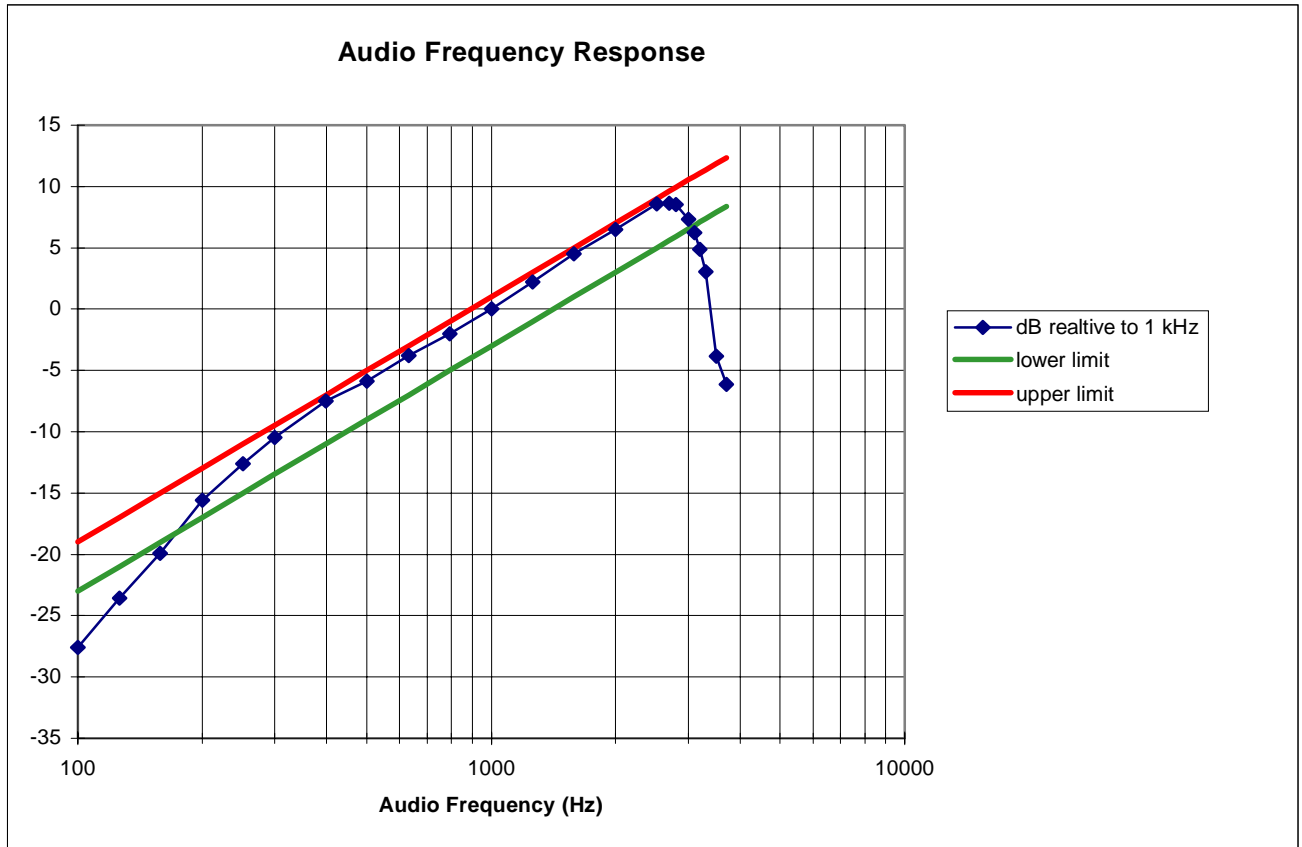

Audio Frequency Response (> 3 kHz)

| freq | dev (dB) | dB from 3 kHz | upper limit |
|-------|----------|---------------|-------------|
| 3000 | -5.35 | 0 | 0.00 |
| 3500 | -19.97 | -30.45 | -2.68 |
| 4000 | -67.85 | -33.85 | -5.00 |
| 4500 | -76.09 | -48.85 | -7.04 |
| 5000 | -73.95 | -54.35 | -8.87 |
| 5900 | -79.05 | -64.25 | -11.75 |
| 5900 | -79.05 | -64.25 | -11.75 |
| 6000 | -85.00 | -62.25 | -35.00 |
| 6100 | -85.5 | -62.15 | -35.00 |
| 6100 | -85.5 | -62.15 | -35.00 |
| 7000 | -91.36 | -57.65 | -35.00 |
| 8500 | -95.6 | -65.05 | -14.72 |
| 10000 | -81 | -59.95 | -18.09 |
| 12000 | -87 | -58.75 | -20.92 |
| 15000 | -81 | -66.45 | -24.08 |
| 20000 | -89 | -58.75 | -27.96 |
| 25000 | -89 | -57.65 | -28.00 |
| 30000 | -87.5 | -60.75 | -28.00 |

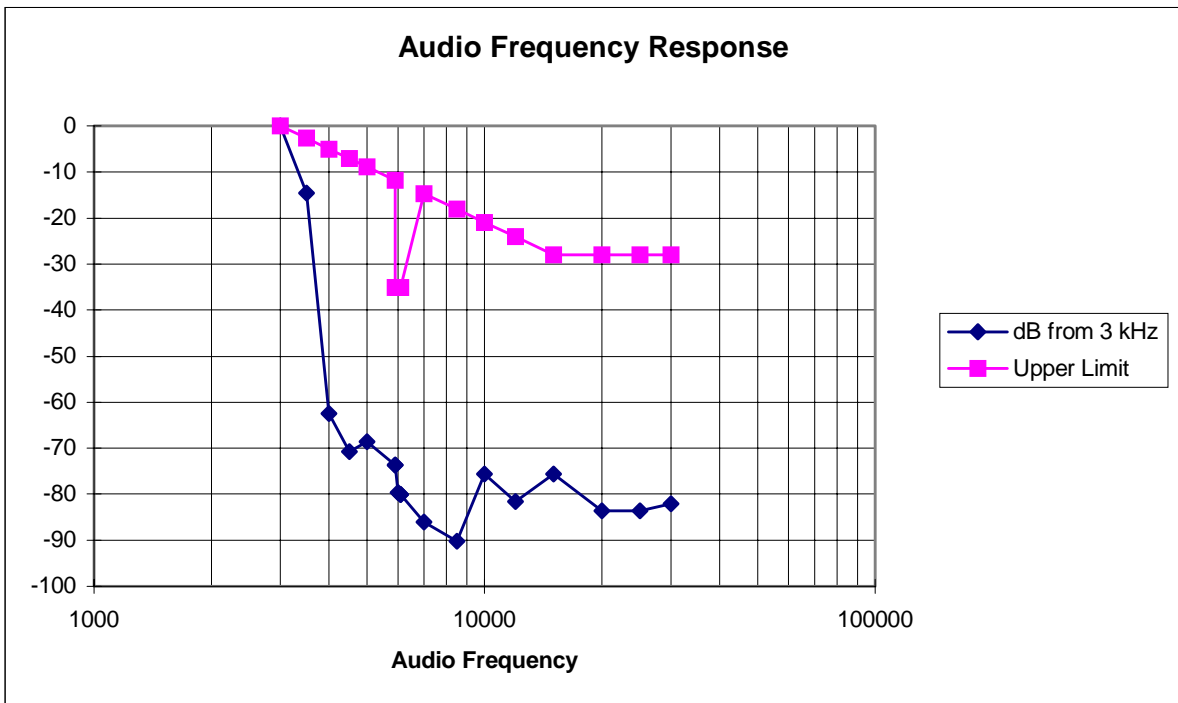

Exhibit 7

Transmitter Modulation Requirement - FCC Part 2, Paragraph 2.1047 (b)

Measured with HP8920 RF communication test set. The test procedures and technique are stated in Exhibit 15.

| Audio Input Level (dB) | FM deviation (kHz peak) | | |
|---------------------------|-------------------------|-------|---------|
| | Modulation frequency | | |
| (0dB=8kHz dev) | 400 Hz | 1 kHz | 2.7 kHz |
| -20 | 1.53 | 2.97 | 5.18 |
| -15 | 1.85 | 3.70 | 6.50 |
| -10 | 2.17 | 4.81 | 7.50 |
| -5 | 2.71 | 6.25 | 8.81 |
| 0 | 3.40 | 8 | 9.54 |
| 5 | 4.45 | 9.21 | 9.82 |
| 10 | 7.25 | 10.13 | 10.26 |
| 15 | 9.10 | 10.45 | 10.14 |
| 20 | 9.67 | 10.37 | 9.91 |

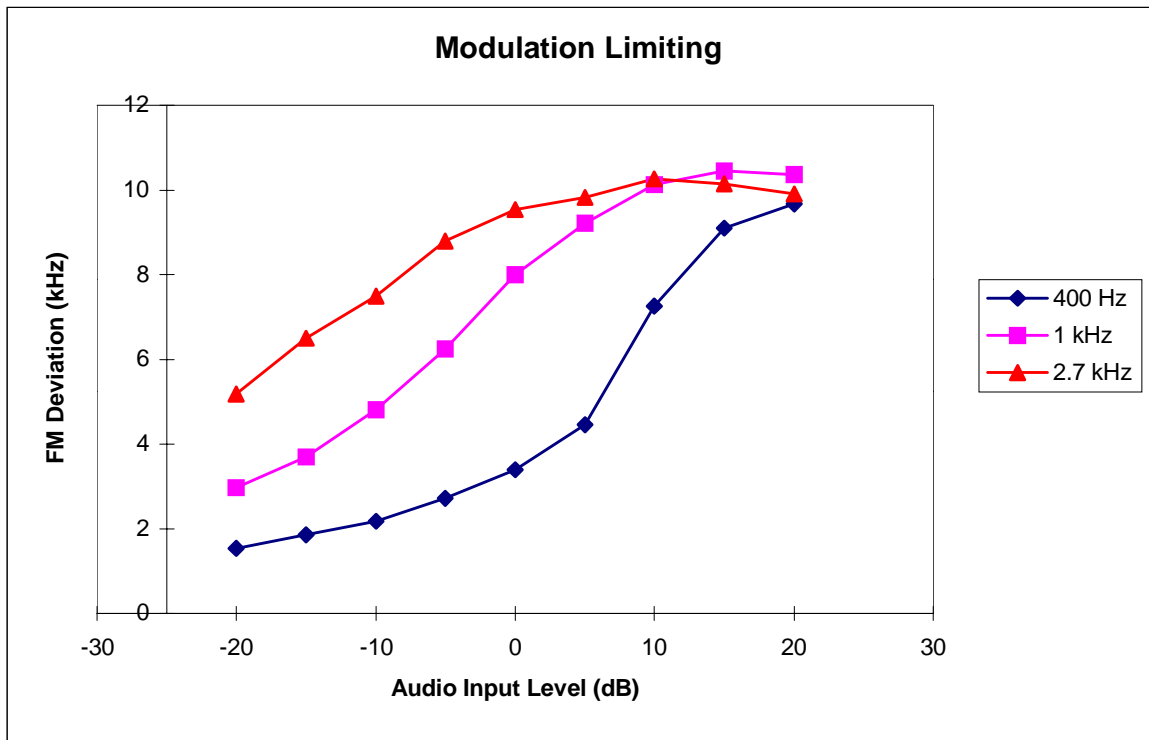

Exhibit 8**Occupied Bandwidth and Spurious Emission Measured Data**

The test procedures and technique are stated in Exhibit 15.

List of Exhibits

| <u>Exhibit</u> | <u>Description</u> | <u>FCC Reference</u> |
|----------------|--|--------------------------|
| a-1 | AMPS voice, ± 100 kHz from carrier frequency | 2.1049, 22.917 |
| a-2 | AMPS voice, 0 Hz to 3 rd harmonic | 2.1049, 22.917 |
| a-3 | AMPS voice, 869 - 894 MHz | 2.1049, 22.917 |
| b-1 | AMPS voice + SAT, ± 100 kHz from carrier frequency | 2.1049, 22.917 |
| b-2 | AMPS voice + SAT, 0 Hz to 3 rd harmonic | 2.1049, 22.917 |
| b-3 | AMPS voice + SAT, 869 - 894 MHz | 2.1049, 22.917 |
| c-1 | AMPS SAT, ± 100 kHz from carrier frequency | 2.1049, 22.917 |
| c-2 | AMPS SAT, 0 Hz to 3 rd harmonic | 2.1049, 22.917 |
| c-3 | AMPS SAT, 869 - 894 MHz | 2.1049, 22.917 |
| d-1 | AMPS ST, ± 100 kHz from carrier frequency | 2.1049, 22.917 |
| d-2 | AMPS ST, 0 Hz to 3 rd harmonic | 2.1049, 22.917 |
| d-3 | AMPS ST, 869 - 894 MHz | 2.1049, 22.917 |
| e-1 | AMPS ST + SAT, ± 100 kHz from carrier frequency | 2.1049, 22.917 |
| e-2 | AMPS ST + SAT, 0 Hz to 3 rd harmonic | 2.1049, 22.917 |
| e-3 | AMPS ST + SAT, 869 - 894 MHz | 2.1049, 22.917 |
| f-1 | SAT & DTMF, ± 100 kHz from carrier frequency | 2.1049, 22.917 |
| f-2 | SAT & DTMF, 0 Hz to 3 rd harmonic | 2.1049, 22.917 |
| f-4 | SAR & DTMF, 869 - 894 MHz | 2.1049, 22.917 |
| g-1 | AMPS WIDEBAND, ± 100 kHz from carrier frequency | 2.1049, 22.917 |
| g-2 | AMPS WIDEBAND, 0 Hz to 3 rd harmonic | 2.1049, 22.917 |
| g-3 | AMPS WIDEBAND, 869 - 894 MHz | 2.1049, 22.917 |
| h-1 | Cellular CDMA at RC1, 99% occupy bandwidth | 2.1049, 22.917 |
| h-2 | Cellular CDMA at RC1, 0 Hz to 3 rd harmonic | 2.1049, 22.917 |
| h-3 | Cellular CDMA at RC1, 869 - 894 MHz | 2.1049, 22.917 |
| | Cellular CDMA at RC3 | |
| i | <i>note: KWC-3245 supports additional reverse channels, as per IS-98D (CDMA 1x), therefore, additional measurements were taken to show compliance. Please see a separate attachment (Exhibit 24)</i> | 2.1049, 22.917 IS-98D |

AMPS Voice

a-1

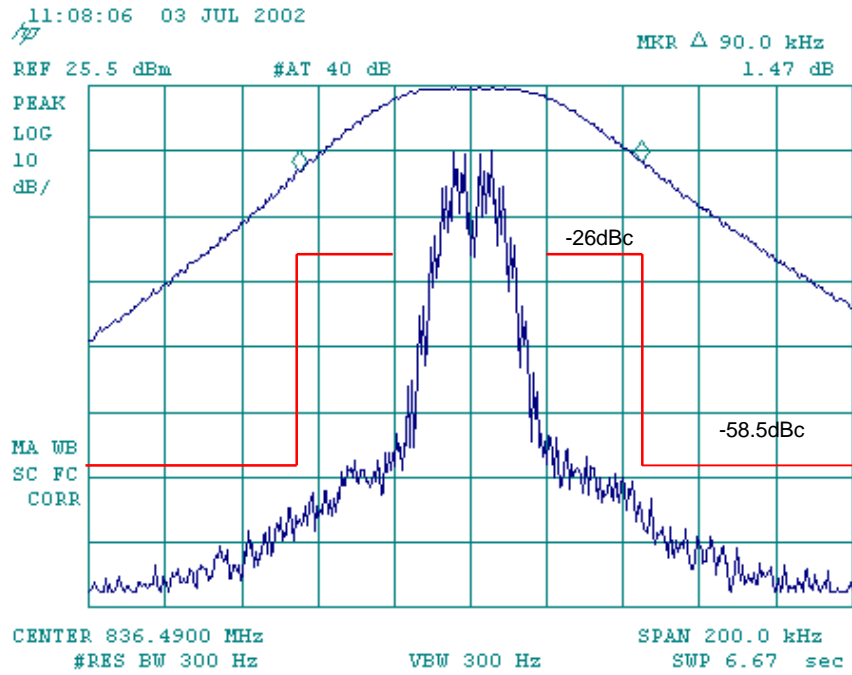

a-2

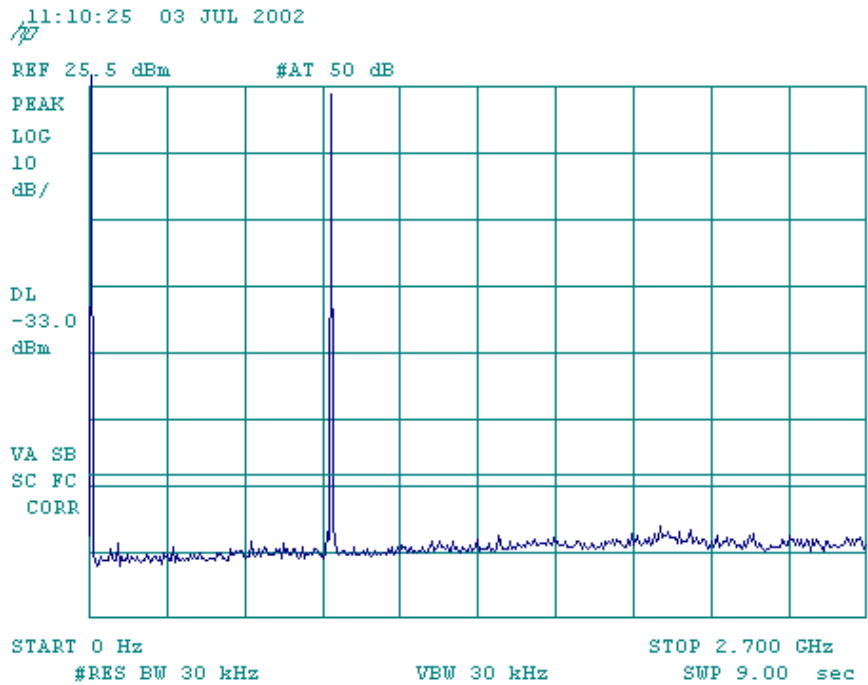

a-3

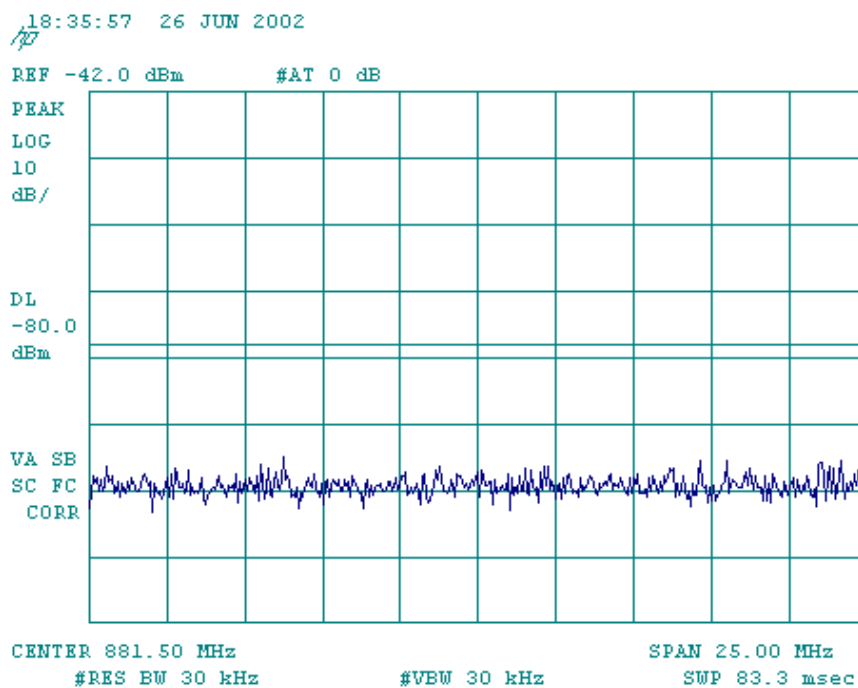

AMPS Voice + SAT

b-1

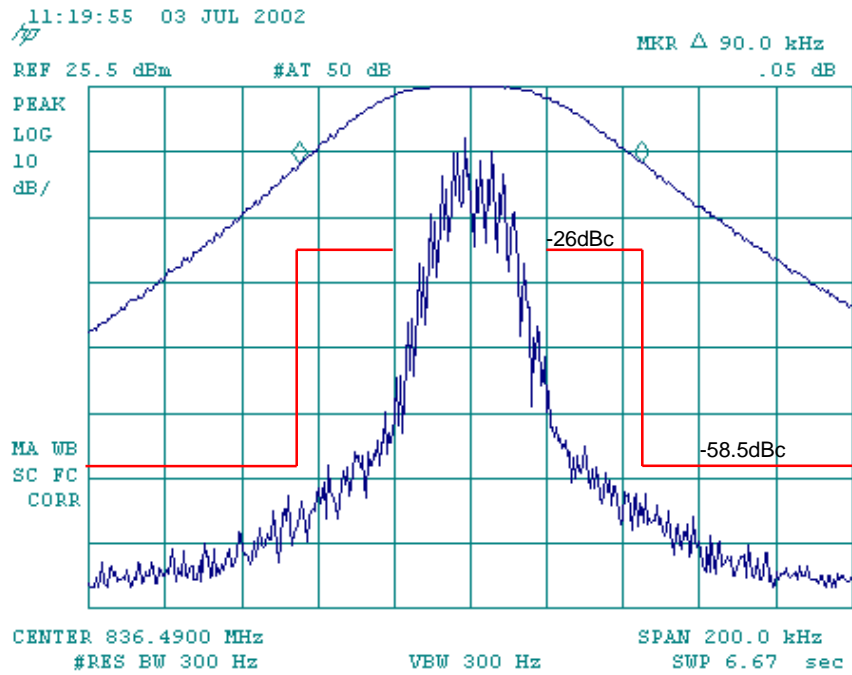

b-2

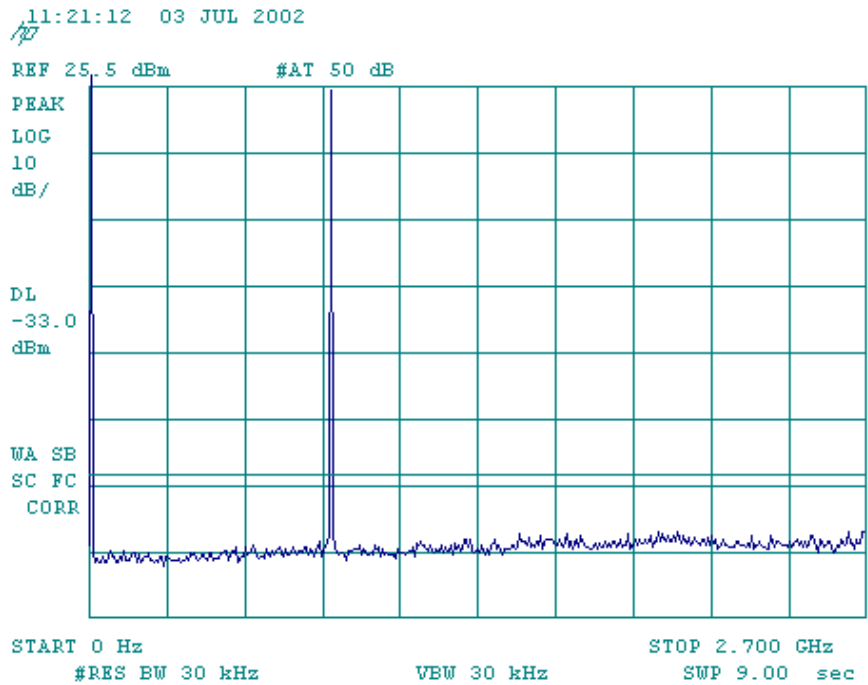

b-3

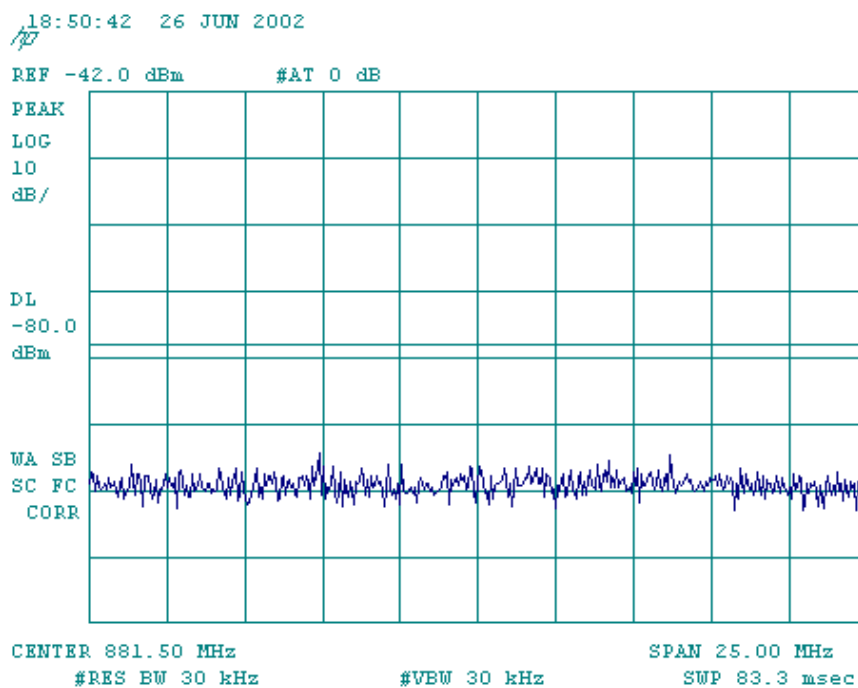

AMPS SAT

c-1

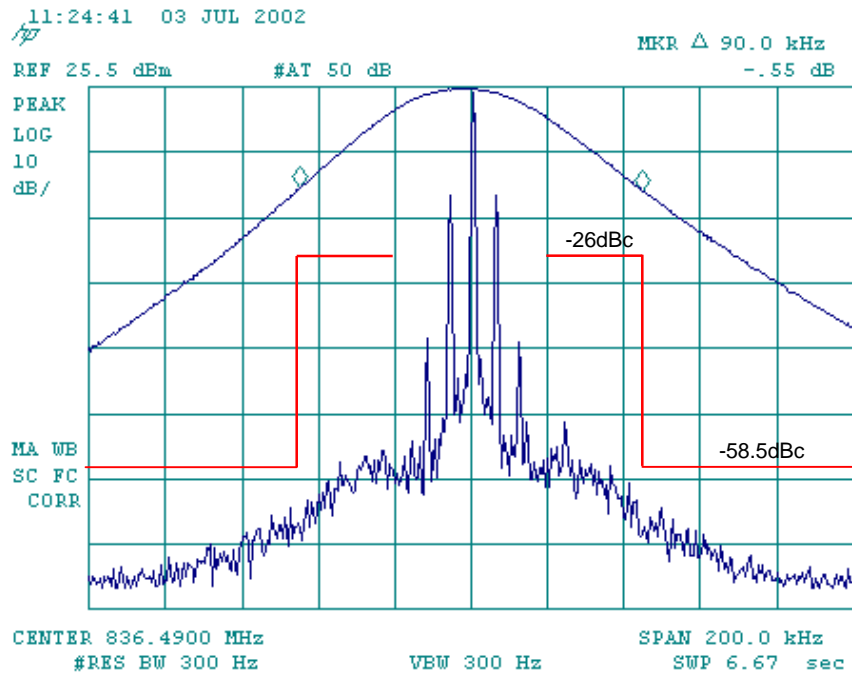

c-2

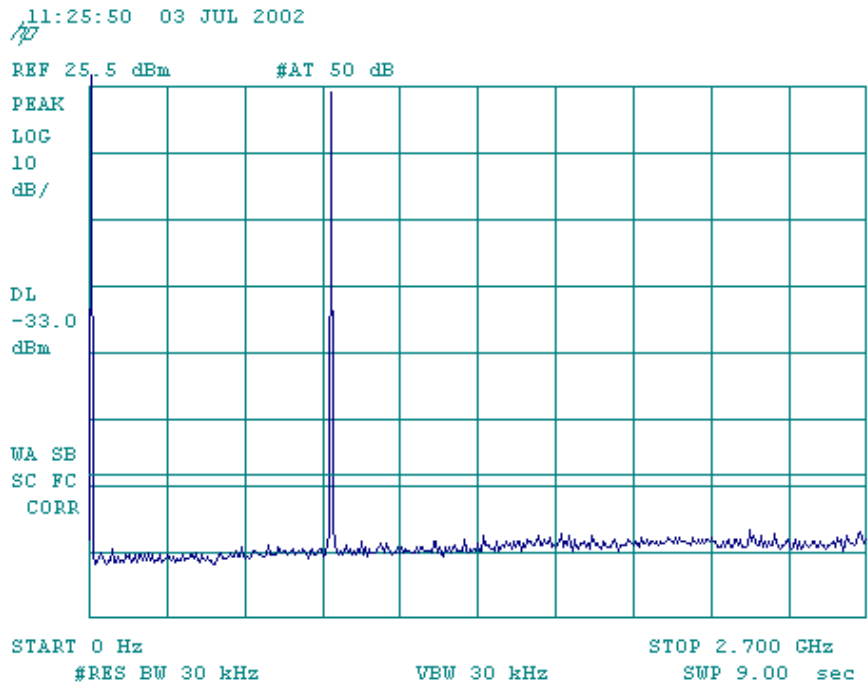

c-3

18:58:03 26 JUN 2002

~~17~~

REF -42.0 dBm #AT 0 dB

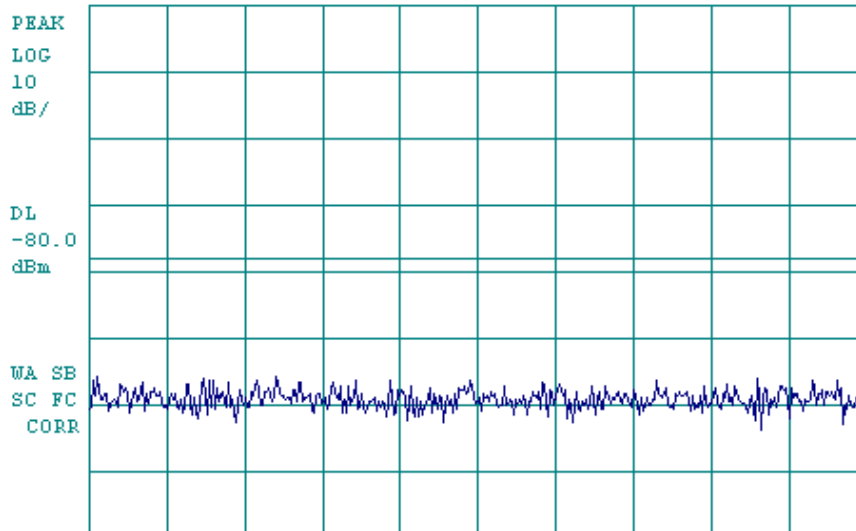

CENTER 881.50 MHz

#RES BW 30 kHz

SPAN 25.00 MHz

#VBW 30 kHz

SWP 83.3 msec

WA SB
SC FC
CORR

AMPS ST

d-1

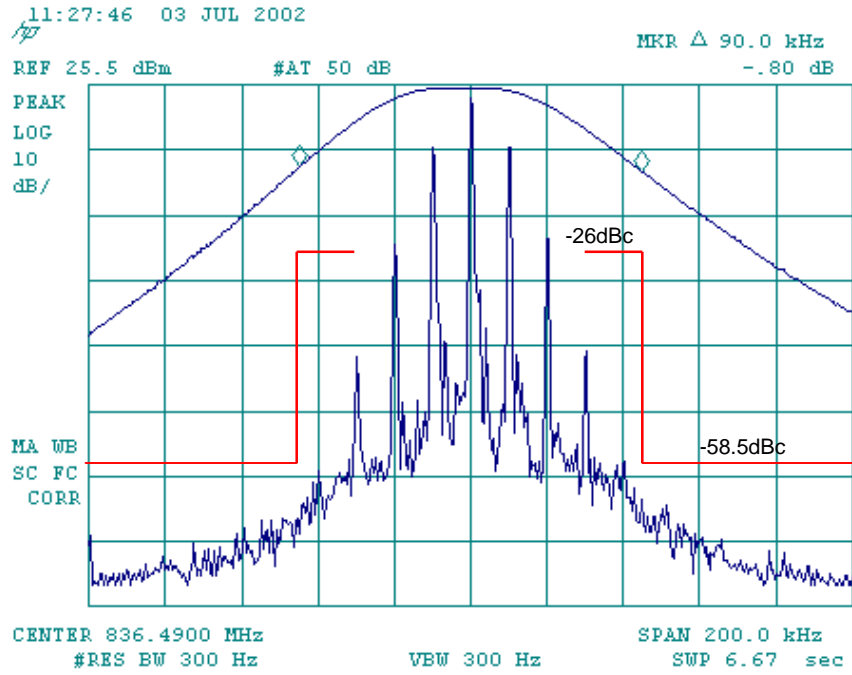

d-2

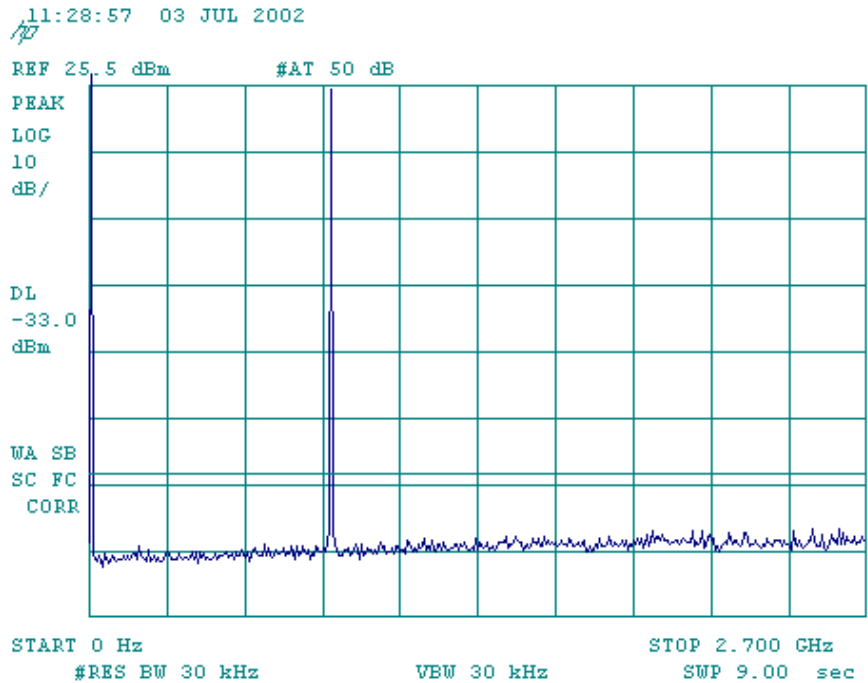

d-3

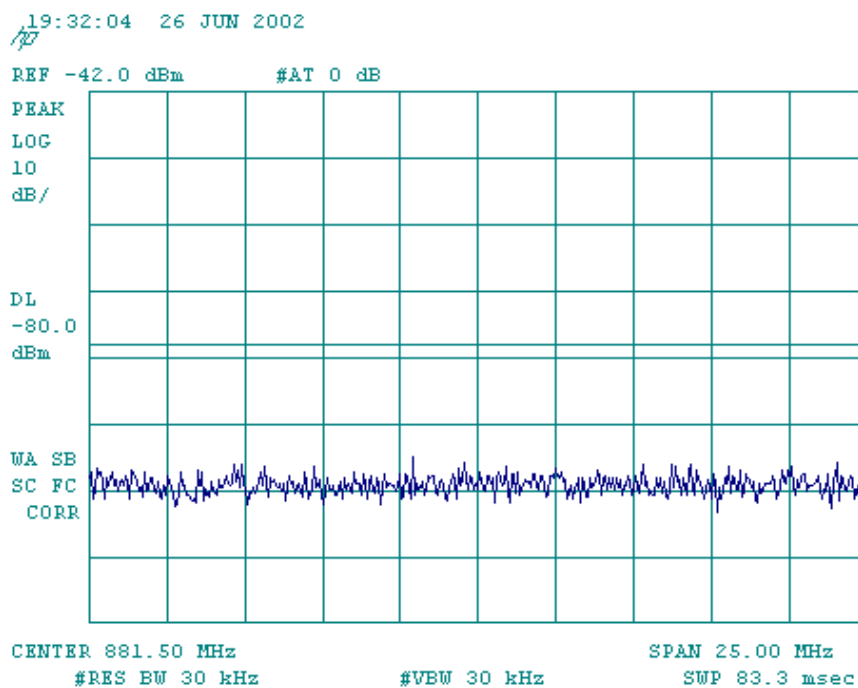

AMPS ST + SAT

e-1

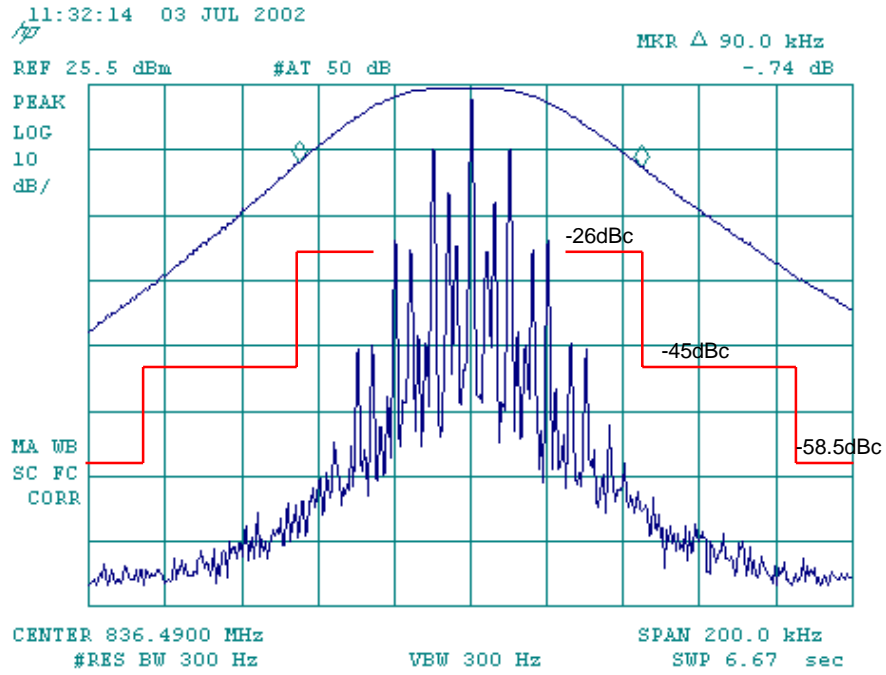

e-2

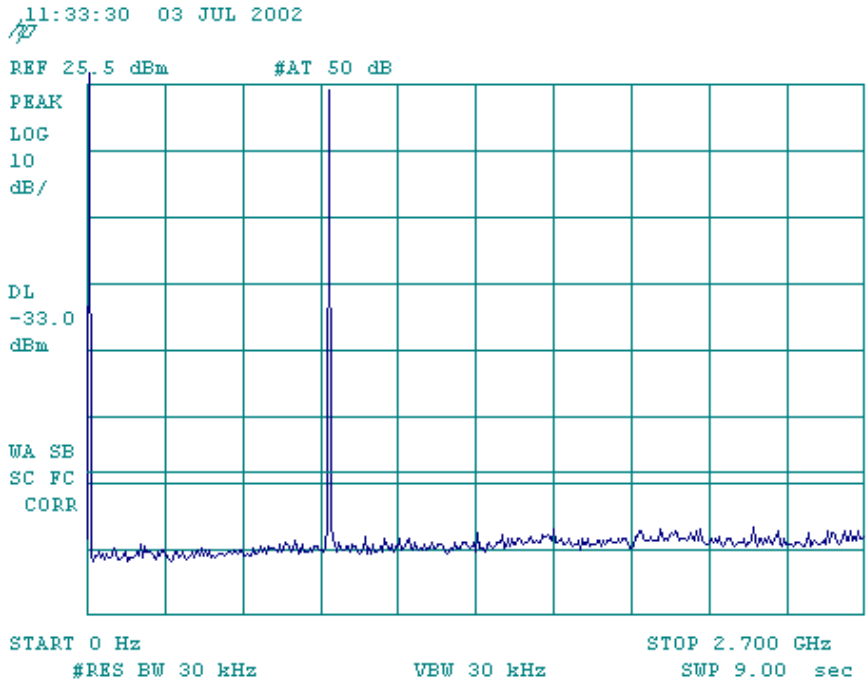

e-3

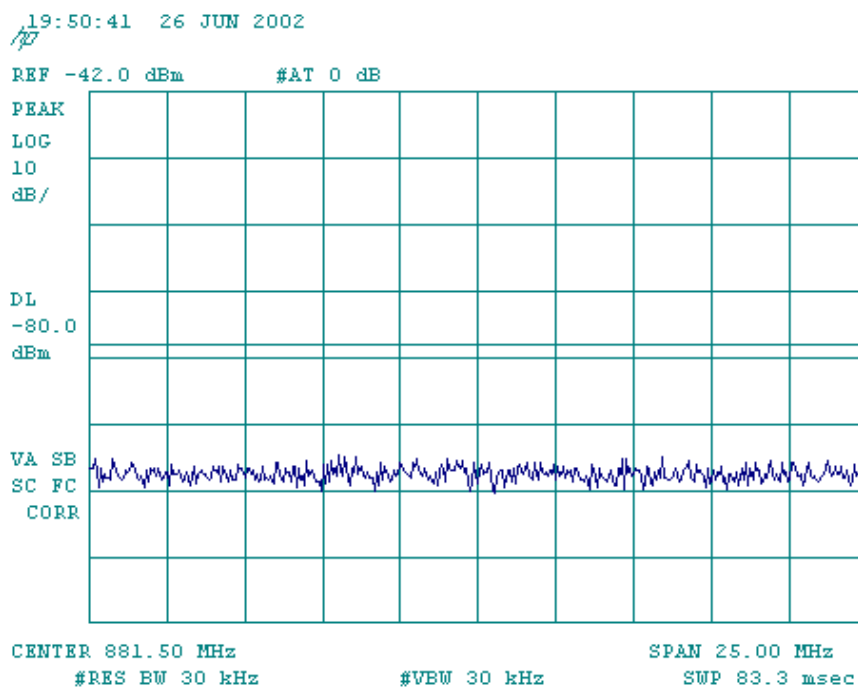

SAT + DTMF

f-1

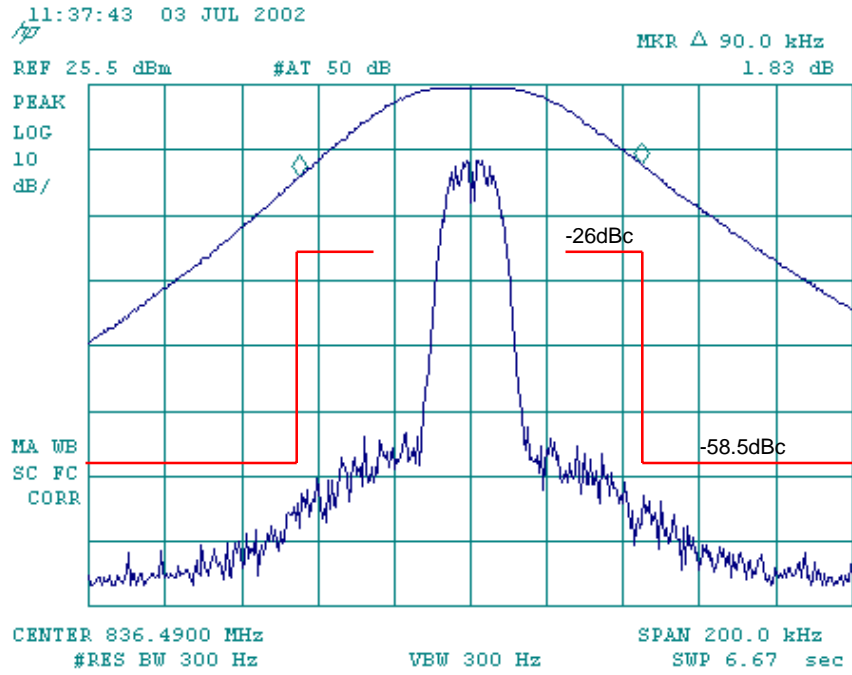

f-2

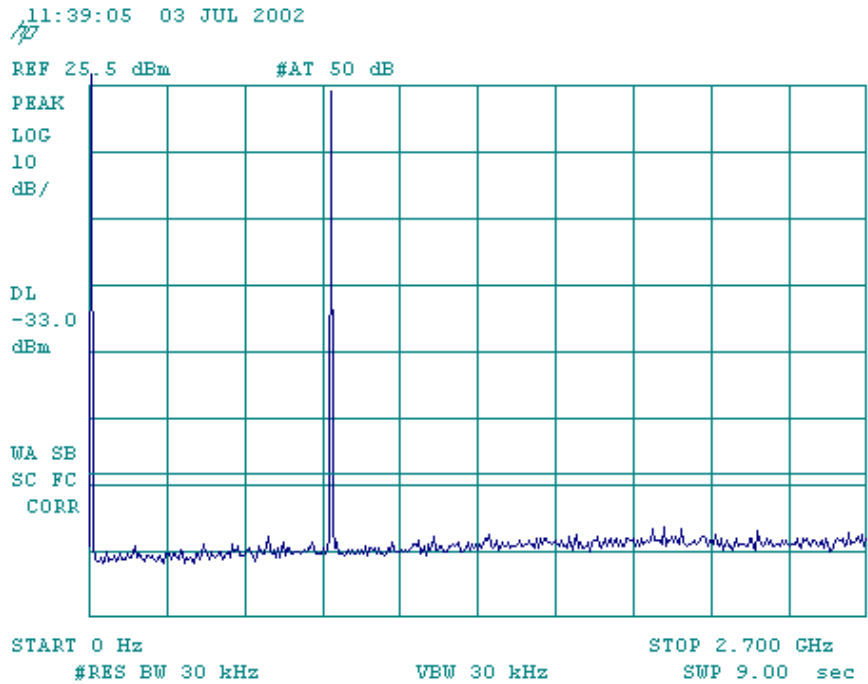

f-3

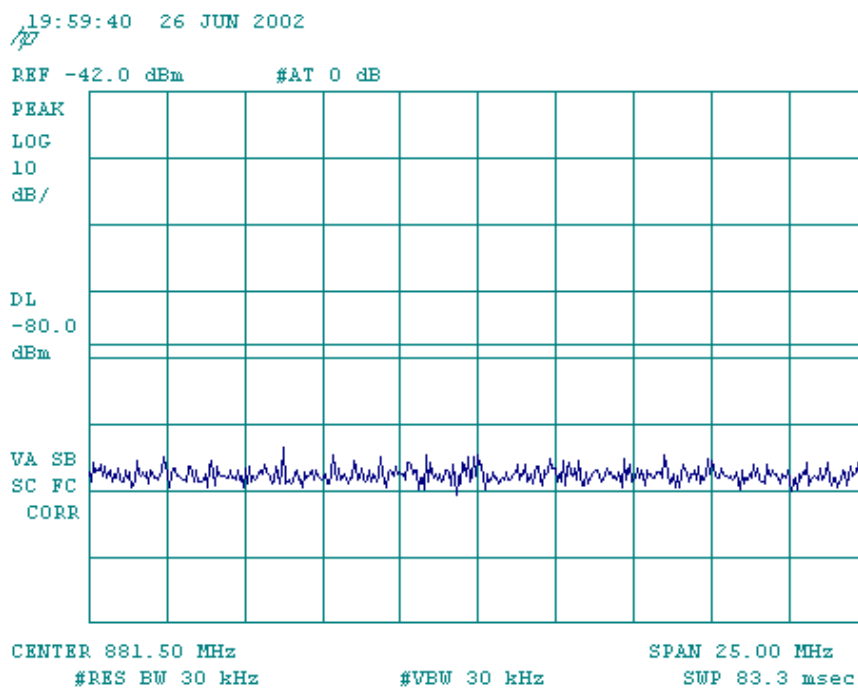

AMPS WIDEBAND

g-1

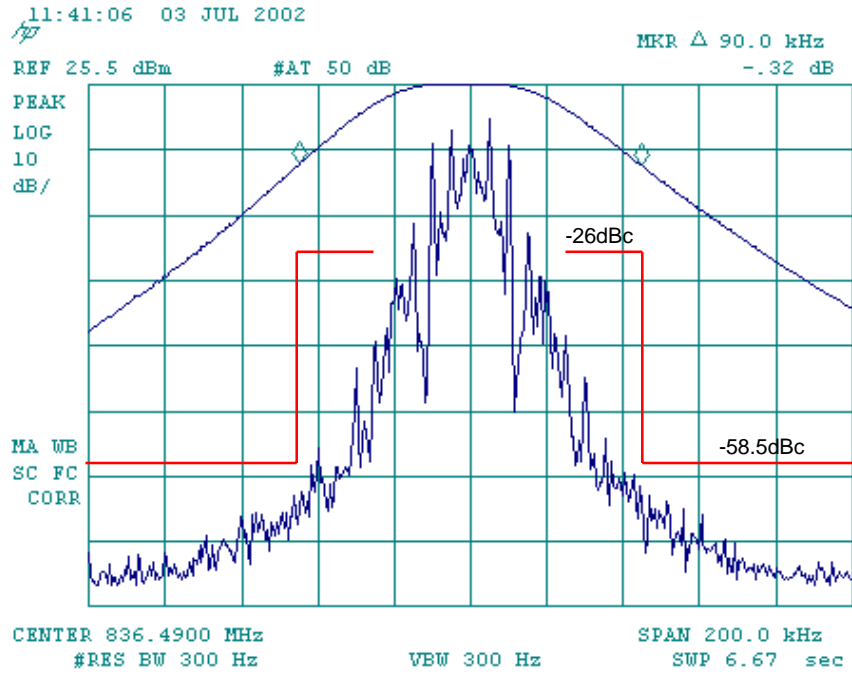

g-2

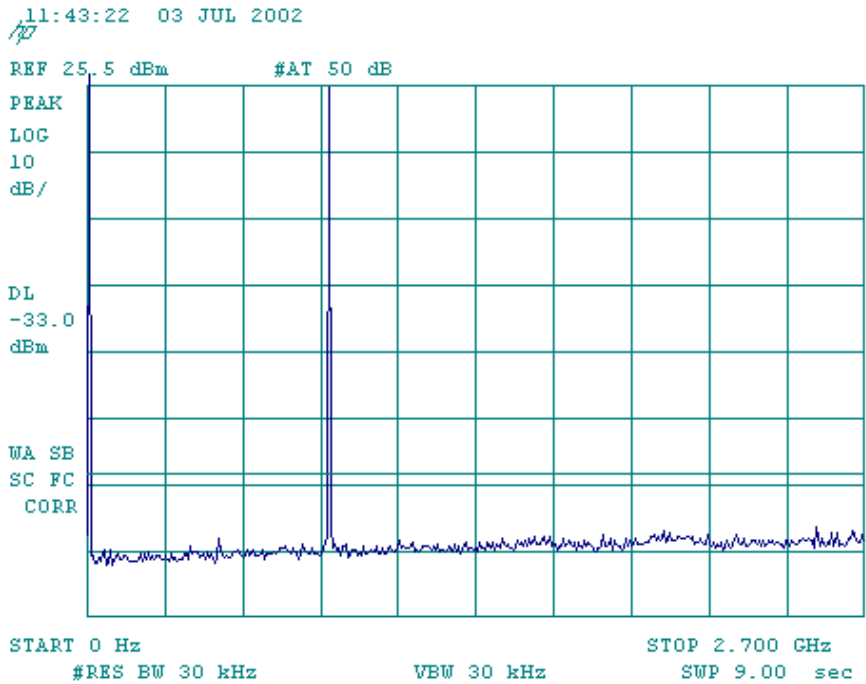

g-3

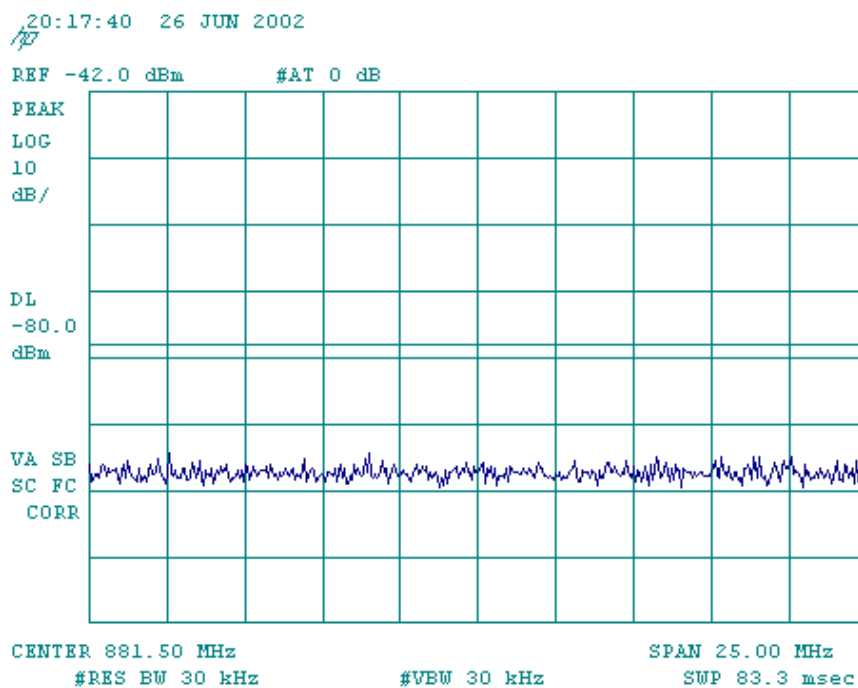

Cellular CDMA at RC1

h-1

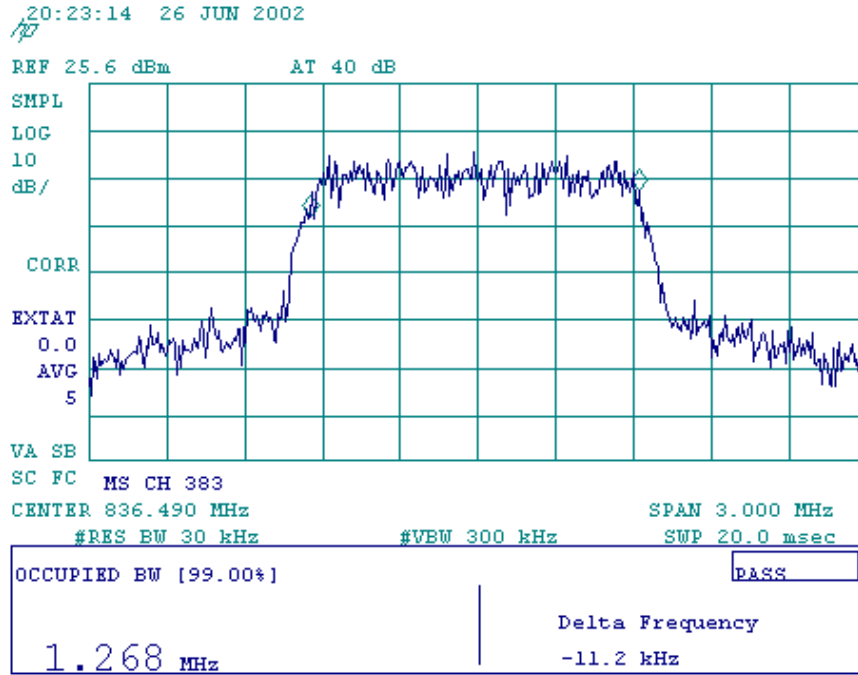

h-2

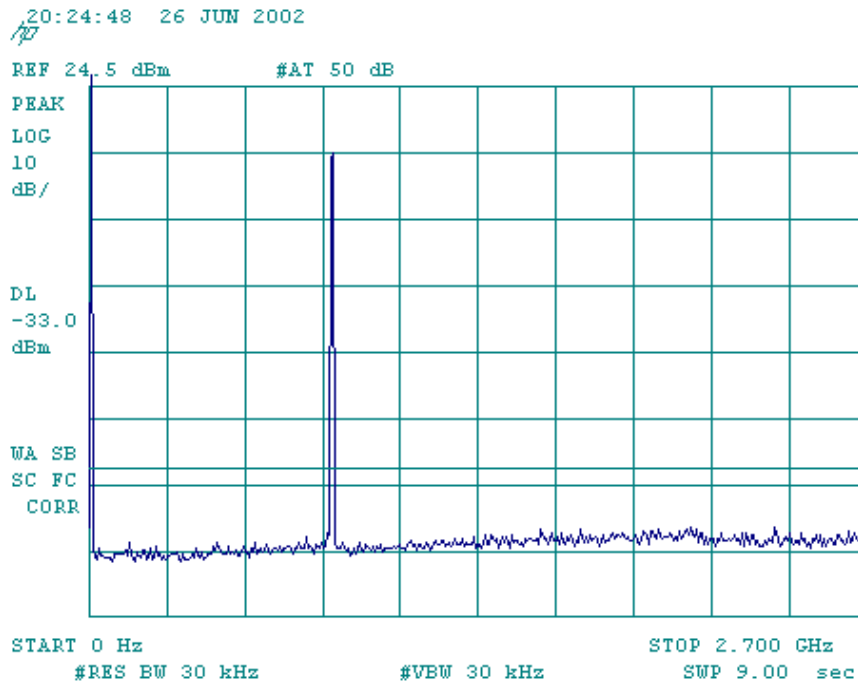

h-3

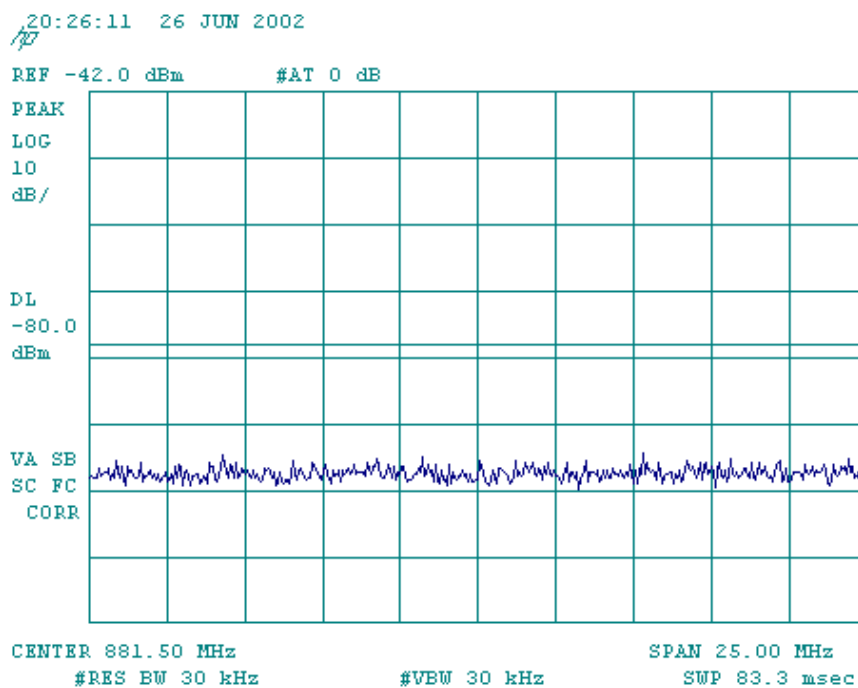
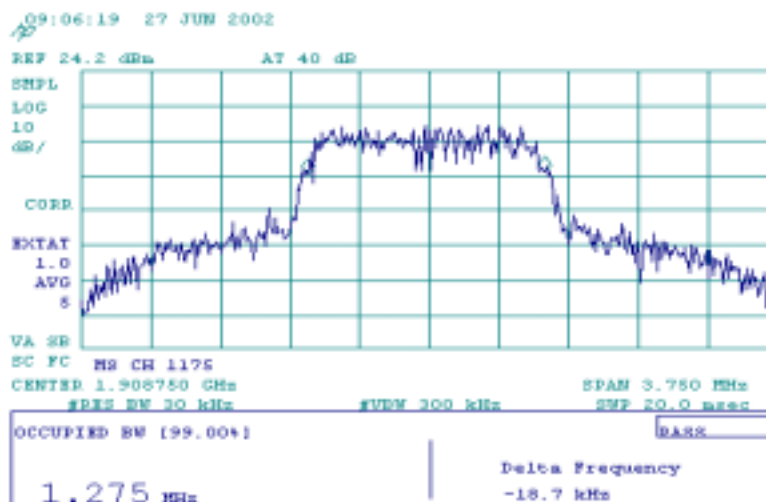
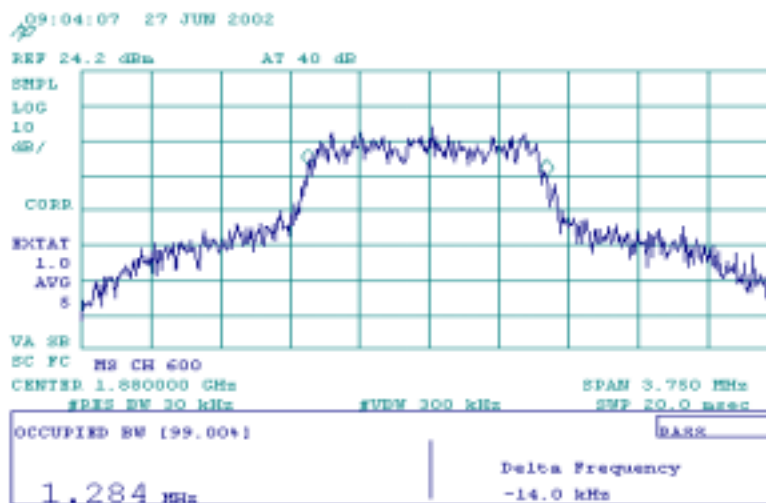
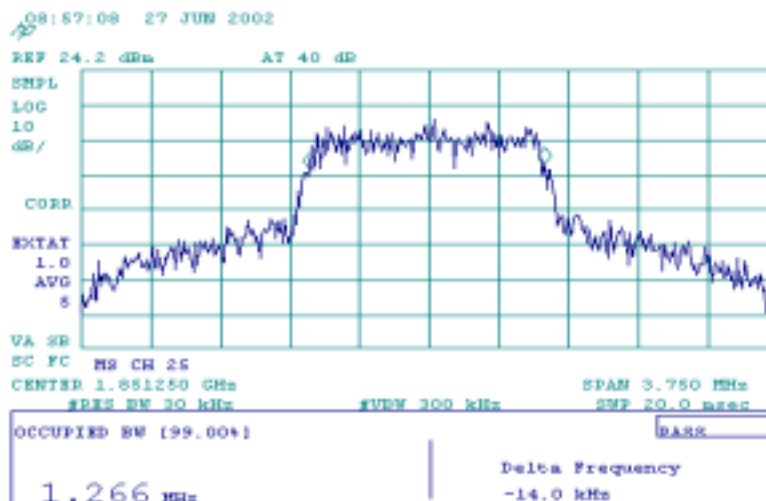

Exhibit 9

Occupied Bandwidth and Spurious Emission Measured Data – FCC Part 2.1049, 24.238

The following data shows compliance for CDMA mode when operating in a P_REV 5 or less network. For CDMA mode when operating in a P_REV 6 or above, see a separate attachment (exhibit 24).

1. Occupied Bandwidth



2. Spurious Emission at Antenna Terminals

Out of Band Spurious Emission Measurement Procedures

(a) 1 MHz band immediately adjacent to the PCS band

We performed a numerical integration of the power as performed by the spectrum analyzer (HP8594E) in the 1 MHz band immediately outside of the PCS block. As specified in Part 24.238 of the rules, we used a Resolution Bandwidth of 1% of the fundamental emission bandwidth, which in this instance equates to the measurement bandwidth of 12.5 kHz.

The ACPR (Adjacent Channel Power Ratio) function of the HP CDMA measurement personality was used on spectrum analyzer, which provides the power integration. The ACPR function and the spectrum analyzer settings used to complete the measurement will be addressed in section (c).

(b) 2nd 1 MHz band adjacent to PCS Block

As specified in Part 24.238 of the rules, the 2nd 1 MHz band outside of the PCS block was measured using a resolution bandwidth of 1 MHz.

The ACPR function of the HP CDMA measurement personality was used to complete the measurement. See section (c) for the ACPR function and the spectrum analyzer settings.

(c) ACPR measurement and spectrum analyzer settings

The ACPR (Adjacent Channel Power Ratio) is the power contained in a specified frequency-channel bandwidth relative to the total carrier power. It can measure up to three pairs of offset channels and relates them to the carrier power. ACPR measurement uses an integration bandwidth method (IBW) to measure the carrier power and the offset powers. IBW method performs a frequency sweep through the bandwidth of integration (set up by the user) using a resolution bandwidth (automatically set) much narrower than the channel bandwidth (e.g. 30 kHz RBW for a channel bandwidth of 1.25 MHz). The measurement computes an average power of the channel over a specified number of sweeps, automatically compensating for noise and scaling.

The following settings were used in the ACPR integration bandwidth method to complete the above measurements (a) and (b). An example to explain the settings is given.

Settings used in ACPR measurement

| | Frequency (Hz) | Offset Limit | IBW (Hz) | Offset Span (Hz) | Comments |
|----------|----------------|---------------------|----------|------------------|---|
| Offset A | ± 885k | n/a | n/a | n/a | not required on a mobile station |
| Offset B | ±1.25625M | -35.0dB (43+10logP) | 12.5k | 25k | setup for 1 MHz band immediately adjacent to PCS band |
| Offset C | ± 2.75M | -35.0dB (43+10logP) | 1M | 2M | setup for 2 nd 1 MHz band adjacent to PCS band |

As an example of channel 25, the center frequency is 1851.25 MHz. The interpretation of the settings in the above table is shown in following drawing.

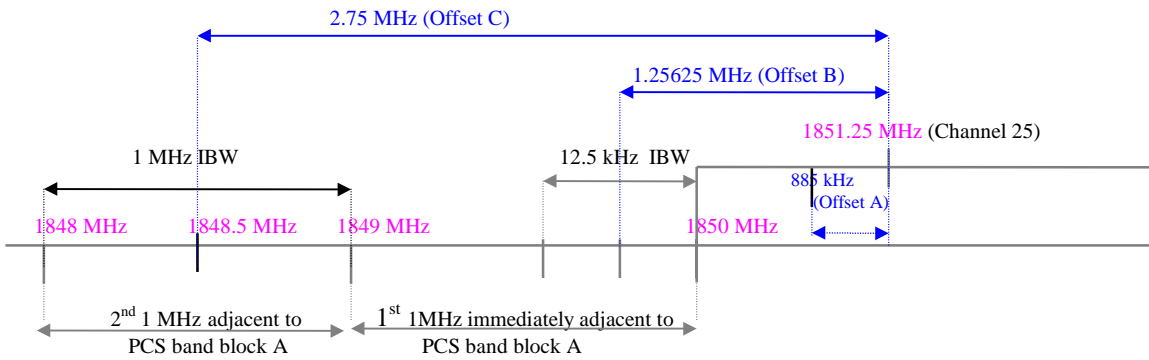

Note: The above drawing is not in scale.

(d) Spurious emission up to 10th harmonic of the transmitting frequency

The harmonic and spurious emissions from 0 Hz to 22 GHz were measured using a RBW of 1 MHz and a VBW of 1 MHz on the spectral analyzer.

Test Results

ACPR measurement (1st and 2nd 1MHz adjacent to PCS)

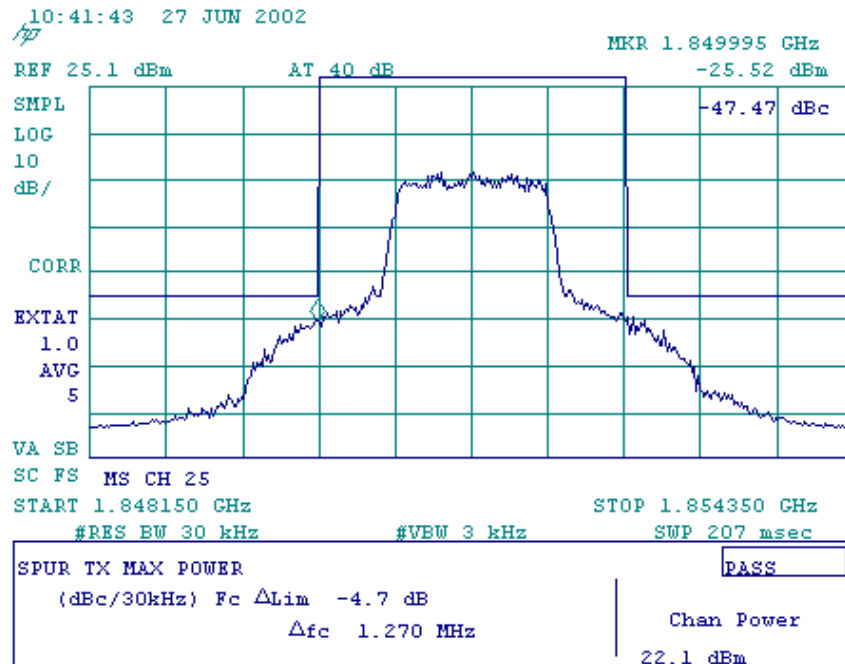
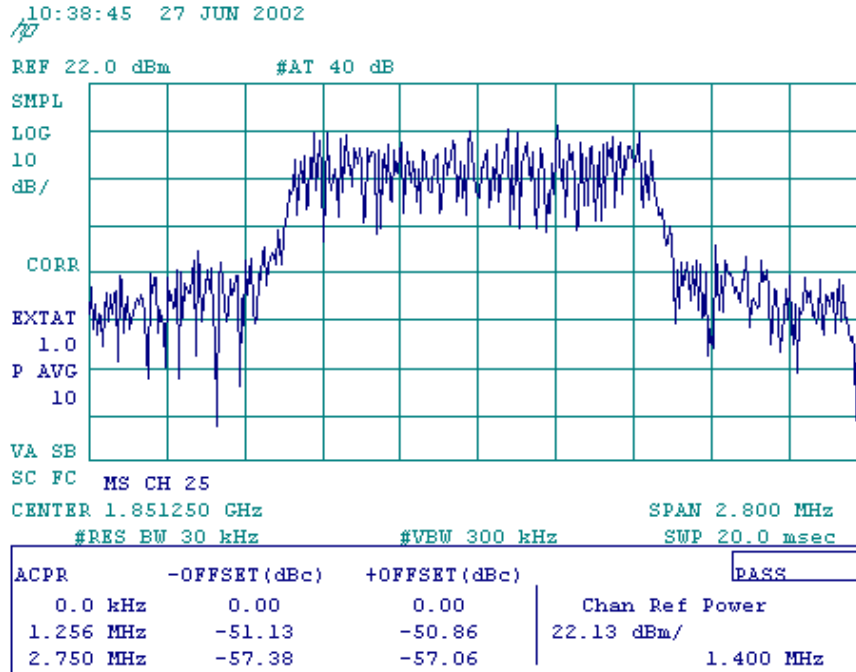

14:17:13 27 JUN 2002

fp

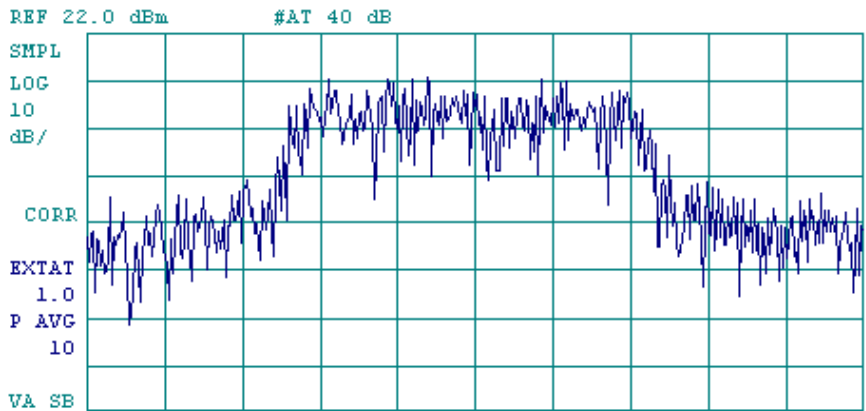

SC FC MS CH 600
CENTER 1.880000 GHz SPAN 2.800 MHz
#RES BW 30 kHz #VBW 300 kHz SWP 20.0 msec

| ACPR | -OFFSET(dBc) | +OFFSET(dBc) | PASS |
|-----------|--------------|--------------|----------------|
| 0.0 kHz | 0.00 | 0.00 | Chan Ref Power |
| 1.256 MHz | -47.46 | -47.19 | 22.05 dBm/ |
| 2.750 MHz | -56.40 | -49.84 | 1.400 MHz |

14:30:15 27 JUN 2002

fp

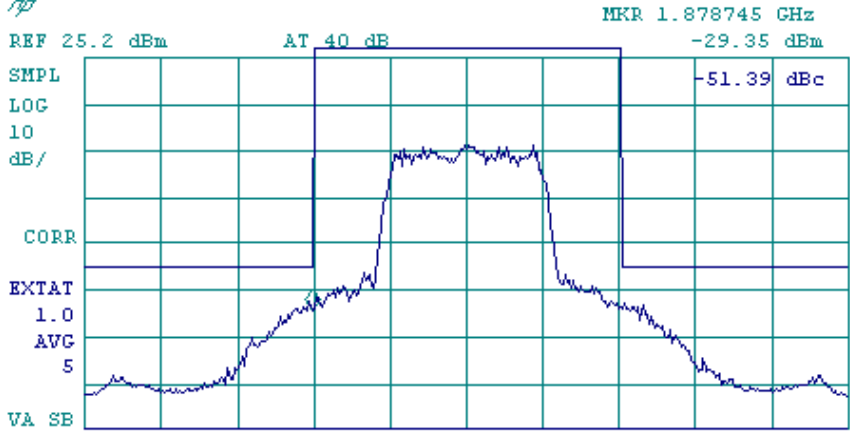

SC FS MS CH 600
START 1.876900 GHz STOP 1.883100 GHz
#RES BW 30 kHz #VBW 3 kHz SWP 207 msec

| SPUR TX MAX POWER | PASS |
|-----------------------------|------------|
| (dBc/30kHz) Fc ΔLim -7.6 dB | Chan Power |
| Δfc -1.290 MHz | 22.2 dBm |

14:55:40 27 JUN 2002

~~17~~

REF 22.0 dBm #AT 40 dB

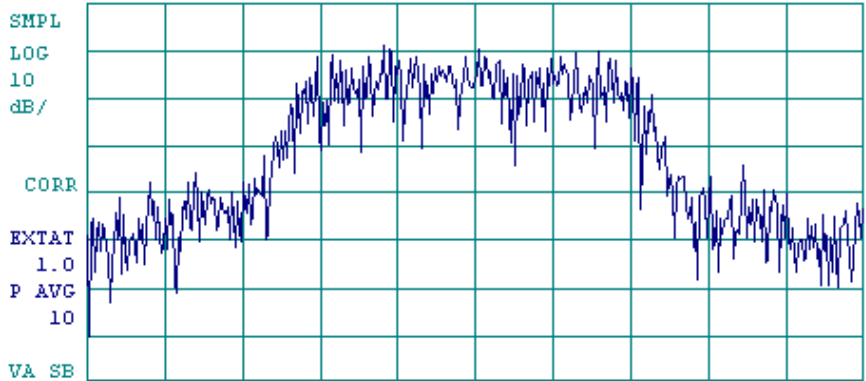

CENTER 1.908750 GHz SPAN 2.800 MHz
 #RES BW 30 kHz #VBW 300 kHz SWP 20.0 msec

| ACPR | -OFFSET(dBc) | +OFFSET(dBc) | PASS |
|-----------|--------------|--------------|----------------|
| 0.0 kHz | 0.00 | 0.00 | Chan Ref Power |
| 1.256 MHz | -50.53 | -51.17 | 21.97 dBm/ |
| 2.750 MHz | -59.05 | -56.25 | 1.400 MHz |

14:57:36 27 JUN 2002

~~17~~

REF 25.2 dBm AT 40 dB MKR 1.910006 GHz -25.84 dBm

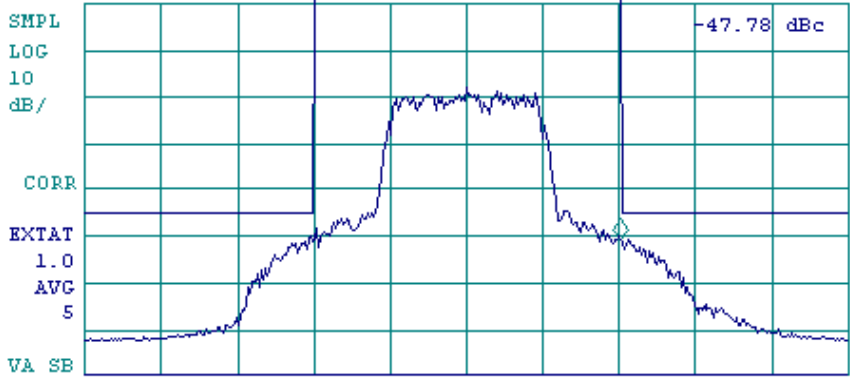

START 1.905650 GHz STOP 1.911850 GHz
 #RES BW 30 kHz #VBW 3 kHz SWP 207 msec

| SPUR TX MAX POWER | PASS |
|-----------------------------|------------|
| (dBc/30kHz) Fc ΔLim -5.1 dB | Chan Power |
| Δfc -1.270 MHz | 22.2 dBm |

Spurious Emission Up to 10th harmonics

Ch25

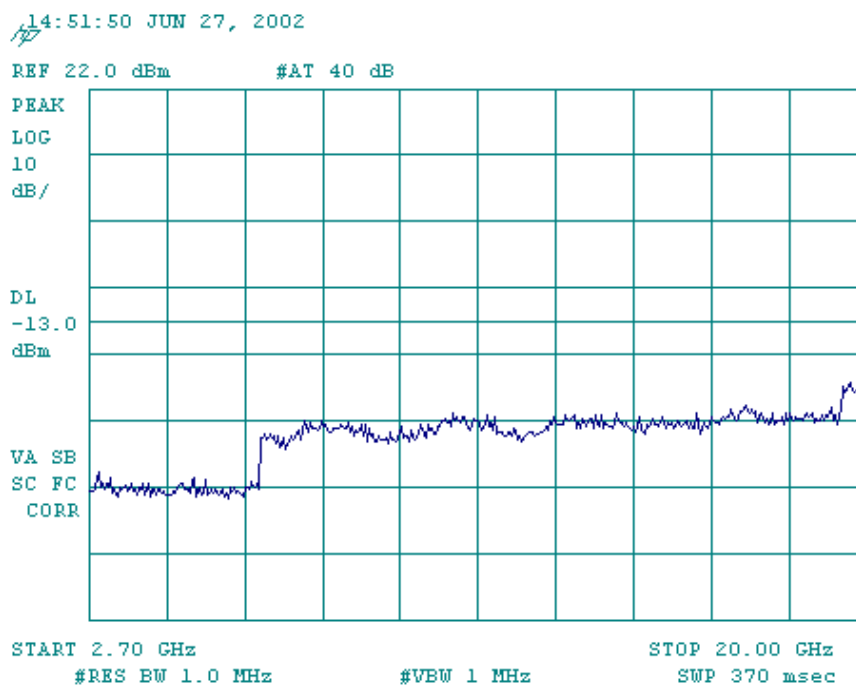
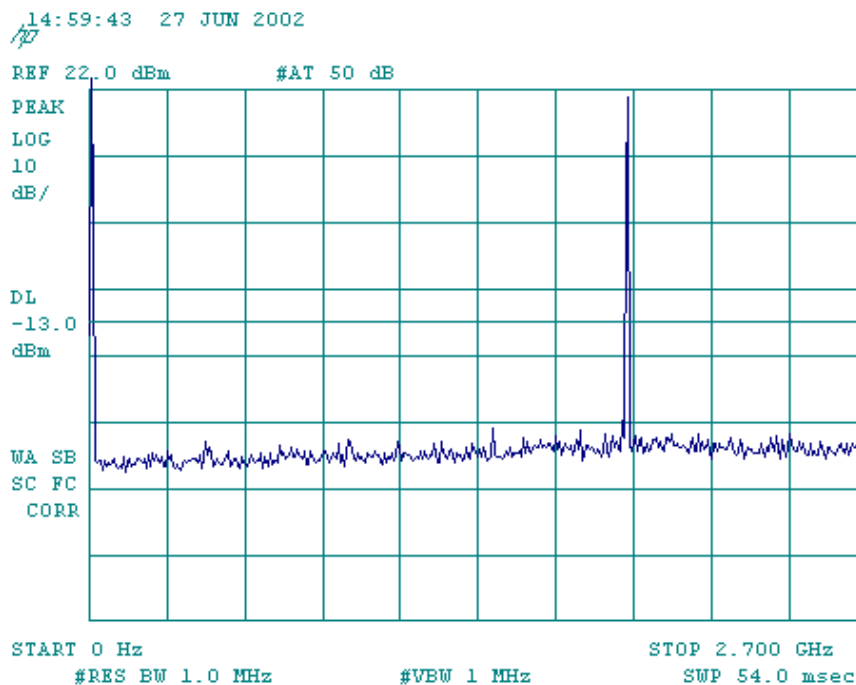

Ch600

15:01:37 27 JUN 2002

~~15~~

REF 22.0 dBm #AT 50 dB

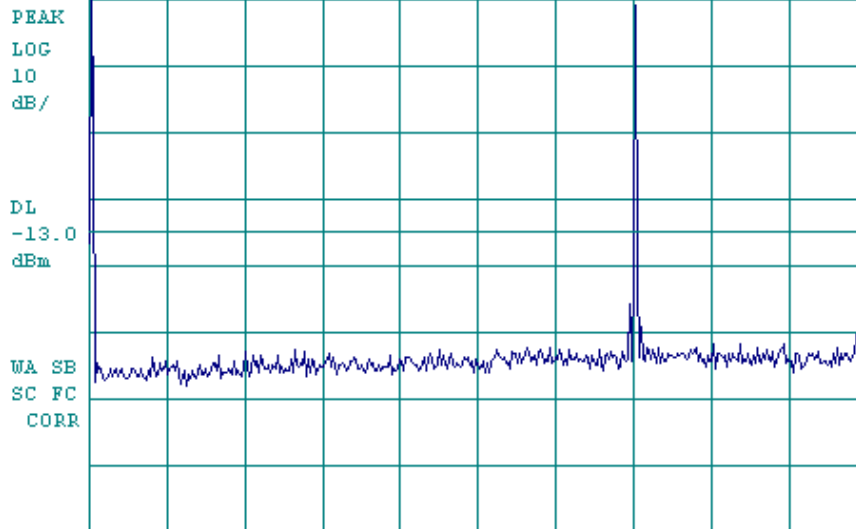

START 0 Hz #RES BW 1.0 MHz #VBW 1 MHz SWP 54.0 msec
STOP 2.700 GHz

14:52:42 JUN 27, 2002

~~14~~

REF 22.0 dBm #AT 40 dB

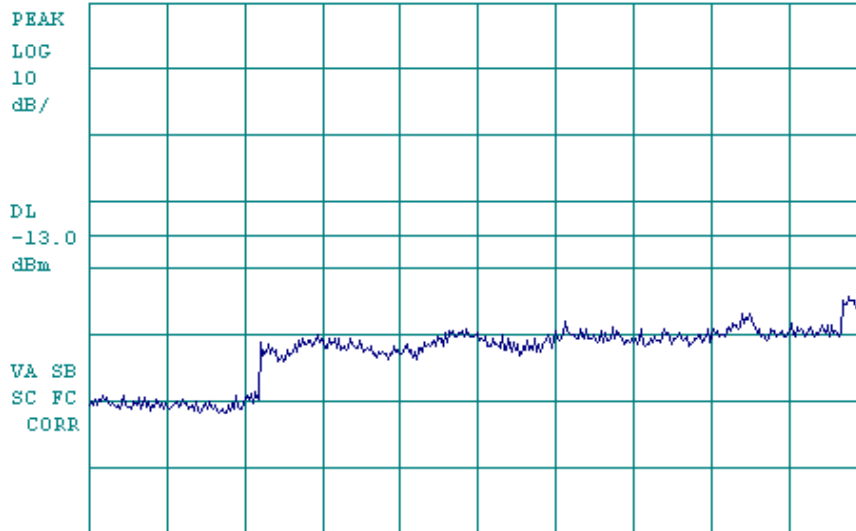

START 2.70 GHz #RES BW 1.0 MHz #VBW 1 MHz SWP 370 msec
STOP 20.00 GHz

Ch1175

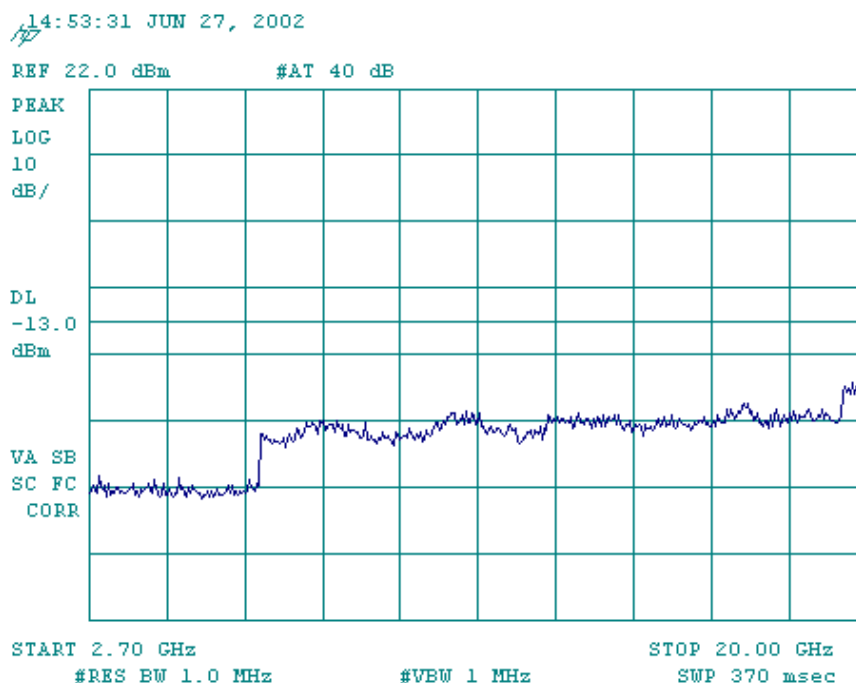
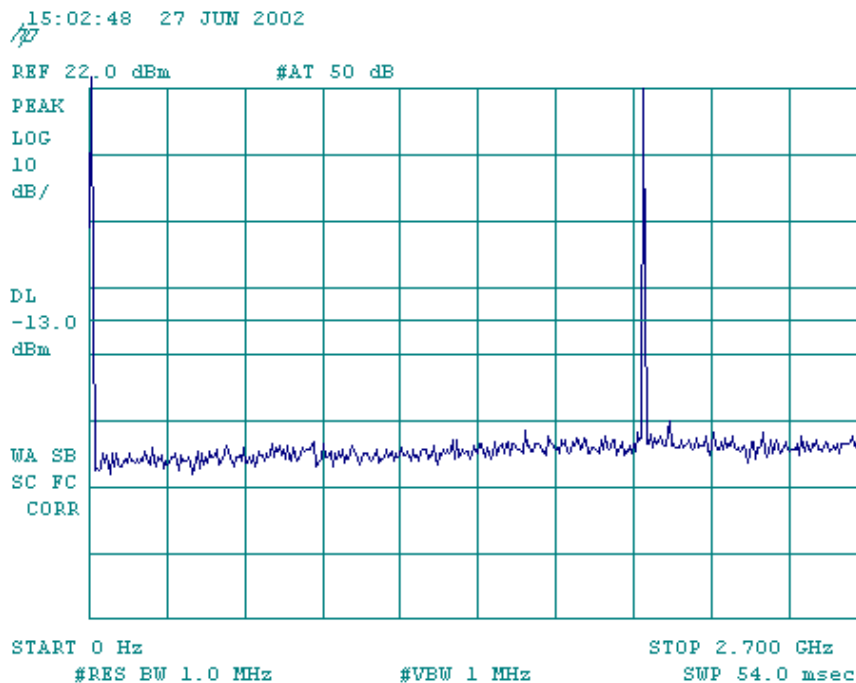

Exhibit 10**Conducted Emissions Test Results (harmonics) - FCC Part 2 and 22, Paragraph 2.1051, 22.917**

6/28/2002

FM High Power

low band – channel 991

| | Frequency (MHz) | Measured Level (dBm) | specification limit (dBm) |
|---------------------------|-----------------|----------------------|---------------------------|
| Fundamental | 824.04 | 25.50 | - |
| 2 nd harmonic | 1648.08 | -27.23 | -13 |
| 3 rd harmonic | 2472.12 | -40.68 | -13 |
| 4 th harmonic | 3296.16 | -67.89 | -13 |
| 5 th harmonic | 4120.2 | -68.90 | -13 |
| 6 th harmonic | 4944.24 | -77.06 | -13 |
| 7 th harmonic | 5768.28 | -78.05 | -13 |
| 8 th harmonic | 6592.32 | -62.46 | -13 |
| 9 th harmonic | 7416.36 | -69.20 | -13 |
| 10 th harmonic | 8240.4 | < -85 | -13 |

mid band – channel 383

| | Frequency (MHz) | Measured Level (dBm) | specification limit (dBm) |
|---------------------------|-----------------|----------------------|---------------------------|
| Fundamental | 836.49 | 25.51 | - |
| 2 nd harmonic | 1672.98 | -34.05 | -13 |
| 3 rd harmonic | 2509.47 | -43.33 | -13 |
| 4 th harmonic | 3345.96 | -72.31 | -13 |
| 5 th harmonic | 4182.45 | -66.10 | -13 |
| 6 th harmonic | 5018.94 | -74.72 | -13 |
| 7 th harmonic | 5855.43 | -79.90 | -13 |
| 8 th harmonic | 6691.92 | -60.03 | -13 |
| 9 th harmonic | 7528.41 | -68.37 | -13 |
| 10 th harmonic | 8364.9 | < -85 | -13 |

high band – channel 799

| | Frequency (MHz) | Measured Level (dBm) | specification limit (dBm) |
|---------------------------|-----------------|----------------------|---------------------------|
| Fundamental | 848.97 | 25.54 | - |
| 2 nd harmonic | 1697.94 | -37.74 | -13 |
| 3 rd harmonic | 2546.91 | -42.25 | -13 |
| 4 th harmonic | 3395.88 | -77.73 | -13 |
| 5 th harmonic | 4244.85 | -79.25 | -13 |
| 6 th harmonic | 5093.82 | -87.05 | -13 |
| 7 th harmonic | 5942.79 | < -85 | -13 |
| 8 th harmonic | 6791.76 | -69.38 | -13 |
| 9 th harmonic | 7640.73 | < -85 | -13 |
| 10 th harmonic | 8489.7 | < -85 | -13 |

CDMA High Power

low band – channel 1013

| | Frequency (MHz) | Measured Level (dBm) | specification limit (dBm) |
|---------------------------|-----------------|----------------------|---------------------------|
| Fundamental | 824.04 | 24.48 | - |
| 2 nd harmonic | 1648.08 | -27.50 | -13 |
| 3 rd harmonic | 2472.12 | -42.78 | -13 |
| 4 th harmonic | 3296.16 | -70.00 | -13 |
| 5 th harmonic | 4120.2 | -68.96 | -13 |
| 6 th harmonic | 4944.24 | -77.98 | -13 |
| 7 th harmonic | 5768.28 | -78.53 | -13 |
| 8 th harmonic | 6592.32 | -62.86 | -13 |
| 9 th harmonic | 7416.36 | -69.31 | -13 |
| 10 th harmonic | 8240.4 | < -85 | -13 |

mid band – channel 383

| | Frequency (MHz) | Measured Level (dBm) | specification limit (dBm) |
|---------------------------|-----------------|----------------------|---------------------------|
| Fundamental | 836.49 | 24.5 | - |
| 2 nd harmonic | 1672.98 | -34.33 | -13 |
| 3 rd harmonic | 2509.47 | -43.75 | -13 |
| 4 th harmonic | 3345.96 | -72.33 | -13 |
| 5 th harmonic | 4182.45 | -66.48 | -13 |
| 6 th harmonic | 5018.94 | -74.23 | -13 |
| 7 th harmonic | 5855.43 | -79.33 | -13 |
| 8 th harmonic | 6691.92 | -60.41 | -13 |
| 9 th harmonic | 7528.41 | -68.79 | -13 |
| 10 th harmonic | 8364.9 | < -85 | -13 |

high band – channel 777

| | Frequency (MHz) | Measured Level (dBm) | specification limit (dBm) |
|---------------------------|-----------------|----------------------|---------------------------|
| Fundamental | 848.31 | 24.53 | - |
| 2 nd harmonic | 1676.62 | -37.22 | -13 |
| 3 rd harmonic | 2514.93 | -42.98 | -13 |
| 4 th harmonic | 3353.24 | -77.00 | -13 |
| 5 th harmonic | 4191.55 | -79.75 | -13 |
| 6 th harmonic | 5029.86 | -68.53 | -13 |
| 7 th harmonic | 5868.17 | < -85 | -13 |
| 8 th harmonic | 6706.48 | -69.41 | -13 |
| 9 th harmonic | 7544.79 | < -85 | -13 |
| 10 th harmonic | 8383.1 | < -85 | -13 |

Exhibit 11**Conducted Emission Test Results (Harmonics) - FCC Part 2 and 24, Paragraph 2.1051,
24.238**

6/28/2002

PCS CDMA High Power

low band – channel 25

| | Frequency (MHz) | Measured Level (dBm) | specification limit (dBm) |
|---------------------------|-----------------|----------------------|---------------------------|
| Fundamental | 1851.25 | 22.13 | - |
| 2 nd harmonic | 3702.5 | -59.98 | -13 |
| 3 rd harmonic | 5553.75 | -49.31 | -13 |
| 4 th harmonic | 7405 | -51.06 | -13 |
| 5 th harmonic | 9256.25 | -68.91 | -13 |
| 6 th harmonic | 11107.5 | -84.25 | -13 |
| 7 th harmonic | 12958.75 | < -85 | -13 |
| 8 th harmonic | 14810 | < -85 | -13 |
| 9 th harmonic | 16661.25 | < -85 | -13 |
| 10 th harmonic | 18512.5 | < -85 | -13 |

mid band – channel 600

| | Frequency (MHz) | Measured Level (dBm) | specification limit (dBm) |
|---------------------------|-----------------|----------------------|---------------------------|
| Fundamental | 1880 | 22.05 | - |
| 2 nd harmonic | 3760 | -60.55 | -13 |
| 3 rd harmonic | 5640 | -69.57 | -13 |
| 4 th harmonic | 7520 | -50.14 | -13 |
| 5 th harmonic | 9400 | -84.10 | -13 |
| 6 th harmonic | 11280 | < -85 | -13 |
| 7 th harmonic | 13160 | < -85 | -13 |
| 8 th harmonic | 15040 | < -85 | -13 |
| 9 th harmonic | 16920 | < -85 | -13 |
| 10 th harmonic | 18800 | < -85 | -13 |

high band – channel 1175

| | Frequency (MHz) | Measured Level (dBm) | specification limit (dBm) |
|---------------------------|-----------------|----------------------|---------------------------|
| Fundamental | 1908.75 | 21.97 | - |
| 2 nd harmonic | 3817.5 | -61.36 | -13 |
| 3 rd harmonic | 5726.25 | -62.95 | -13 |
| 4 th harmonic | 7635 | -44.64 | -13 |
| 5 th harmonic | 9543.75 | < -85 | -13 |
| 6 th harmonic | 11452.5 | < -85 | -13 |
| 7 th harmonic | 13361.25 | < -85 | -13 |
| 8 th harmonic | 15270 | < -85 | -13 |
| 9 th harmonic | 17178.75 | < -85 | -13 |
| 10 th harmonic | 19087.5 | < -85 | -13 |

Exhibit 12

Radiated Spurious Emissions Measured Data - FCC Part 2, Paragraph 2.1053

The radiated spurious emission test was performed at TUV in San Diego, California. The test report is attached in a separate attachment. The test procedures and technique are stated in Exhibit 15.

Exhibit 13

Transmitter RF Carrier Frequency Stability - FCC part 2.1055

Transmitter RF Carrier Frequency Stability - FCC part 2.1055

Phone transmitting in FM mode in cellular band, but with no modulation on the carrier

Measured with HP 8560A Spectrum Analyzer, The test procedures and technique are stated in Exhibit 15.

Carrier Frequency : 836.49 MHz FM

| Temperature (C) | Transmitter Carrier Frequency Deviation (Hz) | | | | | | | Specification | |
|-----------------|--|-------|-------|-------|-------|-------|-------|---------------|-------------|
| | 3.2 V | 3.4 V | 3.6 V | 3.8 V | 4.0 V | 4.1 V | 4.2 V | lower limit | upper limit |
| -30 | -14 | -14 | -14 | -14 | -14 | -14 | -14 | -2091 | 2091 |
| -20 | -10 | -10 | -10 | -10 | -10 | -10 | -10 | -2091 | 2091 |
| -10 | 13 | 13 | 13 | 13 | 13 | 13 | 13 | -2091 | 2091 |
| 0 | -17 | -17 | -17 | -17 | -17 | -17 | -17 | -2091 | 2091 |
| 10 | -17 | -17 | -17 | -17 | -17 | -17 | -17 | -2091 | 2091 |
| 20 | -7 | -3 | -3 | 0 | -7 | -7 | -7 | -2091 | 2091 |
| 30 | -3 | -5 | -3 | -3 | -3 | -3 | -3 | -2091 | 2091 |
| 40 | 1 | 1 | 1 | 1 | 2 | 1 | 2 | -2091 | 2091 |
| 50 | -3 | -1 | -3 | -3 | -2 | -3 | -2 | -2091 | 2091 |
| 60 | -24 | -24 | -24 | -24 | -24 | -24 | -24 | -2091 | 2091 |

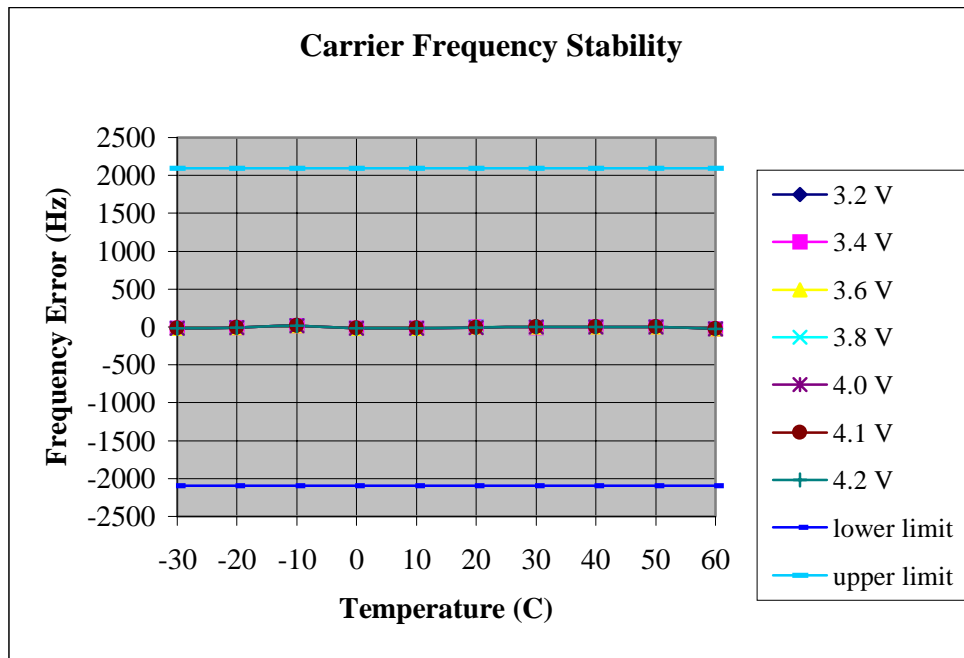

Transmitter RF Carrier Frequency Stability - FCC part 2.1055
Phone transmitting in CDMA mode in cellular band, but with no modulation on the carrier

Measured with HP 8560A Spectrum Analyzer, The test procedures and technique are stated in Exhibit 15.

Carrier Frequency : 836.49 MHz CDMA

| Temperature (C) | Transmitter Carrier Frequency Deviation (Hz) | | | | | | | Specification | |
|-----------------|--|-------|-------|-------|-------|-------|-------|---------------|-------------|
| | 3.2 V | 3.4 V | 3.6 V | 3.8 V | 4.0 V | 4.1 V | 4.2 V | lower limit | upper limit |
| -30 | 164 | 191 | 201 | 201 | 204 | 207 | 214 | -2091 | 2091 |
| -20 | 421 | 447 | 454 | 457 | 454 | 447 | 434 | -2091 | 2091 |
| -10 | 644 | 661 | 657 | 658 | 657 | 667 | 667 | -2091 | 2091 |
| 0 | 557 | 584 | 584 | 584 | 584 | 584 | 590 | -2091 | 2091 |
| 10 | 300 | 324 | 327 | 324 | 320 | 317 | 310 | -2091 | 2091 |
| 20 | -3 | 14 | 14 | 0 | 14 | 20 | 20 | -2091 | 2091 |
| 30 | -86 | -86 | -82 | -76 | -69 | -62 | -49 | -2091 | 2091 |
| 40 | -376 | -346 | -346 | -346 | -352 | -356 | -356 | -2091 | 2091 |
| 50 | -656 | -629 | -626 | -626 | -623 | -619 | -613 | -2091 | 2091 |
| 60 | -579 | -516 | -516 | -516 | -529 | -533 | -536 | -2091 | 2091 |

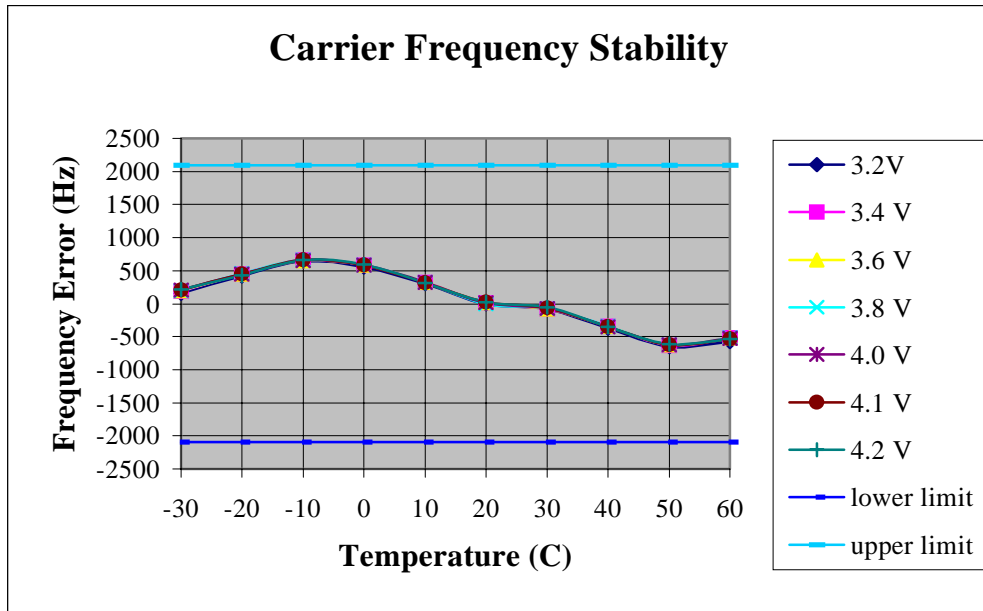

Exhibit 14

Transmitter RF Carrier Frequency Stability - FCC part 2.1055, 24.235

Transmitter RF Carrier Frequency Stability - FCC part 2.1055, 24.235
Phone transmitting in CDMA mode in PCS band, but with no modulation on the carrier

Measured with HP 8560A Spectrum Analyzer, The test procedures and technique are stated in Exhibit 15.

Carrier Frequency : 1880.00 MHz CDMA

| Temperature (C) | Transmitter Carrier Frequency Deviation (Hz) | | | | | | | Specification | |
|-----------------|--|-------|-------|-------|-------|-------|-------|---------------|-------------|
| | 3.2 V | 3.4 V | 3.6 V | 3.8 V | 4.0 V | 4.1 V | 4.2 V | lower limit | upper limit |
| -30 | 596 | 649 | 656 | 652 | 652 | 656 | 626 | -4700 | 4700 |
| -20 | 1189 | 1246 | 1256 | 1262 | 1272 | 1282 | 1282 | -4700 | 4700 |
| -10 | 1636 | 1669 | 1686 | 1689 | 1692 | 1682 | 1679 | -4700 | 4700 |
| 0 | 1579 | 1639 | 1632 | 1632 | 1626 | 1622 | 1616 | -4700 | 4700 |
| 10 | 696 | 750 | 740 | 708 | 694 | 674 | 674 | -4700 | 4700 |
| 20 | 24 | 61 | 45 | 0 | 94 | 99 | 100 | -4700 | 4700 |
| 30 | -184 | -111 | -111 | -104 | -121 | -131 | -137 | -4700 | 4700 |
| 40 | -604 | -544 | -541 | -544 | -541 | -531 | -511 | -4700 | 4700 |
| 50 | -1194 | -1121 | -1145 | -1161 | -1181 | -1198 | -1218 | -4700 | 4700 |
| 60 | -2268 | -2125 | -2128 | -2138 | -2138 | -2135 | -2121 | -4700 | 4700 |

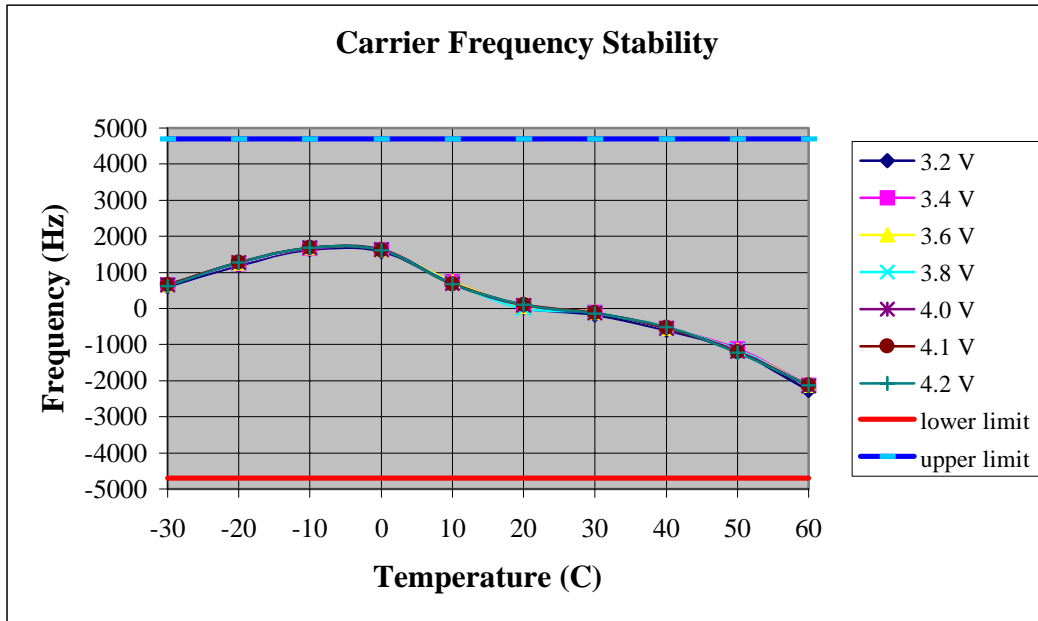

Exhibit 15

Measurement Procedures, Techniques and Minimum Requirements

List of Equipment

Computer with Phone_T software

Spectrum Analyzers

HP 8593EM, CAL DUE 4/15/2003

HP8594E, CAL DUE 03/03/2003

HP 8593EM, Cal due 08-November-2002

Agilent 8960, Cal due 27-June-2003

Audio Spectrum Analyzer

HP3588A, CAL DUE 02/08/2003

Communication Test Set

HP8920B, CAL DUE 12/12/2003

Power Meter

Giga-tronics 8541C, CAL DUE 2/19/2003

DC Power Supply

Measurement Procedures

RF Output Power

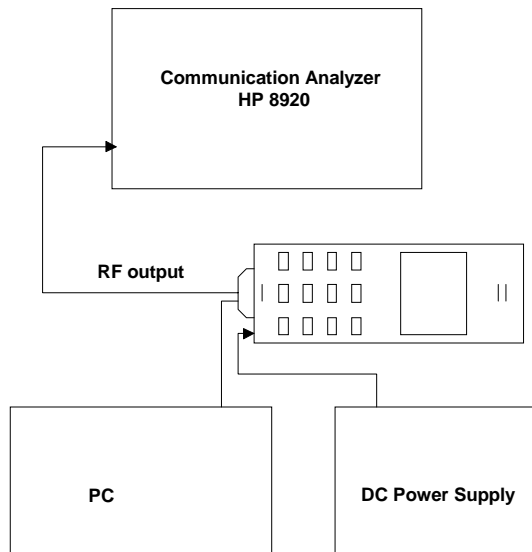

Definition - The output power rating of the transmitter is the power available at the output terminal of the transmitter when the terminal is connected to the normal load.

Method of Measurement - Measure the transmitter output carrier power without modulation using a communication test set for FM which has a RF wattmeter. A HP 8594E spectrum analyzer with the CDMA personality was used to measure CDMA mode.

Minimum Standard - The transmitter output power shall be maintained within +2 / -4 dB.

Modulation Audio Response

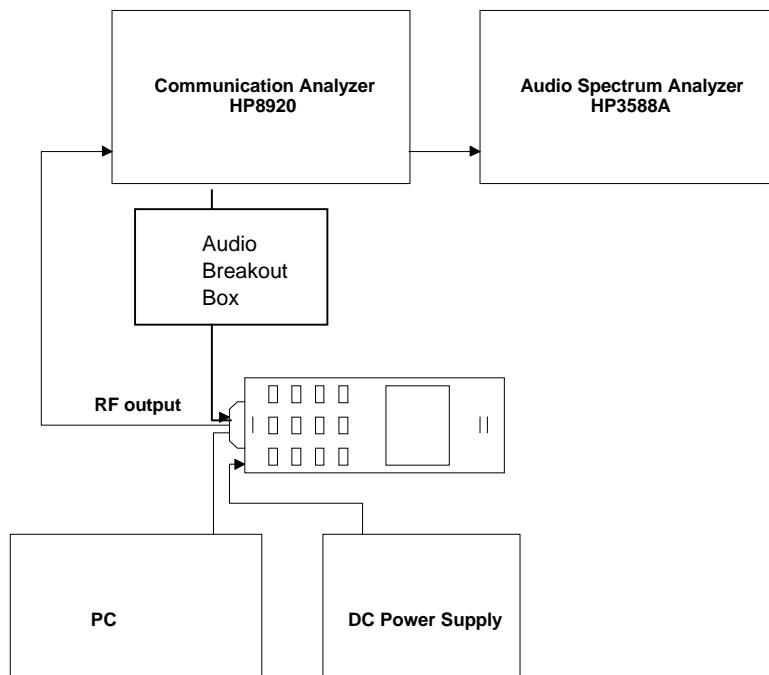

Definition - The transmitter audio frequency response is defined in terms of the degree of closeness with which the frequency deviation of the transmitter follows the prescribed 6 dB/octave pre-emphasis characteristic over a specified continuous audio frequency range while conforming to the required band-limiting conditions outside of that range.

Method of Measurement - Operate the transmitter with the compressor disabled, and monitor the output with HP8920 test receiver without de-emphasis. Apply a sine wave audio input to the transmitter external audio input port, vary the modulating frequency from 100 to 5000 Hz, and observe the input levels necessary to maintain a constant ± 2.9 kHz system deviation. Record the results. Adjust the audio input level to 20 dB greater than that required to produce ± 8 kHz deviation with 1 kHz tone. Vary the modulation frequency from 3 kHz to 30 kHz and observe the deviation while maintaining a constant audio input level. Use the audio spectrum analyzer to measure the output deviation at the same frequency as the input signal.

Minimum Standard - From 300 to 3000 Hz, the audio frequency response shall not vary more than +1 to -3 dB from a true 6 dB/octave pre-emphasis characteristic as referred to the 1000 Hz level (with the exception of a permissible 6 dB/octave roll-off from 2500 to 3000 Hz). Between 3 kHz to 30 kHz, the response shall not exceed that defined by the following table:

| Frequency Range (f in kHz) | Attenuation Relative to 3 kHz (dB) |
|---|------------------------------------|
| $3 \text{ kHz} \leq f \leq 5.9 \text{ kHz}$ | $40 \log (f/3)$ |
| $5.9 \text{ kHz} \leq f \leq 6.1 \text{ kHz}$ | 35 |
| $6.1 \text{ kHz} \leq f \leq 15 \text{ kHz}$ | $40 \log (f/3)$ |
| $15 \text{ kHz} \leq f \leq 30 \text{ kHz}$ | 28 |

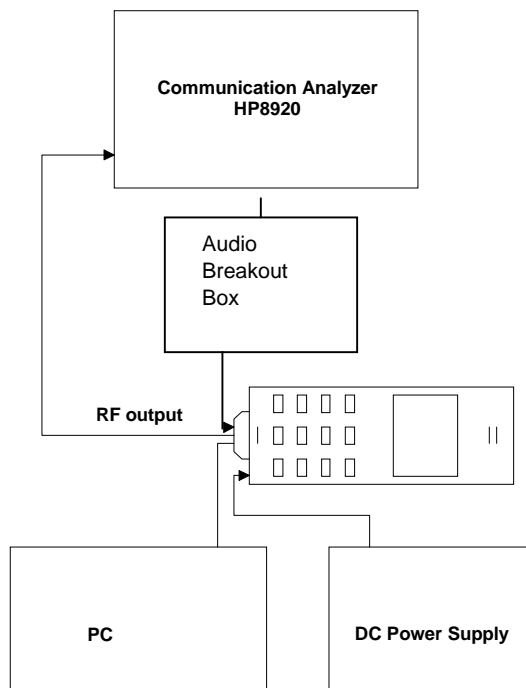
Modulation Limiting

Definition - Modulation limiting refers to the ability of the transmitter circuits to prevent the transmitter from producing deviation in excess of rated system deviation.

Method of Measurement - With the compressor enabled and the SAT disabled, adjust the audio input for ± 8 kHz peak deviation at 1000 Hz. Increase the audio input level by 20 dB. With the input level held constant at the 20 dB, and observe the deviation for 400 Hz, 1000 Hz, and 2.7 kHz.

Minimum Standard - The peak deviation shall not exceed the rated system peak frequency deviation of ± 12 kHz at any time.

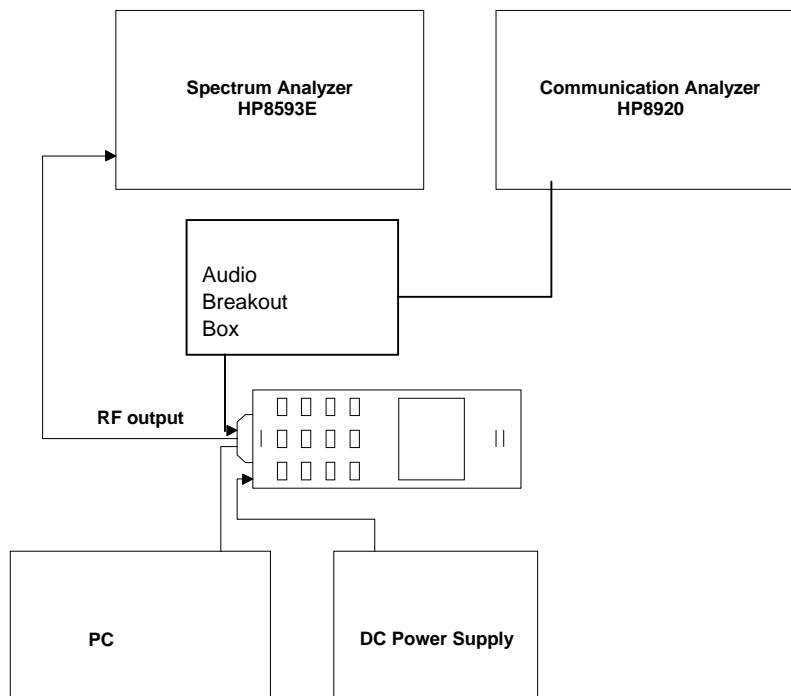
Occupied Bandwidth – (In Cellular Band)

Definition - The occupied bandwidth is defined as the spectrum noise produced at discrete frequency separations from the carrier due to all sources of unwanted noise within the transmitter in a modulated condition.

Method of Measurement - Use the spectrum analyzer and measure the following 8 modulating conditions: (1) For combined voice and SAT, disable the compressor, modulate with a 2500 Hz sine wave 13.5 dB greater than that required to produce ± 8 kHz peak deviation at 1000 Hz and a 6000 Hz SAT with ± 2.0 kHz peak deviation. (2) For combined Signaling Tone and SAT, modulate with a 10 kHz ST with ± 8 kHz peak deviation and a 6000 Hz SAT with ± 2.0 kHz peak deviation. (3) For wideband data, modulate with a quasi-random 10 kbps data pattern with ± 8 kHz peak deviation. (4) For CDMA, modulate with full rate. (4) For voice only, disable the compressor, modulate with a 2500 Hz sine wave 13.5 dB greater than that required to produce ± 8 kHz peak deviation at 1000 Hz. (5) For SAT only, modulate with a 6000 Hz SAT with ± 2.0 kHz peak deviation. (6) For ST only, modulate with a 10 kHz ST with ± 8 kHz peak deviation. (7) For combined SAT and DTMF, modulate with a 6000 Hz SAT with ± 2.0 kHz peak deviation and one of the DTMF tones.

Minimum Standard - The mean power of emissions from the transmitter with modulated carrier shall be attenuated below the mean power of the unmodulated carrier in accordance with the following.

- (1) For all modulation: In a 300 Hz bandwidth centered on any frequency removed from the carrier by greater than 20 kHz up to and including 45 kHz, at least 26 dB.
- (2) For modulation by combined voice and SAT: In a 300 Hz bandwidth centered on any frequency removed from the carrier frequency by greater than 45 kHz, at least $63 + 10 \log$ (mean output power in Watts) dBc. Since the equipment is rated 25.0dBm, the limit is 58.5dBc.
- (3) For modulation by wideband data and combined ST and SAT: In a 300 Hz bandwidth centered on any frequency:

- (a) More than 45 kHz up to and including 90 kHz, at least 45 dBc.
- (b) More than 90 kHz up to the first multiple of the carrier frequency, at least $63 + 10 \log$ (mean power in Watts) dBc.

In addition, in a 30 kHz bandwidth centered anywhere between 869 and 894 MHz, the mean power of emissions from the transmitter with modulated carrier shall not exceed -80 dBm.

Occupied Bandwidth – (In PCS Band)

The procedure has been stated in Exhibit 9

Conducted Spurious and Harmonic Emissions at Antenna Terminal

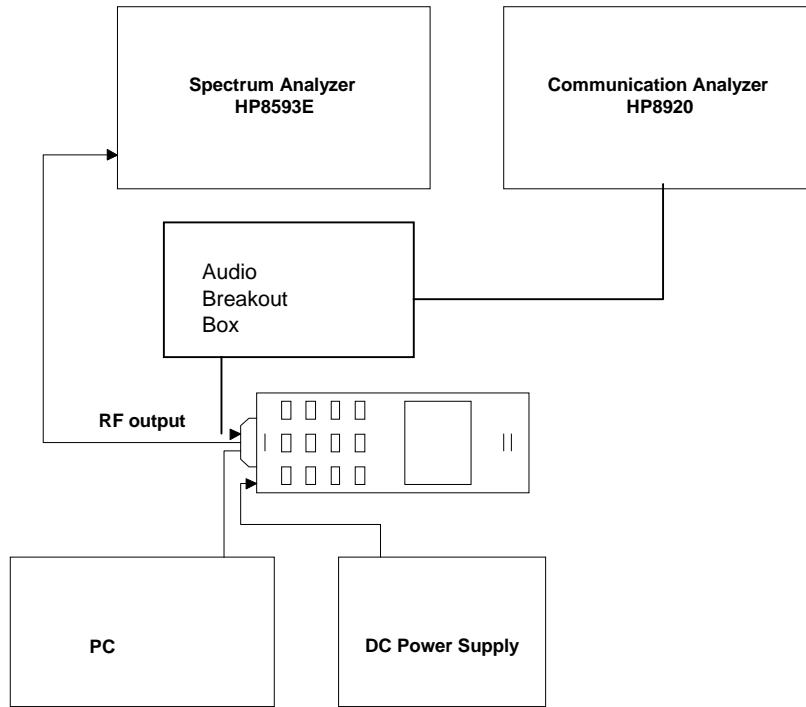

Definition - The conducted harmonic and spurious emissions are emissions at the antenna terminals on a frequency or frequencies that are outside the authorized bandwidth of the transmitter.

Method of Measurement - The transmitter shall be alternately modulated with combined voice and SAT and with wideband data. For combined voice and SAT measurements, disable the compressor, modulate with a 2500 Hz sine wave 13.5 dB greater than that required to produce ± 8 kHz peak deviation at 1000 Hz and a 6000 SAT with ± 2.0 kHz peak deviation. For wideband data measurements, the transmitter shall be modulated with a quasi-random 10 kbps data pattern with ± 8 kHz peak deviation. The measurement shall be made with a spectrum analyzer from the lowest radio frequency generated in the equipment to the 10th harmonic of the carrier except for that region within 75 kHz of the carrier frequency.

Minimum Standard - Conducted harmonic and spurious emissions shall be attenuated below the level of emissions of the carrier frequency by at least $43 + 10 \log$ (mean output power in Watts) dB.

Radiated Spurious and Harmonic Radiation

Definition - The radiated spurious emissions are emissions from the subscriber unit with the attached antenna fully extended. The radiated spurious emissions include those emissions radiated from the attached antenna as well as the equipment cabinet and attached cables.

Method of Measurement - The measurement shall be conducted at standard radiation test site with a search antenna which is movable vertically and is rotatable 90 degrees for vertically and horizontally polarized signals.

Minimum Standard - Radiated spurious emissions shall be attenuated below the maximum level of emission of the carrier frequency by at least $43 + 10 \log$ (mean output power in Watts) dB.

Frequency Stability

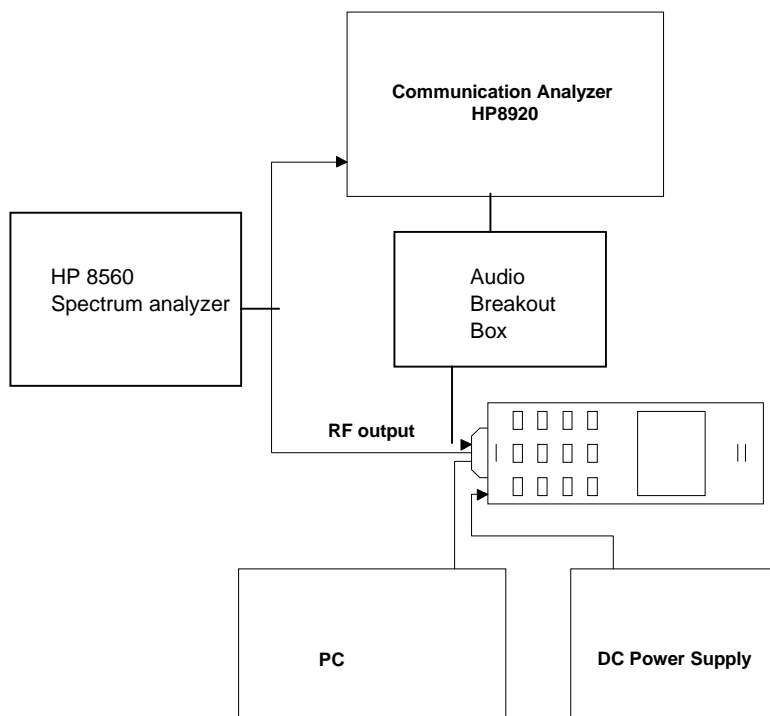

Definition - The frequency stability is the ability of the transmitter to maintain an assigned carrier frequency.

Method of Measurement - Use the communication tester to sample the transmitter RF output signal and measure its frequency. Vary the ambient temperature from -30 to +60 °C, and also vary the DC supply voltage to the equipment from 3.4 to 4.2 V at each temperature.

Minimum Standard - The transmitter carrier frequency shall be maintained within ± 2.5 ppm.

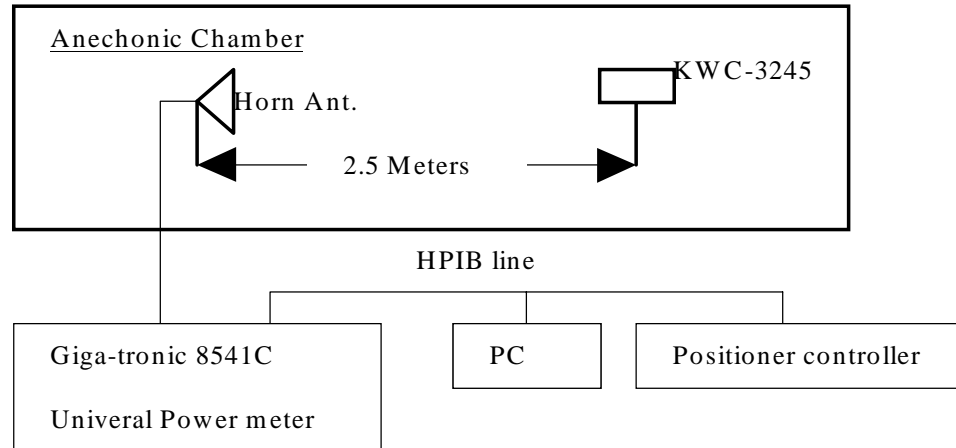
ERP/EIRP measurement**Test Setup –****Measurement Method –**

Set KWC-3245 conducted power level using phone_t software (KWC phone control software), then mount it on PVC pipe inside the chamber, rotate the phone 360degree in azimuth and elevation. The horn antenna receives the handset signal from 2.5 meters away. The computer will record the maximum radiated power taking into consideration of all path losses. The entire measurement is controlled by 959 automated antenna measurement workstation software by Flam & Russel Inc.

Minimum Standard –

The maximum output power in a FM mode in cellular band shall be no more than -2 dBw. The maximum output power in a CDMA mode in cellular band shall be in the range of -7 dBw to 0 dBw. The maximum output power in a CDMA mode in PCS band shall be in the range of -7 dBw to 0 dBw.

Exhibit 16

List of Semiconductor Devices

Included in the part list in separate attachments

Exhibit 17**Product Overview and Circuit Diagrams**

Technical Description

The Trimode Phone consists of an Analog FM mode and Code Division Multiple Access (CDMA) mode in the cellular band, and CDMA mode in the PCS band. The analog transmitter is only for use in the Cellular Radiotelephone Service Part 22 of the CFR. The Portable Phone is designed to meet the requirements of TIA/EIA/IS-98-B&D standards for Dual-Mode Wideband Spread Spectrum Cellular Mobile Stations, and ANSI J-STD_018 standard for 1.8GHz to 2.0GHz Code Division Multiple Access (CDMA) Personal Stations.

Frequency Range of operation: 824 - 849 MHz transmitter and 869 - 894 receiver for cellular band. 1850 – 1910MHz transmitter and 1930 – 1990 receiver for PCS band. Nominal RF power output is: 0.55W for FM (ERP), 0.43W for CDMA in cellular band (ERP) and 0.40W for CDMA in PCS band (EIRP).

Power Supply requirements: 4.2V DC Li-Ion battery.

Modulation:

The audio input is sampled, digitally limited, and then filtered to amplitude and frequency limit the signal applied to the modulator. The device supports the AMPS standard. The device has an operating temperature range of -30 to +60 C. The functions include Compandor, PLL lock detect for received data, audio signal filtering for signals.

Power limiting:

Transmitted power is monitored by a RF detector diode which is coupled from the Power Amplifier (PA) output. The detected DC voltage is fed into a microprocessor which uses a calibration table along with an offset correction and temperature correction table to control power limits. When the RF power exceeds a predetermined limit the gain of the stage preceding the PA is reduced.

Block and Circuit Diagrams

Block and circuit diagrams are included in separate attachments.

Exhibit 18

FCC Identification Label Information

Included in the separate attachment.

Exhibit 19

Photographs

The photographs are in a separate attachment.

Exhibit 20

Users Manuel

The user's guide is in a separate attachment.

Exhibit 21

Statement of SAR compliance and SAR DATA

The statement and SAR data is in a separate attachment.

Exhibit 22

FCC Compliance Emergency 911, FCC Part 22, Paragraph 22.921

When an emergency 911 call is originated by the user, the mobile will attempt to acquire any available system and originate the emergency call on that system, disregarding restrictions set by the roaming list. The FCC NPRM WT99-13, CC94-102 automatic analog A/B roaming option has been implemented for 911 emergency calls. Note that the KWC-3245 has Global Positioning System (GPS) support.

Exhibit 23

TTY compliance, FCC Section 255 of the Telecom Act

KWC 3245 has been designed for TTY Compliance with Cellular Compatibility Standard.

Exhibit 24

Occupied Bandwidth and Spurious Emission Measure data

KWC-3245 supports additional reverse channels, as per IS-98, additional measurement were taken to show compliance. See a separate attachment.