

Cover Letter

Federal Communications Commission
Authorization and Evaluation Division

Re: Application for Cellular and PCS Transceiver Type Acceptance

Kyocera Wireless Corporation (KWC) herein submits the Application for Equipment Authorization (FCC Form 731) and Exhibits for Type Acceptance of a Cellular & PCS Transceiver, FCC ID: OVFKWC-2325.

Applicant: Kyocera Wireless Corporation
10300 Campus Point Drive
San Diego, CA 92121-1522

Manufacture: Kyocera Wireless Corporation
10300 Campus Point Drive
San Diego, California 92121

The equipment, KWC model # KWC-2325, is for mobile station cellular and PCS system use. The KWC-2325 is in full compliance with all parts of EIA/TIA/IS-98-B&D Mobile Station-Land Station Compatibility Specification, issue July 2000 and March 2001, and also in full compliance with all parts of ANSI J-STD-018, Recommended Minimum Performance Requirements for 1.8 to 2 GHz Code Division Multiple Access (CDMA) Personal Stations, issue July 1996. The KWC-2325 has E911 Phase II GPS capability.

Information concerning how the ESN protection requirements are met is provided in Exhibit 3.

Kyocera Wireless Corporation

Lin Lu
EMC Engineer, senior staff

Request of Confidentiality

Federal Communications Commission
Authorization and Evaluation Division

Re: Request of Confidentiality

Pursuant to Sections 0.457 and 0.459 of the Commission's Rules, the Applicant hereby requests confidential treatment of information accompanying this Application as outlined below:

All schematics/block diagrams
All parts lists

The above materials contain trade secrets and proprietary information not customarily released to the public. The public disclosure of these matters might be harmful to the Applicant and provide unjustified benefits to its competitors.

The Applicant understands that pursuant to Rule 0.457, disclosure of this Application and all accompanying documentation will not be made before the date of the Grant for this Application.

Kyocera Wireless Corporation

Lin Lu
EMC Engineer, senior staff

List of Exhibits

<u>Exhibit</u>	<u>Description</u>	<u>FCC Reference</u>
1	Certification of Test Data	2.911
2	General Information	2.1033(c), 2.1061,
3	ESN Protection	22.919
4	RF Output Power Measured Data - Cellular	2.1046
5	RF Output Power Measured Data - PCS	2.1046, 24.232
6	Modulation Audio Response Measured Data	2.1047(a)
7	Modulation Limiting Measured Data	2.1047(b), 22.917
8	Occupied Bandwidth and Spurious Emission Measured Data - Cellular	2.1049, 22.917
9	Occupied Bandwidth and Spurious Emission Measured Data - PCS	2.1049, 24.238
10	Conducted Harmonics Emissions Measured Data - Cellular	2.1051, 22.917, 22.901(d)
11	Conducted Harmonics Emissions Measured Data - PCS	2.1051, 24.238
12	Radiated Spurious and Harmonics Emissions Measured Data	2.1053
13	Frequency Stability vs. Temperature and Voltage Measured Data - Cellular	2.1055
14	Frequency Stability vs. Temperature and Voltage Measured Data - PCS	2.1055, 24.235
15	Measurement Procedures and Techniques	
16	List of Semiconductor Devices	2.1033(c)
17	Circuit Diagram	2.1033(c)
18	Identification (Labels) Information	2.1033(c)
19	Photographs	2.1033(c)
20	User's Manual	2.1033(c)
21	Statement of SAR compliance and SAR test data	2.1093
22	FCC Compliance Emergency 911	22.921
23	FCC TTY Compliance Statement	Section 255
24	Occupied Bandwidth and Spurious Emission Measured Data - CDMA mode when operating in a P-REV 6 or above	2.1049, 22.917, 24.238, IS98D

Exhibit 1

Certification of Test Data

The data, data evaluation and equipment configuration represented herein are a true and accurate representation of the measurements of the sample's radio frequency interference emissions characteristics as of the dates and at the times of the test under the conditions herein specified. This applies to all tests that were performed that did not require an Open Area Test Site (OATS). Tests that required an OATS site were performed by TUV Product Services.

Equipment Tested: KWC-2325

Dates of Test: April 10 – May 18 2002

Test Performed by:

EMC Engineer, Senior Staff: Lin Lu

Exhibit 2

General Information

1. Production Plans

Quantity Production Planned

2. Technical Description - Section 2.1033 (c)

(1) The full name and mailing address of the manufacturer of the device and the applicant

Applicant: Kyocera Wireless Corporation
10300 Campus Point Drive
San Diego, CA 92121

Manufacture: Kyocera Wireless Corporation
10300 Campus Point Drive
San Diego, CA92121

(2) FCC Identifier

FCC ID: OVFKWC-2325

(3) User's Manual

See exhibit 20

(4) Types of Emission

40K0F8W
40K0F1D
1M25F9W

F3E voice
F3D supervisory audio tones, signaling tones
F1D wideband data signal

(5) Frequency range

The frequency range of the equipment in Domestic Public Cellular Radio Telecommunications Service bands, 824 - 849 MHz and 869 - 894 MHz for FM and cellular CDMA. The channel spacing is 30 kHz for FM.

The frequency range of the equipment in the Personal Communications Services (PCS) bands, 1850 – 1910 MHz and 1930 – 1990 MHz. The channel spacing is 1.25 MHz for CDMA.

(6) Operating power levels

The transmitter output power is independent of whether the equipment operates in the cellular system FM or CDMA mode, or PCS system CDMA mode. The equipment supports Class 3 Cellular Mobile Station Power Class, and Class 2 PCS Mobile Station Power Class. Its power output capability is reported to the Land Station via Station Class Mark. The equipment will respond to commands from

the Land Station to change power levels as defined in the EIA/TIA/IS-98 and ANSI J-STD-018 Specification.

(7) Maximum output power

The equipment supports the maximum output power for Class 3 Cellular Mobile Station which is -2 dBW ERP for a FM mode and in the range of -7 dBW to 0 dBW ERP for a CDMA mode, and meets the 7 W ERP (+8.45 dBW) maximum power limitation of Section 22.913.

The equipment supports the maximum output power for Class 2 PCS Mobile Station which is in the range of -7dBW to 0 dBW EIRP, and is within the limited 2 watts E.I.R.P. peak power of CFR 47 Part 24.232 (b). The equipment is able to limit the output power to the minimum necessary for successful communications.

(8) Final RF amplifying device power consumption

The equipment is powered by lithium ion rechargeable batteries which have a voltage range of 3.2 to 4.2 Vdc.

In the Cellular band, the power consumption of the high power amplifier is about 27.8dBm in a CDMA mode and about 28.8dBm in a FM mode. In the PCS band, the power consumption of the high power amplifier is about 26.4dBm.

(9) Tune-up procedure over the power range

All frequency and power adjustments are set at the factory and there are no field adjustments for this product. Under digital mode, the frequency is locked to the base station and controlled by VCTCXO adjustments to offset any possible errors. Note: Digital mode encompasses the mobiles CDMA and FM operation. In CDMA, the carrier frequency error combiner combines the frequency error estimates of all in-lock demodulating fingers, and filters the result. This result drives a PDM circuit, which in turn yields a voltage that corrects the frequency of the VCTCXO. In FM, also referred to as digital FM, the frequency tracking loop circuit calculates the rate of rotation. This rate of rotation corresponds to the frequency error. This frequency error signal is filtered. This result drives a PDM circuit, which in turn yields a voltage that corrects the frequency of the VCTCXO.

(10) Circuit description

(a) Circuit diagram and list of semiconductor device

See exhibit 16 and 17.

(b) Circuit description for frequency determining and stabilizing

The circuit provided for determining and stabilizing frequency is in exhibit 17.

A voltage controlled, temperature compensated, crystal oscillator (VCTCXO) is employed as a frequency reference for all of the transceiver local oscillators. This crystal oscillator is specified to remain within +/- 2.5 ppm over temperature and voltage variations. The lock status indicator of all synthesizers is monitored by the microprocessor and an out of lock condition will inhibit transmission. In all modes, the mobile receiver monitors the received signal and adjusts the frequency of the VCTCXO, this corrects any errors between the mobile frequency and the base station transmitter. The mobile is locked to the base station.

(c) Circuit description for spurious radiation suppression

The circuit provided for suppression of spurious radiation is in exhibit 17.

The transmitter front end provides filtering of the RF signal in order to meet FCC specifications. For radiated spurious suppression, proper design techniques and the use of proper shielding techniques reduced the emission levels well below the permissible FCC limit.

(d) Circuit description for limiting modulation

The circuit provided for limiting modulation is in exhibit 17.

AMPS Mode

The F3E audio modulation is accomplished through the use of Digital Signal Processor (DSP). Audio samples are output from the DFM block at 120Ksps. These samples are converted to 2's complement form, Interpotated to 480Ksps rate , FM modulated, and Interpolated to the VCTCXO rate. The filtering and modulator require the VCTCXO clock along with the different enables, 120KHz, 240KHz, and 480KHz, all of which are generated from the VCTCXO reference.

CDMA Mode when operating in a P_REV 5 or less network

The CDMA mode described in the following pages is from the TIA/EIA/IS-95B Standard. The justification for the CDMA bandwidth of 1.25 MHz is that the chip rate is 1.2288 MHz. The 1.25MHz is measured at the 3dB down bandwidth. Channel spacing is normally set at this 1.25 MHz. In addition the reference baseband filtering requirements are shown in Section 6.1.3.10, Baseband Filtering of IS95B. The filter coefficients for the recommended baseband filter are listed in Table 6.1.3.10-1. These values yield the "necessary bandwidth" of 1.25 MHz based on optimal detection and channel capacity theory.

6.1.3 Modulation Characteristics

6.1.3.1 Reverse CDMA Channel Signals

The Reverse CDMA Channel is composed of Access Channels and Reverse Traffic Channels. These channels shall share the same CDMA frequency assignment using direct-sequence CDMA techniques. Figure 6.1.3.1-1 shows an example of all of the signals received by a base station on the Reverse CDMA Channel. Each Traffic Channel is identified by a distinct user long code sequence; each Access Channel is identified by a distinct Access Channel long code sequence. Multiple Reverse CDMA Channels may be used by a base station in a frequency division multiplexed manner.

The Reverse CDMA Channel has the overall structure shown in Figure 6.1.3.1-2. Data transmitted on the Reverse CDMA Channel is grouped into 20 ms frames. All data transmitted on the Reverse CDMA Channel is convolutionally encoded, block interleaved, modulated by the 64-ary orthogonal modulation, and direct-sequence spread prior to transmission.

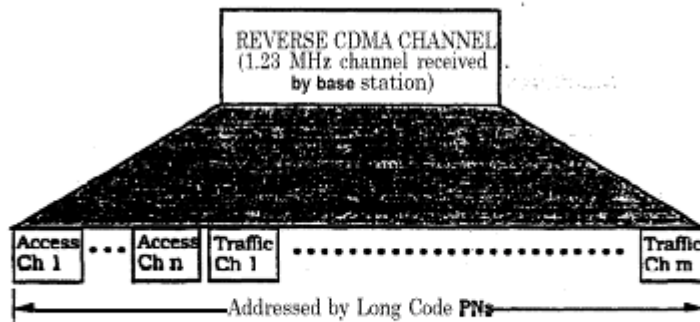

Figure 6.1.3.1-1. Example of Logical Reverse CDMA Channels Received at a Base Station

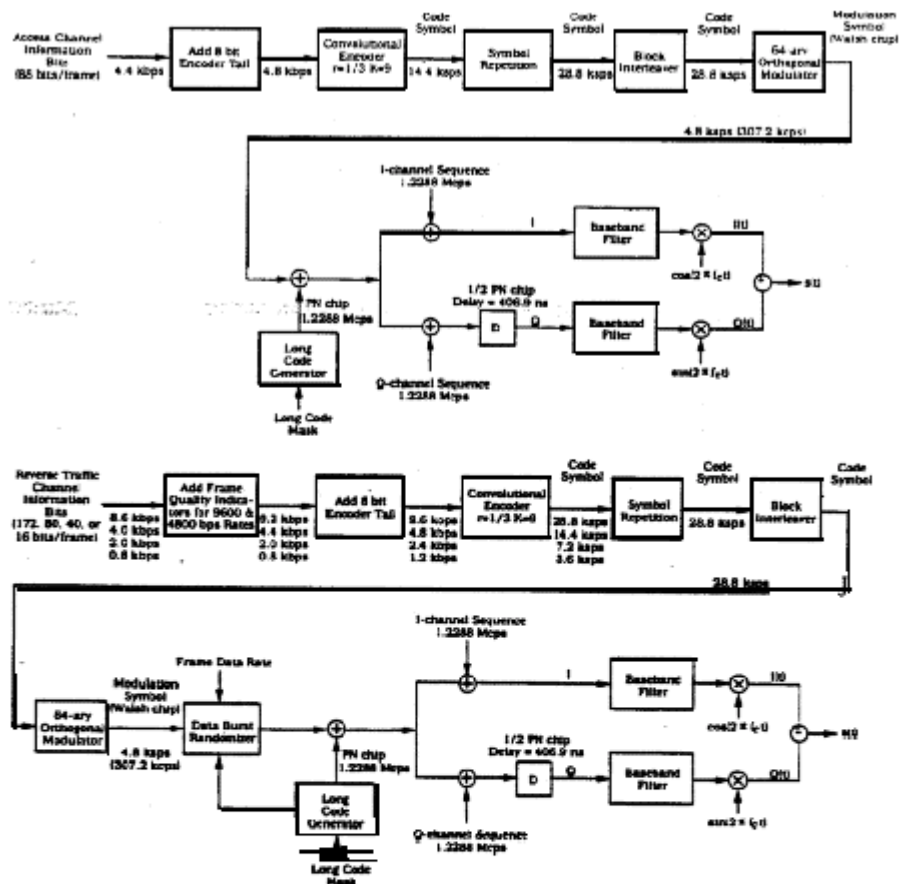

Figure 6.1.3.1-2. Reverse CDMA Channel Structure

After adding frame quality indicators for both the 9600 bps and 4800 bps rates (see 6.1.3.3.2.1) and adding eight Encoder Tail Bits (see 6.1.3.3.2.2), data frames may be transmitted on the Reverse **Traffic** Channel at data rates of 9600, **4800**, **2400**, and 1200 bps. The Reverse **Traffic** Channel may use any of these **data** rates for transmission. The transmission duty cycle on the Reverse Traffic Channel varies with the transmission data rate. Specifically, the transmission duty cycle for 9600 bps frames is 100 percent, the transmission duty cycle for 4800 bps frames is 50 percent, the transmission duty cycle for 2400 bps frames is 25 percent, and the **transmission** duty cycle for 1200 bps frames is 12.5 percent as shown in Table 6.1.3.1.1-1. As the duty cycle for transmission varies **proportionately** with the data rate, the actual burst transmission rate is fixed at 28.800

code symbols per second. Since ~~six~~ code symbols are modulated as one of 64 modulation symbols for transmission, the modulation ~~symbol~~ transmission rate is fixed at 4800 modulation symbols per second. This results in a ~~fixed~~ Walsh chip rate of 307.2 kcps. The rate of the spreading PN sequence is fixed at 1.2288 Mcps, so that each Walsh chip is spread by four PN chips. Table 6.1.3.1.1-1 defines the signal rates and their relationship for the various transmission rates on the Reverse Traffic Channel.

The numerology is identical for the Access Channel except that the transmission rate is ~~fixed~~ at 4800 bps after adding eight Encoder Tail Bits (see 6.1.3.2.2). Each code symbol is repeated once, and the transmission duty cycle is 100 percent. Table 6.1.3.1.1-2 defines the signal rates and their relationship on the Access Channel.

6.1.3.1.1 Modulation Parameters

The modulation parameters for the Reverse Traffic Channel and the Access Channel are shown in Table 6.1.3.1.1-1 and Table 6.1.3.1.1-2, respectively.

Table 6.1.3.1.1-1. Reverse Traffic Channel Modulation Parameters

Parameter	Data Rate (bps)				Units
	9600	4800	2400	1200	
PN Chip Rate	1.2288	1.2288	1.2288	1.2288	Mcps
Code Rate	1/3	1/3	1/3	1/3	bits/code sym
Transmit Duty Cycle	100.0	50.0	25.0	12.5	%
Code Symbol Rate	28,800	28,800	28,800	28,800	sps
Modulation	6	6	6	6	code sym/mod symbol
Modulation Symbol Rate	4800	4800	4800	4800	sps
Walsh Chip Rate	307.20	307.20	307.20	307.20	kcps
Mod Symbol Duration	208.33	208.33	208.33	208.33	μs
PN Chips/Code Symbol	42.67	42.67	42.67	42.67	PN chip/code symbol
PN Chips/Mod symbol	256	256	256	256	PN chip/mod symbol
PN Chips/Walsh Chip	4	4	4	4	PN chips/Walsh chip

CDMA MODE when operating in a P_REV 6 or above Network

The CDMA mode described in the following pages is from IS-2000.2 Standard, Release 0, dated 24-April-2001. This specification is also known by the 3GPP2 Group as : *Physical Layer Standard for cdma2000 Spread Spectrum Systems, 3GPP2 C.S0002-0-2, Version 1.13*. This particular mobile can only invoke a Spreading Rate 1 operational mode. This term, Spreading Rate 1, by definition limits the bandwidth to the same 1.25MHz bandwidth occupied by the legacy IS-95/8-A/B systems. More specifically, Spreading Rate 1 is defined as a 1.2288 Mcps chip rate-based system using a direct-spread single carrier. In addition, the reference baseband filtering requirements are shown in Section 2.1.3.1.13, Baseband Filtering. The associated filter coefficients listed in Table 2.1.3.1.13.1-1 are identical to those listed in IS-95. Thus, for Spreading Rate 1 in IS-2000, the frequency response is identical to the legacy IS-95B system standard, where it was shown that these values yield the “necessary bandwidth” of 1.25 MHz based upon optimal detection and channel capacity theory.

2.1.3 Modulation Characteristics when operating in a P_REV 6 or above Network

The IS2000.2 standard details all of the possible radio configurations, channel types, frame lengths, and encoding schemes, associated with reverse channel for Spreading Rate 1 as well as Spreading Rate 3. As previously stated, the microprocessor resident in the KWC-2325 handset is limited to Spreading Rate 1 chip rates. Furthermore, this microprocessor is also limited to following on the Reverse Link:

- Radio Configurations and Channel Types
- RC3 – RC4 for the Pilot Channel, R-PICH
- RC1 – RC4 for the Fundamental Channel, R-FCH
- RC3-RC4 for the Supplemental Channel, R-SCH
 - RC3 maximum data rate is 153600bps
 - RC4 maximum data rate is 115200bps
- RC1 – RC4 for the Access Channel, R-ACH
- 20msec frames only, (no support for 5msec, 40msec, or 80msec frames)
- Convolutional and Turbo Encoding

To aid in the understanding, of which channels are supported by the microprocessor resident in the KWC-2325, a Figure from IS-2000.2 is presented below. In this Figure, the non-supported items have been crossed out. This clearly demonstrates which types of channels the mobile is not capable of generating on the reverse link.

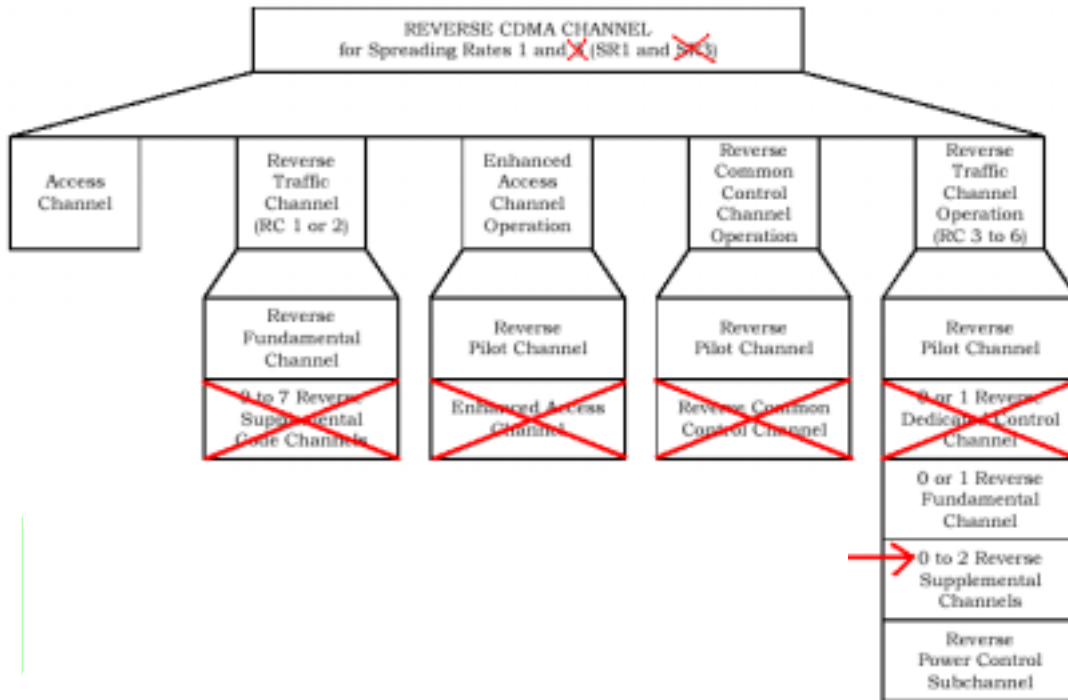
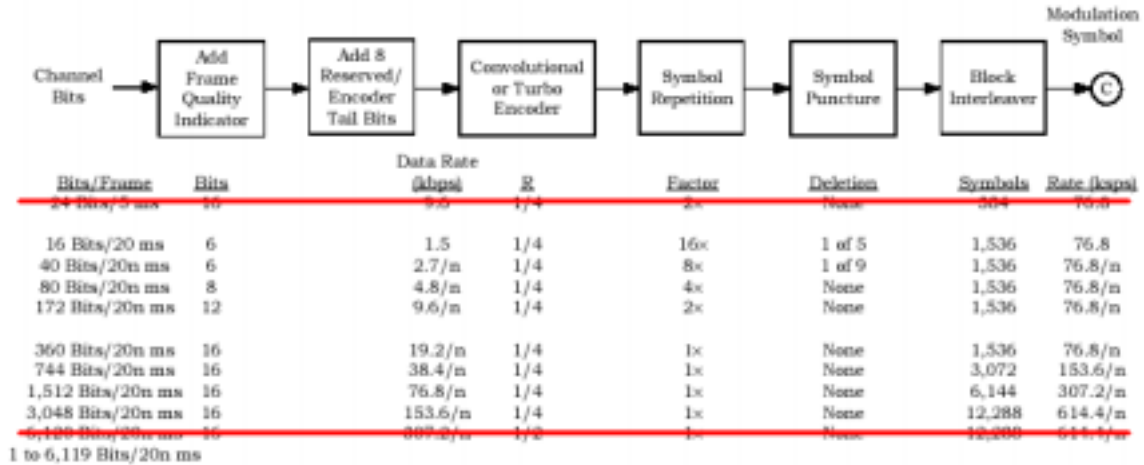

Figure 2.1.3.1.1-1. Reverse CDMA Channels Received at the Base Station

For Radio Configurations 1 and 2, the creation of $s(t)$ nets an identical waveform to the waveform created in the legacy IS-95B system / standard. Thus, backwards compatibility is insured. For Radio Configurations 3 and 4, $s(t)$ differs in a manner that is detailed below. Note, even though the composite waveform differs, the resultant is still based upon Spreading Rate 1 using the direct-sequence CDMA technique. Thus the 3dB bandwidth is still 1.25MHz, and all of the channels share the same CDMA frequency assignment, as in the legacy 95B system.

The following Pictures detailing the RC3 and RC4 Channel creating structures



- Notes:
1. n is the length of the frame in multiples of 20 ms. For 31 to 54 encoder input bits per frame, n = 1, 2, or 4.
 2. ~~The 5 ms frame is only used for the Reverse Fundamental Channel, and the Reverse Fundamental Channel only uses 15 to 192 encoder input bits per frame with n = 1.~~
 3. Turbo coding may be used for the Reverse Supplemental Channels with 384 or more encoder input bits per frame; otherwise, K = 9 convolutional coding is used.
 4. With convolutional coding, the Reserved/Encoder Tail bits provide an encoder tail. With turbo coding, the first two of these bits are reserved bits that are encoded and the last six bits are replaced by an internally generated tail.
 5. If variable-rate Reverse Supplemental Channel operation, flexible reverse link data rates, or both are supported, the parameters are determined from the specified number of channel bits per frame, the maximum assigned number of channel bits per frame for the Reverse Fundamental Channel or the Reverse Supplemental Channel, and the specified frame quality indicator length.
 - The frame quality indicator length is 16 for more than 192 encoder input bits per frame; 12 or 16 for 97 to 192 encoder input bits per frame; 8, 12, or 16 for 55 to 96 encoder input bits per frame; and 6, 8, 12, or 16 otherwise.
 - The code rate is 1/2 for more than 3,072 encoder input bits per frame; otherwise, it is 1/4. If the number of encoder input bits per frame is less than 384, the type of encoding is convolutional; otherwise, it is the same as that of the maximum assigned data rate for the channel.
 - If the specified number of channel bits per frame is equal to the maximum assigned number of channel bits per frame and that number and the specified frame quality indicator length match one of the listed cases, the symbol repetition factor and symbol puncturing from that listed case are used. Otherwise, the symbol repetition factor and puncturing are calculated to achieve the same interleaver block size as for the maximum assigned data rate for the channel.
 - If the maximum assigned data rate matches one of the data rates listed in the figure, the interleaver block size for that listed data rate is used. Otherwise, the interleaver block size of the next higher listed data rate is used.

Figure 2.1.3.1.1.1-8. Reverse Fundamental Channel and Reverse Supplemental Channel Structure for Radio Configuration 3

Note: The OVFKWC-2325 does not support 5msec frames, and it is limited to 153.6kbps on the RL for RC3

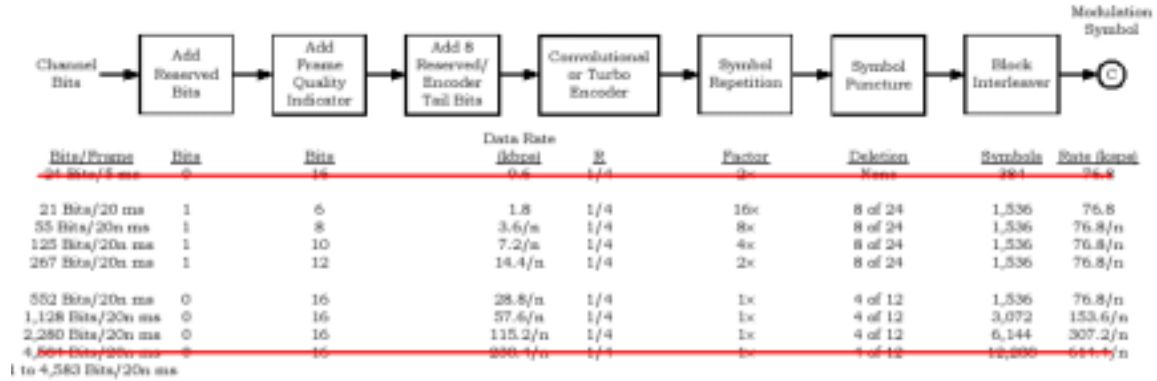

Notes:

- n is the length of the frame in multiples of 20 ms. For 37 to 72 encoder input bits per frame, n = 1 or 2. For more than 72 encoder input bits per frame, n = 1, 2, or 4.
- ~~The 5 ms frame is only used for the Reverse Fundamental Channel, and the Reverse Fundamental Channel only uses 16 to 288 encoder input bits per frame with n = 1.~~
- Turbo coding may be used for the Reverse Supplemental Channels with 576 or more encoder input bits per frame; otherwise, K = 9 convolutional coding is used.
- With convolutional coding, the Reserved/Encoder Tail bits provide an encoder tail. With turbo coding, the first two of these bits are reserved bits that are encoded and the last six bits are replaced by an internally generated tail.
- If variable-rate Reverse Supplemental Channel operation, flexible reverse link data rates, or both are supported, the parameters are determined from the specified number of channel bits per frame, the maximum assigned number of channel bits per frame for the Reverse Fundamental Channel or the Reverse Supplemental Channel, and the specified frame quality indicator length.
 - When the number of channel bits per frame is 21, 55, 125, or 267 and the corresponding number of frame quality indicator bits is 6, 8, 10, and 12, an initial reserved bit is used; otherwise, no initial reserved bits are used.
 - The frame quality indicator length is 16 for more than 288 encoder input bits per frame; 12 or 16 for 145 to 288 encoder input bits per frame; 10, 12, or 16 for 73 to 144 encoder input bits per frame; 8, 10, 12, or 16 for 37 to 72 encoder input bits per frame; and 6, 8, 10, 12, or 16 otherwise.
 - The code rate is 1/4. If the number of encoder input bits per frame is less than 576, the type of encoding is convolutional; otherwise, it is the same as that of the maximum assigned data rate for the channel.
 - If the specified number of channel bits per frame is equal to the maximum assigned number of channel bits per frame and that number and the specified frame quality indicator length match one of the listed cases, the symbol repetition factor and symbol puncturing from that listed case are used. Otherwise, the symbol repetition factor and puncturing are calculated to achieve the same interleaver block size as for the maximum assigned data rate for the channel.
 - If the maximum assigned data rate matches one of the data rates listed in the figure, the interleaver block size for that listed data rate is used. Otherwise, the interleaver block size of the next higher listed data rate is used.

Figure 2.1.3.1.1-9. Reverse Fundamental Channel and Reverse Supplemental Channel Structure for Radio Configuration 4

Note: The OVFKWC-2325 does not support 5msec frames, and it is limited to 115.2kbps on the RL for RC4

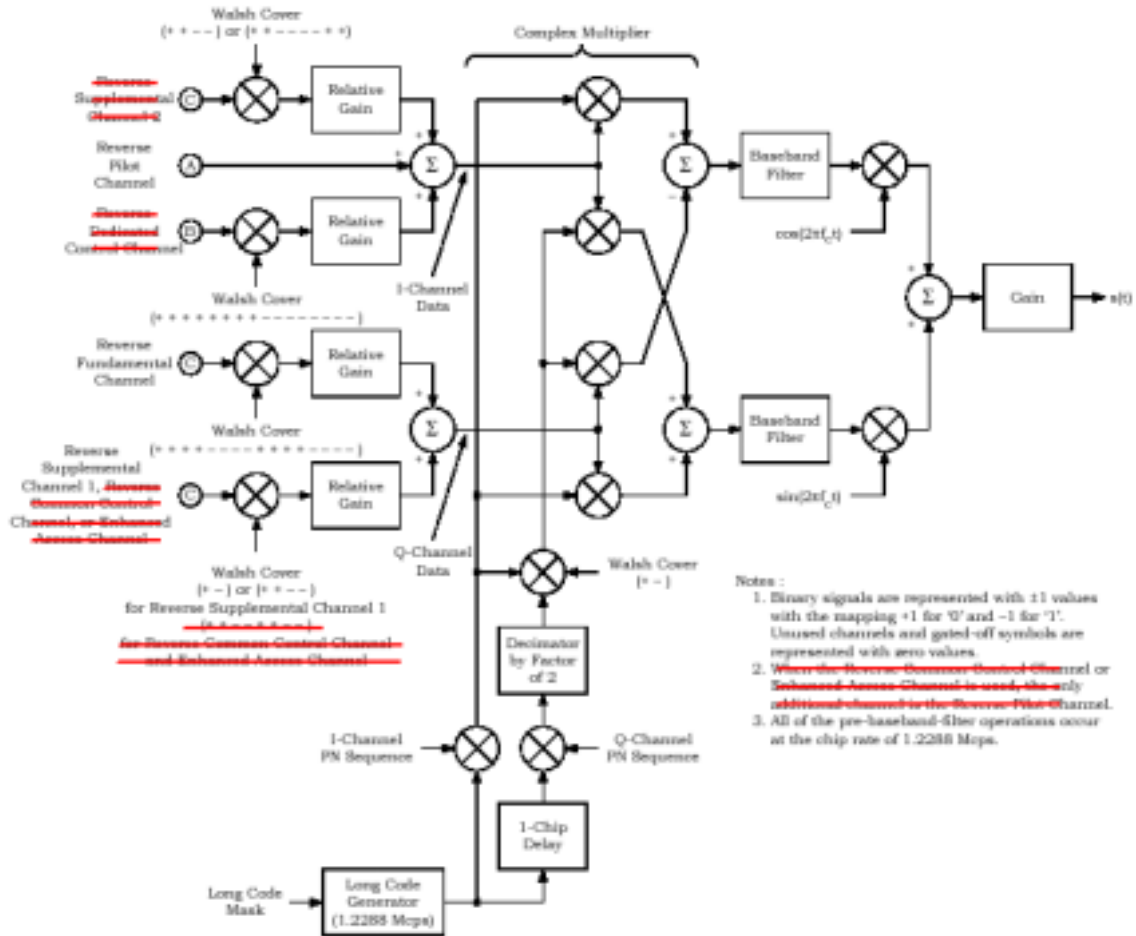

Figure 2.1.3.1.1.1-10. I and Q Mapping for Reverse Pilot Channel, Enhanced Access Channel, Reverse Common Control Channel, and Reverse Traffic Channel with Radio Configurations 3 and 4

Note: The OVFKWC-2325 does R-SCH2, R-DCCH, R-CCCH, or R-EACH

2.1.3.1.2 Modulation Parameters when operating in a P_REV 6 or above Network

The modulation parameters for the Reverse CDMA Channel operating in Spreading Rate 1 are shown in the following Tables. Note, only the Tables supported by the microprocessor contained in the KWC-2325 are provided. Furthermore, within these tables, some additional non-supported items are line-striking to indicate the KWC-2325 Handset does not support.

Table 2.1.3.1.2.1-1. Access Channel Modulation Parameters for Spreading Rate 1

Parameter	Data Rate (bps)	Units
	4,800	
PN Chip Rate	1.2288	Mcps
Code Rate	1/3	bits/code symbol
Code Symbol Repetition	2	repeated code symbols/code symbol
Repeated Code Symbol Rate	28,800	sps
Modulation	6	repeated code symbols/modulation symbol
Modulation Symbol Rate	4800	sps
Walsh Chip Rate	307.20	kcps
Modulation Symbol Duration	208.33	μs
PN Chips/Repeated Code Symbol	42.67	PN chips/repeated code symbol
PN Chips/Modulation Symbol	256	PN chips/modulation symbol
Transmit Duty Cycle	100.0	%
PN Chips/Walsh Chip	4	PN chips/Walsh chip

Table 2.1.3.1.2.1-6. Reverse Fundamental Channel and Reverse Supplemental Code Channel Modulation Parameters for Radio Configuration 1

Parameter	Data Rate (bps)				Units
	9,600	4,800	2,400	1,200	
PN Chip Rate	1.2288	1.2288	1.2288	1.2288	Mcps
Code Rate	1/3	1/3	1/3	1/3	bits/code symbol
Code Symbol Repetition	1	2	4	8	repeated code symbols/code symbol
Repeated Code Symbol Rate	28,800	28,800	28,800	28,800	sps
Modulation	6	6	6	6	repeated code symbols/modulation symbol
Modulation Symbol Rate	4,800	4,800	4,800	4,800	sps
Walsh Chip Rate	307.20	307.20	307.20	307.20	kcps
Modulation Symbol Duration	208.33	208.33	208.33	208.33	μ s
PN Chips/Repeated Code Symbol	42.67	42.67	42.67	42.67	PN chips/repeated code symbol
PN Chips/Modulation Symbol	256	256	256	256	PN chips/modulation symbol
PN Chips/Walsh Chip	4	4	4	4	PN chips/Walsh chip
Transmit Duty Cycle	100.0	50.0	25.0	12.5	%
Processing Gain	128	128	128	128	PN chips/bit

Note: The 1200, 2400, and 4800 bps data rates are applicable to the Reverse Fundamental Channel only.

Table 2.1.3.1.2.1-7. Reverse Fundamental Channel and Reverse Supplemental Code Channel Modulation Parameters for Radio Configuration 2

Parameter	Data Rate (bps)				Units
	14,400	7,200	3,600	1,800	
PN Chip Rate	1.2288	1.2288	1.2288	1.2288	Mcps
Code Rate	1/2	1/2	1/2	1/2	bits/code symbol
Code Symbol Repetition	1	2	4	8	repeated code symbols/code symbol
Repeated Code Symbol Rate	28,800	28,800	28,800	28,800	sps
Modulation	6	6	6	6	repeated code symbols/modulation symbol
Modulation Symbol Rate	4,800	4,800	4,800	4,800	sps
Walsh Chip Rate	307.20	307.20	307.20	307.20	kcps
Modulation Symbol Duration	208.33	208.33	208.33	208.33	μs
PN Chips/Repeated Code Symbol	42.67	42.67	42.67	42.67	PN chips/repeated code symbol
PN Chips/Modulation Symbol	256	256	256	256	PN chips/modulation symbol
PN Chips/Walsh Chip	4	4	4	4	PN chips/Walsh chip
Transmit Duty Cycle	100.0	50.0	25.0	12.5	%
Processing Gain	85.33	85.33	85.33	85.33	PN chips/bit

Note: The 1800, 3600, and 7200 bps data rates are applicable to the Reverse Fundamental Channel only.

Table 2.1.3.1.2.1-8. Reverse Fundamental Channel and Reverse Supplemental Channel Modulation Parameters for 20 ms Frames for Radio Configuration 3

Parameter	Data Rate (bps)				Units
	9,600 × N	4,800	2,700	1,500	
PN Chip Rate	1.2288	1.2288	1.2288	1.2288	Mcps
Code Rate	1/4 (N < 32) 1/2 (N = 32)	1/4	1/4	1/4	bits/code symbol
Code Symbol Repetition	2 (N = 1) 1 (N > 1)	4	8	16	repeated code symbols/code symbol
Puncturing Rate	1	1	8/9	4/5	interleaver symbols/repeated code symbol
Modulation Symbol Rate	76,800 (N ≤ 2) 38,400 × N (N = 4 or 8) 614,400 (N = 16)	76,800	76,800	76,800	sps
Walsh Length	For Reverse Fundamental Channel: 16 For Reverse Supplemental Channel: 8, 4, or 2 (N ≤ 4) 4 or 2 (N = 8) 2 (N ≥ 16)	16 (Reverse Fundamental Channel) 8, 4, or 2 (Reverse Supplemental Channel)			PN chips
Number of Walsh Function Repetitions per Modulation Symbol	For Reverse Fundamental Channel: 1 For Reverse Supplemental Channel: 2, 4, or 8 (N ≤ 2) 1, 2, or 4 (N = 4) 1 or 2 (N = 8) 1 (N ≥ 16)	1 (Reverse Fundamental Channel) 2, 4, or 8 (Reverse Supplemental Channel)			Walsh functions/modulation symbol
Transmit Duty Cycle	100.0	100.0	100.0	100.0 or 50.0	%
Processing Gain	128/N	256	455.1	819.2	PN chips/bit

Note:

1. N = 1, 2, 4, 8, ~~16, or 32~~, which yields data rates of 9600, 19200, 38400, 76800, ~~153600, or 307200~~ bps, respectively.
2. The 50% transmit duty cycle at 1500 bps data rate corresponds to the Reverse Fundamental Channel gating.

Table 2.1.3.1.2.1-11. Reverse Fundamental Channel and Reverse Supplemental Channel Modulation Parameters for 20 ms Frames for Radio Configuration 4

Parameter	Data Rate (bps)				Units
	14,400 × N	7,200	3,600	1,800	
PN Chip Rate	1.2288	1.2288	1.2288	1.2288	Mcps
Code Rate	1/4	1/4	1/4	1/4	bits/code symbol
Code Symbol Repetition	2 (N = 1) 1 (N > 1)	4	8	16	repeated code symbols/code symbol
Puncturing Rate	16/24 (N = 1) 8/12 (N > 1)	16/24	16/24	16/24	interleaver symbols/ repeated code symbol
Modulation Symbol Rate	76,800 (N = 1) 38,400 × N (N ≥ 2)	76,800	76,800	76,800	sps
Walsh Length	For Reverse Fundamental Channel: 16 For Reverse Supplemental Channel: 8, 4, or 2 (N ≤ 4) 4 or 2 (N = 8) 2 (N = 16)	16 (Reverse Fundamental Channel) 8, 4, or 2 (Reverse Supplemental Channel)			PN chips
Number of Walsh Function Repetitions per Modulation Symbol	For Reverse Fundamental Channel: 1 For Reverse Supplemental Channel: 2, 4, or 8 (N ≤ 2) 1, 2, or 4 (N = 4) 1 or 2 (N = 8) 1 (N = 16)	1 (Reverse Fundamental Channel) 2, 4, or 8 (Reverse Supplemental Channel)			Walsh functions/modulation symbol
Transmit Duty Cycle	100.0	100.0	100.0	100.0 or 50.0	%
Processing Gain	85.33/N	170.67	341.33	682.67	PN chips/bit

Notes:

1. N = 1, 2, 4, 8, or 16, which yields data rates of 14400, 28800, 57600, 115200, or ~~230400~~ bps, respectively.
2. If variable-rate Reverse Supplemental Channel operation, flexible reverse link data rates, or both are supported, the parameters are determined from the specified number of channel bits per frame, the maximum assigned number of channel bits per frame for the Reverse Fundamental Channel or the Reverse Supplemental Channel, and the specified frame quality indicator length.
3. The 50% transmit duty cycle at 1800 bps data rate corresponds to the Reverse Fundamental Channel gating.

Note: The OVFKWC-2325 is limited to 115200bps, thus 230400bps has been struck-out above

2.1.3.1.3 Data Rates

The data rates for channels operating with Spreading Rate 1 shall be as specified in Table 2.1.3.1.3-1. Note: Here again the channels, data rates, and frame sizes not supported by the KWC-2325 Handset have been line-striking in the Table 2.1.3.1.3-1

Table 2.1.3.1.3-1. Data Rates for Spreading Rate 1

Channel Type		Data Rates (bps)
Access Channel		4800
Enhanced Access Channel	Header	9600
	Data	38400 (5, 10, or 20 ms frames), 19200 (10 or 20 ms frames), or 9600 (20 ms frames)
Reverse Common Control Channel		38400 (5, 10, or 20 ms frames), 19200 (10 or 20 ms frames), or 9600 (20 ms frames)
Reverse Dedicated Control Channel	RC 3	9600
	RC 4	14400 (20 ms frames) or 9600 (5 ms frames)
Reverse Fundamental Channel	RC 1	9600, 4800, 2400, or 1200
	RC 2	14400, 7200, 3600, or 1800
	RC 3	9600, 4800, 2700, or 1500 (20 ms frames) or 9600 (5 ms frames)
	RC 4	14400, 7200, 3600, or 1800 (20 ms frames) or 9600 (5 ms frames)
Reverse Supplemental Code Channel	RC 1	9600
	RC 2	14400
Reverse Supplemental Channel	RC 3	307200, 153600, 76800, 38400, 19200, 9600, 4800, 4800, 2700, or 1500 (20 ms frames) 153600, 76800, 38400, 19200, 9600, 4800, 2400, or 1200 (40 ms frames) 76800, 38400, 19200, 9600, 4800, 2400, or 1200 (80 ms frames)
	RC 4	230400, 115200, 57600, 28800, 14400, 7200, 3600, or 1800 (20 ms frames) 115200, 57600, 28800, 14400, 7200, 3600, or 1800 (40 ms frames) 57600, 28800, 14400, 7200, 3600, or 1800 (80 ms frames)

Note: The OVFKWC-2325 does not support: R-EACH, R-DCCH, R-CCCH. Nor does it support 5msec, 40msec, or 80msec frames. Additionally, the data rates on the R-SCH are limited to the rates not line-striking above.

(e) Circuit description for limiting power

Transmitted power is monitored by a RF detector diode which is coupled from the Power Amplifier (PA) output. The detected DC voltage is fed into a microprocessor which uses a calibration table along with an offset correction and temperature correction table to control power limits. When the RF power exceeds a predetermined limit the gain of the stage preceding the PA is reduced.

(11) Photograph of the identification label

See Exhibit 18

(12) Photograph to reveal equipment construction and layout

See Exhibit 19

Exhibit 3

ELECTRONIC SERIAL NUMBERS (ESN) Protection

The KWC-2325 Trimode Phone, FCC ID: OVFKWC-2325 uses ESN. The ESN is a unique identification number to each phone which is contained in the Numeric Assignment Module and is automatically transmitted to the base station whenever a call is placed. The ESN is stored in an EPROM and is isolated from fraudulent contact and tampering. Any attempt to change the ESN will render the portable phone inoperative.

The phone complies with all requirements for ESN under Part 22.919.

Exhibit 4**Transmitter RF Power Output - FCC part 2, Paragraph 2.1046**

5/14/2002

Conducted Power --

The RF output power was measured using a Giga-tronics 8541C Universal Power Meter and HP 8594E Spectrum Analyzer that has the CDMA personality option. Terminated to a resistive coaxial load of 50 ohms.

carrier frequency (MHz)	channel	RF output power (dBm) - Cellular	
		Measured	
		FM	CDMA
824.04	991	25.74dBm	
824.7	1013		24.48dBm
836.49	383	25.69dBm	24.50dBm
848.31	777		24.53dBm
848.97	799	25.70dBm	

Radiated Power --

The RF output power (ERP) was measured in the antenna range (anechonic chamber). The test procedures and technique are stated in Exhibit 15.

carrier frequency (MHz)	channel	RF output power ERP (dBm) – Cellular	
		Measured	
		FM	CDMA
824.04	991	26.37 dBm	
824.7	1013		25.17 dBm
836.49	383	26.07 dBm	24.87 dBm
848.31	777		25.61 dBm
848.97	799	26.81 dBm	

Exhibit 5**Transmitter RF Power Output - FCC part 24, Paragraph 2.1046, 24.232 (b)**

5/16/2002

Conducted power --

The RF output power was measured using a HP 8594 Spectrum Analyzer that has the CDMA personality option. Terminated to a resistive coaxial load of 50 ohms.

carrier frequency (MHz)	channel	RF output power (dBm) - PCS	
		CDMA	
		measured	
1851.25	25	22.46dBm	
1880	600	22.48dBm	
1908.75	1175	22.54dBm	

Radiated power --

The RF output power (EIRP) was measured in the antenna range (anechonic chamber). The test procedures and technique are stated in Exhibit 15.

carrier frequency (MHz)	channel	RF output power EIRP (dBm) - PCS	
		CDMA	
		measured	
1851.25	25	25.37 dBm	
1880	600	25.70 dBm	
1908.75	1175	26.20 dBm	

Exhibit 6**Transmitter Modulation Requirement - FCC part 2, Paragraph 2.1047 (a), FCC part 22, Paragraph 22.917**

Measured with HP8920 RF communication test set & HP 3588A spectrum analyzer. The test procedures and technique are stated in Exhibit 15.

Audio Frequency Response (<3 kHz)

	audio freq (Hz)	audio level (mV)	dB relative to 1 kHz	lower limit	upper limit
1	100	937	-34.23	-23.00	-19.00
2	126	744	-32.23	-20.99	-16.99
3	158	326	-25.06	-19.03	-15.03
4	200	140	-17.72	-16.98	-12.98
5	251	93.9	-14.25	-15.01	-11.01
6	300	73	-12.07	-13.46	-9.46
7	316	67.1	-11.33	-13.01	-9.01
8	398	49.8	-8.74	-11.00	-7.00
9	501	38.1	-6.42	-9.00	-5.00
10	631	29.6	-4.22	-7.00	-3.00
11	794	22.9	-2.00	-5.00	-1.00
12	1000	18.2	0.00	-3.00	1.00
13	1259	14	2.28	-1.00	3.00
14	1585	11.2	4.22	1.00	5.00
15	1995	8.7	6.41	3.00	7.00
16	2512	7.26	7.98	5.00	9.00
17	2700	7.24	8.01	5.63	9.63
18	2800	7.24	8.01	5.94	9.94
19	3000	7.96	7.18	6.54	10.54
20	3100	8.86	6.25	6.83	10.83
21	3200	10.7	4.61	7.10	11.10
22	3300	13.2	2.79	7.37	11.37
23	3500	38.2	-6.44	7.88	11.88
24	3700	37.8	-6.35	8.36	12.36

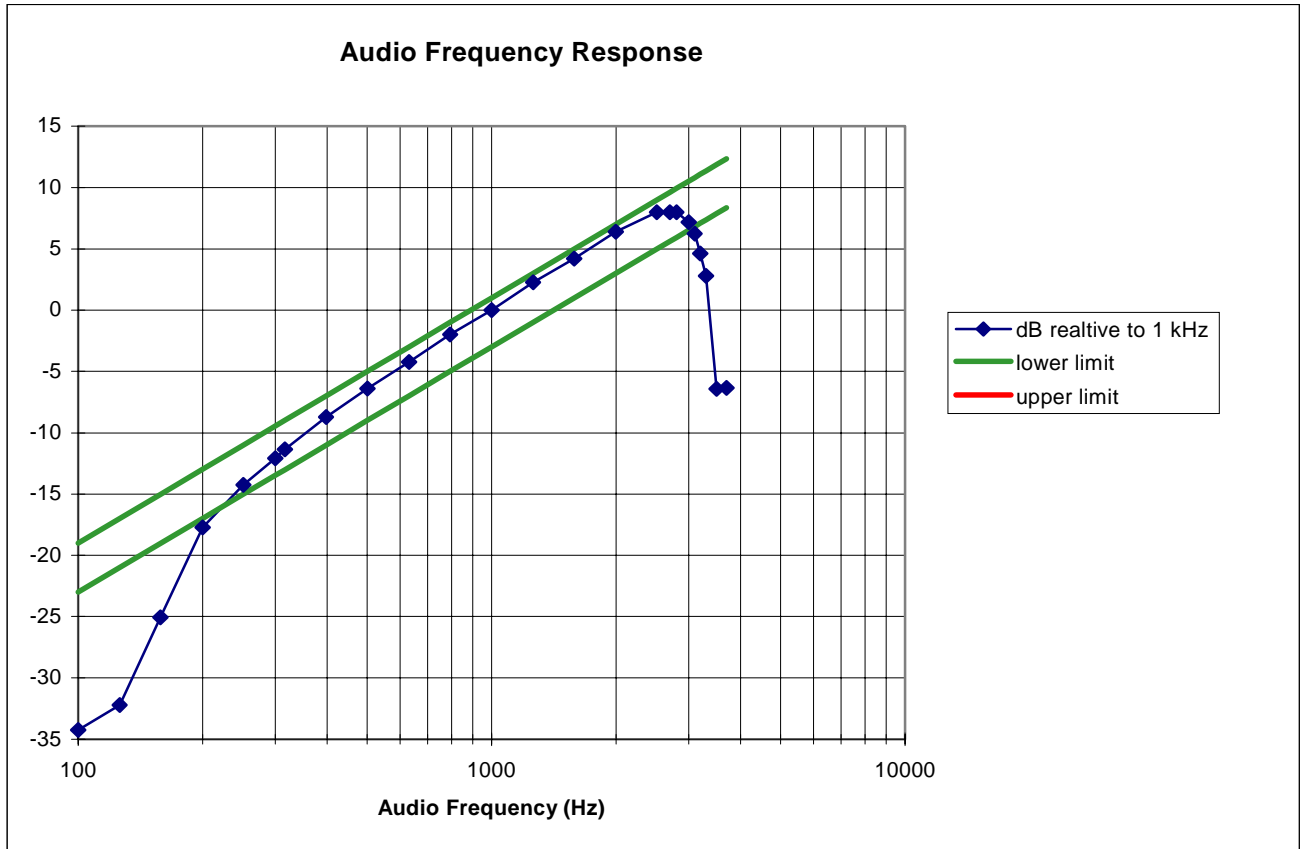

Audio Frequency Response (> 3 kHz)

freq	dev (dB)	dB from 3 kHz	upper limit
3000	-2.35	0	0.00
3500	-32.8	-30.45	-2.68
4000	-36.2	-33.85	-5.00
4500	-51.2	-48.85	-7.04
5000	-56.7	-54.35	-8.87
5900	-66.6	-64.25	-11.75
5900	-66.6	-64.25	-11.75
6000	-64.6	-62.25	-35.00
6100	-64.5	-62.15	-35.00
6100	-64.5	-62.15	-35.00
7000	-60.0	-57.65	-35.00
8500	-67.4	-65.05	-14.72
10000	-62.3	-59.95	-18.09
12000	-61.1	-58.75	-20.92
15000	-68.8	-66.45	-24.08
20000	-61.1	-58.75	-27.96
25000	-60.0	-57.65	-28.00
30000	-63.1	-60.75	-28.00

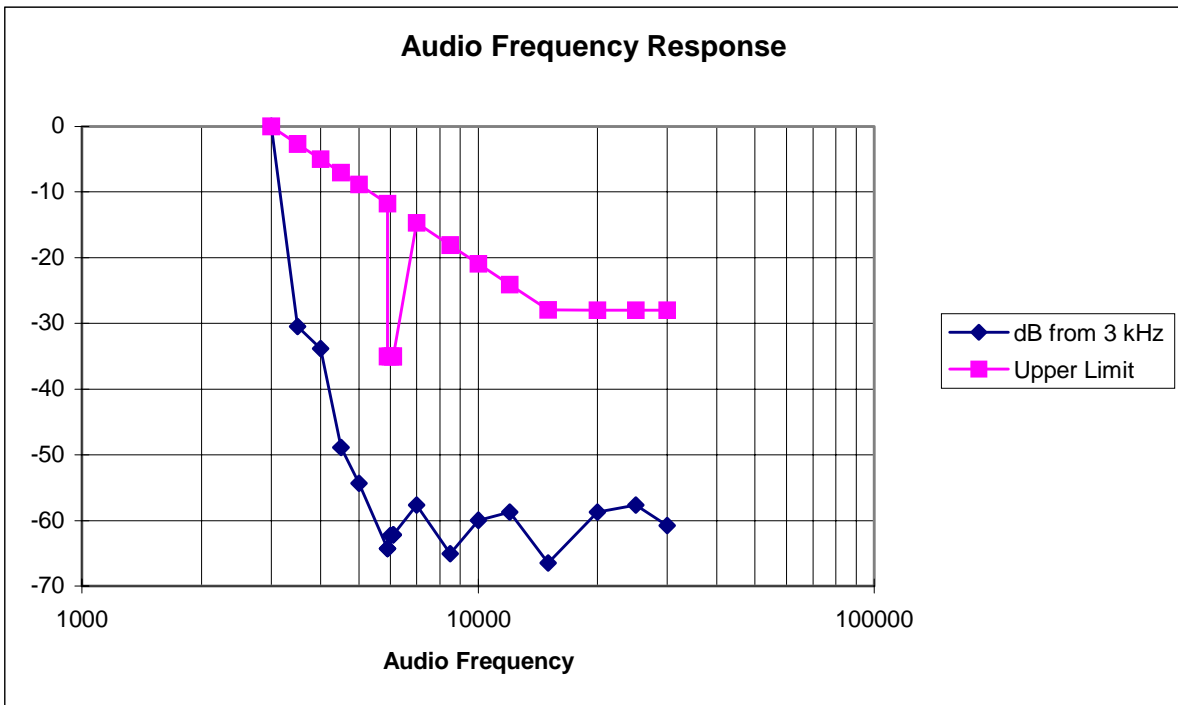

Exhibit 7

Transmitter Modulation Requirement - FCC Part 2, Paragraph 2.1047 (b)

Measured with HP8920 RF communication test set. The test procedures and technique are stated in Exhibit 15.

Audio Input Level (dB)	FM deviation (kHz peak)		
	Modulation frequency		
(0dB=8kHz dev)	400 Hz	1 kHz	2.7 kHz
-20	1.53	2.97	7.18
-15	1.85	3.70	8.34
-10	2.17	4.81	8.90
-5	2.71	6.25	9.12
0	3.40	8	9.54
5	4.45	9.21	9.82
10	9.25	10.13	10.23
15	10.10	10.37	10.14
20	9.67	8.93	10.10

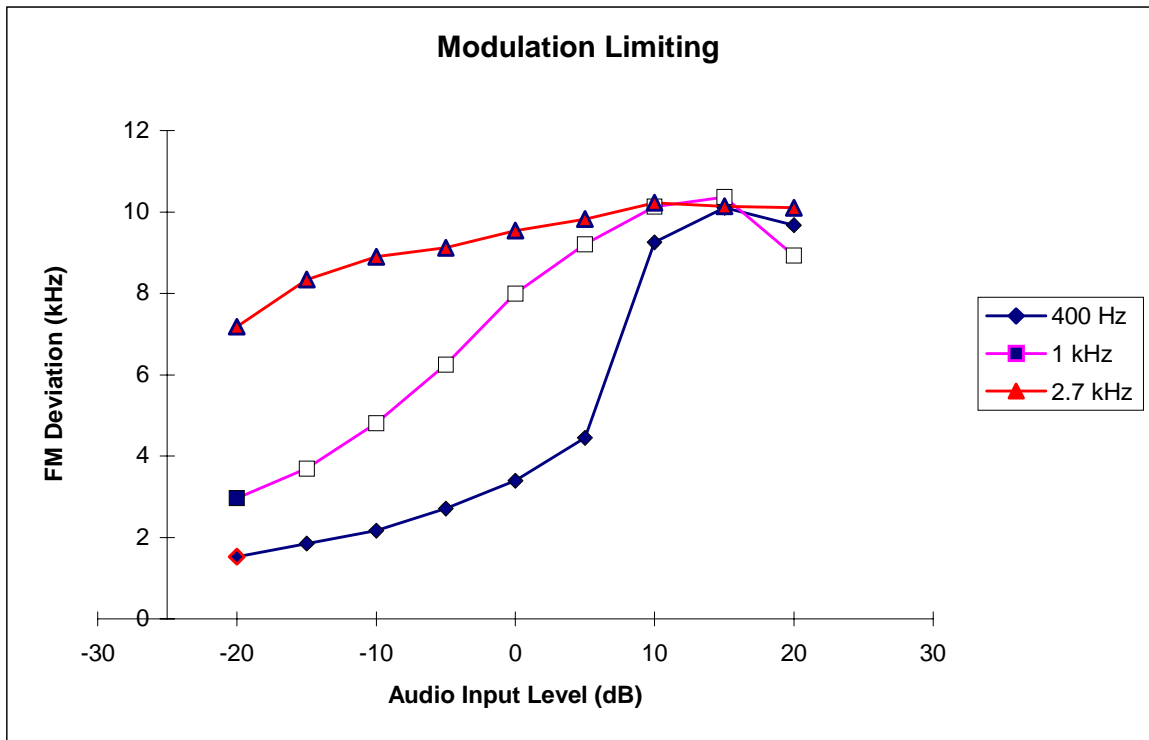

Exhibit 8**Occupied Bandwidth and Spurious Emission Measured Data**

The test procedures and technique are stated in Exhibit 15.

List of Exhibits

<u>Exhibit</u>	<u>Description</u>	<u>FCC Reference</u>
a-1	AMPS voice, ± 100 kHz from carrier frequency	2.1049, 22.917
a-2	AMPS voice, 0 Hz to 3 rd harmonic	2.1049, 22.917
a-3	AMPS voice, 869 - 894 MHz	2.1049, 22.917
b-1	AMPS voice + SAT, ± 100 kHz from carrier frequency	2.1049, 22.917
b-2	AMPS voice + SAT, 0 Hz to 3 rd harmonic	2.1049, 22.917
b-3	AMPS voice + SAT, 869 - 894 MHz	2.1049, 22.917
c-1	AMPS SAT, ± 100 kHz from carrier frequency	2.1049, 22.917
c-2	AMPS SAT, 0 Hz to 3 rd harmonic	2.1049, 22.917
c-3	AMPS SAT, 869 - 894 MHz	2.1049, 22.917
d-1	AMPS ST, ± 100 kHz from carrier frequency	2.1049, 22.917
d-2	AMPS ST, 0 Hz to 3 rd harmonic	2.1049, 22.917
d-3	AMPS ST, 869 - 894 MHz	2.1049, 22.917
e-1	AMPS ST + SAT, ± 100 kHz from carrier frequency	2.1049, 22.917
e-2	AMPS ST + SAT, 0 Hz to 3 rd harmonic	2.1049, 22.917
e-3	AMPS ST + SAT, 869 - 894 MHz	2.1049, 22.917
f-1	SAT & DTMF, ± 100 kHz from carrier frequency	2.1049, 22.917
f-2	SAT & DTMF, 0 Hz to 3 rd harmonic	2.1049, 22.917
f-4	SAR & DTMF, 869 - 894 MHz	2.1049, 22.917
g-1	AMPS WIDEBAND, ± 100 kHz from carrier frequency	2.1049, 22.917
g-2	AMPS WIDEBAND, 0 Hz to 3 rd harmonic	2.1049, 22.917
g-3	AMPS WIDEBAND, 869 - 894 MHz	2.1049, 22.917
h-1	Cellular CDMA at RC1, 99% occupy bandwidth	2.1049, 22.917
h-2	Cellular CDMA at RC1, 0 Hz to 3 rd harmonic	2.1049, 22.917
h-3	Cellular CDMA at RC1, 869 - 894 MHz	2.1049, 22.917
	Cellular CDMA at RC3	
i	<i>note: KWC-2325 supports additional reverse channels, as per IS-98D (CDMA 1x), therefore, additional measurements were taken to show compliance. Please see a separate attachment (Exhibit 24)</i>	2.1049, 22.917 IS-98D

AMPS Voice

a-1

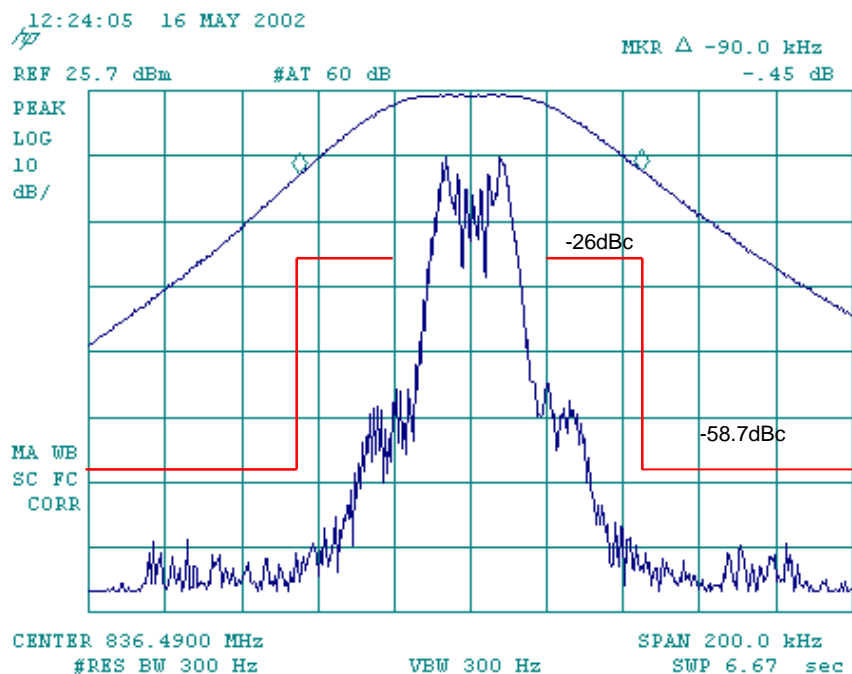

a-2

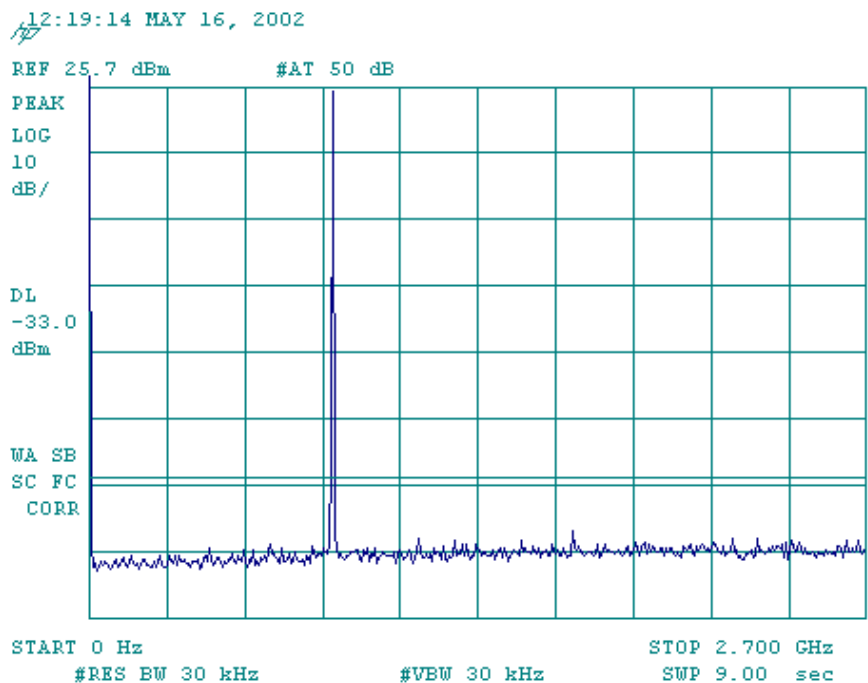

a-3

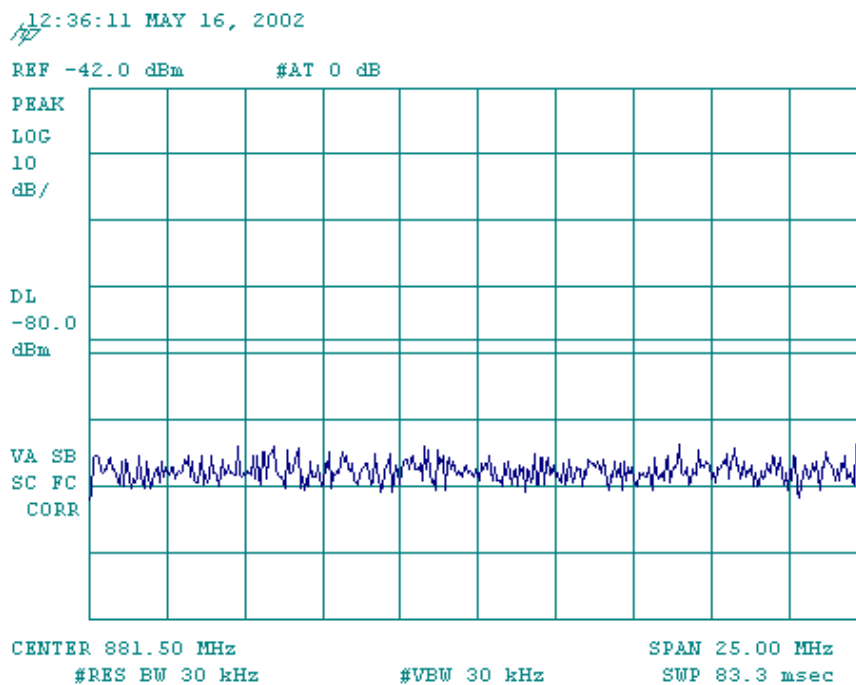

AMPS Voice + SAT

b-1

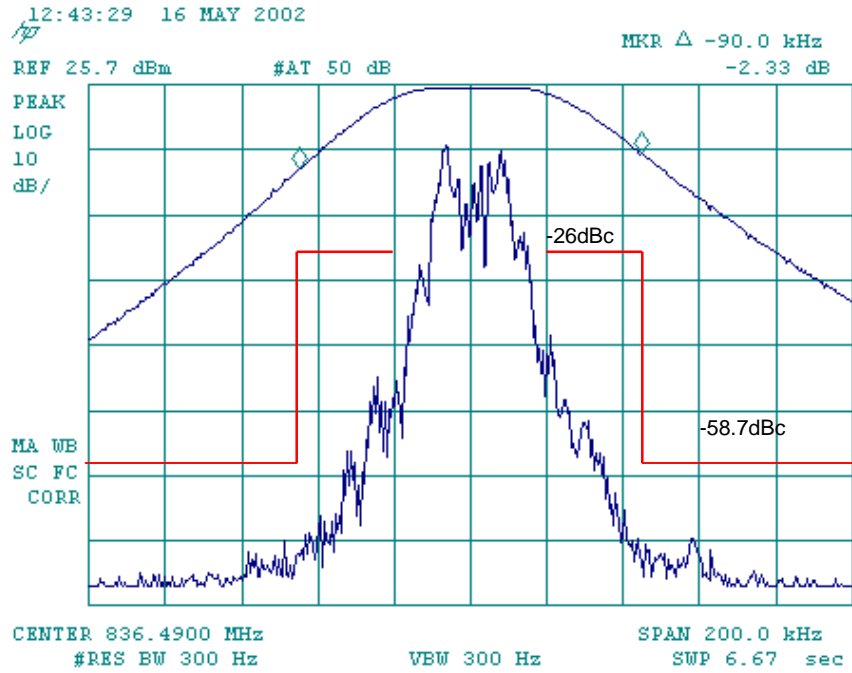

b-2

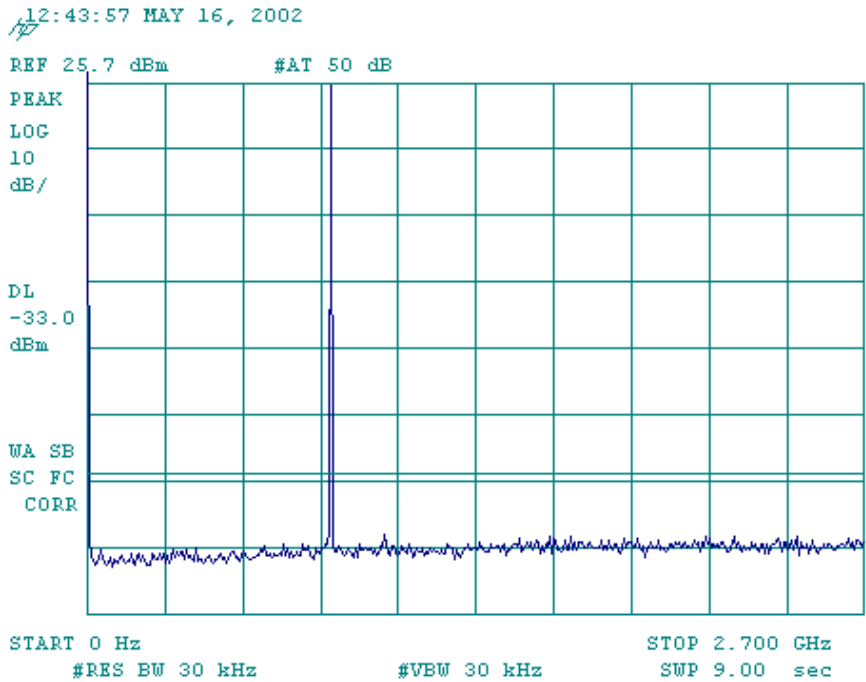

b-3

12:35:22 MAY 16, 2002

REF -42.0 dBm #AT 0 dB

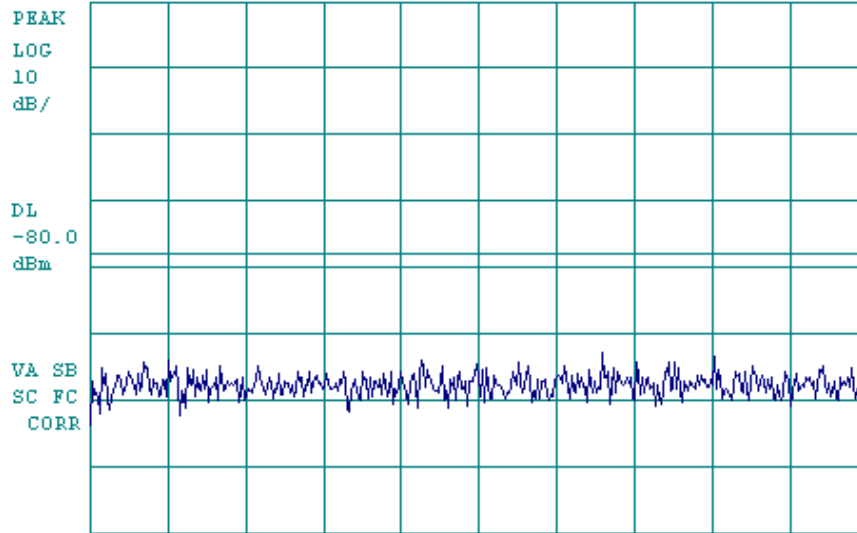

CENTER 881.50 MHz SPAN 25.00 MHz
#RES BW 30 kHz #VBW 30 kHz SWP 83.3 msec

AMPS SAT

c-1

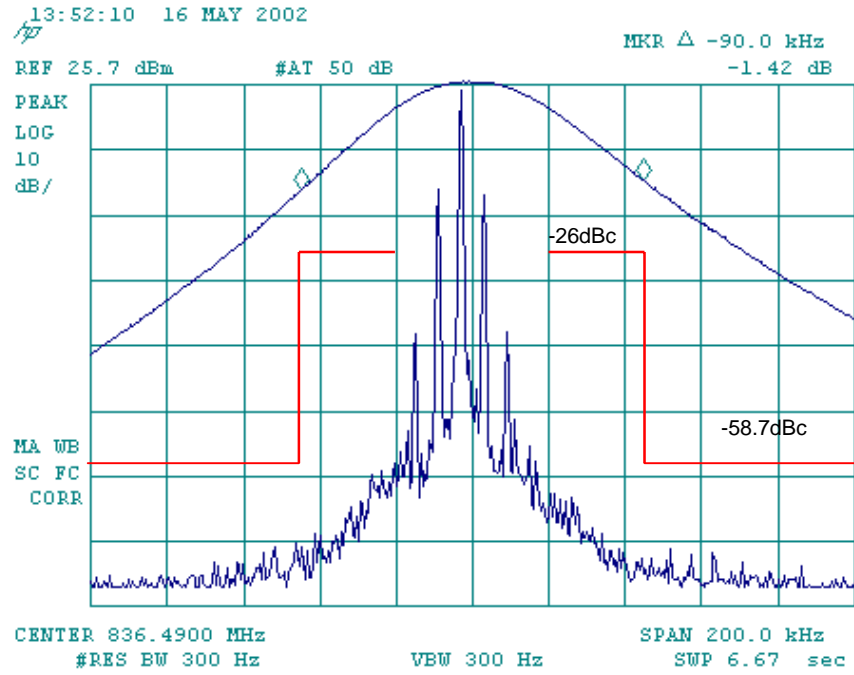

c-2

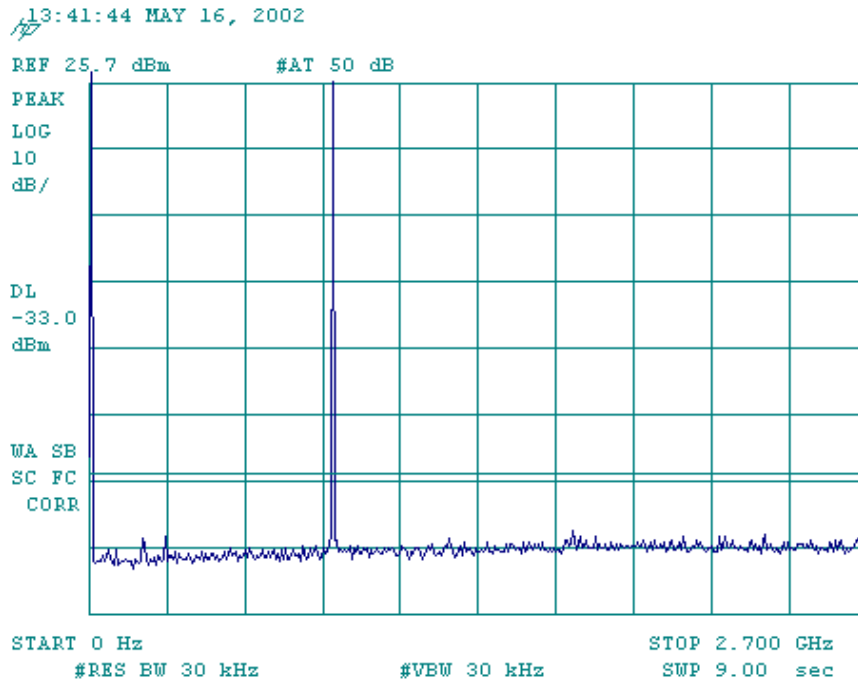

c-3

13:43:39 MAY 16, 2002

REF -42.0 dBm #AT 0 dB

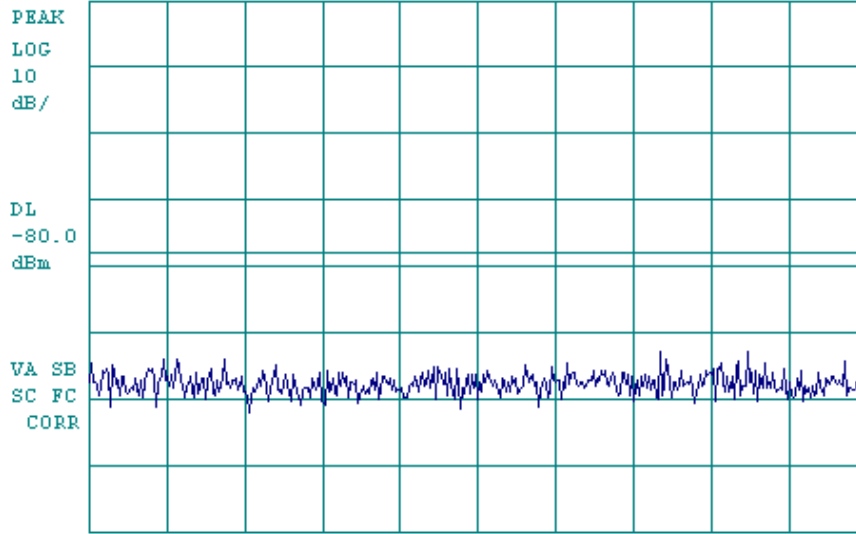

CENTER 881.50 MHz

#RES BW 30 kHz

#VBW 30 kHz

SPAN 25.00 MHz

SWP 83.3 msec

AMPS ST

d-1

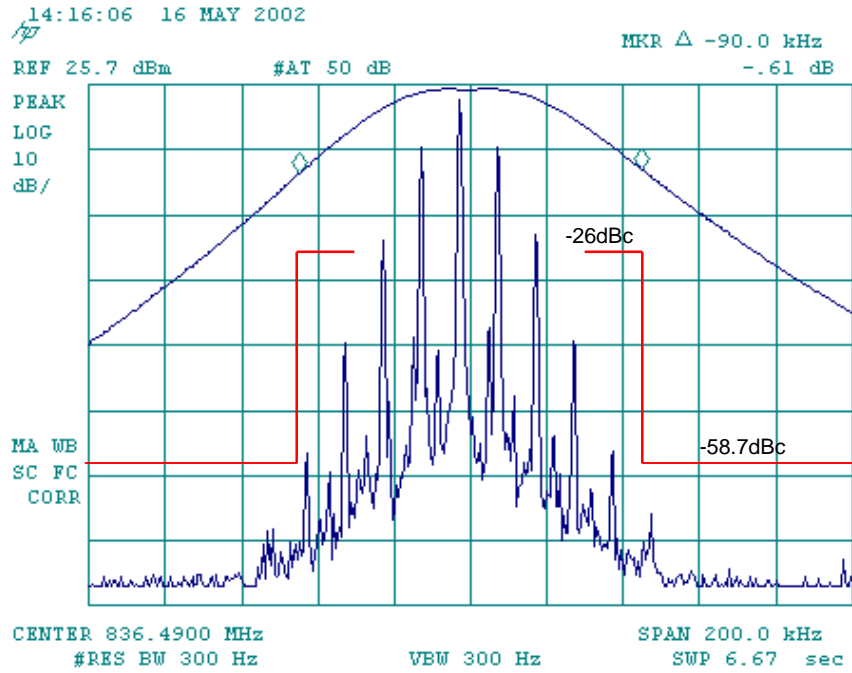

d-2

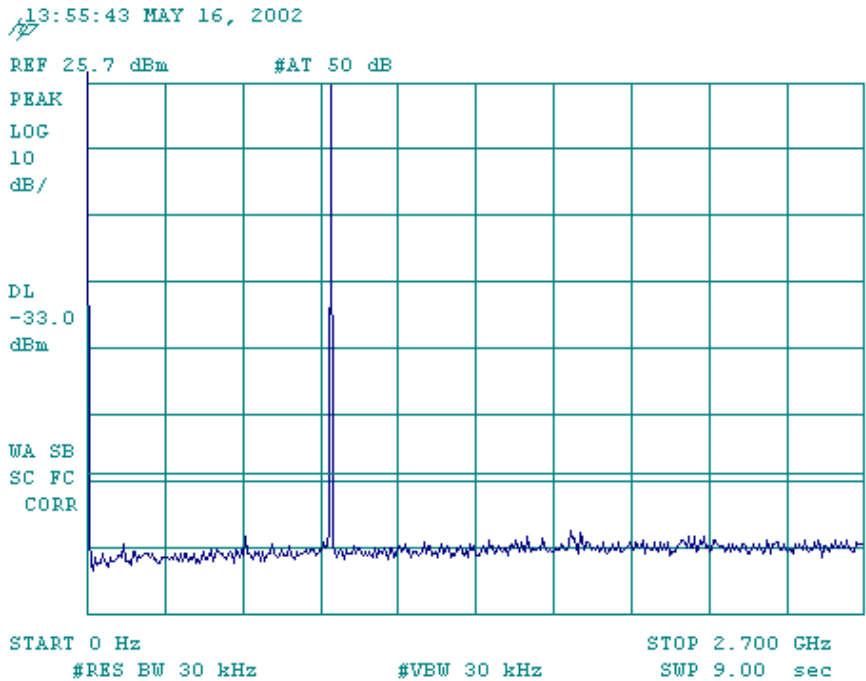

d-3

13:47:17 MAY 16, 2002

REF -42.0 dBm #AT 0 dB

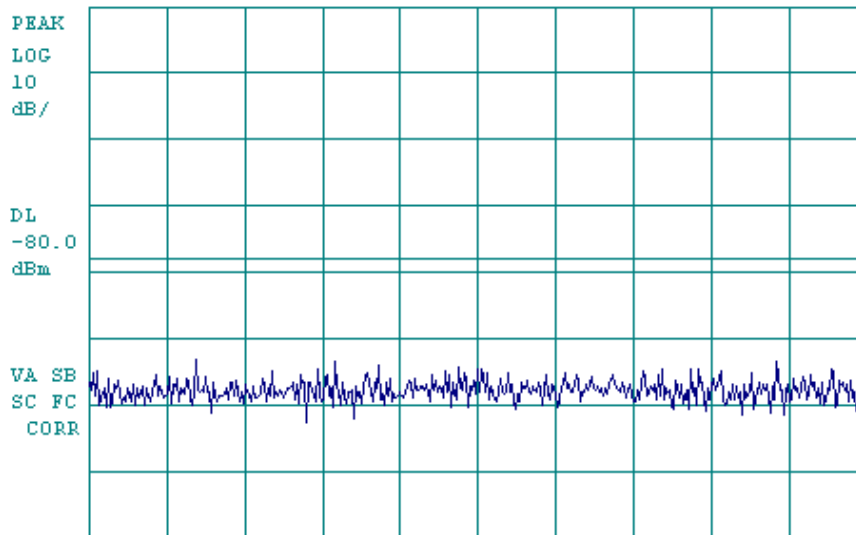

CENTER 881.50 MHz

#RES BW 30 kHz

#VBW 30 kHz

SPAN 25.00 MHz

SWP 83.3 msec

AMPS ST + SAT

e-1

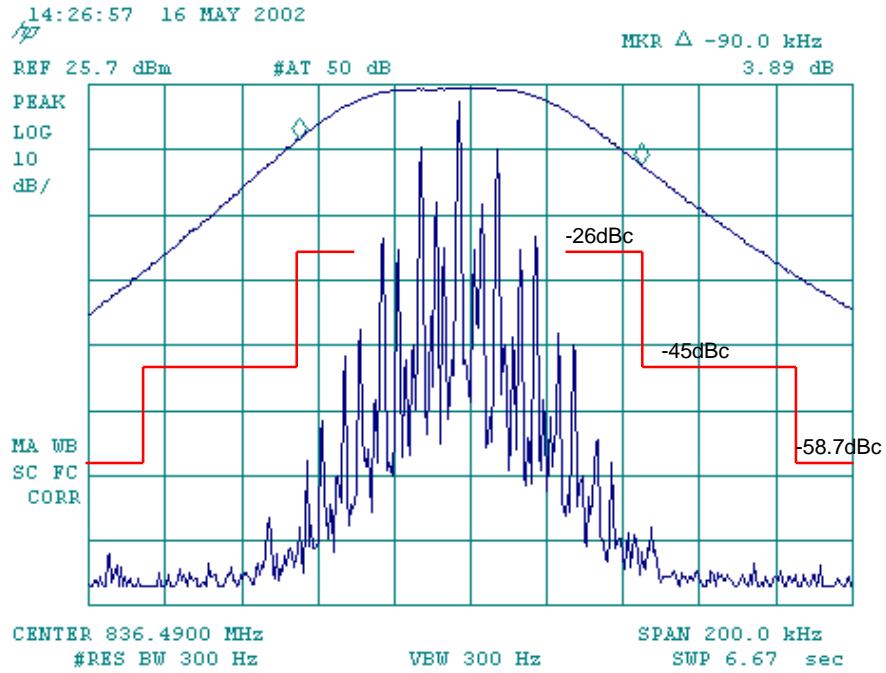

e-2

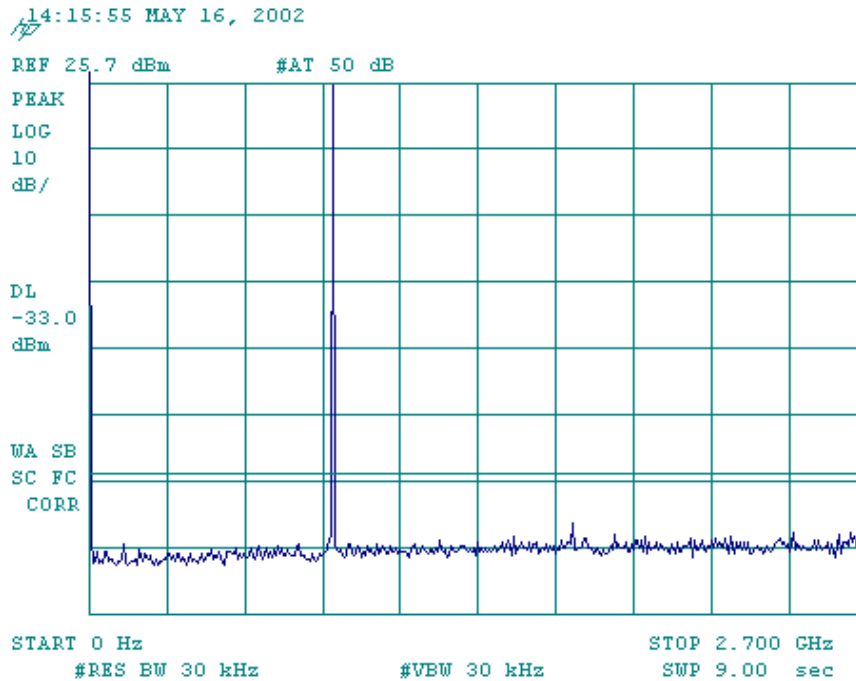

e-3

14:17:44 MAY 16, 2002

REF -42.0 dBm #AT 0 dB

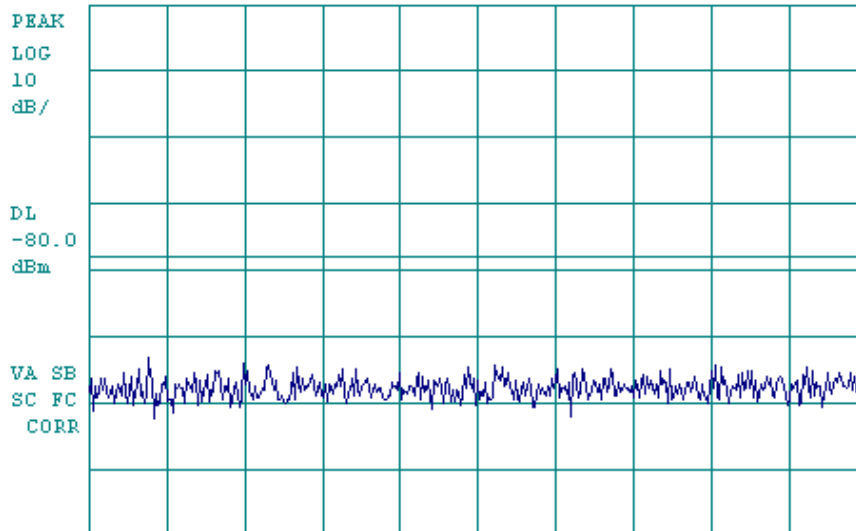

CENTER 881.50 MHz

#RES BW 30 kHz

#VBW 30 kHz

SPAN 25.00 MHz

SWP 83.3 msec

SAT + DTMF

f-1

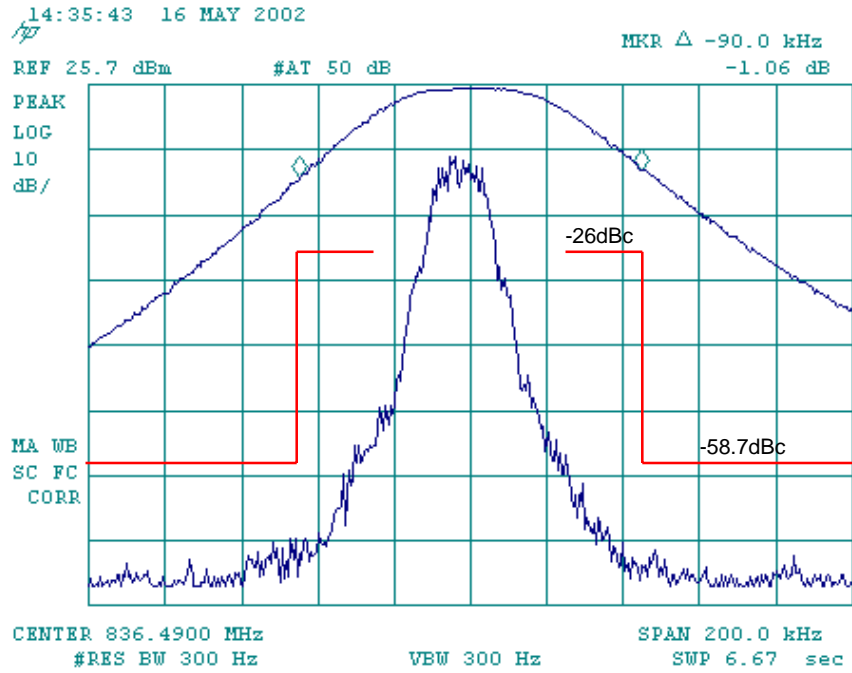

f-2

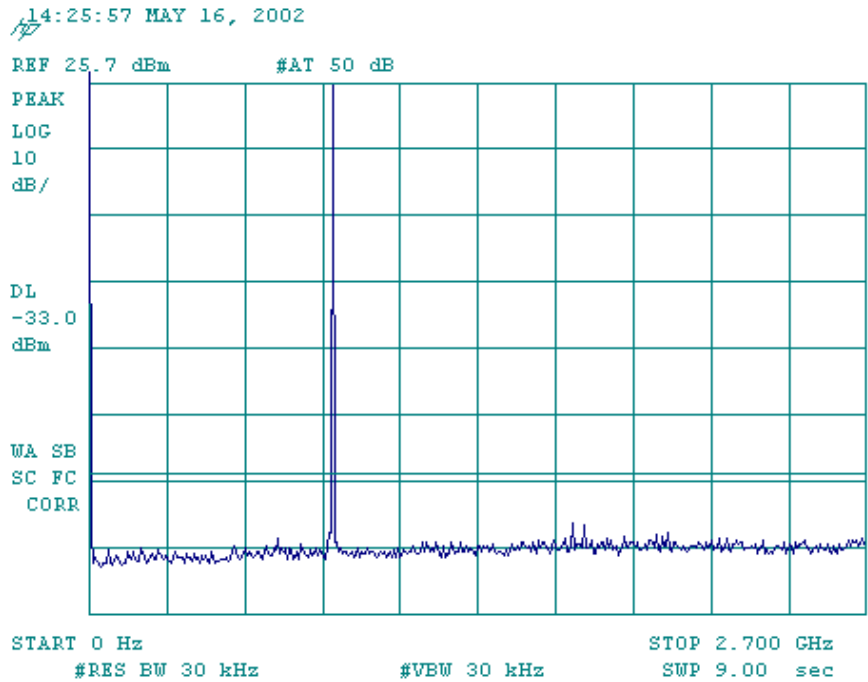

f-3

14:24:11 MAY 16, 2002

REF -42.0 dBm #AT 0 dB

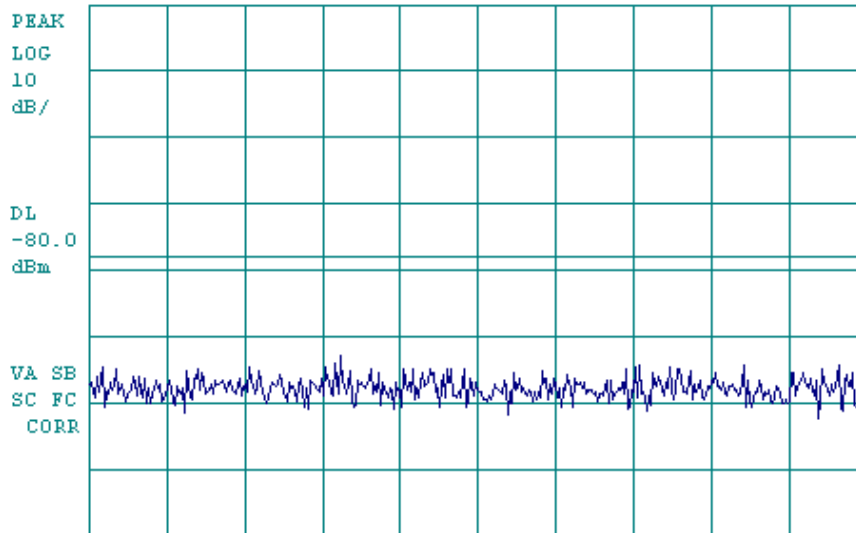

CENTER 881.50 MHz

#RES BW 30 kHz

#VBW 30 kHz

SPAN 25.00 MHz

SWP 83.3 msec

AMPS WIDEBAND

g-1

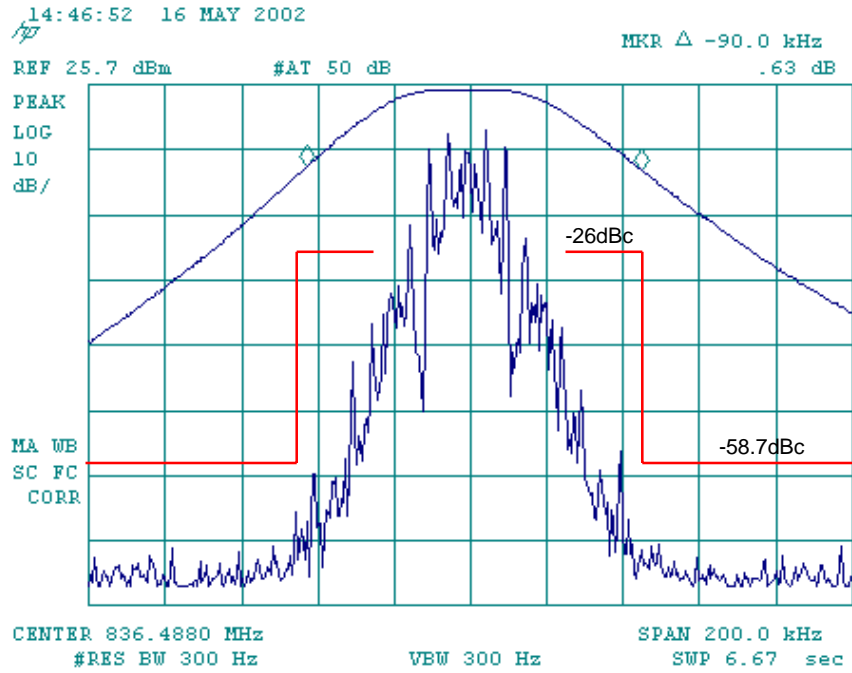

g-2

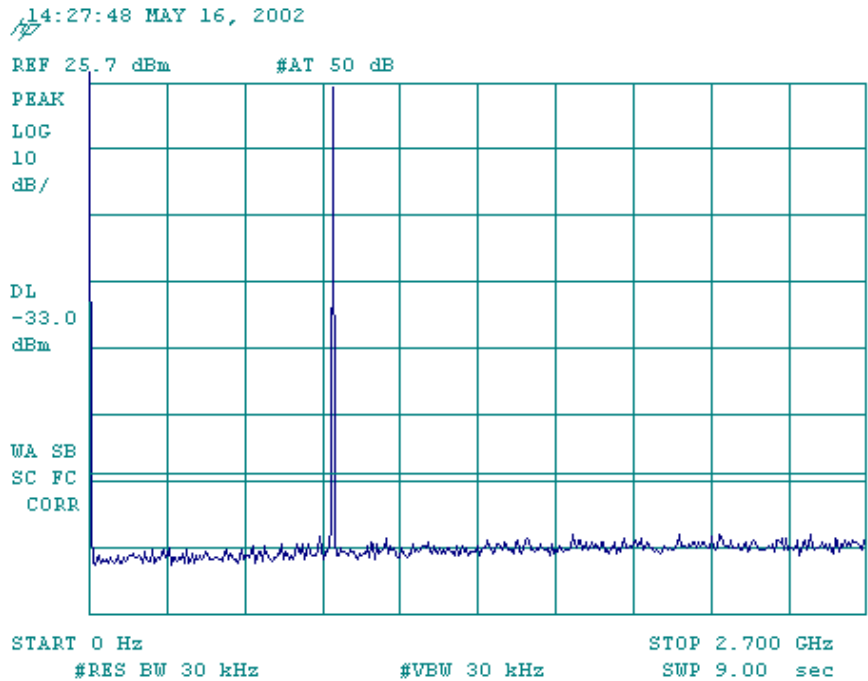

g-3

14:30:01 MAY 16, 2002

REF -42.0 dBm #AT 0 dB

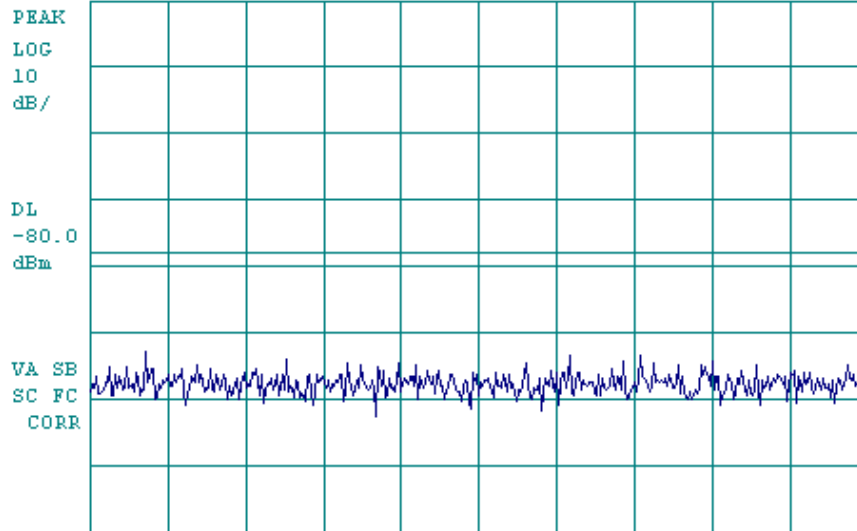

CENTER 881.50 MHz

#RES BW 30 kHz

#VBW 30 kHz

SPAN 25.00 MHz

SWP 83.3 msec

Cellular CDMA at RC1

h-1

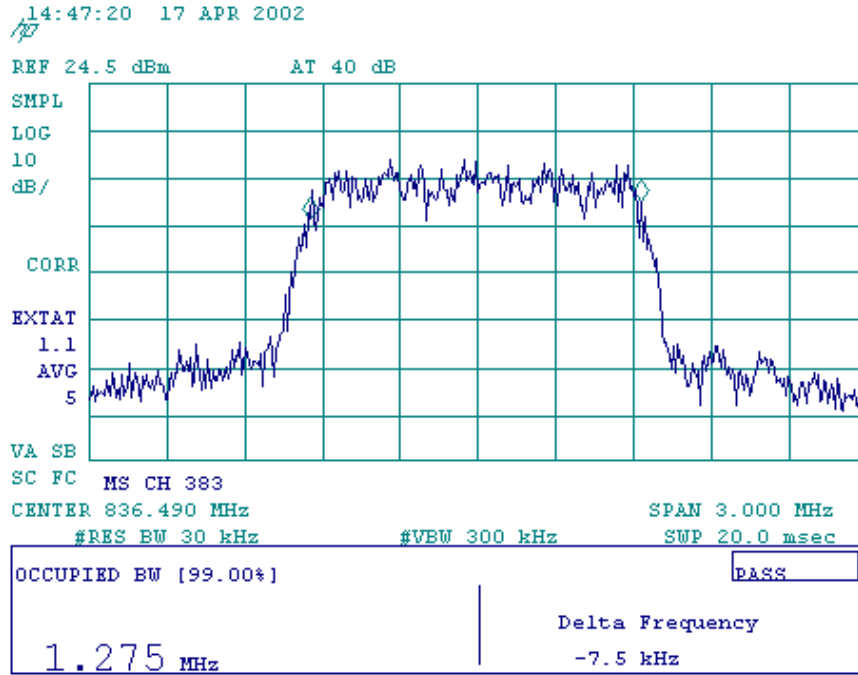

h-2

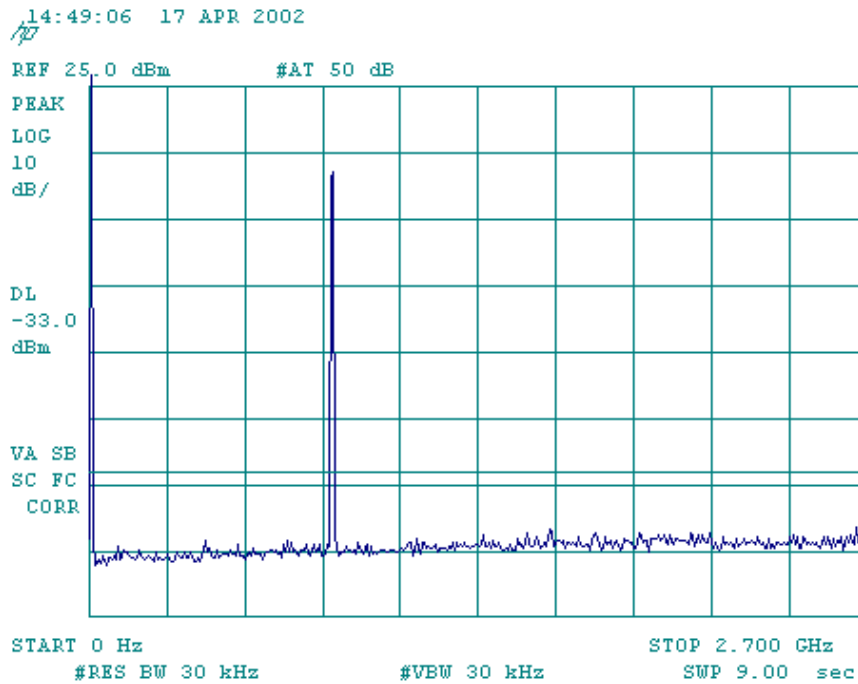

h-3

14:50:31 17 APR 2002

~~17~~

REF -42.0 dBm #AT 0 dB

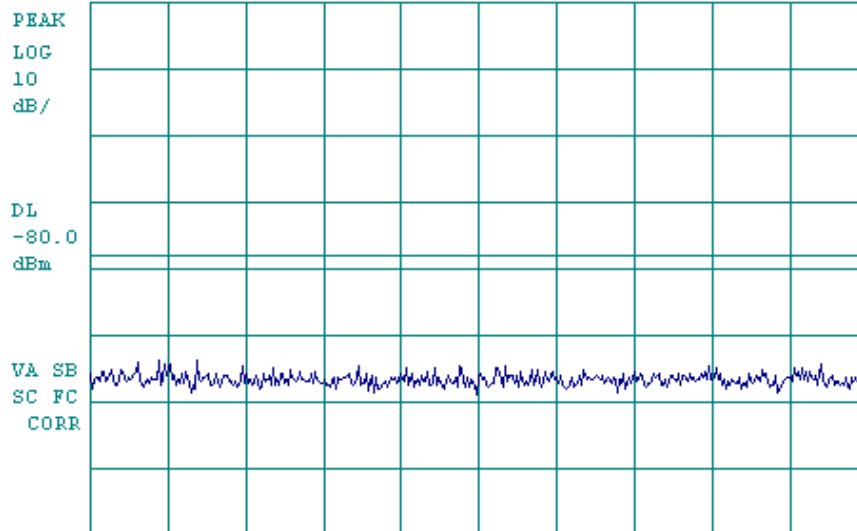

CENTER 881.50 MHz SPAN 25.00 MHz
#RES BW 30 kHz #VBW 30 kHz SWP 83.3 msec

Exhibit 9

Occupied Bandwidth and Spurious Emission Measured Data – FCC Part 2.1049, 24.238

The following data shows compliance for CDMA mode when operating in a P_REV 5 or less network. For CDMA mode when operating in a P_REV 6 or above, see a separate attachment (exhibit 24).

1. Occupied Bandwidth

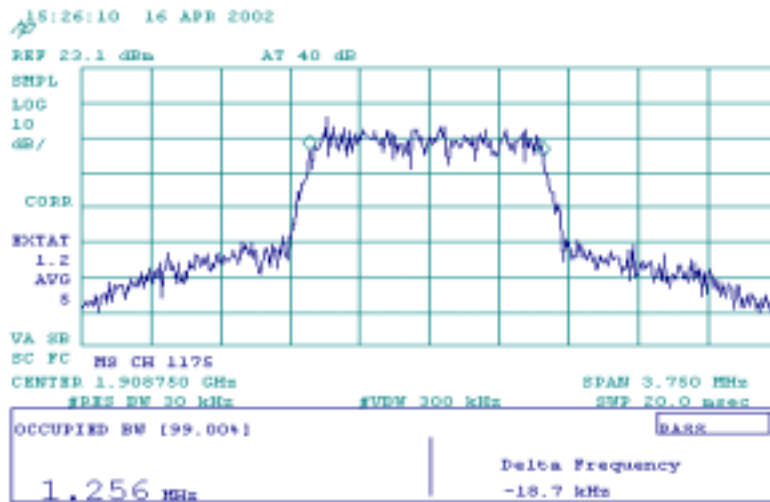
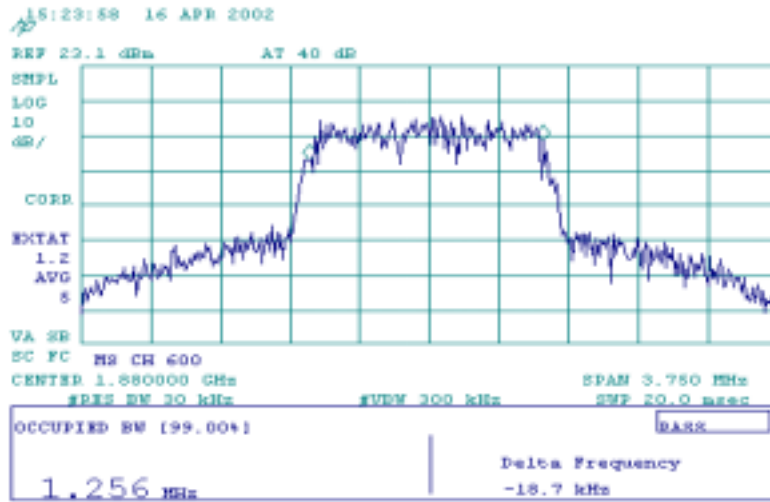
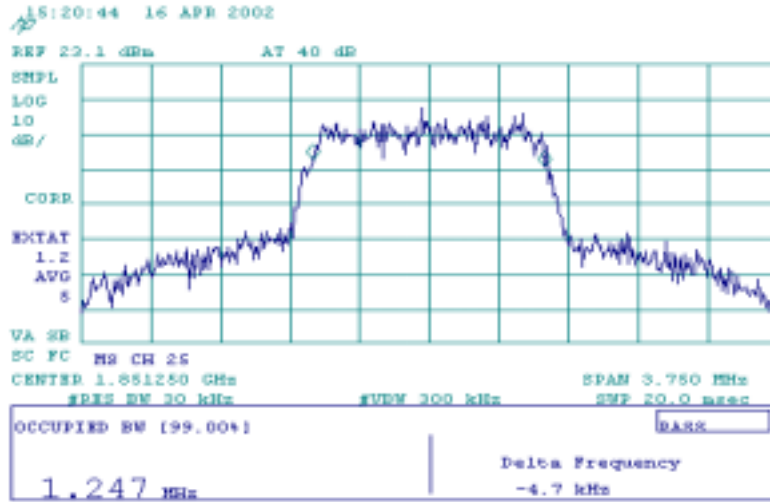

2. Spurious Emission at Antenna Terminals

Out of Band Spurious Emission Measurement Procedures

(a) 1 MHz band immediately adjacent to the PCS band

We performed a numerical integration of the power as performed by the spectrum analyzer (HP8594E) in the 1 MHz band immediately outside of the PCS block. As specified in Part 24.238 of the rules, we used a Resolution Bandwidth of 1% of the fundamental emission bandwidth, which in this instance equates to the measurement bandwidth of 12.5 kHz.

The ACPR (Adjacent Channel Power Ratio) function of the HP CDMA measurement personality was used on spectrum analyzer, which provides the power integration. The ACPR function and the spectrum analyzer settings used to complete the measurement will be addressed in section (c).

(b) 2nd 1 MHz band adjacent to PCS Block

As specified in Part 24.238 of the rules, the 2nd 1 MHz band outside of the PCS block was measured using a resolution bandwidth of 1 MHz.

The ACPR function of the HP CDMA measurement personality was used to complete the measurement. See section (c) for the ACPR function and the spectrum analyzer settings.

(c) ACPR measurement and spectrum analyzer settings

The ACPR (Adjacent Channel Power Ratio) is the power contained in a specified frequency-channel bandwidth relative to the total carrier power. It can measure up to three pairs of offset channels and relates them to the carrier power. ACPR measurement uses an integration bandwidth method (IBW) to measure the carrier power and the offset powers. IBW method performs a frequency sweep through the bandwidth of integration (set up by the user) using a resolution bandwidth (automatically set) much narrower than the channel bandwidth (e.g. 30 kHz RBW for a channel bandwidth of 1.25 MHz). The measurement computes an average power of the channel over a specified number of sweeps, automatically compensating for noise and scaling.

The following settings were used in the ACPR integration bandwidth method to complete the above measurements (a) and (b). An example to explain the settings is given.

Settings used in ACPR measurement

	Frequency (Hz)	Offset Limit	IBW (Hz)	Offset Span (Hz)	Comments
Offset A	± 885k	n/a	n/a	n/a	not required on a mobile station
Offset B	±1.25625M	-35.5dB (43+10logP)	12.5k	25k	setup for 1 MHz band immediately adjacent to PCS band
Offset C	± 2.75M	-35.5dB (43+10logP)	1M	2M	setup for 2 nd 1 MHz band adjacent to PCS band

As an example of channel 25, the center frequency is 1851.25 MHz. The interpretation of the settings in the above table is shown in following drawing.

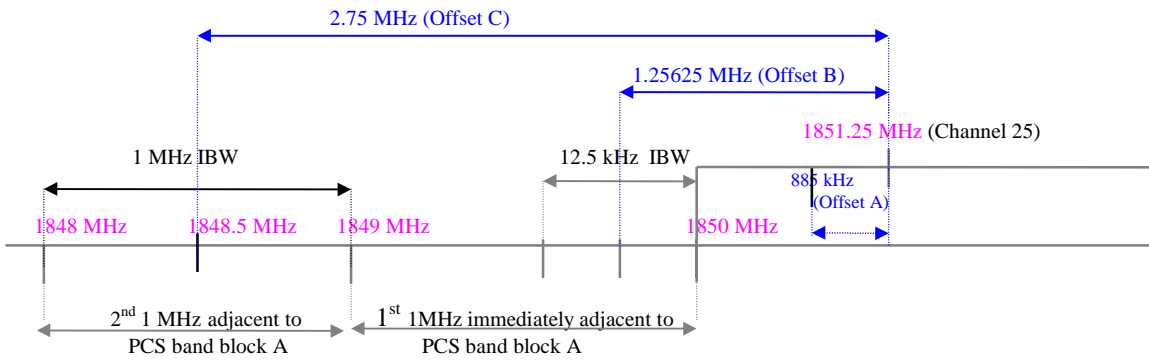

Note: The above drawing is not in scale.

(d) Spurious emission up to 10th harmonic of the transmitting frequency

The harmonic and spurious emissions from 0 Hz to 22 GHz were measured using a RBW of 1 MHz and a VBW of 1 MHz on the spectral analyzer.

Test Results

ACPR measurement (1st and 2nd 1MHz adjacent to PCS)

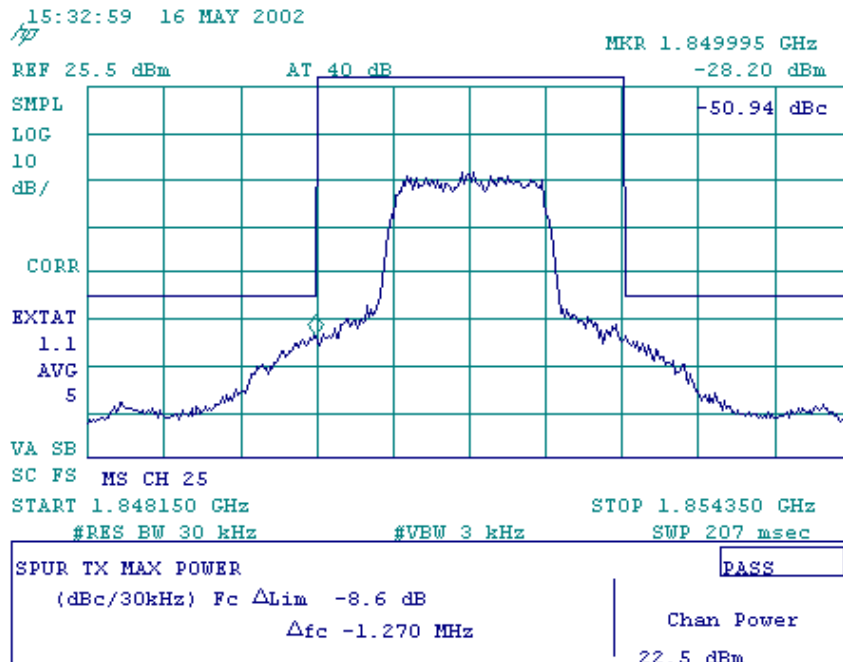
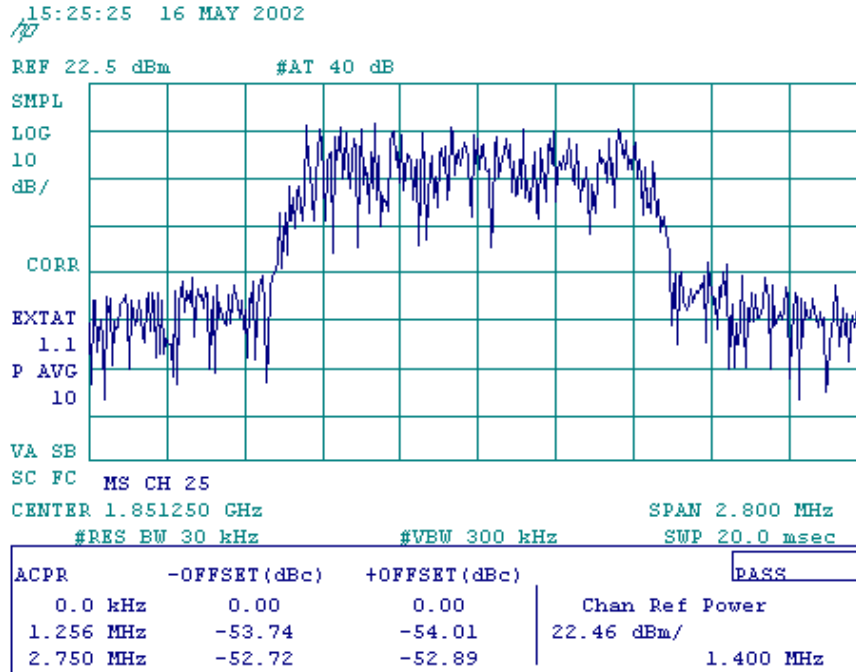

16:04:00 16 MAY 2002

fp

REF 22.5 dBm #AT 40 dB

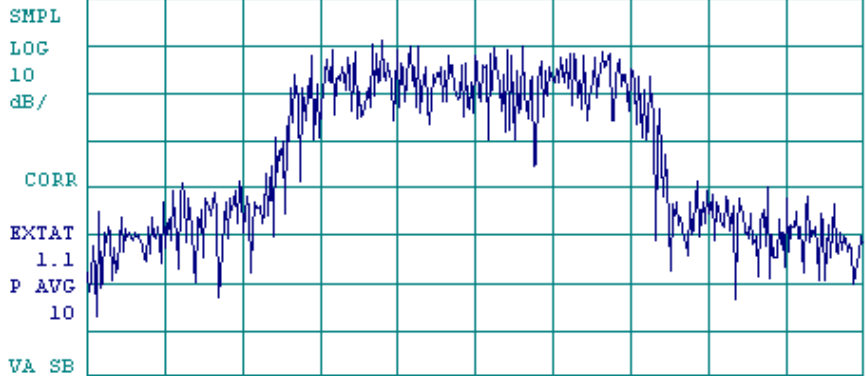

SC FC MS CH 600
 CENTER 1.880000 GHz SPAN 2.800 MHz
 #RES BW 30 kHz #VBW 300 kHz SWP 20.0 msec

ACPR	-OFFSET(dBc)	+OFFSET(dBc)	PASS
0.0 kHz	0.00	0.00	Chan Ref Power
1.256 MHz	-53.91	-54.28	22.48 dBm/
2.750 MHz	-53.04	-53.23	1.400 MHz

16:05:47 16 MAY 2002

fp

MKR 1.878745 GHz

REF 25.5 dBm AT 40 dB -27.82 dBm

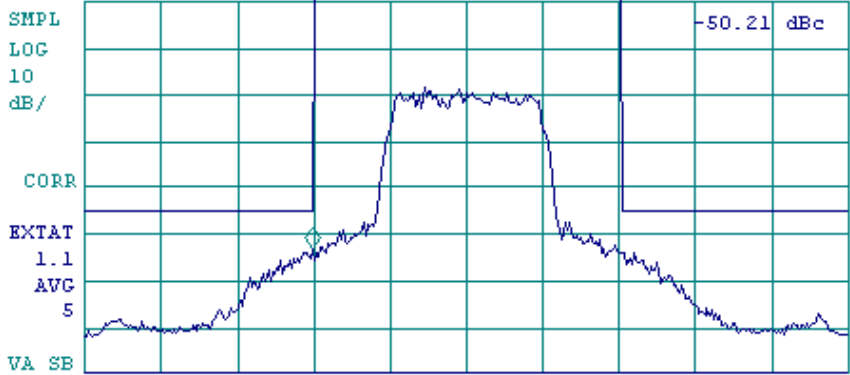

SC FS MS CH 600
 START 1.876900 GHz STOP 1.883100 GHz
 #RES BW 30 kHz #VBW 3 kHz SWP 207 msec

SPUR TX MAX POWER	PASS
(dBc/30kHz) Fc ΔLim -8.3 dB	Chan Power
Δfc -1.260 MHz	22.5 dBm

16:13:37 16 MAY 2002

fp

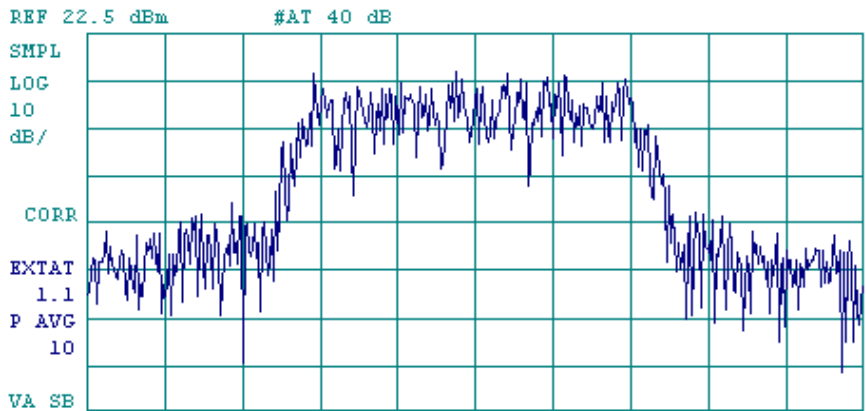

SC FC MS CH 1175
CENTER 1.908750 GHz SPAN 2.800 MHz
#RES BW 30 kHz #VBW 300 kHz SWP 20.0 msec

ACPR	-OFFSET(dBc)	+OFFSET(dBc)	PASS
0.0 kHz	0.00	0.00	Chan Ref Power
1.256 MHz	-52.94	-54.03	22.54 dBm/
2.750 MHz	-53.22	-54.42	1.400 MHz

16:19:59 16 MAY 2002

fp

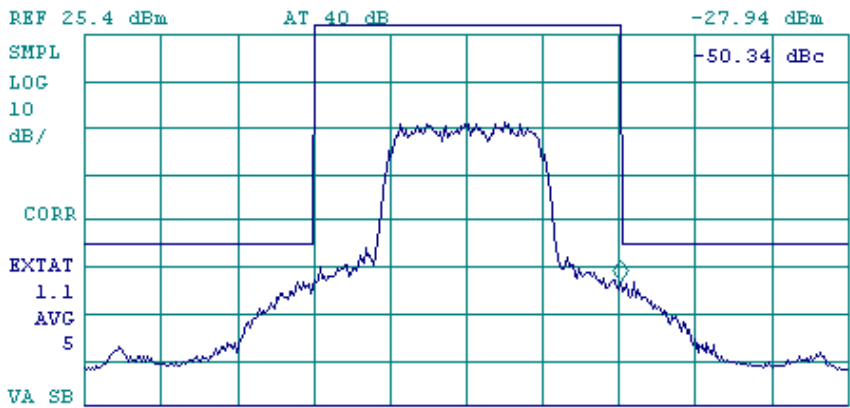

SC FS MS CH 1175
START 1.905650 GHz STOP 1.911850 GHz
#RES BW 30 kHz #VBW 3 kHz SWP 207 msec

SPUR TX MAX POWER	PASS
(dBc/30kHz) Fc ΔLim -8.2 dB	Chan Power
Δfc 1.360 MHz	22.4 dBm

Spurious Emission Up to 10th harmonics

Ch25

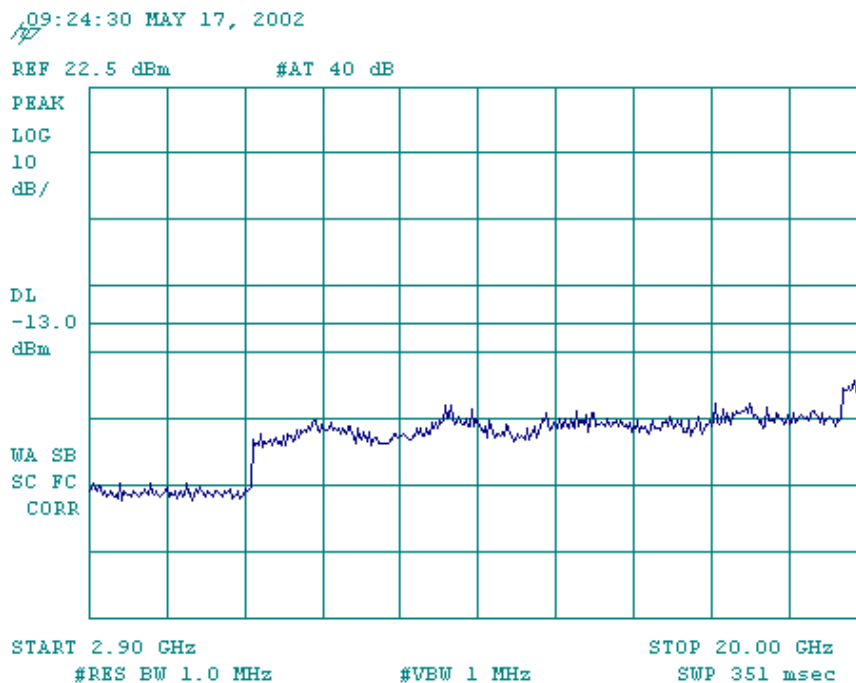
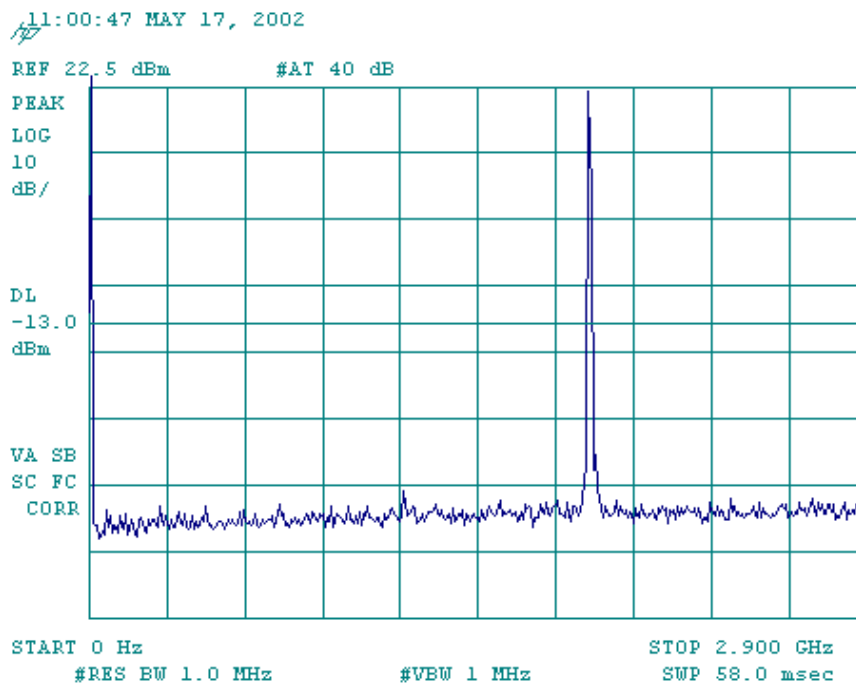

Ch600

11:01:58 MAY 17, 2002

REF 22.5 dBm #AT 40 dB

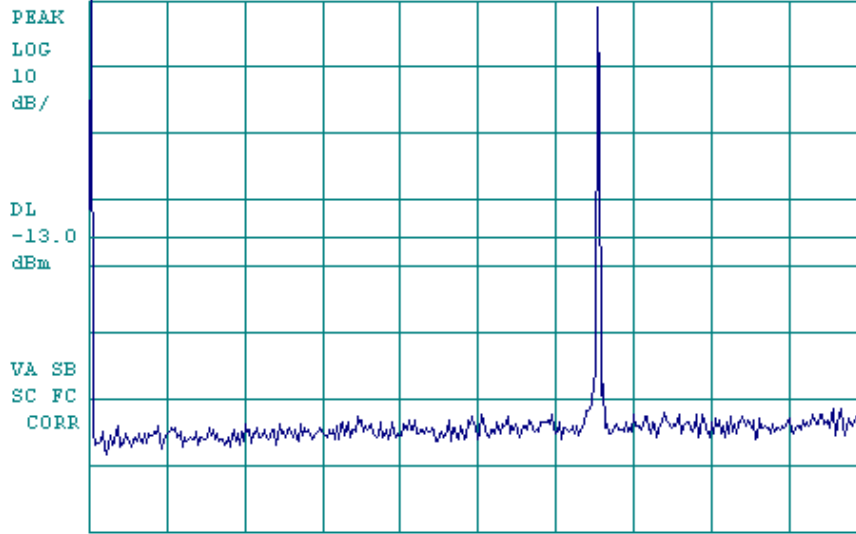

START 0 Hz #RES BW 1.0 MHz #VBW 1 MHz STOP 2.900 GHz SWP 58.0 msec

09:28:18 MAY 17, 2002

REF 22.5 dBm #AT 40 dB

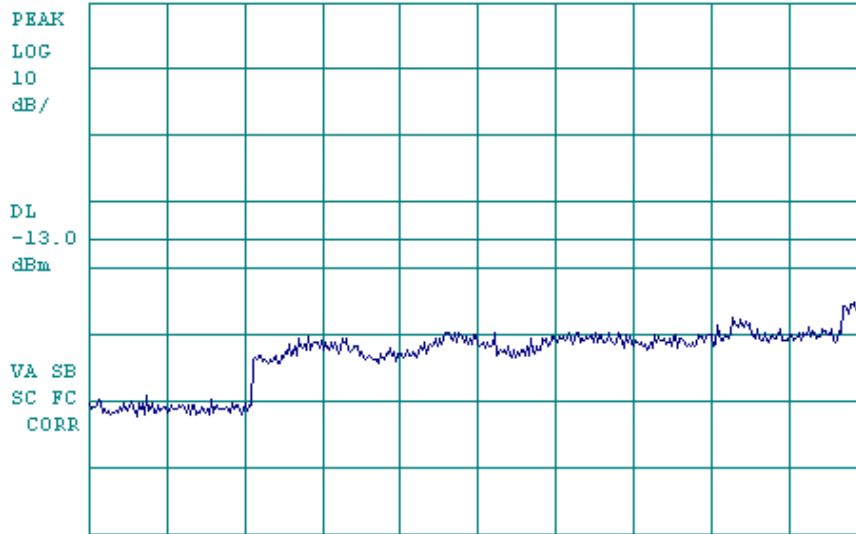

START 2.90 GHz #RES BW 1.0 MHz #VBW 1 MHz STOP 20.00 GHz SWP 351 msec

Ch1175

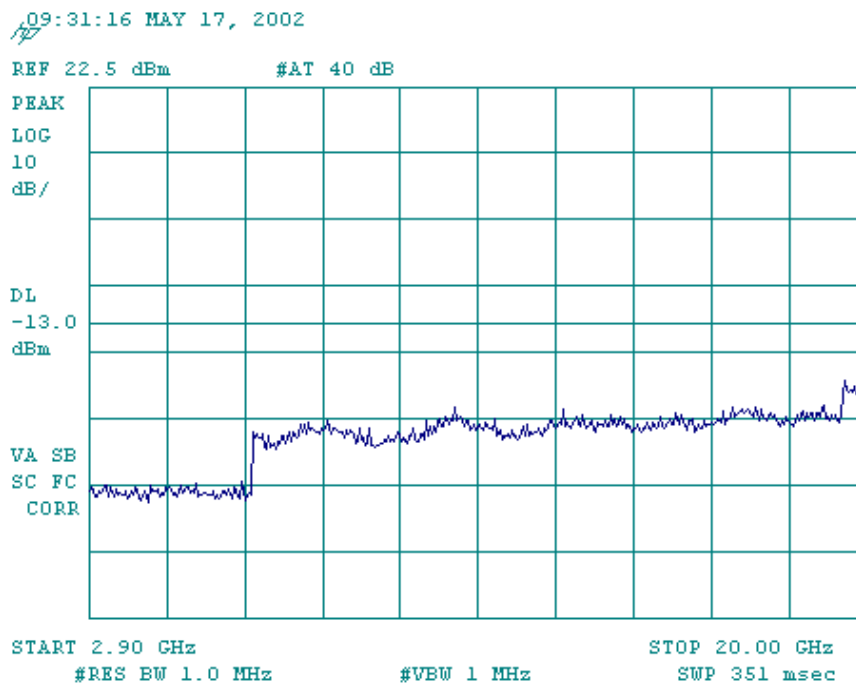
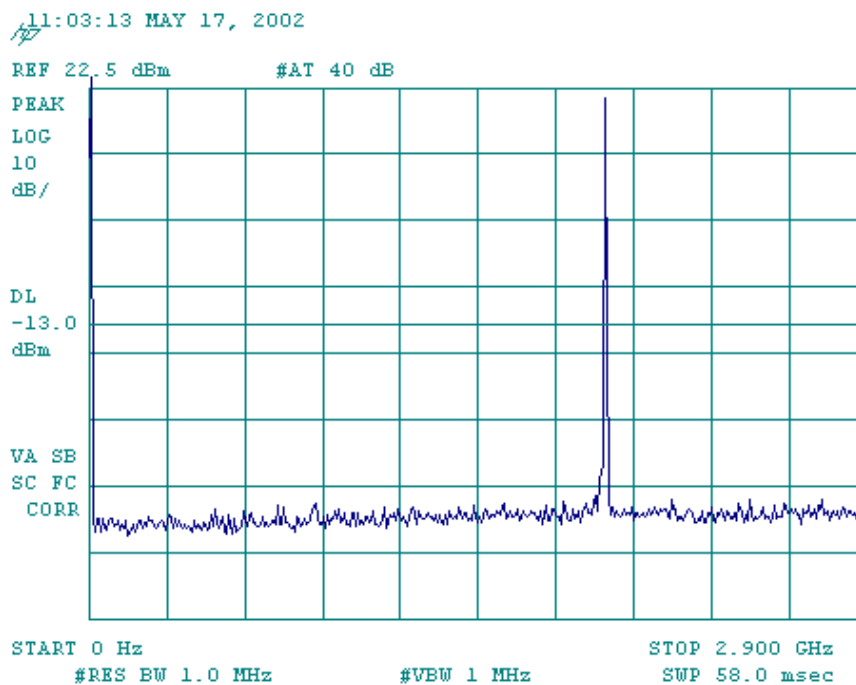

Exhibit 10**Conducted Emissions Test Results (harmonics) - FCC Part 2 and 22, Paragraph 2.1051, 22.917**

5/16/2002

FM High Power

low band – channel 991

	Frequency (MHz)	Measured Level (dBm)	specification limit (dBm)
Fundamental	824.04	25.74	-
2 nd harmonic	1648.08	-33.03	-13
3 rd harmonic	2472.12	-44.24	-13
4 th harmonic	3296.16	-59.14	-13
5 th harmonic	4120.2	-68.18	-13
6 th harmonic	4944.24	-66.06	-13
7 th harmonic	5768.28	-77.03	-13
8 th harmonic	6592.32	-68.46	-13
9 th harmonic	7416.36	-67.20	-13
10 th harmonic	8240.4	< -80	-13

mid band – channel 383

	Frequency (MHz)	Measured Level (dBm)	specification limit (dBm)
Fundamental	836.49	25.69	-
2 nd harmonic	1672.98	-32.12	-13
3 rd harmonic	2509.47	-43.33	-13
4 th harmonic	3345.96	-63.31	-13
5 th harmonic	4182.45	-69.10	-13
6 th harmonic	5018.94	-61.90	-13
7 th harmonic	5855.43	-74.91	-13
8 th harmonic	6691.92	-64.03	-13
9 th harmonic	7528.41	-65.37	-13
10 th harmonic	8364.9	< -80	-13

high band – channel 799

	Frequency (MHz)	Measured Level (dBm)	specification limit (dBm)
Fundamental	848.97	25.70	-
2 nd harmonic	1697.94	-33.47	-13
3 rd harmonic	2546.91	-48.25	-13
4 th harmonic	3395.88	-60.73	-13
5 th harmonic	4244.85	-59.25	-13
6 th harmonic	5093.82	-67.05	-13
7 th harmonic	5942.79	< -80	-13
8 th harmonic	6791.76	-65.38	-13
9 th harmonic	7640.73	-68.31	-13
10 th harmonic	8489.7	-77.05	-13

CDMA High Power

low band – channel 1013

	Frequency (MHz)	Measured Level (dBm)	specification limit (dBm)
Fundamental	824.04	24.48	-
2 nd harmonic	1648.08	-34.57	-13
3 rd harmonic	2472.12	-41.14	-13
4 th harmonic	3296.16	-72.40	-13
5 th harmonic	4120.2	-60.73	-13
6 th harmonic	4944.24	-70.20	-13
7 th harmonic	5768.28	< -80	-13
8 th harmonic	6592.32	< -80	-13
9 th harmonic	7416.36	< -80	-13
10 th harmonic	8240.4	< -80	-13

mid band – channel 383

	Frequency (MHz)	Measured Level (dBm)	specification limit (dBm)
Fundamental	836.49	24.5	-
2 nd harmonic	1672.98	-33.28	-13
3 rd harmonic	2509.47	-40.96	-13
4 th harmonic	3345.96	-74.46	-13
5 th harmonic	4182.45	-59.90	-13
6 th harmonic	5018.94	-69.95	-13
7 th harmonic	5855.43	< -80	-13
8 th harmonic	6691.92	-64.60	-13
9 th harmonic	7528.41	< -80	-13
10 th harmonic	8364.9	< -80	-13

high band – channel 777

	Frequency (MHz)	Measured Level (dBm)	specification limit (dBm)
Fundamental	848.31	24.53	-
2 nd harmonic	1676.62	-34.59	-13
3 rd harmonic	2514.93	-44.39	-13
4 th harmonic	3353.24	< -80	-13
5 th harmonic	4191.55	< -80	-13
6 th harmonic	5029.86	-65.70	-13
7 th harmonic	5868.17	-70.48	-13
8 th harmonic	6706.48	-74.58	-13
9 th harmonic	7544.79	< -80	-13
10 th harmonic	8383.1	< -80	-13

Exhibit 11**Conducted Emission Test Results (Harmonics) - FCC Part 2 and 24, Paragraph 2.1051,
24.238**

5/16/2002

PCS CDMA High Power

low band – channel 25

	Frequency (MHz)	Measured Level (dBm)	specification limit (dBm)
Fundamental	1851.25	22.46	-
2 nd harmonic	3702.5	-54.60	-13
3 rd harmonic	5553.75	-60.13	-13
4 th harmonic	7405	< -70	-13
5 th harmonic	9256.25	< -70	-13
6 th harmonic	11107.5	< -70	-13
7 th harmonic	12958.75	< -70	-13
8 th harmonic	14810	< -70	-13
9 th harmonic	16661.25	< -70	-13
10 th harmonic	18512.5	< -70	-13

mid band – channel 600

	Frequency (MHz)	Measured Level (dBm)	specification limit (dBm)
Fundamental	1880	22.48	-
2 nd harmonic	3760	-52.45	-13
3 rd harmonic	5640	-67.61	-13
4 th harmonic	7520	< -70	-13
5 th harmonic	9400	-56.10	-13
6 th harmonic	11280	< -70	-13
7 th harmonic	13160	< -70	-13
8 th harmonic	15040	< -70	-13
9 th harmonic	16920	< -70	-13
10 th harmonic	18800	< -70	-13

high band – channel 1175

	Frequency (MHz)	Measured Level (dBm)	specification limit (dBm)
Fundamental	1908.75	22.54	-
2 nd harmonic	3817.5	-61.70	-13
3 rd harmonic	5726.25	-73.65	-13
4 th harmonic	7635	< -70	-13
5 th harmonic	9543.75	-61.34	-13
6 th harmonic	11452.5	< -70	-13
7 th harmonic	13361.25	-67.20	-13
8 th harmonic	15270	< -70	-13
9 th harmonic	17178.75	< -70	-13
10 th harmonic	19087.5	< -70	-13

Exhibit 12

Radiated Spurious Emissions Measured Data - FCC Part 2, Paragraph 2.1053

The radiated spurious emission test was performed at TUV in San Diego, California. The test report is attached in a separate attachment. The test procedures and technique are stated in Exhibit 15.

Exhibit 13

Transmitter RF Carrier Frequency Stability - FCC part 2.1055

Transmitter RF Carrier Frequency Stability - FCC part 2.1055

Phone transmitting in FM mode in cellular band, but with no modulation on the carrier

Measured with HP 8560A Spectrum Analyzer, The test procedures and technique are stated in Exhibit 15.

Carrier Frequency : 836.49 MHz FM

Temperature (C)	Transmitter Carrier Frequency Deviation (Hz)							Specification	
	3.2 V	3.4 V	3.6 V	3.8 V	4.0 V	4.1 V	4.2 V	lower limit	upper limit
-30	-139	-139	-139	-139	-139	-139	-139	-2091	2091
-20	-205	-205	-205	-205	-205	-205	-205	-2091	2091
-10	-700	-700	-700	-700	-700	-700	-700	-2091	2091
0	-443	-443	-443	-443	-443	-443	-433	-2091	2091
10	-233	-233	-233	-233	-233	-233	-233	-2091	2091
20	-94	-94	-94	-94	-94	-94	-94	-2091	2091
30	-177	-177	-177	0	-177	-177	-177	-2091	2091
40	-167	-167	-167	-167	-167	-167	-167	-2091	2091
50	-207	-207	-207	-207	-207	-207	-207	-2091	2091
60	-67	-67	-67	-67	-67	-67	-67	-2091	2091

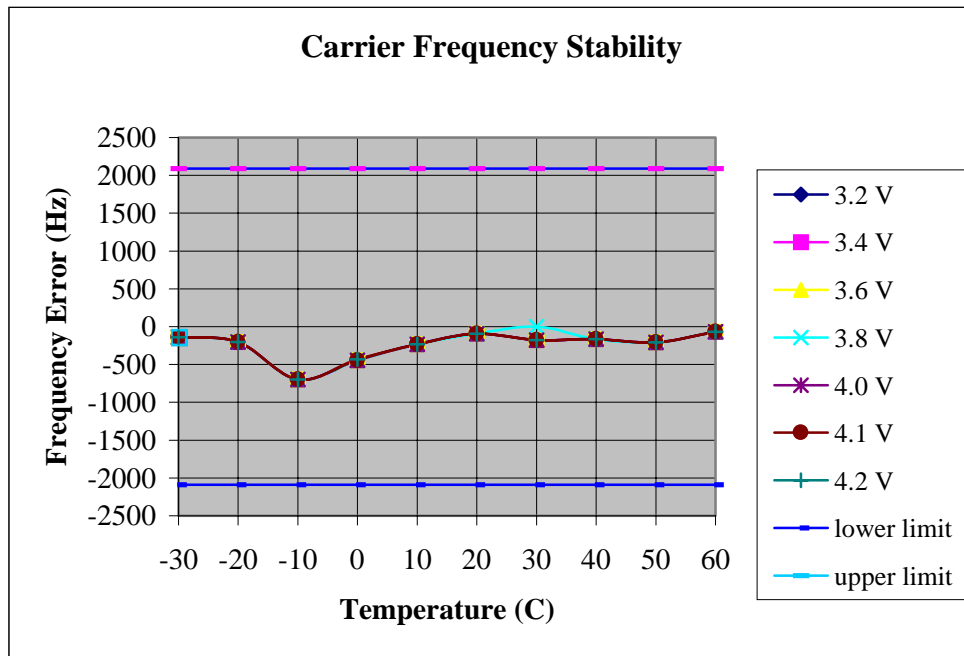

Transmitter RF Carrier Frequency Stability - FCC part 2.1055
Phone transmitting in CDMA mode in cellular band, but with no modulation on the carrier

Measured with HP 8560A Spectrum Analyzer, The test procedures and technique are stated in Exhibit 15.

Carrier Frequency : 836.49 MHz CDMA

Temperature (C)	Transmitter Carrier Frequency Deviation (Hz)							Specification	
	3.2 V	3.4 V	3.6 V	3.8 V	4.0 V	4.1 V	4.2 V	lower limit	upper limit
-30	-19	-19	-19	-19	-19	-19	-19	-2091	2091
-20	310	310	310	310	310	310	310	-2091	2091
-10	670	670	670	670	670	670	670	-2091	2091
0	811	811	811	811	811	811	811	-2091	2091
10	371	371	371	371	371	371	371	-2091	2091
20	130	130	130	130	130	130	130	-2091	2091
30	20	20	20	0	20	20	20	-2091	2091
40	-3	-3	-3	-3	-3	-3	-3	-2091	2091
50	-20	-20	-20	-20	-20	-20	-20	-2091	2091
60	-80	-80	-80	-80	-80	-80	-80	-2091	2091

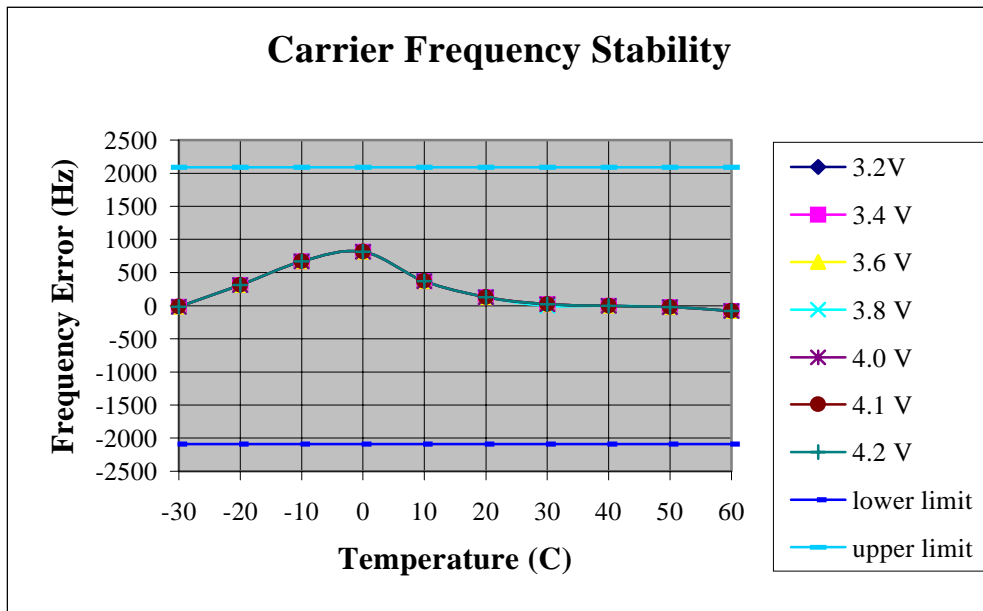

Exhibit 14

Transmitter RF Carrier Frequency Stability - FCC part 2.1055, 24.235

Transmitter RF Carrier Frequency Stability - FCC part 2.1055, 24.235

Phone transmitting in CDMA mode in PCS band, but with no modulation on the carrier

Measured with HP 8560A Spectrum Analyzer, The test procedures and technique are stated in Exhibit 15.

Carrier Frequency : 1880.00 MHz CDMA

Temperature (C)	Transmitter Carrier Frequency Deviation (Hz)							Specification	
	3.2 V	3.4 V	3.6 V	3.8 V	4.0 V	4.1 V	4.2 V	lower limit	upper limit
-30	-43	-43	-43	-43	-43	-43	-43	-4700	4700
-20	-890	-890	-890	-890	-890	-890	-890	-4700	4700
-10	-1550	-1550	-1550	-1550	-1550	-1550	-1550	-4700	4700
0	-1387	-1387	-1387	-1387	-1387	-1387	-1387	-4700	4700
10	846	846	846	846	846	846	846	-4700	4700
20	283	283	283	283	283	283	283	-4700	4700
30	0	0	0	0	0	0	0	-4700	4700
40	1493	1493	1493	1493	1493	1493	1493	-4700	4700
50	-35	-35	-35	-35	-35	-35	-35	-4700	4700
60	-218	-218	-218	-218	-218	-218	-218	-4700	4700

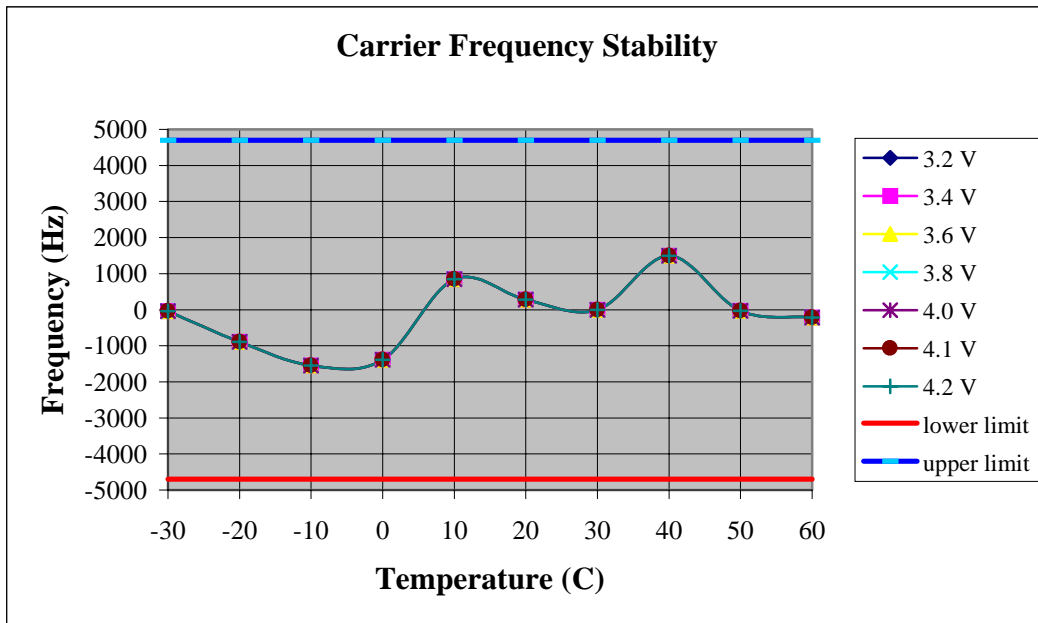

Exhibit 15

Measurement Procedures, Techniques and Minimum Requirements

List of Equipment

Computer with Phone_T software

Spectrum Analyzers

HP 8593EM, CAL DUE 4/15/2003

HP8594E, CAL DUE 03/03/2003

HP 8593EM, Cal due 08-November-2002

Agilent 8960, Cal due 27-June-2002

Audio Spectrum Analyzer

HP3588A, CAL DUE 02/08/2003

Communication Test Set

HP8920B, CAL DUE 12/12/2003

Power Meter

Giga-tronics 8541C, CAL DUE 2/19/2003

DC Power Supply

Measurement Procedures

RF Output Power

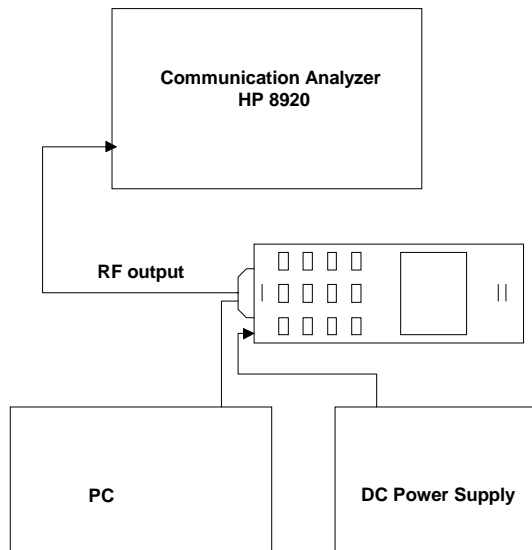

Definition - The output power rating of the transmitter is the power available at the output terminal of the transmitter when the terminal is connected to the normal load.

Method of Measurement - Measure the transmitter output carrier power without modulation using a communication test set for FM which has a RF wattmeter. A HP 8594E spectrum analyzer with the CDMA personality was used to measure CDMA mode.

Minimum Standard - The transmitter output power shall be maintained within +2 / -4 dB.

Modulation Audio Response

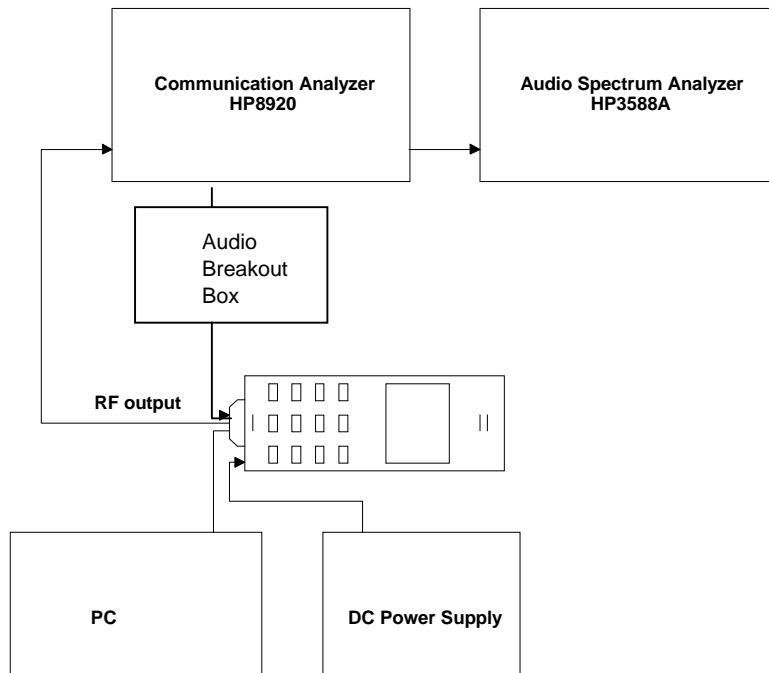

Definition - The transmitter audio frequency response is defined in terms of the degree of closeness with which the frequency deviation of the transmitter follows the prescribed 6 dB/octave pre-emphasis characteristic over a specified continuous audio frequency range while conforming to the required band-limiting conditions outside of that range.

Method of Measurement - Operate the transmitter with the compressor disabled, and monitor the output with HP8920 test receiver without de-emphasis. Apply a sine wave audio input to the transmitter external audio input port, vary the modulating frequency from 100 to 5000 Hz, and observe the input levels necessary to maintain a constant ± 2.9 kHz system deviation. Record the results. Adjust the audio input level to 20 dB greater than that required to produce ± 8 kHz deviation with 1 kHz tone. Vary the modulation frequency from 3 kHz to 30 kHz and observe the deviation while maintaining a constant audio input level. Use the audio spectrum analyzer to measure the output deviation at the same frequency as the input signal.

Minimum Standard - From 300 to 3000 Hz, the audio frequency response shall not vary more than +1 to -3 dB from a true 6 dB/octave pre-emphasis characteristic as referred to the 1000 Hz level (with the exception of a permissible 6 dB/octave roll-off from 2500 to 3000 Hz). Between 3 kHz to 30 kHz, the response shall not exceed that defined by the following table:

Frequency Range (f in kHz)	Attenuation Relative to 3 kHz (dB)
$3 \text{ kHz} \leq f \leq 5.9 \text{ kHz}$	$40 \log (f/3)$
$5.9 \text{ kHz} \leq f \leq 6.1 \text{ kHz}$	35
$6.1 \text{ kHz} \leq f \leq 15 \text{ kHz}$	$40 \log (f/3)$
$15 \text{ kHz} \leq f \leq 30 \text{ kHz}$	28

Modulation Limiting

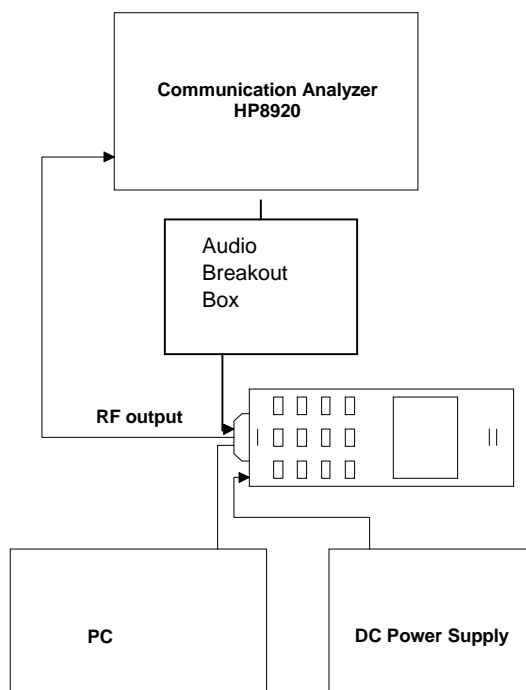

Definition - Modulation limiting refers to the ability of the transmitter circuits to prevent the transmitter from producing deviation in excess of rated system deviation.

Method of Measurement - With the compressor enabled and the SAT disabled, adjust the audio input for ± 8 kHz peak deviation at 1000 Hz. Increase the audio input level by 20 dB. With the input level held constant at the 20 dB, and observe the deviation for 400 Hz, 1000 Hz, and 2.7 kHz.

Minimum Standard - The peak deviation shall not exceed the rated system peak frequency deviation of ± 12 kHz at any time.

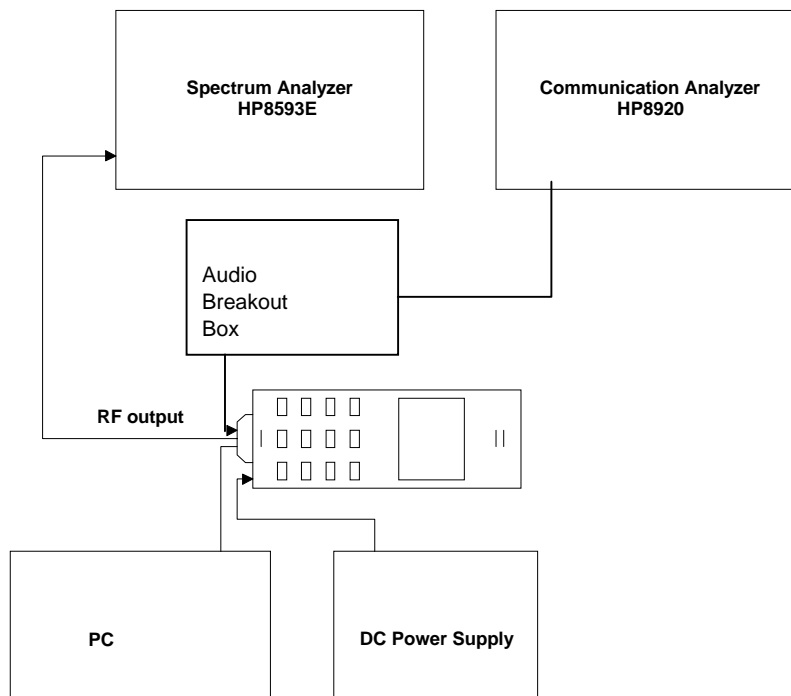
Occupied Bandwidth – (In Cellular Band)

Definition - The occupied bandwidth is defined as the spectrum noise produced at discrete frequency separations from the carrier due to all sources of unwanted noise within the transmitter in a modulated condition.

Method of Measurement - Use the spectrum analyzer and measure the following 8 modulating conditions: (1) For combined voice and SAT, disable the compressor, modulate with a 2500 Hz sine wave 13.5 dB greater than that required to produce ± 8 kHz peak deviation at 1000 Hz and a 6000 Hz SAT with ± 2.0 kHz peak deviation. (2) For combined Signaling Tone and SAT, modulate with a 10 kHz ST with ± 8 kHz peak deviation and a 6000 Hz SAT with ± 2.0 kHz peak deviation. (3) For wideband data, modulate with a quasi-random 10 kbps data pattern with ± 8 kHz peak deviation. (4) For CDMA, modulate with full rate. (4) For voice only, disable the compressor, modulate with a 2500 Hz sine wave 13.5 dB greater than that required to produce ± 8 kHz peak deviation at 1000 Hz. (5) For SAT only, modulate with a 6000 Hz SAT with ± 2.0 kHz peak deviation. (6) For ST only, modulate with a 10 kHz ST with ± 8 kHz peak deviation. (7) For combined SAT and DTMF, modulate with a 6000 Hz SAT with ± 2.0 kHz peak deviation and one of the DTMF tones.

Minimum Standard - The mean power of emissions from the transmitter with modulated carrier shall be attenuated below the mean power of the unmodulated carrier in accordance with the following.

- (1) For all modulation: In a 300 Hz bandwidth centered on any frequency removed from the carrier by greater than 20 kHz up to and including 45 kHz, at least 26 dB.
- (2) For modulation by combined voice and SAT: In a 300 Hz bandwidth centered on any frequency removed from the carrier frequency by greater than 45 kHz, at least $63 + 10 \log$ (mean output power in Watts) dBc. Since the equipment is rated 25.0dBm, the limit is 58.7dBc.
- (3) For modulation by wideband data and combined ST and SAT: In a 300 Hz bandwidth centered on any frequency:

- (a) More than 45 kHz up to and including 90 kHz, at least 45 dBc.
- (b) More than 90 kHz up to the first multiple of the carrier frequency, at least $63 + 10 \log$ (mean power in Watts) dBc.

In addition, in a 30 kHz bandwidth centered anywhere between 869 and 894 MHz, the mean power of emissions from the transmitter with modulated carrier shall not exceed -80 dBm.

Occupied Bandwidth – (In PCS Band)

The procedure has been stated in Exhibit 9

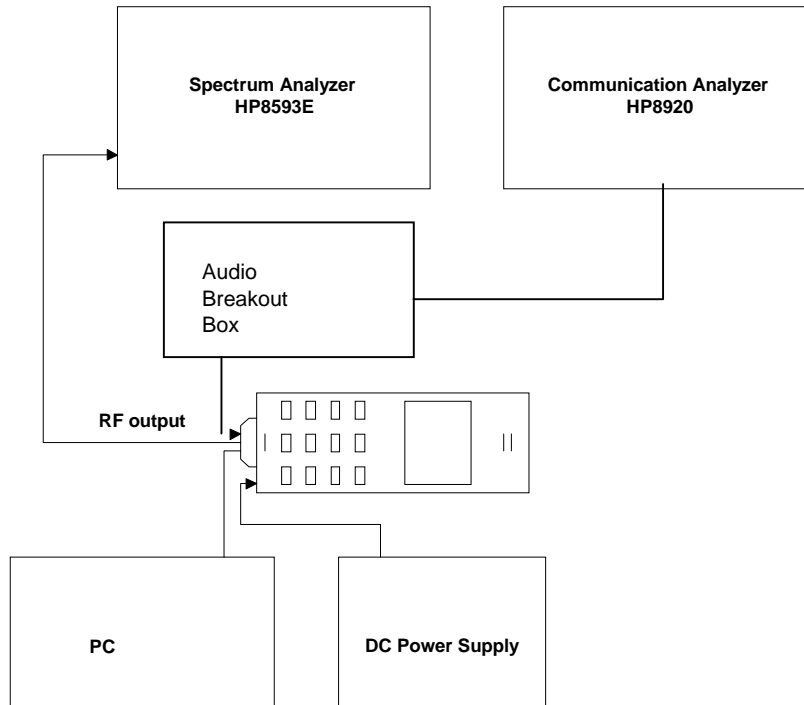
Conducted Spurious and Harmonic Emissions at Antenna Terminal

Definition - The conducted harmonic and spurious emissions are emissions at the antenna terminals on a frequency or frequencies that are outside the authorized bandwidth of the transmitter.

Method of Measurement - The transmitter shall be alternately modulated with combined voice and SAT and with wideband data. For combined voice and SAT measurements, disable the compressor, modulate with a 2500 Hz sine wave 13.5 dB greater than that required to produce ± 8 kHz peak deviation at 1000 Hz and a 6000 SAT with ± 2.0 kHz peak deviation. For wideband data measurements, the transmitter shall be modulated with a quasi-random 10 kbps data pattern with ± 8 kHz peak deviation. The measurement shall be made with a spectrum analyzer from the lowest radio frequency generated in the equipment to the 10th harmonic of the carrier except for that region within 75 kHz of the carrier frequency.

Minimum Standard - Conducted harmonic and spurious emissions shall be attenuated below the level of emissions of the carrier frequency by at least $43 + 10 \log$ (mean output power in Watts) dB.

Radiated Spurious and Harmonic Radiation

Definition - The radiated spurious emissions are emissions from the subscriber unit with the attached antenna fully extended. The radiated spurious emissions include those emissions radiated from the attached antenna as well as the equipment cabinet and attached cables.

Method of Measurement - The measurement shall be conducted at standard radiation test site with a search antenna which is movable vertically and is rotatable 90 degrees for vertically and horizontally polarized signals.

Minimum Standard - Radiated spurious emissions shall be attenuated below the maximum level of emission of the carrier frequency by at least $43 + 10 \log$ (mean output power in Watts) dB.

Frequency Stability

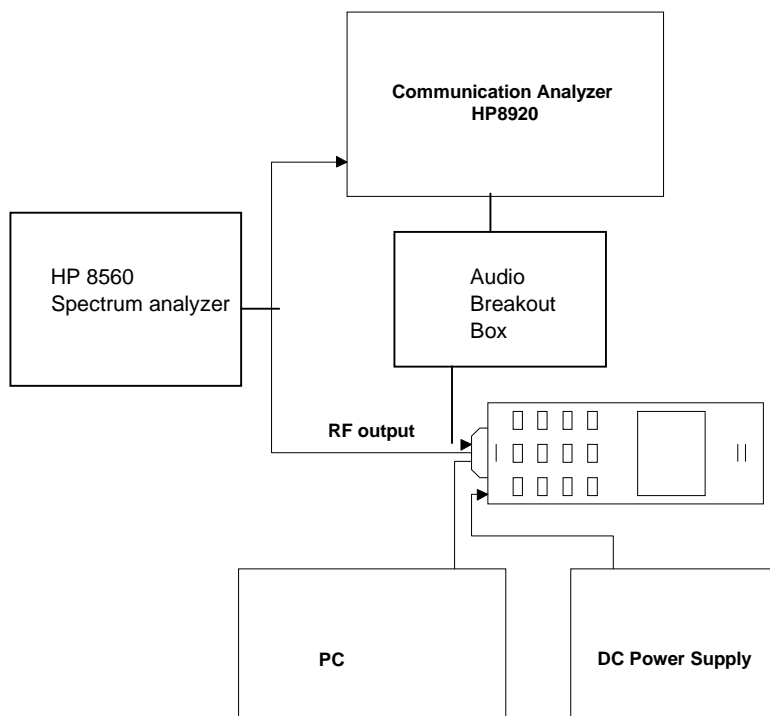

Definition - The frequency stability is the ability of the transmitter to maintain an assigned carrier frequency.

Method of Measurement - Use the communication tester to sample the transmitter RF output signal and measure its frequency. Vary the ambient temperature from -30 to +60 °C, and also vary the DC supply voltage to the equipment from 3.4 to 4.2 V at each temperature.

Minimum Standard - The transmitter carrier frequency shall be maintained within ± 2.5 ppm.

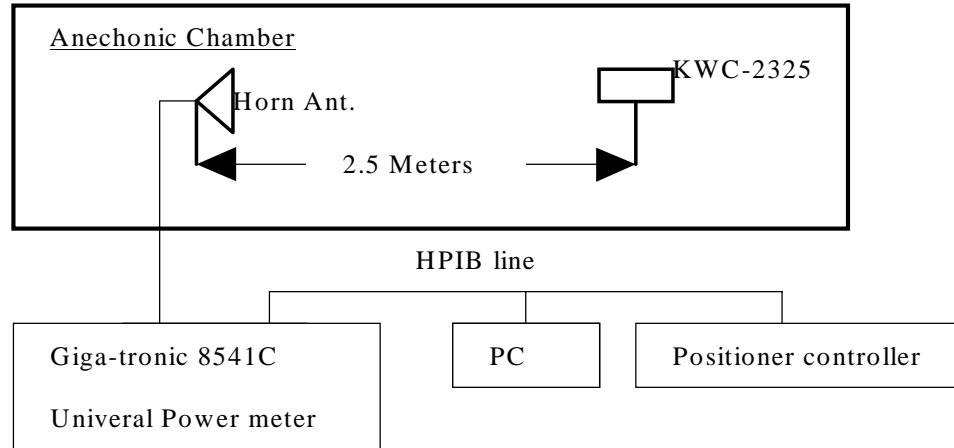
ERP/EIRP measurement**Test Setup –****Measurement Method –**

Set KWC-2325 conducted power level using phone_t software (KWC phone control software), then mount it on PVC pipe inside the chamber, rotate the phone 360degree in azimuth and elevation. The horn antenna receives the handset signal from 2.5 meters away. The computer will record the maximum radiated power taking into consideration of all path losses. The entire measurement is controlled by 959 automated antenna measurement workstation software by Flam & Russel Inc.

Minimum Standard –

The maximum output power in a FM mode in cellular band shall be no more than -2 dBw. The maximum output power in a CDMA mode in cellular band shall be in the range of -7 dBw to 0 dBw. The maximum output power in a CDMA mode in PCS band shall be in the range of -7 dBw to 0 dBw.

Exhibit 16

List of Semiconductor Devices

Included in the part list in separate attachments

Exhibit 17

Product Overview and Circuit Diagrams

Technical Description

The Trimode Phone consists of an Analog FM mode and Code Division Multiple Access (CDMA) mode in the cellular band, and CDMA mode in the PCS band. The analog transmitter is only for use in the Cellular Radiotelephone Service Part 22 of the CFR. The Portable Phone is designed to meet the requirements of TIA/EIA/IS-98-B&D standards for Dual-Mode Wideband Spread Spectrum Cellular Mobile Stations, and ANSI J-STD_018 standard for 1.8GHz to 2.0GHz Code Division Multiple Access (CDMA) Personal Stations.

Frequency Range of operation: 824 - 849 MHz transmitter and 869 - 894 receiver for cellular band. 1850 – 1910MHz transmitter and 1930 – 1990 receiver for PCS band. Nominal RF power output is: 0.48W for FM in cellular band (ERP) and 0.42W for CDMA in PCS band (EIRP).

Power Supply requirements: 4.2V DC Li-Ion battery.

Modulation:

The audio input is sampled, digitally limited, and then filtered to amplitude and frequency limit the signal applied to the modulator. The device supports the AMPS standard. The device has an operating temperature range of -30 to +60 C. The functions include Compandor, PLL lock detect for received data, audio signal filtering for signals.

Power limiting:

Transmitted power is monitored by a RF detector diode which is coupled from the Power Amplifier (PA) output. The detected DC voltage is fed into a microprocessor which uses a calibration table along with an offset correction and temperature correction table to control power limits. When the RF power exceeds a predetermined limit the gain of the stage preceding the PA is reduced.

Block and Circuit Diagrams

Block and circuit diagrams are included in separate attachments.

Exhibit 18

FCC Identification Label Information

Included in the separate attachment.

Exhibit 19

Photographs

The photographs are in a separate attachment.

Exhibit 20

Users Manuel

The user's guide is in a separate attachment.

Exhibit 21

Statement of SAR compliance and SAR DATA

The statement and SAR data is in a separate attachment.

Exhibit 22

FCC Compliance Emergency 911, FCC Part 22, Paragraph 22.921

When an emergency 911 call is originated by the user, the mobile will attempt to acquire any available system and originate the emergency call on that system, disregarding restrictions set by the roaming list. The FCC NPRM WT99-13, CC94-102 automatic analog A/B roaming option has been implemented for 911 emergency calls. Note that the KWC-2325 has Global Positioning System (GPS) support.

Exhibit 23

TTY compliance, FCC Section 255 of the Telecom Act

Attached letter in the proceeding page is the Statement of TTY Compliance with Cellular Compatibility Standard for KWC-2325 from KWC Interoperability Test group.

May 17, 2002

Subject: Statement of TTY Compliance with Cellular Compatibility Standard for Kyocera 2325

Reference documents:

CDG Stage 2 Interoperability Tests (CDG 57), March 26, 2001 Revision 1.0

3GPP2 C.S0028 CDMA TTY/TDD Minimum Performance Specification, April 24, 2001 Version 1.0

TIA/EIA/IS-127-2

To Whom It May Concern:

This letter is an attestation that Kyocera Wireless Corp has tested the Kyocera 2325 and that it is compliant with TTY functional requirements.

If you have any questions, or need further clarification, please do not hesitate to contact me.

Regards,

Erick Polk
Interoperability Test Manager
QCP, Inc. representing Kyocera Wireless Corp.
(858) 882-2579

Exhibit 24

Occupied Bandwidth and Spurious Emission Measure data

KWC-2325 supports additional reverse channels, as per IS-98, additional measurement were taken to show compliance. See a separate attachment.