

Cover Letter

Federal Communications Commission
Authorization and Evaluation Division

Re: Application for Cellular and PCS Transceiver Type Acceptance

Kyocera Wireless Corporation (KWC) herein submits the Application for Equipment Authorization (FCC Form 731) and Exhibits for Type Acceptance of a Cellular & PCS Transceiver, FCC ID: OVFKWC-2135.

Applicant: Kyocera Wireless Corporation
10290 Campus Point Drive
San Diego, CA 92121-1522

Manufacture: Kyocera Wireless Corporation
10290 Campus Point Drive
San Diego, California 92121

The equipment, KWC model # 2135, is for mobile station cellular and PCS system use. The 2135 is in full compliance with all parts of EIA/TIA/IS-98-B Mobile Station-Land Station Compatibility Specification, issue July 1998, and also in full compliance with all parts of ANSI J-STD-018, Recommended Minimum Performance Requirements for 1.8 to 2 GHz Code Division Multiple Access (CDMA) Personal Stations, issue July 1996.

Information concerning how the ESN protection requirements are met is provided in Exhibit 3.

Kyocera Wireless Corporation

Robert J Scodellaro
EMC Engineer, Staff/Manager

Request of Confidentiality

Federal Communications Commission
Authorization and Evaluation Division

Re: Request of Confidentiality

Pursuant to Sections 0.457 and 0.459 of the Commission's Rules, the Applicant hereby requests confidential treatment of information accompanying this Application as outlined below:

All schematics/block diagrams
All parts lists

The above materials contain trade secrets and proprietary information not customarily released to the public. The public disclosure of these matters might be harmful to the Applicant and provide unjustified benefits to its competitors.

The Applicant understands that pursuant to Rule 0.457, disclosure of this Application and all accompanying documentation will not be made before the date of the Grant for this Application.

Kyocera Wireless Corporation

Robert J Scodellaro
EMC Engineer, Staff/Manager

List of Exhibits

<u>Exhibit</u>	<u>Description</u>	<u>FCC Reference</u>
1	Certification of Test Data	2.911
2	General Information	2.1033(c), 2.1061,
3	ESN Protection	22.919
4	RF Output Power Measured Data - Cellular	2.1046
5	RF Output Power Measured Data - PCS	2.1046, 24.232
6	Modulation Audio Response Measured Data	2.1047(a)
7	Modulation Limiting Measured Data	2.1047(b), 22.917
8	Occupied Bandwidth and Spurious Emission Measured Data - Cellular	2.1049, 22.917
9	Occupied Bandwidth and Spurious Emission Measured Data - PCS	2.1049, 24.238
10	Conducted Harmonics Emissions Measured Data - Cellular	2.1051, 22.917, 22.901(d)
11	Conducted Harmonics Emissions Measured Data - PCS	2.1051, 24.238
12	Frequency Stability vs. Temperature and Voltage Measured Data - Cellular	2.1055
13	Frequency Stability vs. Temperature and Voltage Measured Data - PCS	2.1055, 24.235
14	Measurement Procedures and Techniques	
15	Circuit Diagram	2.1033(c)

Exhibit 1

Certification of Test Data

The data, data evaluation and equipment configuration represented herein are a true and accurate representation of the measurements of the sample's radio frequency interference emissions characteristics as of the dates and at the times of the test under the conditions herein specified. This applies to all tests that were performed that did not require an Open Area Test Site (OATS). Tests that required an OATS site were performed by TUV Product Services.

Equipment Tested: 2135

Dates of Test: April 19-May 1 2001

Test Performed by:

EMC Engineer, Staff/Manager:
Robert J Scodellaro

Exhibit 2

General Information

1. Production Plans

Quantity Production Planned

2. Technical Description - Section 2.1033 (c)

(1) The full name and mailing address of the manufacturer of the device and the applicant

Applicant: Kyocera Wireless Corporation
10290 Campus Point Drive
San Diego, CA 92121

Manufacture: Kyocera Wireless Corporation
10290 Campus Point Drive
San Diego, CA92121

(2) FCC Identifier

FCC ID: OVFKWC-2135

(3) User's Manual

Sent separate

(4) Types of Emission

40K0F8W
40K0F1D
1M25F9W

F3E voice
F3D supervisory audio tones, signaling tones
F1D wideband data signal

(5) Frequency range

The frequency range of the equipment in Domestic Public Cellular Radio Telecommunications Service bands, 824 - 849 MHz and 869 - 894 MHz for FM and cellular CDMA. The channel spacing is 30 kHz for FM.

The frequency range of the equipment in the Personal Communications Services (PCS) bands, 1850 – 1910 MHz and 1930 – 1990 MHz. The channel spacing is 1.25 MHz for CDMA.

(6) Operating power levels

The transmitter output power is independent of whether the equipment operates in the cellular system FM or CDMA mode, or PCS system CDMA mode. The equipment supports Class 3 Cellular Mobile Station Power Class, and Class 2 PCS Mobile Station Power Class. Its power output capability is reported to the Land Station via Station Class Mark. The equipment will respond to commands from the Land Station to change power levels as defined in the EIA/TIA/IS-98 and ANSI J-STD-018 Specification.

(7) Maximum output power

The equipment supports the maximum output power for Class 3 Cellular Mobile Station which is -2 dBW ERP for a FM mode and in the range of -7 dBW to 0 dBW ERP for a CDMA mode, and meets the 7 W ERP (+8.45 dBW) maximum power limitation of Section 22.913.

The equipment supports the maximum output power for Class 2 PCS Mobile Station which is in the range of -7dBW to 0 dBW EIRP, and is within the limited 2 watts E.I.R.P. peak power of CFR 47 Part 24.232 (b). The equipment is able to limit the output power to the minimum necessary for successful communications.

(8) Final RF amplifying device power consumption

The equipment is powered by lithium ion rechargeable batteries which have a voltage range of 3.4 to 4.2 Vdc.

In the Cellular band, the power consumption of the high power amplifier is about 31dBm watts. In the PCS band, the power consumption of the high power amplifier is about 27.9dBm.

(9) Tune-up procedure over the power range

All frequency and power adjustments are set at the factory and there are no field adjustments for this product. Under digital mode, frequency is locked to the base station and controlled by VCTCXO adjustments to offset any possible errors.

(10) Circuit description

(a) Circuit diagram and list of semiconductor device

See parts list that was sent separate

(b) Circuit description for frequency determining and stabilizing

The circuit provided for determining and stabilizing frequency is shown in the schematics.

A voltage controlled, temperature compensated, crystal oscillator (VCTCXO) is employed as a frequency reference for all of the transceiver local oscillators. This crystal oscillator is specified to remain within +/- 2.5 ppm over temperature and voltage variations. The lock status indicator of all synthesizers is monitored by the microprocessor and an out of lock condition will inhibit transmission. In

all modes, the mobile receiver monitors the received signal and adjusts the frequency of the VCTCXO, this corrects any errors between the mobile frequency and the base station transmitter. The mobile is locked to the base station.

(c) Circuit description for spurious radiation suppression

The circuit provided for suppression of spurious radiation is in the schematics.

The transmitter front end provides filtering of the RF signal in order to meet FCC specifications. For radiated spurious suppression, proper design techniques and the use of proper shielding techniques reduced the emission levels well below the permissible FCC limit.

(d) Circuit description for limiting modulation

The circuit provided for limiting modulation is in the schematics.

AMPS Mode

The F3E audio modulation is accomplished through the use of Digital Signal Processor (DSP). The audio signal is converted to digital samples at 8 kHz sample rate. The samples are filtered, integrated, interpolated, and phase modulated at a 40 kHz rate. The resulting signal is then decomposed into I and Q signals, oversampled again at 160 kHz rate, and then sent to the digital-to-analog converter after proper filtering. The transmit audio modulation limiting function is performed digitally in the DSP. The pre-emphasis is performed through an IIR filter and the filtering of audio frequencies is performed through a FIR filter in DSP. The combined performance of these filters is shown in Exhibit 6 along with the actual audio frequency response of the modulated carrier signal. The DSP clocks are locked to the reference VCTCXO output signal, and maintained within ± 2.5 ppm tolerance.

CDMA Mode

The CDMA mode is described in the following pages from the TIA/EIA /IS-95B Standard. The justification for the CDMA bandwidth of 1.25 MHz is that the chip rate is 1.2288 MHz (see page 6-35 of IS-95B). The 1.25MHz is measured at the 3dB down bandwidth. Channel spacing is normally set at this 1.25 MHz. In addition the reference baseband filtering requirements are shown on page 6-60 of IS95B. The Z-transform filter coefficient for the recommended baseband filter are shown on page 6-61, and also yield a "necessary bandwidth" of 1.25 MHz based on optimal detection and channel capacity theory.

6.1.3 Modulation Characteristics

6.1.3.1 Reverse CDMA Channel Signals

The Reverse CDMA Channel is composed of Access Channels and Reverse Traffic Channels. These channels shall share the same CDMA frequency assignment using direct-sequence CDMA techniques. Figure 6.1.3.1-1 shows an example of all of the signals received by a base station on the Reverse CDMA Channel. Each Traffic Channel is identified by a distinct user long code sequence; each Access Channel is identified by a distinct Access Channel long code sequence. Multiple Reverse CDMA Channels may be used by a base station in a frequency division multiplexed manner.

The Reverse CDMA Channel has the overall structure shown in Figure 6.1.3.1-2. Data transmitted on the Reverse CDMA Channel is grouped into 20 ms frames. All data transmitted on the Reverse CDMA Channel is convolutionally encoded, block interleaved, modulated by the 64-ary orthogonal modulation, and direct-sequence spread prior to transmission.

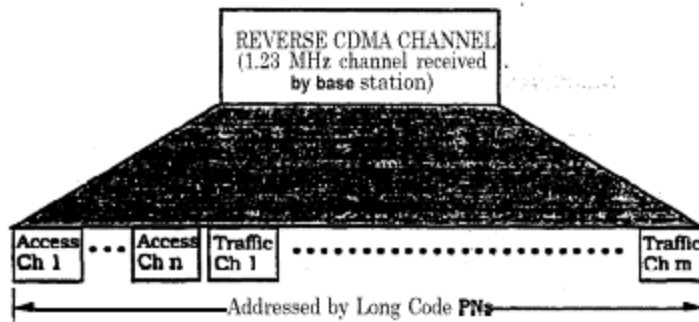

Figure 6.1.3.1-1. Example of Logical Reverse CDMA Channels Received at a Base Station

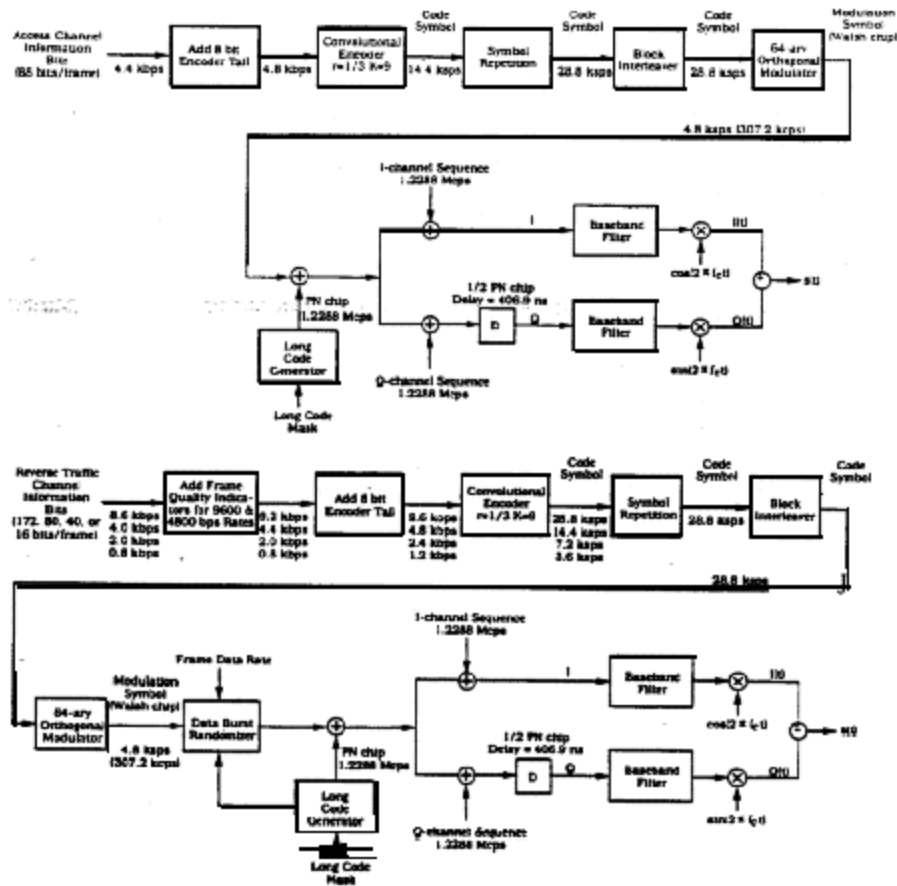

Figure 6.1.3.1-2. Reverse CDMA Channel Structure

After adding frame quality indicators for both the 9600 bps and 4800 bps rates (see 6.1.3.3.2.1) and adding eight Encoder Tail Bits (see 6.1.3.3.2.2), data frames may be transmitted on the Reverse Traffic Channel at data rates of 9600, 4800, 2400, and 1200 bps. The Reverse Traffic Channel may use any of these data rates for transmission. The transmission duty cycle on the Reverse Traffic Channel varies with the transmission data rate. Specifically, the transmission duty cycle for 9600 bps frames is 100 percent, the transmission duty cycle for 4800 bps frames is 50 percent, the transmission duty cycle for 2400 bps frames is 25 percent, and the transmission duty cycle for 1200 bps frames is 12.5 percent as shown in Table 6.1.3.1.1-1. As the duty cycle for transmission varies proportionately with the data rate, the actual burst transmission rate is fixed at 28.800

code symbols per second. Since ~~six~~ code symbols are modulated as one of 64 modulation symbols for transmission, the modulation **symbol** transmission rate is fixed at 4800 modulation symbols per second. This results in a **fixed** Walsh chip rate of 307.2 kcps. The rate of the spreading PN sequence is fixed at 1.2288 Mcps, so that each Walsh chip is spread by four PN chips. Table 6.1.3.1.1- 1 defines the signal rates and their relationship for the various transmission rates on the Reverse Traffic Channel.

The numerology is identical for the Access Channel except that the transmission rate is **fixed** at 4800 bps after adding eight Encoder Tail Bits (see 6.1.3.2.2). Each code symbol is repeated once, and the transmission duty cycle is 100 percent. Table 6.1.3.1.1-2 defines the signal rates and their relationship on the Access Channel.

6.1.3.1.1 Modulation Parameters

The modulation parameters for the Reverse Traffic Channel and the Access Channel are shown in Table 6.1.3.1.1- 1 and Table 6.1.3.1.1-2, respectively.

Table 6.1.3.1.1-1. Reverse Traffic Channel Modulation Parameters

Parameter	Data Rate (bps)				Units
	9600	4800	2400	1200	
PN Chip Rate	1.2288	1.2288	1.2288	1.2288	Mcps
Code Rate	1/3	1/3	1/3	1/3	bits/code sym
Transmit Duty Cycle	100.0	50.0	25.0	12.5	%
Code Symbol Rate	28,800	28,800	28,800	28,800	sps
Modulation	6	6	6	6	code sym/mod symbol
Modulation Symbol Rate	4800	4800	4800	4800	sps
Walsh Chip Rate	307.20	307.20	307.20	307.20	kcps
Mod Symbol Duration	208.33	208.33	208.33	208.33	µs
PN Chips/Code Symbol	42.67	42.67	42.67	42.67	PN chip/code symbol
PN Chips/Mod symbol	256	256	256	256	PN chip/mod symbol
PN Chips/Walsh Chip	4	4	4	4	PN chips/Walsh chip

(e) Circuit description for limiting power

Transmitted power is monitored by a RF detector diode which is coupled from the Power Amplifier (PA) output. The detected DC voltage is fed into a microprocessor which uses a calibration table along with an offset correction and temperature correction table to control power limits. When the RF power exceeds a predetermined limit the gain of the stage preceding the PA is reduced.

(11) Photograph of the identification label

Sent separate

(12) Photograph to reveal equipment construction and layout

Sent separate

Exhibit 3

ELECTRONIC SERIAL NUMBERS (ESN) Protection

The 2135Trimode Phone, FCC ID: OVFKWC-2135 uses ESN. The ESN is a unique identification number to each phone which is contained in the Numeric Assignment Module and is automatically transmitted to the base station whenever a call is placed. The ESN is stored in an EPROM and is isolated from fraudulent contact and tampering. Any attempt to change the ESN will render the portable phone inoperative.

The phone complies with all requirements for ESN under Part 22.919.

Exhibit 4**Transmitter RF Power Output - FCC part 2, Paragraph 2.1046****Transmitter RF Power Output - FCC part 2, Paragraph 2.1046**

4/19/2001

Conducted Power --

The RF output power was measured using a Gigatronics 8541C Power Meter.

carrier frequency (MHz)	channel	RF output power (W) - Cellular	
		Measured	
		FM	CDMA
824.04	991	0.400	
824.7	1013		0.321
836.49	383	0.401	0.320
848.31	777		0.317
848.97	799	0.398	

Transmitter RF Power Output - FCC part 2, Paragraph 2.1046**Transmitter RF Power Output - FCC part 2, Paragraph 2.1046**

4/19/2001

Radiated Power --The RF output power (**ERP**) was measured in an antenna range anechoic chamber.

carrier frequency (MHz)	channel	RF output power (W) – Cellular	
		Measured	
		FM	CDMA
824.04	991	0.600	
824.7	1013		0.501
836.49	383	0.625	0.500
848.31	777		0.497
848.97	799	0.615	

Exhibit 5

Transmitter RF Power Output - FCC part 24, Paragraph 2.1046, 24.232 (b)

Transmitter RF Power Output - FCC part 24, Paragraph 2.1046, 24.232 (b)

4/19/2001

Conducted power --

The RF output power was measured using a Gigatronics 8541C Power Meter.

carrier frequency (MHz)	channel	RF output power (W) - PCS
		CDMA
		measured
1851.25	25	0.178
1880	600	0.180
1908.75	1175	0.183

Transmitter RF Power Output - FCC part 24, Paragraph 2.1046, 24.232 (b)**Transmitter RF Power Output - FCC part 24, Paragraph 2.1046, 24.232 (b)**

4/19/2001

Radiated power --

The RF output power, **EIRP** was measured in an antenna range anechoic chamber.

carrier frequency (MHz)	channel	RF output power (W) - PCS
		CDMA
		measured
1851.25	25	0.324
1880	600	0.332
1908.75	1175	0.414

Exhibit 6

Modulation Audio Response Measured Data FCC Part 2, Paragraph 2.1047 (a)

Baseband Audio Response

TOLR (Reverse Link)

V1 TOLR

2001-01-16 14:21 AMPS Test System Type 6709 V1.10 C:\.....\TEMPL

Transmit GTIA P.3.3.2.5 Input for 2.9kHz P
V1 SLA testing TOLR (900 Ohm) -42.17 dBu/Pa P
P2U SLA (600 Ohm) 16.48 dBu/Pa

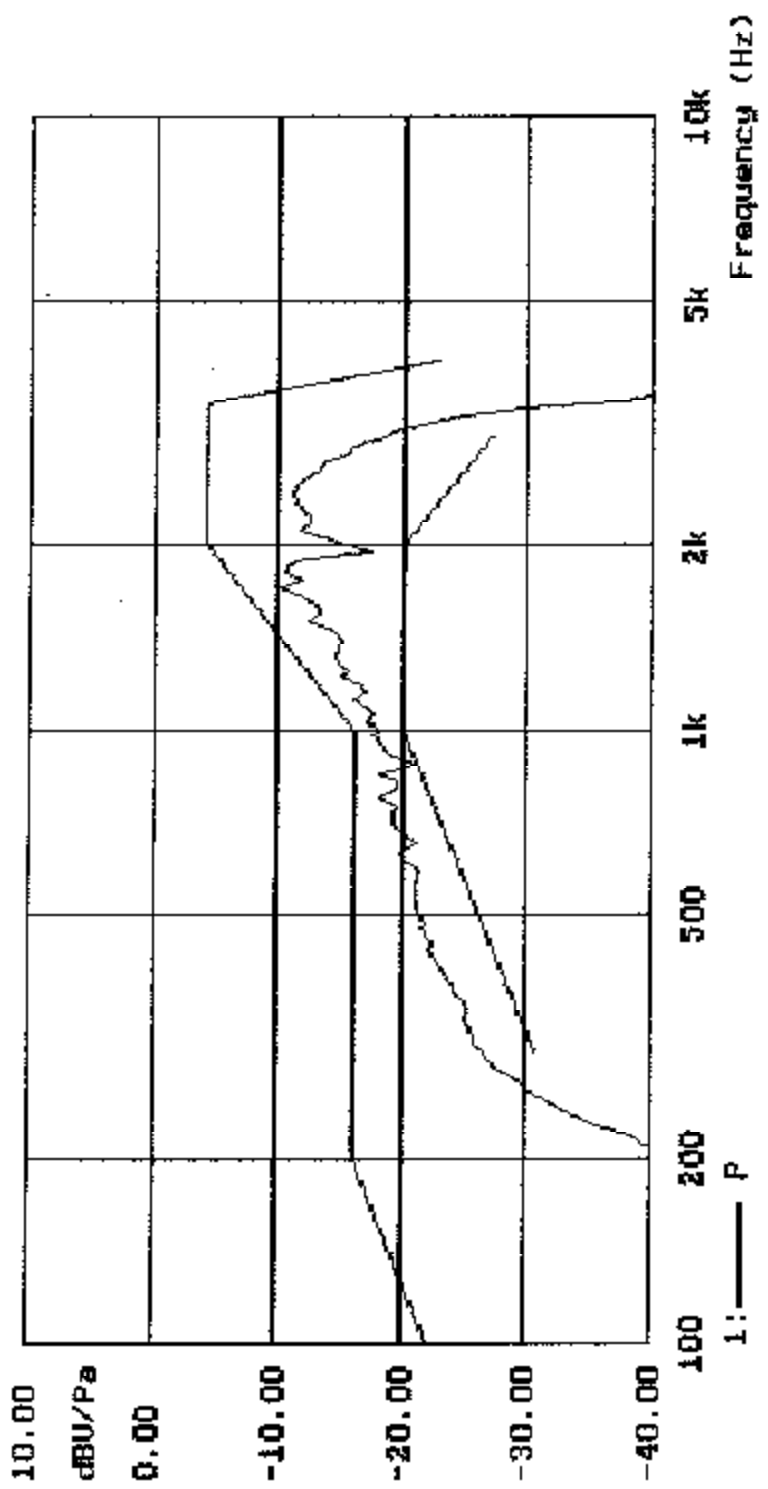

Transmitter Modulation Requirement - FCC part 2, Paragraph 2.1047 (a), FCC part
22,
Paragraph 22.917

Measured with HP8920 RF communication test set & HP 3588A spectrum analyzer
Measurements above 3,700 Hz were not possible due to excessively high audio tone.

Audio Frequency Response (<3 kHz)

	audio freq (Hz)	audio level (mV)	dB relative to 1 kHz	lower limit	upper limit
1	100	902	-33.53	-23	-19
2	126	761	-32.05	-21	-17
3	158	331	-24.82	-19	-15
4	200	147	-17.77	-17	-13
5	251	97.9	-14.24	-15	-11
	300	76.1	-11.31	-13.5	-9.5
6	316	69.9	-11.31	-13	-9
7	398	52.2	-8.78	-11	-7
8	501	39.5	-6.36	-9	-5
9	631	30.8	-4.20	-7	-3
10	794	23.8	-1.96	-5	-1
11	1000	19	0.00	-3	1
12	1259	14.7	2.23	-1	3
13	1585	11.5	4.36	1	5
14	1995	9.02	6.47	3	7
15	2512	7.48	8.10	5	9
16	2700	7.25	8.37	5.63	9.63
17	2800	7.29	8.32	5.94	9.94
18	3000	8.3	7.19	6.54	10.54
19	3100	9.03	6.46		
20	3200	10.6	5.07		
21	3300	13.5	2.97		
22	3500	38.7	-6.18		
23	3700	388	-26.20		

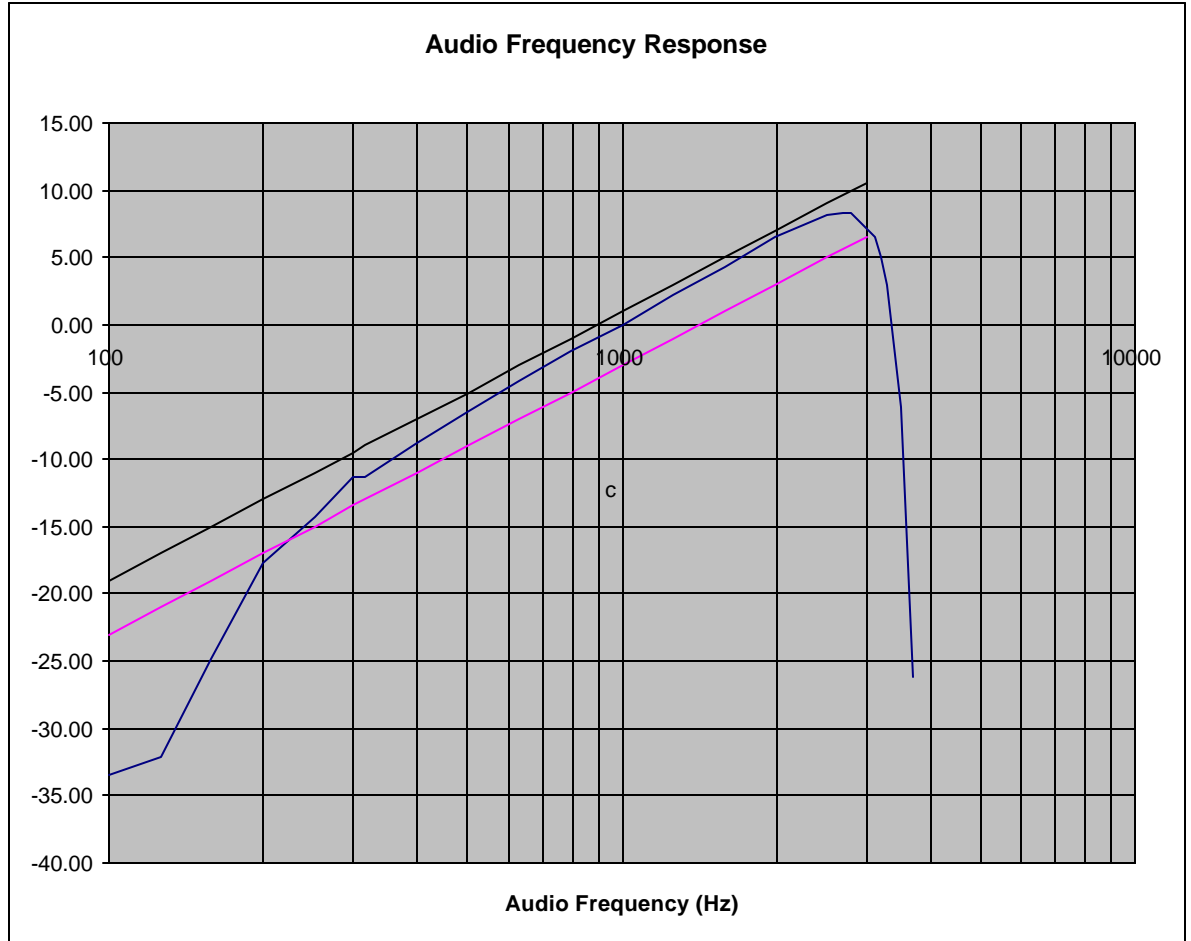

Audio Frequency Response (> 3 kHz)

freq	dev (dB)	dB from 3 kHz	upper limit
3000	-3.97	0.00	0.00
3500	-12.16	-8.19	-2.68
4000	-65.5	-61.53	-5.00
4500	-58.89	-54.92	-7.04
5000	-64.81	-60.84	-8.87
5900	-68.17	-64.20	-11.75
5900	-68.17	-64.20	-35.00
6000	-70.6	-66.63	-35.00
6100	-73.06	-69.09	-35.00
6100	-73.06	-69.09	-12.33
7000	-68.45	-64.48	-14.72
8500	-69.25	-65.28	-18.09
10000	-70.74	-66.77	-20.92
12000	-65.48	-61.51	-24.08
15000	-68.04	-64.07	-27.96
20000	-60.41	-56.44	-28.00
25000	-59.06	-55.09	-28.00
30000	-55.11	-51.14	-28.00

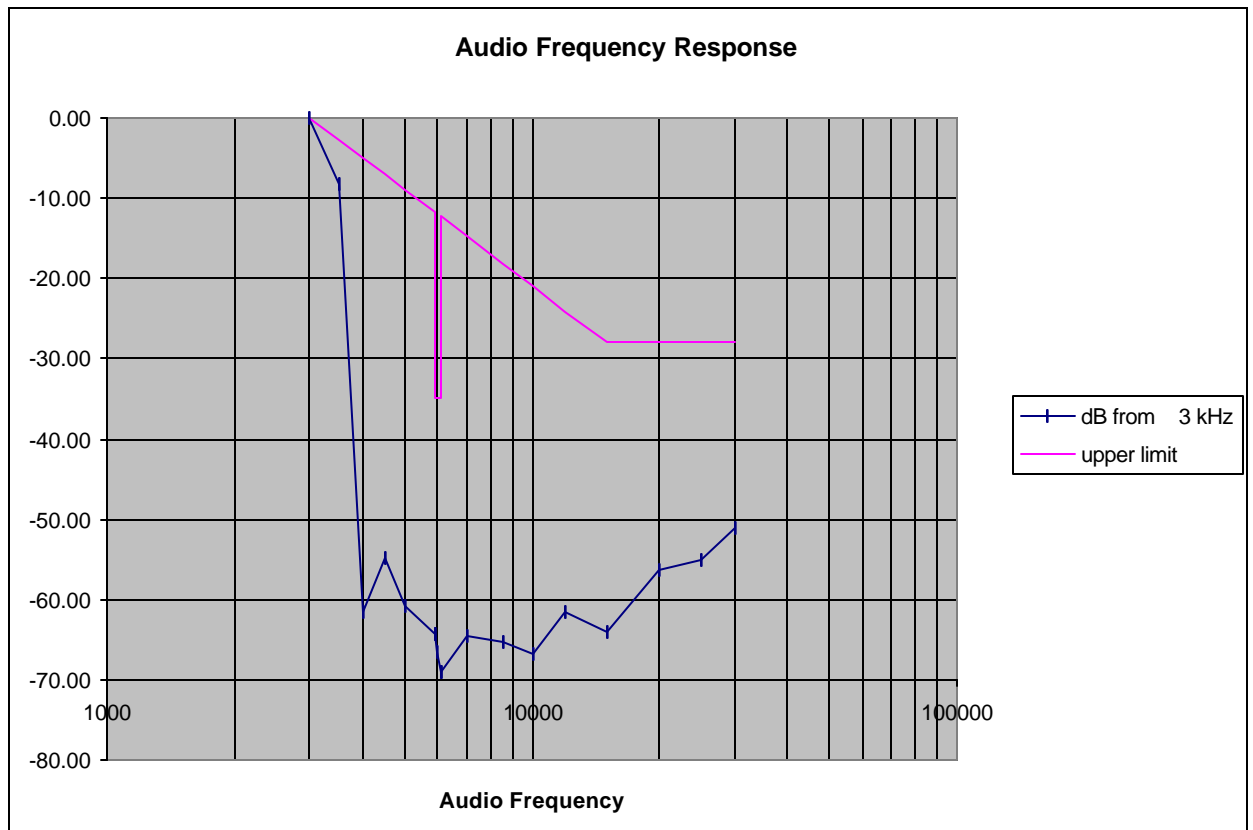

Exhibit 7

Transmitter Modulation Requirement - FCC Part 2, Paragraph 2.1047 (b)

Transmitter Modulation Requirement - FCC part 2, Paragraph 2.1047 (b)

Measured with HP8920 RF communication test set

Modulation Limiting

audio input level (dB) (0dB=8kHz dev)	FM deviation (kHz peak)		
	modulation frequency		
	400 Hz	1 kHz	2.7 kHz
-25	2.08	2.81	5.63
-20	2.17	3.47	7.25
-15	2.41	4.04	8.41
-10	2.66	5.01	8.95
-5	3.06	6.27	9.23
0	3.72	8.00	9.62
5	4.69	9.42	9.98
10	9.38	10.17	10.20
15	10.17	10.58	10.27
20	10.26	10.34	10.15

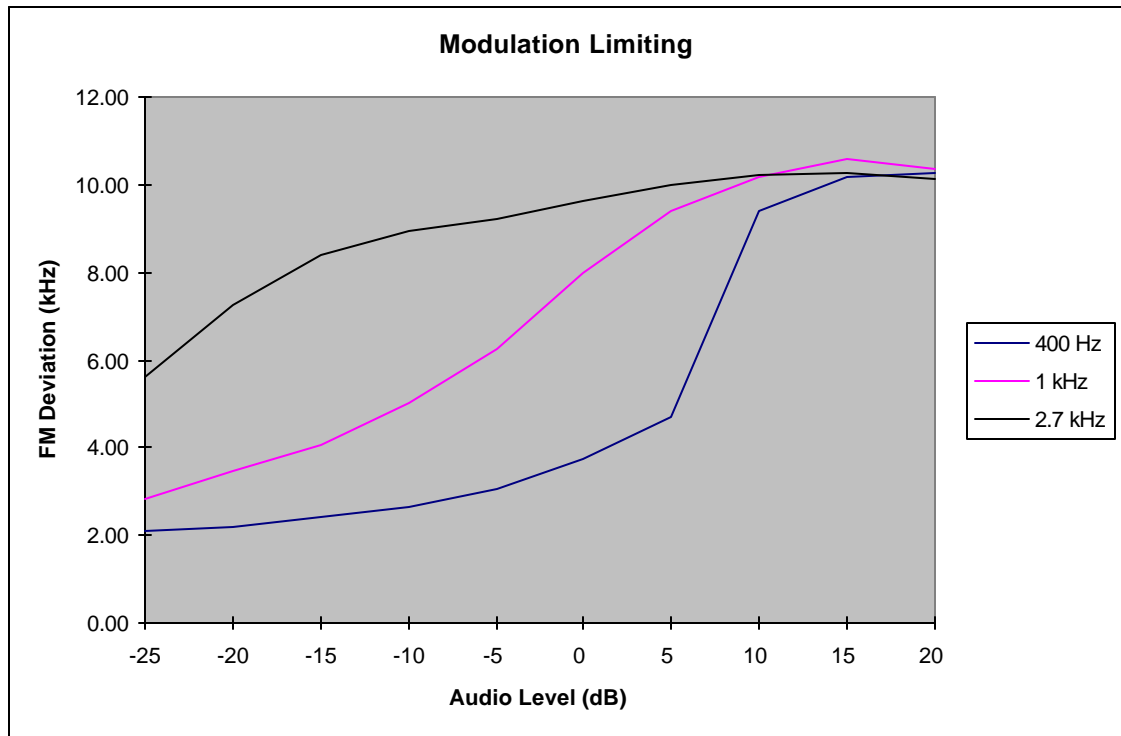

Exhibit 8**Occupied Bandwidth and Spurious Emission Measured Data****List of Exhibits**

<u>Exhibit</u>	<u>Description</u>	<u>FCC Reference</u>
a-1	AMPS voice, ± 100 kHz from carrier frequency	2.1049, 22.917
a-2	AMPS voice, 0 Hz to 850 MHz	2.1049, 22.917
a-3	AMPS voice, 800 MHz to 3rd harmonic	2.1049, 22.917
a-4	AMPS voice, 869 - 894 MHz	2.1049, 22.917
b-1	AMPS voice + SAT, ± 100 kHz from carrier frequency	2.1049, 22.917
b-2	AMPS voice + SAT, 0 Hz to 850 MHz	2.1049, 22.917
b-3	AMPS voice + SAT, 800 MHz to 3rd harmonic	2.1049, 22.917
b-4	AMPS voice + SAT, 869 - 894 MHz	2.1049, 22.917
c-1	AMPS SAT, ± 100 kHz from carrier frequency	2.1049, 22.917
c-2	AMPS SAT, 0 Hz to 850 MHz	2.1049, 22.917
c-3	AMPS SAT, 800 MHz to 3rd harmonic	2.1049, 22.917
c-4	AMPS SAT, 869 - 894 MHz	2.1049, 22.917
d-1	AMPS ST, ± 100 kHz from carrier frequency	2.1049, 22.917
d-2	AMPS ST, 0 Hz to 850 MHz	2.1049, 22.917
d-3	AMPS ST, 800 MHz to 3rd harmonic	2.1049, 22.917
d-4	AMPS ST, 869 - 894 MHz	2.1049, 22.917
e-1	AMPS ST + SAT, ± 100 kHz from carrier frequency	2.1049, 22.917
e-2	AMPS ST + SAT, 0 Hz to 850 MHz	2.1049, 22.917
e-3	AMPS ST + SAT, 800 MHz to 3rd harmonic	2.1049, 22.917
e-4	AMPS ST + SAT, 869 - 894 MHz	2.1049, 22.917
f-1	SAT & DTMF, ± 100 kHz from carrier frequency	2.1049, 22.917
f-2	SAT & DTMF, 0 Hz to 850 MHz	2.1049, 22.917
f-3	SAT & DTMF, 800 MHz to 3rd harmonic	2.1049, 22.917
f-4	SAR & DTMF, 869 - 894 MHz	2.1049, 22.917
g-1	AMPS WIDEBAND, ± 100 kHz from carrier frequency	2.1049, 22.917
g-2	AMPS WIDEBAND, 0 Hz to 850 MHz	2.1049, 22.917
g-3	AMPS WIDEBAND, 800 MHz to 3rd harmonic	2.1049, 22.917
g-4	AMPS WIDEBAND, 869 - 894 MHz	2.1049, 22.917
h-1	Cellular CDMA, 99% occupy bandwidth	2.1049, 22.917
h-2	Cellular CDMA, 0 Hz to 850 MHz	2.1049, 22.917
h-3	Cellular CDMA, 800 MHz to 3rd harmonic	2.1049, 22.917
h-4	Cellular CDMA, 869 - 894 MHz	2.1049, 22.917

16:38:42 30 APR 2001

~~17~~

REF 26.0 dBm AT 40 dB

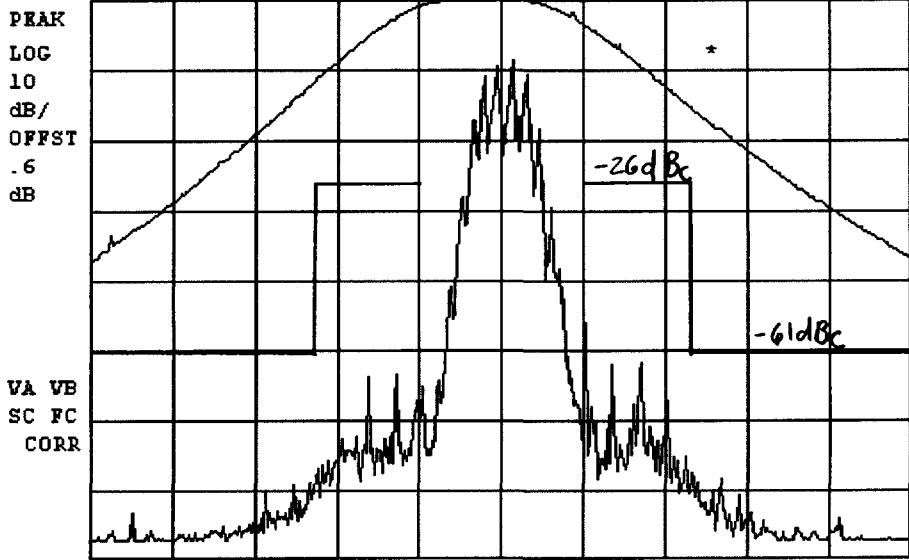

CENTER 836.4900 MHz SPAN 200.0 kHz
#RES BW 300 Hz #VBW 300 Hz SWP 6.67 sec

A1. Amps Voice

16:41:45 30 APR 2001

~~17~~

REF 26.0 dBm AT 40 dB

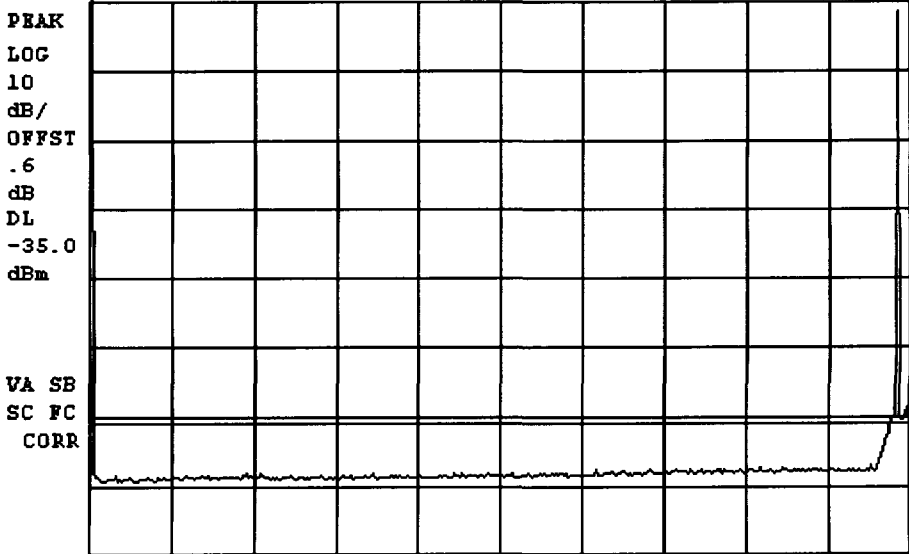

START 0 Hz STOP 850.0 MHz
#RES BW 30 kHz #VBW 30 kHz SWP 2.83 sec

A2. AMPS Voice

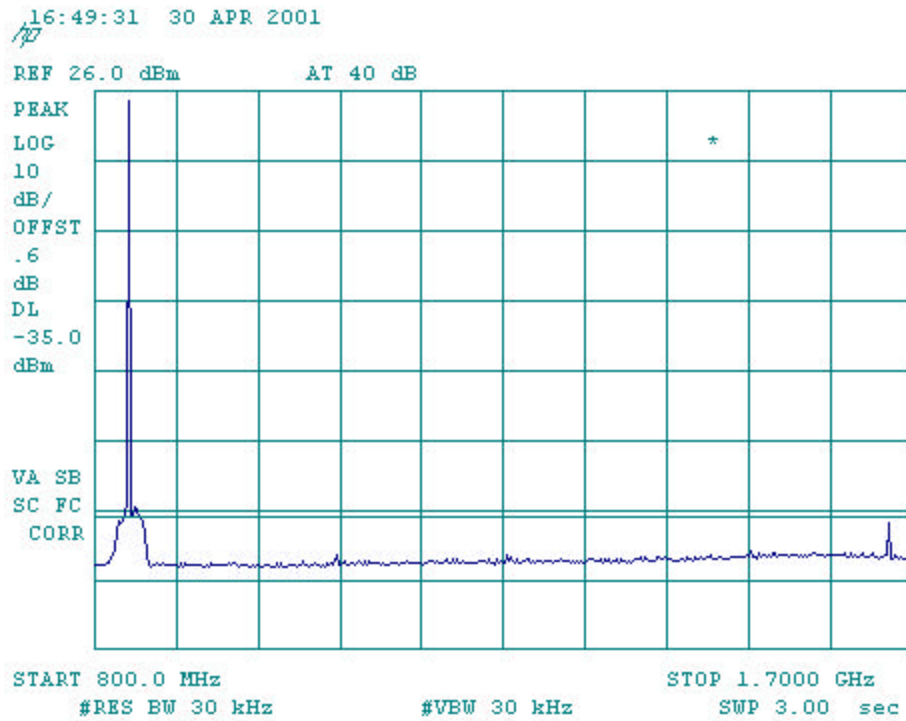

A3. AMPS Voice

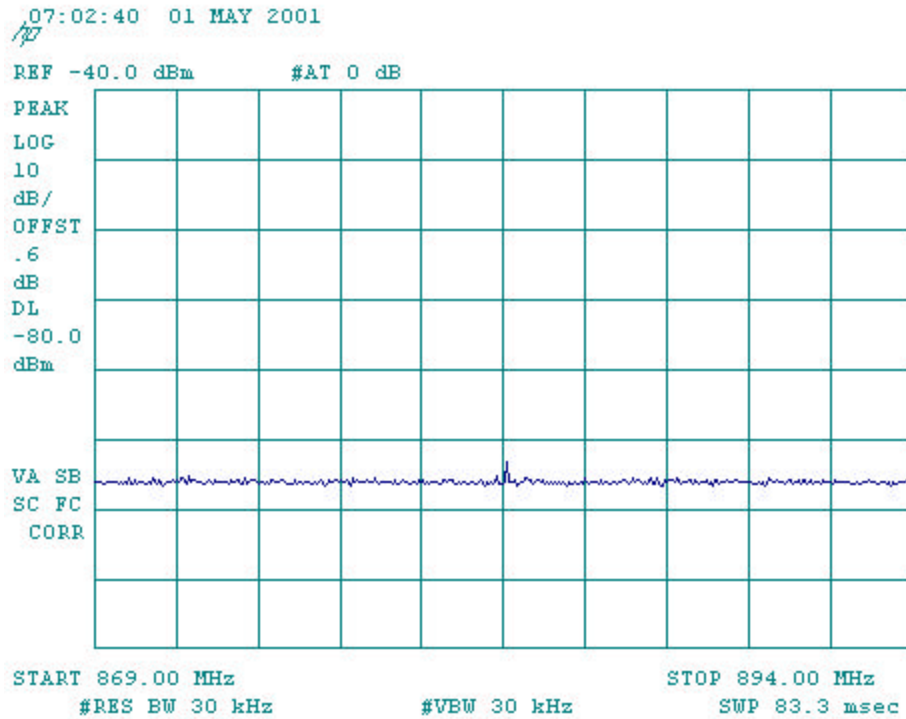

07:17:12 01 MAY 2001

REF 26.0 dBm AT 40 dB

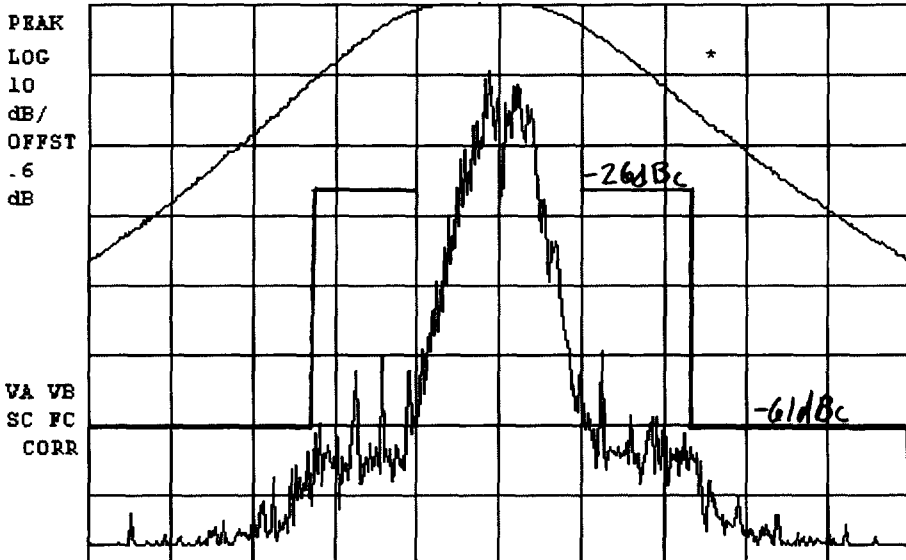

CENTER 836.4900 MHz SPAN 200.0 kHz
 #RES BW 300 Hz #VBW 300 Hz SWP 6.67 sec

B1. AMPS Voice and SAT

07:20:59 01 MAY 2001

REF 26.0 dBm AT 40 dB

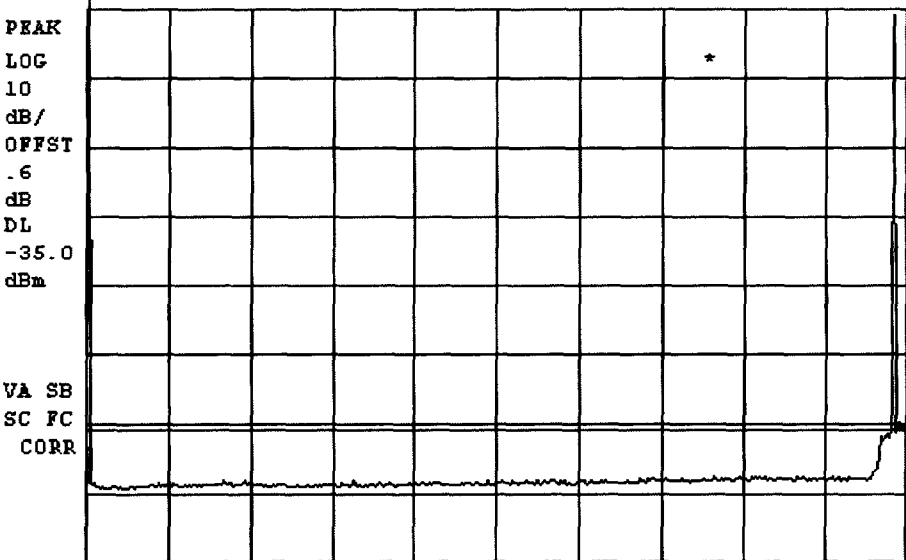

START 0 Hz STOP 850.0 MHz
 #RES BW 30 kHz #VBW 30 kHz SWP 2.83 sec

B2. AMPS Voice and SAT

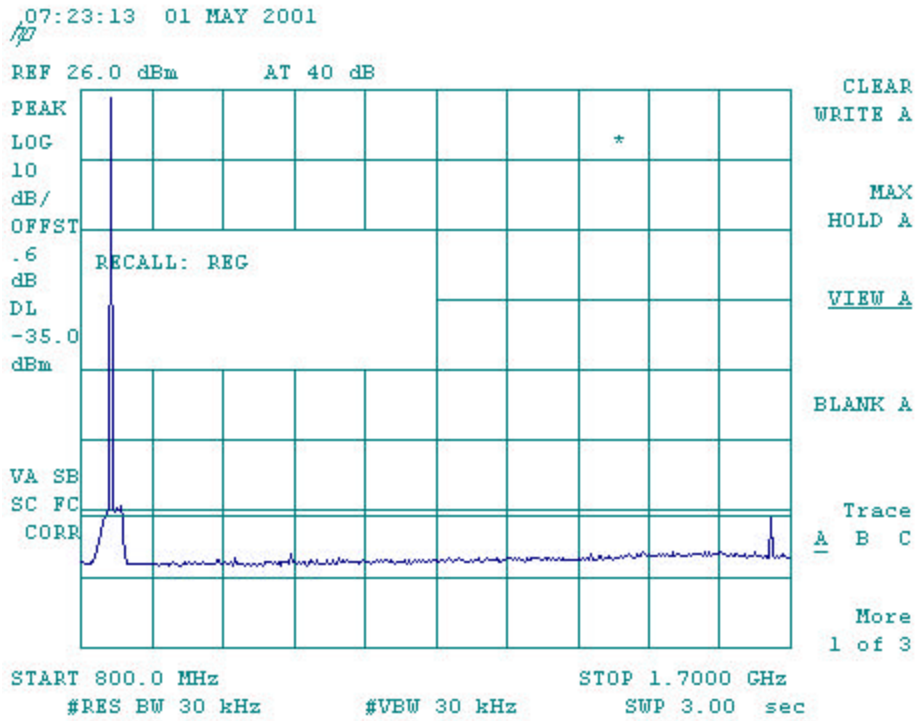

B3. AMPS Voice and SAT

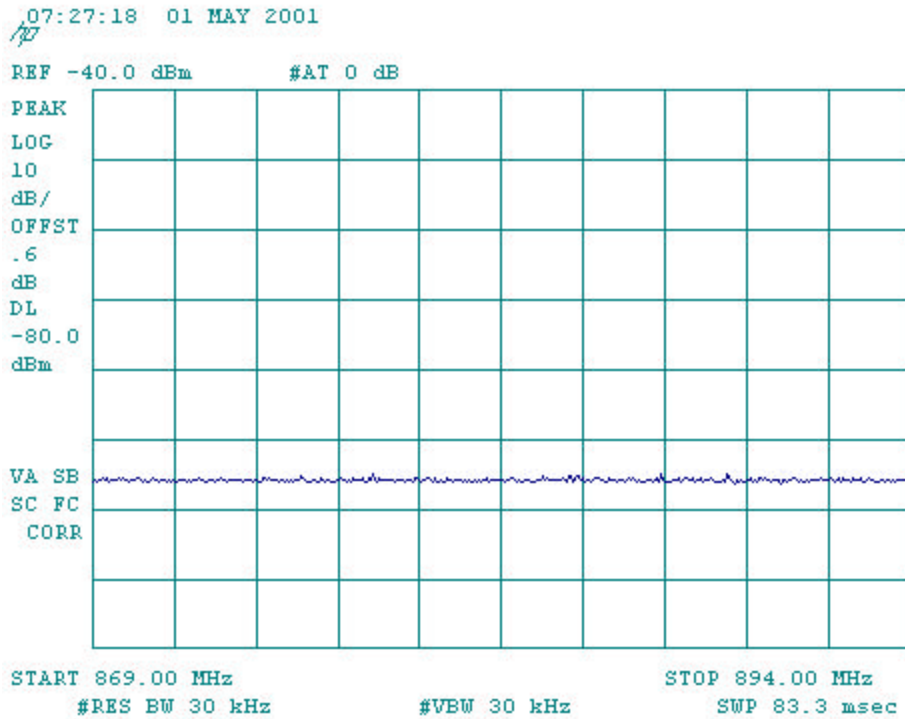

B4. AMPS Voice and SAT

08:39:52 01 MAY 2001

REF 26.0 dBm AT 40 dB

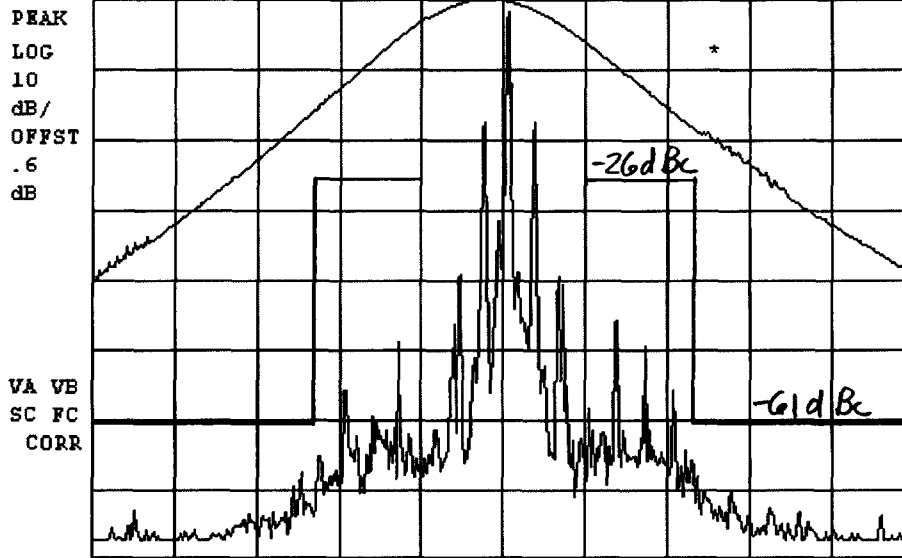

CENTER 836.4900 MHz
#RES BW 300 Hz

#VBW 300 Hz

SPAN 200.0 kHz
SWP 6.67 sec

C1. AMPS SAT

08:43:09 01 MAY 2001

REF 26.0 dBm AT 40 dB

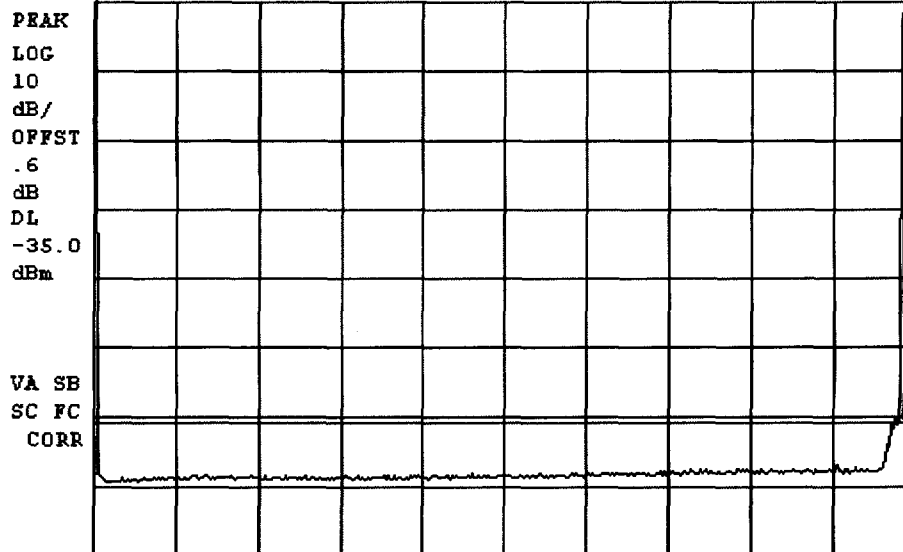

START 0 Hz
#RES BW 30 kHz

#VBW 30 kHz

STOP 850.0 MHz
SWP 2.83 sec

C2. AMPS SAT

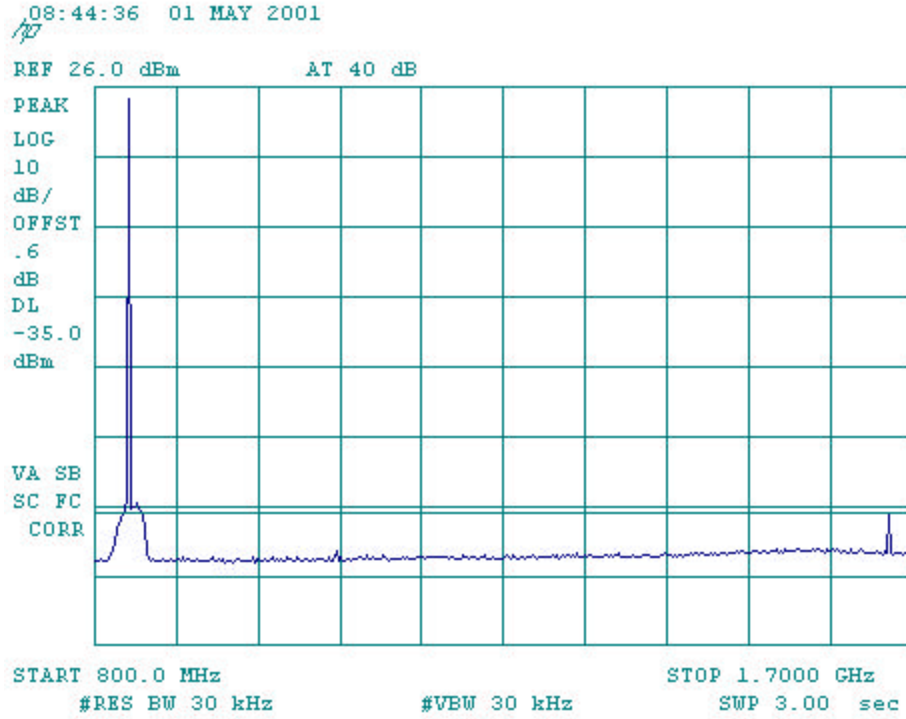

C3. AMPS SAT

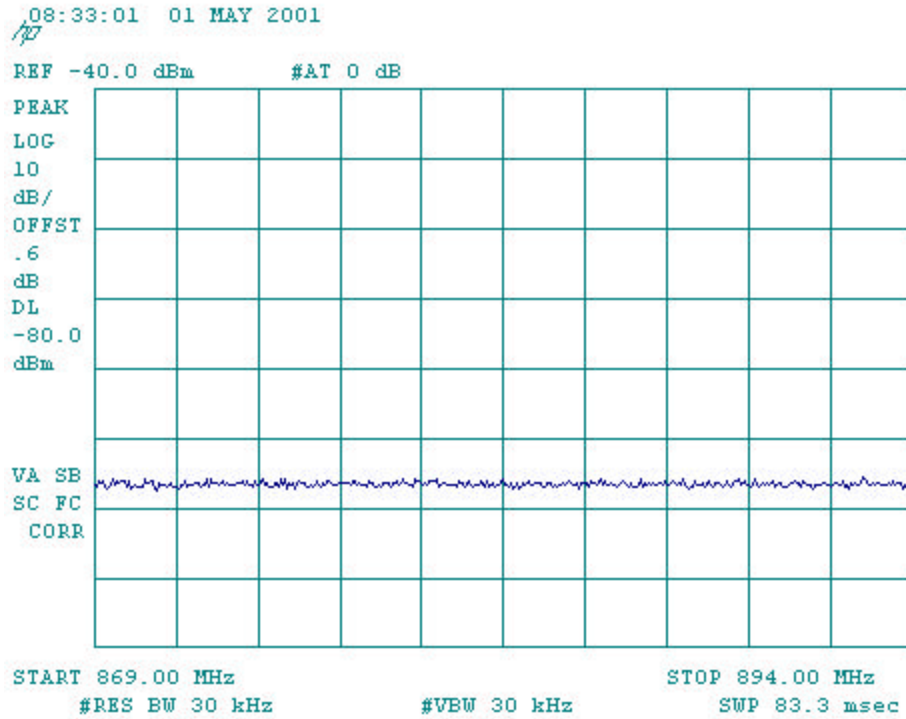

C4. AMPS SAT

08:47:58 01 MAY 2001

REF 26.0 dBm AT 40 dB

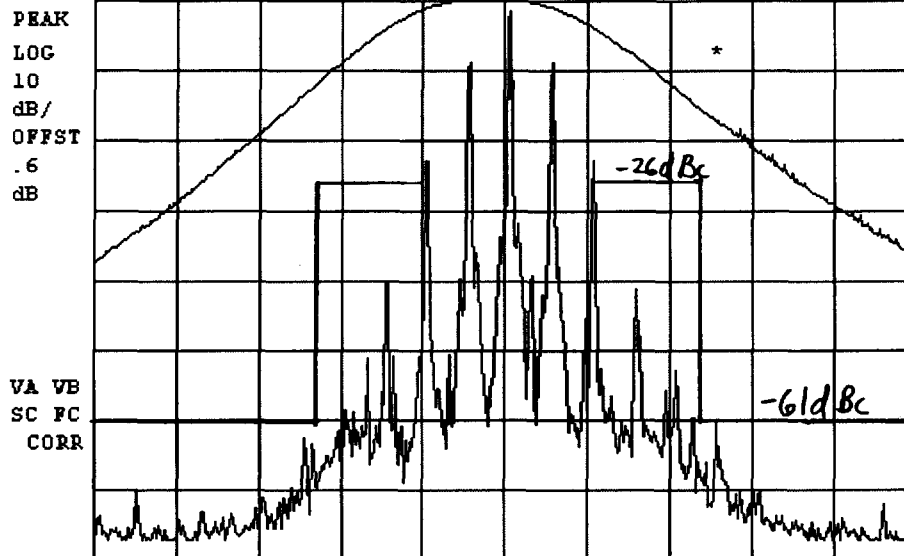

CENTER 836.4900 MHz
#RES BW 300 Hz

#VBW 300 Hz

SPAN 200.0 kHz
SWP 6.67 sec

D1. AMPS ST

08:51:03 01 MAY 2001

REF 26.0 dBm AT 40 dB

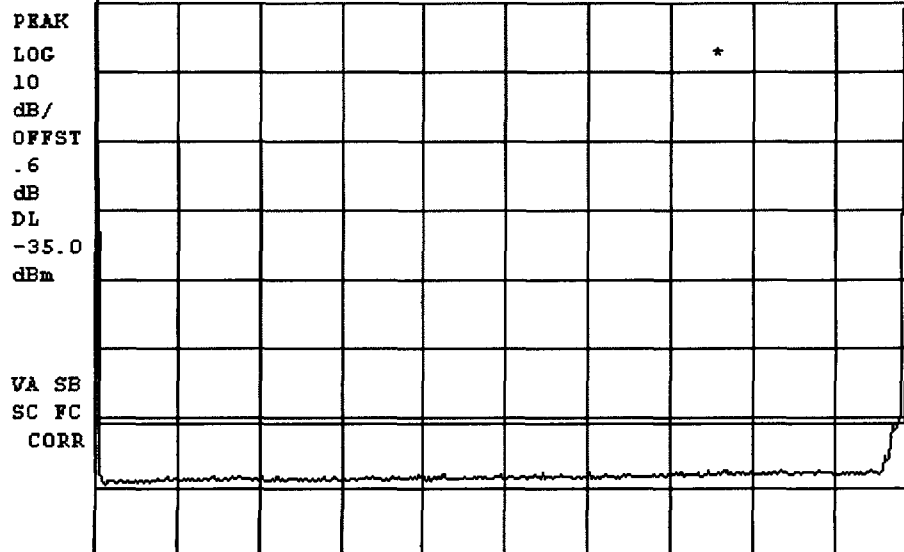

START 0 Hz
#RES BW 30 kHz

#VBW 30 kHz

STOP 850.0 MHz
SWP 2.83 sec

D2. AMPS ST

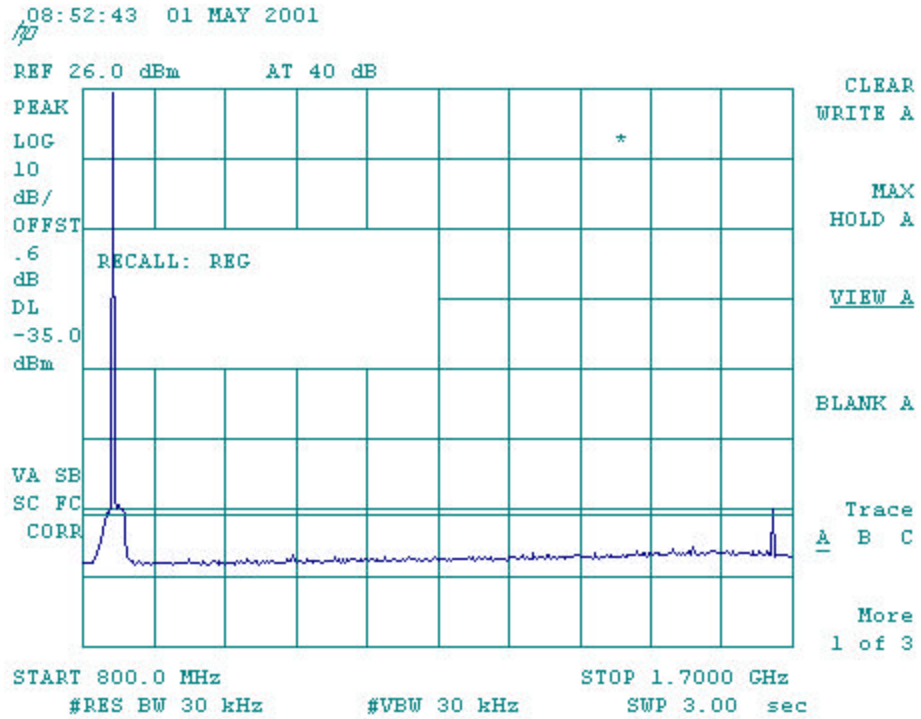

D3 AMPS ST

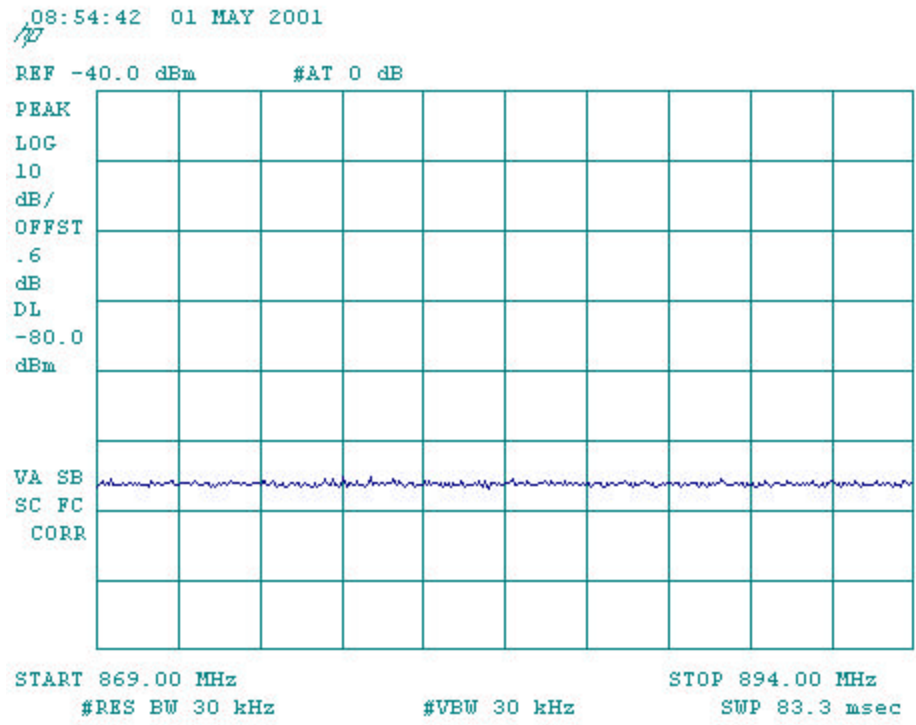

D4. AMPS ST

09:55:17 01 MAY 2001

17

REF 26.0 dBm AT 40 dB

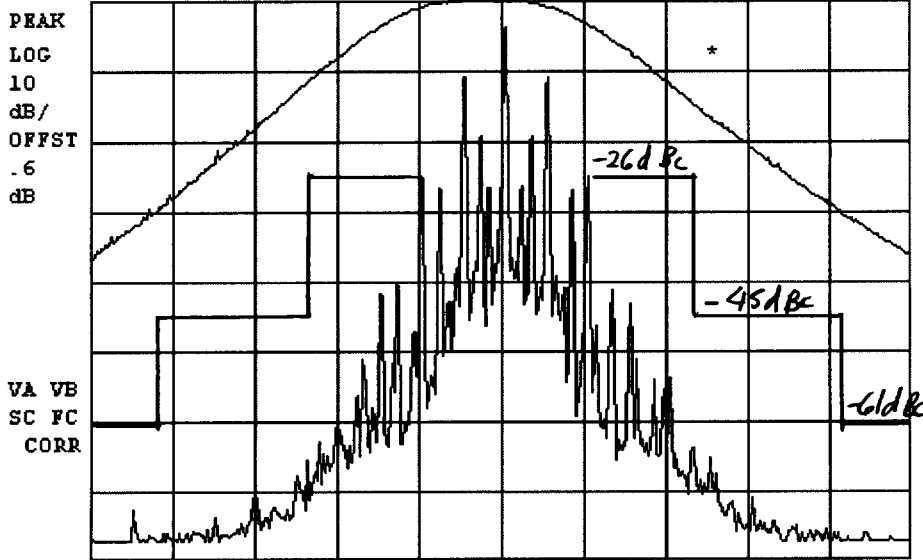

CENTER 836.4900 MHz
#RES BW 300 Hz

#VBW 300 Hz

SPAN 200.0 kHz
SWP 6.67 sec

E1. AMPS ST and SAT

10:00:29 01 MAY 2001

17

REF 26.0 dBm AT 40 dB

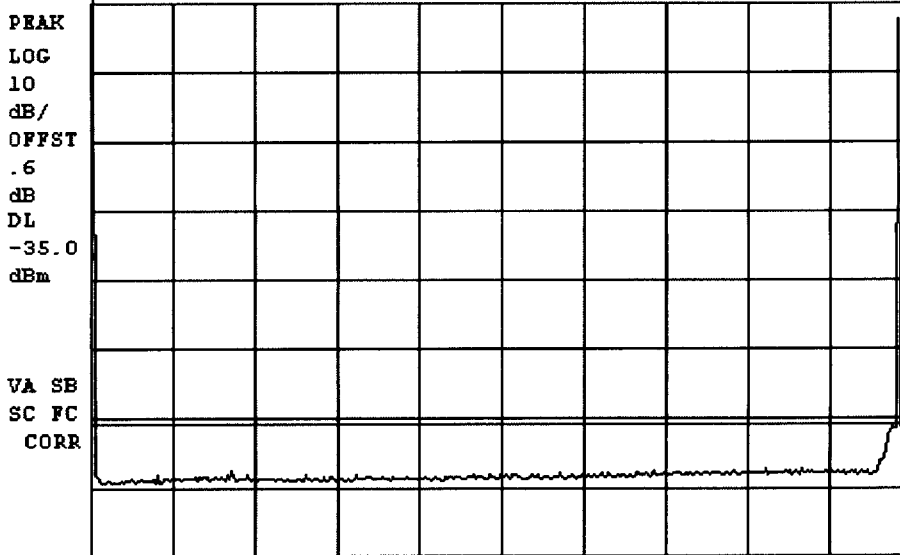

START 0 Hz
#RES BW 30 kHz

#VBW 30 kHz

STOP 850.0 MHz
SWP 2.83 sec

E2. AMPS ST and SAT

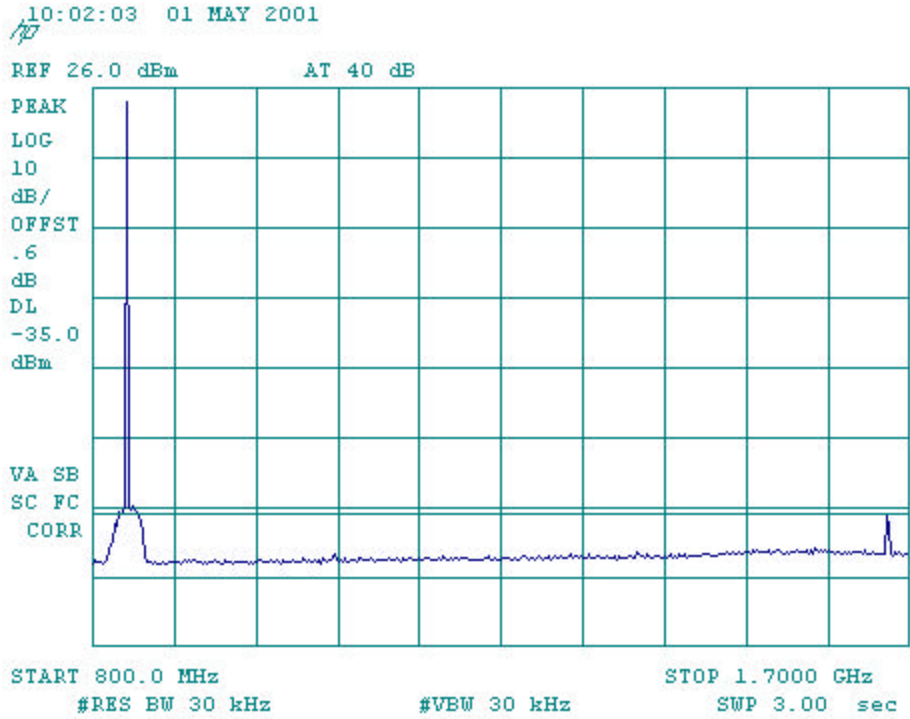

E3. AMPS ST and SAT

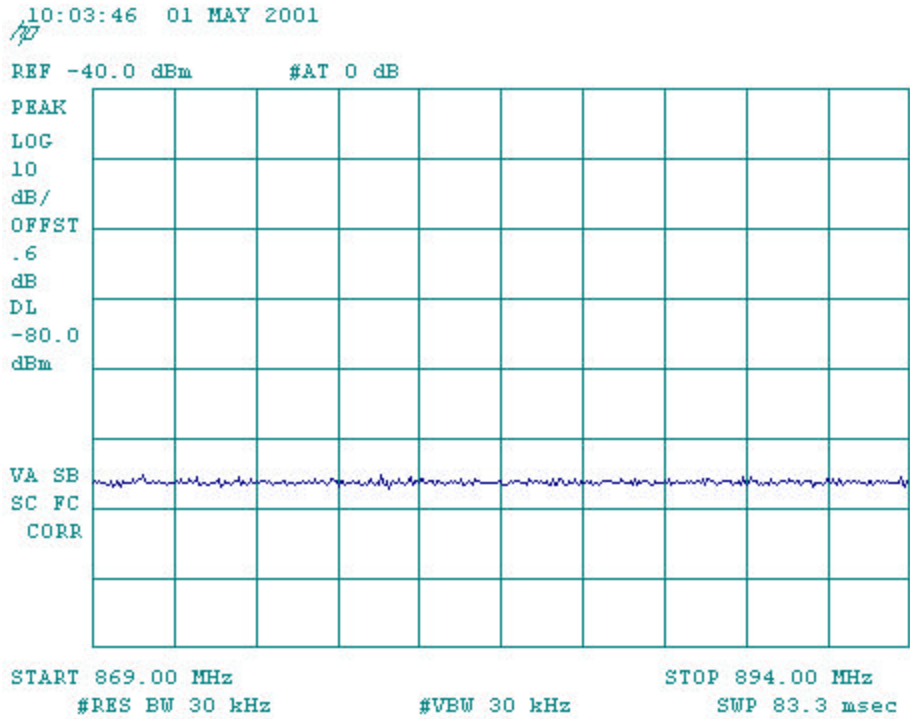

E4. AMPS ST and SAT

11:25:33 01 MAY 2001

AP

REF 26.0 dBm AT 40 dB

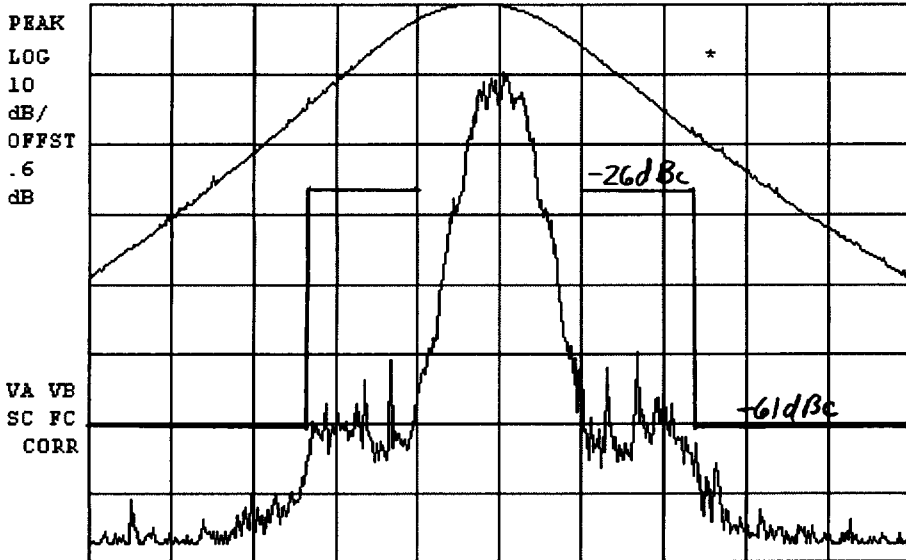

CENTER 836.4900 MHz SPAN 200.0 kHz
#RES BW 300 Hz #VBW 300 Hz SWP 6.67 sec

F1. AMPS SAT and DTMF

11:27:41 01 MAY 2001

AP

REF 26.0 dBm AT 40 dB

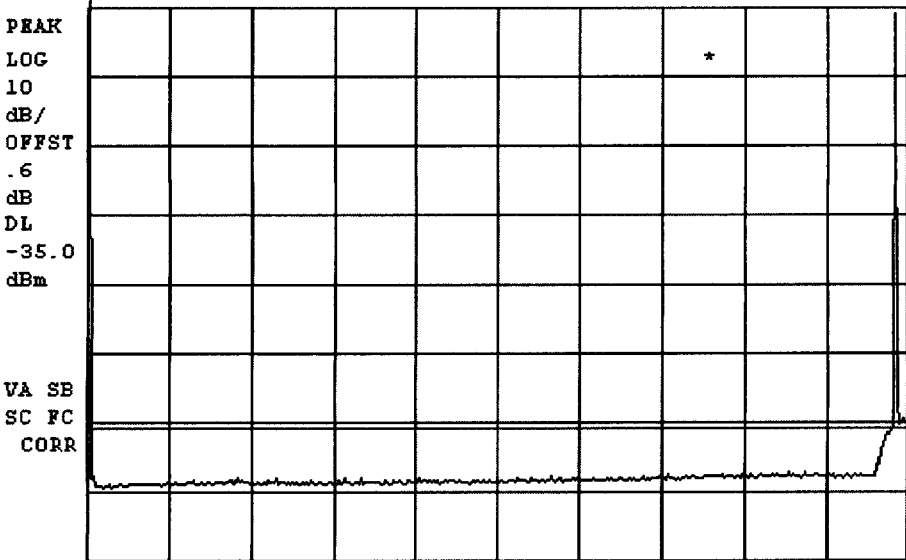

START 0 Hz STOP 850.0 MHz
#RES BW 30 kHz #VBW 30 kHz SWP 2.83 sec

F2. AMPS SAT and DTMF

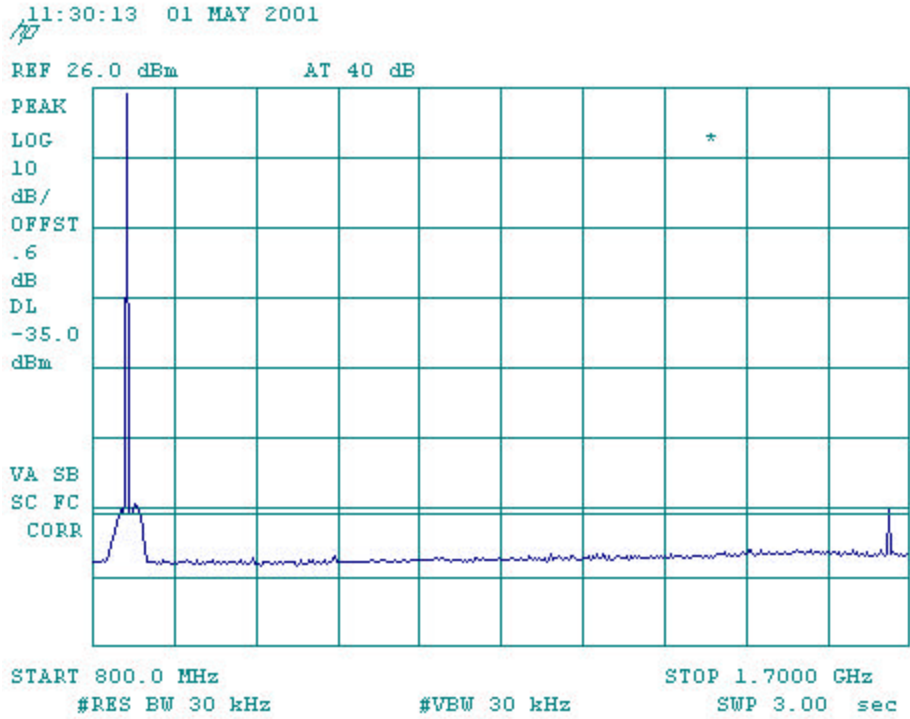

F3. AMPS SAT and DTMF

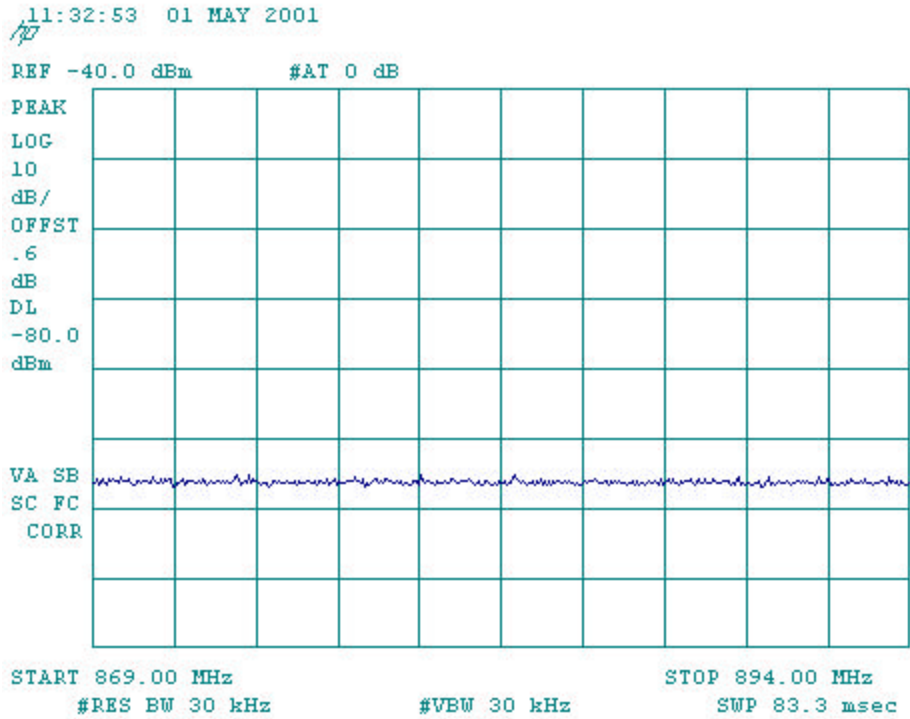

F4. AMPS SAT and DTMF

11:50:27 01 MAY 2001

AP

REF 26.0 dBm AT 40 dB

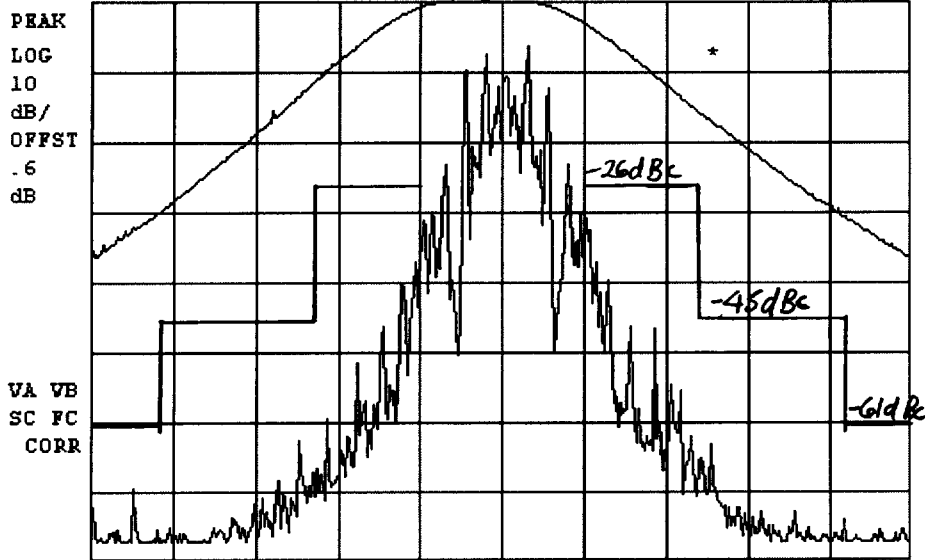

CENTER 836.4900 MHz
#RES BW 300 Hz

#VBW 300 Hz

SPAN 200.0 kHz
SWP 6.67 sec

G1. AMPS WIDEBAND

11:51:57 01 MAY 2001

AP

REF 26.0 dBm AT 40 dB

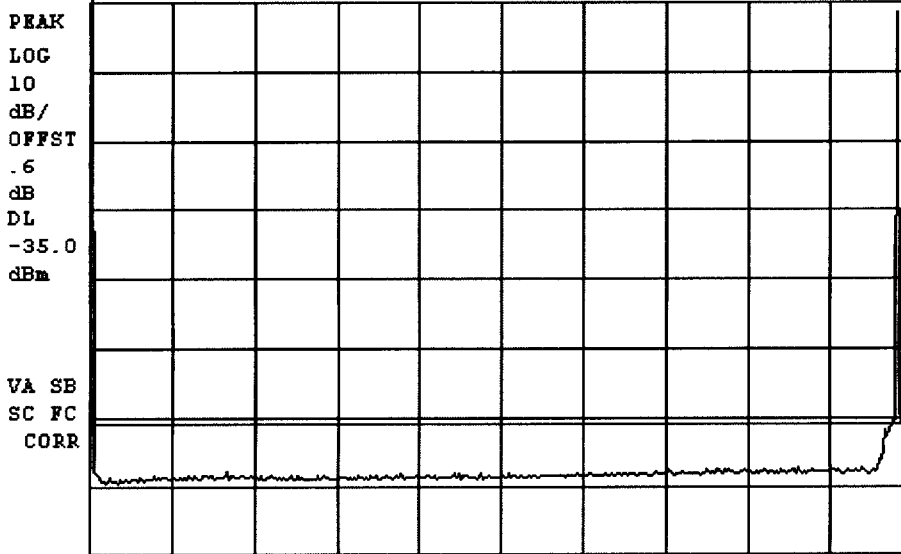

START 0 Hz
#RES BW 30 kHz

#VBW 30 kHz

STOP 850.0 MHz
SWP 2.83 sec

G1. AMPS WIDEBAND

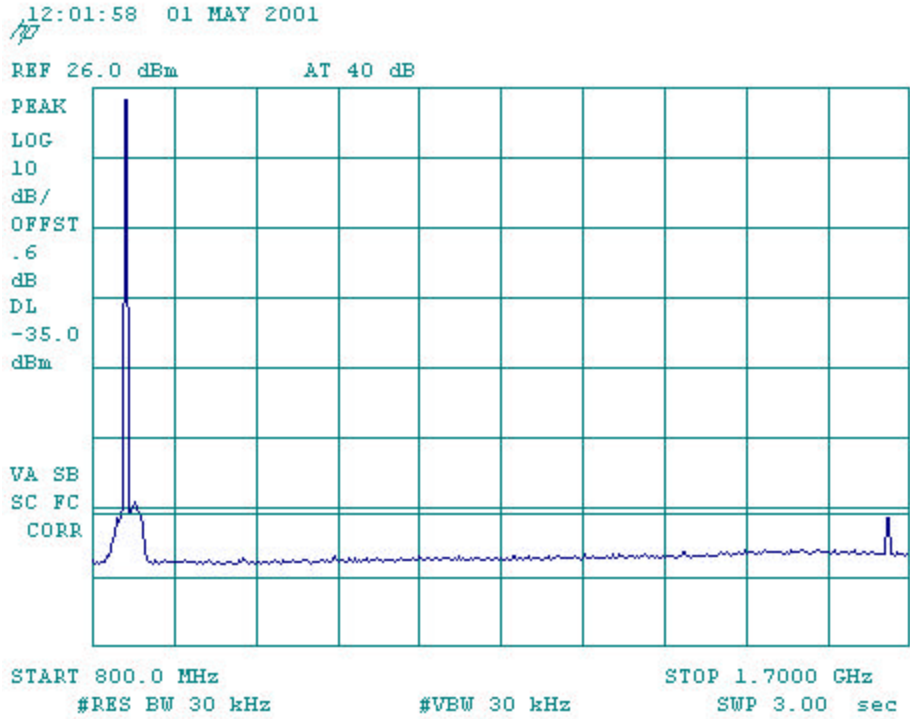

G3. AMPS WIDEBAND

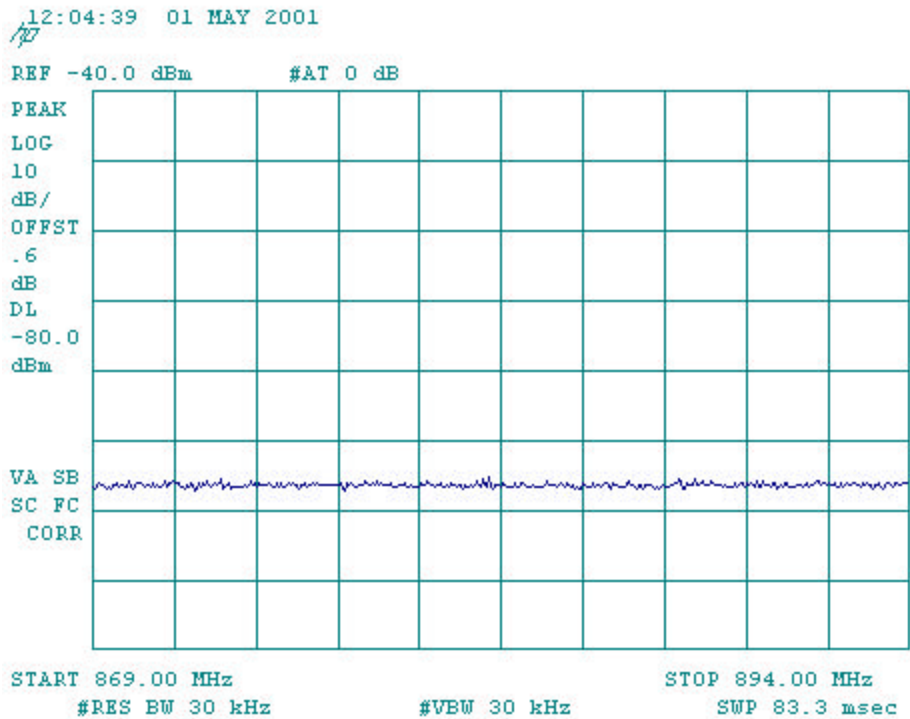

G4. AMPS WIDEBAND

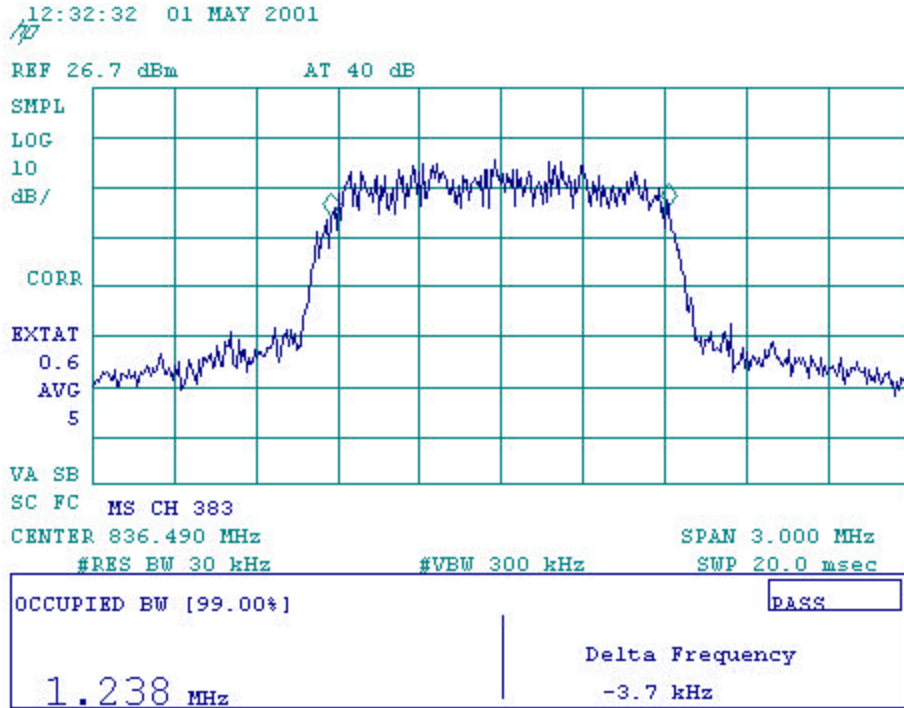

CDMA

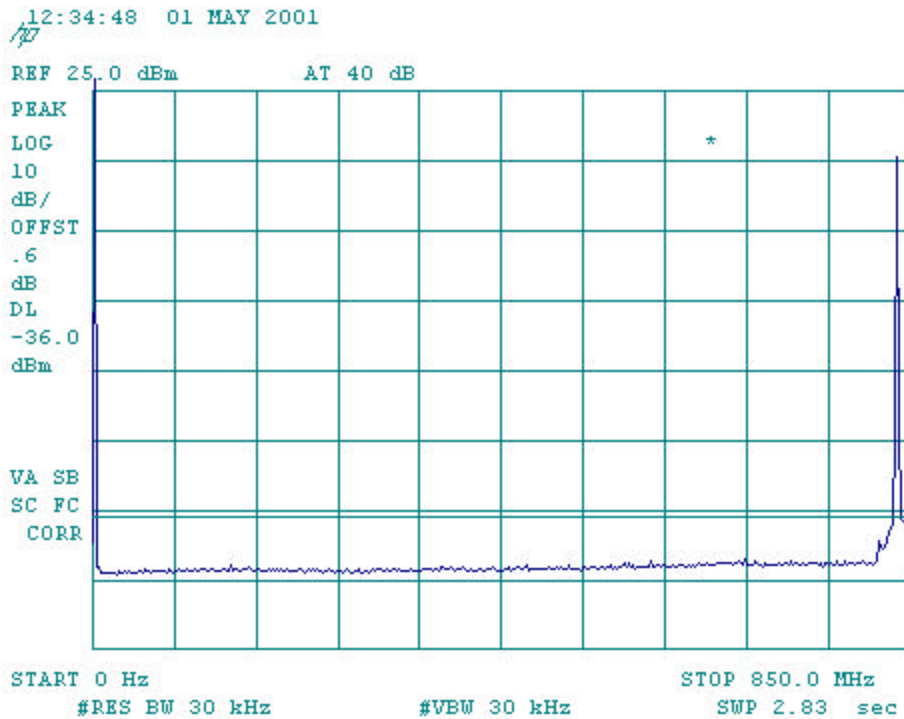

CDMA

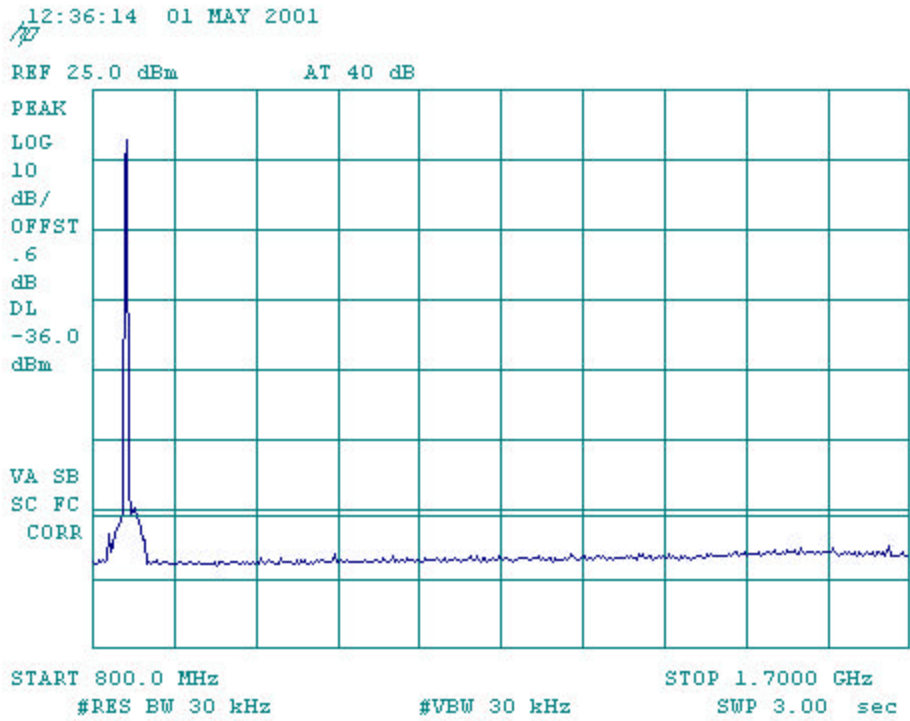

CDMA

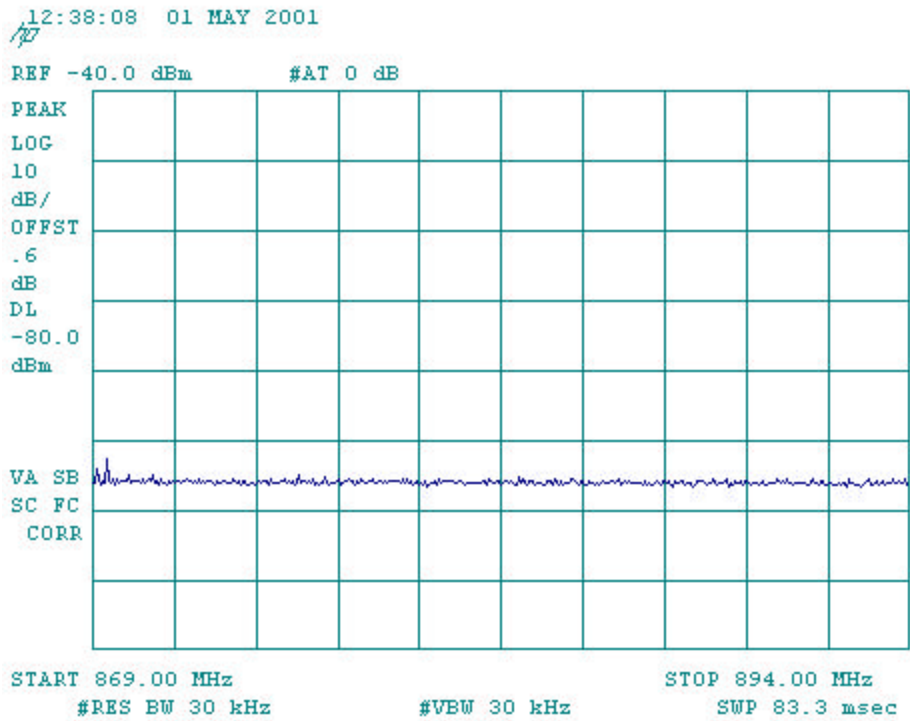

CDMA

Exhibit 9

Occupied Bandwidth and Spurious Emission Measured Data – FCC Part 2.1049, 24.238

1. Occupied Bandwidth

13:13:15 01 MAY 2001

FD

REF 26.0 dBm AT 40 dB

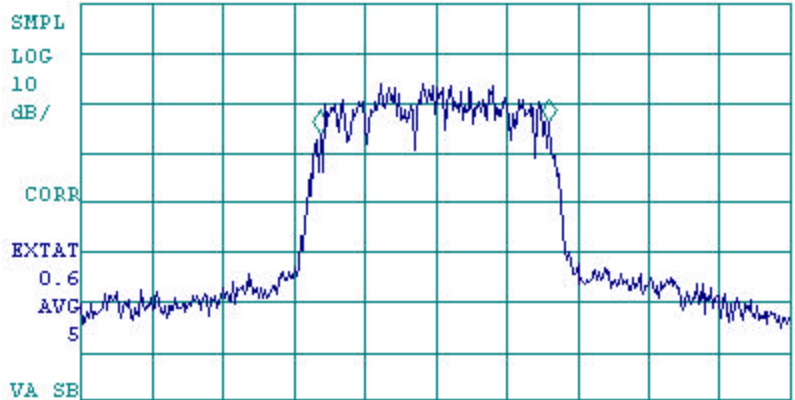

REPEAT
MEAS

MEAS
CONT SCL

NUMBER
AVERAGES

SC FC MS CH 25
 CENTER 1.851250 GHz SPAN 3.750 MHz
 #RES BW 30 kHz #VBW 300 kHz SWP 20.0 msec

OCCUPIED BW [99.00%] PASS

Delta Frequency

1.209 MHz -4.7 kHz

Previous Menu

13:24:51 01 MAY 2001

FD

REF 26.0 dBm AT 40 dB

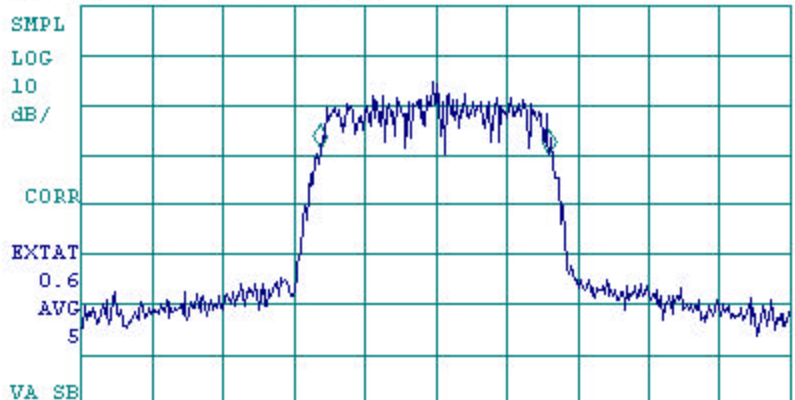

REPEAT
MEAS

MEAS
CONT SCL

NUMBER
AVERAGES

SC FC MS CH 600
 CENTER 1.880000 GHz SPAN 3.750 MHz
 #RES BW 30 kHz #VBW 300 kHz SWP 20.0 msec

OCCUPIED BW [99.00%] PASS

Delta Frequency

1.209 MHz -4.7 kHz

Previous Menu

13:29:52 01 MAY 2001

FD

REF 26.0 dBm AT 40 dB

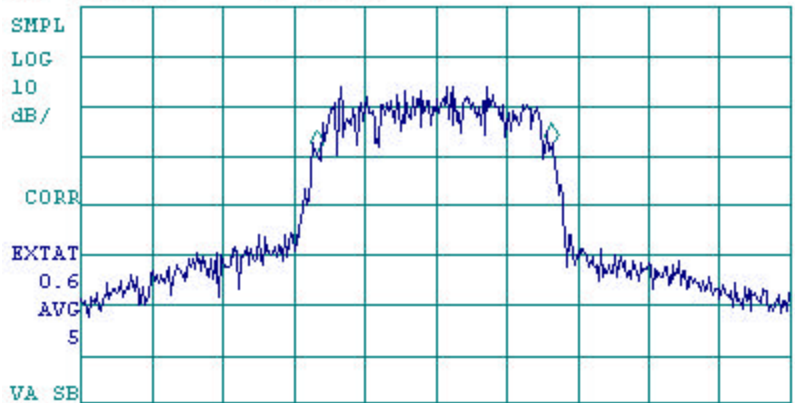

REPEAT
MEAS
MEAS
CONT SCL
NUMBER
AVERAGES

SC FC MS CH 1175
CENTER 1.908750 GHz SPAN 3.750 MHz
#RES BW 30 kHz #VBW 300 kHz SWP 20.0 msec

OCCUPIED BW [99.00%]	PASS
1.238 MHz	Delta Frequency -9.4 kHz

Previous
Menu

2. Spurious Emission at Antenna Terminals

Out of Band Spurious Emission Measurement Procedures

(a) 1 MHz band immediately adjacent to the PCS band

We performed a numerical integration of the power as performed by the spectrum analyzer (HP8594E) in the 1 MHz band immediately outside of the PCS block. As specified in Part 24.238 of the rules, we used a Resolution Bandwidth of 1% of the fundamental emission bandwidth, which in this instance equates to the measurement bandwidth of 12.5 kHz.

The ACPR (Adjacent Channel Power Ratio) function of the HP CDMA measurement personality was used on spectrum analyzer, which provides the power integration. The ACPR function and the spectrum analyzer settings used to complete the measurement will be addressed in section (c).

(b) 2nd 1 MHz band adjacent to PCS Block

As specified in Part 24.238 of the rules, the 2nd 1 MHz band outside of the PCS block was measured using a resolution bandwidth of 1 MHz.

The ACPR function of the HP CDMA measurement personality was used to complete the measurement. See section (c) for the ACPR function and the spectrum analyzer settings.

(c) ACPR measurement and spectrum analyzer settings

The ACPR (Adjacent Channel Power Ratio) is the power contained in a specified frequency-channel bandwidth relative to the total carrier power. It can measure up to three pairs of offset channels and relates them to the carrier power. ACPR measurement uses an integration bandwidth method (IBW) to measure the carrier power and the offset powers. IBW method performs a frequency sweep through the bandwidth of integration (set up by the user) using a resolution bandwidth (automatically set) much narrower than the channel bandwidth (e.g. 30 kHz RBW for a channel bandwidth of 1.25 MHz). The measurement computes an average power of the channel over a specified number of sweeps, automatically compensating for noise and scaling.

The following settings were used in the ACPR integration bandwidth method to complete the above measurements (a) and (b). An example to explain the settings is given.

Settings used in ACPR measurement

	Frequency (Hz)	Offset Limit	IBW (Hz)	Offset Span (Hz)	Comments
Offset A	± 885k	n/a	n/a	n/a	not required on a mobile station
Offset B	±1.25625M	-35dB (43+10logP)	12.5k	25k	setup for 1 MHz band immediately adjacent to PCS band
Offset C	± 2.75M	-35dB (43+10logP)	1M	2M	setup for 2 nd 1 MHz band adjacent to PCS band

As an example of channel 25, the center frequency is 1851.25 MHz. The interpretation of the settings in the above table is shown in following drawing.

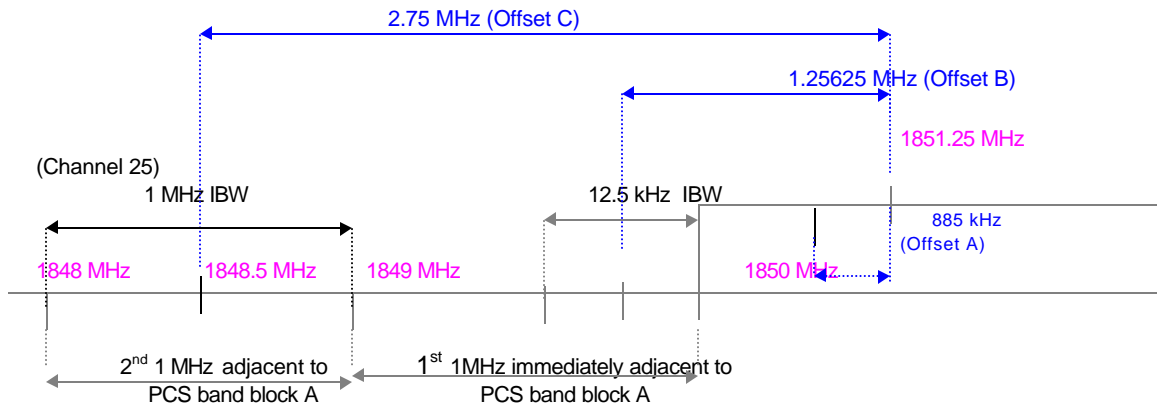

Note: The above drawing is not in scale.

(d) Spurious emission up to 10th harmonic of the transmitting frequency

The harmonic and spurious emissions from 0 Hz to 22 GHz were measured using a RBW of 1 MHz and a VBW of 1 MHz on the spectral analyzer.

Test Results

ACPR measurement (1st and 2nd 1MHz adjacent to PCS)

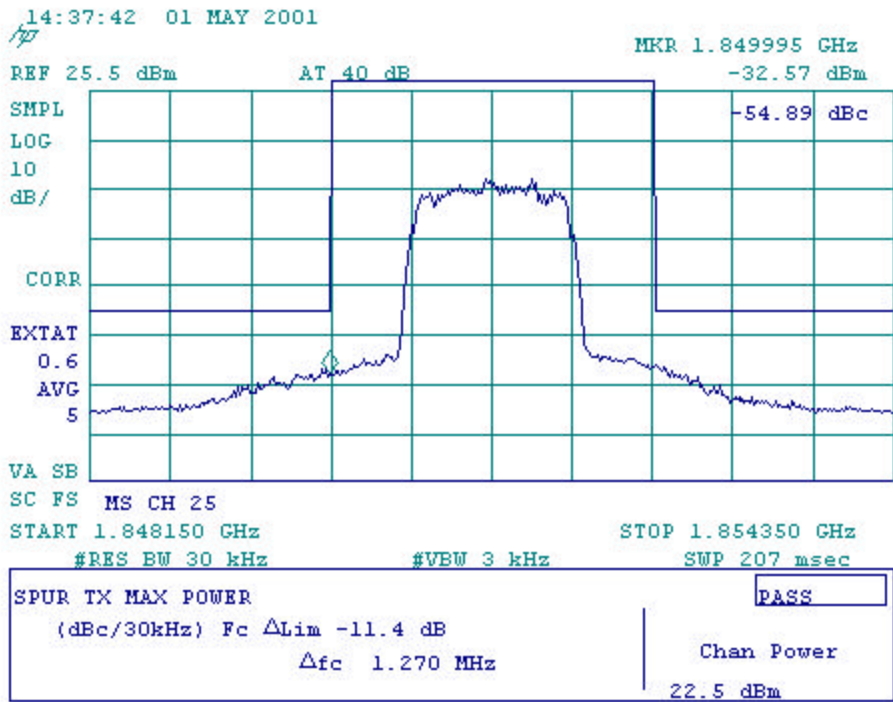
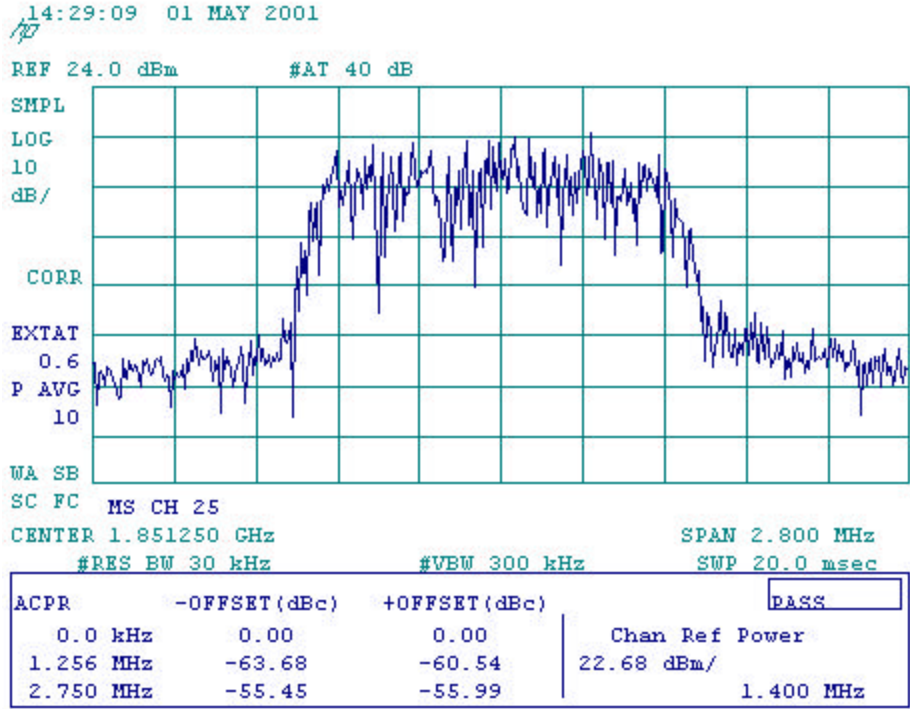

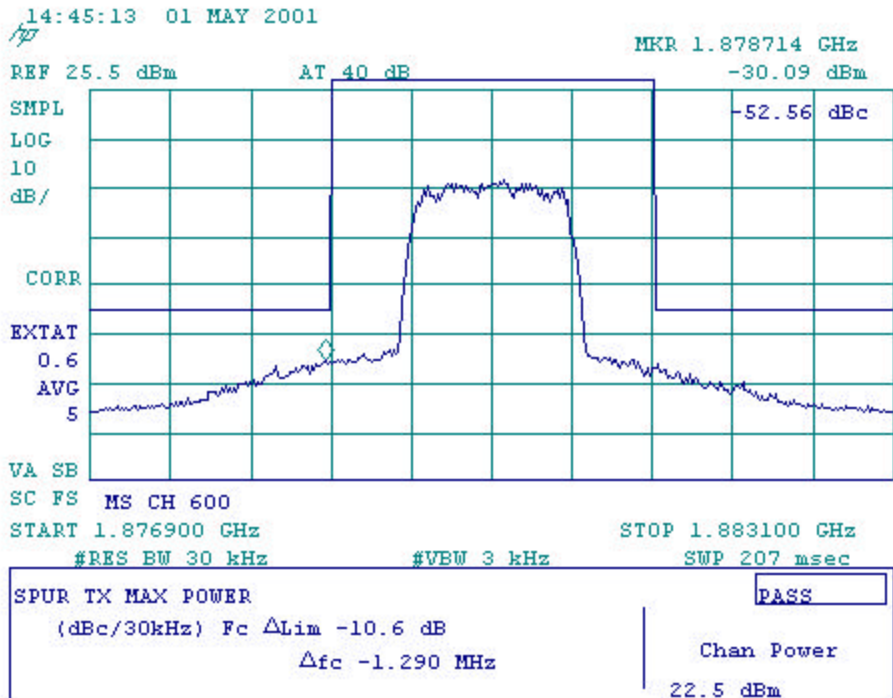
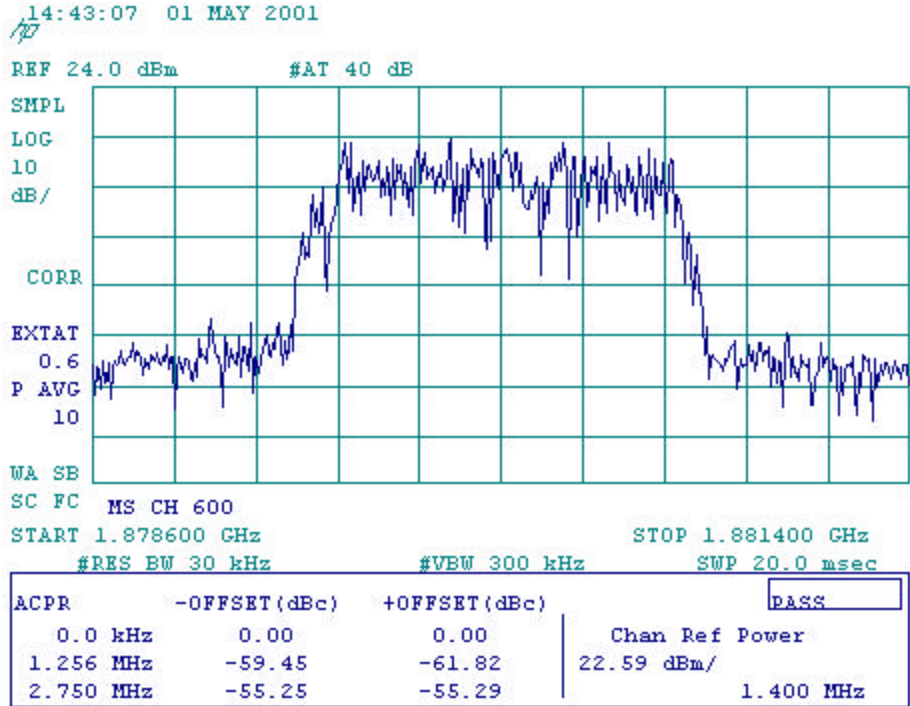

15:00:54 01 MAY 2001

hp

REF 24.0 dBm #AT 40 dB

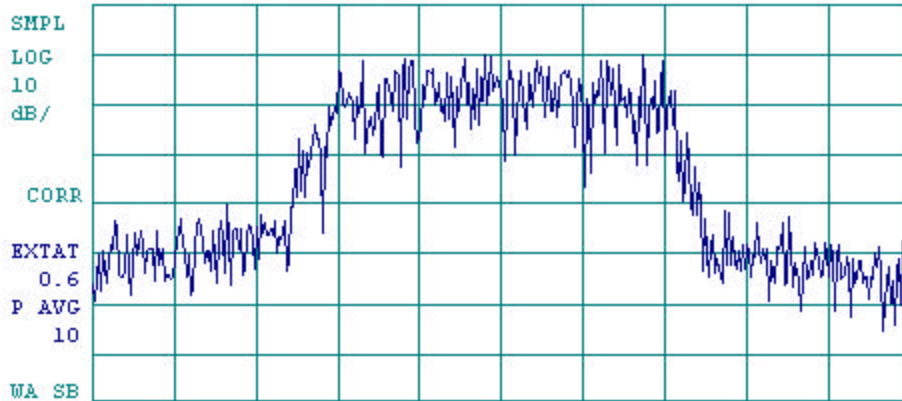

ACPR	-OFFSET (dBc)	+OFFSET (dBc)	PASS
0.0 kHz	0.00	0.00	Chan Ref Power 22.60 dBm/ 1.400 MHz
1.256 MHz	-52.42	-55.26	
2.750 MHz	-53.55	-55.02	

14:57:38 01 MAY 2001

hp

MKR 1.910021 GHz

REF 25.4 dBm AT 40 dB -28.37 dBm

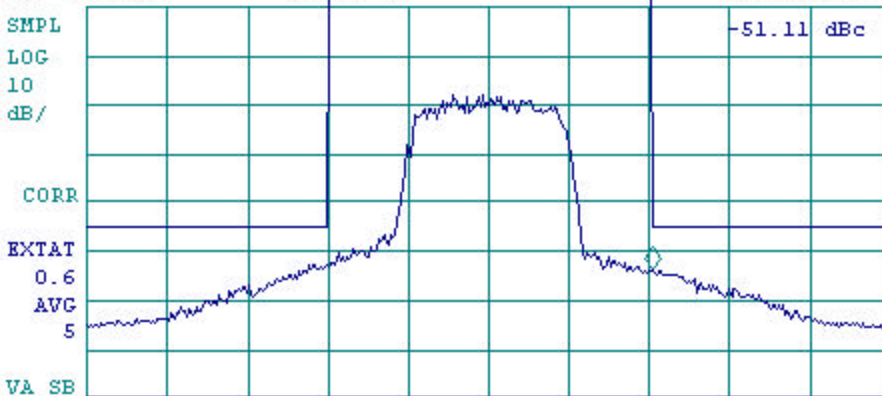

SPUR TX MAX POWER	PASS
(dBc/30kHz) Fc Δ Lim -7.8 dB	Chan Power 22.4 dBm
Δ fc -1.350 MHz	

Spurious Emission Up to 10th harmonics

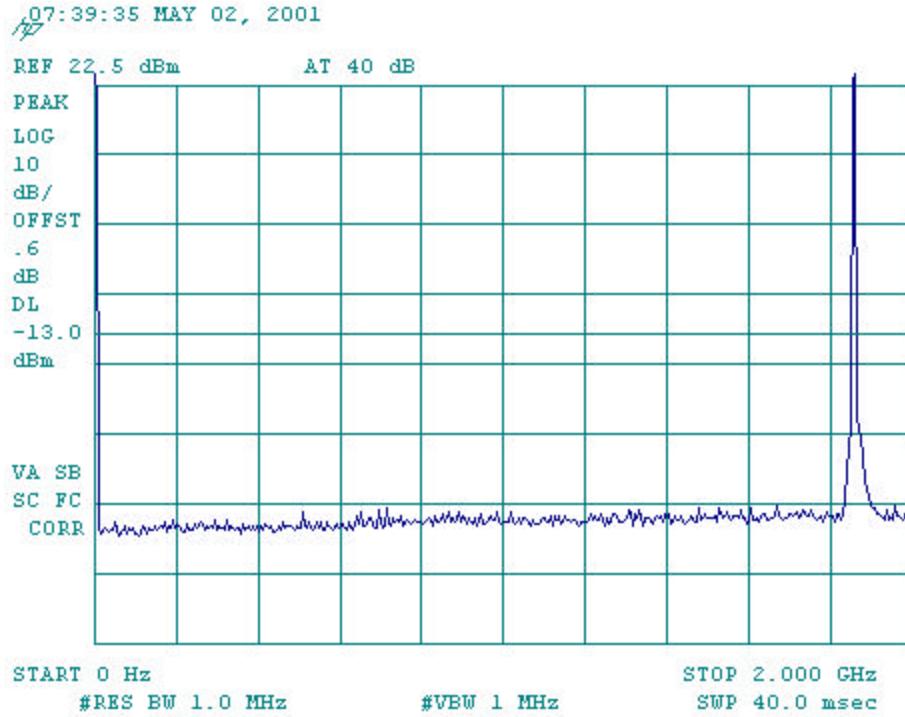

Channel 25

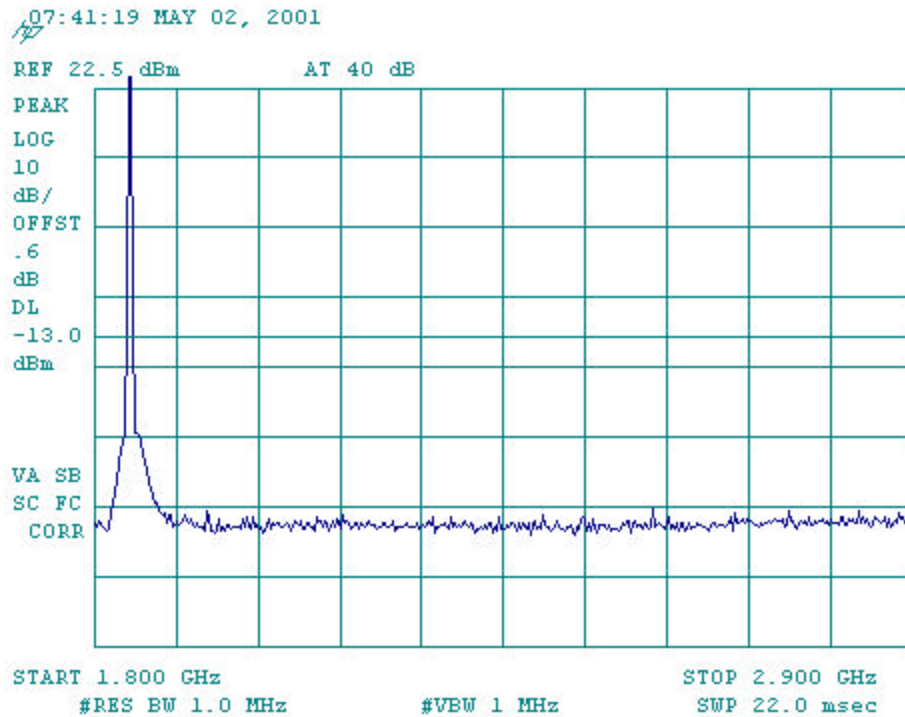

Channel 25

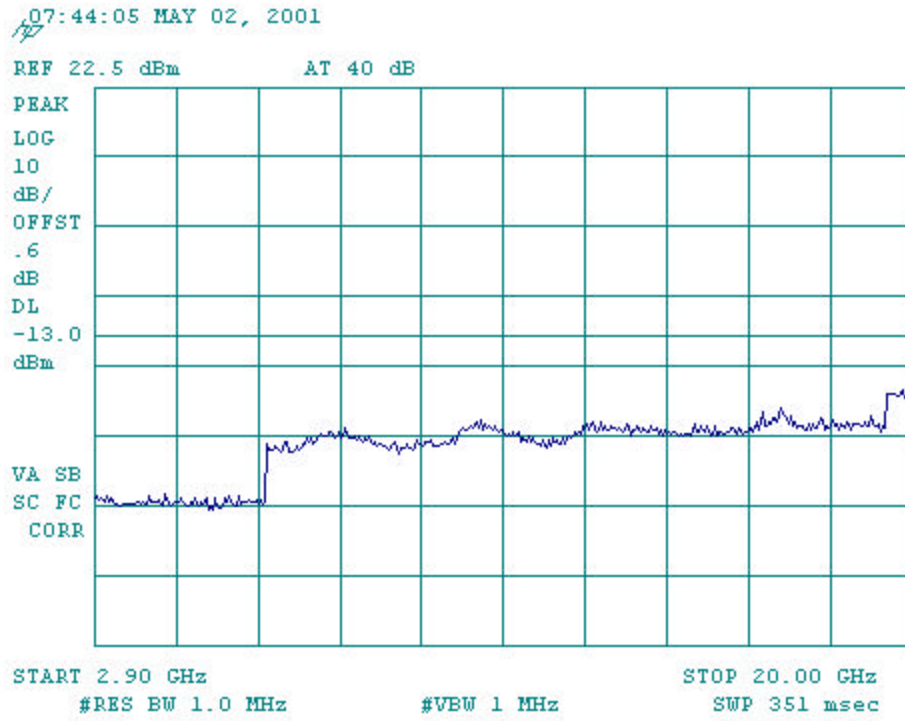

Channel 25

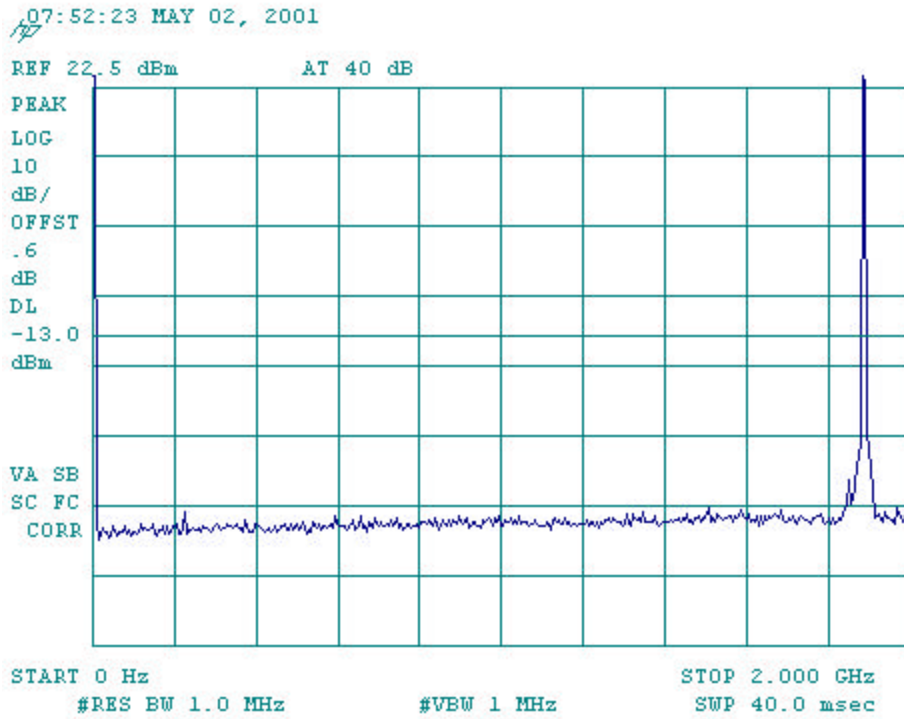

Channel 600

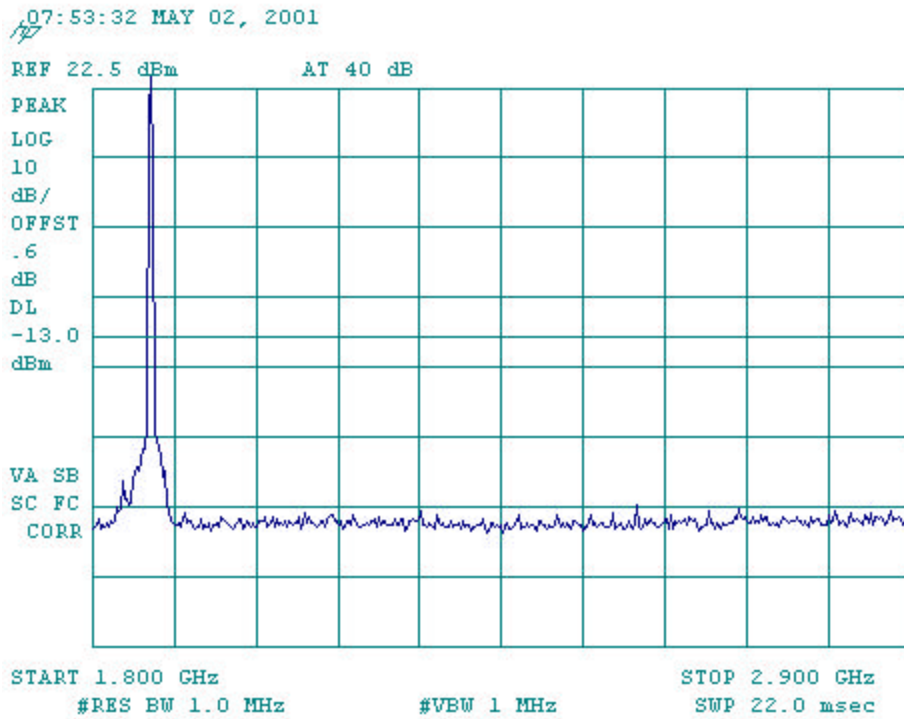

Channel 600

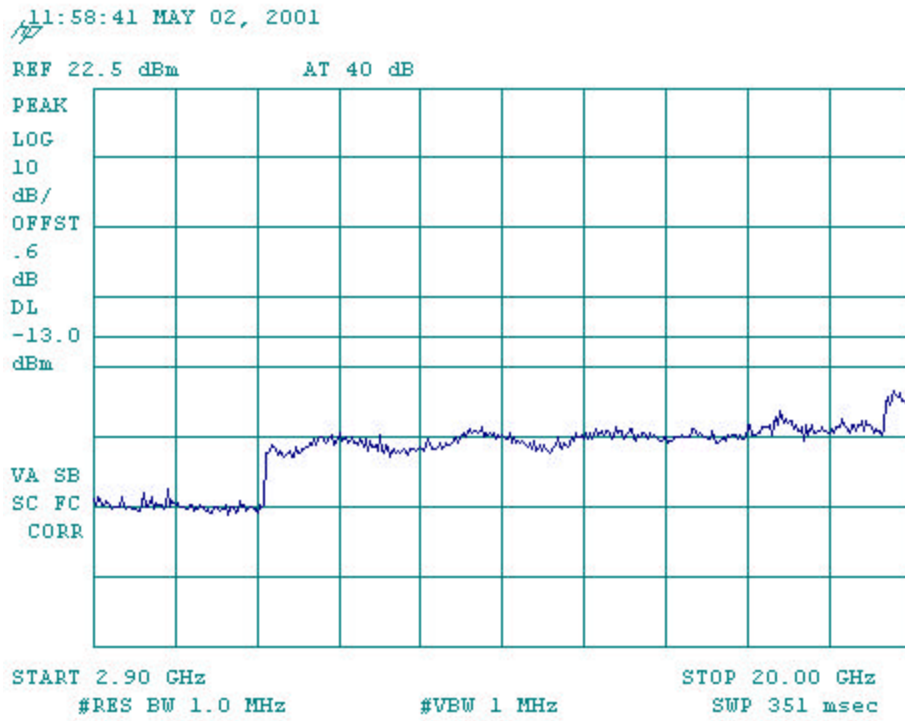

Channel 600

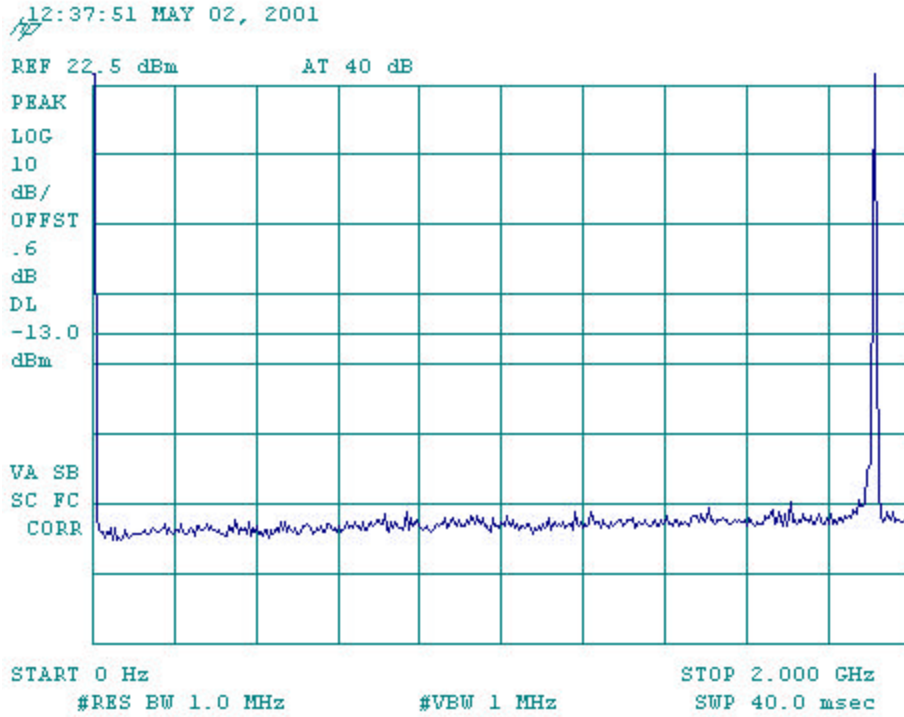

Channel 1175

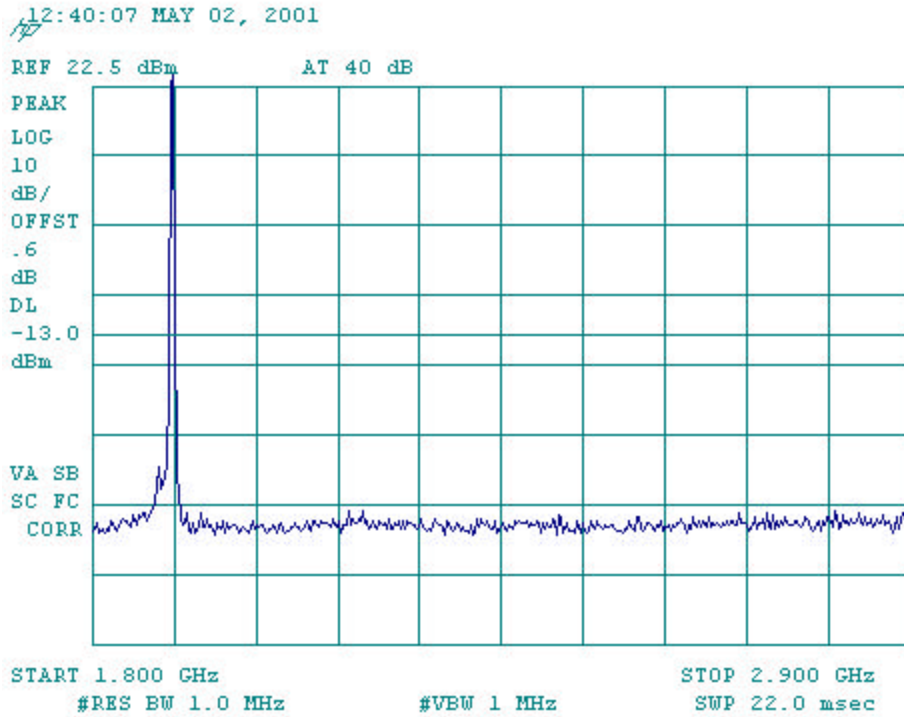

Channel 1175

12:41:57 MAY 02, 2001

REF 22.5 dBm AT 40 dB

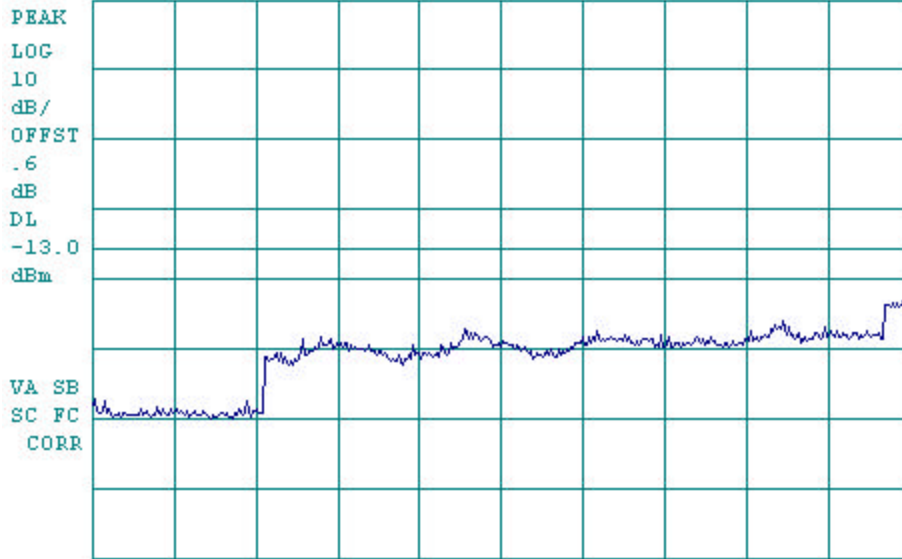

Channel 1175

Exhibit 10**Conducted Emissions Test Results (harmonics) - FCC Part 2 and 22, Paragraph 2.1051,**22.917

4/25/2001

FM High Power

low band – channel 991

	Frequency (MHz)	Measured Level (dBm)	specification limit (dBm)
1	824.04		-
	1052.64	-52.21	-13
2	1648.08	-75.14	-13
3	2472.12	-70.95	-13
4	3296.16	-79.68	-13
5	4120.2	-75.80	-13
6	4944.24	-75.47	-13
7	5768.28	-92.88	-13
8	6592.32	-78.33	-13
9	7416.36	-81.02	-13
10	8240.4	-94.90	-13

mid band – channel 383

	Frequency (MHz)	Measured Level (dBm)	specification limit (dBm)
1	836.49		-
	1065.09	-54.20	-13
2	1672.98	-78.99	-13
3	2509.47	-76.04	-13
4	3345.96	-83.37	-13
5	4182.45	-80.03	-13
6	5018.94	-92.16	-13
7	5855.43	-89.56	-13
8	6691.92	-79.10	-13
9	7528.41	-81.67	-13
10	8364.9	-96.16	-13

high band – channel 799

	Frequency (MHz)	Measured Level (dBm)	specification limit (dBm)
1	848.97		-
	1077.56	-58.53	-13
2	1697.94	-78.92	-13
3	2546.91	-73.83	-13
4	3395.88	-76.70	-13
5	4244.85	-74.82	-13
6	5093.82	-91.02	-13

7	5942.79	-86.98	-13
8	6791.76	-72.54	-13
9	7640.73	-86.17	-13
10	8489.7	-95.19	-13

CDMA High Power

low band – channel 1013

	Frequency (MHz)	Measured Level (dBm)	specification limit (dBm)
1	824.7		-
	1053.3	-55.32	-13
2	1649.4	-85.67	-13
3	2474.1	-83.76	-13
4	3298.8	-96.97	-13
5	4123.5	-98.43	-13
6	4948.2	-102.66	-13
7	5772.9	-100.45	-13
8	6597.6	-87.76	-13
9	7422.3	-93.72	-13
10	8247.0	-93.36	-13

mid band – channel 383

	Frequency (MHz)	Measured Level (dBm)	Specification limit (dBm)
1	836.49		-
	1065.09	-54.19	-13
2	1672.98	-86.65	-13
3	2509.47	-95.81	-13
4	3345.96	-93.20	-13
5	4182.45	-98.97	-13
6	5018.94	-102.38	-13
7	5855.43	-102.67	-13
8	6691.92	-91.36	-13
9	7528.41	-93.09	-13
10	8364.90	-93.35	-13

high band – channel 777

	Frequency (MHz)	Measured Level (dBm)	specification limit (dBm)
1	848.31		-
	1076.91	-58.71	-13
2	1696.62	-83.30	-13
3	2544.93	-87.02	-13
4	3393.24	-79.09	-13
5	4241.55	-92.64	-13
6	5089.86	-100.30	-13
7	5938.17	-101.75	-13
8	6786.48	-84.38	-13
9	7634.79	-92.41	-13
10	8483.10	-92.91	-13

Exhibit 11Conducted Emission Test Results (Harmonics) - FCC Part 2 and 24, Paragraph 2.1051,24.238

4/25/2001

PCS CDMA High Power

low band – channel 25

	Frequency (MHz)	Measured Level (dBm)	specification limit (dBm)
1	1851.25		-
	2114.85	-88.35	-13
2	3702.5	-80.49	-13
3	5553.75	-82.64	-13
4	7405	-78.23	-13
5	9256.25	-88.71	-13
6	11107.5	-98.18	-13
7	12958.75	-97.07	-13
8	14810	-92.60	-13
9	16661.25	-96.12	-13
10	18512.5	-94.19	-13

mid band – channel 600

	Frequency (MHz)	Measured Level (dBm)	specification limit (dBm)
1	1880		-
	2143.60	-83.38	-13
2	3760	-87.06	-13
3	5640	-93.23	-13
4	7520	-75.91	-13
5	9400	-92.21	-13
6	11280	-87.99	-13
7	13160	-93.70	-13
8	15040	-96.42	-13
9	16920	-93.49	-13
10	18800	-94.43	-13

high band – channel 1175

	Frequency (MHz)	Measured Level (dBm)	specification limit (dBm)
1	1908.75		-
	2172.35	-89.69	-13
2	3817.5	-82.63	-13
3	5726.25	-77.92	-13
4	7635	-76.45	-13
5	9543.75	-87.40	-13
6	11452.5	-97.45	-13

7	13361.25	-94.62	-13
8	15270	-95.84	-13
9	17178.75	-93.16	-13
10	19087.5	-94.47	-13

Exhibit 12

Transmitter RF Carrier Frequency Stability - FCC part 2.1055

Transmitter RF Carrier Frequency Stability - FCC part 2.1055

Phone transmitting in FM mode in cellular band, but with no modulation on the carrier

Measured with HP 8560A Spectrum Analyzer and HP 8920 Communication Test Set

Carrier Frequency : 836.49 MHz FM

Temperature (C)	3.4V	3.5V	3.6V	3.8V	4.0V	4.1V	4.2V	lower limit	upper limit
-30	-2	45	45	45	45	45	45	-2091	2091
-20	88	0	0	0	0	0	0	-2091	2091
-10	-19	0	0	0	0	0	0	-2091	2091
0	-33	1	1	1	1	1	1	-2091	2091
10	-47	0	0	0	0	0	0	-2091	2091
20	60	3	0	0	1	1	1	-2091	2091
30	22	-1	0	0	0	0	-1	-2091	2091
40	4	1	1	1	1	1	1	-2091	2091
50	4	4	4	4	4	4	4	-2091	2091
60	828	827	827	828	827	827	827	-2091	2091

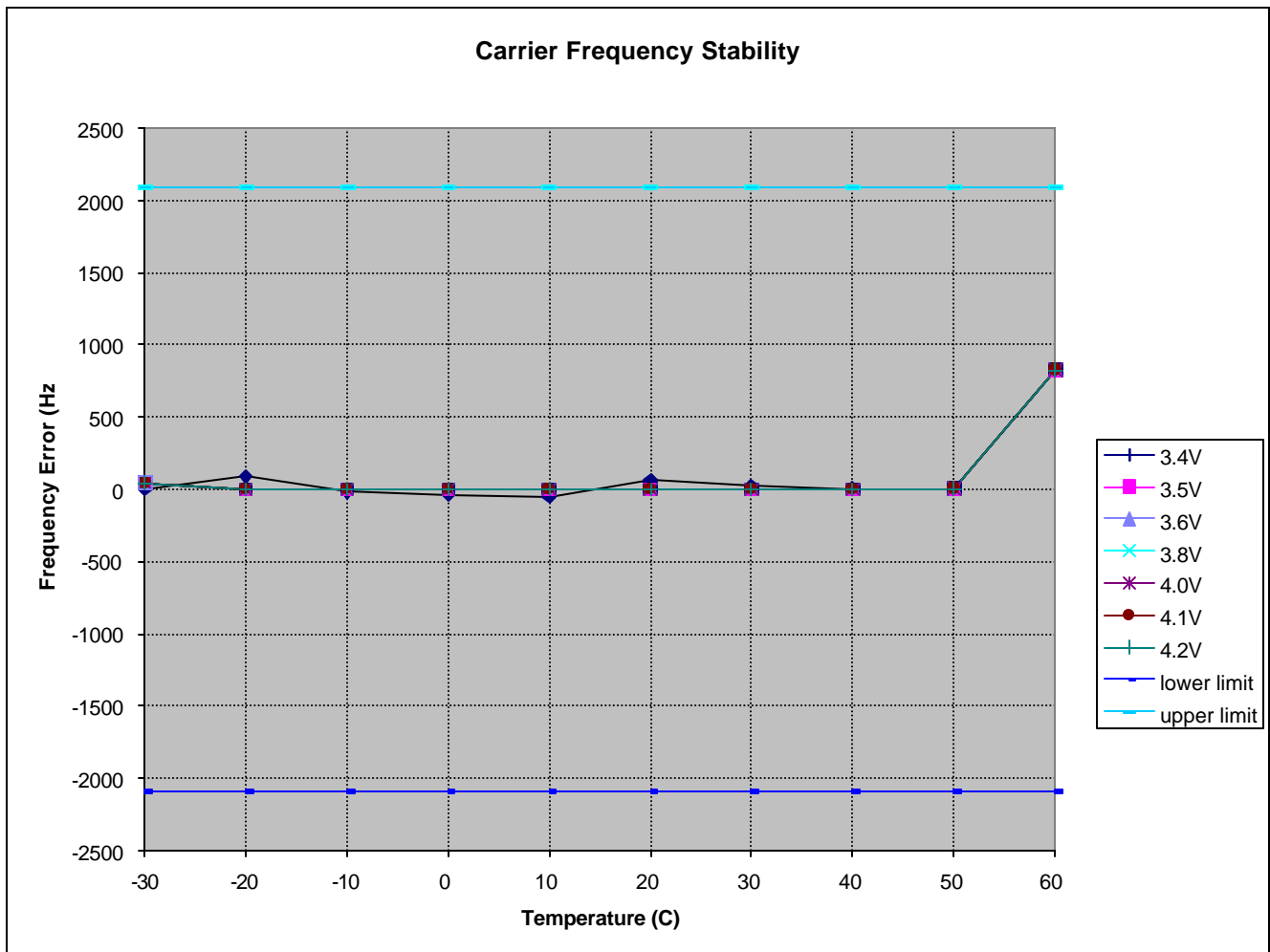

Transmitter RF Carrier Frequency Stability - FCC part 2.1055

Phone transmitting in CDMA mode in cellular band, but with no modulation on the carrier

Measured with HP 8560A Spectrum Analyzer

Carrier Frequency : 836.49 MHz CDMA

Temperature (C)	3.4V	3.5V	3.6V	3.8V	4.0V	4.1V	4.2V	lower limit	upper limit
-30	26	31	134	539	48	147	149	-2062	2062
-20	83	108	99	178	82	89	94	-2062	2062
-10	140	233	237	237	240	245	248	-2062	2062
0	274	305	303	269	280	286	292	-2062	2062
10	225	156	261	267	260	267	283	-2062	2062
20	105	140	141	150	139	131	126	-2062	2062
30	-17	7	6	0	5	1	0	-2062	2062
40	-82	-69	-69	-68	-68	-68	-68	-2062	2062
50	182	11	29	-6	0	17	37	-2062	2062
60	312	354	383	365	465	481	504	-2091	2062

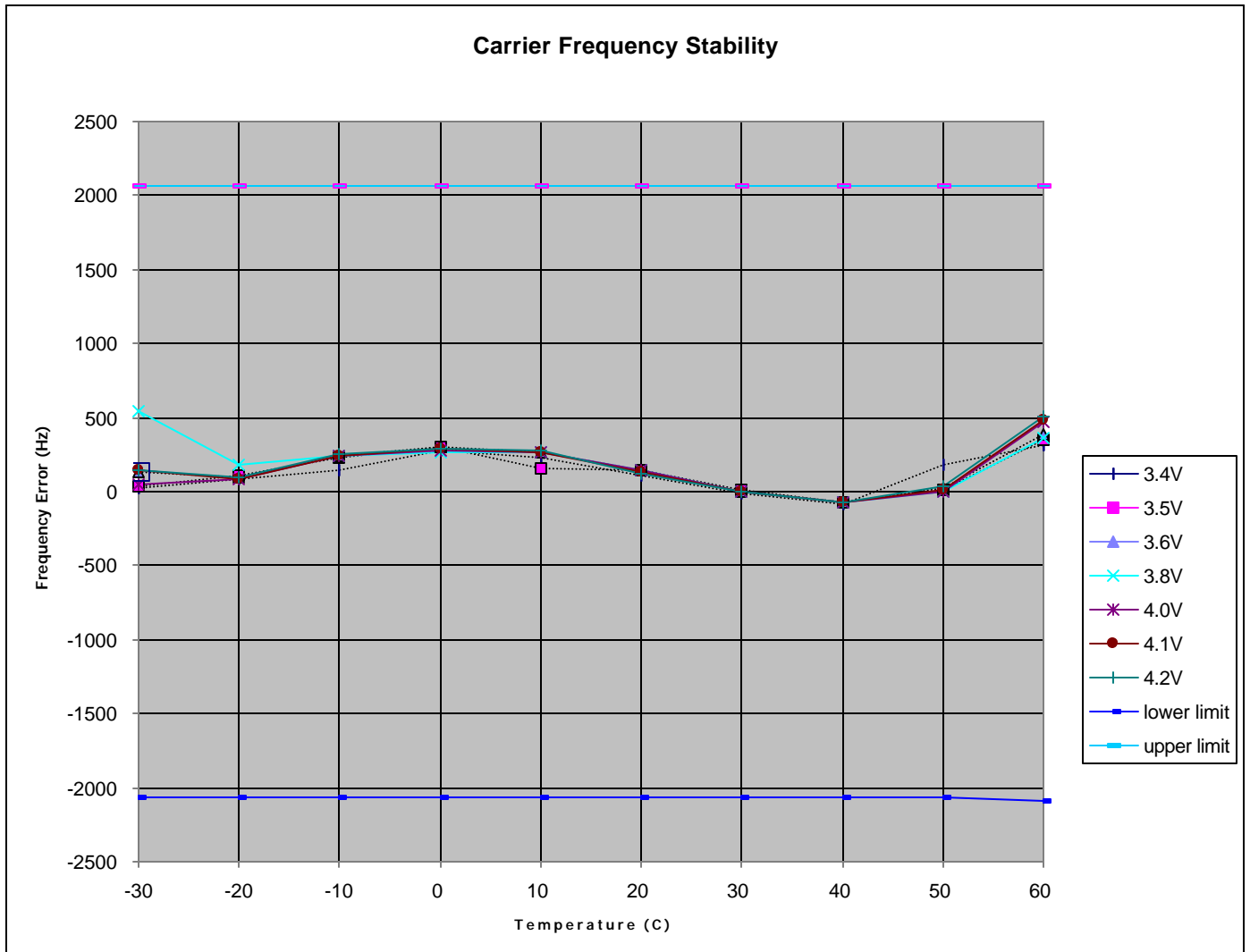

Exhibit 13

Transmitter RF Carrier Frequency Stability - FCC part 2.1055, 24.235

Transmitter RF Carrier Frequency Stability - FCC part 2.1055, 24.235
Phone transmitting in CDMA mode in PCS band, but with no modulation on the carrier

Measured with HP 8560A Spectrum Analyzer

Carrier Frequency : 1880.00 MHz CDMA

temperature (C)	3.4V	3.5V	3.6V	3.8V	4.0V	4.1V	4.2V	lower limit	upper limit
-30	-12	-19	163	171	186	203	268	-4700	4700
-20	87	187	212	287	294	397	304	-4700	4700
-10	414	393	369	332	430	451	471	-4700	4700
0	727	790	832	840	835	832	832	-4700	4700
10	767	777	777	784	761	747	737	-4700	4700
20	474	519	529	542	500	485	459	-4700	4700
30	-81	-26	-46	0	17	34	24	-4700	4700
40	89	-28	37	24	-3	1	24	-4700	4700
50	-43	57	170	200	201	215	253	-4700	4700
60	791	844	857	428	527	672	1208	-4700	4700

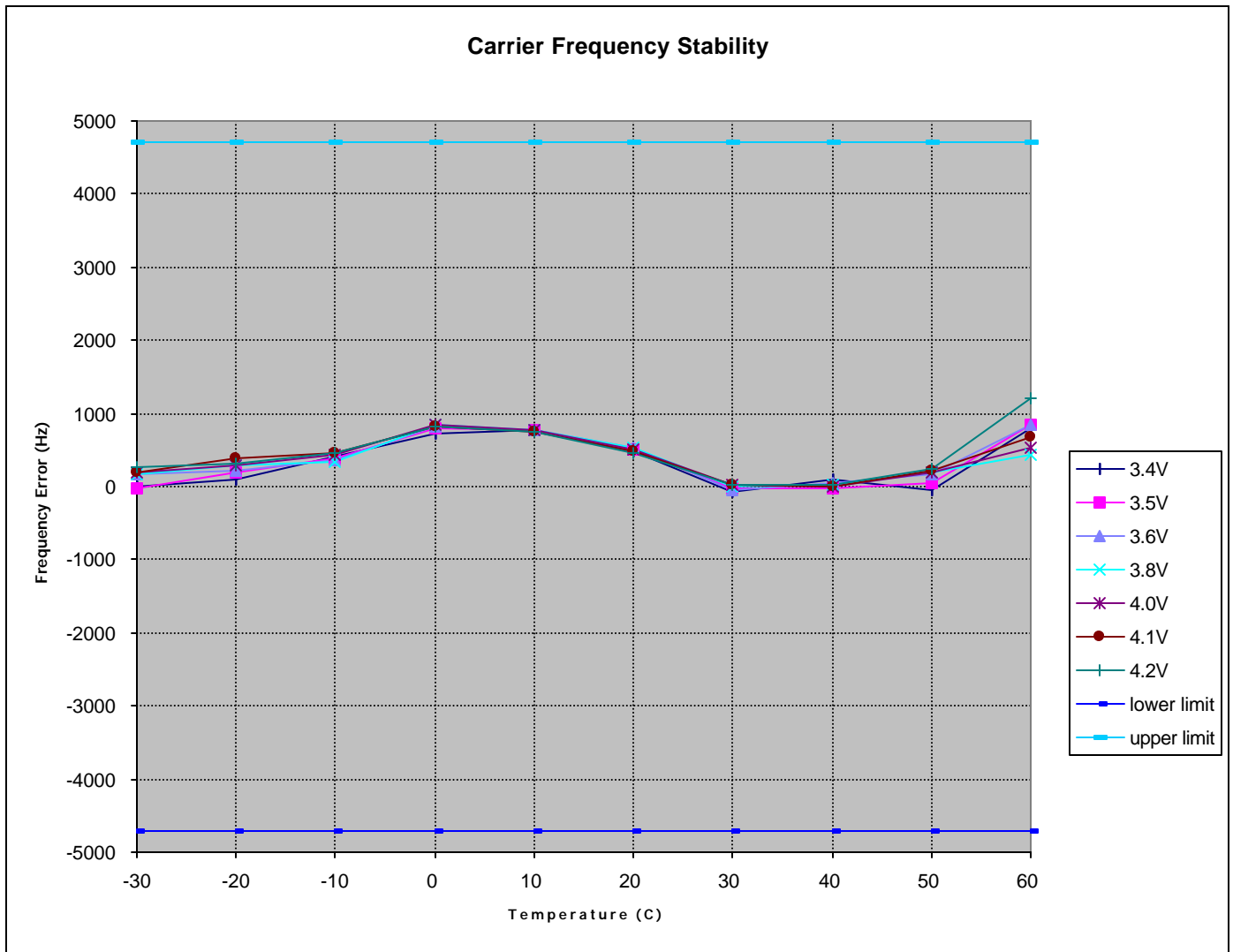

Exhibit 14

Measurement Procedures and Techniques

List of Equipment

Computer with Phone_T software

Spectrum Analyzers

HP8560E, S/N 3643A0680, CAL DUE 8/16/2001

HP8594E, S/N 3710A04900, CAL DUE 1/17/2002

HP8593EM, S/N 3501A01547, CAL DUE 3/5/2002

Audio Spectrum Analyzer

HP3588A, S/N 3005A00111, CAL DUE 1/24/2002

Communication Test Set

HP8920B, S/N US35320824, CAL DUE 11/22/2002

DC Power Supply

Power Meter

Gigatronics 8541C, S/N 1832893, CAL DUE 1/25/2002

Measurement Procedures

RF Output Power

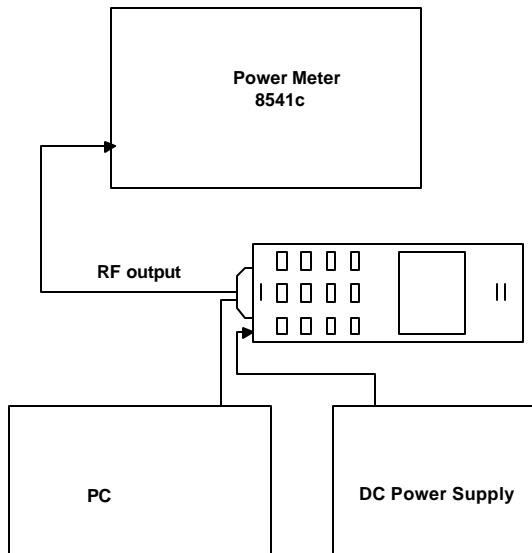

Definition - The output power rating of the transmitter is the power available at the output terminal of the transmitter when the terminal is connected to the normal load.

Method of Measurement - Measure the transmitter output carrier power without modulation using a power meter.

Minimum Standard - The transmitter output power shall be maintained within +2 / -4 dB.

Modulation Audio Response

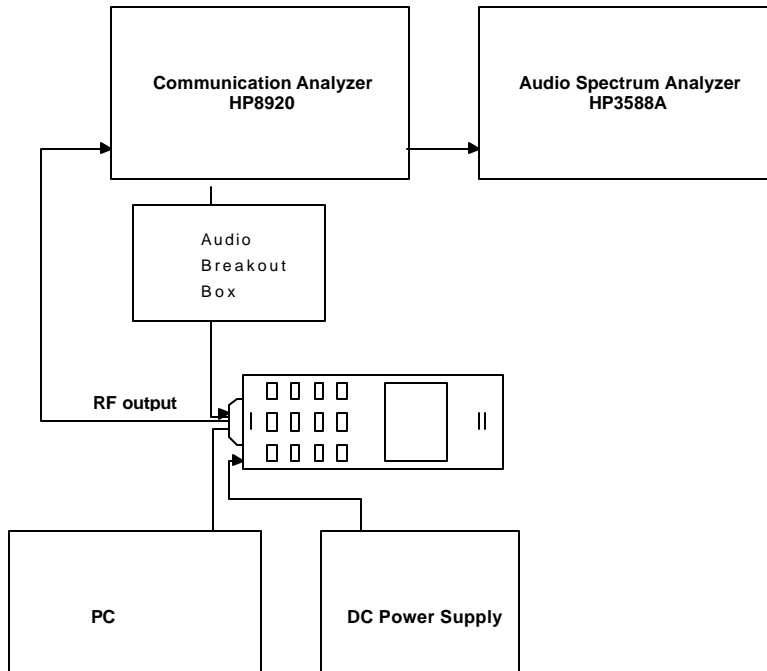

Definition - The transmitter audio frequency response is defined in terms of the degree of closeness with which the frequency deviation of the transmitter follows the prescribed 6 dB/octave pre-emphasis characteristic over a specified continuous audio frequency range while conforming to the required band-limiting conditions outside of that range.

Method of Measurement - Operate the transmitter with the compressor disabled, and monitor the output with HP8920 test receiver without de-emphasis. Apply a sine wave audio input to the transmitter external audio input port, vary the modulating frequency from 100 to 5000 Hz, and observe the input levels necessary to maintain a constant ± 2.9 kHz system deviation. Record the results. Adjust the audio input level to 20 dB greater than that required to produce ± 8 kHz deviation with 1 kHz tone. Vary the modulation frequency from 3 kHz to 30 kHz and observe the deviation while maintaining a constant audio input level. Use the audio spectrum analyzer to measure the output deviation at the same frequency as the input signal.

Minimum Standard - From 300 to 3000 Hz, the audio frequency response shall not vary more than +1 to -3 dB from a true 6 dB/octave pre-emphasis characteristic as referred to the 1000 Hz level (with the exception of a permissible 6 dB/octave roll-off from 2500 to 3000 Hz). Between 3 kHz to 30 kHz, the response shall not exceed that defined by the following table:

Frequency Range (f in kHz)	Attenuation Relative to 3 kHz (dB)
$3 \text{ kHz} \leq f \leq 5.9 \text{ kHz}$	$40 \log (f/3)$
$5.9 \text{ kHz} \leq f \leq 6.1 \text{ kHz}$	35
$6.1 \text{ kHz} \leq f \leq 15 \text{ kHz}$	$40 \log (f/3)$

15 kHz \leq f \leq 30 kHz

28

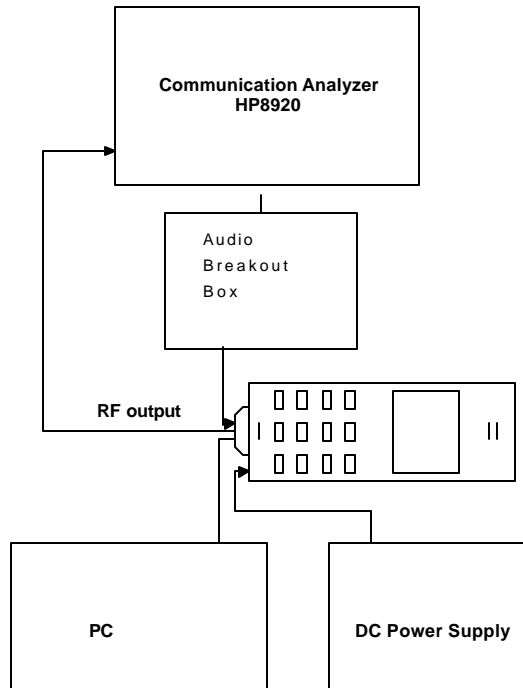
Modulation Limiting

Definition - Modulation limiting refers to the ability of the transmitter circuits to prevent the transmitter from producing deviation in excess of rated system deviation.

Method of Measurement - With the compressor enabled and the SAT disabled, adjust the audio input for ± 8 kHz peak deviation at 1000 Hz. Increase the audio input level by 20 dB. With the input level held constant at the 20 dB, and observe the deviation for 400 Hz, 1000 Hz, and 2.7 kHz.

Minimum Standard - The peak deviation shall not exceed the rated system peak frequency deviation of ± 12 kHz at any time.

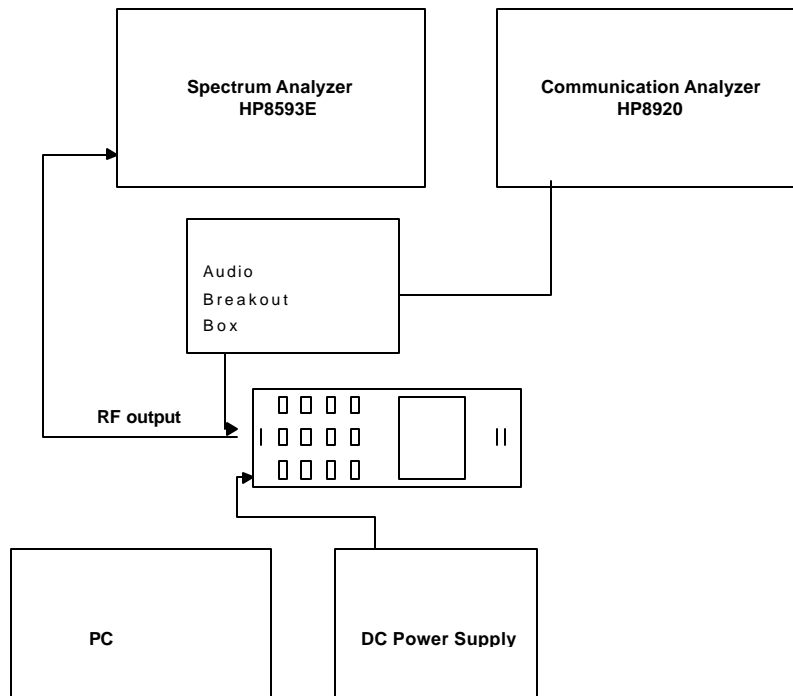
Occupied Bandwidth – (In Cellular Band)

Definition - The occupied bandwidth is defined as the spectrum noise produced at discrete frequency separations from the carrier due to all sources of unwanted noise within the transmitter in a modulated condition.

Method of Measurement - Use the spectrum analyzer and measure the following 8 modulating conditions: (1) For combined voice and SAT, disable the compressor, modulate with a 2500 Hz sine wave 13.5 dB greater than that required to produce ± 8 kHz peak deviation at 1000 Hz and a 6000 Hz SAT with ± 2.0 kHz peak deviation. (2) For combined Signaling Tone and SAT, modulate with a 10 kHz ST with ± 8 kHz peak deviation and a 6000 Hz SAT with ± 2.0 kHz peak deviation. (3) For wideband data, modulate with a quasi-random 10 kbps data pattern with ± 8 kHz peak deviation. (4) For CDMA, modulate with full rate. (5) For voice only, disable the compressor, modulate with a 2500 Hz sine wave 13.5 dB greater than that required to produce ± 8 kHz peak deviation at 1000 Hz. (6) For SAT only, modulate with a 6000 Hz SAT with ± 2.0 kHz peak deviation. (7) For ST only, modulate with a 10 kHz ST with ± 8 kHz peak deviation. (8) For combined SAT and DTMF, modulate with a 6000 Hz SAT with ± 2.0 kHz peak deviation and one of the DTMF tones.

Minimum Standard - The mean power of emissions from the transmitter with modulated carrier shall be attenuated below the mean power of the unmodulated carrier in accordance with the following.

- (1) For all modulation: In a 300 Hz bandwidth centered on any frequency removed from the carrier by greater than 20 kHz up to and including 45 kHz, at least 26 dB.

- (2) For modulation by combined voice and SAT: In a 300 Hz bandwidth centered on any frequency removed from the carrier frequency by greater than 45 kHz, at least $63 + 10 \log$ (mean output power in Watts) dBc. Since the equipment is rated 26.5dBm, the limit is 59.5 dBc.
- (3) For modulation by wideband data and combined ST and SAT: In a 300 Hz bandwidth centered on any frequency:
 - (a) More than 45 kHz up to and including 90 kHz, at least 45 dBc.
 - (b) More than 90 kHz up to the first multiple of the carrier frequency, at least $63 + 10 \log$ (mean power in Watts) dBc.

In addition, in a 30 kHz bandwidth centered anywhere between 869 and 894 MHz, the mean power of emissions from the transmitter with modulated carrier shall not exceed -80 dBm.

Occupied Bandwidth – (In PCS Band)

The procedure has been stated in Exhibit 9

Conducted Spurious and Harmonic Emissions at Antenna Terminal

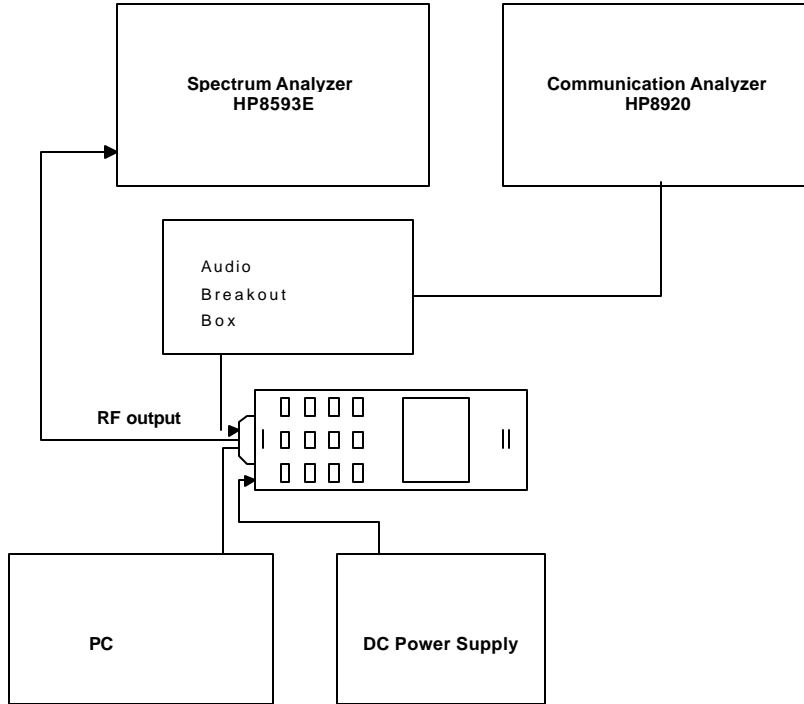

Definition - The conducted harmonic and spurious emissions are emissions at the antenna terminals on a frequency or frequencies that are outside the authorized bandwidth of the transmitter.

Method of Measurement - The transmitter shall be alternately modulated with combined voice and SAT and with wideband data. For combined voice and SAT measurements, disable the compressor, modulate with a 2500 Hz sine wave 13.5 dB greater than that required to produce ± 8 kHz peak deviation at 1000 Hz and a 6000 SAT with ± 2.0 kHz peak deviation. For wideband data measurements, the transmitter shall be modulated with a quasi-random 10 kbps data pattern with ± 8 kHz peak deviation. The measurement shall be made with a spectrum analyzer from the lowest radio frequency generated in the equipment to the 10th harmonic of the carrier except for that region within 75 kHz of the carrier frequency.

Minimum Standard - Conducted harmonic and spurious emissions shall be attenuated below the level of emissions of the carrier frequency by at least $43 + 10 \log$ (mean output power in Watts) dB.

Radiated Spurious and Harmonic Radiation

Definition - The radiated spurious emissions are emissions from the subscriber unit with the attached antenna fully extended. The radiated spurious emissions include those emissions radiated from the attached antenna as well as the equipment cabinet and attached cables.

Method of Measurement - The measurement shall be conducted at standard radiation test site with a search antenna which is movable vertically and is rotatable 90 degrees for vertically and horizontally polarized signals.

Minimum Standard - Radiated spurious emissions shall be attenuated below the maximum level of emission of the carrier frequency by at least $43 + 10 \log$ (mean output power in Watts) dB.

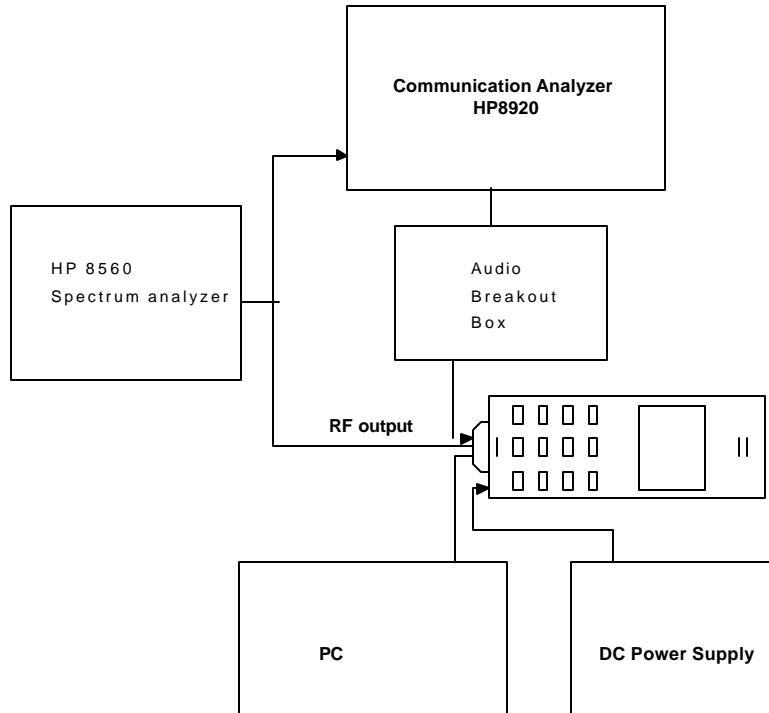
Frequency Stability

Definition - The frequency stability is the ability of the transmitter to maintain an assigned carrier frequency.

Method of Measurement - Use the communication tester to sample the transmitter RF output signal and measure its frequency. Vary the ambient temperature from -30 to +60 °C, and also vary the DC supply voltage to the equipment from 3.2 to 4.2 V at each temperature.

Minimum Standard - The transmitter carrier frequency shall be maintained within ± 2.5 ppm.

Exhibit 15

Product Overview and Circuit Diagrams

Technical Description

The Trimode Phone consists of an Analog FM mode and Code Division Multiple Access (CDMA) mode in the cellular band, and CDMA mode in the PCS band. The analog transmitter is only for use in the Cellular Radiotelephone Service Part 22 of the CFR. The Portable Phone is designed to meet the requirements of TIA/EIA/IS-98-B standards for Dual-Mode Wideband Spread Spectrum Cellular Mobile Stations, and ANSI J-STD_018 standard for 1.8GHz to 2.0GHz Code Division Multiple Access (CDMA) Personal Stations.

Frequency Range of operation: 824 - 849 MHz transmitter and 869 - 894 receiver for cellular band. 1850 – 1910MHz transmitter and 1930 – 1990 receiver for PCS band. Max RF power output is: 0.6W for FM, 0.4W for CDMA in cellular band and 0.3W for CDMA in PCS band.

Power Supply requirements: 4.1V DC Li-Ion battery.

Modulation:

The audio input is sampled, digitally limited, and then filtered to amplitude and frequency limit the signal applied to the modulator. The device supports the AMPS standard. The device has an operating temperature range of -30 to +60 C. The functions include Compandor, PLL lock detect for received data, audio signal filtering for signals.

Power limiting:

Transmitted power is monitored by a RF detector diode which is coupled from the Power Amplifier (PA) output. The detected DC voltage is fed into a microprocessor which uses a calibration table along with an offset correction and temperature correction table to control power limits. When the RF power exceeds a predetermined limit the gain of the stage preceding the PA is reduced.

Block and Circuit Diagrams

Block and circuit diagrams are included in separate attachments.