

**Appendix D:**  
**Dipole Calibration Parameters**



Accredited by the Swiss Accreditation Service (SAS)  
 The Swiss Accreditation Service is one of the signatories to the EA  
 Multilateral Agreement for the recognition of calibration certificates

Accreditation No.: **SCS 108**

Client **Kyocera USA**

Certificate No: **D1900V2-5d016-Sep08**

## CALIBRATION CERTIFICATE

Object **D1900V2 - SN: 5d016**

Calibration procedure(s) **QA CAL-05.v7  
 Calibration procedure for dipole validation kits**

Calibration date: **September 15, 2008**

Condition of the calibrated item **In Tolerance**

This calibration certificate documents the traceability to national standards, which realize the physical units of measurements (SI).  
 The measurements and the uncertainties with confidence probability are given on the following pages and are part of the certificate.

All calibrations have been conducted in the closed laboratory facility: environment temperature (22 ± 3)°C and humidity < 70%.

Calibration Equipment used (M&TE critical for calibration)

Primary Standards	ID #	Cal Date (Calibrated by, Certificate No.)	Scheduled Calibration
Power meter EPM-442A	GB37480704	04-Oct-07 (No. 217-00736)	Oct-08
Power sensor HP 8481A	US37292783	04-Oct-07 (No. 217-00736)	Oct-08
Reference 20 dB Attenuator	SN: 5086 (20g)	01-Jul-08 (No. 217-00864)	Jul-09
Type-N mismatch combination	SN: 5047.2 / 06327	01-Jul-08 (No. 217-00867)	Jul-09
Reference Probe ES3DV2	SN: 3025	28-Apr-08 (No. ES3-3025_Apr08)	Apr-09
DAE4	SN: 601	14-Mar-08 (No. DAE4-601_Mar08)	Mar-09
Secondary Standards	ID #	Check Date (in house)	Scheduled Check
Power sensor HP 8481A	MY41092317	18-Oct-02 (in house check Oct-07)	In house check: Oct-09
RF generator R&S SMT-06	100005	4-Aug-99 (in house check Oct-07)	In house check: Oct-09
Network Analyzer HP 8753E	US37390585 S4206	18-Oct-01 (in house check Oct-07)	In house check: Oct-08

Calibrated by: **Jeton Kastrati**      **Function: Laboratory Technician**

Approved by: **Katja Pokovic**      **Technical Manager**

Issued: September 17, 2008

This calibration certificate shall not be reproduced except in full without written approval of the laboratory.



Accredited by the Swiss Accreditation Service (SAS)  
The Swiss Accreditation Service is one of the signatories to the EA  
Multilateral Agreement for the recognition of calibration certificates

Accreditation No.: **SCS 108**

### Glossary:

TSL	tissue simulating liquid
ConvF	sensitivity in TSL / NORM x,y,z
N/A	not applicable or not measured

### Calibration is Performed According to the Following Standards:

- IEEE Std 1528-2003, "IEEE Recommended Practice for Determining the Peak Spatial-Averaged Specific Absorption Rate (SAR) in the Human Head from Wireless Communications Devices: Measurement Techniques", December 2003
- CENELEC EN 50361, "Basic standard for the measurement of Specific Absorption Rate related to human exposure to electromagnetic fields from mobile phones (300 MHz - 3 GHz), July 2001
- Federal Communications Commission Office of Engineering & Technology (FCC OET), "Evaluating Compliance with FCC Guidelines for Human Exposure to Radiofrequency Electromagnetic Fields; Additional Information for Evaluating Compliance of Mobile and Portable Devices with FCC Limits for Human Exposure to Radiofrequency Emissions", Supplement C (Edition 01-01) to Bulletin 65

### Additional Documentation:

- DASY4/5 System Handbook

### Methods Applied and Interpretation of Parameters:

- Measurement Conditions:** Further details are available from the Validation Report at the end of the certificate. All figures stated in the certificate are valid at the frequency indicated.
- Antenna Parameters with TSL:** The dipole is mounted with the spacer to position its feed point exactly below the center marking of the flat phantom section, with the arms oriented parallel to the body axis.
- Feed Point Impedance and Return Loss:** These parameters are measured with the dipole positioned under the liquid filled phantom. The impedance stated is transformed from the measurement at the SMA connector to the feed point. The Return Loss ensures low reflected power. No uncertainty required.
- Electrical Delay:** One-way delay between the SMA connector and the antenna feed point. No uncertainty required.
- SAR measured:** SAR measured at the stated antenna input power.
- SAR normalized:** SAR as measured, normalized to an input power of 1 W at the antenna connector.
- SAR for nominal TSL parameters:** The measured TSL parameters are used to calculate the nominal SAR result.

## Measurement Conditions

DASY system configuration, as far as not given on page 1.

<b>DASY Version</b>	DASY5	V5.0
<b>Extrapolation</b>	Advanced Extrapolation	
<b>Phantom</b>	Modular Flat Phantom V5.0	
<b>Distance Dipole Center - TSL</b>	10 mm	with Spacer
<b>Zoom Scan Resolution</b>	dx, dy, dz = 5 mm	
<b>Frequency</b>	1900 MHz $\pm$ 1 MHz	

## Head TSL parameters

The following parameters and calculations were applied.

	Temperature	Permittivity	Conductivity
<b>Nominal Head TSL parameters</b>	22.0 °C	40.0	1.40 mho/m
<b>Measured Head TSL parameters</b>	(22.0 $\pm$ 0.2) °C	40.7 $\pm$ 6 %	1.47 mho/m $\pm$ 6 %
<b>Head TSL temperature during test</b>	(21.5 $\pm$ 0.2) °C	---	---

## SAR result with Head TSL

<b>SAR averaged over 1 cm<sup>3</sup> (1 g) of Head TSL</b>	condition	
SAR measured	250 mW input power	10.3 mW / g
SAR normalized	normalized to 1W	41.2 mW / g
SAR for nominal Head TSL parameters <sup>1</sup>	normalized to 1W	<b>40.6 mW / g <math>\pm</math> 17.0 % (k=2)</b>

<b>SAR averaged over 10 cm<sup>3</sup> (10 g) of Head TSL</b>	Condition	
SAR measured	250 mW input power	5.37 mW / g
SAR normalized	normalized to 1W	21.5 mW / g
SAR for nominal Head TSL parameters <sup>1</sup>	normalized to 1W	<b>21.4 mW / g <math>\pm</math> 16.5 % (k=2)</b>

<sup>1</sup> Correction to nominal TSL parameters according to d), chapter "SAR Sensitivities"

## Body TSL parameters

The following parameters and calculations were applied.

	Temperature	Permittivity	Conductivity
Nominal Body TSL parameters	22.0 °C	53.3	1.52 mho/m
Measured Body TSL parameters	(22.0 ± 0.2) °C	52.1 ± 6 %	1.6 mho/m ± 6 %
Body TSL temperature during test	(21.5 ± 0.2) °C	---	---

## SAR result with Body TSL

SAR averaged over 1 cm <sup>3</sup> (1 g) of Body TSL	Condition	
SAR measured	250 mW input power	10.2 mW / g
SAR normalized	normalized to 1W	40.8 mW / g
SAR for nominal Body TSL parameters <sup>2</sup>	normalized to 1W	<b>39.1 mW / g ± 17.0 % (k=2)</b>

SAR averaged over 10 cm <sup>3</sup> (10 g) of Body TSL	condition	
SAR measured	250 mW input power	5.31 mW / g
SAR normalized	normalized to 1W	21.2 mW / g
SAR for nominal Body TSL parameters <sup>2</sup>	normalized to 1W	<b>20.8 mW / g ± 16.5 % (k=2)</b>

<sup>2</sup> Correction to nominal TSL parameters according to d), chapter "SAR Sensitivities"

## Appendix

### Antenna Parameters with Head TSL

Impedance, transformed to feed point	$51.9 \Omega + 4.5 j\Omega$
Return Loss	- 26.4 dB

### Antenna Parameters with Body TSL

Impedance, transformed to feed point	$47.0 \Omega + 4.8 j\Omega$
Return Loss	- 24.7 dB

### General Antenna Parameters and Design

Electrical Delay (one direction)	1.195 ns
----------------------------------	----------

After long term use with 100W radiated power, only a slight warming of the dipole near the feedpoint can be measured.

The dipole is made of standard semirigid coaxial cable. The center conductor of the feeding line is directly connected to the second arm of the dipole. The antenna is therefore short-circuited for DC-signals.

No excessive force must be applied to the dipole arms, because they might bend or the soldered connections near the feedpoint may be damaged.

### Additional EUT Data

Manufactured by	SPEAG
Manufactured on	June 04, 2002

# DASY5 Validation Report for Head TSL

Date/Time: 11.09.2008 14:48:18

Test Laboratory: SPEAG, Zurich, Switzerland

**DUT: Dipole 1900 MHz; Type: D1900V2; Serial: D1900V2 - SN:5d016**

Communication System: CW; Frequency: 1900 MHz; Duty Cycle: 1:1

Medium: HSL U10 BB

Medium parameters used:  $f = 1900$  MHz;  $\sigma = 1.47$  mho/m;  $\epsilon_r = 40.7$ ;  $\rho = 1000$  kg/m<sup>3</sup>

Phantom section: Flat Section

Measurement Standard: DASY5 (IEEE/IEC)

## DASY5 Configuration:

- Probe: ES3DV2 - SN3025; ConvF(4.9, 4.9, 4.9); Calibrated: 28.04.2008
- Sensor-Surface: 3.4mm (Mechanical Surface Detection)
- Electronics: DAE4 Sn601; Calibrated: 14.03.2008
- Phantom: Flat Phantom 5.0 (front); Type: QD000P50AA; Serial: 1001
- Measurement SW: DASY5, V5.0 Build 119; SEMCAD X Version 13.2 Build 87

**Pin = 250 mW; dip = 10 mm, scan at 3.4mm/Zoom Scan (dist=3.4mm, probe 0deg)**

**(7x7x7)/Cube 0:** Measurement grid: dx=5mm, dy=5mm, dz=5mm

Reference Value = 93.2 V/m; Power Drift = 0.00747 dB

Peak SAR (extrapolated) = 19 W/kg

**SAR(1 g) = 10.3 mW/g; SAR(10 g) = 5.37 mW/g**

Maximum value of SAR (measured) = 12.2 mW/g

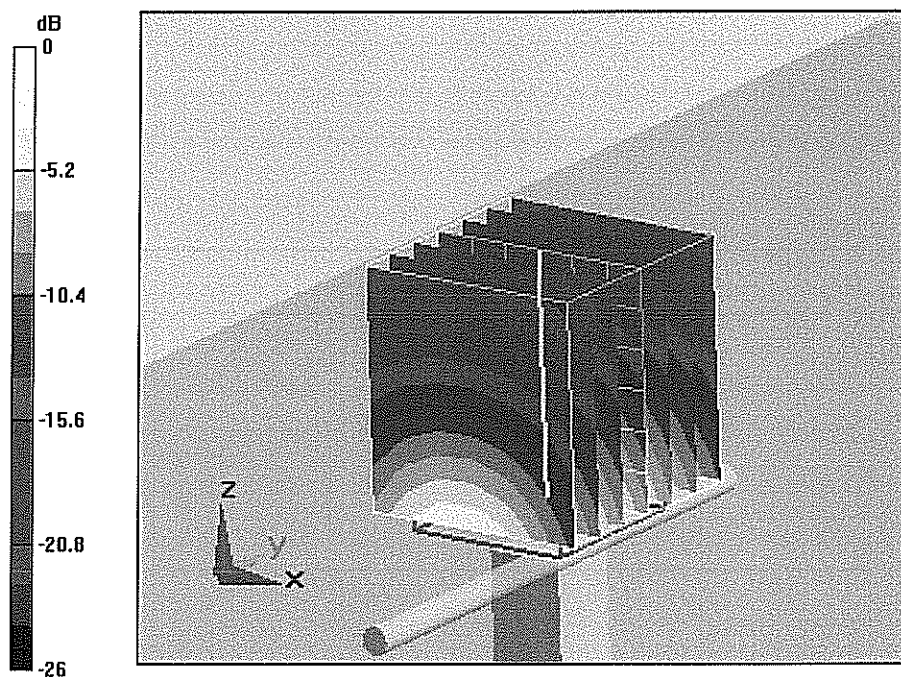

0 dB = 12.2mW/g

# Impedance Measurement Plot for Head TSL

11 Sep 2008 11:06:53

CH1 S11 1 U FS 2: 51.904  $\Omega$  4.5098  $\Omega$  377.76  $\mu\text{H}$  1 900.000 000 MHz

\*  
Del  
Cor

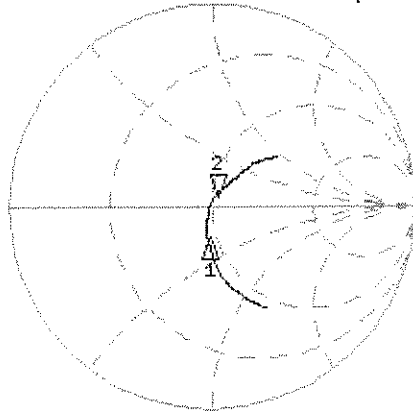

CH1 Markers  
1: 46.000  $\Omega$   
-15.488  $\Omega$   
1.00000 GHz

Avg  
16

↑

CH2 S11 LOG 5 dB/REF -20 dB 2:-26.355 dB 1 900.000 000 MHz

Cor

Avg  
16

↑

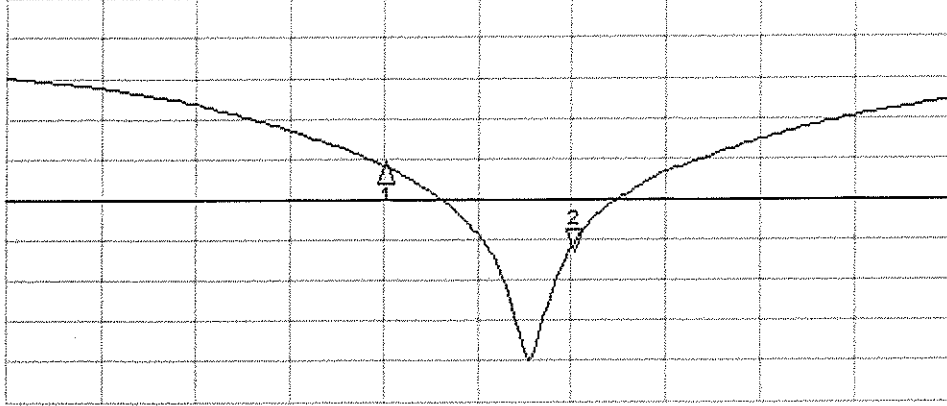

CH2 Markers  
1:-15.678 dB  
1.00000 GHz

START 1 500.000 000 MHz

STOP 2 100.000 000 MHz



## DASY5 Validation Report for Body TSL

Date/Time: 15.09.2008 14:13:19

Test Laboratory: SPEAG, Zurich, Switzerland

**DUT: Dipole 1900 MHz; Type: D1900V2; Serial: D1900V2 - SN:5d016**

Communication System: CW; Frequency: 1900 MHz; Duty Cycle: 1:1

Medium: MSL U10 BB

Medium parameters used:  $f = 1900$  MHz;  $\sigma = 1.6$  mho/m;  $\epsilon_r = 52.1$ ;  $\rho = 1000$  kg/m<sup>3</sup>

Phantom section: Flat Section

Measurement Standard: DASY5 (IEEE/IEC)

### DASY5 Configuration:

- Probe: ES3DV2 - SN3025; ConvF(4.5, 4.5, 4.5); Calibrated: 28.04.2008
- Sensor-Surface: 3.4mm (Mechanical Surface Detection)
- Electronics: DAE4 Sn601; Calibrated: 14.03.2008
- Phantom: Flat Phantom 5.0 (back); Type: QD000P50AA; Serial: 1002
- Measurement SW: DASY5, V5.0 Build 119; SEMCAD X Version 13.2 Build 87

**Pin = 250 mW; dip = 10 mm, scan at 3.4mm/Zoom Scan (dist=3.4mm, probe 0deg)**

**(7x7x7)/Cube 0:** Measurement grid: dx=5mm, dy=5mm, dz=5mm

Reference Value = 91.3 V/m; Power Drift = 0.00376 dB

Peak SAR (extrapolated) = 18.3 W/kg

**SAR(1 g) = 10.2 mW/g; SAR(10 g) = 5.31 mW/g**

Maximum value of SAR (measured) = 12.5 mW/g

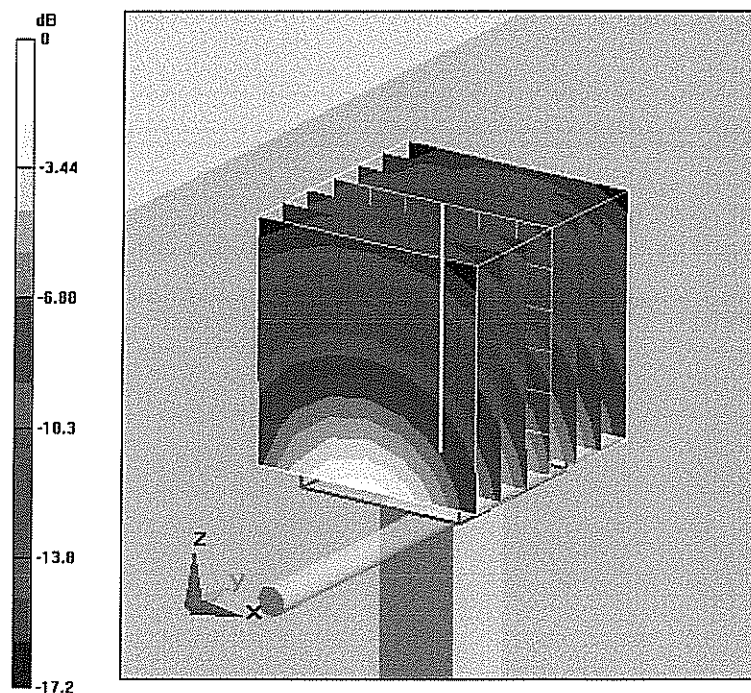

0 dB = 12.5mW/g

# Impedance Measurement Plot for Body TSL

15 Sep 2008 10:28:12

CH1 S11 1 U FS 2: 47.039  $\Omega$  4.8457  $\Omega$  405.90  $\mu$ H 1 900.000 000 MHz

\*  
Del  
Cor

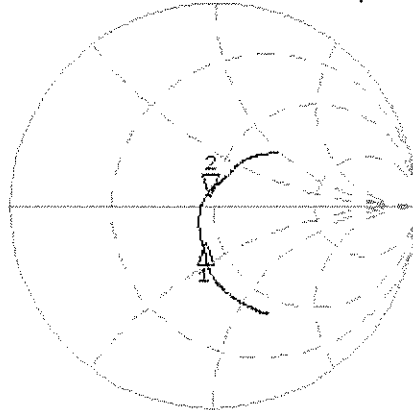

CH1 Markers  
1: 47.418  $\Omega$   
-15.305  $\Omega$   
1.80000 GHz

Avg  
16

↑

CH2 S11 LOG 5 dB/ REF -20 dB 2: -24.662 dB 1 900.000 000 MHz

Cor

Avg  
16

↑

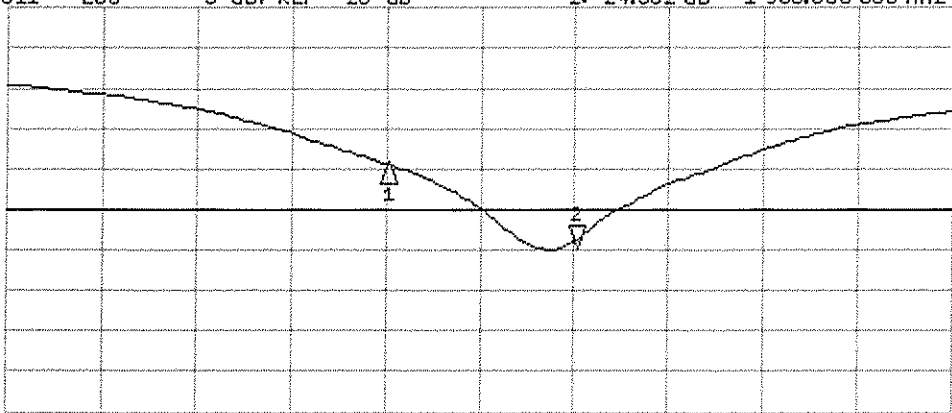

CH2 Markers  
1: -14.352 dB  
1.80000 GHz

START 1 1600.000 000 MHz

STOP 2 2000.000 000 MHz



Accredited by the Swiss Accreditation Service (SAS)  
The Swiss Accreditation Service is one of the signatories to the EA  
Multilateral Agreement for the recognition of calibration certificates

Accreditation No.: **SCS 108**

Client **Kyocera USA**

Certificate No: **D835V2-467\_Sep08**

## CALIBRATION CERTIFICATE

Object **D835V2 - SN: 467**

Calibration procedure(s) **QA CAL-05.v7  
Calibration procedure for dipole validation kits**

Calibration date: **September 16, 2008**

Condition of the calibrated item **In Tolerance**

This calibration certificate documents the traceability to national standards, which realize the physical units of measurements (SI).  
The measurements and the uncertainties with confidence probability are given on the following pages and are part of the certificate.

All calibrations have been conducted in the closed laboratory facility: environment temperature (22 ± 3)°C and humidity < 70%.

Calibration Equipment used (M&TE critical for calibration)

Primary Standards	ID #	Cal Date (Certificate No.)	Scheduled Calibration
Power meter EPM-442A	GB37480704	04-Oct-07 (No. 217-00736)	Oct-08
Power sensor HP 8481A	US37292783	04-Oct-07 (No. 217-00736)	Oct-08
Reference 20 dB Attenuator	SN: 5086 (20g)	01-Jul-08 (No. 217-00864)	Jul-09
Type-N mismatch combination	SN: 5047.2 / 06327	01-Jul-08 (No. 217-00867)	Jul-09
Reference Probe ES3DV2	SN: 3025	28-Apr-08 (No. ES3-3025_Apr08)	Apr-09
DAE4	SN: 601	14-Mar-08 (No. DAE4-601_Mar08)	Mar-09
Secondary Standards	ID #	Check Date (in house)	Scheduled Check
Power sensor HP 8481A	MY41092317	18-Oct-02 (in house check Oct-07)	In house check: Oct-09
RF generator R&S SMT-06	100005	4-Aug-99 (in house check Oct-07)	In house check: Oct-09
Network Analyzer HP 8753E	US37390585 S4206	18-Oct-01 (in house check Oct-07)	In house check: Oct-08

	Name	Function	Signature
Calibrated by:	Marcel Fehr	Laboratory Technician	
Approved by:	Katja Pokovic	Technical Manager	

Issued: September 16, 2008

This calibration certificate shall not be reproduced except in full without written approval of the laboratory.



Accredited by the Swiss Accreditation Service (SAS)  
The Swiss Accreditation Service is one of the signatories to the EA  
Multilateral Agreement for the recognition of calibration certificates

Accreditation No.: **SCS 108**

### Glossary:

TSL	tissue simulating liquid
ConvF	sensitivity in TSL / NORM x,y,z
N/A	not applicable or not measured

### Calibration is Performed According to the Following Standards:

- IEEE Std 1528-2003, "IEEE Recommended Practice for Determining the Peak Spatial-Averaged Specific Absorption Rate (SAR) in the Human Head from Wireless Communications Devices: Measurement Techniques", December 2003
- IEC 62209-1, "Procedure to measure the Specific Absorption Rate (SAR) for hand-held devices used in close proximity to the ear (frequency range of 300 MHz to 3 GHz)", February 2005
- Federal Communications Commission Office of Engineering & Technology (FCC OET), "Evaluating Compliance with FCC Guidelines for Human Exposure to Radiofrequency Electromagnetic Fields; Additional Information for Evaluating Compliance of Mobile and Portable Devices with FCC Limits for Human Exposure to Radiofrequency Emissions", Supplement C (Edition 01-01) to Bulletin 65

### Additional Documentation:

- DASY4/5 System Handbook

### Methods Applied and Interpretation of Parameters:

- Measurement Conditions:** Further details are available from the Validation Report at the end of the certificate. All figures stated in the certificate are valid at the frequency indicated.
- Antenna Parameters with TSL:** The dipole is mounted with the spacer to position its feed point exactly below the center marking of the flat phantom section, with the arms oriented parallel to the body axis.
- Feed Point Impedance and Return Loss:** These parameters are measured with the dipole positioned under the liquid filled phantom. The impedance stated is transformed from the measurement at the SMA connector to the feed point. The Return Loss ensures low reflected power. No uncertainty required.
- Electrical Delay:** One-way delay between the SMA connector and the antenna feed point. No uncertainty required.
- SAR measured:** SAR measured at the stated antenna input power.
- SAR normalized:** SAR as measured, normalized to an input power of 1 W at the antenna connector.
- SAR for nominal TSL parameters:** The measured TSL parameters are used to calculate the nominal SAR result.

## Measurement Conditions

DASY system configuration, as far as not given on page 1.

<b>DASY Version</b>	DASY5	V5.0
<b>Extrapolation</b>	Advanced Extrapolation	
<b>Phantom</b>	Modular Flat Phantom V4.9	
<b>Distance Dipole Center - TSL</b>	15 mm	with Spacer
<b>Zoom Scan Resolution</b>	dx, dy, dz = 5 mm	
<b>Frequency</b>	835 MHz $\pm$ 1 MHz	

## Head TSL parameters

The following parameters and calculations were applied.

	Temperature	Permittivity	Conductivity
<b>Nominal Head TSL parameters</b>	22.0 °C	41.5	0.90 mho/m
<b>Measured Head TSL parameters</b>	(22.0 $\pm$ 0.2) °C	41.2 $\pm$ 6 %	0.88 mho/m $\pm$ 6 %
<b>Head TSL temperature during test</b>	(22.0 $\pm$ 0.2) °C	—	—

## SAR result with Head TSL

<b>SAR averaged over 1 cm<sup>3</sup> (1 g) of Head TSL</b>	Condition	
SAR measured	250 mW input power	2.35 mW / g
SAR normalized	normalized to 1W	9.40 mW / g
SAR for nominal Head TSL parameters <sup>1</sup>	normalized to 1W	<b>9.35 mW / g <math>\pm</math> 17.0 % (k=2)</b>

<b>SAR averaged over 10 cm<sup>3</sup> (10 g) of Head TSL</b>	condition	
SAR measured	250 mW input power	1.54 mW / g
SAR normalized	normalized to 1W	6.16 mW / g
SAR for nominal Head TSL parameters <sup>1</sup>	normalized to 1W	<b>6.12 mW / g <math>\pm</math> 16.5 % (k=2)</b>

<sup>1</sup> Correction to nominal TSL parameters according to d), chapter "SAR Sensitivities"

## Body TSL parameters

The following parameters and calculations were applied.

	Temperature	Permittivity	Conductivity
Nominal Body TSL parameters	22.0 °C	55.2	0.97 mho/m
Measured Body TSL parameters	(22.0 ± 0.2) °C	53.3 ± 6 %	1.01 mho/m ± 6 %
Body TSL temperature during test	(21.7 ± 0.2) °C	—	—

## SAR result with Body TSL

SAR averaged over 1 cm <sup>3</sup> (1 g) of Body TSL	Condition	
SAR measured	250 mW input power	2.49 mW / g
SAR normalized	normalized to 1W	9.96 mW / g
SAR for nominal Body TSL parameters <sup>2</sup>	normalized to 1W	<b>9.49 mW / g ± 17.0 % (k=2)</b>

SAR averaged over 10 cm <sup>3</sup> (10 g) of Body TSL	condition	
SAR measured	250 mW input power	1.64 mW / g
SAR normalized	normalized to 1W	6.56 mW / g
SAR for nominal Body TSL parameters <sup>2</sup>	normalized to 1W	<b>6.34 mW / g ± 16.5 % (k=2)</b>

<sup>2</sup> Correction to nominal TSL parameters according to d), chapter "SAR Sensitivities"

## Appendix

### Antenna Parameters with Head TSL

Impedance, transformed to feed point	47.3 $\Omega$ -1.7 j $\Omega$
Return Loss	- 29.6 dB

### Antenna Parameters with Body TSL

Impedance, transformed to feed point	45.3 $\Omega$ -5.1 j $\Omega$
Return Loss	- 22.8 dB

### General Antenna Parameters and Design

Electrical Delay (one direction)	1.363 ns
----------------------------------	----------

After long term use with 100W radiated power, only a slight warming of the dipole near the feedpoint can be measured.

The dipole is made of standard semirigid coaxial cable. The center conductor of the feeding line is directly connected to the second arm of the dipole. The antenna is therefore short-circuited for DC-signals.

No excessive force must be applied to the dipole arms, because they might bend or the soldered connections near the feedpoint may be damaged.

### Additional EUT Data

Manufactured by	SPEAG
Manufactured on	August 27, 2002

## DASY5 Validation Report for Head TSL

Date/Time: 12.09.2008 12:33:15

Test Laboratory: SPEAG, Zurich, Switzerland

**DUT: Dipole 835 MHz; Type: D835V2; Serial: D835V2 - SN:467**

Communication System: CW-835; Frequency: 835 MHz; Duty Cycle: 1:1

Medium: HSL 900 MHz

Medium parameters used:  $f = 835$  MHz;  $\sigma = 0.9$  mho/m;  $\epsilon_r = 41.2$ ;  $\rho = 1000$  kg/m<sup>3</sup>

Phantom section: Flat Section

Measurement Standard: DASY5 (IEEE/IEC)

### DASY5 Configuration:

- Probe: ES3DV2 - SN3025; ConvF(5.97, 5.97, 5.97); Calibrated: 28.04.2008
- Sensor-Surface: 3.4mm (Mechanical Surface Detection)
- Electronics: DAE4 Sn601; Calibrated: 14.03.2008
- Phantom: Flat Phantom 4.9L; Type: QD000P49AA; Serial: 1001
- Measurement SW: DASY5, V5.0 Build 119; SEMCAD X Version 13.2 Build 87

**Pin=250mW; dip=15mm; dist=3.4mm/Zoom Scan (7x7x7)/Cube 0:**

Measurement grid: dx=5mm, dy=5mm, dz=5mm

Reference Value = 55.6 V/m; Power Drift = 0.018 dB

Peak SAR (extrapolated) = 3.44 W/kg

**SAR(1 g) = 2.35 mW/g; SAR(10 g) = 1.54 mW/g**

Maximum value of SAR (measured) = 2.65 mW/g

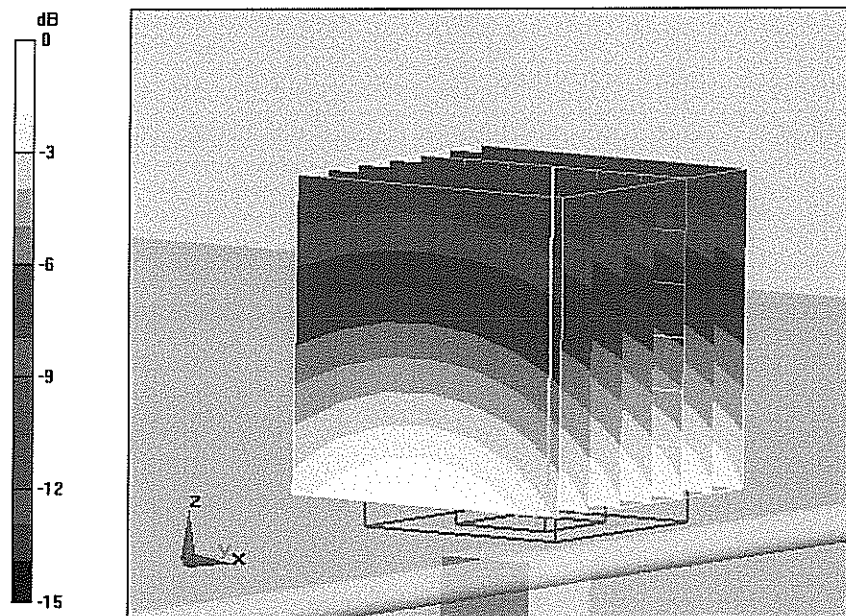

0 dB = 2.65mW/g



# Impedance Measurement Plot for Head TSL

12 Sep 2008 08:54:47

CH1 S11 1 U FS 1: 47.260  $\Omega$  -1.6895  $\Omega$  112.92 pF 835.000 000 MHz

\*  
Del  
Cor  
Avg  
16  
↑

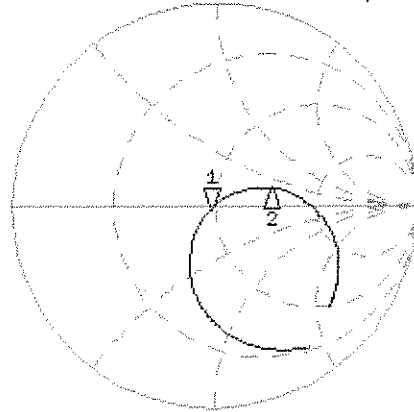

CH1 Markers  
2: 85.566  $\Omega$   
16.328  $\Omega$   
900.000 MHz

CH2 S11 LOG 5 dB/REF -20 dB 1: -29.633 dB 835.000 000 MHz

Cor  
Avg  
16  
↑

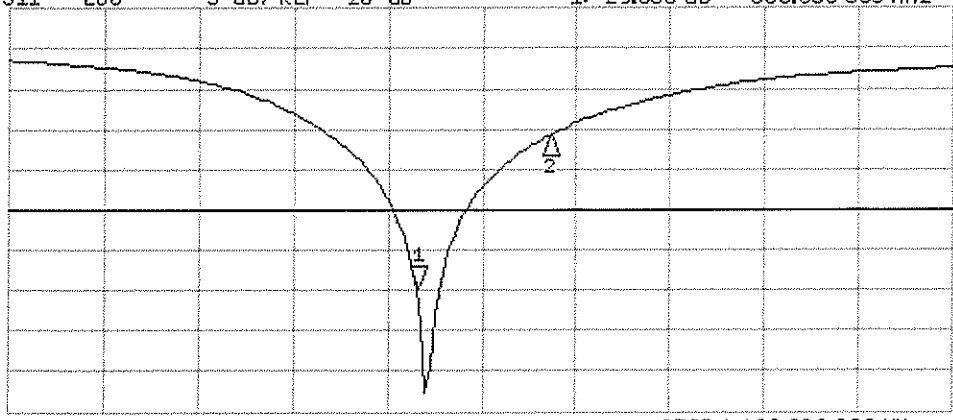

CH2 Markers  
2: -10.854 dB  
900.000 MHz

Test Laboratory: SPEAG, Zurich, Switzerland

**DUT: Dipole 835 MHz; Type: D835V2; Serial: D835V2 - SN:467**

Communication System: CW; Frequency: 835 MHz; Duty Cycle: 1:1

Medium: MSL900

Medium parameters used:  $f = 835 \text{ MHz}$ ;  $\sigma = 1.01 \text{ mho/m}$ ;  $\epsilon_r = 53.3$ ;  $\rho = 1000 \text{ kg/m}^3$

Phantom section: Flat Section

Measurement Standard: DASY5 (IEEE/IEC)

DASY5 Configuration:

- Probe: ES3DV2 - SN3025; ConvF(5.9, 5.9, 5.9); Calibrated: 28.04.2008
- Sensor-Surface: 3.4mm (Mechanical Surface Detection)
- Electronics: DAE4 Sn601; Calibrated: 14.03.2008
- Phantom: Flat Phantom 4.9L; Type: QD000P49AA; Serial: 1001
- Measurement SW: DASY5, V5.0 Build 119; SEMCAD X Version 13.2 Build 87

**Pin = 250mW, d = 15mm/Zoom Scan (7x7x7)/Cube 0:**

Measurement grid:  $dx=5\text{mm}$ ,  $dy=5\text{mm}$ ,  $dz=5\text{mm}$

Reference Value = 53.9 V/m; Power Drift = 0.046 dB

Peak SAR (extrapolated) = 3.61 W/kg

**SAR(1 g) = 2.49 mW/g; SAR(10 g) = 1.64 mW/g**

Maximum value of SAR (measured) = 2.79 mW/g

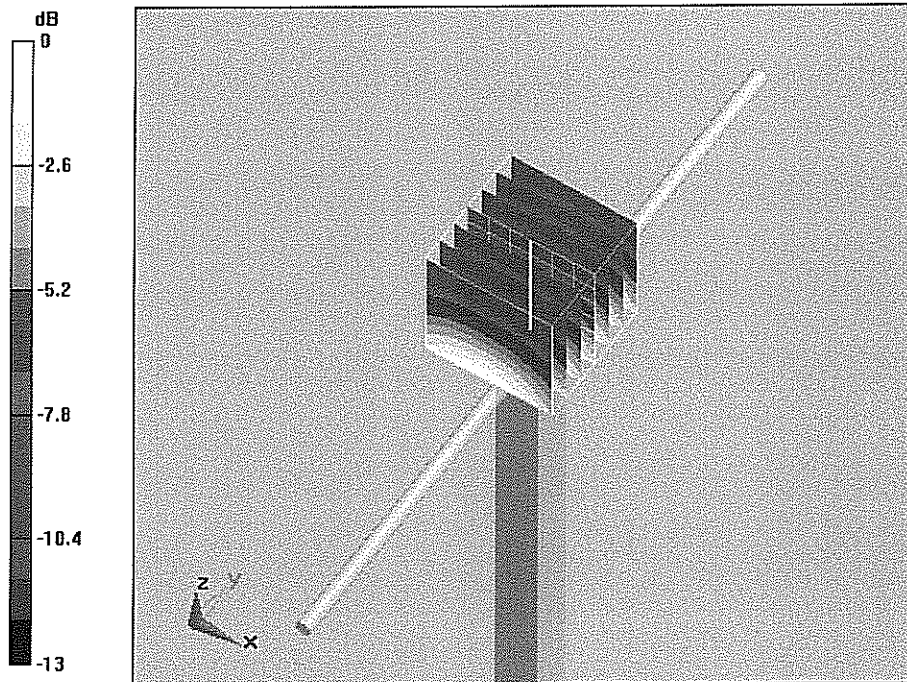

0 dB = 2.79mW/g

# Impedance Measurement Plot for Body TSL

16 Sep 2008 09:01:56

CH1 S11 1 U FS 1: 45.273  $\Omega$  -5.0977  $\Omega$  37.391 pF 835.000 000 MHz

\*  
De1  
Cor  
Avg  
16  
↑

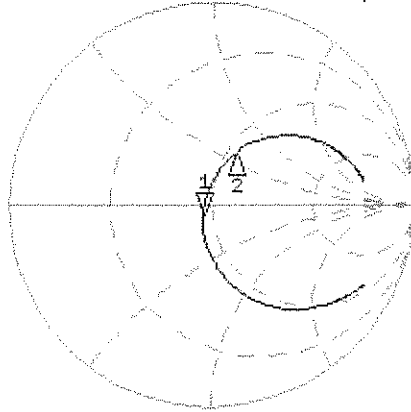

CH1 Markers  
2: 54.469  $\Omega$   
29.291  $\Omega$   
900.000 MHz

CH2 S11 LOG 5 dB/REF -20 dB 1: -22.753 dB 835.000 000 MHz

Cor  
Avg  
16  
↑

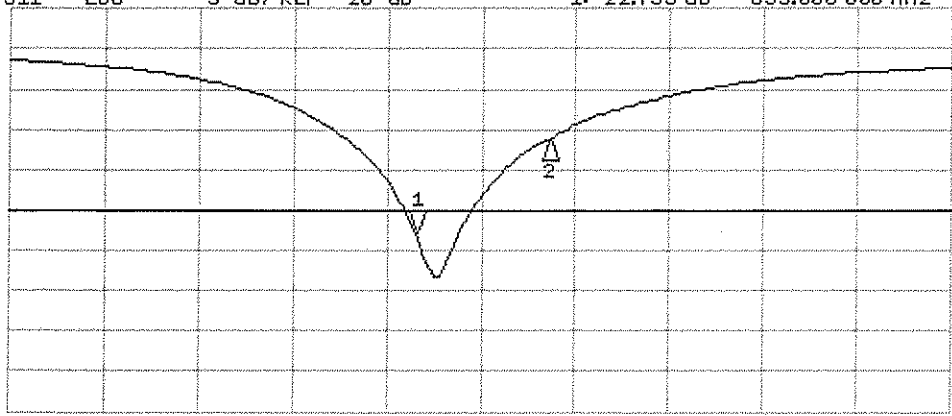

CH2 Markers  
2: -11.275 dB  
900.000 MHz



Accredited by the Swiss Accreditation Service (SAS)  
The Swiss Accreditation Service is one of the signatories to the EA  
Multilateral Agreement for the recognition of calibration certificates

Accreditation No.: **SCS 108**

Client **Kyocera USA**

Certificate No: **D1800V2-220\_Nov07**

**CALIBRATION CERTIFICATE**

Object: **D1800V2 - SN: 220**

Calibration procedure(s): **QA CAL-05.v7  
Calibration procedure for dipole validation kits**

Calibration date: **November 13, 2007**

Condition of the calibrated item: **In Tolerance**

This calibration certificate documents the traceability to national standards, which realize the physical units of measurements (SI).  
The measurements and the uncertainties with confidence probability are given on the following pages and are part of the certificate.

All calibrations have been conducted in the closed laboratory facility: environment temperature (22 ± 3)°C and humidity < 70%.

Calibration Equipment used (M&TE critical for calibration)

Primary Standards	ID #	Cal Date (Calibrated by, Certificate No.)	Scheduled Calibration
Power meter EPM-442A	GB37480704	04-Oct-07 (METAS, No. 217-00736)	Oct-08
Power sensor HP 8481A	US37292783	04-Oct-07 (METAS, No. 217-00736)	Oct-08
Reference 20 dB Attenuator	SN: 5086 (20g)	07-Aug-07 (METAS, No 217-00718)	Aug-08
Reference 10 dB Attenuator	SN: 5047.2 (10r)	07-Aug-07 (METAS, No 217-00718)	Aug-08
Reference Probe ET3DV6 (HF)	SN: 1507	26-Oct-07 (SPEAG, No. ET3-1507_Oct07)	Oct-08
DAE4	SN 601	30-Jan-07 (SPEAG, No. DAE4-601_Jan07)	Jan-08

Secondary Standards	ID #	Check Date (in house)	Scheduled Check
Power sensor HP 8481A	MY41092317	18-Oct-02 (SPEAG, in house check Oct-07)	In house check: Oct-08
RF generator R&S SMT-06	100005	4-Aug-99 (SPEAG, in house check Oct-07)	In house check: Oct-09
Network Analyzer HP 8753E	US37390585 S4206	18-Oct-01 (SPEAG, in house check Oct-07)	In house check: Oct-08

Calibrated by: **Claudio Leubler** (Name), **Laboratory Technician** (Function), *[Signature]* (Signature)

Approved by: **Katja Pokovic** (Name), **Technical Manager** (Function), *[Signature]* (Signature)

Issued: November 15, 2007

This calibration certificate shall not be reproduced except in full without written approval of the laboratory.



Accredited by the Swiss Accreditation Service (SAS)  
The Swiss Accreditation Service is one of the signatories to the EA  
Multilateral Agreement for the recognition of calibration certificates

Accreditation No.: **SCS 108**

### Glossary:

TSL	tissue simulating liquid
ConvF	sensitivity in TSL / NORM x,y,z
N/A	not applicable or not measured

### Calibration is Performed According to the Following Standards:

- IEEE Std 1528-2003, "IEEE Recommended Practice for Determining the Peak Spatial-Averaged Specific Absorption Rate (SAR) in the Human Head from Wireless Communications Devices: Measurement Techniques", December 2003
- IEC 62209-1, "Procedure to measure the Specific Absorption Rate (SAR) for hand-held devices used in close proximity to the ear (frequency range of 300 MHz to 3 GHz)", February 2005
- Federal Communications Commission Office of Engineering & Technology (FCC OET), "Evaluating Compliance with FCC Guidelines for Human Exposure to Radiofrequency Electromagnetic Fields; Additional Information for Evaluating Compliance of Mobile and Portable Devices with FCC Limits for Human Exposure to Radiofrequency Emissions", Supplement C (Edition 01-01) to Bulletin 65

### Additional Documentation:

- DASY4 System Handbook

### Methods Applied and Interpretation of Parameters:

- Measurement Conditions:** Further details are available from the Validation Report at the end of the certificate. All figures stated in the certificate are valid at the frequency indicated.
- Antenna Parameters with TSL:** The dipole is mounted with the spacer to position its feed point exactly below the center marking of the flat phantom section, with the arms oriented parallel to the body axis.
- Feed Point Impedance and Return Loss:** These parameters are measured with the dipole positioned under the liquid filled phantom. The impedance stated is transformed from the measurement at the SMA connector to the feed point. The Return Loss ensures low reflected power. No uncertainty required.
- Electrical Delay:** One-way delay between the SMA connector and the antenna feed point. No uncertainty required.
- SAR measured:** SAR measured at the stated antenna input power.
- SAR normalized:** SAR as measured, normalized to an input power of 1 W at the antenna connector.
- SAR for nominal TSL parameters:** The measured TSL parameters are used to calculate the nominal SAR result.

## Measurement Conditions

DASY system configuration, as far as not given on page 1.

<b>DASY Version</b>	DASY4	V4.7
<b>Extrapolation</b>	Advanced Extrapolation	
<b>Phantom</b>	Modular Flat Phantom V5.0	
<b>Distance Dipole Center - TSL</b>	10 mm	with Spacer
<b>Zoom Scan Resolution</b>	dx, dy, dz = 5 mm	
<b>Frequency</b>	1800 MHz ± 1 MHz	

## Head TSL parameters

The following parameters and calculations were applied.

	Temperature	Permittivity	Conductivity
<b>Nominal Head TSL parameters</b>	22.0 °C	40.0	1.40 mho/m
<b>Measured Head TSL parameters</b>	(22.0 ± 0.2) °C	38.8 ± 6 %	1.39 mho/m ± 6 %
<b>Head TSL temperature during test</b>	(22.2 ± 0.2) °C	---	---

## SAR result with Head TSL

<b>SAR averaged over 1 cm<sup>3</sup> (1 g) of Head TSL</b>	condition	
SAR measured	250 mW input power	9.57 mW /g
SAR normalized	normalized to 1W	38.3 mW /g
SAR for nominal Head TSL parameters <sup>1</sup>	normalized to 1W	<b>37.8 mW / g ± 17.0 % (k=2)</b>

<b>SAR averaged over 10 cm<sup>3</sup> (10 g) of Head TSL</b>	condition	
SAR measured	250 mW input power	5.07 mW /g
SAR normalized	normalized to 1W	20.3 mW /g
SAR for nominal Head TSL parameters <sup>1</sup>	normalized to 1W	<b>20.1 mW / g ± 16.5 % (k=2)</b>

<sup>1</sup> Correction to nominal TSL parameters according to d), chapter "SAR Sensitivities"

## Body TSL parameters

The following parameters and calculations were applied.

	Temperature	Permittivity	Conductivity
Nominal Body TSL parameters	22.0 °C	53.3	1.52 mho/m
Measured Body TSL parameters	(22.0 ± 0.2) °C	53.6 ± 6 %	1.47 mho/m ± 6 %
Body TSL temperature during test	(21.5 ± 0.2) °C	---	---

## SAR result with Body TSL

SAR averaged over 1 cm <sup>3</sup> (1 g) of Body TSL	condition	
SAR measured	250 mW input power	9.50 mW /g
SAR normalized	normalized to 1W	38.0 mW /g
SAR for nominal Body TSL parameters <sup>2</sup>	normalized to 1W	<b>38.8 mW / g ± 17.0 % (k=2)</b>

SAR averaged over 10 cm <sup>3</sup> (10 g) of Body TSL	condition	
SAR measured	250 mW input power	5.12 mW /g
SAR normalized	normalized to 1W	20.5 mW /g
SAR for nominal Body TSL parameters <sup>2</sup>	normalized to 1W	<b>20.7 mW / g ± 16.5 % (k=2)</b>

<sup>2</sup> Correction to nominal TSL parameters according to d), chapter "SAR Sensitivities"

## Appendix

### Antenna Parameters with Head TSL

Impedance, transformed to feed point	46.7 j $\Omega$ - 3.1 j $\Omega$
Return Loss	- 26.6 dB

### Antenna Parameters with Body TSL

Impedance, transformed to feed point	42.4 j $\Omega$ - 4.0 j $\Omega$
Return Loss	- 20.7 dB

### General Antenna Parameters and Design

Electrical Delay (one direction)	1.181 ns
----------------------------------	----------

After long term use with 100W radiated power, only a slight warming of the dipole near the feedpoint can be measured.

The dipole is made of standard semirigid coaxial cable. The center conductor of the feeding line is directly connected to the second arm of the dipole. The antenna is therefore short-circuited for DC-signals.

No excessive force must be applied to the dipole arms, because they might bend or the soldered connections near the feedpoint may be damaged.

### Additional EUT Data

Manufactured by	SPEAG
Manufactured on	December 01, 1997



# DASY4 Validation Report for Head TSL

Date/Time: 05.11.2007 12:01:10

Test Laboratory: SPEAG, Zurich, Switzerland

**DUT: Dipole 1800 MHz; Type: D1800V2; Serial: SN:220**

Communication System: CW; Frequency: 1800 MHz; Duty Cycle: 1:1

Medium: HSL U10 BB;

Medium parameters used:  $f = 1800$  MHz;  $\sigma = 1.39$  mho/m;  $\epsilon_r = 38.7$ ;  $\rho = 1000$  kg/m<sup>3</sup>

Phantom section: Flat Section

Measurement Standard: DASY4 (High Precision Assessment)

## DASY4 Configuration:

- Probe: ET3DV6 - SN1507 (HF); ConvF(4.99, 4.99, 4.99); Calibrated: 26.10.2007
- Sensor-Surface: 4mm (Mechanical Surface Detection)
- Electronics: DAE4 Sn601; Calibrated: 30.01.2007
- Phantom: Flat Phantom 5.0 (front); Type: QD000P50AA; ;
- Measurement SW: DASY4, V4.7 Build 55; Postprocessing SW: SEMCAD, V1.8 Build 172

## Pin = 250 mW; d = 10 mm/Zoom Scan (7x7x7)/Cube 0:

Measurement grid: dx=5mm, dy=5mm, dz=5mm

Reference Value = 93.2 V/m; Power Drift = 0.029 dB

Peak SAR (extrapolated) = 16.6 W/kg

**SAR(1 g) = 9.57 mW/g; SAR(10 g) = 5.07 mW/g**

Maximum value of SAR (measured) = 10.7 mW/g

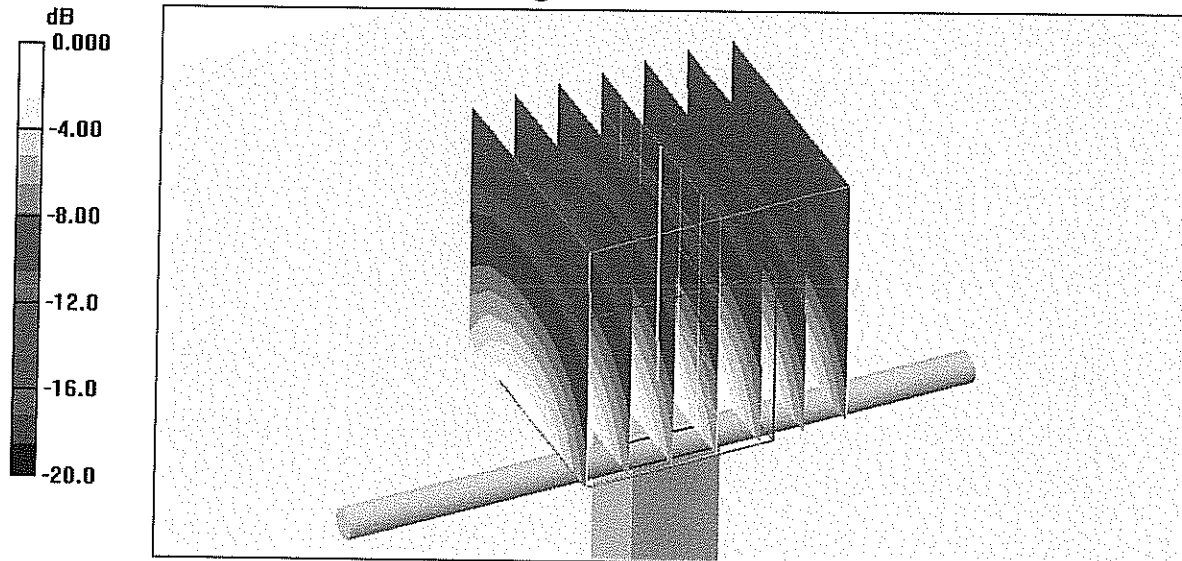

0 dB = 10.7mW/g

# Impedance Measurement Plot for Head TSL

5 Nov 2007 11:44:57

CH1 S11 1 U FS 1: 46.709  $\Omega$  -3.0684  $\Omega$  28.817 pF 1.800.000 000 MHz

\*  
Del

CΔ

Avg  
16

↑

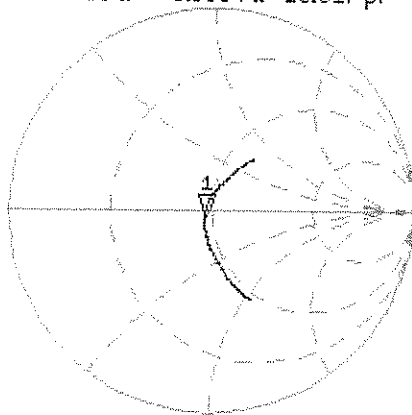

CH2 S11 LOG 5 dB/REF -20 dB 1:-26.649 dB 1.800.000 000 MHz

CΔ

Avg  
16

↑

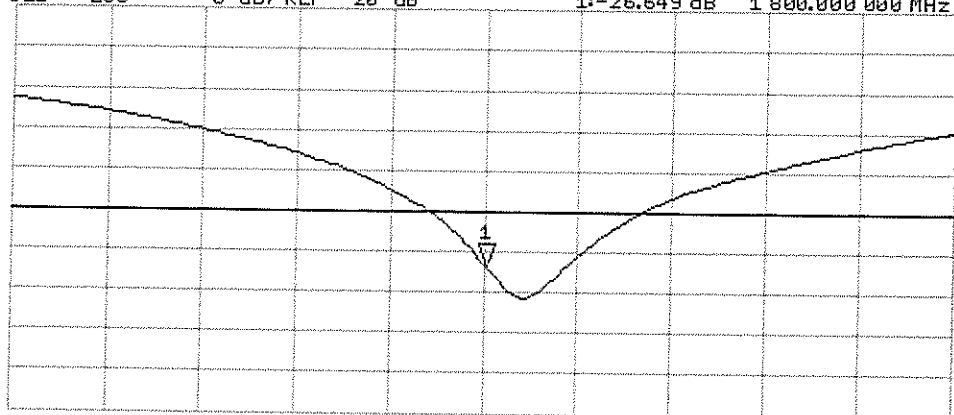

CENTER 1.800.000 000 MHz

SPAN 400.000 000 MHz

Test Laboratory: SPEAG, Zurich, Switzerland

**DUT: Dipole 1800 MHz; Type: D1800V2; Serial: D1800V2 - SN:220**

Communication System: CW; Frequency: 1800 MHz; Duty Cycle: 1:1

Medium: MSL U10 BB;

Medium parameters used:  $f = 1800$  MHz;  $\sigma = 1.47$  mho/m;  $\epsilon_r = 53.6$ ;  $\rho = 1000$  kg/m<sup>3</sup>

Phantom section: Flat Section

Measurement Standard: DASY4 (High Precision Assessment)

### DASY4 Configuration:

- Probe: ET3DV6 - SN1507 (HF); ConvF(4.56, 4.56, 4.56); Calibrated: 26.10.2007
- Sensor-Surface: 4mm (Mechanical Surface Detection)
- Electronics: DAE4 Sn601; Calibrated: 30.01.2007
- Phantom: Flat Phantom 5.0 (back); Type: QD000P50AA; ;
- Measurement SW: DASY4, V4.7 Build 55; Postprocessing SW: SEMCAD, V1.8 Build 172

**Pin = 250 mW; d = 10 mm/Zoom Scan (7x7x7)/Cube 0:**

Measurement grid: dx=5mm, dy=5mm, dz=5mm

Reference Value = 91.8 V/m; Power Drift = -0.026 dB

Peak SAR (extrapolated) = 16.1 W/kg

**SAR(1 g) = 9.5 mW/g; SAR(10 g) = 5.12 mW/g**

Maximum value of SAR (measured) = 10.8 mW/g

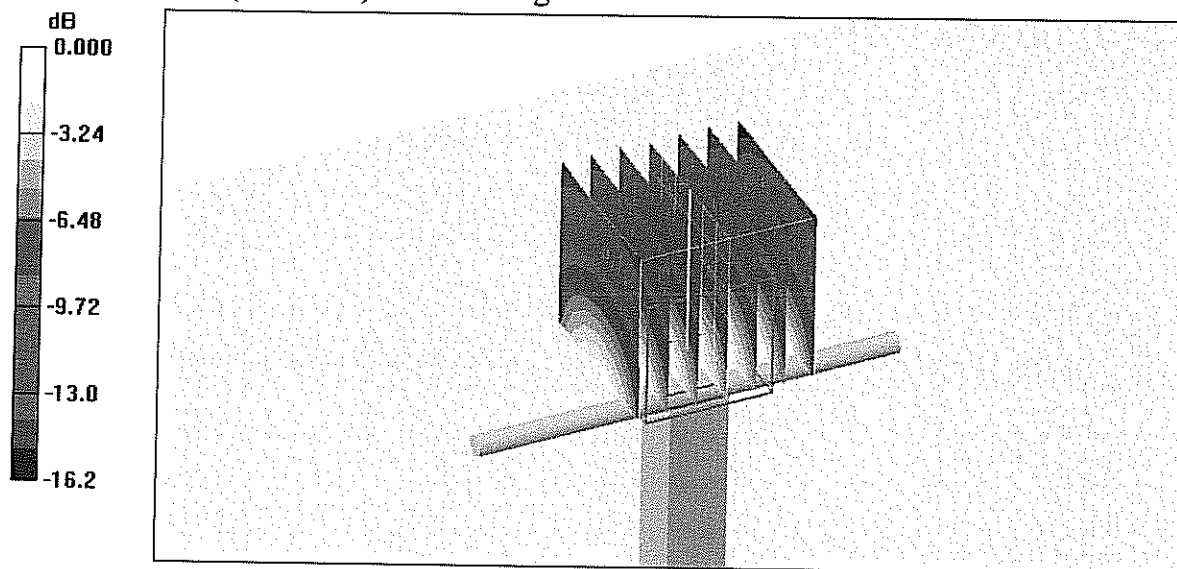

0 dB = 10.8mW/g

# Impedance Measurement Plot for Body TSL

13 Nov 2007 10:21:32

CH1 S11 1 U FS 1: 42.412  $\Omega$  -3.9707  $\Omega$  22.268 pF 1 800.000 000 MHz

\*  
Del  
Cor  
Avg  
15  
↑

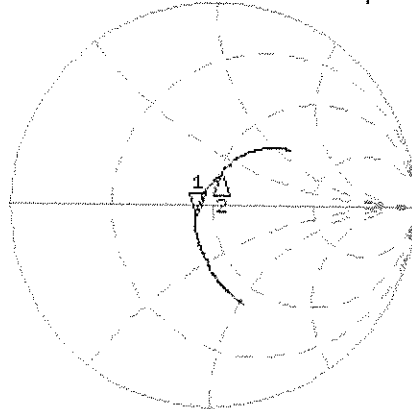

CH1 Markers  
2: 51.301  $\Omega$   
14.910  $\Omega$   
1.90000 GHz

CH2 S11 LOG 5 dB/REF -20 dB 1: -20.670 dB 1 800.000 000 MHz

Cor  
Avg  
15  
↑

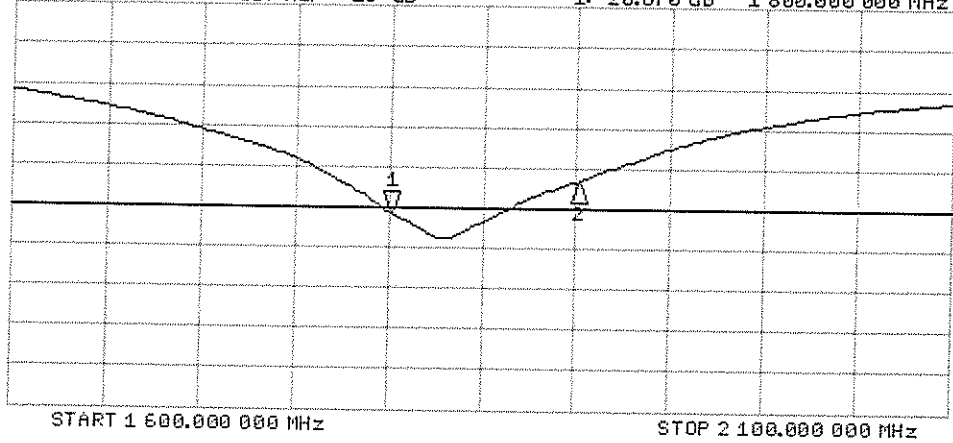

CH2 Markers  
2: -16.702 dB  
1.90000 GHz