

Hearing Aid Compatibility T-Coil

FCC 47 CFR section 20.19 Test Report

Single Band CDMA Cellular Phone
FCC ID: OVF-K33BIC04
Model: K33BIC-04

<p>STATEMENT OF CERTIFICATION</p> <p><i>The data, data evaluation and equipment configuration represented herein are a true and accurate representation of the measurements of the sample's HAC T-Coil characteristics as of the dates and at the times of the test under the conditions herein specified.</i></p> <p>STATEMENT OF COMPLIANCE</p> <p><i>This product was tested in accordance with the measurement procedures specified in ANSI C63.19-2007 and has been shown to be capable of compliance with the technical requirements of FCC 47 CFR section 20.19.</i></p>			
Test Location:	Kyocera Communications, Inc. 10300 Campus Point Drive, San Diego CA 92121 USA		
Test performed by:	Thuy To Regulatory Engineer, Senior	Date of Test:	06/14/10
Report Prepared by:	Thuy To Regulatory Engineer, Senior	Date of Report:	06/14/10
Report Reviewed by:	C. K. Li Director of Regulatory Engineering	Date of Review:	06/14/10

TABLE OF CONTENTS

1	Introduction.....	3
2	Equipment Under Test (EUT).....	3
3	Summary of Test Results.....	4
4	Test conditions.....	5
4.1	Environmental Conditions.....	5
4.2	RF characteristics of the test site.....	5
4.3	Ambient Noise of the test site.....	5
4.4	Test Signal, Frequencies and Output Power.....	5
4.4.1	CDMA2000 Test conditions.....	5
4.5	EUT Operating Conditions.....	6
5	Description of the test equipment.....	6
5.1	Test Equipment Used.....	6
5.2	HAC T-Coil Measurement System.....	7
5.3	Audio Magnetic Probe.....	8
5.4	Audio Magnetic Measuring Instrument (AMMI).....	8
5.5	Audio Magnetic Calibration Coil (AMCC).....	8
6	System Validation & Calibration.....	9
6.1	Input Channel Calibration.....	9
6.2	Probe Calibration.....	9
6.3	Reference Input Level.....	10
6.3.1	CMU200 Audio Codec Calibration.....	10
6.3.2	AMMI Signal Verification.....	10
7	Test Procedure.....	11
7.1	Test Positions.....	12
7.2	Audio Signals.....	12
7.3	Scan Procedures.....	13
7.3.1	Signal Strength and SNR.....	13
7.3.2	Frequency Response.....	13
8	Measurement Uncertainty.....	14
9	T-Coil Requirements and Category.....	15
9.1	RF Emissions.....	15
9.2	Axial Field Intensity.....	15
9.3	Signal Quality.....	15
9.4	Frequency Response.....	16
10	T-Coil Test Results.....	17
10.1	Field Strength and Signal Quality.....	17
10.2	Frequency Response.....	18
11	Appendix A1: Probe Calibration Certification.....	19
12	Appendix A2: AMCC Calibration Certification.....	20
13	Appendix B1: Ambient Noise Plots, 1900 MHz.....	21
14	Appendix C: System Calibration Results.....	22
15	Appendix D: ABM and SNR Test Results/Plots.....	22
16	Appendix E: Photo Test Setup.....	22

1 Introduction

This test report describes the Hearing Aid Compatibility (HAC) measurement of a wireless portable device manufactured by Kyocera Wireless Corp. (KWC). These measurements were performed for compliance with the rules and regulations of the U.S. Federal Communications Commission (FCC). The testing was performed in accordance with ANSI C63.19-2007.

This report covers test and data on:

	RF Emissions	ANSI C63.19 Clause 4
X	T-Coil	ANSI C63.19 Clause 6

2 Equipment Under Test (EUT)

Product:	Single Band CDMA Cellular Phone
FCC ID:	OVF-K33BIC04
Model Number:	K33BIC-04
EUT Serial Number:	F0000037984760
Type:	<input type="checkbox"/> Identical Prototype <input checked="" type="checkbox"/> Pre-Production <input type="checkbox"/> Production
Device Category:	Portable
RF Exposure Environment:	General Population / Uncontrolled
T-Coil Location:	Same as speaker location
Antenna:	Internal Antenna
Detachable Antenna:	No
External Input:	Audio/Digital Data
Quantity:	Quantity production is planned
Modes:	1900 CDMA
Multiple Access Scheme:	CDMA
TX Frequency (MHz):	1850 - 1910
Rated RF Conducted Output Power (dBm):	23.0

3 Summary of Test Results

ANSI C63.19 (2007)				
Section 6 T-coil				
Mode	Test	Test Results	T-Rating	Verdict
CDMA 1900	Min. Axial Field Strength, dB A/m	2.66	4	Pass
	Min. Radial Field Strength, dB A/m	-6.52	4	Pass
	Min. Signal Quality (ABM1/ABM2), dB	43.55	4	Pass
	Frequency Response @ Axial position			Pass
Overall T-Rating :		T4		
M-Rating* :		M4		
HAC Category Rating :		M4, T4		

* M-rating obtained from HAC RF report.

4 Test conditions

4.1 Environmental Conditions

All tests were performed under the following environmental conditions:

Ambient Temperature:	23 ± 2 Degrees C
Relative Humidity (RH):	0% <RH < 80%
Atmospheric Pressure:	101.3kPa + 10 to -5 kPa

4.2 RF characteristics of the test site

All HAC measurements were performed inside a shielded room that provide isolation from external EM fields, with the RF ambient at least 20 dB below the intended measurement limits.

4.3 Ambient Noise of the test site

The test site's ambient magnetic level were determined and found to be at least 10dB below the measurement data ABM2, unless a very low level of ABM2. Measurement of the ambient level was performed for each probe orientation and results are shown in Appendix B.

4.4 Test Signal, Frequencies and Output Power

During tests, the EUT was put in in-call mode and controlled by a CDMA simulator to generate the required signal and power.

4.4.1 CDMA2000 Test conditions

The device supports CDMA2000 in 1X (Phase I, Protocol revision 6) mode only. CDMA2000 1X includes TIA/EIA-95B as a subset and was approved for publishing in July 1999. It provides voice and data capabilities within a standard 1.25 MHz CDMA channel. This RF bandwidth is identical to the legacy IS-95 B system standard.

Maximum average conducted powers were measured to ensure worst case power configuration was tested.

CONFIGURATION (Full Rate)		CONDUCTED POWER (dBm)		
		CDMA 1900		
		Ch25	Ch600	Ch1175
SO2	RC1	23.05	23.07	23.25
	RC3	23.10	23.18	23.24
SO3	RC1	23.02	23.01	23.08
	RC3	23.12	23.26	23.30
SO17	RC2	23.09	23.15	23.06
	RC54	23.12	23.11	23.16
SO55	RC1	23.08	23.12	23.26
	RC3	23.10	23.25	23.27
TDSO SO32	RC3 (+F-SCH)	23.00	23.17	23.09
	RC3 (+SCH)	23.08	23.24	23.14

Table 4.4.1 Conducted RF output power measured vs RC's

The following configuration was chosen:

Protocol:	6 (IS-2000)
Radio Configuration:	3
Power Control:	All Up Bits
Service Option:	3
Vocoder:	8K Enhanced (low)
Data Rate:	Full

The measurement system measures power drift during HAC testing by comparing field strength in the same location at the beginning and at the end of measurement. These records were used to monitor stability of power output during tests. Conducted RF power measurements were also performed before and after each HAC measurements to confirm the output power.

4.5 EUT Operating Conditions

The EUT was tested with the follow configurations and conditions, if applicable:

<input checked="" type="checkbox"/>	Fully charged standard battery as supplied with the handset
<input type="checkbox"/>	Open and Closed configurations, at ear use position
<input type="checkbox"/>	Both retracted and extended antenna positions
<input checked="" type="checkbox"/>	LCD Contrast High
<input type="checkbox"/>	Simultaneous transmission with Bluetooth transmitter ON ²
<input checked="" type="checkbox"/>	Volume setting at maximum
<input checked="" type="checkbox"/>	Microphone muted

Note

1: This phone has only one configuration for ear usage

2: This phone does not support Bluetooth

5 Description of the test equipment

5.1 Test Equipment Used

Below is a list of the calibrated equipment used for the measurements:

Description	Manufacturer	Model Number	Serial Number	Cal Due Date
Power Meter	Giga-tronics	8541C	1831306	07/16/10
Radio Communication Tester	Rohde & Schwarz	CMU200	101328	03/29/11
Data Acquisition	Speag	DAE4	602	06/17/10
Audio Band Magnetic Probe	Speag	AM1DV2	1045	09/22/10
Audio Band Magnetic Measuring Instrument	Speag	AMMI	1035	N/A
Helmholtz Coil	Speag	AMCC	1001	N/A
Test Arch	Speag	HAC	1015	N/A

The calibration certificates of Probe and Helmholtz Coil are attached in Appendix A.

5.2 HAC T-Coil Measurement System

The measurements were performed with Dasy4 automated near-field scanning system comprised of high precision robot, robot controller, computer, Magnetic probe, probe alignment sensor, non-conductive phone positioner, Test Arch and software extension. Figure 5.2 shows the setup and cabling. The overall expanded uncertainty (K=2) of the measurement system is $\pm 12.3\%$. The measurement uncertainty budget is given in section 8.



Figure 5.2a T-Coil setup with Helmholtz Coil

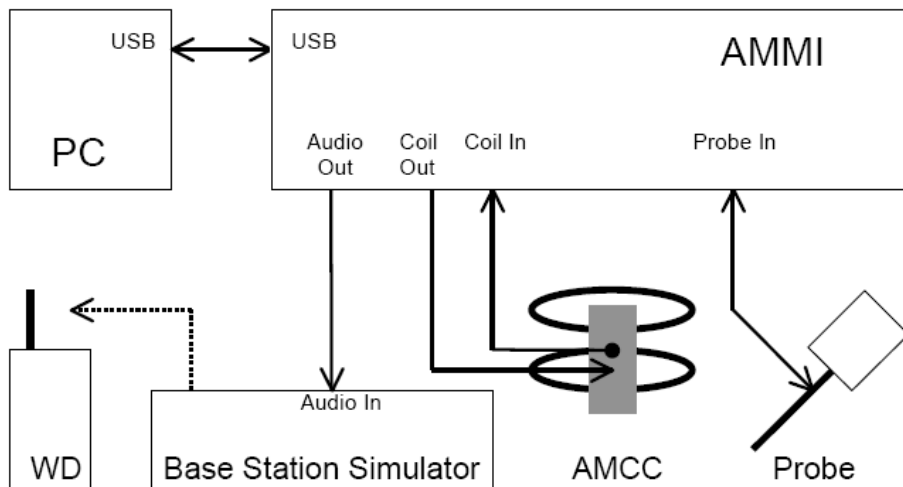

Figure 5.2b Setup Cabling

5.3 Audio Magnetic Probe

Model:	▪ AM1D
Application:	▪ Active single sensor probe for both axial and radial measurement scans
Construction:	<ul style="list-style-type: none"> ▪ Fully RF shielded ▪ Rounded tip of 6 mm diameter incorporating a pickup coil with its center offset 3mm from the tip and the sides ▪ Compatible with DAE, with adapted probe cup
Frequency Response:	▪ ± 0.5 dB of ideal differentiator from 100 Hz to 10 kHz
Linearity:	▪ < 0.1 dB from 5 dB below limitation to 16 dB above noise level
Dynamic Range:	▪ Max 21 dB A/m @ 1 kHz, Noise level typ. -70 dB A/m @ 1kHz, ABM2 typ. -60 dB A/m
Sensitivity:	▪ Typ. -24 dBV / A./m @ 1kHz at probe output
RF Shielding:	▪ Immunity to AM (1 kHz, 80%) modulation RF signal

5.4 Audio Magnetic Measuring Instrument (AMMI)

Model:	▪ AMMI
Application:	AMMI is a desktop 19-inch unit containing a sampling unit, a waveform generator for test and calibration signals and a USB interface.
Connection:	<p>Front connectors</p> <ul style="list-style-type: none"> ▪ Audio Out - audio signal to the base station simulator ▪ Coil Out - test and calibration signal to the AMCC ▪ Coil In - monitor signal from the AMCC BNO connector ▪ Probe In - probe signal

5.5 Audio Magnetic Calibration Coil (AMCC)

Model:	▪ AMCC
Application:	The Audio Magnetic Calibration coil is a Helmholtz Coil designed according to ANSI C63.19-2006 section D.9, for calibration of the AM1D probe. The two horizontal coils generate a homogeneous magnetic field in the z direction. The DC input resistance is adjusted to approximately 50 Ohm by a series resistor, and a shunt resistor of 10 Ohm allows monitoring the current with a scale of 1:10.
Connection:	<ul style="list-style-type: none"> ▪ Coil In ▪ Coil Monitor

6 System Validation & Calibration

At the beginning of the HAC T-coil measurement, a 3-phase calibration was performed per Speag instruction to ensure accurate measurement of the voltages and ABM field. Reference input level was also validated and calibrated per C63.19.

6.1 Input Channel Calibration

Phase 1: The AMMI audio output was switched off, and a 200 mV_{pp} symmetric rectangular signal of 1 kHz was generated and internally connected directly to both channels of the sampling unit (coil in, probe in).

Phase 2: The AMMI audio output was off, and a 20 mV_{pp} symmetric 100 Hz signal was internally connected.

The signals during phases 1 and 2 were available at the output on the rear panel of the AMMI. The output must however not be loaded in order not to influence the calibration. After the first two phases, the two input channels were both calibrated for absolute measurements of voltages. The resulting factors were displayed above the multimeter window.

After phases 1 and 2, the input channels were calibrated to measure exact voltages.

6.2 Probe Calibration

Phase 3: a multisine signal covering each third-octave band from 50 Hz to 5 kHz was generated and applied to both audio outputs. The probe was positioned in the center of the AMCC (user point “coil center”) and aligned in the z-direction, the field orientation of the AMCC. The Coil In channel was measuring the voltage over the AMCC internal shunt, which was proportional to the magnetic field in the AMCC. At the same time, the probe in channel samples the amplified signal picked up by the probe coil. The ratio of the two voltages – in each third-octave filter – leads to the calibration factor of the probe over the frequency band of interest for the spectral representation.

The calibration result is shown in Appendix C. The internal calibration factors of the coil and probe channel are listed. The graphics represent the values (applying the calibration factors from the previous steps) for the probe and coil channel in dB V for each third-octave filter from 100 Hz to 5 kHz. The single values are interconnected with a blue line for the probe and a green line for the coil channel.

The probe sensitivity in V / (A/m) at 1 kHz is calculated from the values in the chart. -20 dBV in the coil channel corresponds approx. to 1 A/m.

Calibration Factors	Measured Value
Probe Sensitivity, V/(A/m)	0.0658
Probe calibration factor, V	1.1328
Coil calibration factor, V	2.3277

6.3 Reference Input Level

ANSI C63.19 requires the use of reference input level of -18dBm0 that correlate to a normal speech input level for CDMA air interface. In order to create the correct level the CMU200 audio codec and the AMMI output were calibrated.

6.3.1 CMU200 Audio Codec Calibration

To determine the correct input level, the Encoder/Decoder of the CMU200 base station simulator was calibrated for measured full-scale input voltage level. The CMU200 0dBm0 input reference was determined utilizing the build-in functions of “Decoder Cal” and “Encoder Cal”.

CMU200 S/N	Modulation	Ref. I/P Level	Target Level
101328	CDMA	-18dBm0	-20.35

6.3.2 AMMI Signal Verification

Verification of AMMI output level was performed before the compliance measurement. The measured results are showed in Table 6.3b

Date	Signal	Measured AMMI Output (dBm0)	Target Reference Input (dBm0)	Delta (dB)
6/10/2010	1KHz	-20.5	-20.35	-0.15
	300-3000 Hz	-20.49	-20.35	-0.14

Table 6.3b Measured Output Level

7 Test Procedure

The device was positioned and setup according to ANSI C63.19-2007. Figure 7.0 shows the T-Coil Signal measurement flowchart:

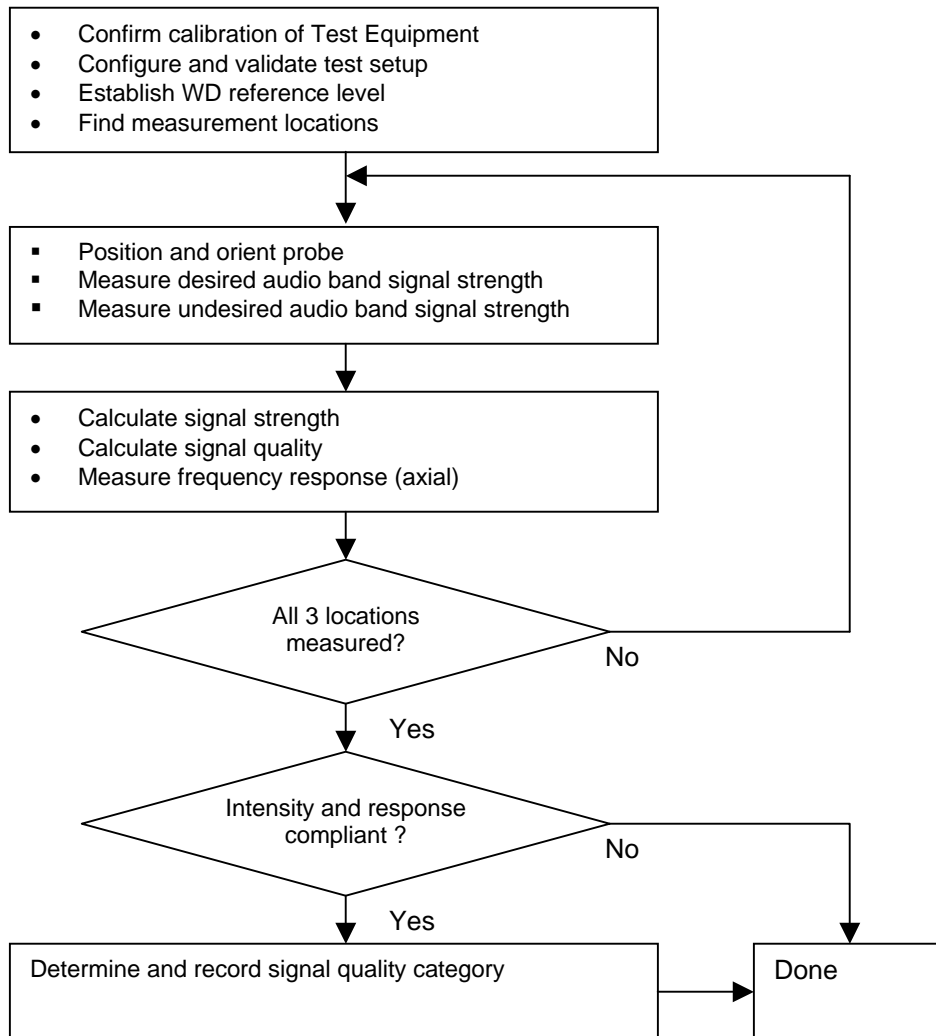

Figure 7.0 T-Coil measurement flowchart

7.1 Test Positions

The device was placed on a non-conductive phone positioner under the Test Arch. The acoustic output of the EUT was aligned with the center point of the area formed by the dielectric wire and the middle bar of the arch's top frame. Please refer to Appendix E for the test setup photos.

7.2 Audio Signals

During tests signal was fed to the EUT via communication Test set. Proper gain setting was used in software to ensure correct signal level fed to communication test set speech input.

The following audio signals were pre-defined by DAS4 and used for calibration and measurements:

48k_voice_1kHz_1 s (duration 1 s): This signal is voice like and has been processed to have a narrow bandwidth mainly within the 1 kHz third-octave band and an even shorter duration of 1 second for faster measurement. This signal passes through a large variety of codecs and permits a direct amplitude and signal quality measurement (S/N) without considerable bandwidth compensation. Its spectrum is shown in a practical measurement in Figure 7.2a.

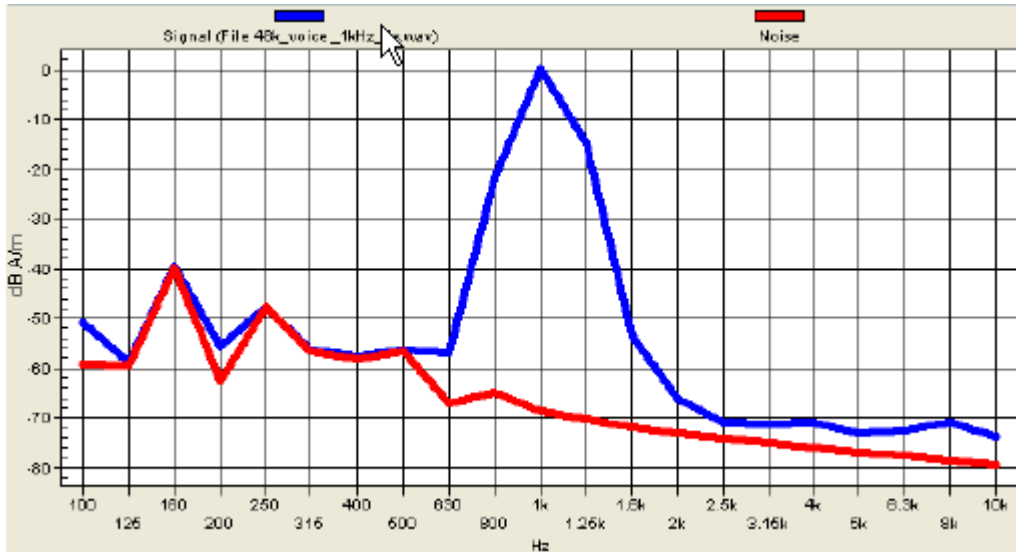

Figure 7.2a 49k_voice_1kHz_1s signal spectrum

Multisine signal 50 Hz – 5 kHz (duration 10 s): Signal with carrier centered in each third-octave band, as used during the calibration. Suited for frequency response measurements. Peak to RMS ratio: 11.1 dB.

48k_voice_300-3000 (duration 2 s): The signal is voice like and has been processed to have a duration of 2 seconds for fast measurement. At the same time, it has a flat spectrum across all third-octave band filters between 300 Hz to 3 kHz and is vanishing at the beginning and end in order to allow longer measurement sequences without transients. It has bandwidth sufficient for frequency response measurements. The spectrum is shown in a practical measurement in fig. 7.2b. The measurement window length of this signal must be set to a multiple of 2 s in order to integrate over the full voice sample. Peak to RMS ratio: 21.6 dB.

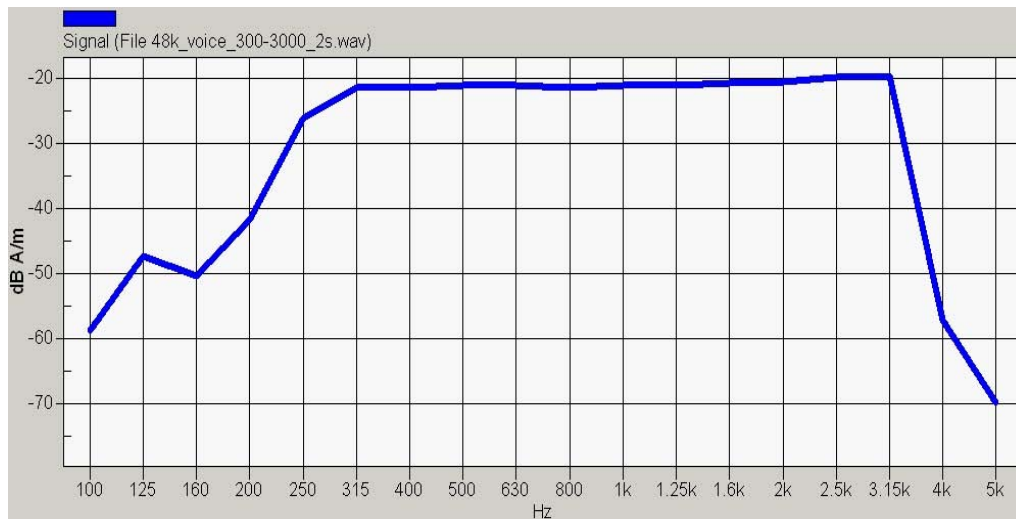
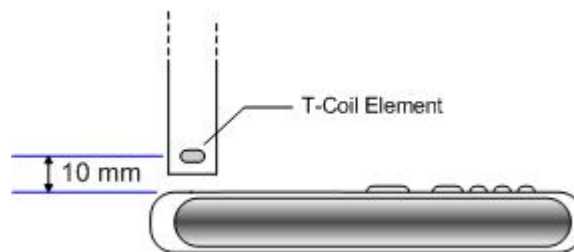

Figure 7.2b Boardband signal spectrum

7.3 Scan Procedures

7.3.1 Signal Strength and SNR

- a) A 50mm x 50mm (10mm step) coarse axial scan was performed to search for the “optimal points” and spatial distribution of ABM1.
- b) Base on the coarse scan results, a 16mm x 16mm (4mm step) fine scan in axial, a 24mmx16mm (4mm step) fine scan in radial_L, and a 16mmx24mm (4mm step) fine scan in radial-T coil orientation were performed for both ABM1 and ABM2.



7.3.2 Frequency Response

Base on the coarse axial scan results, a point axial scan was performed.

8 Measurement Uncertainty

Table 8.1 shows the uncertainty budget for HAC Audio Band Magnetic Field (AMB) assessment according to ANSI C63.19-2006. The budget is valid for the DASY4 system and represents a worst-case analysis. For specific tests and configurations, the uncertainty could be smaller.

Uncertainty Description	Uncert. Value (± %)	Prob. Dist.	Div.	C _i (ABM1)	C _i (ABM2)	Stand. Uncert (ABM1) (±%)	Stand. Uncert (ABM2) (±%)
PROBE SENSITIVITY							
Reference level	3.0	N	1.0	1	1	3.0	3.0
AMCC geometry	0.4	R	1.7	1	1	0.2	0.2
AMCC current	0.6	R	1.7	1	1	0.4	0.4
Probe positioning during calibration	0.1	R	1.7	1	1	0.1	0.1
Noise contribution	0.7	R	1.7	0.0143	1	0	0.4
Frequency slope	5.9	R	1.7	1	1	0.3	3.5
PROBE SYSTEM							
Repeatability / Drift	1.0	R	1.7	1	1	0.6	0.6
Linearity / Dynamic range	0.6	R	1.7	1	1	0.4	0.4
Acoustic noise	1.0	R	1.7	0.1	1	0.1	0.6
Probe angle	2.3	R	1.7	1	1	1.4	1.4
Spectral processing	0.9	R	1.7	1	1	0.5	0.5
Integration time	0.6	N	1.0	1	5	0.6	3.0
Field distribution	0.2	R	1.7	1	1	0.1	0.1
TEST SIGNAL							
Reference signal spectral response	0.6	R	1.7	0	1	0	0.4
POSITIONING							
Probe positioning	1.9	R	1.7	1	1	1.1	1.1
Phantom thickness	0.9	R	1.7	1	1	0.5	0.5
DUT positioning	1.9	R	1.7	1	1	1.1	1.1
EXTERNAL CONTRIBUTIONS							
RF interference	0	R	1.7	1	1	0	0
Test signal variation	2.0	R	1.7	1	1	1.2	1.2
COMBINED UNCERTAINTY							
Combined Standard Uncertainty (ABM):						4.1	6.1
Extended Standard Uncertainty (k=2) [%]:						8.1	12.3

N: Normal
R: Rectangular

Table 8.1 Worst-Case uncertainty budget for HAC ABM assessment

9 T-Coil Requirements and Category

9.1 RF Emissions

EUT has to fulfill RF emission requirements at the axial measurement location.

9.2 Axial Field Intensity

Table 9.2 shows the minimum limits for ABM1 field intensity:

Component	ABN1 Magnetic Field dB(A/m)	Condition
Axial (z)	≥-18	1 kHz, in 1/3 octave band filter
Radial (x, y)	≥-18	

Table 9.2 ABM1 Intensity Requirements

9.3 Signal Quality

Table 9.3 provides the signal quality requirement for the intended T-Coil signal from a Wireless Device. The worst Signal Quality of the axial and radial components of the magnetic field was used to determine the T-Coil category.

Category	Signal Quality (Signal+Noise to Noise) [dB]
T1	0 to 10
T2	10 to 20
T3	20 to 30
T4	> 30
AWF=0	

Table 9.3 T-coil Signal Quality Categories

9.4 Frequency Response

The frequency response of the axial component must follow the frequency curve specified in ANSI C63.19-2007 section 7.3.2, over the frequency range 300-3000 Hz (Figure 9.4).

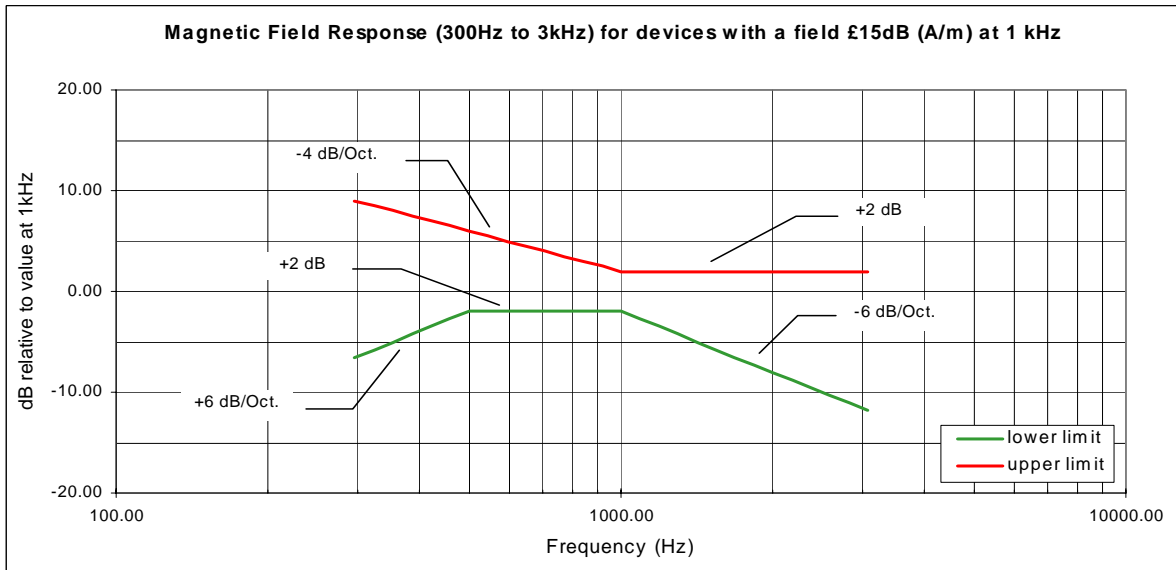

Figure 9.4a Magnetic Field Response (300Hz to 3kHz) for devices with a field ≤ 15 dB (A/m) at 1 kHz

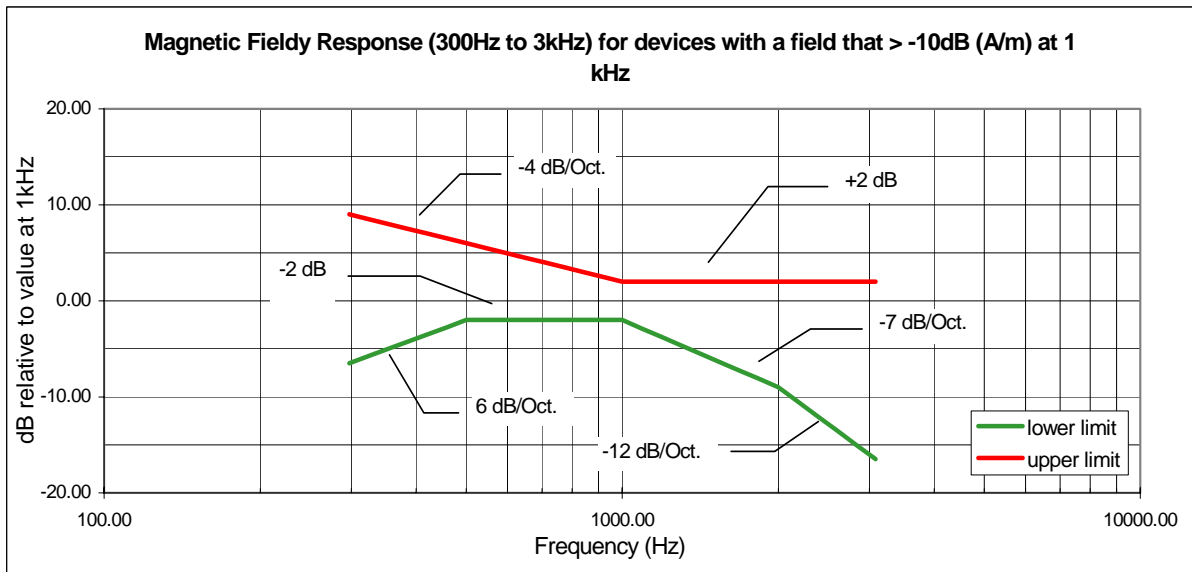

Figure 9.4b Magnetic Field Response (300Hz to 3kHz) for devices with a field that > -15 dB (A/m) at 1 kHz

10 T-Coil Test Results

10.1 Field Strength and Signal Quality

ANSI C63.19 (2007)							
Section 6 T-coil							
Field Strength and Signal Quality							
Mode	Ch	Probe Position	Ambient Noise	ABM1	ABM2	Signal Quality	T-Rating
			(dB A/m)	(dB A/m)	(dB A/m)	(dB)	
CDMA 1900	25	Axial (z)	-55.68	2.66	-48.19	50.85	4
		Radial_L (x)	-58.66	-4.46	-48.01	43.55	4
		Radial_T (y)	-59.01	-5.72	-52.95	47.23	4
	600	Axial (z)	-55.68	4.29	-46.97	51.26	4
		Radial_L (x)	-58.66	-1.48	-45.96	44.48	4
		Radial_T (y)	-59.01	-4.97	-52.65	47.68	4
	1175	Axial (z)	-55.68	3.59	-47.63	51.22	4
		Radial_L (x)	-58.66	-3.63	-47.03	43.40	4
		Radial_T (y)	-59.01	-6.52	-54.31	47.79	4

Note:

- Signal Quality = ABM1/ABM2
- Bold Number = worst case in each category
- Data plots are showed in Appendix D

10.2 Frequency Response

ANSI C63.19 (2007)			
Section 6 T-coil			
Frequency Response			
Mode	Probe Position	Signal Type	Result
CDMA-1900	Axial	Voice	Pass

Figure 10.2 show the worst case frequency response of the axial component of the magnetic field.

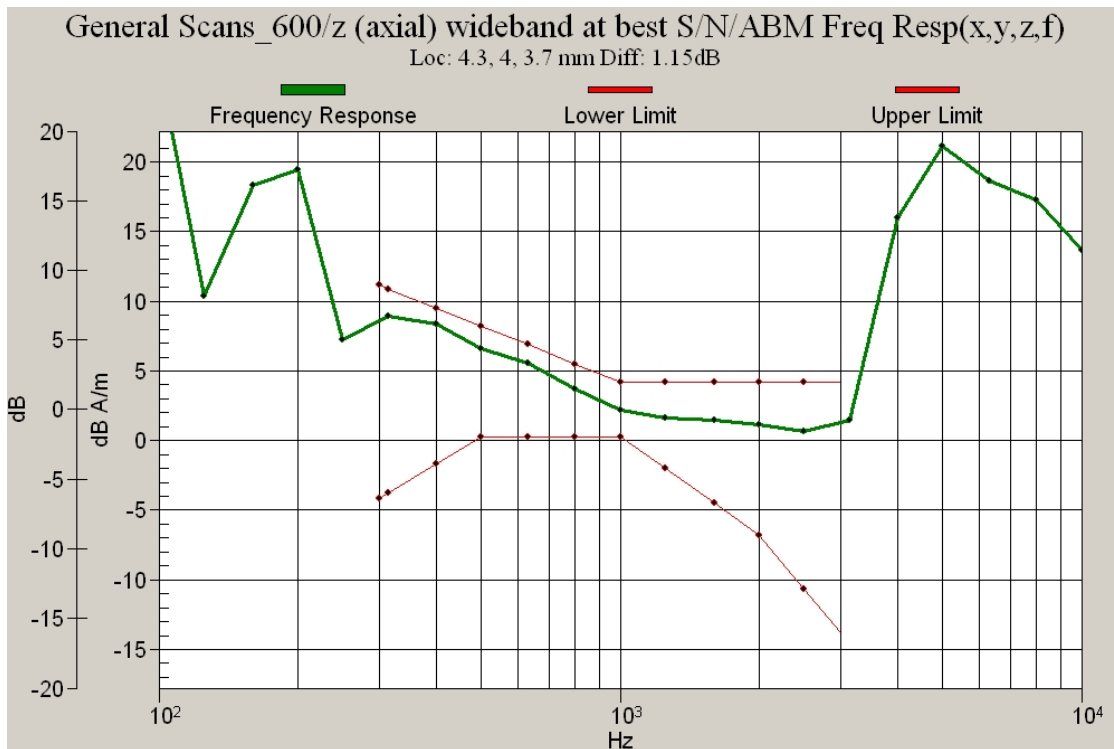

Figure 10.2a CDMA 1900 Channel 600 Frequency Response

11 Appendix A1: Probe Calibration Certification

**Calibration Laboratory of
Schmid & Partner
Engineering AG**
Zeuhausstrasse 43, 8004 Zurich, Switzerland



S Schweizerischer Kalibrierdienst
S Service suisse d'étalonnage
C Servizio svizzero di taratura
S Swiss Calibration Service

Accredited by the Swiss Accreditation Service (SAS)
The Swiss Accreditation Service is one of the signatories to the EA
Multilateral Agreement for the recognition of calibration certificates
Client **Kyocera USA**

Accreditation No.: **SCS 108**

Certificate No.: **AM1DV2-1045_Sep09**

CALIBRATION CERTIFICATE

Object	AM1DV2 - SN: 1045		
Calibration procedure(s)	QA CAL-24.v2 Calibration procedure for AM1D magnetic field probes and TMFS in the audio range		
Calibration date:	September 22, 2009		
Condition of the calibrated item	In Tolerance		
<p>This calibration certificate documents the traceability to national standards, which realize the physical units of measurements (SI). The measurements and the uncertainties with confidence probability are given on the following pages and are part of the certificate.</p> <p>All calibrations have been conducted in the closed laboratory facility: environment temperature (22 ± 3)°C and humidity < 70%.</p> <p>Calibration Equipment used (M&TE critical for calibration)</p>			
Primary Standards	ID #	Cal Date (Certificate No.)	Scheduled Calibration
Keithley Multimeter Type 2001	SN: 0810278	30-Sep-08 (No: 7670)	Sep-09
Reference Probe AM1DV2	SN: 1008	12-Jan-09 (No. AM1D-1008_Jan09)	Jan-10
DAE4	SN: 781	20-Feb-09 (No. DAE4-781_Feb09)	Feb-10
Secondary Standards	ID #	Check Date (in house)	Scheduled Check
AMCC	1050	30-Jul-09 (in house check Jul-09)	Jul-10
Calibrated by:	Name Fin Bornholt	Function R&D Director	Signature <i>F. Bornholt</i>
Approved by:	Name Katja Pokovic	Function Laboratory Director	Signature <i>Katja Pokovic</i>
			Issued: September 24, 2009
This calibration certificate shall not be reproduced except in full without written approval of the laboratory.			

12 Appendix A2: AMCC Calibration Certification

Schmid & Partner Engineering AG



 Zeughausstrasse 43, 8004 Zurich, Switzerland
 Phone +41 1 245 9700, Fax +41 1 245 9779
 info@speag.com, http://www.speag.com

Certificate of conformity

Item	Audio Magnetic Calibration Coil AMCC
Type No	SD HAC P02 A
Series No	1001 ff.
Manufacturer / Origin	Schmid & Partner Engineering AG Zurich, Switzerland

Description of the item

The Audio Magnetic Calibration coil (AMCC) is a Helmholtz Coil designed according to standard [1], section D.9 for calibration of the AM1D probe. Two horizontal coils are positioned above a non-metallic base plate and generate a homogeneous magnetic field in the z direction (normal to it).

Configuration

The AMCC consists of two parallel coils of 20 turns with radius 143 mm connected in parallel in a distance of 143 mm. With this design, a current of 10 mA produces a field of 1 A/m. The DC input resistance at the input BNC socket is adjusted by a series resistor to a DC resistance of approximately 50 Ohm. The voltage required to produce a field of 1 A/m is consequently approx. 500 mV. To current through the coil is monitored via a shunt resistor of 10 Ohm +/- 1%. The voltage is available on a BNO socket with 100 mV corresponding to 1 A/m.

Handling of the item

The coil shall be positioned in a non-metallic environment to avoid distortion of the magnetic field.

Tests

Test	Requirement	Details	Units tested
Number of turns	N = 20 per coil	Resistance measurement	all
Orientation of coils	parallel coils with same direction of windings	Magnetic field variation in the AMCC axis	all
Coil radius	r = 143 mm	mechanical dimension	First article
Coil distance	d = 143 mm distance between coil centers	mechanical dimension	First article
Input resistance	51.7 +/- 2 Ohm	DC resistance at BNC input connector	all
Shunt resistance	R = 10.0 Ohm +/- 1 %	DC resistance at BNO output connector	all
Shunt sensitivity	Hc = 1 A/m per 100 mV according to formula $H_c = (U / R) * N / r / (1.25^{1.5})$	Field measurement compared with Narda ELT400 + BN2300/90.10	First article

Standards

[1] ANSI PC63.19-2006 Draft 3.12

Conformity

Based on the tests above, we certify that this item is in compliance with the requirements of [1].

Date 22.5.2006

Stamp / Signature



Schmid & Partner Engineering AG
 Zeughausstrasse 43, 8004 Zurich, Switzerland
 Phone +41 1 245 9700, Fax +41 1 245 9779
 info@speag.com, http://www.speag.com

13 Appendix B1: Ambient Noise Plots, 1900 MHz

Ambient Noise Spectrum Plot Axial (z)

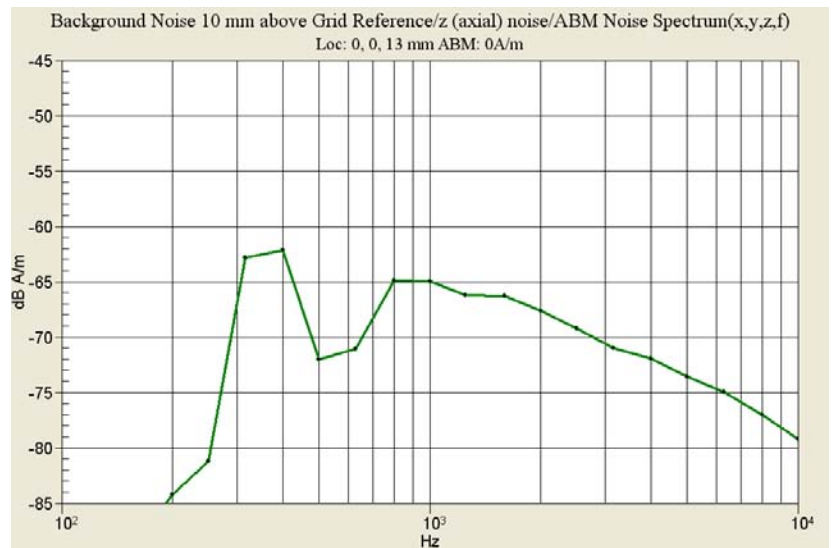

Ambient Noise Spectrum Plot Radial Longitudinal (x)

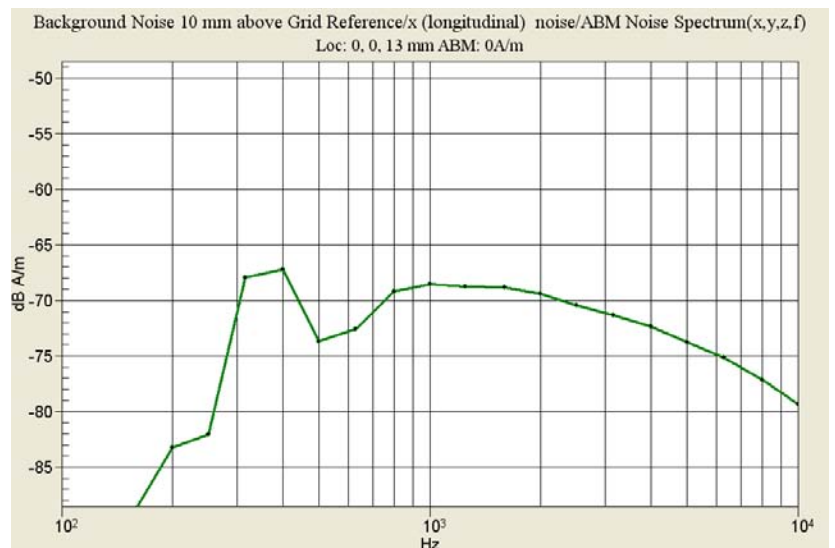

Ambient Noise Spectrum Plot Radial Transversal (y)

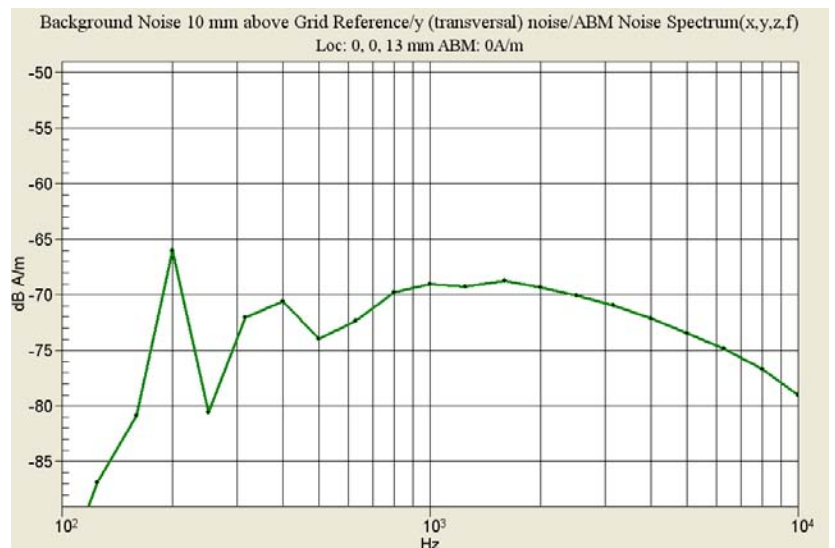

14 Appendix C: System Calibration Results

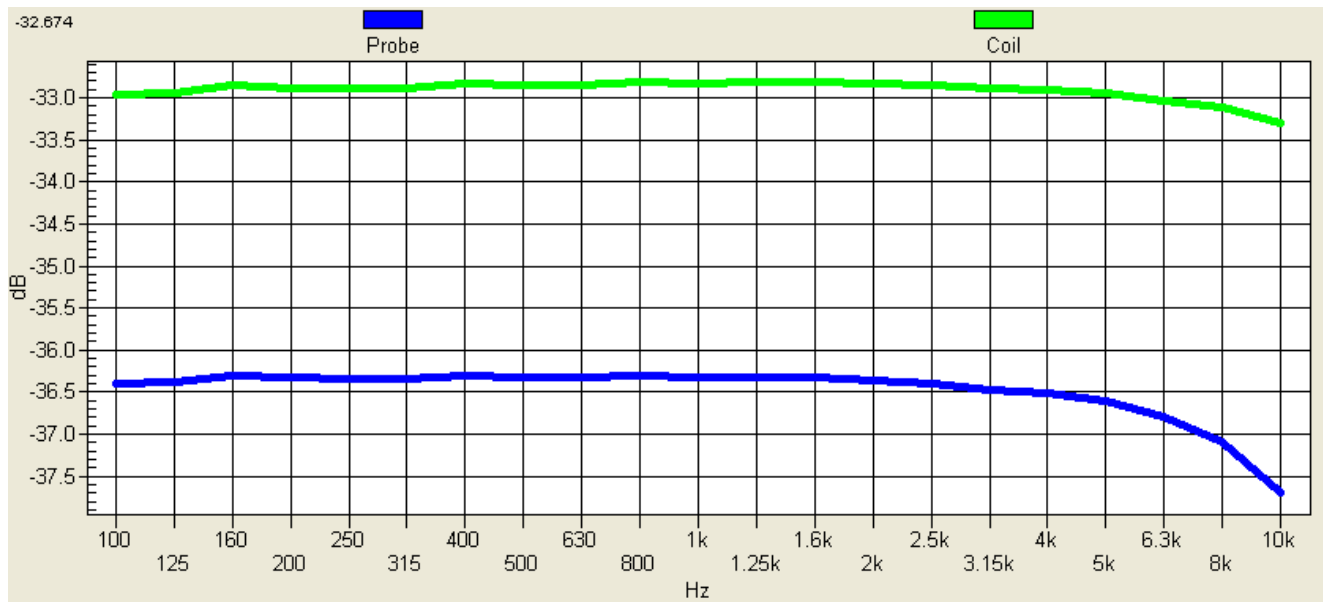

15 Appendix D: ABM and SNR Test Results/Plots

(See attachment)

16 Appendix E: Photo Test Setup

(see attachment)