



User Guide

Touchscreen Mobile Phone

Table of Contents

Introduction	2
For Your Safety	3
Getting Started	4
Call Functions	12
Contacts	14
Call Log	17
Calendar	17
Multimedia	18
Messaging	22
Games	24
Internet	24
Profiles	26
Tools	26
Camera	26
My files	28
Settings	28
Care and Maintenance	32

Introduction

Thank you for choosing the product. The KU86 is a touchscreen mobile phone features a 2.8 inch screen with 240*320 resolution, a 2-megapixel camera/camcorder, and Bluetooth for handsfree devices. This is also a quad-phone supporting the four global standard GSM frequencies of 850/2100 MHz, so you do not worry about that whether or not your phone will work in a different country.

As you explore your KU86 mobile phone, use this guide to find out more useful information.

Now get your SIM card and enjoy your new KU86 mobile phone!

© 2010 by Compal Communications Inc. All rights reserved

No part of this publication may be reproduced, stored in a retrieval system or transmitted in any form or by any means(electronic, mechanical, photocopying, recording or otherwise) without prior written permission from Compal Communications Inc.

For Your Safety

Read and understand all the following guidelines before using the product. Breaking the rules may be dangerous or illegal.

- Use only approved battery and charger. Do not connect incompatible products. Using other types of batteries or chargers may damage the phone and void the warranty.
- Turn off the phone before inserting or removing the battery and memory card.
- Keep the battery and the phone dry and away from water or any other liquids as it may cause a short circuit.
- Keep the battery out of the reach of children.
- Do not dispose of the battery by fire or with hazardous or flammable materials.
- Do not use a hand-held phone while driving, except in the case of emergency.
- Do not use the phone in areas where its use is prohibited. Switch the phone OFF near medical equipment, in aircraft, and at the refueling point.
- Do not take apart or attempt to service the phone yourself.

Getting Started

Phone at a glance

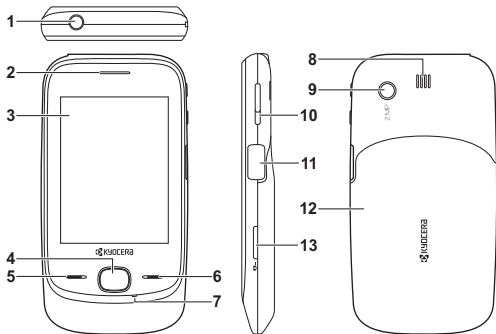

1 Earphone jack

2 Earpiece

3 Touch screen

4 Menu key

5 Call key

6 Power/End key

7 Microphone

8 Speaker

9 Camera lens

10 Volume keys

11 USB charge/sync
connector

10 Volume keys

12 Back cover

13 Camera key

SIM card

The SIM (Subscriber Identity Module) card, which contains your subscription details, is provided by your network operator.



Important!

Keep your SIM card in a safe place when you are not using it. The SIM card can be easily damaged by scratching, bending, or exposing it to static electricity, water, or dirt.

Install the SIM card, battery and memory card

Always turn off your phone and disconnect the charger before installing or replacing the SIM card, battery, and memory card.

1. Slide the back cover downward to release and remove the cover.

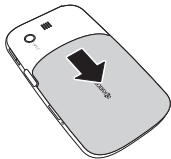

2. Locate the SIM card slot and insert the SIM card with its gold contacts facing down and its cut-off corner facing out the card slot. Make sure the card is securely inserted.
3. If necessary, locate the memory card slot and insert the memory card with its gold contacts facing down as shown. Make sure the card is securely inserted.
4. Insert the battery with the correct polarity. Then gently press down to secure the battery.
5. Slide the back cover into place.

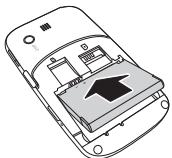
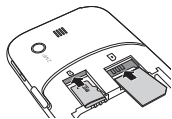

To remove the SIM card, memory card, and battery,

1. Make sure the phone is turned off.
2. Remove the back cover.
3. Lift out the battery from the notches at the bottom of the battery compartment as shown.

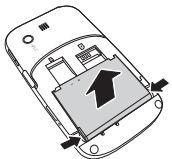

4. Gently press on the SIM card and slide it out of its slot.
5. Gently press on the memory card and slide it out of its slot.

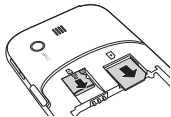

Charge the battery

1. Make sure the battery is installed properly in your phone.
2. Connect the AC charger and the phone using the supplied USB sync cable.
3. Plug in the AC charger to an electrical outlet to start charging the battery.



Important!

The rechargeable Lithium-ion battery is not charged when shipped. Before you start using your phone, it is recommended that you install and fully charge the battery.

An icon in the upper-right corner of the **Main** screen shows battery charging status. When charging is complete, a full battery icon (▢▢▢▢) appears on the screen. Disconnect the phone and the charger from the electrical outlet.



NOTE

Your phone can be charged via a computer's USB port. To do so, connect your phone directly to a computer's USB port using the supplied USB cable. Make sure the computer used for charging is turned on.

Low battery indicator

When the battery power is low, you will find a blinking empty battery icon () at the top of the **Main** screen. The phone will sound an alert and display a low-battery warning message. In this condition, you should immediately charge the battery, otherwise the phone may be turned off automatically.

Turn your phone on and off

To turn the phone on, press and hold the **Power/End** key until the display lights up. If you have set up phone and SIM card password, the phone may prompt you to enter your password to unlock your phone or SIM card.

To turn off the phone, press and hold the **Power/End** key for a few seconds.

Status indicators

Your device status indicators are located at the top of the **Main** screen. Here's some common indicators:

 : The current signal strength of the cellular network.

 : You have selected the *Normal* profile mode.

 : You have one or more unread messages.

 : Alarm has been set.

 : Bluetooth function is activated.

 : Bluetooth device is connected.

 : The battery charging level.

 : Available 3G network connection.

 : Available Edge network connection.

Lock the keys and touchscreen

To avoid accidental dialling, the touchscreen and keys may be locked automatically after a period of inactivity. You can also lock the touchscreen and keys manually by pressing the Menu key.

To unlock, press and hold the  icon on the **Main** screen.

Adjust the volume



The volume keys on the side of the phone allows you to quickly adjust ring tone, music player and earpiece volumes.



NOTE

Earpiece volume can be only adjusted during a call.

Access the Main menu and shortcut menus

- To start using the touchscreen, first press the **Menu** key on the phone to enter the **Main menu**.
- Tap a menu item you want to use. Each menu item may have a shortcut menu. To access, touch a menu item and tap  at the top left-hand corner of the screen. There may be more options available under a shortcut menu. Touch and hold a shortcut menu to bring up its option menu. Touch and slide your finger up or down the screen to scroll through the shortcut menu and option menu.
- To go back to the previous screen, tap  at the top right-hand corner of the screen.

Widget

Widgets are placed at the bottom of the **Main** screen, which is called Widget section. These widgets can be shortcuts to an application or program so that you can easily access them from the **Main** screen. You can drag widgets left and right to reorder them. To open a widget, do the following:

1. Press the widget you want to use until the icon turns green.
2. Drag it out of the Widget section and onto the desktop.

To close a widget, press the widget until the icon turns green and drag it back to the widget section.

Text input modes

When you store names in the Contacts or write a message, you can enter text by using the on-screen keypad. Tap  to bring up the text input menu.

Call Functions

Make a call

There are two ways you can make a call,

- From the **Dialer** -- From any screen, press the **Call** key to bring up the Dialer. Use the on-screen keypad to enter the phone number, then touch  to call the number.
- From **Contacts** -- Tap the desired contact in the contact list, and tap the phone number that you want to call.

Answer or reject a call

When a call comes in, the screen displays the phone number or a caller's name (if stored in **Contacts**).









- To answer the call, press the **Call** key on the phone or tap the green **Answer** button on the screen.
- To reject a call, press the **Power/End** key on the phone or tap the red **End/Reject** button on the screen.

End a call

When you are finished talking, tap the **End/Reject** button on the Dialer screen to hang up.

During a call

Your phone provides a number of options that you can use during a call.

-   : Mute/Unmute the microphone.
-   : Activate/Deactivate the speakerphone.
-  : Place the current call on hold, allowing you to alternate between two calls.
-  : Place another call. To make a three-party conversation, tap .
-  : Search for a number in **Contacts**.

Speed dial

Speed dialling allows you to make a call with a single tap on the Dialer screen. Before you can use this function, you will need to assign different phone numbers to the speed dial numbers.



How to set up speed dial?

See "**Speed dial**" on page 13.

Contacts

Contacts lists all entries on your phone and on the SIM card. You can use this feature to create, edit, and manage all contact information. Touch and slide your finger up or down the screen to scroll through **Contacts** directory.



Add a new contact

1. Press the **Menu** key to enter the **Main menu**.
2. Tap **Contacts** >  > **Add**.
3. Touch each field and use the on-screen keypad to enter the necessary information.
4. You can also assign a picture or a specific ring tone to a new contact.
5. To add more fields, tap  > **Add**.
6. When finishing editing, tap  > **Save**.

Caller groups

The phone provides five default groups as follows, Business, Family, Friends, Others, and VIP. You can also create new groups or delete existing groups from **Main menu** > **Contacts** >  > **Group**.

To assign a contact to a group:

1. Press the **Menu** key to enter the **Main menu**.
2. Tap **Contacts** >  > **Groups**.
3. Touch a group type, tap , and select a contact from the list.

Speed dial

Speed dials can only be assigned to numbers stored in **Contacts** only. To create a speed dial entry from **Contacts**, do the following:

1. Press the **Menu** key > tap **Contacts** >  > **Speed dial**.
2. Tap a key to use as the speed dial key.
3. Tap a desired contact to assign to that key.

Personal details

From the **Main menu**, tap **Contacts** >  > **My details** or **Owner numbers** to enter your personal details.

Service dial number

From the **Main menu**, tap **Contacts** >  > **Service dial number** to view the SDN (Service Dialing Numbers) list assigned by your service provider in your SIM card.

SOS number

From the **Main menu**, tap **Contacts** >  > **SOS number**. The worldwide emergency number for mobile is 112.

Manage contacts

This feature allows you to copy and move contacts to different databases (from phone memory to SIM card or vice versa), and clear all contacts from both your phone memory and SIM card. To use this function, enter the **Main menu**, and tap **Contacts** >  > **Manage contacts**.

Settings

From the **Main menu**, tap **Contacts** >  > **Settings** to display the following advanced configuration.

- **Sort contacts by:** Choose from *First name* or *Last name*.

- **Save new contacts to:** Choose from *Ask each time*, *Phone memory*, or *SIM memory*.
- **View contacts from:** Choose from *Phone memory*, *SIM memory*, or *Both phone and SIM*.

Call Log

Call Log allows you to view all recent history including all received, dialed, and missed calls. Enter the **Main menu**, and tap **Call Log** >  to clear call history, and check call time or cost.



NOTE

*The most recent calls are listed first. The phone will list recent calls in 30 days and store call logs for 30 days by default. You can change the settings via **Main menu > Call Log** >  > **Settings**.*

Calendar



You can use this application to schedule appointments or a repeating event such as a birthday, anniversary, or meeting.

Create a new calendar entry

1. Open the **Main menu** and tap **Calendar**.

2. Touch a specific date. Tap  > **New**.
3. Choose the new event type from *Appointment*, *Anniversary*, *Birthday*, and *Vacation*. Then enter the event information. The reminder and event recurrence can be set for appointments only.

View and delete an event

- To open an event, touch a specific date, and then tap  > **View day**.
- To delete an event, touch a specific date, and then tap  > **Delete**.
- To move to the current date, tap  > **Go to today**.



You can configure the starting day of the calendar and the default reminder time for appointments via  > **Settings**.

Multimedia

Multimedia works as an entertainment center, which is well equipped with image gallery, music player, video player, voice recorder, and FM radio.

View images

Open the **Main menu** and tap **Multimedia > Gallery** to view all the images stored in your device. Tap on the desired thumbnail to view the image in the fullscreen mode. Double-tapping the fullscreen image to bring up the zoom function.

- To view images as a slideshow, tap  > **Slideshow**.
- To take a new picture, tap  > **Take picture**.
- To delete all images, tap  > **Delete all**.

Music player



This allows you to play the media files stored on your phone or memory card. To open the music player, go to **Main menu > Multimedia > Music player**. You can easily control the music player by tapping the control buttons on the screen.

Media libraries

Go to **Main menu > Multimedia**, touch **Music**, **Playlist**, or **Video** library to locate the songs, playlists, or videos you want to play. In each library, touch and hold a track, playlist, or video to bring up the shortcut menu.

Create a playlist

To create playlist of your favorite tracks, do the following:

1. Go to **Main menu > Multimedia > Playlist**, tap  > **New**.
2. Enter a name for the playlist and tap . The new playlist is added to the Playlist library.
3. Touch the playlist you want to edit and touch the music tracks you want to add to the playlist. When finished adding songs, tap  > **Save**.

To rename or delete a playlist, touch and hold the playlist, and then choose the desired option on the shortcut menu.



Update media library

Go to **Main menu > Multimedia > Update media library** after you add or delete any media files. It stores your media information and updates the music, playlist, and video library databases.

Voice recorder

Go to **Main menu > Multimedia > Voice recorder** to record a voice note. You can send the voice record as a message

or set it as a ring tone. Use the control buttons on the screen to start, pause, and stop a recording.





- To save a recording, tap . All recording files are saved to **My recordings** folder.
- To access **My recordings** folder, tap .

In **My recordings** folder, touch and hold a voice recording to bring up the shortcut menu.



FM radio

Go to **Main menu > FM radio**. This feature lets you listen to FM radio stations on your phone. Before you open the FM radio, you must connect a wired headset (headset wire functions as the antenna) to the earphone jack of your phone. On the FM radio screen, tap the red **Power**  button to turn the FM radio on.





Tuner

Touch and hold the Tuner  and  keys to scan for available frequencies. Simply touch the Tuner  and  keys to fine tune the frequency by ± 0.1 MHz.

Channel

When you have preset radio stations, you can use the Channel  and  arrow keys to scroll through your preset channels.

To save favorite stations as presets, do the following:

1. Find a desired frequency by either using the Tuner  and  keys on the FM radio screen or tapping  > **Manual input**.
2. Tap  > **Save** to save a preset channel.

To edit or delete a preset channel, tap  > **Channel list**. Touch and hold a channel, and choose the desired option.



Messaging

Your phone supports a variety of messaging services. Go to **Main menu > Messaging** to send and receive your text, multimedia, email, and WAP push messages. Contact your service provider for details on which services you can use.

Compose and send a new message

Press the **Menu** key to enter the **Main menu**. Tap **Messaging > Create new message** to edit your message.

You can tap  > **Add content** to add a media file, contact, or attachment in your message.

When you finish editing the message, tap  > **Set recipients** > enter a recipient's phone number or select from **Contacts**. On the **Recipients** screen, tap  > **Add** to add more recipients or **Send** to send the message.



NOTE

*If you do not want to send out the message immediately, tap  > **Save as draft** on the **Message** screen.*

More options

On the **Message** screen, tap  > **Advanced options** to configure more settings. The options include *Priority*, *Read report*, *Delivery report*, *Relative delivery time*, and *Relative validity period*.

Set up an email account

Press the **Menu** key to enter the **Main menu**. Tap **Messaging > Email** >  to create a new email account. Follow the on-screen instructions and complete as required.

When finished, your new email account will be displayed under **Messaging > Email**. Tap an email account to start writing and checking your emails.



Games

The phone offers four games. Access these games via **Main menu > Games**.

Internet

This application lets you browse web pages from your phone. This service is dependent on your network service provider.

Launch the browser and visit a web page

1. From the **Main menu**, tap **Internet > Browser**.
2. A message pops up asking you if you want to connect to the Internet. Tap **Yes**.
3. To browse a web page, tap  **> Go to URL**.
4. Enter the desired URL address, and tap  **> Go**.





NOTE

*You can change the home page of your browser via **Main menu > Internet > Settings > Home page.***

Other features

From the **Main menu**, tap **Internet** to access the following features:

- **Bookmarks:** You can bookmark a web page by tapping  > **New**. Use your finger to scroll up and down the bookmark list if necessary. Tap a desired bookmarked web page to view.
- **History:** You can view the recently visited web pages via **Main menu > Internet > History**.
- **Enter URL:** Instead of opening the browser, you can simply go to **Main menu > Internet > Enter URL** to enter a web page address. When finished, tap  > **Go** to view the web page.
- **Saved pages:** You can find a list of saved pages here. Tap a desired web page to view.
- **RSS reader:** Once you know the URL of an RSS feed, tap  to enter the RSS feed URL to your reader.

- **Weather:** It retrieves the latest weather information for your chosen local weather location.

Settings

From the **Main menu**, tap **Internet > Settings** to personalize your browser.

Profiles

You can select a specific profile to use with your phone. Enter the **Main menu**, and tap **Profiles**. Each profile uses a different ring and vibrate setting for incoming calls and messages.



Tools

Your phone offers a set of useful gadgets. Go to **Main menu > Tools** to use the small applications such as calculator, converter, alarm, or stopwatch.

Camera

The **Camera** feature allows you to take photos and record video clips. Go to **Main menu > Camera** or press the **Camera** key on the right side of your phone to activate the

camera. On the Camera screen, tap  to enter the camera settings. Tap the capture mode you want to use.

-  : Touch this key in Picture mode to take a photo.
-  : Touch this key in Video mode to record a video clip.

Camera settings

On the Camera screen, tap  to enter the camera settings. The following tabs are represented by icons on the top of the screen. Press the **Power/End** key to save the settings and return to the Camera screen.





Icon	Tab	Description
	Camera	To adjust a setting, keep tapping an item to cycle through the available settings.
	Program mode	Set the shooting mode to Automatic or Night.
	White balance	Set this option to Automatic, Cloudy, Fluorescent, or Incandescent.
	Style	Set the image color tone Normal, Black and white, Sepia, or Negative.



Image
size

Set the image size.





Quality

Set the image quality to Low, Medium, or High.

My files

All the media files and the files you download from the Internet are stored in **My files**. From the **Main menu**, tap **My files > Phone**, there are six folders (My downloads, My music, My pictures, My recordings, My ring tones, and My videos) created by default.

- To create a new folder, tap  > **Create folder**.
- Tap and hold a folder to bring up the shortcut menu. The **Rename**, **Move to**, and **Delete** options are only available with custom folders.
- To delete all folders in the phone, tap  > **Delete all**.

Settings

From the **Main menu**, tap **Settings** to configure more settings for your phone.

General

Tap **General > Date and time**, to set up the current date and time of your phone, time zone, time format, daylight saving time, and automatic daylight saving time adjustment.

To use your phone on an airplane during flight, tap **General > Airplane mode > On** to enable the non-wireless functions of your phone (such as music, games, calendar, or camera).

Connectivity

Main menu > Settings > Connectivity allows you to configure *Mobile networks*, *Bluetooth*, *Data accounts*, *MMS settings*, *Browser settings*, *Internet connection*, *Email*, and *Data service confirmation*.

Sounds & alerts

Main menu > Settings > Sounds & alerts allows you to set ring tones and volume of a call, message, alert, and notification. You can also switch the silent mode, vibration, battery alerts, and dialog alerts on or off by scrolling down the list and tapping on the corresponding option.

Screen

Main menu > Settings > Screen allows you to configure screen-related settings. The options include *Wallpaper*,

Display language, Input language, Chinese input mode, Brightness level, Lighting duration, Dialog dismiss timer, and Camera timeout timer.

Calls

There are other advanced call features in your phone. Some features are dependent on your service provider's network. From the **Main menu**, tap **Settings > Calls** to access the following functions:

- **Divert call:** Redirect the voice, video, fax, data, or all incoming calls to another number. Call divert conditions include Always, When busy, Not reachable, and No answer.
- **Call waiting:** Activate this option to notify you when another call comes in while you are on a call.
- **Restrict call:** Restrict or bar certain or all types of calls to and from your phone.
- **Send my number:** Display or hide your phone number while making a call.
- **Voice mail:** Tap  to set up your voice mail service number.

Security

The **Security** feature allows you to activate/deactivate and set the codes for a SIM card and your phone. Tap **Settings > Security** to access the following options:

- **PIN code request:** Set this option to **On** to protect your SIM card by requesting a PIN code every time the phone is turned on.
- **SIM lock:** Set this option to **On** to lock your phone with the current SIM card. To use a different SIM card, you must enter the correct **SIM lock** code to unlock the phone.
- **Phone lock:** Set this option to **On** to protect the data in your phone by requesting a password every time the phone is turned on.
- **Change PIN:** Change the SIM PIN code.
- **Change PIN2:** Change the SIM PIN2 code.

Factory reset

This allows you to restore all settings to factory default or delete all user data in the phone memory. From the **Main menu**, tap **Settings > Factory reset**, and then tap the desired option.

Care and Maintenance

Battery information and care

- Do not short-circuit the battery. Accidental shortcircuiting can occur when a metallic object such as a coin, clip, or pen causes direct connection of the positive (+) and negative (-) terminals of the battery.
- Always try to keep the battery between 15°C and 25°C (59°F and 77°F). Extreme temperatures reduce the capacity and lifetime of the battery.
- Do not dispose of batteries in a fire as they may explode. Dispose of batteries according to local regulations. Please recycle when possible.
- Use the battery only for its intended purpose. Never use any charger or battery that is damaged.
- Keep your battery out of the reach of small children.

Certification information (SAR)

Your mobile device is a radio transmitter and receiver. It is designed not to exceed the limits for exposure to radio waves recommended by international guidelines. These guidelines were developed by the Federal Communications Commission of the US Government and include safety margins designed to assure the protection of all persons,

regardless of age and health.

The exposure guidelines for mobile devices employ a unit of measurement known as the Specific Absorption Rate or SAR. The SAR limit stated by the FCC is 1.6 watts/kilogram averaged over 10 grams of tissue. Tests for SAR are conducted using standard operating positions with the device transmitting at its highest certified power level in all tested frequency bands. The actual SAR level of an operating device can be below the maximum value because the device is designed to use only the power required to reach the network. That amount changes depending on a number of factors such as how close you are to a network base station. The highest SAR value for use of the device at the ear is 1.42 W/kg. The highest SAR value for use of the device at the body is 1.38 W/kg. For body worn operation, position the handset a minimum of 1.5 cm from your body.

Use of device accessories may result in different SAR values. SAR values may vary depending on national reporting and testing requirements and the network band.

Use the mobile device properly to reduce your exposure to electromagnetic radiation (EMR).

Without permission granted by the National Communications Commissions (NCC) of Taiwan, any company, enterprise, or user is not allowed to change frequency, enhance transmitting power or alter original characteristic as

well as performance to a approved low power radio-frequency devices.

Low power radio-frequency devices shall not influence aircraft security and interfere with legal communications; If such influence or interference occurs, the user shall immediately cease operating the device. Legal communications is defined as radio communications operations that conform to the Telecommunications Act.

Low power radio-frequency devices must accept any interference received from legal communications and industrial, scientific, and medical (ISM) radio wave radiated devices.

FCC NOTICE

This mobile phone complies with part 15 of the FCC Rules. Operation is subject to the following two conditions: (1) This device may not cause harmful interference, and (2) this device must accept any interference received, including interference that may cause undesired operation.

This mobile phone has been tested and found to comply with the limits for a Class B digital device, pursuant to Part 15 of the FCC Rules. These limits are designed to provide reasonable protection against harmful interference in a residential installation. This equipment generates, uses and can radiated radio frequency energy and, if not installed and

used in accordance with the instructions, may cause harmful interference to radio communications. However, there is no guarantee that interference will not occur in a particular installation. If this equipment does cause harmful interference to radio or television reception, which can be determined by turning the equipment off and on, the user is encouraged to try to correct the interference by one or more of the following measures:

- Reorient or relocate the receiving antenna.
- Increase the separation between the equipment and receiver.
- Connect the equipment into an outlet on a circuit different from that to which the receiver is connected.
- Consult the dealer or an experienced radio/TV technician for help.

Changes or modifications not expressly approved by the party responsible for compliance could void the user's authority to operate the equipment.

The antenna(s) used for this transmitter must not be co-located or operating in conjunction with any other antenna or transmitter.