

Installation and operation guide

READY MTU

Warning!

Read instructions before installation



Disclaimer

All information provided in this document is copyright of Kamstrup. Licence is granted to the user to freely use and distribute the information in complete and unaltered form, provided that the purpose is to use or evaluate Kamstrup products. Distribution rights do not include public posting or mirroring on Internet websites. Only a link to the Kamstrup website can be provided on such public websites.

Kamstrup shall in no event be liable to any party for direct, indirect, special, general, incidental, or consequential damages arising from the use of this information or any derivative works thereof. The information is provided on an as-is basis, and thus comes with absolutely no warranty, either express or implied. No right or licence is granted under any intellectual property right, hereunder copyright, patent or trademark, of Kamstrup to any other party. This disclaimer includes, but is not limited to, implied warranties of merchantability, fitness for any particular purpose, and non-infringement.

Information in this document is subject to change without notice and should not be construed as a commitment by Kamstrup. While the information contained herein is believed to be accurate, Kamstrup assumes no responsibility for any errors and/or omissions that may appear in this document.

Copyright Information

Copyright © Kamstrup A/S

Industrivej 28

Stilling

DK-8660 Skanderborg, Denmark

All Rights Reserved

The graphics and content in this document are the copyrighted work of Kamstrup and contain proprietary trademarks and trade names of Kamstrup.

Third parties

This document may contain links to other parties. Kamstrup makes no warranty or representation regarding any linked information appearing therein. Such links do not constitute an endorsement by Kamstrup of any such information and are provided only as a convenience. Kamstrup is not responsible for the content or links displayed by third parties.

Contents

1	Symbols used in this document	4
1.1	Warnings in this document	4
2	Abbreviations	6
3	FCC caution	6
4	Canadian compliance statement	6
5	Technical data	7
5.1	Product introduction	7
5.2	System overview	7
5.3	Electrical data	7
5.4	Mechanical data	7
5.5	Material	8
5.6	Communication	8
5.7	Transmission interval	8
5.8	Input	8
5.9	Data security	8
6	Before you begin	8
6.1	Precautions	8
6.2	What is in the box	9
6.3	Accessories	9
6.4	Deployment process summary	9
7	Before field deployment	9
7.1	Import READy MTU from Kamstrup Encryption Key Service	9
7.2	Import non-Kamstrup meters and customer information in READy Manager	9
7.3	Create a group of non-Kamstrup meters for READy MTU installation	10
7.4	MTU modes and LED blinking scheme	10
8	Field deployment	11
8.1	Installation	11
8.2	Configuration of READy MTU	14
8.3	Default or preconfigured	14
9	Operation	21
9.1	Normal operation	21
9.2	Alarms/info codes	21
9.3	Device exchanges	22
9.4	Fallback and log readings	23
9.5	Reconfiguration	23
9.6	Decommissioning	26
9.7	Kamstrup support	28
10	Storage	28
11	Disposal	29
11.1	Disposal by Kamstrup A/S	29
11.2	The customer sends for disposal	29
11.3	Disposal by the customer	29
11.4	Instructions for disposal	29
12	Ordering details	30
12.1	Type number	30
12.2	US AMI MTU configuration is described below:	30
12.3	Other MTU ordering data	31
12.4	Accessories	31

1 Symbols used in this document



Warning

Indicates a hazardous situation which, if not avoided, could result in death or serious injury.



Caution

Indicates a hazardous situation which, if not avoided, could result in moderate injury, damage the product, or lead to loss of data.

Notice

Indicates a hazardous situation which, if not avoided, may seriously impact operations.

1.1 Warnings in this document



Warning

Battery safety:

Fire, explosion and severe burn hazard.

Please follow these guidelines in order to avoid injury to yourself and others:

- If not disposed of properly, the battery may cause fire or chemical burn
- Do NOT recharge, disassemble, crush, expose to water, heat above 212 °Fahrenheit (100 °Celsius), or incinerate the battery
- Keep away from children



Warning

Must be installed to provide a separation distance of at least 20 cm from all persons.



Warning

The contents of this guide and the quick guide included with the device must be followed at all times when installing, configuring or handling the device in general. If this guide is not followed, Kamstrup cannot be held accountable for any malfunctions or misuse of the product.



Warning

Do not install outside Lightning Protection Zone 0C. 10 ft/3 m height and depth around the building.



Warning

Use only approved accessories with this device. Unapproved modifications or operation beyond or in conflict with these instructions for use may void authorization by the authorities to operate the device.



Warning

Ensure that READy MTU is in transport mode when transported by air freight or during decommissioning.



Warning

Ensure proper disposal of the product.



Caution

Do not disassemble the product as the IP68 sealing will be void, and do not tamper with the internal battery and electronics.



Caution

READy MTU is designed to operate at temperatures of -30 °C...65 °C [-22 °F...149 °F]. Using the device outside the intended operating temperature range may cause deterioration of battery life or in worst case operating failure.



Caution

Must NOT be co-located in conjunction with any other antenna or transmitter.



Caution

Do not try to modify or repair the device. Attempts to modify or repair will void the warranty.



Caution

Ensure that READy App and READy Manager are synchronized before you proceed with the installation.



Read the guide prior to installation and taking the device into use.



The product may only be installed by trained personnel.



Wire terminations must be properly sealed with a non-conductive gel material to prevent water intrusion (otherwise, this configuration should not be used in a pit environment).



Kamstrup does not recommend using gel connectors in pit environments.



Kamstrup recommends mounting READy MTU in/under non-metallic meter pit lids only. If installing under metal lids, make sure to use the pit antenna.



Mount READy MTU as high as possible in the pit, without the antenna being in contact with the pit lid.



Mount READy MTU as high as possible. The MTU should be mounted at or above ground level. Mount READy MTU as high as possible. The MTU should be mounted at or above ground level.



Always install READy MTU in the protection cover (accessory) when the device is installed in sun-exposed areas.



Mount READy MTU at least 6 inches away from any metal objects, including pipes, conduit, and downspouts.



When mounting multiple MTUs in the same location, leave at least 4 inches between the MTUs if mounting side by side and at least 3 inches between MTUs if mounting one above another.



Do not mount READy MTU so that it is transmitting towards a nearby building or fence.



Do not mount READy MTU directly under AC power or telecommunications wires.



Mount READy MTU as high as possible near an exterior wall. The MTU should be mounted at or above grade (ground level).



Mount READy MTU at least 6 inches away from pipes and conduit and several inches below the ceiling.



Mount READy MTU at least 5 feet away from any large metal objects. (e.g. refrigerators, HVAC ducts, furnaces, and hot water heaters).



Do not mount READy MTU in a basement with a metal ceiling.



Do not mount READy MTU directly under AC power wires, circuit breaker panels, or telecommunications wires.

2 Abbreviations

MTU:	meter transmission unit
LPZ:	Lightning Protection Zone
MDM:	meter data management
EO:	encoded output
CIS:	customer information system

3 FCC caution

This device complies with part 15 of the FCC Rules. Operation is subject to the following two conditions:

- (1) This device may not cause harmful interference, and
- (2) this device must accept any interference received, including interference that may cause undesired operation.

This equipment has been tested and found to comply with the limits for a Class B digital device, pursuant to part 15 of the FCC Rules. These limits are designed to provide reasonable protection against harmful interference in a residential installation. This equipment generates, uses and can radiate radio frequency energy and, if not installed and used in accordance with the instructions, may cause harmful interference to radio communications. However, there is no guarantee that interference will not occur in a particular installation. If this equipment does cause harmful interference to radio or television reception, which can be determined by turning the equipment off and on, the user is encouraged to try to correct the interference by one or more of the following measures:

- Reorient or relocate the receiving antenna
- Increase the separation between the equipment and receiver
- Connect the equipment into an outlet on a circuit different from that to which the receiver is connected
- Consult the dealer or Kamstrup for help

4 Canadian compliance statement

This device complies with Industry Canada license-exempt RSS standard(s). Operation is subject to the following two conditions:

- (1) This device may not cause interference, and
- (2) This device must accept any interference, including interference that may cause undesired operation of the device.

Cet appareil est conforme aux normes CNR exemptes de licence d'Industrie Canada. Le fonctionnement est soumis aux deux conditions suivantes:

- (1) Cet appareil ne doit pas provoquer d'interférences et
- (2) Cet appareil doit accepter toute interférence, y compris celles susceptibles de provoquer un fonctionnement non souhaité de l'appareil.

Complies with the Canadian ICES-003 Class B specifications.

Cet appareil numérique de la classe B est conforme à la norme NMB-003 du Canada.

This device complies with RSS 247 of Industry Canada. This Class B device meets all the requirements of the Canadian interference-causing equipment regulations.

Cet appareil est conforme à la norme canadienne RSS 247. Cet appareil numérique de la Classe B respecte toutes les exigences du Règlement sur le matériel brouilleur du Canada.

5 Technical data

5.1 Product introduction

READy MTU is a one-to-one meter data transmission unit that connects to meters utilizing the Sensus UI1203 Encoded Output protocol. Data from READy MTU is forwarded to the READy Manager MDM system via Kamstrup's AMI system.

5.2 System overview

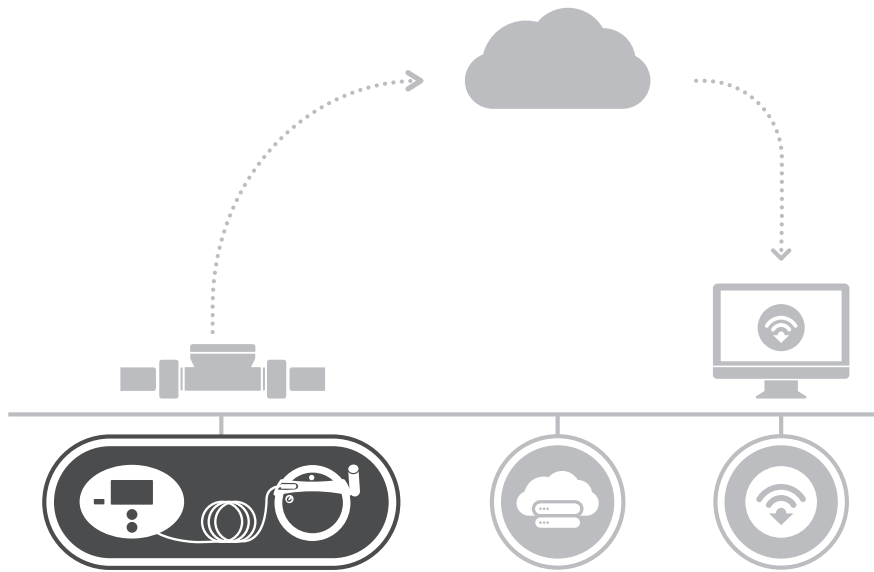

READy MTU connects to an encoded output meter and sends data to READY Collector and READY Manager.

5.3 Electrical data

Battery safety:

Fire, explosion and severe burn hazard.



Warning

Please follow these guidelines in order to avoid injury to yourself and others:

- If not disposed of properly, the battery may cause fire or chemical burn
- Do NOT recharge, disassemble, crush, expose to water, heat above 212 °Fahrenheit (100 °Celsius), or incinerate the battery
- Keep away from children



Caution

Do not disassemble the product as the IP68 sealing will be void, and do not tamper with the internal battery and electronics.

Battery	D-cell battery
Battery lifetime	Up to 20 years at tBAT < 40 °F Up to 16 years at tBAT < 55 °F Up to 8 years at tBAT < 130 °F

5.4 Mechanical data



Caution

READy MTU is designed to operate at temperatures of -30 °C...65 °C [-22 °F...149 °F]. Using the device outside the intended operating temperature range may cause deterioration of battery life or in worst case operating failure.

Protection class	IP68 rated (waterproof/submersible)
Weight	Approx. 525 g / 1.15 Lbs incl. stub antenna
Dimensions	Ø 91.6 mm x 106 mm [Ø 3.6" x 4.2"] Ø 91.6 mm x 149.8 mm [Ø 3.6" x 5.9"] incl. antenna

5.5 Material

Housing	Polyphenylene sulfide (PPS) with fiberglass (40 %) reinforcement
Top ring	Polycarbonate (grey)

5.6 Communication

Wireless fallback reading and configuration	902 MHz – 928 MHz (license free)
Kamstrup AMI	450 – 470 MHz (FCC licensed)
Antenna	External
Magnet sensor	Activation of MTU radio and installation mode

5.7 Transmission interval



Warning

Must be installed to provide a separation distance of at minimum 20 cm from all persons.



Caution

Must NOT be co-located in conjunction with any other antenna or transmitter.

Meter reading interval	Hourly top of the hour
Transmission	Every 3 hours

5.8 Input

Single meter/register input	Sensus UI-1203 3-wire encoded
Wire length	5 ft Nicor/Itron/flying wire

5.9 Data security

READY MTU is part of the complete end-to-end data encryption of the READY suite. Data is AES 128 bit end-to-end encrypted when in transit from READY MTU to READY Manager.

6 Before you begin

6.1 Precautions



Warning

The contents of this guide and the guide included with the device must be followed at all times when installing, configuring or handling the device in general. If this guide is not followed, Kamstrup cannot be held accountable for any malfunctions or misuse of the product.



Caution

Do not try to modify or repair the device. Attempts to modify or repair will void the warranty.



Caution

Ensure that READY App and READY Manager are synchronized before you proceed with the installation.



Caution

Read the guide prior to installation and taking the device into use.



Caution

The product may only be installed by trained personnel.

NOTE: Kamstrup recommends using READY Bluetooth optical read-out head to activate the magnet sensor of READY MTU. Magnet power 8.6 lbs/3.9 kg [N35].

6.2 What is in the box

The content of the box depends on the chosen accessories:

- READy MTU
- MTU mounting screw
- Quick guide

6.3 Accessories

READy MTU can be ordered with the following accessories:

- 5 ft cable with flying wire, Nicor or Itron plug
- Wall antenna (packed separately)
- External stub antenna
- 3" pit antenna for installation in pit lids (packed separately)
- Wall/pit bracket
- Protection cover for installation in sun-exposed areas (packed separately)
Dimensions: 198 mm x 166 mm x 114 mm [7.8" x 6.5" x 4.5"]

6.4 Deployment process summary

1. Before field deployment

- Import READy MTU(s) in READy Manager
- Import non-Kamstrup meters and customer information (optional)
- Create a group containing non-Kamstrup meters that will be retrofitted with READy MTU
- Charge READy Converter and mobile device

2. Field deployment of default or preconfigured MTU

- a. Default configured MTU: install, activate, and configure READy MTU using READy App and READy Converter
- b. Preconfigured MTU: install and activate READy MTU. No additional configuration is required

3. The installation and configuration are complete

7 Before field deployment

Before field deployment, make sure that your READy Manager system is prepared for collecting data from encoded meters via READy MTU by following the steps in this section.

7.1 Import READy MTU from Kamstrup Encryption Key Service

READy MTU is automatically imported into READy Manager if you are logged in with your My Kamstrup account and the **Import new devices** checkbox is ticked.

If not logged in, you can import READy MTUs directly from Kamstrup Encryption Key Service found in My Kamstrup.

Click the **Import devices** button on the start-up page of READy Manager.

More information can be found in the READy Manager guide under **Automatically importing information for new devices** or **Manually importing information for new devices**.

7.2 Import non-Kamstrup meters and customer information in READy Manager

Notice Kamstrup recommends that you import the ID/serial number that is sent on the encoded output as the meter serial number in READy Manager. If not, you are required to overwrite the serial number of the encoded output with the serial number imported in READy Manager for your specific device.

Import non-Kamstrup meters and customer information in READy Manager by selecting **Import customers** on the start-up page of READy Manager.

More information on CIS import can be found in the READy Manager guide under **Automatically importing customer data** or **Manually importing customer data**.

7.3 Create a group of non-Kamstrup meters for READY MTU installation

It is recommended to create a group of non-Kamstrup meters that will be retrofitted with READY MTU that can be synced with READY App.

Create a group:

1. Select the **Meters** view in READY Manager.
2. Select **New group**. Name the group.
3. Select the meters that are to be part of the group and add the meters to the group.

Find more information in the READY Manager guide under **Organizing meters in reading groups**.

7.4 MTU modes and LED blinking scheme

7.4.1 MTU modes

7.4.1.1 Transport mode

When you receive READY MTU, the device is in transport mode. In transport mode, the radio is deactivated. The magnet sensor for activating the MTU is active.

By influencing the magnet sensor for 3 seconds, the LED on the front of READY MTU turns on. The MTU checks if a meter is connected on the encoded interface before turning on the radio. If no meter is connected, READY MTU remains in transport mode.

Remember to enable transport mode when decommissioning READY MTU. See section **9.6 Decommissioning**.

7.4.1.2 Installation mode

After activation, READY MTU starts up in installation mode. The LED turns on and a connection beacon is sent out every 4 seconds.

Installation mode is active for 5 minutes after activation.



After the installation mode period has ended, READY MTU enters normal mode.

When operating in normal mode, installation mode can be triggered by holding the magnet to the front of READY MTU. This will also reactivate the LED.

7.4.1.3 Operation mode

In operation mode, READY MTU can at all times be accessed via READY App. A connection beacon is sent every 30 seconds during normal operation. The LED is not active in normal mode.

7.4.2 LED blinking scheme

<p>1 time every 5 seconds</p> 	<p>Everything is OK. READY MTU is reading the encoded output and sending data via AMI.</p>
<p>3 times every 5 seconds</p> 	<p>Something is wrong. READY MTU is not reading the encoded output or sending data via AMI.</p>

8 Field deployment



Warning Use only approved accessories with this device. Unapproved modifications or operation beyond or in conflict with these instructions for use may void authorization by the authorities to operate the device.



Warning Do not install outside Lightning Protection Zone OC. 3 meters or 10 ft height and depth around the building.



Caution Wire terminations must be properly sealed with a non-conductive gel material to prevent water intrusion [otherwise, this configuration should not be used in a pit environment].

Notice Complete all cable connections before activating the device using the magnet sensor.

8.1 Installation

READy MTU is intended to be installed in vertical position indoors and outdoors in residential, commercial, and industrial environments. The device is intended to be installed either at ground level, above ground on a wall, or in pits (flooded environment, underground). As READy MTU is IP68 rated, the device is resistant to harmful dust and can be submerged.

8.1.1 Encoded output wiring diagram



Caution Kamstrup does not recommend using gel connectors in pit environments.

Wiring diagram

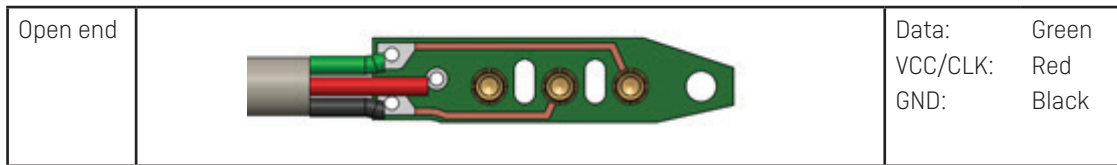

Connector pinouts

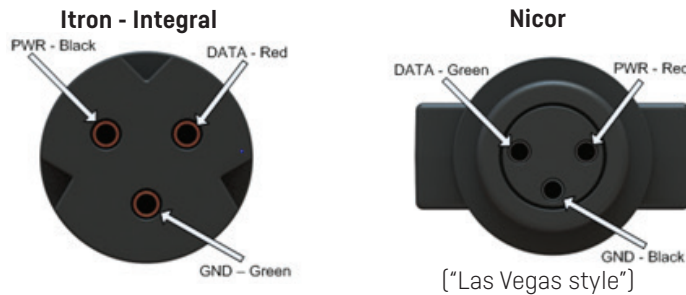

Function	Kamstrup	Sensus	Neptune	Itron Integral
DATA	Green	Green	Red	Red
PWR/Clock	Red	Red	Black	Black
GND	Black	Black	Green	White

8.1.2 Antennas and connectors

When using a pit or wall antenna, please use the grey antenna cover when attaching the antenna to READY MTU.

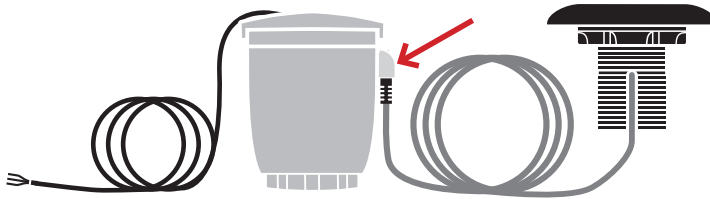

When using the stub antenna, please use the black antenna cover when attaching the antenna to READY MTU.

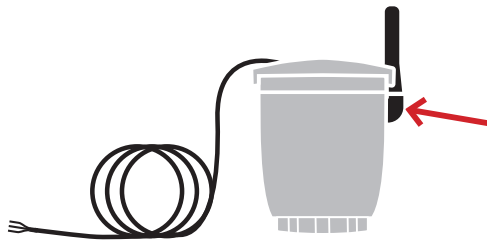

8.1.3 Pit



Kamstrup recommends mounting READY MTU in/under non-metallic meter pit lids only. If installing under metal lids, make sure to use the pit antenna.



Mount READY MTU as high as possible in the pit, without the antenna being in contact with the pit lid.

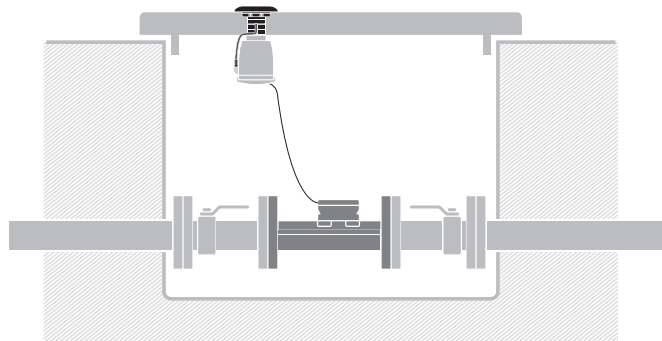

You can use the pit antenna or the wall bracket with a rebar or similar to install READY MTU in pits.

8.1.4 Wall exterior



Caution

Mount READy MTU as high as possible. The MTU should be mounted at or above ground level.



Caution

Always install READy MTU in the protection cover (accessory) when the device is installed in sun-exposed areas.



Caution

Mount READy MTU at least 6 inches away from any metal objects, including pipes, conduit, and downspouts.



Caution

When mounting multiple MTUs in the same location, leave at least 4 inches between the MTUs if mounting side by side and at least 3 inches between MTUs if mounting one above another.



Caution

Do not mount READy MTU so that it is transmitting towards a nearby building or fence.



Caution

Do not mount READy MTU directly under AC power or telecommunications wires.

Notice

Finish the field configuration of READy MTU before installing it in the protection cover.



Use the protection cover in sun-exposed areas. When installed in areas without sun exposure, the wall/pit bracket can potentially be used.

8.1.5 Wall interior



Mount READy MTU as high as possible near an exterior wall. The MTU should be mounted at or above grade (ground level).



Mount READy MTU at least 6 inches away from pipes and conduit and several inches below the ceiling.



Mount READy MTU at least 5 feet away from any large metal objects. (e.g. refrigerators, HVAC ducts, furnaces, and hot water heaters).



Do not mount READy MTU in a basement with a metal ceiling.



Do not mount READy MTU directly under AC power wires, circuit breaker panels, or telecommunications wires.

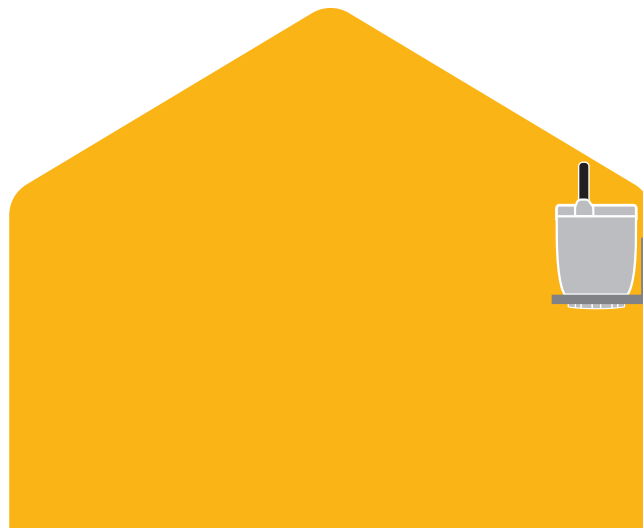

Use the wall bracket to install READy MTU in interior environments.

8.2 Configuration of READy MTU

Required:

- Android device
- READy App (synchronized with READy Manager)
- READy Converter
- Magnet

8.3 Default or preconfigured

If your READy MTU has been ordered preconfigured, please follow section **8.3.1 Configuration of preconfigured MTU**.

If your READy MTU has been ordered default configured, please follow section **8.3.2 Configuration of default configured MTU**.

If in doubt, follow **8.3.2 Configuration of default configured MTU**.

8.3.1 Configuration of preconfigured MTU

Notice

A preconfigured MTU requires that the device serial number imported in READy Manager equals the device ID read on the encoded output.

Notice

Complete all cable connections before activating the device using the magnet sensor.

If the device serial number imported in READy Manager does not equal the ID read by the MTU on the encoded output, please follow the installation and configuration instructions for default configured MTU in section **8.3.2 Configuration of default configured MTU**.

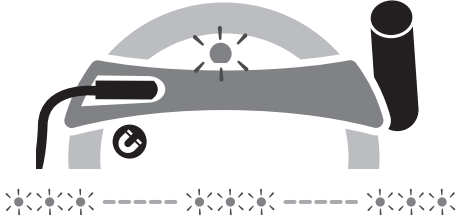
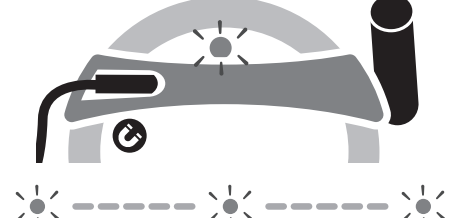
<p>1. The LED starts blinking 3 times every 5 seconds. NOTE: Finish all cable connections before activating READY MTU.</p>	
<p>2. When the LED blinks 1 time every 5 seconds, everything is OK. READY MTU is reading the encoded output and sending data via AMI.</p>	

The LED automatically stops blinking after 5 minutes. No further configuration is needed.



The configuration of a preconfigured MTU can at all times be read and changed by following the steps in section **9.5 Reconfiguration**.

8.3.2 Configuration of default configured MTU

Notice A default configured MTU requires configuration using READY App.

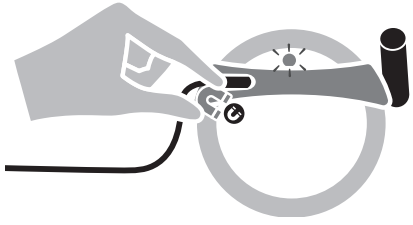
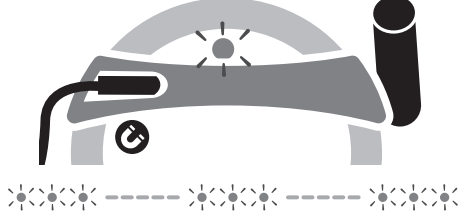
Notice The reading on the encoded output must match the imported meter ID/serial number in READY Manager. If the IDs do not match, you can overwrite the encoded output reading to ensure data flows to the correct meter.

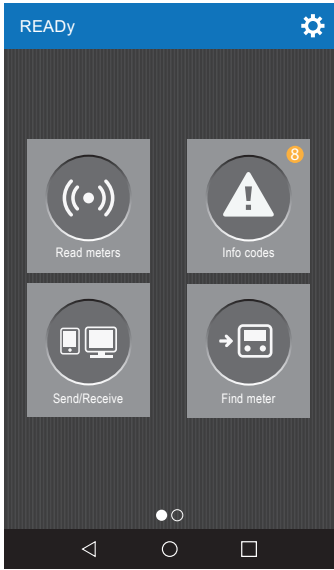
<p>1. Sync READY Manager and READY App before proceeding to step 2.</p>	
<p>2. Activate READY MTU by pointing a magnet at the designated spot.</p>	
<p>3. The LED starts blinking.</p>	

<p>4. Turn on READY Converter.</p> <p>5. Open READY.</p>	
<p>6. Go to the menu item Installation.</p>	
<p>7. Pair with READY Converter.</p>	