



EMI TEST REPORT

Test Report No. : 13487459H-B-R1

Applicant : NIDEC MOBILITY CORPORATION
Type of EUT : ECU of Keyless Operation System
Model Number of EUT : R328E
FCC ID : OUCR328E
Test regulation : FCC Part 15 Subpart B: 2020
Test Result : Complied (Refer to SECTION 3.2)

1. This test report shall not be reproduced in full or partial, without the written approval of UL Japan, Inc.
2. The results in this report apply only to the sample tested.
3. This sample tested is in compliance with the limits of the above regulation.
4. The test results in this test report are traceable to the national or international standards.
5. This test report must not be used by the customer to claim product certification, approval, or endorsement by the A2LA accreditation body.
6. This test report covers EMC technical requirements. It does not cover administrative issues such as Manual or non-EMC test related Requirements. (if applicable)
7. The all test items in this test report are conducted by UL Japan, Inc. Ise EMC Lab.
8. The opinions and the interpretations to the result of the description in this report are outside scopes where UL Japan has been accredited.
9. The information provided from the customer for this report is identified in SECTION 1.
10. This report is a revised version of 13487459H-B. 13487459H-B is replaced with this report.

Date of test: September 6, 2020

Representative test engineer:

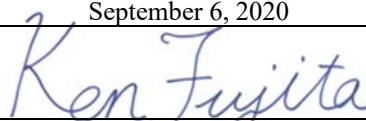
Ken Fujita
Engineer
Consumer Technology Division

Approved by:

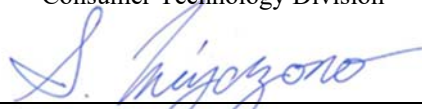
Shinichi Miyazono
Engineer
Consumer Technology Division



CERTIFICATE 5107.02

- The testing in which "Non-accreditation" is displayed is outside the accreditation scopes in UL Japan.
 There is no testing item of "Non-accreditation".

UL Japan, Inc.
Ise EMC Lab.

4383-326 Asama-cho, Ise-shi, Mie-ken 516-0021 JAPAN
Telephone : +81 596 24 8999
Facsimile : +81 596 24 8124

REVISION HISTORY

Original Test Report No.: 13487459H-B

Revision	Test report No.	Date	Page revised	Contents																																																																
- (Original)	13487459H-B	October 13, 2020	-	-																																																																
1	13487459H-B-R1	November 26, 2020	P.6	Addition of “Type of Modulation: ASK” in Smart System: LF Transmitting function of Clause 2.2																																																																
1	13487459H-B-R1	November 26, 2020	P.11	Correction of the following table in Clause 4.2; from <table border="1" style="margin-left: 20px;"> <thead> <tr> <th colspan="4">Description of EUT and Support equipment</th> </tr> <tr> <th>No.</th> <th>Item</th> <th>Model number</th> <th>Serial number</th> </tr> </thead> <tbody> <tr> <td>A</td> <td>ECU</td> <td>R328E</td> <td>10</td> </tr> <tr> <td>B</td> <td>LF Antenna DR</td> <td>841M-A</td> <td>8637A525</td> </tr> <tr> <td>C</td> <td>LF Antenna AS</td> <td>841M-A</td> <td>8637A525</td> </tr> <tr> <td>D</td> <td>LF Antenna INF</td> <td>841M-A</td> <td>8637A525</td> </tr> <tr> <td>E</td> <td>LF Antenna INR</td> <td>841M-A</td> <td>8637A525</td> </tr> <tr> <td>F</td> <td>LF Antenna T/G</td> <td>841M-A</td> <td>8637A525</td> </tr> </tbody> </table> To <table border="1" style="margin-left: 20px;"> <thead> <tr> <th colspan="4">Description of EUT and Support equipment</th> </tr> <tr> <th>No.</th> <th>Item</th> <th>Model number</th> <th>Serial number</th> </tr> </thead> <tbody> <tr> <td>A</td> <td>KOS</td> <td>R328E</td> <td>#10</td> </tr> <tr> <td>B</td> <td>LF Antenna DR</td> <td>5716A639WB</td> <td>200826-1</td> </tr> <tr> <td>C</td> <td>LF Antenna AS</td> <td>5716A640WB</td> <td>200826-2</td> </tr> <tr> <td>D</td> <td>LF Antenna INF</td> <td>G8D-841M-ANT</td> <td>200826-3</td> </tr> <tr> <td>E</td> <td>LF Antenna INR</td> <td>G8D-841M-ANT</td> <td>200826-4</td> </tr> <tr> <td>F</td> <td>LF Antenna T/G</td> <td>G8D-841M-ANT</td> <td>200826-5</td> </tr> </tbody> </table>	Description of EUT and Support equipment				No.	Item	Model number	Serial number	A	ECU	R328E	10	B	LF Antenna DR	841M-A	8637A525	C	LF Antenna AS	841M-A	8637A525	D	LF Antenna INF	841M-A	8637A525	E	LF Antenna INR	841M-A	8637A525	F	LF Antenna T/G	841M-A	8637A525	Description of EUT and Support equipment				No.	Item	Model number	Serial number	A	KOS	R328E	#10	B	LF Antenna DR	5716A639WB	200826-1	C	LF Antenna AS	5716A640WB	200826-2	D	LF Antenna INF	G8D-841M-ANT	200826-3	E	LF Antenna INR	G8D-841M-ANT	200826-4	F	LF Antenna T/G	G8D-841M-ANT	200826-5
Description of EUT and Support equipment																																																																				
No.	Item	Model number	Serial number																																																																	
A	ECU	R328E	10																																																																	
B	LF Antenna DR	841M-A	8637A525																																																																	
C	LF Antenna AS	841M-A	8637A525																																																																	
D	LF Antenna INF	841M-A	8637A525																																																																	
E	LF Antenna INR	841M-A	8637A525																																																																	
F	LF Antenna T/G	841M-A	8637A525																																																																	
Description of EUT and Support equipment																																																																				
No.	Item	Model number	Serial number																																																																	
A	KOS	R328E	#10																																																																	
B	LF Antenna DR	5716A639WB	200826-1																																																																	
C	LF Antenna AS	5716A640WB	200826-2																																																																	
D	LF Antenna INF	G8D-841M-ANT	200826-3																																																																	
E	LF Antenna INR	G8D-841M-ANT	200826-4																																																																	
F	LF Antenna T/G	G8D-841M-ANT	200826-5																																																																	
1	13487459H-B-R1	November 26, 2020	P.13	Correction of the calculation formula for 1GHz-6 GHz in Figure 2: Test Setup of SECTION 5; From: Distance Factor: $20 \times \log(3.7 \text{ m}^*/3.0 \text{ m}) = 0.83 \text{ dB}$ To: Distance Factor: $20 \times \log(3.3 \text{ m}^*/3.0 \text{ m}) = 0.83 \text{ dB}$																																																																
1	13487459H-B-R1	November 26, 2020	P.16	Addition of “EMI Test Receiver” (Local ID: MTR-09) in Test equipment list																																																																

Reference: Abbreviations (Including words undescribed in this report)

AAN	Asymmetric Artificial Network	ILAC	International Laboratory Accreditation Conference
AC	Alternating Current	ISED	Innovation, Science and Economic Development Canada
AM	Amplitude Modulation	ISN	Impedance Stabilization Network
AMN	Artificial Mains Network	ISO	International Organization for Standardization
Amp, AMP	Amplifier	JAB	Japan Accreditation Board
ANSI	American National Standards Institute	LAN	Local Area Network
Ant, ANT	Antenna	LCL	Longitudinal Conversion Loss
AP	Access Point	LIMS	Laboratory Information Management System
ASK	Amplitude Shift Keying	LISN	Line Impedance Stabilization Network
Atten., ATT	Attenuator	MRA	Mutual Recognition Arrangement
AV	Average	N/A	Not Applicable
BPSK	Binary Phase-Shift Keying	NIST	National Institute of Standards and Technology
BR	Bluetooth Basic Rate	NS	No signal detect.
BT	Bluetooth	NSA	Normalized Site Attenuation
BT LE	Bluetooth Low Energy	NVLAP	National Voluntary Laboratory Accreditation Program
BW	BandWidth	OBW	Occupied Band Width
C.F	Correction Factor	OFDM	Orthogonal Frequency Division Multiplexing
Cal Int	Calibration Interval	PK	Peak
CAV	CISPR AV	PLT	long-term flicker severity
CCK	Complementary Code Keying	POHC(A)	Partial Odd Harmonic Current
CDN	Coupling Decoupling Network	Pol., Pola.	Polarization
Ch., CH	Channel	PR-ASK	Phase Reversal ASK
CISPR	Comite International Special des Perturbations Radioelectriques	PT	short-term flicker severity
Corr.	Correction	QAM	Quadrature Amplitude Modulation
CPE	Customer premise equipment	QP	Quasi-Peak
CW	Continuous Wave	QPSK	Quadri-Phase Shift Keying
DBPSK	Differential BPSK	r.m.s., RMS	Root Mean Square
DC	Direct Current	RBW	Resolution Band Width
DET	Detector	RE	Radio Equipment
D-factor	Distance factor	REV	Reverse
Dmax	maximum absolute voltage change during an observation period	RF	Radio Frequency
DQPSK	Differential QPSK	RFID	Radio Frequency Identifier
DSSS	Direct Sequence Spread Spectrum	RSS	Radio Standards Specifications
EDR	Enhanced Data Rate	Rx	Receiving
e.i.r.p., EIRP	Equivalent Isotropically Radiated Power	SINAD	Ratio of (Signal + Noise + Distortion) to (Noise + Distortion)
EM clamp	Electromagnetic clamp	S/N	Signal to Noise ratio
EMC	ElectroMagnetic Compatibility	SA, S/A	Spectrum Analyzer
EMI	ElectroMagnetic Interference	SG	Signal Generator
EMS	ElectroMagnetic Susceptibility	SVSWR	Site-Voltage Standing Wave Ratio
EN	European Norm	THC(A)	Total Harmonic Current
e.r.p., ERP	Effective Radiated Power	THD(%)	Total Harmonic Distortion
EU	European Union	TR	Test Receiver
EUT	Equipment Under Test	Tx	Transmitting
Fac.	Factor	VBW	Video BandWidth
FCC	Federal Communications Commission	Vert.	Vertical
FHSS	Frequency Hopping Spread Spectrum	WLAN	Wireless LAN
FM	Frequency Modulation	xDSL	Generic term for all types of DSL technology (DSL: Digital Subscriber Line)
Freq.	Frequency		
FSK	Frequency Shift Keying		
Fund	Fundamental		
FWD	Forward		
GFSK	Gaussian Frequency-Shift Keying		
GNSS	Global Navigation Satellite System		
GPS	Global Positioning System		
Hori.	Horizontal		
ICES	Interference-Causing Equipment Standard		
I/O	Input/Output		
IEC	International Electrotechnical Commission		
IEEE	Institute of Electrical and Electronics Engineers		
IF	Intermediate Frequency		

UL Japan, Inc.

Ise EMC Lab.

4383-326 Asama-cho, Ise-shi, Mie-ken 516-0021 JAPAN

Telephone : +81 596 24 8999

Facsimile : +81 596 24 8124

CONTENTS	PAGE
SECTION 1: Customer information	5
SECTION 2: Equipment under test (EUT).....	5
SECTION 3: Test specification, procedures & results	7
SECTION 4: Operation of EUT during testing.....	10
SECTION 5: Radiated Emission.....	12
APPENDIX 1: Test data	14
Radiated Emission	14
APPENDIX 2: Test instruments	16
APPENDIX 3: Photographs of test setup.....	17
Radiated Emission	17
Worst Case Position.....	19

SECTION 1: Customer information

Company Name : NIDEC MOBILITY CORPORATION
Address : 6368, Nenjo-zaka, Okusa, Komaki-city, Aichi 485-802 Japan
Telephone Number : +81-568-78-6159
Facsimile Number : +81-568-78-7659
Contact Person : Kazushi Yamasaki

The information provided from the customer is as follows;

- Applicant, Type of EUT, Model Number of EUT, FCC ID on the cover and other relevant pages
- Operating/Test Mode(s) (Mode(s)) on all the relevant pages
- SECTION 1: Customer information
- SECTION 2: Equipment under test (EUT) other than the Receipt Date
- SECTION 4: Operation of EUT during testing

* The laboratory is exempted from liability of any test results affected from the above information in SECTION 2 and 4.

SECTION 2: Equipment under test (EUT)

2.1 Identification of EUT

Type : ECU of Keyless Operation System
Model Number : R328E
Serial Number : Refer to SECTION 4.2
Rating : DC 12.0 V
Receipt Date : August 28, 2020
Country of Mass-production : China
Condition : Production model
Modification : No Modification by the test lab

2.2 Product Description

Model: R328E (referred to as the EUT in this report) is a ECU of Keyless Operation System.
Keyless Operation System has the following radio functions: Immobilizer system and Smart System (LF Transmitting / UHF Receiving).

General Specification

Clock frequency (maximum) : UHF: 21.948717 MHz
Operating Temperature : -40 deg. C to +85 deg. C

UL Japan, Inc.

Ise EMC Lab.

4383-326 Asama-cho, Ise-shi, Mie-ken 516-0021 JAPAN

Telephone : +81 596 24 8999

Facsimile : +81 596 24 8124

Radio Specification

Immobilizer system function *

Equipment Type : Transceiver
Frequency of Operation : 125 kHz
Type of Modulation : ASK
Antenna Type : Coil Antenna

Smart System: LF Transmitting function *

Equipment Type : Transmitter
Frequency of Operation : 125 kHz
Type of Modulation : ASK
Antenna Type : Coil Antenna

Smart System: UHF Receiving function

Type of Receiver : Super Heterodyne
Receiving Frequency : 433.92 MHz
Oscillator Frequency : 21.948717 MHz
Local Oscillator Frequency : 434.194 MHz
Intermediate Frequency : 274 kHz
Antenna Type : $\lambda/4$ Monopole Antenna

*The test of these functions was performed separately from this test report, and the conformability is confirmed.

SECTION 3: Test specification, procedures & results

3.1 Test Specification

Test Specification : FCC Part 15 Subpart B
FCC Part 15 final revised on June 26, 2020 and effective July 27, 2020
Title : FCC 47CFR Part15 Radio Frequency Device
Subpart B Unintentional Radiators

3.2 Procedures and results

Item	Test Procedure	Limits	Deviation	Worst margin	Result	Remarks
Conducted emission	FCC: ANSI C63.4: 2014 7. AC power - line conducted emission measurements	FCC:Part 15 Subpart B 15.107(a)	N/A	N/A	N/A	*1)
	ISED: RSS-Gen 7.1	ISED: RSS-Gen 7.2				
Radiated emission	FCC: ANSI C63.4: 2014 8. Radiated emission measurements	FCC: Part 15 Subpart B 15.109(a)	N/A	15.3 dB 180.479 MHz, Horizontal, QP <Mode 1>	Complied a)	-
	ISED: RSS-Gen 7.1	ISED: RSS-Gen 7.3				
Antenna Terminal	FCC: ANSI C63.4: 2014 12. Measurement of unintentional radiators other than ITE	FCC: Part 15 Subpart B 15.111(a)	N/A	N/A	N/A	*2)
	ISED: - RSS-Gen 7.1	ISED: RSS-Gen 7.4				
<p>*Note: UL Japan, Inc's EMI Work Procedure 13-EM-W0420. *1) The test is not applicable since the EUT is not the device that is designed to be connected to the public utility (AC) power line. *2) The receiving antenna (of this EUT) is installed inside the EUT and cannot be removed (permanently attached). Therefore, Radiated emission test was performed.</p>						
<p>a) Refer to APPENDIX 1 (data of Radiated Emission)</p>						
<p>Symbols: Complied The data of this test item has enough margin, more than the measurement uncertainty. Complied# The data of this test item meets the limits unless the measurement uncertainty is taken into consideration.</p>						

3.3 Addition to standard

No addition, exclusion nor deviation has been made from the standard.

3.4 Uncertainty

There is no applicable rule of uncertainty in this applied standard. Therefore, the results are derived depending on whether or not laboratory uncertainty is applied.

The following uncertainties have been calculated to provide a confidence level of 95 % using a coverage factor $k = 2$.

Radiated emission

Measurement distance	Frequency range	Uncertainty (+/-)	
3 m	30 MHz to 200 MHz	(Horizontal)	4.8 dB
		(Vertical)	5.0 dB
	200 MHz to 1000 MHz	(Horizontal)	5.2 dB
		(Vertical)	6.3 dB
10 m	30 MHz to 200 MHz	(Horizontal)	4.8 dB
		(Vertical)	4.8 dB
	200 MHz to 1000 MHz	(Horizontal)	5.0 dB
		(Vertical)	5.0 dB
3 m	1 GHz to 6 GHz	4.9 dB	
	6 GHz to 18 GHz	5.2 dB	
1 m	10 GHz to 26.5 GHz	5.5 dB	
	26.5 GHz to 40 GHz	5.5 dB	
0.5 m	26.5 GHz to 40 GHz	5.5 dB	
10 m	1 GHz to 18 GHz	5.2 dB	

3.5 Test Location

UL Japan, Inc. Ise EMC Lab.

4383-326 Asama-cho, Ise-shi, Mie-ken 516-0021 JAPAN

Telephone: +81 596 24 8999, Facsimile: +81 596 24 8124

* A2LA Certificate Number: 5107.02/ FCC Test Firm Registration Number: 199967 / ISED Lab Company Number: 2973C

Test site	Width x Depth x Height (m)	Size of reference ground plane (m) / horizontal conducting plane	Other rooms	Maximum measurement distance
No.1 semi-anechoic chamber	19.2 x 11.2 x 7.7	7.0 x 6.0	No.1 Power source room	10 m
No.2 semi-anechoic chamber	7.5 x 5.8 x 5.2	4.0 x 4.0	-	3 m
No.3 semi-anechoic chamber	12.0 x 8.5 x 5.9	6.8 x 5.75	No.3 Preparation room	3 m
No.3 shielded room	4.0 x 6.0 x 2.7	N/A	-	-
No.4 semi-anechoic chamber	12.0 x 8.5 x 5.9	6.8 x 5.75	No.4 Preparation room	3 m
No.4 shielded room	4.0 x 6.0 x 2.7	N/A	-	-
No.5 semi-anechoic chamber	6.0 x 6.0 x 3.9	6.0 x 6.0	-	-
No.5 measurement room	6.4 x 6.4 x 3.0	6.4 x 6.4	-	-
No.6 shielded room	4.0 x 4.5 x 2.7	4.0 x 4.5	-	-
No.6 measurement room	4.75 x 5.4 x 3.0	4.75 x 4.15	-	-
No.7 shielded room	4.7 x 7.5 x 2.7	4.7 x 7.5	-	-
No.8 measurement room	3.1 x 5.0 x 2.7	3.1 x 5.0	-	-
No.9 measurement room	8.8 x 4.6 x 2.8	2.4 x 2.4	-	-
No.11 measurement room	6.2 x 4.7 x 3.0	4.8 x 4.6	-	-

* Size of vertical conducting plane (for Conducted Emission test) : 2.0 m x 2.0 m for No.1, No.2, No.3, and No.4 semi-anechoic chambers and No.3 and No.4 shielded rooms.

3.6 Test data, Test instruments, and Test set up

Refer to APPENDIX.

UL Japan, Inc.

Ise EMC Lab.

4383-326 Asama-cho, Ise-shi, Mie-ken 516-0021 JAPAN

Telephone : +81 596 24 8999

Facsimile : +81 596 24 8124

SECTION 4: Operation of EUT during testing

4.1 Operating Mode(s)

Mode	Remarks
1) Receiving mode (Rx) 433.92MHz	-
* EUT was set by the software as follows; Software: Radio Law Certification EU kazasi Version 35 FC E2	

*The test signal level was confirmed to be sufficient to stabilize the local oscillator of the EUT.

* It was confirmed by using checker that the EUT receives the signal from the transmitter (pair of EUT).

4.2 Configuration and peripherals

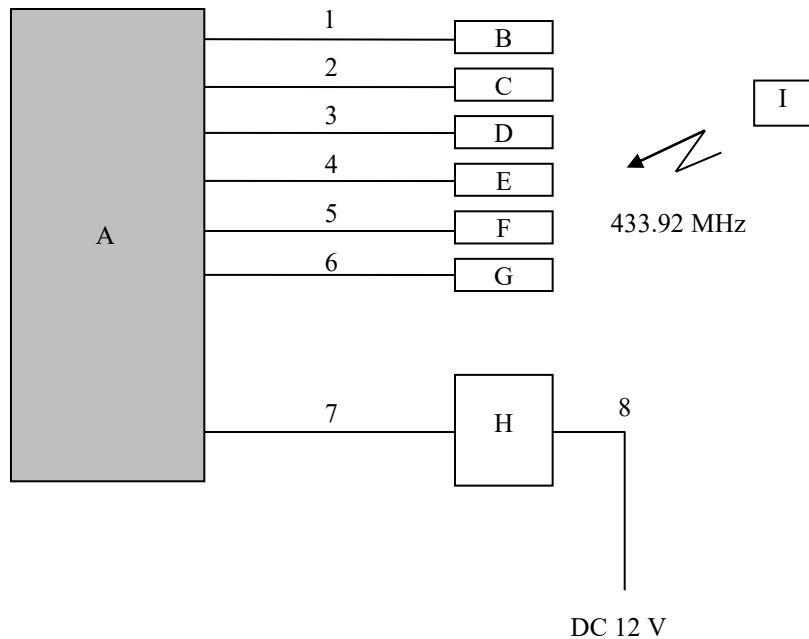

- * Cabling and setup(s) were taken into consideration and test data was taken under worse case conditions.
- * Item No. A includes Receiver Antenna.

Description of EUT and Support equipment

No.	Item	Model number	Serial number	Manufacturer	Remarks
A	KOS	R328E	#10	NIDEC MOBILITY CORPORATION	EUT
B	LF Antenna DR	5716A639WB	200826-1	NIDEC MOBILITY CORPORATION	-
C	LF Antenna AS	5716A640WB	200826-2	NIDEC MOBILITY CORPORATION	-
D	LF Antenna INF	G8D-841M-ANT	200826-3	NIDEC MOBILITY CORPORATION	-
E	LF Antenna INR	G8D-841M-ANT	200826-4	NIDEC MOBILITY CORPORATION	-
F	LF Antenna T/G	G8D-841M-ANT	200826-5	NIDEC MOBILITY CORPORATION	-
G	Push Switch	CFT-M001	2210D1	NIDEC MOBILITY CORPORATION	-
H	Jig	-	-	NIDEC MOBILITY CORPORATION	-
I	FOB	GHR-M014	23	NIDEC MOBILITY CORPORATION	-

List of cables used

No.	Name	Length (m)	Shield		Remark
			Cable	Connector	
1	Antenna Cable	2.3	Unshielded	Unshielded	-
2	Antenna Cable	2.3	Unshielded	Unshielded	-
3	Antenna Cable	2.3	Unshielded	Unshielded	-
4	Antenna Cable	2.3	Unshielded	Unshielded	-
5	Antenna Cable	2.3	Unshielded	Unshielded	-
6	Antenna Cable	2.3	Unshielded	Unshielded	-
7	DC & Signal Cable	3.0	Unshielded	Unshielded	-
8	DC Cable	3.0	Unshielded	Unshielded	-

UL Japan, Inc.

Ise EMC Lab.

4383-326 Asama-cho, Ise-shi, Mie-ken 516-0021 JAPAN

Telephone : +81 596 24 8999

Facsimile : +81 596 24 8124

SECTION 5: Radiated Emission

5.1 Operating environment

Test place : No.4 semi anechoic chamber
Temperature : See data
Humidity : See data

5.2 Test configuration

EUT was placed on a urethane platform of nominal size, 1.0 m by 1.5 m, raised 0.8 m above the conducting ground plane.

The EUT was set on the edge of the tabletop.

Test was made with the antenna positioned in both the horizontal and vertical planes of polarization. The measurement antenna was varied in height above the conducting ground plane to obtain the maximum signal strength.

Photographs of the set up are shown in Appendix 3.

5.3 Test conditions

Frequency range : 30 MHz - 200 MHz (Biconical antenna) / 200 MHz - 1000 MHz (Logperiodic antenna)
1000 MHz - 6000 MHz (Horn antenna)
Test distance : 3 m
EUT position : Table top
EUT operation mode : See Clause 4.1

5.4 Test procedure

The height of the measuring antenna varied between 1 and 4 m and EUT was rotated a full revolution in order to obtain the maximum value of the electric field intensity.

The measurements were performed for both vertical and horizontal antenna polarization with the Test Receiver

The radiated emission measurements were made with the following detector function of the Test Receiver

For above 1 GHz, test antenna was aimed at the EUT for receiving the maximum signal and always kept within the illumination area of the 3 dB beamwidth of the antenna.

Frequency	Below 1GHz	Above 1GHz *1)
Instrument used	Test Receiver	Test Receiver
IF Bandwidth	QP: BW 120 kHz	PK: BW 1 MHz, CISPR AV: BW 1 MHz

*1) The measurement data was adjusted to a 3 m distance using the following Distance Factor.
Distance Factor: See Figure 2.

Figure 2: Test Setup

Below 1 GHz

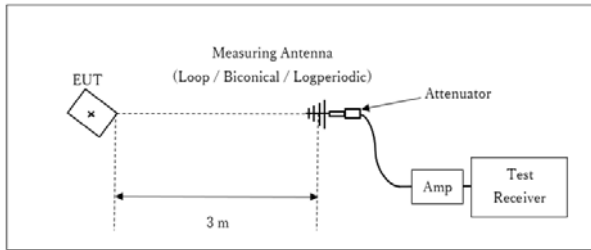

* : Center of turn table

Test Distance: 3 m

1 GHz - 6 GHz

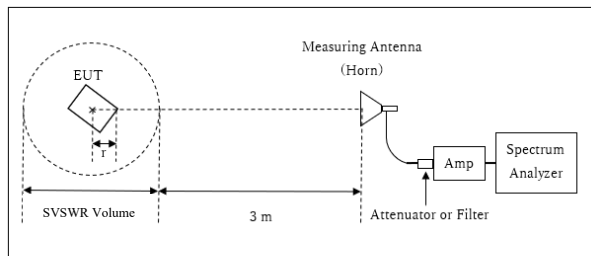

r : Radius of an outer periphery of EUT

* : Center of turn table

Distance Factor: $20 \times \log(3.3 \text{ m}^*/3.0 \text{ m}) = 0.83 \text{ dB}$
* Test Distance: $(3 + \text{SVSWR Volume} / 2) - r = 3.3 \text{ m}$

SVSWR Volume: 2 m
(SVSWR Volume has been calibrated based on CISPR 16-1-4.)
 $r = 0.7 \text{ m}$

- The noise levels were confirmed at each position of X, Y and Z axes of EUT to see the position of maximum noise, and the test was made at the position that has the maximum noise.

5.5 Test result

Summary of the test results: Pass

The limit is rounded down to one decimal place.

The test result is rounded off to one or two decimal places, so some differences might be observed.

Date: September 6, 2020

Test engineer: Ken Fujita

APPENDIX 1: Test data

Radiated Emission
(Below 1 GHz)

Report No. 13487459H
Test place Ise EMC Lab.
Semi Anechoic Chamber No.4
Date September 6, 2020
Temperature / Humidity 23 deg. C / 51 % RH
Engineer Ken Fujita
Mode Mode 1

Limit : FCC_Part 15 Subpart B(15.109)_Class B

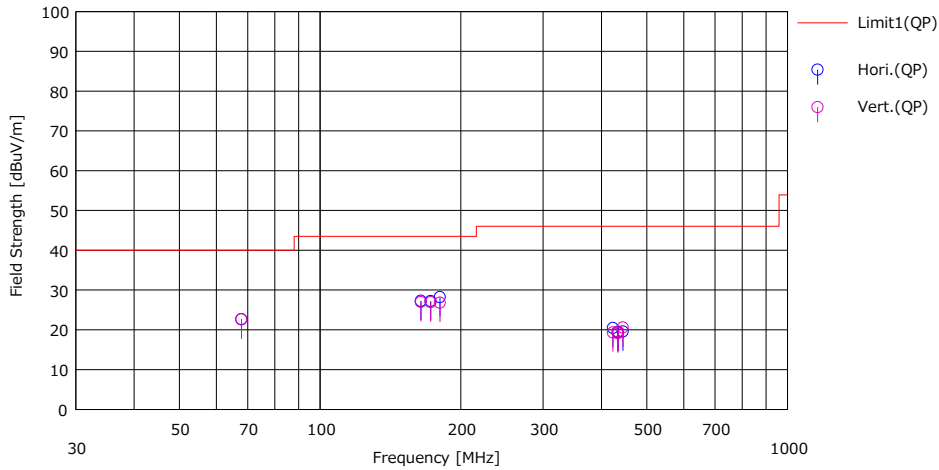

No.	Freq. [MHz]	Reading	Ant.Fac	Loss	Gain	Result	Limit	Margin	Pola.	Height	Angle	Ant. Type	Comment
		[dBUV]				[dBUV/m]	[dBUV/m]	[dBUV/m]					
1	67.845	34.60	8.92	7.72	28.57	22.67	40.00	17.3	Hori.	300	23	BA	
2	164.332	34.10	12.73	8.69	28.25	27.27	43.50	16.2	Hori.	300	240	BA	
3	172.413	33.50	13.16	8.75	28.20	27.21	43.50	16.2	Hori.	300	298	BA	
4	180.479	34.00	13.53	8.82	28.16	28.19	43.50	15.3	Hori.	100	2	BA	
5	423.220	22.50	16.17	10.49	28.74	20.42	46.00	25.5	Hori.	200	337	LA	
6	433.646	21.40	16.27	10.55	28.82	19.40	46.00	26.6	Hori.	200	29	LA	
7	434.194	21.40	16.28	10.56	28.82	19.42	46.00	26.5	Hori.	200	231	LA	
8	444.620	21.30	16.54	10.62	28.89	19.57	46.00	26.4	Hori.	200	32	LA	
9	67.845	34.50	8.92	7.72	28.57	22.57	40.00	17.4	Vert.	100	266	BA	
10	164.332	33.80	12.73	8.69	28.25	26.97	43.50	16.5	Vert.	200	342	BA	
11	172.413	33.20	13.16	8.75	28.20	26.91	43.50	16.5	Vert.	100	357	BA	
12	180.479	32.60	13.53	8.82	28.16	26.79	43.50	16.7	Vert.	100	6	BA	
13	423.220	21.40	16.17	10.49	28.74	19.32	46.00	26.6	Vert.	100	132	LA	
14	433.646	21.10	16.27	10.55	28.82	19.10	46.00	26.9	Vert.	100	357	LA	
15	434.194	21.50	16.28	10.56	28.82	19.52	46.00	26.4	Vert.	100	13	LA	
16	444.620	22.30	16.54	10.62	28.89	20.57	46.00	25.4	Vert.	200	2	LA	

CHART: WITH FACTOR

ANT TYPE: - 30 MHz: LOOP, 30 MHz - 200 MHz: BICONICAL, 200 MHz - 1000 MHz: LOGPERIODIC, 1000 MHz -: HORN

CALCULATION: RESULT = READING + ANT FACTOR + LOSS(CABLE + ATT) - GAIN(AMP)

Except for the above table: adequate margin data below the limits.

UL Japan, Inc.

Ise EMC Lab.

4383-326 Asama-cho, Ise-shi, Mie-ken 516-0021 JAPAN

Telephone : +81 596 24 8999

Facsimile : +81 596 24 8124

Radiated Emission (Above 1 GHz)

Report No. 13487459H
Test place Ise EMC Lab.
Semi Anechoic Chamber No.4
Date September 6, 2020
Temperature / Humidity 23 deg. C / 51 % RH
Engineer Ken Fujita
Mode Mode 1

Limit : FCC_Part 15 Subpart B(15.109)_Class B

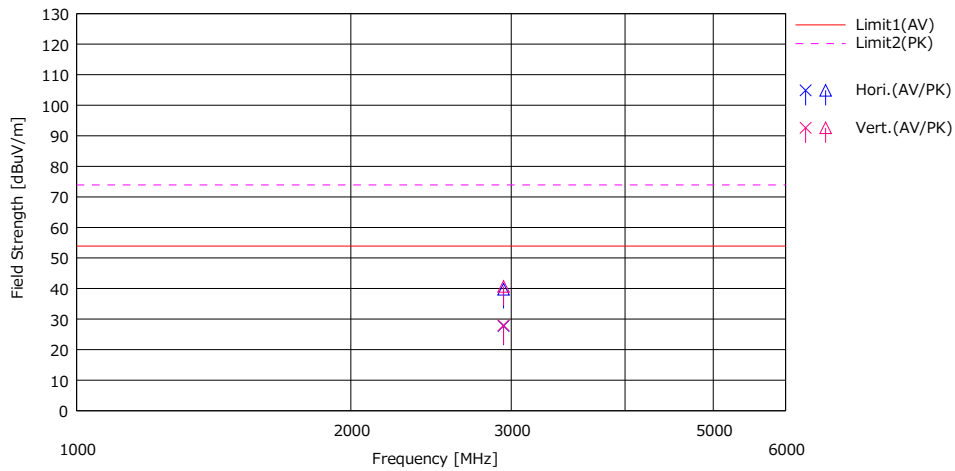

No.	Freq. [MHz]	Reading		Ant.Fac [dB/m]	Loss [dB]	Gain [dB]	Result		Limit		Margin		Pola. [H/V]	Height [cm]	Angle [deg]	Ant. Type	Comment
		(AV) [dBuV]	(PK) [dBuV]				(AV) [dBuV/m]	(PK) [dBuV/m]	(AV) [dBuV/m]	(PK) [dBuV/m]	(AV) [dB]	(PK) [dB]					
1	2942.861	28.20	40.20	28.47	3.62	32.50	27.79	39.79	53.90	73.90	26.11	34.11	Hori.	100	0	H20	
2	2942.861	28.40	41.10	28.47	3.62	32.50	27.99	40.69	53.90	73.90	25.91	33.21	Vert.	100	0	H20	

CHART: WITH FACTOR

ANT TYPE: - 30 MHz: LOOP, 30 MHz - 200 MHz: BICONICAL, 200 MHz - 1000 MHz: LOGPERIODIC, 1000 MHz -: HORN

CALCULATION: RESULT = READING + ANT FACTOR + LOSS(CABLE + D-factor) - GAIN(AMP)

Except for the above table: adequate margin data below the limits.

UL Japan, Inc.

Ise EMC Lab.

4383-326 Asama-cho, Ise-shi, Mie-ken 516-0021 JAPAN

Telephone : +81 596 24 8999

Facsimile : +81 596 24 8124

APPENDIX 2: Test instruments

Test equipment

Test Item	Local ID	LIMS ID	Description	Manufacturer	Model	Serial	Last Calibration Date	Cal Int
RE	MAEC-04	142011	AC4_Semi Anechoic Chamber(NSA)	TDK	Semi Anechoic Chamber 3m	DA-10005	05/25/2020	24
RE	MOS-15	141562	Thermo-Hygrometer	CUSTOM. Inc	CTH-201	0010	01/07/2020	12
RE	MMM-10	141545	DIGITAL HiTESTER	Hioki	3805	51201148	01/06/2020	12
RE	MJM-26	142227	Measure	KOMELON	KMC-36	-	-	-
RE	COTS-ME MI-02	178648	EMI measurement program	TSJ (Techno Science Japan)	TEPTO-DV	-	-	-
RE	MAEC-04-SVSWR	142017	AC4_Semi Anechoic Chamber(SVSWR)	TDK	Semi Anechoic Chamber 3m	DA-10005	04/04/2019	24
RE	MAT-34	141331	Attenuator(6dB)	TME	UFA-01	-	02/05/2020	12
RE	MBA-05	141425	Biconical Antenna	Schwarzbeck Mess - Elektronik	VHA9103+BBA9106	VHA 91031302	08/31/2020	12
RE	MCC-50	141397	Coaxial Cable	UL Japan	-	-	03/24/2020	12
RE	MLA-23	141267	Logperiodic Antenna (200-1000MHz)	Schwarzbeck Mess - Elektronik	VUSLP9111B	9111B-192	09/02/2020	12
RE	MPA-14	141583	Pre Amplifier	SONOMA INSTRUMENT	310	260833	02/18/2020	12
RE	MHA-21	141508	Horn Antenna 1-18GHz	Schwarzbeck Mess - Elektronik	BBHA9120D	557	05/22/2020	12
RE	MPA-12	141581	MicroWave System Amplifier	Keysight Technologies Inc	83017A	650	10/16/2019	12
RE	MCC-141	141412	Microwave Cable	Junkosha	MWX221	1305S002R(1m) / 1405S146(5m)	-	-
RE	MTR-09	141950	EMI Test Receiver	Rohde & Schwarz	ESU26	100412	2020/06/03	12

*Hyphens for Last Calibration Date and Cal Int (month) are instruments that Calibration is not required (e.g. software), or instruments checked in advance before use.

The expiration date of the calibration is the end of the expired month.

As for some calibrations performed after the tested dates, those test equipment have been controlled by means of an unbroken chains of calibrations.

All equipment is calibrated with valid calibrations. Each measurement data is traceable to the national or international standards.

Test item:

RE: Radiated emission

UL Japan, Inc.

Ise EMC Lab.

4383-326 Asama-cho, Ise-shi, Mie-ken 516-0021 JAPAN

Telephone : +81 596 24 8999

Facsimile : +81 596 24 8124