



RADIO TEST REPORT

Test Report No. : 12266560H-R1

Applicant : OMRON Automotive Electronics Co. Ltd.
Type of Equipment : Immobilizer
Model No. : I54P0
FCC ID : OUCI54P0
Test regulation : FCC Part 15 Subpart C: 2018
Test Result : Complied

1. This test report shall not be reproduced in full or partial, without the written approval of UL Japan, Inc.
2. The results in this report apply only to the sample tested.
3. This sample tested is in compliance with above regulation.
4. The test results in this report are traceable to the national or international standards.
5. This test report covers Radio technical requirements. It does not cover administrative issues such as Manual or non-Radio test related Requirements. (if applicable)
6. The all test items in this test report are conducted by UL Japan, Inc. Ise EMC Lab.
7. This test report must not be used by the customer to claim product certification, approval, or endorsement by NVLAP, NIST, or any agency of the Federal Government.
8. This report is a revised version of 12266560H. 12266560H is replaced with this report.

Date of test: May 14 and 16, 2018

Representative test engineer:

Hiroyuki Furutaka
Engineer
Consumer Technology Division

Approved by:

Shinichi Miyazono
Engineer
Consumer Technology Division



This laboratory is accredited by the NVLAP LAB CODE 200572-0, U.S.A. The tests reported herein have been performed in accordance with its terms of accreditation.
*As for the range of Accreditation in NVLAP, you may refer to the WEB address,
http://japan.ul.com/resources/emc_accredited/

- The testing in which "Non-accreditation" is displayed is outside the accreditation scopes in UL Japan.
 There is no testing item of "Non-accreditation".

UL Japan, Inc.
Ise EMC Lab.

4383-326 Asama-cho, Ise-shi, Mie-ken 516-0021 JAPAN
Telephone : +81 596 24 8999
Facsimile : +81 596 24 8124

CONTENTS	PAGE
SECTION 1: Customer information	4
SECTION 2: Equipment under test (E.U.T.).....	4
SECTION 3: Test specification, procedures & results	5
SECTION 4: Operation of E.U.T. during testing.....	8
SECTION 5: Radiated emission (Fundamental and Spurious Emission).....	9
SECTION 6: -26dB Bandwidth.....	11
SECTION 7: 99% Occupied Bandwidth.....	11
APPENDIX 1: Test data	12
Radiated Emission below 30 MHz (Fundamental and Spurious Emission)	12
Radiated Emission above 30MHz (Spurious Emission).....	14
-26dB Bandwidth and 99% Occupied Bandwidth	15
APPENDIX 2: Test instruments	16
APPENDIX 3: Photographs of test setup.....	17
Radiated Emission.....	17
Worst case position	19

UL Japan, Inc.

Ise EMC Lab.

4383-326 Asama-cho, Ise-shi, Mie-ken 516-0021 JAPAN

Telephone : +81 596 24 8999

Facsimile : +81 596 24 8124

SECTION 1: Customer information

Company Name : OMRON Automotive Electronics Co. Ltd.
Address : 6368 NENJOZAKA OKUSA KOMAKI AICHI, 485-0802 JAPAN
Telephone Number : +81-568-78-6159
Facsimile Number : +81-568-78-7659
Contact Person : Takashi Betsui

SECTION 2: Equipment under test (E.U.T.)

2.1 Identification of E.U.T.

Type of Equipment : Immobilizer
Model No. : I54P0
Serial No. : Refer to Clause 4.2
Rating : DC 12.0 V
Receipt Date of Sample : May 9, 2018
Country of Manufacture : China
Condition of EUT : Production model
Modification of EUT : No Modification by the test lab

2.2 Product Description

Model: I54P0 (referred to as the EUT in this report) is a Immobilizer.

Radio Specification

Radio Type : Transceiver
Frequency of Operation : 125 kHz
Modulation : ASK
Antenna type : Coil Antenna (built-in)
Clock Frequency (maximum) : 8 MHz

UL Japan, Inc.

Ise EMC Lab.

4383-326 Asama-cho, Ise-shi, Mie-ken 516-0021 JAPAN

Telephone : +81 596 24 8999

Facsimile : +81 596 24 8124

SECTION 3: Test specification, procedures & results

3.1 Test Specification

Test Specification : FCC Part 15 Subpart C
FCC Part 15 final revised on March 12, 2018 and effective April 11, 2018

Title : FCC 47CFR Part15 Radio Frequency Device Subpart C Intentional Radiators
Section 15.207 Conducted limits
Section 15.209 Radiated emission limits; general requirements.

3.2 Procedures and results

No.	Item	Test Procedure	Specification	Remarks	Deviation	Worst margin	Results
1	Conducted Emission	<FCC> ANSI C63.10:2013 6 Standard test methods <IC> RSS-Gen 8.8	<FCC> Section 15.207 <IC> RSS-Gen 8.8	-	N/A	N/A	N/A
2	Electric Field Strength of Fundamental Emission	<FCC> ANSI C63.10:2013 6 Standard test methods <IC> RSS-Gen 6.4, 6.12	<FCC> Section 15.209 <IC> RSS-210 4.4 RSS-Gen 8.9	Radiated	N/A	21.0 dB 0.12500 MHz 0 deg., PK with Duty factor	Complied
3	Electric Field Strength of Spurious Emission	<FCC> ANSI C63.10:2013 6 Standard test methods <IC> RSS-Gen 6.4, 6.13	<FCC> Section 15.209 <IC> RSS-210 4.4 RSS-Gen 8.9	Radiated	N/A	15.9 dB 212.000 MHz Vertical, QP	Complied
4	-26dB Bandwidth	<FCC> ANSI C63.10:2013 6 Standard test methods <IC> -	<FCC> Reference data <IC> -	Radiated	N/A	N/A	N/A

Note: UL Japan, Inc.'s EMI Work Procedures No. 13-EM-W0420 and 13-EM-W0422.

*1) The test is not applicable since the EUT is not the device that is designed to be connected to the public utility (AC) power line.

FCC 15.31 (e)

This EUT provides stable voltage constantly to RF Module regardless of input voltage. Therefore, this EUT complies with the requirement.

FCC Part 15.203 Antenna requirement

It is impossible for end users to replace the antenna, because the antenna is mounted inside of the EUT. Therefore, the equipment complies with the antenna requirement of Section 15.203.

UL Japan, Inc.

Ise EMC Lab.

4383-326 Asama-cho, Ise-shi, Mie-ken 516-0021 JAPAN

Telephone : +81 596 24 8999

Facsimile : +81 596 24 8124

3.3 Addition to standard

No.	Item	Test Procedure	Specification	Remarks	Deviation	Worst margin	Results
1	99 % Occupied Band Width	RSS-Gen 6.6	-	Radiated	N/A	N/A	N/A

Other than above, no addition, exclusion nor deviation has been made from the standard.

3.4 Uncertainty

EMI

The following uncertainties have been calculated to provide a confidence level of 95% using a coverage factor $k=2$.

Test distance	Radiated emission (+/-)
	9 kHz to 30 MHz
3 m	3.8 dB
10 m	3.6 dB

*Measurement distance

Polarity	Radiated emission (Below 1 GHz)			
	(3 m*)(+/-)		(10 m*)(+/-)	
	30 MHz to 200 MHz	200 MHz to 1000 MHz	30 MHz to 200 MHz	200 MHz to 1000 MHz
Horizontal	4.8 dB	5.2 dB	4.8 dB	5.0 dB
Vertical	5.0 dB	6.3 dB	4.9 dB	5.0 dB

Radiated emission test(3 m)

The data listed in this test report has enough margin, more than the site margin.

3.5 Test Location

UL Japan, Inc. Ise EMC Lab.
4383-326 Asama-cho, Ise-shi, Mie-ken 516-0021 JAPAN
Telephone: +81 596 24 8999, Facsimile: +81 596 24 8124
NVLAP Lab. code: 200572-0 / FCC Test Firm Registration Number: 199967

Test site	IC Registration Number	Width x Depth x Height (m)	Size of reference ground plane (m) / horizontal conducting plane	Other rooms	Maximum measurement distance
No.1 semi-anechoic chamber	2973C-1	19.2 x 11.2 x 7.7	7.0 x 6.0	No.1 Power source room	10 m
No.2 semi-anechoic chamber	2973C-2	7.5 x 5.8 x 5.2	4.0 x 4.0	-	3 m
No.3 semi-anechoic chamber	2973C-3	12.0 x 8.5 x 5.9	6.8 x 5.75	No.3 Preparation room	3 m
No.3 shielded room	-	4.0 x 6.0 x 2.7	N/A	-	-
No.4 semi-anechoic chamber	2973C-4	12.0 x 8.5 x 5.9	6.8 x 5.75	No.4 Preparation room	3 m
No.4 shielded room	-	4.0 x 6.0 x 2.7	N/A	-	-
No.5 semi-anechoic chamber	-	6.0 x 6.0 x 3.9	6.0 x 6.0	-	-
No.6 shielded room	-	4.0 x 4.5 x 2.7	4.0 x 4.5	-	-
No.6 measurement room	-	4.75 x 5.4 x 3.0	4.75 x 4.15	-	-
No.7 shielded room	-	4.7 x 7.5 x 2.7	4.7 x 7.5	-	-
No.8 measurement room	-	3.1 x 5.0 x 2.7	N/A	-	-
No.9 measurement room	-	8.8 x 4.6 x 2.8	2.4 x 2.4	-	-
No.11 measurement room	-	6.2 x 4.7 x 3.0	4.8 x 4.6	-	-

* Size of vertical conducting plane (for Conducted Emission test) : 2.0 m x 2.0m for No.1, No.2, No.3, and No.4 semi-anechoic chambers and No.3 and No.4 shielded rooms.

3.6 Test data, Test instruments, and Test set up

Refer to APPENDIX.

SECTION 4: Operation of E.U.T. during testing

4.1 Operating Modes

Test mode	Remarks
Transmitting mode	-

Justification : The system was configured in typical fashion (as a user would normally use it) for testing.

4.2 Configuration and peripherals

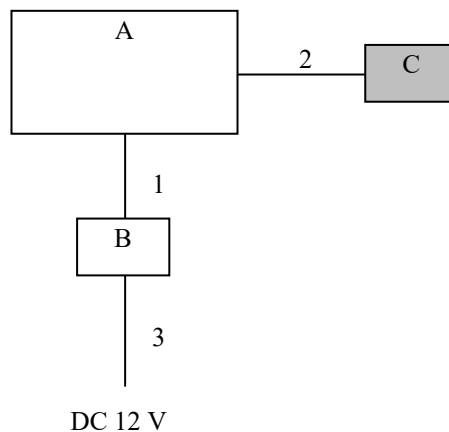

* Cabling and setup were taken into consideration and test data was taken under worse case conditions.

Description of EUT and Support equipment

No.	Item	Model number	Serial number	Manufacturer	Remark
A	Body Control Module	S54P0	S54YFA-180510-001	OMRON Automotive Electronics Co. Ltd.	-
B	Switch and Load Board	-	-	-	-
C	Immobilizer	I54P0	I54-180510-001	OMRON Automotive Electronics Co. Ltd.	EUT

List of cables used

No.	Name	Length (m)	Shield		Remark
			Cable	Connector	
1	DC & Signal Cable	2.4	Unshielded	Unshielded	-
2	DC & Signal Cable	2.4	Unshielded	Unshielded	-
3	DC Cable	2.0	Unshielded	Unshielded	-

UL Japan, Inc.

Ise EMC Lab.

4383-326 Asama-cho, Ise-shi, Mie-ken 516-0021 JAPAN

Telephone : +81 596 24 8999

Facsimile : +81 596 24 8124

SECTION 5: Radiated emission (Fundamental and Spurious Emission)

Test Procedure

EUT was placed on a urethane platform of nominal size, 0.5 m by 1.0 m, raised 0.8 m above the conducting ground plane.

The Radiated Electric Field Strength has been measured in a Semi Anechoic Chamber with a ground plane.

Frequency : From 9 kHz to 30 MHz

The EUT was rotated a full revolution in order to obtain the maximum value of the electric field intensity.

The measurements were performed for vertical polarization (antenna angle: 0 deg., 45 deg., 90 deg., and 135 deg.) and horizontal polarization.

*Refer to Figure 1 about Direction of the Loop Antenna.

Frequency: From 30 MHz to 1 GHz

The measuring antenna height varied between 1 and 4 m and EUT was rotated a full revolution in order to obtain the maximum value of the electric field intensity.

The measurements were performed for both vertical and horizontal antenna polarization.

The test was made with the detector (RBW / VBW) in the following table.

When using Spectrum analyzer, the test was made with adjusting span to zero by using peak hold.

Test Antennas are used as below;

Frequency	Below 30 MHz	30 MHz to 200 MHz	200 MHz to 1 GHz
Antenna Type	Loop	Biconical	Logperiodic

Frequency	From 9 kHz to 90 kHz and From 110 kHz to 150 kHz	From 90 kHz to 110 kHz	From 150 kHz to 490 kHz	From 490 kHz to 30 MHz	From 30 MHz to 1 GHz
Instrument used	Test Receiver				
Detector	PK / AV	QP	PK / AV	QP	QP
IF Bandwidth	200 Hz	200 Hz	9 kHz	9 kHz	120 kHz
Test Distance	3 m *1)	3 m *1)	3 m *1)	3 m *2)	3 m

*1) Distance Factor: $40 \times \log(3 \text{ m} / 300 \text{ m}) = -80 \text{ dB}$

*2) Distance Factor: $40 \times \log(3 \text{ m} / 30 \text{ m}) = -40 \text{ dB}$

Although these tests were performed other than open field test site, adequate comparison measurements were confirmed against 30 m open field test site. Therefore sufficient tests were made to demonstrate that the alternative site produces results that correlate with the ones of tests made in an open field based on KDB 414788.

These tests were performed in semi anechoic chamber. Therefore the measured level of emissions may be higher than if measurements were made without a ground plane.

However test results were confirmed to pass against standard limit.

- The carrier level and noise levels were confirmed at each position of X, Y and Z axes of EUT to see the position of maximum noise, and the test was made at the position that has the maximum noise.

This EUT has two modes which Mechanical key is inserted or not. The worst case was confirmed with and without Mechanical key, as a result, the test without Mechanical key was the worst case. Therefore the test without Mechanical key was performed only.

The test results and limit are rounded off to one decimal place, so some differences might be observed.

UL Japan, Inc.

Ise EMC Lab.

4383-326 Asama-cho, Ise-shi, Mie-ken 516-0021 JAPAN

Telephone : +81 596 24 8999

Facsimile : +81 596 24 8124

Measurement range : 9 kHz - 1 GHz
Test data : APPENDIX 1
Test result : Pass

Date: May 14 and 16, 2018

Test engineer:

Hiroyuki Furutaka

Figure 1: Direction of the Loop Antenna

Side View (Vertical)

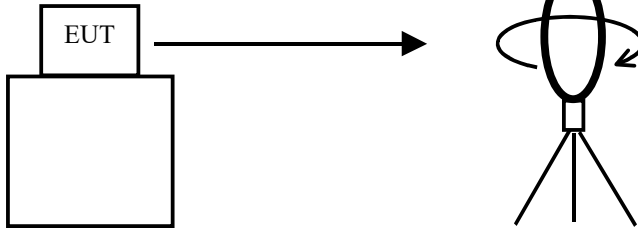

Top View (Horizontal)

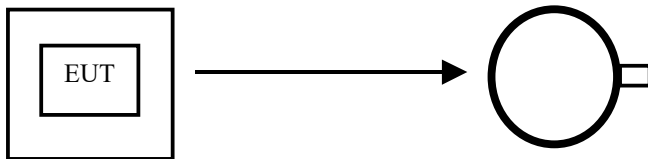

Antenna was not rotated.

Top View (Vertical)

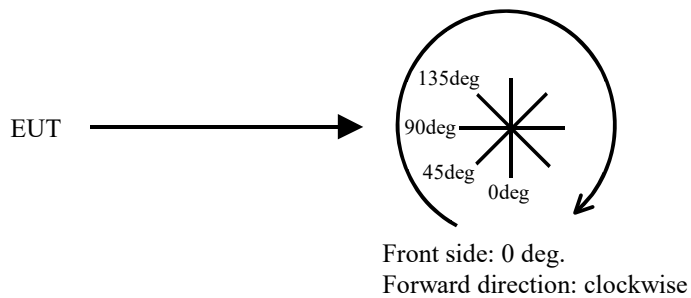

SECTION 6: -26dB Bandwidth

Test Procedure

The test was measured with a spectrum analyzer using a test fixture.

Test	Span	RBW	VBW	Sweep	Detector	Trace	Instrument used
-26 dB Bandwidth	100 kHz	1 kHz	3 kHz	Auto	Peak	Max Hold	Spectrum Analyzer

Test data : APPENDIX 1
Test result : Pass

SECTION 7: 99% Occupied Bandwidth

Test Procedure

The test was measured with a spectrum analyzer using a test fixture.

Test	Span	RBW	VBW	Sweep	Detector	Trace	Instrument used
99 % Occupied Bandwidth	Enough width to display emission skirts	1 to 5 % of OBW	Three times of RBW	Auto	Peak	Max Hold	Spectrum Analyzer
Peak hold was applied as Worst-case measurement.							

Test data : APPENDIX 1
Test result : Pass

APPENDIX 1: Test data

Radiated Emission below 30 MHz (Fundamental and Spurious Emission)

Test place : Ise EMC Lab. No.2 Semi Anechoic Chamber
Order No. : 12266560H
Date : 05/14/2018
Temperature/ Humidity : 23 deg. C / 51 % RH
Engineer : Hiroyuki Furutaka
Mode : Tx 125kHz

PK or QP

Ant Deg [deg]	Frequency [MHz]	Detector	Reading [dBuV]	Ant Factor [dB/m]	Loss [dB]	Gain [dB]	Duty Factor [dB]	Result [dBuV/m]	Limit [dBuV/m]	Margin [dB]	Remark
0	0.12500	PK	90.9	19.8	-73.9	32.2	-	4.6	45.6	41.0	Fundamental
0	0.25000	PK	67.2	19.7	-73.9	32.2	-	-19.2	39.6	58.8	
0	0.37500	PK	53.7	19.7	-73.9	32.2	-	-32.7	36.1	68.8	
0	0.50000	QP	32.3	19.7	-33.9	32.1	-	-14.0	33.6	47.6	
0	0.62500	QP	42.6	19.7	-33.9	32.2	-	-3.8	31.7	35.5	
0	0.75000	QP	37.4	19.7	-33.8	32.2	-	-8.9	30.1	39.0	
0	0.87500	QP	37.9	19.7	-33.8	32.2	-	-8.4	28.7	37.1	
0	1.00000	QP	30.7	19.7	-33.8	32.2	-	-15.6	27.6	43.2	

Result = Reading + Ant Factor + Loss (Cable + Attenuator + D.Factor) - Gain(Amplifier)

PK with Duty factor

Ant Deg [deg]	Frequency [MHz]	Detector	Reading [dBuV]	Ant Factor [dB/m]	Loss [dB]	Gain [dB]	Duty Factor [dB]	Result [dBuV/m]	Limit [dBuV/m]	Margin [dB]	Remark
0	0.12500	PK	90.9	19.8	-73.9	32.2	0.0	4.6	25.6	21.0	
0	0.25000	PK	67.2	19.7	-73.9	32.2	0.0	-19.2	19.6	38.8	
0	0.37500	PK	53.7	19.7	-73.9	32.2	0.0	-32.7	16.1	48.8	

Result = Reading + Ant Factor + Loss (Cable + Attenuator + D.Factor) - Gain(Amplifier) + Duty factor *

* Since the peak emission result satisfied the average limit, duty factor was omitted.

Result of the fundamental emission at 3m without Distance factor

PK or QP

Ant Deg [deg]	Frequency [MHz]	Detector	Reading [dBuV]	Ant Factor [dB/m]	Loss [dB]	Gain [dB]	Duty Factor [dB]	Result [dBuV/m]	Limit [dBuV/m]	Margin [dB]	Remark
0	0.12500	PK	90.9	19.8	6.1	32.2	-	84.6	-	-	Fundamental

Result = Reading + Ant Factor + Loss (Cable+Attenuator+Filter) - Gain(Amplifier)

* All spurious emissions lower than this result.

*The test result is rounded off to one or two decimal places, so some differences might be observed.

UL Japan, Inc.

Ise EMC Lab.

4383-326 Asama-cho, Ise-shi, Mie-ken 516-0021 JAPAN

Telephone : +81 596 24 8999

Facsimile : +81 596 24 8124

Radiated Emission below 30 MHz (Fundamental and Spurious Emission)
(Plot data, Worst case)

Test place Ise EMC Lab. No.2 Semi Anechoic Chamber
Order No. 12266560H
Date 05/14/2018
Temperature/ Humidity 23 deg. C / 51 % RH
Engineer Hiroyuki Furutaka
Mode Tx 125kHz

LIMIT : FCC15.209(a), 9-90kHz:PK, 110-490kHz:PK, other:QP
FCC15.209(a), 9-90kHz:AV, 110-490kHz:AV, other:QP

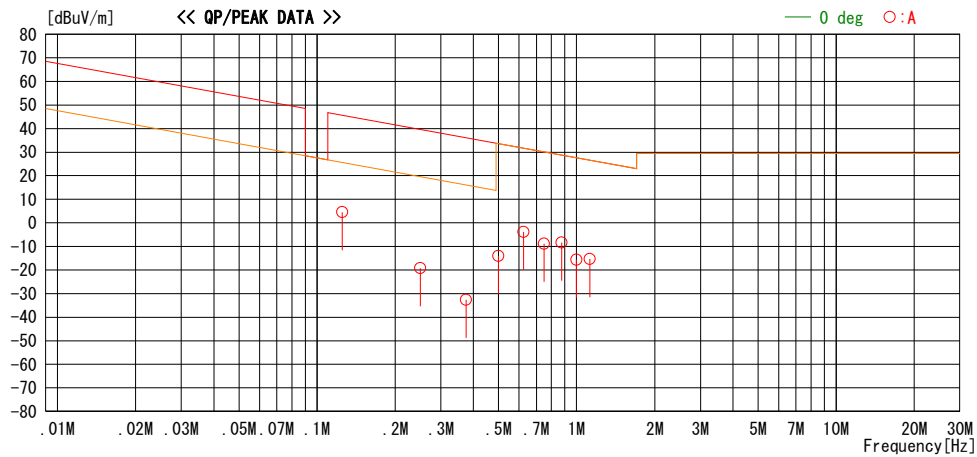

*These plots data contains sufficient number to show the trend of characteristic features for EUT.

Radiated Emission above 30MHz (Spurious Emission)

Test place : Ise EMC Lab. No.4 Semi Anechoic Chamber
Order No. : 12266560H
Date : 05/16/2018
Temperature/ Humidity : 23 deg. C / 45 % RH
Engineer : Hiroyuki Furutaka
Mode : Tx 125kHz

LIMIT : FCC15.209 3m, below 1GHz:QP, above 1GHz:AV
All other spurious emissions were less than 20dB for the limit.

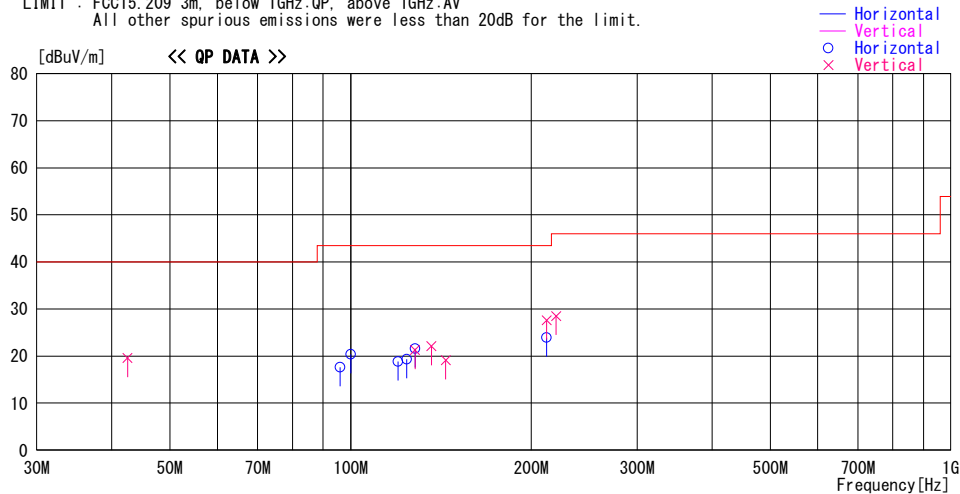

Frequency [MHz]	Reading [dBuV]	DET	Antenna		Level [dBuV/m]	Angle [Deg]	Height [cm]	Polar.	Limit [dBuV/m]	Margin [dB]	Comment
			Factor [dB/m]	Loss& Gain [dB]							
42.496	30.8	QP	13.5	-24.7	19.6	196	100	Vert.	40.0	20.4	
96.000	32.1	QP	9.5	-24.0	17.6	9	306	Hori.	43.5	25.9	
100.008	34.2	QP	10.2	-24.0	20.4	5	300	Hori.	43.5	23.1	
120.000	29.6	QP	12.9	-23.7	18.8	356	280	Hori.	43.5	24.7	
124.000	29.8	QP	13.2	-23.7	19.3	168	297	Hori.	43.5	24.2	
128.000	31.3	QP	13.6	-23.6	21.3	359	100	Vert.	43.5	22.2	
128.000	31.6	QP	13.6	-23.6	21.6	211	231	Hori.	43.5	21.9	
136.293	31.5	QP	14.2	-23.6	22.1	286	100	Vert.	43.5	21.4	
143.980	27.7	QP	14.8	-23.4	19.1	324	100	Vert.	43.5	24.4	
212.000	38.9	QP	11.5	-22.8	27.6	359	100	Vert.	43.5	15.9	
212.000	35.2	QP	11.5	-22.8	23.9	66	181	Hori.	43.5	19.6	
219.984	39.6	QP	11.6	-22.7	28.5	54	100	Vert.	46.0	17.5	

CHART: WITH FACTOR

ANT TYPE: - 30 MHz: LOOP, 30 MHz - 200 MHz: BICONICAL, 200 MHz - 1000 MHz: LOGPERIODIC, 1000 MHz -: HORN
CALCULATION: RESULT = READING + ANT FACTOR + LOSS & GAIN (CABLE + ATT - GAIN(AMP))

*The test result is rounded off to one or two decimal places, so some differences might be observed.

-26dB Bandwidth and 99% Occupied Bandwidth

Test place	Ise EMC Lab. No.2 Semi Anechoic Chamber
Order No.	12266560H
Date	05/14/2018
Temperature/ Humidity	23 deg. C / 51 % RH
Engineer	Hiroyuki Furutaka
Mode	Tx 125kHz

Frequency [kHz]	-26dB Bandwidth [kHz]	99% Occupied Bandwidth [kHz]
125	9.778	11.6808

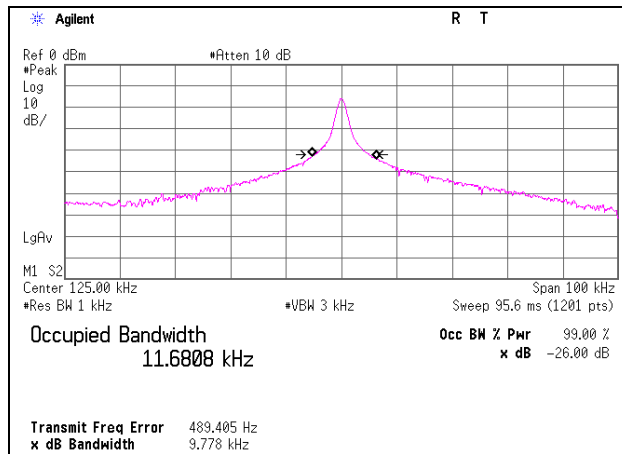

APPENDIX 2: Test instruments

Test equipment

Test item	LIMS ID	Description	Manufacturer	Model	Serial	Last Calibration Date	Calibration Due Date	Cal Int
RE	141885	Spectrum Analyzer	AGILENT	E4448A	US44300523	11/14/2017	11/30/2018	12
RE	141942	Test Receiver	Rohde & Schwarz	ESCI	100300	8/21/2017	8/31/2018	12
RE	142004	AC2_Semi Anechoic Chamber(NSA)	TDK	Semi Anechoic Chamber 3m	DA-06902	8/31/2017	8/31/2018	12
RE	141583	Pre Amplifier	SONOMA INSTRUMENT	11/5/1900	260833	2/27/2018	2/28/2019	12
RE	142182	Measure	KOMELON	KMC-36	-	-	-	-
RE	141254	Loop Antenna	Rohde & Schwarz	HFH2-Z2	100017	10/11/2017	10/31/2018	12
RE	141152	EMI measurement program	TSJ	TEPTO-DV	-	-	-	-
RE	141542	Digital Tester	Fluke Corporation	FLUKE 26-3	78030611	8/7/2017	8/31/2018	12
RE	141413	Coaxial Cable	UL Japan	-	-	6/12/2017	6/30/2018	12
RE	141222	Coaxial Cable	FUJIKURA	3D-2W(12m)/ 5D-2W(5m)/ 5D-2W(0.8m)/5	-	2/23/2018	2/28/2019	12
RE	141556	Thermo-Hygrometer	CUSTOM	CTH-201	0003	12/21/2017	12/31/2018	12
RE	141203	Attenuator(6dB)	Weinschel Corp	2	BK7970	11/14/2017	11/30/2018	12
RE	141562	Thermo-Hygrometer	CUSTOM	CTH-180	1501	1/24/2018	1/31/2019	12
RE	142011	AC4_Semi Anechoic Chamber(NSA)	TDK	Semi Anechoic Chamber 3m	DA-10005	10/30/2017	10/31/2018	12
RE	142227	Measure	KOMELON	KMC-36	-	-	-	-
RE	141267	Logperiodic Antenna(200-1000MHz)	Schwarzbeck	VUSLP9111B	911B-192	12/10/2017	12/31/2018	12
RE	148898	Attenuator	KEYSIGHT	8491A	MY52462282	10/12/2017	10/31/2018	12
RE	141951	EMI Test Receiver	Rohde & Schwarz	ESR26	101408	1/30/2018	1/31/2019	12
RE	141545	DIGITAL HiTESTER	HIOKI	3805	51201148	1/9/2018	1/31/2019	12
RE	141397	Coaxial Cable	UL Japan	-	-	6/22/2017	6/30/2018	12
RE	141425	Biconical Antenna	Schwarzbeck	BBA9106	1302	11/23/2017	11/30/2018	12

*Hyphens for Last Calibration Date, Calibration Due Date and Cal Int (month) are instruments that Calibration is not required (e.g. software), or instruments checked in advance before use.

The expiration date of the calibration is the end of the expired month.

All equipment is calibrated with valid calibrations. Each measurement data is traceable to the national or international standards.

As for some calibrations performed after the tested dates, those test equipment have been controlled by means of an unbroken chains of calibrations.

Test item:

RE: Spurious emission

UL Japan, Inc.

Ise EMC Lab.

4383-326 Asama-cho, Ise-shi, Mie-ken 516-0021 JAPAN

Telephone : +81 596 24 8999

Facsimile : +81 596 24 8124