

OMRON

G8D-382H-A

Transmitter, RF Keyless Entry System





<As for the undermentioned product,the amount of SW is different by the same circuit>

【Product No.】	【Function of SW】	【Amount of SW】
G8D-382H-A-NT	LOCK,UNLOCK	2SW

Table of contents

1.	Constitution of the Radio Frequency Keyless Entry system with Door Lock Controller for vehicle	1
2.	User's manual (provisionally)	2
3.	Block diagram	3
4.	Specification	4
5.	Features	5
6.	PCB	6
6.1	Circuit diagram	6
6.2	Parts layout	7
6.3	Pattern layout	9
6.4	Parts list	11
7.	Photographs	13

Rough sketch

	G8D-382H-A	G8D-382H-A-NT		
Module				
Assy				

1. Constitution of the Radio Frequency Keyless Entry System with Door Lock Controller for vehicle

The radio frequency keyless entry is a system that it controls locking and unlocking the door by wireless remote controller. This system consists of two components. The TRANSMITTER is a device that transmits the signal when the button is pressed. The transmission signal consists of several synchronous codes, unique identification code, and security code and function code. The RECEIVER is fixed inside the vehicle. It works intermittently to prevent the battery exhaustion. When the receiver detects the synchronous code, it runs continuously to receive the signals completely. After receiving the signal, the receiver decides which operation will be performed. The user can select the following operations by pressing the button of the remote transmitter.

OPERATION	ACTION
LOCK	Lock the door
UNLOCK	Unlock the door (Open the window)
BOOT RELEASE	Release the boot

This receiver also controls wired operation. When the key is in the driver's side key cylinder, all doors will Unlock if the key is turned to UNLOCK and hold more than one second. In case of the operation time is shorter, the only driver's side door is mechanically unlocked. It is also available to control the door lock status by using the remote door control switch(both driver's and passenger's side)

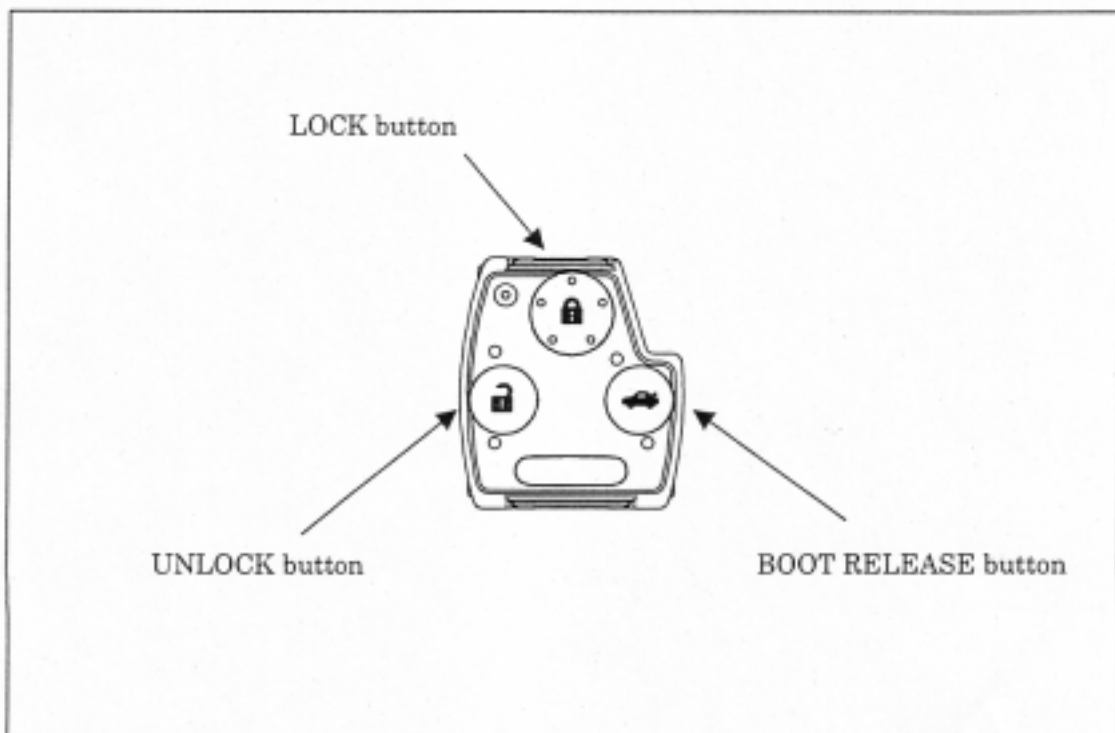

Transmitter
f =433.92MHz

2. User's manual (provisionally)

REMOTE TRANSMITTER

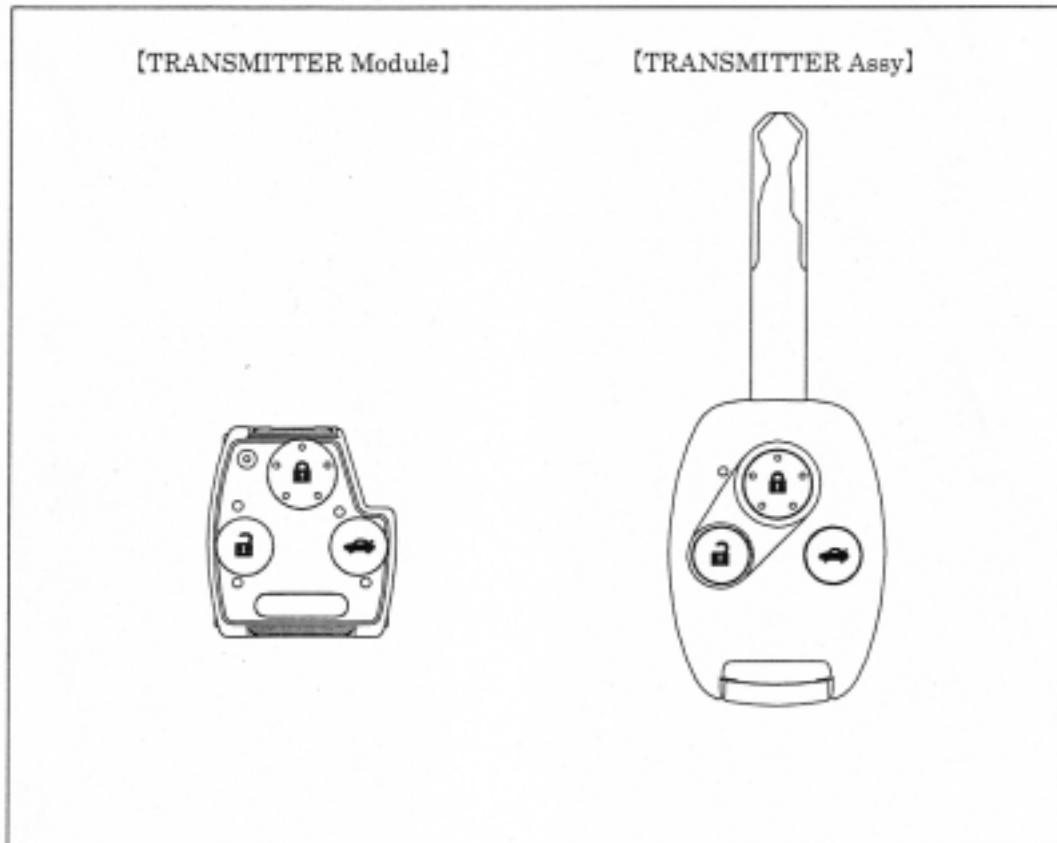

You can lock and unlock your vehicle with the remote transmitter.

LOCK

When you push the **LOCK** button, all the doors will lock.

You cannot lock any of the doors with the remote transmitter if any door is open or the key is in the ignition switch.

UNLOCK

When you push the **UNLOCK** button, all the doors will unlock.

You cannot unlock any of the doors with the remote transmitter if the key is in the ignition switch.

When you push the **UNLOCK** button more than about 1.0 second, the window will open.

BOOT RELEASE

To open the boot, push the **BOOT RELEASE** button for approximately one second.

The boot will not open if the key is in the ignition switch.

3. Block diagram

This is the block diagram concerning to the transmitter

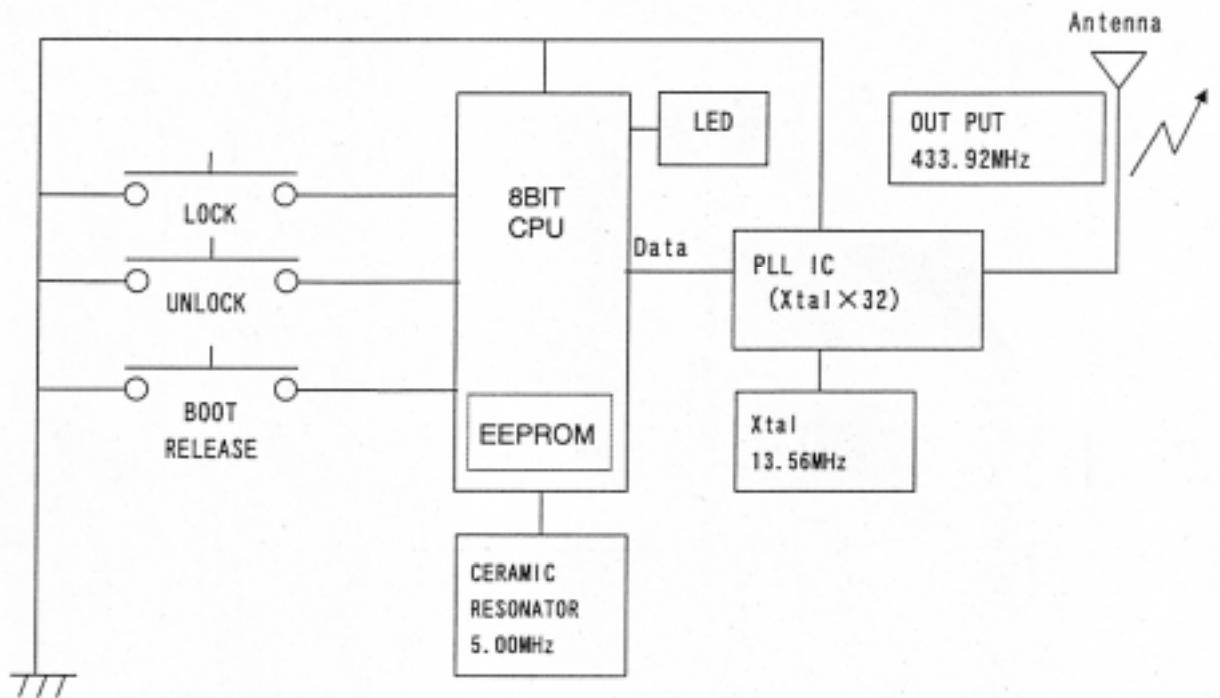

Figure 3.1 block diagram of the transmitter

Switch combination

OMRON MODEL NAME	SW QTY	LOCK	UNLOCK	PANIC	BOOT RELEASE
G8D-382H-A	3	○	○	×	○
G8D-382H-A-NT	2	○	○	×	×

4. Specification

4.1 CPU

Type	UPD789860 (8bit) Manufacturer: NEC Corporation
ROM	4K bytes
RAM	128 bytes
EEPROM	32 bytes
Clock frequency	5MHz
Clock frequency generation	Ceramic resonator
Package	20pin SSOP

4.2 RF block

Carrier frequency	433.87~433.97MHz
Frequency generation	Crystal resonator
Modulation	FSK
Bit transmission rate	1000bps or 2000bps
Bandwidth	120KHz
RF output power (field strength)	6000 μ V/m

4.3 Others

Dimension	33.5mm \times 29.8mm \times 8.4mm
Weight	10g
Battery	Lithium cell (CR1616) Manufacturer: MATSUSHITA Battery corporation
Operation Voltage	DC 3V, 20mA
Operation temperature	-20 $^{\circ}$ C ~ +60 $^{\circ}$ C

5. Features

5.1 Transmission frame

The transmission begins immediately in case of any button is pressed.

The transmission frame consists of the synchronous frame and the data frame. The synchronous frame has 324 bit codes that it will be used for the receiver to wake up. The data frame consists of 28-bit length identification code, 24-bit security code, 4-bit function code and 8-bit quality check code.(sometimes). 16000000 different identification codes are available. The security code is always changed in case of any of the buttons is pressed. The transmission time is typically 220 milliseconds.

5.2 Battery saving

To prevent the battery exhaustion, the microcomputer of the transmitter is usually inactive. When the button will be pressed, the microcomputer wakes up immediately and judges which button is pressing. Then the microcomputer constructs the transmission frame and radiates it from the antenna. After transmitting, the microcomputer switches stand-by mode by itself.