

Signs and symbols	Page 7
Description of signal words	Page 7
Customer service	Page 8
List of pictograms used	Page 8
Upper Arm Blood Pressure Monitor	Page 10
Introduction	Page 10
Intended purpose.....	Page 10
Target group.....	Page 11
Clinical use.....	Page 11
Indication.....	Page 12
Contraindication.....	Page 12
Parts description.....	Page 13
Scope of delivery.....	Page 16
Technical data.....	Page 16
Warning and safety instructions	Page 19
General warning instructions.....	Page 19
General precautions.....	Page 21
Safety warnings for batteries.....	Page 22
Information on electromagnetic compatibility.....	Page 25
FCC compliance information.....	Page 26
Initial use	Page 27
Inserting / Replacing batteries.....	Page 27
App / web version of "HealthForYou".....	Page 28
Changing the date / time / time format /	
Bluetooth® settings.....	Page 29
Activating and deactivating Bluetooth®.....	Page 30

Measuring blood pressure	Page 31
Attaching the cuff.....	Page 32
Adopting the correct posture.....	Page 34
Selecting a memory.....	Page 35
Carrying out the blood pressure measurement	Page 35
Transferring measurements via Bluetooth®	Page 37
Evaluating Measurements	Page 38
General information about blood pressure	Page 38
Cardiac arrhythmia	Page 39
Risk indicator.....	Page 40
Saving, requesting and deleting measurements	Page 42
Restoring the device to its factory settings	Page 44
Cleaning and care	Page 44
Storage	Page 45
Troubleshooting	Page 46
Disposal	Page 47
Notes on electromagnetic compatibility	Page 47
Three year limited warranty	Page 48

● Signs and symbols

The following signs are used in the safety section and in these instructions for use.

CAREFULLY READ THIS ENTIRE MANUAL, THE SAFETY SECTION AND ALL INSTRUCTIONS AND WARNINGS BEFORE USING THIS PRODUCT. FOLLOW ALL SAFETY NOTES AND WARNINGS TO AVOID HAZARDOUS SITUATIONS AND TO ENSURE CORRECT PRODUCT USE.

The following terms indicate safety and property damage messages, and the hazard level.

DESCRIPTION OF SIGNAL WORDS

WARNING

WARNING indicates a hazardous situation that, if not avoided, could result in death or serious injury.

ATTENTION

ATTENTION indicates a hazardous situation that, if not avoided, could result in minor or moderate injury.

NOTICE

NOTICE indicates information considered important, but not hazard related (e.g. messages related to property damage).

CUSTOMER SERVICE



Call customer service at
1 (844) 543-5872



Visit the Website Customer
Service Platform at
www.lidl.com/contact-us

Visit a LIDL store for further assistance.

IAN 366723_2101

Please have your
IAN number ready.

List of pictograms used



WARNING

Warning of risks of injury or health hazards



ATTENTION

This symbol shows that caution should be exercised if devices or controllers are being operated near this symbol or that the current situation requires attentiveness or intervention from the operator to avoid unintended consequences.











Note on important information



Instructions

List of pictograms used

	Observe instructions for use
	Direct current
Storage / Transport 	Permissible storage and transport temperature and humidity
Operating 	Permissible operating temperature and humidity
	Permissible storage, transport and operating air pressure
	Manufacturer
	Applied part, type BF
	Serial number
IP21	Device protected against foreign matter ≥ 0.49 in (12.5 mm) and against water falling vertically
	Data transfer via <i>Bluetooth</i> [®] low energy technology

List of pictograms used



**FINAL DATA
TO FOLLOW**

the packaging and device in an environmentally-friendly manner!

Upper Arm Blood Pressure Monitor

● Introduction



Familiarize yourself with the upper arm blood pressure monitor before using it for the first time.

Please carefully read the following instructions for use and the important safety notes. Failure to observe the notes may result in personal injury or property damage. Only use the upper arm blood pressure monitor as described and for the indicated purposes. Keep these instructions for use in a safe place. Include all documentation when passing the upper arm blood pressure monitor on to third parties.

● Intended use

● Intended purpose

This upper-arm blood pressure monitor is intended to measure and monitor the arterial blood pressure values and the heart rates of adults with an arm circumference of **8.7 to 16.5 in** (22 cm to 42 cm), in a non-invasive way.

Using this device, you can quickly and easily measure your blood pressure, save the measurements and display the progression and average of these measurements. The recorded measurements are classified and evaluated graphically. A symbol in the display also warns of possible cardiac arrhythmia. If this symbol lights up in the display after the measurement, please consult your doctor for diagnosis. Any use other than previously mentioned or any product modification is prohibited and may result in injuries and/or product damage. The manufacturer assumes no liability for damage arising out of improper use. The product is only intended for use in private environments (at home).

● Target group

Blood pressure measurement is suitable for adult users whose upper arm circumference is within the area printed on the cuff.

● Clinical use

The user can quickly and easily record their blood pressure and pulse values using the device. The blood pressure measurement values recorded are classified in accordance with internationally applicable guidelines and evaluated graphically. Furthermore, the device can identify irregular heartbeats occurring during the measurement and inform the user via a symbol on the display. The device saves the displayed

measurement values and can also provide average values of previous measurements. The data recorded can support health service providers when diagnosing and treating blood pressure problems and thus contribute to the long-term monitoring of the user's health.

● Indication

If the user has hypertension or hypotension, they can monitor their blood pressure, pulse values and possible existing cardiac arrhythmia, in a home environment. However, the user does not have to suffer from hypertension or arrhythmias to use the device.

● Contraindication

 **WARNING** Failure to observe the following warnings can result in death or serious injuries.

-  Do not use this product on newborns and pre-eclampsia patients. We recommend consulting your doctor before using the product if you are pregnant.
- The device is not suitable for use by patients with implanted electrical devices such as pacemakers or defibrillators. Do not use the device if you have metal implants.
- Before using the device under any of the following circumstances, it is absolutely necessary that you consult

a doctor: cardiac arrhythmias, circulation problems, diabetes, hypotension, chills, tremors.

- Do not use the product in conjunction with a high-frequency surgical unit.
- Ensure that the cuff is not placed on an arm of a person whose arteries or veins are undergoing medical treatment, i.e. intra-vascular access or intra-vascular therapy or an arteriovenous (A-V) shunt.

 **ATTENTION** Failure to observe the following warnings can result in injuries or property damage.

- People with limited physical, sensory or mental abilities should be supervised by a person responsible for their safety and adhere to this person's instructions for using the device.
- Do not place the cuff on individuals who have had a mastectomy.
- Do not place the cuff over wounds as this could lead to further injuries.
- Do not use the device on people with allergies or sensitive skin.



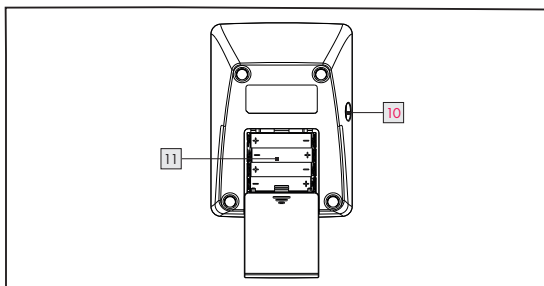
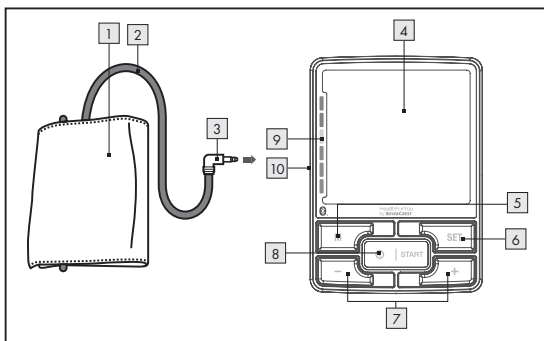

● Parts description

- 1 Cuff
- 2 Cuff tubing
- 3 Cuff plug
- 4 Display

- 5 Memory button M
- 6 Settings button SET
- 7 Function button -/+
- 8 START/STOP button  | START
- 9 Risk indicator
- 10 Connection for cuff plug
- 11 Battery compartment



Display indicators

- 12 Time and date
- 13 Systolic pressure
- 14 Diastolic pressure
- 15 Pulse value determined
- 16 Symbol for cardiac arrhythmia  Symbol for pulse 
- 17 Memory display: Average value (A), morning (AM), evening (PM), number of the memory space
- 18 Symbol for replace battery 
- 19 Risk indicator
- 20 Release air
- 21 User memory
- 22 Symbol for Bluetooth® transfer 
- 23 Cuff position control 

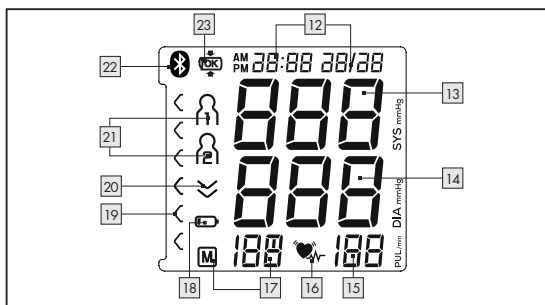

● Scope of delivery

- 1 Upper arm blood pressure monitor
- 1 Upper arm cuff (material no. 164.386 cuff SBM 69) with cuff tubing
- 4 Batteries 1.5V type AAA LR03
- 1 Instructions for use
- 1 Quick start guide
- 1 Blood pressure record card
- 1 Storage pouch

● Technical data

Type:	SBM 69
Measuring method:	Oscillometric, non-invasive blood pressure measurement on the upper arm
Measurement range:	Rated cuff pressure: 0-299 mmHg, Measurement pressure: Systolic: 60-230 mmHg Diastolic: 40-130 mmHg
Pulse value:	40-199 beats per minute
Display accuracy:	systolic ± 3 mmHg, diastolic ± 3 mmHg, pulse $\pm 5\%$ of the displayed value
Measurement uncertainty:	max. permissible standard deviation according to clinical testing: systolic 8 mmHg/diastolic 8 mmHg

Memory:	2 x 100 memory spaces
Dimensions:	L 5.3 in (134.5 mm) x W 3.9 in (100 mm) x H 2 in (51,0 mm)
Cuff:	suitable for an arm circumference between 8.7 in and 16.5 in (22 cm and 42 cm)
Weight:	0.87 lb (395 g) (with cuff, without batteries)
Permissible operating conditions:	41 °F to 104 °F (+5 °C to +40 °C), 15 % to 90 % relative humidity (non-condensing), 700-1060 hPa ambient pressure
Permissible storage conditions:	-4 °F to 140 °F (-20 °C to +60 °C), ≤ 93 % relative humidity (not condensing), 700-1060 hPa ambient pressure
Power supply:	4 x 1.5V AAA batteries
Product expected lifespan:	5 years
Battery life:	225 measurements, depending on blood pressure level and inflation pressure / <i>Bluetooth</i> ® transfer
Classification:	Internal supply, IP21, no AP or APG, continuous operation, applied part Type BF

Data transfer via
Bluetooth® low
energy technology:



The product uses *Bluetooth*® low energy technology, frequency band 2.402 – 2.480 GHz, maximum transmission power radiated in the frequency band < -1.5 dBm

For a list of compatible smart phones, information about the “HealthForYou” app and software, as well as further details about the devices, please visit: www.healthforyou.lidl

System requirements
of the „HealthForYou“
web version:

- MS Internet Explorer
 - MS Edge
 - Mozilla Firefox
 - Google Chrome
 - Apple Safari
- (in the respective updated version)

System requirements
of the “HealthForYou”
app:

iOS from Version 12.0; Android™
from 8.0; *Bluetooth*® from 4.0

Technical specifications subject to change without notice
due to updates.

● **Warning and safety instructions**



READ ALL INSTRUCTIONS. KEEP FOR FUTURE REFERENCE. INCLUDE ALL DOCUMENTATION WHEN PASSING THIS PRODUCT ON TO OTHERS.

● **General warning instructions**

⚠️ WARNING Failure to observe the following warnings can result in death or serious injuries.

- The measurements you take are only intended for your information - they do not replace a medical examination! Discuss your measured values with a doctor. Under no circumstances should you make medical decisions by yourself on the basis of these values (e.g. with regard to medication dosages)!
- Cardiovascular system diseases may result in incorrect measurements and/or impairments to the device's measurement accuracy.
- Do not use the device at the same time as other medical electrical devices (ME devices). This could lead to the measurement device malfunctioning and/or an inaccurate measurement.
- Blood circulation should not be restricted by the blood pressure measurement for an unnecessary amount of time. Remove the cuff from the arm if the device malfunctions.
- The air tube poses a risk of strangulation for infants. Furthermore, the small parts the product contains

present a choking hazard for infants if swallowed. They should therefore always be supervised.

- Do not use the sphygmomanometer in conjunction with a high-frequency surgical unit.
- Do not use the device with a defibrillator.
- Do not use the device during an MRI scan.

⚠ ATTENTION Failure to observe the following warnings can result in injuries or property damage.

- Ensure that the limb is not functionally impaired when inflating the cuff.
- Do not take measurements more often than necessary. Due to the limitation to blood flow, it can lead to the development of bruising.
- Only place the cuff on the upper arm. Do not place the cuff on other body parts.
- Do not expose the device to static electricity. Always ensure that no static electricity is coming off of you before you operate the device.

NOTICE

- The device is only intended for the purpose described in these instructions for use. The manufacturer is not liable for damage caused by improper or incorrect use.
- Using the blood pressure monitor outside the domestic environment or under the influence of movement (e.g. whilst riding in cars, ambulances or helicopters as well as whilst practising physical activities such as sport) can

impact the accuracy of the measurement and lead to measurement errors.

- Do not use the device outside of the stated storage and operating conditions. This could lead to incorrect measurement results.
- Do not place the device in pressure receptacles or gas sterilisation devices.
- Do not allow the device to fall and also avoid stepping on or shaking the device.
- Do not disassemble the device, as this can lead to damage, malfunctions and faults.
- Do not use rechargeable batteries.
- If no button is pressed, the automatic shutoff will switch off the sphygmomanometer within 1 minute to save the batteries.
- Only use the cuffs supplied with this device or described in these instructions for use. Using another cuff can lead to inaccurate measurements.



General precautions

NOTICE

- ⚠ **Attention!** Potential damage to the device. The sphygmomanometer is made up of precision components and electronic components. The accuracy of the measurements and the service life of the device depend on the device being used with a due amount of care.

- Protect the device from impacts, moisture, dirt, severe temperature fluctuations and direct sunlight.
- Do not drop the device.
- Bring the device to room temperature before taking measurements. If the measuring device has been stored near to the maximum or minimum storage and transport temperature and is brought into an environment with a temperature of 68 °F (20 °C), it is recommended that you wait 2 hours before using the measuring device.
- Avoid mechanically restricting, compressing or kinking the cuff tubing.
- Routinely inspect the device to ensure the device is not visibly damaged before use and the battery level is sufficient. When in doubt, do not use and contact the service department or an authorised retailer. Do not use additional parts not recommended or sold as components by the manufacturer.
- Never open or repair the device or proper function cannot be guaranteed. Non-compliance will void the warranty.
- Please contact the service department or an authorised retailer for repairs. However, before making a complaint, firstly check the batteries and replace them if necessary.



Safety warnings for batteries

- When used correctly, cells and batteries provide a safe and dependable source of portable power. However, if

they are misused or abused, this may result in leakage, burns, fire, or explosion.

- Store batteries in a dry place at room temperature. Batteries are sensitive to high and low temperatures. Such thermal exposure may lead to leakage, fire, or explosion.
- Keep cells and batteries out of reach of children and pets, especially small batteries. Ingestion may lead to choking or acute and serious personal injury.
- Keep cells or batteries clean and dry both during use and storage. Wipe metal terminals with a soft, dry cloth if they become dirty. Immediately seek medical attention if a cell or battery has been swallowed. Also, contact your local poison control center.
- Immediately seek medical attention if a cell or battery has been swallowed. Also, contact your local poison-control center.
- In the event that the electrolyte comes into contact with the skin or eyes, immediately flush with fresh water for at least 15 minutes and seek medical attention.
- Store unused batteries in their original packaging or in safe place and away from metal objects that may short-circuit them.
- Exercise care in handling batteries in order to prevent shorting with conducting materials, such as rings, coins, bracelets, and keys. The battery or the conductor can overheat and cause burns, leakage, fire, or explosion.
- Clean the battery contacts and also those of the product prior to battery installation. Keep the contacts clean.
- Remove batteries from the product that will not be used for an extended period of time (months or longer).

- Remove discharged batteries from product promptly to avoid possible damage from leakage.
- Choose the proper battery for the intended application.
- Always take care to correctly insert batteries observing (+) and (-) polarity marks on the battery and the product for which it is intended. Proper polarity must be observed to avoid damage to either product or batteries.
- Always replace the whole set of batteries at one time, taking care not to mix old and new ones, or batteries of different types, capacities, or manufacturers.
- Never heat batteries in order to revive them.

 **WARNING**

Never charge a battery unless the battery label specifically states the battery is rechargeable. Charging a non-rechargeable battery, may result in leakage, fire, or explosion.

- Use only the power cord supplied with the product. The use of other cords may result in the batteries inside the product being charged.
- Do not open or mutilate a battery or cell. Electrolyte from the cell is corrosive and can cause damage to the eyes or skin. The cell contents can also be hazardous if ingested.
- Do not drop or subject the cell or battery to strong mechanical shock.
- Batteries should not be disassembled, crushed, punctured, or otherwise mutilated. Such abuses may result in leakage, fire, or explosion.

- Do not dispose of the battery in a fire. Failure to observe this precaution may result in an explosion.
- Dispose of batteries properly and in accordance with government regulations.



Information on electromagnetic compatibility

NOTICE

- The device is suitable for use in all environments that are listed in these instructions for use, including in the home.
- In the presence of electromagnetic disturbances, the device may under some circumstances only be useable to a limited extent. This can result in error messages or the breakdown of the display / device, for example.
- The use of the device immediately next to other devices or stacked with other devices is to be avoided, as this can result in faulty operation. If it is necessary to use the device in such a way in spite of this, this device and the other device should be monitored to make sure that they are working correctly.
- The use of equipment other than that which has been specified or made available by the manufacturer of this device can lead to increased electromagnetic interference or the reduced electromagnetic stability of the device and can lead to faulty functioning.
- Failure to observe these instructions may lead to a reduction in the performance features of the device.

● FCC compliance information

- FCC ID: OU9TMB1891HJ
- This product complies with part 15 of the FCC Rules. Operation is subject to the following two conditions:
 - 1) This product may not cause harmful interference, and
 - 2) this product must accept any interference received, including interference that may cause undesired operation. Changes or modifications to this product not expressly approved by the party responsible for compliance could void the user's authority to operate the product.

Note: This product has been tested and complies with the limits for a Class B digital device, pursuant to Part 15 of the FCC Rules. These limits are designed to provide reasonable protection against harmful interference in a residential installation. This product generates, uses and can radiate radio frequency energy and, if not installed and used in accordance with the instructions, may cause harmful interference in radio communications.

- However, there is no guarantee that interference will not occur in a particular installation. If this product causes harmful interference to radio or television reception, which can be determined by turning the product off and on, the user is encouraged to try and correct the interference by one or more of the following measures:
 - Reorient or relocate the receiving antenna.
 - Increase the distance between the equipment and receiver.

- Connect the product into an outlet on a circuit different from that to which the receiver is connected.
- Consult the dealer or an experienced radio/TV technician for help.

SAVE THESE INSTRUCTIONS

● Initial use

- Verify the parts listed in the scope of delivery are complete.
- Remove all packaging material.

● Inserting / Replacing batteries

- Slide the battery cover off the battery compartment **11**.

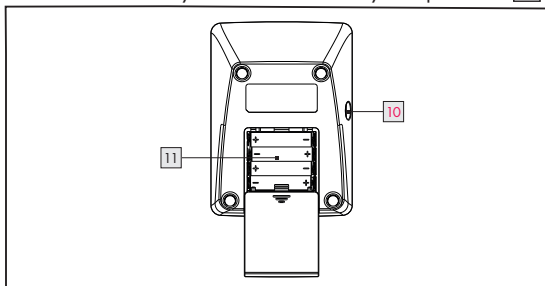

- Insert the four type 1.5 V AAA (Alkaline type LR03) batteries (with the correct polarity) into the device. Please note the marking inside the battery compartment.
- Carefully close the battery cover on the battery compartment **11**.
- Do not use rechargeable batteries.
Note: if the change battery indicator **18** is displayed continuously, measurement will not be possible until all batteries have been replaced. As soon as the batteries have been removed from the device, the date and time will be reset. Saved measurements will still be stored.
- All display elements will be shown briefly and „24h“ will flash on the display. Now set the date, time, time format and Bluetooth® (see the chapter „Changing the date/time/time format/Bluetooth® settings“).

● App / web version of “HealthForYou”

Download the free app “HealthForYou” from the Apple App Store and Google Play.

- Follow the installation instructions on the screen.
- Alternatively, you can also visit the website www.healthforyou.lidl. Here you will be able to enter measurements and find guidance for assessment.



The „HealthForYou“ privacy policy can be viewed via the following link: www.healthforyou.lidl/privacy.html

● Changing the date / time / time format / Bluetooth® settings

- Configure the date, hour format and time. It is only in this way that you will be able to correctly save these measurements with the date and time and request them later on.

❗ The settings menu can be accessed in two different ways:

Before first use and after every battery change:

- When you insert batteries into the device, you will automatically arrive at the relevant menu.

If batteries have already been inserted:

- On the **switched-off** device, hold the settings button SET **6** pressed for 5 seconds.

Now proceed as follows:

- The time format will flash. Use the function buttons -/+ **7** to set the format to 12-hour or 24-hour. Press the SET button **6** to confirm. The year will flash.
- Use the function buttons -/+ **7** to set the year. Press the SET button **6** to confirm. The month will flash.
- Use the function buttons -/+ **7** to set the month. Press the SET button **6** to confirm.
- Configure the day, hour and minute consecutively as described above. Press the SET **6** button to confirm each entry.

The *Bluetooth*[®] symbol will be shown on the display. “On” and “OFF” will flash at the same time.

- Using the function buttons “-/ +”, choose whether you want to activate (“On” flashes) or deactivate (“OFF” flashes) *Bluetooth*[®] data transfer. Press the SET button **6** to confirm.

If *Bluetooth*[®] is activated (“On”) data transfer will begin automatically after the measurement has been taken.

Note: The battery life is reduced by transfer via *Bluetooth*[®].

● **Activating and deactivating *Bluetooth*[®]**

You can activate or deactivate the device’s *Bluetooth*[®] function at any time, independently of the other settings.

Proceed as follows:

- With the device switched off, briefly press the settings button SET **6**. You will now see the *Bluetooth*[®] symbol **22** in the display **4**, “On” or “OFF” will flash simultaneously.
- Now activate or deactivate data transfer using the function buttons -/+ **7** (Activated: „On” flashes in the the display **4**. Deactivated: „OFF” flashes in the display **4**.).
- Confirm your selection using the settings button SET **6**. The device will then automatically switch off.

● **Measuring blood pressure**

Note: To generate an informative profile of the development of your blood pressure and thus guarantee that you will be able to compare the measured values adequately, measure your blood pressure regularly and always at the same time of day. It is recommended that you measure blood pressure twice a day: once in the morning after getting up and once in the evening.

- You should not eat, drink, smoke or be physically active in the 30 minutes before each measurement.
- Before taking the first blood pressure measurement, always rest for 5 minutes!
- The measurement should always be taken in an adequate state of physical rest. You should therefore avoid taking measurements at stressful times.
- Furthermore, if you wish to take multiple measurements one after the other, always wait at least 1 minute between each measurement.
- Repeat the measurement process if the measured values seem incorrect.
- Bring the device to room temperature before taking measurements.
- Only place the cuff on the upper arm. Do not place the cuff on other body parts
- The sphygmomanometer can only be operated with batteries. Please be aware that data transfer and data storage are only possible if your sphygmomanometer is powered on. If the batteries are drained, the date and time will be deleted from the sphygmomanometer.

● Attaching the cuff

⚠ ATTENTION Failure to observe the following warnings can result in injuries or property damage.

- Only use the device with the original cuff. The cuff is suitable for an upper arm circumference of between **8.7 in-16.5 in** (22 cm and 42 cm). The correct fit should be checked before the measurement is taken using the index markings described below.
- Place the cuff **1** on a bare upper arm. The blood flow of the arm should not be constricted by clothing etc. which is too tight.

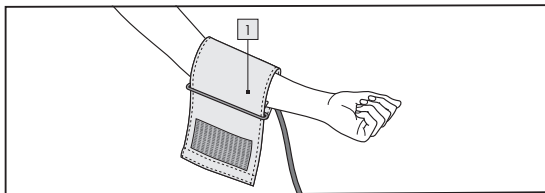

- Position the cuff **1** on the upper arm so the lower edge is **0.79 in-1.18 in** (2 cm-3 cm) up from the elbow and over the artery. The cuff tubing **2** points towards the middle of the palm.

- Place the free end of the cuff **1** closely, but not too tightly, around the arm and close the Velcro strip. The cuff **1** should not be too tight.

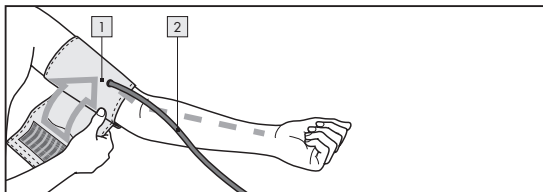

Check that two fingers can still fit beneath the cuff **1**.

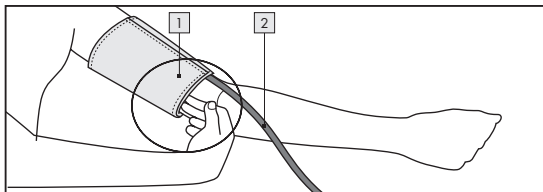

- This cuff is suitable for you if, after putting it on, the index mark on the outside of the cuff (▼) is within the OK range on the cuff.

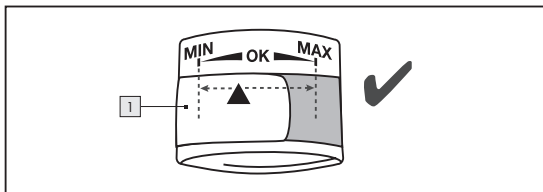

- Now insert the cuff tubing **2** with the cuff plug **3** into the connector **10**.



- If the measurement is being taken using the right upper arm, the air tube should be over the inner side of your elbow. Ensure that you do not press on the air tube with your arm.

● Adopting the correct posture

Note: Stay still during the measurement process and do not talk to prevent the measurement result from being falsified.

- You can carry out the measurement while sitting or lying down. Always ensure that the cuff **1** is at the same level as the heart

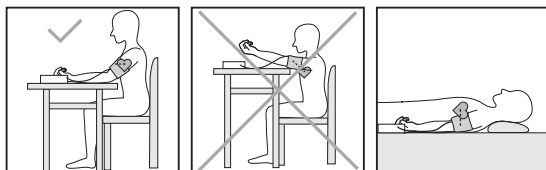







- Sit comfortably for the blood pressure measurement. Recline your back and arms. Do not cross your legs. Put your feet flat on the ground.



- In order not to falsify the measurement result, it is important that you stay still and do not talk.

● **Selecting a memory**



There are 2 memories available, each with 100 memory spaces, so that you can save the measured values of 2 different people separately.

- With the device switched off, press the START / STOP button  | START . The most recently selected user memory will flash in the display  - this is User 1  in the default settings.
- You can now use the function buttons „-/+"  to select the desired user memory.
- Confirm your selection by pressing the START / STOP button  | START  again. The device will then automatically begin measuring values.



● **Carrying out the blood pressure measurement**

- Place the cuff on your arm as previously described and assume the position in which you wish to carry out the measurement.
- Start the blood pressure monitor using the START / STOP button  | START  and select the desired user memory as described in the Chapter „Selecting a memory“.

After the full-screen display, the last measurement result saved will be displayed. If no measurement has been saved, the device will display the value of "0".



After you have confirmed the user selection using the START / STOP button  |  **8**, the blood pressure monitor automatically begins measuring by inflating the cuff. The measurement is taken while the cuff is being pumped up. As soon as a pulse has been detected, the pulse symbol  will be displayed. After this, the cuff air pressure will be released again.

The measurement results for systolic pressure, diastolic pressure and pulse will be displayed.

- You can stop the measurement at any time by pressing the START / STOP button  |  **8**.

If the measurement has not been carried out correctly, "Er_" will be displayed (see "Troubleshooting" also). Repeat the measurement process in the event that this happens.

The measurement result will be saved automatically. If you have activated *Bluetooth*® data transfer, the data will be transferred. The blood pressure monitor displays the symbol for *Bluetooth*® transfer during transfer.

- To power down press the START / STOP button  |  **8**.

Note: The device switches off automatically after one minute if no button has been pressed. Wait for at least one minute before taking another measurement!

● **Transferring measurements via Bluetooth®**

You have the option of transferring the measured values and values saved on your device to your smartphone using *Bluetooth®* low energy technology.

- Activate *Bluetooth®* in your smartphone settings and open the “HealthForYou” app.
Note: The “HealthForYou” app must be open for transfer to occur.
- Add “SBM69” in the app.
- When connecting for the first time, a randomly generated six-digit PIN code will be displayed on the device over two lines. At the same time, an entry field will appear on your smartphone where you should enter this six digit code. When you have entered it correctly, the device is connected with your smartphone and you can begin to transfer your measurement values.

Warning! The displayed values are intended merely as a visualisation and may not be used as the basis for therapeutic measures. The software is not part of a diagnostic medical system.



We wish to expressly indicate that the software at hand is not a medical product in accordance with the EU directive 93/42/EEC.

Note: During data transfer, button functions cannot be executed.

To transfer measurements to your smartphone via *Bluetooth®* proceed as follows:

Manual transfer

Go to save mode (see "Saving, requesting and deleting measurements"). As soon as the average value of all measurements is displayed, a *Bluetooth*® connection will automatically be established. The data will be transferred and the *Bluetooth*® symbol will be shown on the display.

- Switch the blood pressure monitor off by pressing the START/STOP button  | START .

Automatic transfer

If you forget to switch off the blood pressure monitor, it will automatically switch off after one minute. In this case, the value will be saved in the selected user memory and the data will be transferred if *Bluetooth*® data transfer has been activated. The *Bluetooth*® symbol will be shown on the display during transfer.

● Evaluating Measurements

● General information about blood pressure





- Blood pressure is the force with which the bloodstream presses against the arterial walls. Arterial blood pressure changes continuously over the course of a cardiac cycle.
- The blood pressure figure is always given in the form of two values.
 - The highest pressure in the cycle is called the systolic

blood pressure. It occurs when the heart muscle draws together and presses the blood into the vessels.

- The lowest number is the diastolic blood pressure, which then occurs when the heart muscle has fully stretched out again and the heart fills with blood.

- Blood pressure fluctuations are normal. Even on a repeat measurement, observable differences between the measured values can arise. One-time or irregular measurements therefore do not provide a reliable indication of the actual blood pressure. A reliable assessment is only possible if you regularly measure your blood pressure under comparable conditions.

● Cuff position control

The device has a cuff position control. Using this function, the device automatically checks the correct position of the cuff on your upper arm whilst it is taking a measurement. If the cuff  has been correctly positioned, the symbol   will appear in the display  during inflation. It will stay there until the measurement has successfully been taken and will then be shown together with the recorded values.

● Cardiac arrhythmia

This device can identify any potential cardiac arrhythmia disorders and, if necessary, indicates this after the measurement

process with the symbol . This can be an indicator for arrhythmia.

Arrhythmia is an illness in which the heart rhythm is abnormal due to errors in the bioelectric system, which controls the heartbeat. The symptoms (skipped or premature heartbeats, slow or rapid pulse) can stem from heart conditions, age, physical predispositions, an excess of luxury foods, stress or a lack of sleep. Arrhythmia can only be diagnosed by a doctor after a physical examination.

- Repeat the measurement process if the symbol  is shown on the display after the measurement. Please make sure that you rest for a minute before the measurement and do not talk or move during it.

 WARNING Failure to observe the following warnings can result in death or serious injuries.

- If the symbol  is displayed repeatedly, contact your doctor. Self-diagnosis and self-treatment on the basis of measurement results can be dangerous. Follow your doctor's instructions.

● Risk indicator

In accordance with the guidelines / definitions provided by the [Joint National Committee \(JNC\)](#) and the latest findings, the measurement results can be classified and evaluated according to the following table:

Stages of blood pressure levels	Systolic (mmHg)	Diastole (mmHg)	Color	Measure
Stage 2: Hypertension	≥ 180	≥ 110	Red	Seek medical advice
	160–179	100–109	Red	Seek medical advice
Stage 1: Hypertension	140–159	90–99	Red	Have it checked regularly by a doctor
Pre-hypertension	130–139	85–89	Yellow	Have it checked regularly by a doctor
	120–129	80–84	Yellow	Check it yourself
Normal	< 120	< 80	Green	Check it yourself

Source: U.S. Department of Health and Human Service, JNC 8(2014), adapted

⚠ The JNC chart is not intended to replace a medical diagnosis. This chart is only a reference for different classifications of blood pressure.





Note: These standard values merely serve as a general guideline as blood pressure deviates depending on the individual, different age groups, etc.

It is important that you consult your doctor at regularly. Your doctor will provide you with your particular values for normal blood pressure as well as the value for when your blood pressure is classified as dangerous.

The bar chart on the display and the scale on the device state which range the blood pressure measured is in. If the values for systolic and diastolic pressure are in two different JNC ranges (e.g. systolic in the Stage 1 Hypertension range and diastolic pressure in the normal range) the graphic JNC classification on the unit indicates the higher range (Stage 1 Hypertension in the example described).

● **Saving, requesting and deleting measurements**

The results of each successful measurement are saved together with the date and time. If there are over 100 measurement values, the oldest measurement value will be overwritten.

- With the device switched off, press the START / STOP button  | START  to select the desired user memory .
- Confirm your selection by pressing the memory button M .

„A“ will flash in the display **4** and an average of all the saved measurements in the selected user memory will be shown.

- Press the memory button M **5** again to display the average value of the last 7 days for the morning measurement. (Morning: 5.00 am – 9.00 am, display “AM”). Press the memory button M **5** again to display the average value of the last 7 days for the evening measurement. (Evening: 6 pm – 8 pm, display “PM”). By pressing the memory button M again, the last individual measurement will be displayed with the date and time.
- Press the START/STOP button **1** | START **8** to switch off the device.

Note: The device switches off automatically after one minute when no button has been pressed.

Deleting a selected user memory

- To delete the memory of the selected user, press the memory button M **5** when the device is switched off.
- The average value of all measurements will appear on the display. Next to this, “A” and the Bluetooth® transfer symbol **22** will flash.
- Keep the function buttons -/+ **7** pressed simultaneously for 5 seconds.
- After successful deletion, “CL 00” will appear in the display.

The data has been deleted.

● Restoring the device to its factory settings

You can delete all of the data saved on the device, e.g. settings or saved measured values, by restoring the device to its factory settings.

Proceed as follows:

- With the device switched off, press the memory button M **5**. You will then be in the most recently selected user memory. „A” will flash in the display **4**.
- Now press the memory button M **5** again to switch to the display mode for the average morning value. „AM” will flash in the display **4**.
- Hold down both function buttons -/+ **7** at the same time for 15 seconds, until „CL ALL” appears in the display **4**. Now all of the data saved on the device will be deleted and the device will be restored to its factory settings.

● Cleaning and care

NOTICE



- ⚠ Possible property damage! Never hold the product under water as liquid could enter the product and damage it.
- Clean the device and cuff **1** carefully using a slightly damp cloth.
- Do not use cleaners or solvents.

● Storage

NOTICE

- ⚠ Possible property damage! Do not place any heavy objects on the device and cuff **1**.
- If the product will not be used for more than one month, remove both batteries from the device to prevent possible battery leakage.
- Do not kink the cuff tubing **2**.
- Store the product in a dry location (relative humidity $\leq 93\%$). High humidity can shorten the service life or damage the product. Store the product in a location with ambient temperatures between **-4 °F and 140 °F** (-20 °C and +60 °C).

● Troubleshooting

Troubleshooting	Problem	Solution
Er1	The pulse cannot be measured correctly.	Repeat the measurement process. Be sure not to move or talk.
Er2	You have been talking or moving during the measurement process.	
Er3 	The cuff was attached too tightly or too loosely.	
Er4	An error occurred during the measurement process.	
Er5	The pump-up pressure is higher than 300 mmHg or the blood pressure measurement falls outside of the measuring range.	
Er6 	The batteries are almost dead.	Reinsert the batteries or replace them with new batteries.
Er7	Data cannot be sent via Bluetooth®.	Activate Bluetooth® on your smartphone and start the "HealthForYou" app.
Er8	A device error has occurred.	Repeat the measurement process. Be sure not to move or talk.

Trouble-shooting	Problem	Solution
OUT	Out of measurement range	<ul style="list-style-type: none"> - Relax for a moment. - Refasten the cuff and then measure again. - If the problem persists, contact your physician.

● Disposal

Observe the local regulations for material disposal. Dispose of the device and batteries in accordance with local regulations. If you have any questions, please contact the local waste management authorities.

● Notes on electromagnetic compatibility

- The device is suitable for use in all environments listed in these instructions for use, including domestic environments.
- The use of the device may be limited in the presence of electromagnetic disturbances. This could result in issues such as error messages or the failure of the display / device.

- Avoid using this device directly next to other devices or on top of other devices, as this could cause malfunctions. However, if the device must be used in this manner, this device and the other devices must be monitored to ensure they are working properly.
- Using accessories other than those specified or provided by the manufacturer of this device can increase electromagnetic emissions or decrease the device's electromagnetic immunity, which can cause malfunctions.
- Failure to comply with the above can impair device performance.

● **Three year limited warranty**

What does this warranty cover?

The warranty covers:

- Damage, breakage or inoperability due to defect.
- Damage not caused by normal wear and tear or failure to follow the safety and maintenance instructions provided in the user manual.

What is not covered by the warranty?

The warranty does not cover damage caused by:

- Normal wear and tear of the product, including fragile parts (such as switches, glass, etc.);
- Improper use or transport;
- Disregarding safety and maintenance instructions;
- Accidents or acts of nature (e.g. lightning, fire, water, etc.);

- Tampering with the product (such as removing cover, unscrewing screws etc.)

Consequential and incidental damages are also not covered under this warranty. However, some states do not allow the exclusion or limitation of incidental or consequential damages, so this limitation or exclusion may not apply to you.

What is the period of coverage and warranty resolution?

The warranty is for 3 years from the date of purchase. At our discretion, product will either be refunded or replaced.

What will we not do?

We will not:

- Start a new warranty period upon product exchange;
- Repair product.

How to process the warranty?

To initiate, please:

- Call customer service at 1 (844) 543-5872
- Visit the Website Customer Service Platform at www.lidl.com/contact-us
- or
- Visit a LIDL store for further assistance

To ensure the quickest warranty return process, please have the following available:

- The original sales receipt that includes the date purchased;

- The product and manual in the original package;
- A statement of the problem.

What must you do to keep the warranty in effect?

- Retain the original receipt;
- Follow all product instructions;
- Do not repair or modify the product.

How does state law relate to this warranty?

This warranty gives you specific legal rights, and you may also have other rights which vary from state to state. All implied warranties are limited by the duration and terms of this warranty. Some states do not allow limitations on how long an implied warranty lasts, so the above limitation may not apply to you.

This device complies with European Standard EN 60601-1-2 (in accordance with CISPR 11, IEC 61000-4-2, IEC 61000-4-3, IEC 61000-4-8) and is subject to special precautions with respect to electromagnetic compatibility. The device is suitable for use in all environments listed in these instructions for use, including domestic environments. Please note, portable and mobile HF communication devices may interfere with this device. **Das Gerät entspricht der EU-Richtlinie für Medizinprodukte 93/42/EEC, dem Medizinproduktegesetz und der Norm IEC 80601-2-30 (Medical electrical equipment Part 2-30: Particular requirements for basic safety and essential performance of automated non-invasive blood pressure monitors).**

The accuracy of this blood pressure monitor has been thoroughly tested and was developed with regard to a long utilizable service life. If the device is used in medicine, technical inspections using the suitable equipment are to be carried out. Precise information on how to test the accuracy of the device can be requested from our service address.

We hereby affirm that this product complies with the European RED Directive 2014/53/EU.

www.sanitas-online.de/web/de/landingpages/cedeclarationofconformity.php

The *Bluetooth*® word mark and logos are registered trademarks owned by Bluetooth SIG, Inc. and any use of such marks by Hans Dinslage GmbH is under license. Other trademarks and trade names are those of their respective owners.

Apple and the Apple logo are trademarks of Apple Inc., registered in the U.S. and other countries. App Store is a service mark of Apple Inc., registered in the U.S. and other countries.

Google Play and the Google Play logo are trademarks of Google LLC. Android is a trademark of Google LLC.



Guangdong Transtek Medical Electronics Co., Ltd.
Zone A, No. 105, Dongli Road,
Torch Development District,
Zhongshan, 528437, Guangdong, China

Notes on electromagnetic compatibility

The ME EQUIPMENT or ME SYSTEM is suitable for home healthcare environments and so on. Warning: Don't near active HF surgical equipment and the RF shielded room of an ME system for magnetic resonance imaging, where the intensity of EM disturbances is high.

Warning: Use of this equipment adjacent to or stacked with other equipment should be avoided because it could result in improper operation. If such use is necessary, this equipment and the other equipment should be observed to verify that they are operating normally.

Warning: Use of accessories, transducers and cables other than those specified or provided by the manufacturer of this equipment could result in increased electromagnetic emissions or decreased electromagnetic immunity of this equipment and result in improper operation.

Warning: Portable RF communications equipment (including peripherals such as antenna cables and external antennas) should be used no closer than 30 cm (12 inches) to any part of the equipment (SBM69), including cables specified by the manufacturer. Otherwise, degradation of the performance of this equipment could result.

If any: a list of all cables and maximum lengths of cables (if applicable), transducers and other ACCESSORIES that are replaceable by the RESPONSIBLE ORGANIZATION and that are likely to affect compliance of the ME EQUIPMENT

or ME SYSTEM with the requirements of Clause 7 (EMIS- SIONS) and Clause 8 (IMMUNITY). ACCESSORIES may be specified either generically (e.g. shielded cable, load impedance) or specifically (e.g. by MANUFACTURER and EQUIPMENT OR TYPE REFERENCE). If any: the performance of the ME EQUIPMENT or ME SYSTEM that was determined to be ESSENTIAL PERFORMANCE and a description of what the OPERATOR can expect if the ESSENTIAL PERFOR- MANCE is lost or degraded due to EM DISTURBANCES (the defined term “ESSENTIAL PERFORMANCE” need not be used).

Table 1:
Guidance and manufacturer’s declaration –
electromagnetic emissions:

Emissions test	Compliance
RF emissions CISPR 11	Group 1
RF emissions CISPR 11	Group B
Harmonic emissions IEC 61000-3-2	Not application
Voltage fluctuations/ flicker emissions IEC 61000-3-3	Not application

Table 2:
Guidance and manufacturer's declaration –
electromagnetic immunity:

Immunity test	IEC 60601-2 test level	Compliance level
Electrostatic discharge (ESD) IEC 61000-4-2	±8 kV contact ±2 kV, ±4 kV, ±8 kV, ±15 kV air	±8 kV contact ±2 kV, ±4 kV, ±8 kV, ±15 kV air
Electrical fast transient/burst IEC 61000-4-4	Not applicable	Not applicable
Surge IEC 61000-4-5	Not applicable	Not applicable
Voltage dips, short interruptions and voltage variations on power supply input lines IEC 61000-4-11	Not applicable	Not applicable
Power frequency (50Hz/60Hz) magnetic field IEC 61000-4-8	30 A/m 50 Hz/60 Hz	30 A/m 50 Hz/60 Hz
Conducted RF IEC 61000-4-6	Not applicable	Not applicable
Radiated RF IEC 61000-4-3	10V/m 80 MHz–2,7 GHz 80% AM at 1 kHz	10V/m 80 MHz–2,7 GHz 80% AM at 1 kHz

Immunity test	IEC 60601-2 test level	Compliance level
NOTE U_T is the a.c. mains voltage prior to application of the test level.		

**Table 3:
Guidance and manufacturer's declaration -
electromagnetic immunity:**

Radiated RF IEC61000-4-3 (Test specifications for ENCLOSURE PORT IMMUNITY to RF wireless communications equipment)	Test Fre- quency	Band (MHz)	Service
	385	380-390	TETRA 400
	450	430-470	GMRS 460: FRS 460
	710	704-787	LTE Band 13, 17
	745		
	780		
	810	800-960	GSM 800/900, TETRA 800, iDEN 820, CDMA 850, LTE Band 5
	870		
	930		

Radiated RF IEC61000-4-3 (Test specifications for ENCLOSURE PORT IMMUNITY to RF wireless communications equipment)	Test Frequency	Band (MHz)	Service
	1720	1700-1990	GSM 1800; CDMA 1900; GSM 1900; DECT; LTE Band 1, 3, 4, 25; UMTS
	1845		
	1970		
	2450	2400-2570	Bluetooth, WLAN, 802.11 b/g/n, RFID 2450, LTE Band 7
	5240	5100-5800	WLAN 802.11 a/n
	5500		
	5785		

**Table 3:
Guidance and manufacturer's declaration -
electromagnetic immunity:**

Radiated RF IEC61000-4-3 (Test specifications for ENCLOSURE PORT IMMUN- NITY to RF wireless com- munications equipment)	Modu- lation	Modu- lation (W)	Dis- tance (m)	IMMU- NITY TEST LEVEL (V/m)
	Pulse modulation b) 18 Hz	1.8	0.3	27
	FM c) \pm 5kHz deviation 1 kHz sine	2	0.3	28
	Pulse modulation b) 217 Hz	0.2	0.3	9
	Pulse modulation b) 18 Hz	2	0.3	28

Radiated RF IEC61000-4-3 (Test specifications for ENCLOSURE PORT IMMUN- NITY to RF wireless com- munications equipment)	Modu- lation	Modu- lation (W)	Dis- tance (m)	IMMU- NITY TEST LEVEL (V/m)
	Pulse modula- tion b) 217Hz	2	0.3	28
	Pulse modula- tion b) 217Hz	2	0.3	28
	Pulse modula- tion b) 217Hz	0.2	0.3	9