

LS802-GP standard User Manual

Size: 100 x 140 mm

Material (recommended): 80g/m² (80g书纸)

Color: black

Customizable :

Update your company contact information on back cover and Page 21

Transtek Logo → Customized Logo

version:1.0

TRANSTEK

User Manual

Blood Pressure Monitor

LS802-GP

TRANSTEK



Guangdong Transtek Medical Electronics Co., Ltd.

Zone A, No.105, Dongli Road, Torch Development
District, Zhongshan, 528437, Guangdong, China

- Please read the user manual carefully and thoroughly so as to ensure the safe usage of this product, keep the manual well for further reference in case you have problems.

Table of Contents

INTRODUCTION	2
• General Description	
• Indications for Use	
• Contraindications	
• Measurement Principle	
• Safety Information	
• Display and Symbols	
• Name of Each Part	
• Contents/Product Includes	
BEFORE YOU START	9
• The Choice of Power Supply	
• Installing and Replacing the Batteries	
MEASUREMENT	11
• Applying the cuff	
• Taking a measurement	
INFORMATION FOR USER	14
• Tips for measurement	
• Maintenances	
ABOUT BLOOD PRESSURE	16
• What are systolic pressure and diastolic pressure?	
• What is the standard blood pressure classification?	
• Irregular heartbeat detector	
• Why does my blood pressure fluctuate throughout the day?	
• Why do I get a different blood pressure at home compared to the hospital?	
• Is the result the same if measuring on the right arm?	
TROUBLESHOOTING	19
SPECIFICATIONS	20
AUTHORIZED COMPONENT	21
CONTACT INFORMATION	21
FCC STATEMENT	22
EMC GUIDANCE	23

♥ General Description

Thank you for selecting this arm type blood pressure monitor (LS802-GP). The monitor features blood pressure measurement, pulse rate measurement and the result storage. The design provides you with two years of reliable service.

FEATURES:

- 78 mm × 92 mm Digital LCD display
- Systolic, Diastolic Blood Pressure & Pulse Display
- Date / Time Indication
- Irregular Heartbeat detection
- Up-to-date measuring-during-inflation technology
- E-MTC wireless communication

♥ Indications for Use

This Pro Cellular Blood Pressure Monitor LS802-GP is a digital monitor intended for use in measuring blood pressure and heartbeat rate with arm circumference ranging from 22 cm to 32 cm, 22 cm to 42 cm, 22 cm to 45 cm. The device can be used to detect irregular heartbeat. It is intended for adult, home use.

♥ Contraindications















- 1.The device is not suitable for use on the women who are or may be pregnant.
- 2.The device is not suitable for use on patients with implanted,electrical devices, such as cardiac pacemakers, defibrillators.

♥ Measurement Principle

This product uses the Oscillometric Measuring method to detect blood pressure. Before every measurement, the unit establishes a “zero pressure” equivalent to the atmospheric pressure. Then it starts inflating the arm cuff, meanwhile, the unit detects pressure oscillations generated by beat-to-beat pulsatile, which is used to determine the systolic and diastolic pressure, and also pulse rate.

♥ Safety Information

The symbols below might be in the user manual, labeling or other component. They are the requirement of standard and using.

	Refer to instruction manual/booklet To signify that the instruction manual/booklet must be read.		Type BF applied part
	Direct Current		Serial Number
	Date and Country of manufacture		Manufacturer
	Recyclable		Temperature limit
	Atmospheric pressure limitation		Humidity limitation
	For indoor use only		Symbol for “Class II Equipment”
	MR Unsafe To identify an item which poses unacceptable risks to the patient, medical staff or other persons within the MR environment.		
	Caution Indicates that caution is necessary when operating the device or control close to where the symbol is placed, or that the current situation needs operator awareness or operator action in order to avoid undesirable consequences.		
	The symbol indicates that the product should not be discarded as unsorted waste but must be sent to separate collection facilities for recovery and recycling.		

 CAUTION

- * This device is intended for indoor, home use.
- * This device is not intended for public use.
- * This device is portable, but it is not intended for use during patient transport.
- * This device is not suitable for continuous monitoring during medical emergencies or operations.
- * This device is intended for non-invasive measuring and monitoring of arterial blood pressure. It is not intended for use on extremities other than the arm, or for any purpose other than obtaining a blood pressure measurement.
- * This device is for adults. Do not use this device on neonates or infants. Do not use it on children unless otherwise instructed by a medical professional.
- * Do not use on the women in pregnant, including pre-eclamptic, patients.
- * The device is not suitable for use on patients with implanted, electrical devices, such as cardiac pacemakers, defibrillators.
- * The effectiveness of this device has not been established for use:
 - on users with common arrhythmias such as atrial or ventricular premature beats or atrial fibrillation,
 - on users with peripheral arterial disease,
 - on users undergoing intravascular therapy, or with arteriovenous (AV) shunt.
 Consult a medical professional before use.
- * Do not use this device for diagnosis or treatment of any health problem or disease. Contact your physician if you have or suspect any medical problem. Do not change your medications without the advice of your physician or health care professional.
- * If you are taking medication, consult your physician to determine the proper time to measure your blood pressure.
- * This device may be used only for the intended use described in this manual, the manufacturer shall have no liability for any incidental, consequential, or special damages caused by misuse or abuse.
- * Report any unexpected operation or events to the manufacturer.
- * Do not apply the cuff on an arm that has an intravenous drip or a blood transfusion attached.
- * Warning: Do not kink, fold, stretch, compress, or otherwise deform the tube during measuring, as the cuff pressure might continuously increase, which could prevent blood flow and result injury.
- * Warning: Taking blood pressure measurements too frequently could disrupt blood circulation and cause injuries.
- * Warning: Do not apply cuff to areas on patient where skin is delicate or damaged. Check cuff site frequently for irritation.
- * Warning: Do not place the cuff on the arm of a person whose arteries or veins are undergoing medical treatment, i.e. intra-vascular access or intra-vascular therapy or an arteriovenous (A-V) shunt, which could disrupt blood circulation and cause injuries.
- * Do not place the cuff on the arm on the same side of a mastectomy (especially when lymph nodes have been removed). It is recommended to take measurements on the unaffected side.
- * Do not wrap the cuff on the same arm to which another monitoring device is applied. One or both devices could temporarily stop functioning if you try to use them at the same time.
- * Please check that the operation of the device do not result in prolonged impairment of patient blood circulation.
- * Warning: On the rare occasion of a fault causing the cuff to remain fully inflated during measurement, loosen and remove the cuff immediately. Prolonged high pressure applied to the arm (cuff pressure >300 mmHg or constant pressure >15 mmHg for more than 3 minutes) might lead to bruising and discolored skin.
- * Warning: Do not use this device with high-frequency (HF) surgical equipment at the same time.





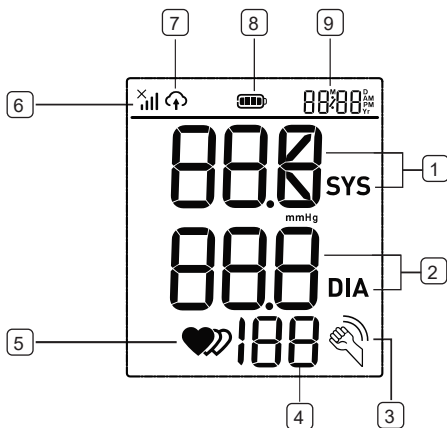

 CAUTION

- * Warning: This device is not AP/APG equipment. Do not use the device where flammable anesthetic are present, or in environments mixture with air of with oxygen or nitrous oxide.
- * The device contains sensitive electronic components. To avoid measurement errors, avoid taking blood pressure measurements near a strong electromagnetic field radiated interference signal or electrical fast transient/burst signal.
- * Wireless communication equipment, such as wireless home network devices, mobile phones, cordless telephones and their base stations, walkie-talkies may cause interference that may affect the accuracy of measurements. A minimum distance of 1 foot (30 cm) should be kept from such devices during a measurement.
- * You can use this device to take your own measurement, no third-party operator is required.
- * Please use the device under the environment which is provided in the user manual. Otherwise, the performance and lifetime of the device will be impacted and reduced.
- * The device may require up to 30 minutes to warm up / cool down from the minimum / maximum storage temperature before it is ready for use.
- * Warning: Excessive cuff tube lengths could cause strangulation if you don't manage them properly.
- * Warning: Do not touch output of the batteries/adaptor and the user simultaneously.
- * Adaptor is specified as a part of ME EQUIPMENT.
- * Warning: The power cord is considered the disconnect device for isolating this equipment from supply mains. Do not position the equipment so that it is difficult to reach or disconnect.
- * The blood pressure monitor, its adaptor, and the cuff are suitable for use within the patient environment.
- * Warning: Do not use this device if you are allergic to polyester, nylon, or plastic.
- * Warning: Only use accessories approved by manufacturer. Using unapproved accessories might cause damage to the unit and injure users.
- * Warning: If you experience discomfort during a measurement, such as pain in the arm or other complaints, press the Power button immediately to release the air from the cuff.
- * No calibration is required within two years of reliable service.
- * Do not attempt to repair the unit yourself if it malfunctions. Only have repairs carried out by authorized service centers.
- * At the request of authorized service personnel, circuit diagrams, component part lists, descriptions, and calibration procedures will be made available by the manufacturer or distributor.
- * It is recommended that the performance should be checked after repair, maintenance, and every two years of use, by retesting the requirements in limits of the error of the cuff pressure indication and air leakage (testing at least at 50 mmHg and 200 mmHg).
- * Warning: Do not use the device while under maintenance, or being serviced.
- * Store your device, cuff and adaptor in a clean and dry place, protect it against extreme moisture, heat, lint, dust and direct sunlight. Never place any heavy objects on it.
- * Make sure the rubber tube of the cuff is not squeezed, stretched, or kinked during storage.
- * Warning: Keep the device, cuff, and batteries away from children as they may pose a risk of choking or strangulation if used improperly.
- * Clean both device and cuff with a soft, dry cloth. If necessary use a dampened cloth and natural detergent. Do not use alcohol, benzene, or other harsh chemicals.
- * Do not wash the cuff in a washing machine or dishwasher!
- * The service life of the cuff may vary by the frequency of washing, skin condition, and storage state. The typical service life is 10000 times.
- * Dispose of accessories, detachable parts, and the device according to the local guidelines.

♥ Display and Symbols



- | | | | |
|---|--|---|-------------------------------------|
| 1 | Systolic blood pressure reading | 6 | Signal indication |
| 2 | Diastolic blood pressure reading | 7 | Data transmission indication |
| 3 | Excessive body motion detector symbol | 8 | Battery symbol / Low battery symbol |
| 4 | Pulse display | 9 | Date / Time display |
| 5 | Heartbeat symbol / Irregular heartbeat | | |

SYMBOL	EXPLANATION
1	Systolic blood pressure reading
2	Diastolic blood pressure reading
3	 Excessive body motion detector symbol Appears when talking, moving, or shaking of the arm with the cuff on is detected during a measurement. NOTE: The measured blood pressure reading may not be accurate when this symbol is displayed with the reading.
4	Pulse display
5	 Heartbeat symbol Flashes when detected during the measurement.
	 Irregular heartbeat symbol Appears when detected during a measurement. Refer to page 17 for more information.
6	 Signal indication Indicates the signal situation in the communication process.
7	 Data transmission indication Appears on the LCD display and flash when the measurement data is being sent. If the data transmission is a success, oK is shown.
8	 Battery symbol / Low battery symbol Indicate the battery is low when both symbols  appear on the LCD display.
9	Date / Time display

♥ Name of Each Part

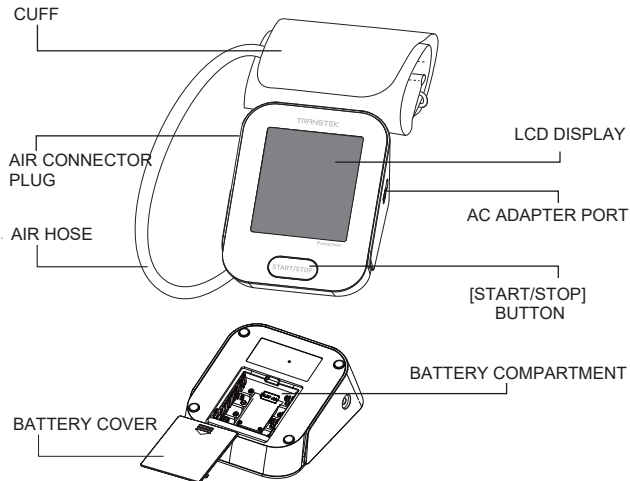

♥ Contents/Product Includes

- Pro Cellular Blood Pressure Monitor (LS802-GP)
- Cuff (Type BF applied part)
 - Upper arm circumference: 22-32 cm
 - Upper arm circumference: 22-42 cm
 - Upper arm circumference: 22-45 cm
- User Manual
- Quick Start Guide
- 4x AA batteries

♥ The Choice of Power Supply

1. Battery powered mode:
6V DC 4× AA batteries
2. AC adapter powered mode: 6V  1A
Please use the AC adapter authorized by the manufacturer!

Please unplug the adapter to depart from the using utility power, when you finish the measurement.

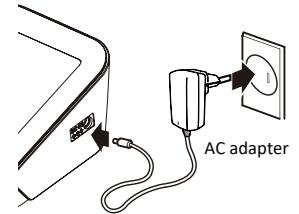

⚠ CAUTION

In order to get the best effect and protect your monitor, please use the right batteries and special power adapter which complies with local safety standard.

♥ Installing and Replacing the Batteries

- Slide off the battery cover.
- Install or replace 4 AA size batteries according to the polarity indications inside the battery compartment.
- Place back the battery cover.

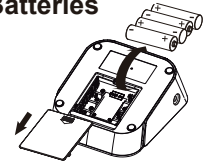

Replace the batteries whenever the below happens

- Both symbols   appear on the LCD display
- The display dims
- The display does not light up

⚠ CAUTION

- Do not use new and used batteries together.
- Do not use different types of batteries together.
- Do not dispose the batteries in fire. Batteries may explode or leak.
- Remove batteries if the device is not likely to be used for some time.
- Worn batteries are harmful to the environment. Do not dispose with daily garbage.
- Remove the old batteries from the device following your local recycling guidelines.

Note

When you insert or replace batteries into the device, the symbol \square and \square will display on the LCD alternately. This indicates that the device is searching and pairing with a mobile network.

You can long press the "START/STOP" button to end pairing and use the device. If you manually cancel pairing, the device may take longer to send a measurement after use.

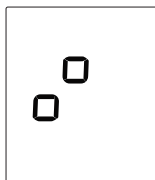
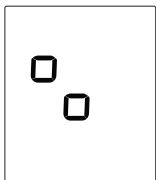

If successful, the symbol [] will be shown on the LCD. You can then utilize the device as normal by pressing the "START/STOP" button.

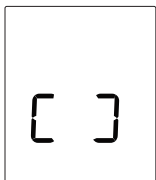

If unsuccessful, the monitor will power off automatically after several minutes.

♥ Applying the cuff

1. Remove all jewelry, such as watches and bracelets from your left arm.

Note: If your doctor has diagnosed you with poor circulation in your left arm, use your right arm.

2. Roll or push up your sleeve to expose the skin. Make sure your sleeve is not too tight.

3. Hold your arm with palm facing up and tie the cuff on your upper arm, then position the tube off-center toward the inner side of arm in line with the little finger. Or position the artery mark ϕ over the main artery (on the inside of your arm).

Note: Locate the main Artery by pressing with 2 fingers approximately 2 cm above the bend of your elbow on the inside of your left arm.

Identify where the pulse can be felt the strongest, that is your main Artery!

4. Make sure the bottom edge of the cuff 1 inch (2-3 cm) above the inside elbow. Then wrap the cuff securely.

Note: The cuff should be snug but not too tight. You should be able to insert one finger between the cuff and your arm.

5. Sit upright in a comfortable chair with your back against the backrest of the chair. Keep your feet flat and your legs uncrossed.

Place your arm resting comfortably on a flat table. The cuff worn on your arm should be placed at the same level as your right atrium of the heart.

6. Take 5-6 deep breaths and let's start measuring!

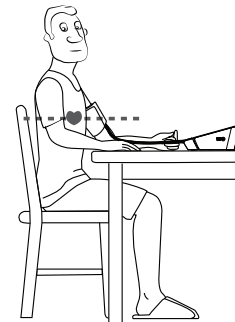
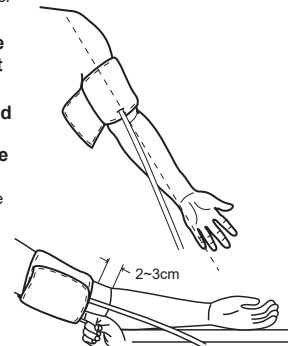

♥ Taking a Measurement

Helpful tips to help ensure an accurate reading

- Take the measurement in a silent room.
- Rest for 5 minutes before a measurement.
- Be relaxed, Remain still and DO NOT talk while taking a measurement.
- For a meaningful comparison, try to measure under similar conditions. For example, take daily measurements at approximately the same time, on the same arm, or as directed by a physician.

Start a measurement

1. When the monitor is off, press the “START/STOP” button to turn on, and then it will complete the whole measurement automatically.



LCD display

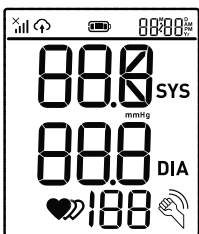

Inflating and measuring

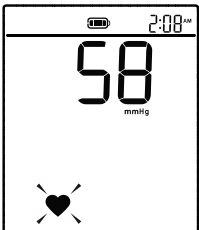

Adjust the zero point

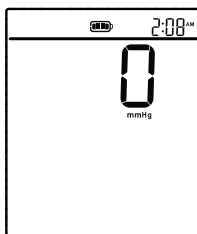

Display the measured result

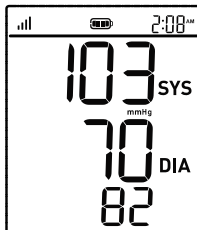

2. After the measurement, the data transmission starts. The symbol  will blink on the LCD.

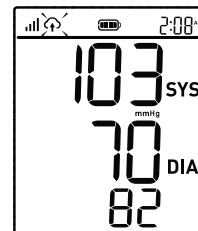

If successful, the symbol  will disappear and the LCD will display “OK”.

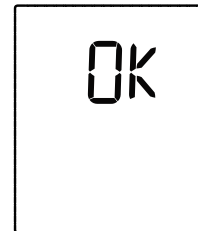

Press the “START/STOP” button to turn off the device, otherwise it will power off automatically after about 1 minute.

If unsuccessful, an error message (“E5” or “E6” for example) will display on the LCD for about 1 minute and then the device will power off.

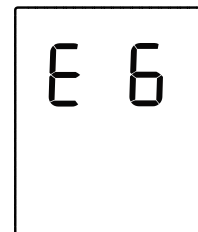

Note

In the case of a data transmission failure (E5 or E6), up to 60 measurements are saved on the device and will be sent when a successful connection is achieved.

Tip

You can press the “START/ STOP” button to stop the measurement any time.



♥ Tips for Measurement

Measurements may be inaccurate if taken in the following circumstances.



Within 1 hour
after dinner or drinking



Immediate measurement
after tea, coffee, smoking



Within 20 minutes after taking a bath



When talking or moving your fingers

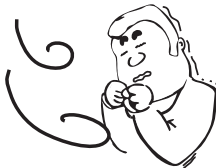

In a very cold environment



When you want to discharge urine



♥ Maintenance

In order to get the best performance, please follow the instructions below.



Put in a dry place
and avoid the sunshine



Avoid touching water,
clean it with a dry cloth in case.



Avoid intense shaking
and collisions



Avoid dusty and unstable
temperature environment



Using wet cloths to
remove dirt



Do not attempt to clean the reusable
cuff with water and never immerse
the cuff in water.

♥ What are systolic pressure and diastolic pressure?

When ventricles contract and pump blood out of the heart, the blood pressure reaches its maximum value in the cycle, which is called systolic pressure. When the ventricles relax, the blood pressure reaches its minimum value in the cycle, which is called diastolic pressure.

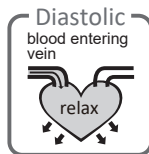
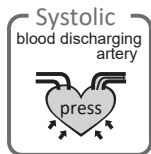

♥ What is the standard blood pressure classification?

The following chart is the standard blood pressure classification published by American Heart Association (AHA).

This chart reflects blood pressure categories defined by American Heart Association.

Blood Pressure Category	Systolic mmHg (upper#)		Diastolic mmHg (lower#)
Normal	less than 120	and	less than 80
Elevated	120-129	and	less than 80
High Blood Pressure (Hypertension) Stage 1	130-139	or	80-89
High Blood Pressure (Hypertension) Stage 2	140 or higher	or	90 or higher
Hypertensive Crisis (Consult your doctor immediately)	Higher than 180	and/or	Higher than 120

⚠ CAUTION

Only a physician can tell your normal BP range. Please contact a physician if your measuring result falls out of the range. Please note that only a physician can tell whether your blood pressure value has reached a dangerous point.

♥ Irregular Heartbeat Detector

An irregular heartbeat is detected when a heartbeat rhythm varies while the unit is measuring the systolic and diastolic blood pressure. During each measurement, the monitor records all the pulse intervals and calculate the average; if there are two or more pulse intervals, the difference between each interval and the average is more than the average value of $\pm 25\%$, or there are four or more pulse intervals, the difference between each interval and the average is more than the average value of $\pm 15\%$, the irregular heartbeat symbol appears on the display when the measurement results are appeared.

⚠ CAUTION

The appearance of the IHB icon indicates that a pulse irregularity consistent with an irregular heart-beat was detected during measurement. Usually this is NOT a cause for concern. However, if the symbol appears often, we recommend you seek medical advice. Please note that the device does not replace a cardiac examination, but serves to detect pulse irregularities at an early stage.

♥ Why does my blood pressure fluctuate throughout the day?

1. Individual blood pressure varies multiple times everyday. It is also affected by the way you tie your cuff and your measurement position, so please take the measurement under the same conditions.
2. If the person takes medicine, the pressure will vary more.
3. Wait at least 3 minutes for another measurement.



♥ Why do I get different blood pressure at home compared to the hospital?

The blood pressure is different even throughout the day due to weather, emotion, exercise etc. Also, there is the "white coat" effect, which means blood pressure usually increases in clinical settings.

What you need to pay attention to when you measure your blood pressure at home:

If the cuff is tied properly.
 If the cuff is too tight or too loose.
 If the cuff is tied on the upper arm.
 If you feel anxious.
 Taking 2-3 deep breaths before beginning will be better for measuring.
 Advice: Relax yourself for 4-5 minutes until you calm down.

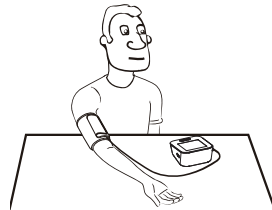

♥ Is the result the same if measuring on the right arm?

It is ok for both arms, but there will be some different results for different people. We suggest you measure the same arm every time.

If any abnormality arises during use, please check the following points:

PROBLEM	SYMPTOM	CHECK THIS	REMEDY
No power	Display can not light up.	Batteries are exhausted.	Replace with new batteries.
		Batteries are installed incorrectly or Adapter is not plugged in properly.	Install the batteries or plug in the adapter properly.
High Battery	H bAt shows	The supply voltage is too high.	Replace with the authorized adapter.
Low Battery	Lo shows	The battery is too low.	Replace with new batteries.
Error message	E 1 shows	The cuff is not wrapped or wrapped incorrectly, or the cuff air plug is loose.	Refasten the cuff and insert air tube plug correctly then measure again.
	E 2 or shows	Excessive body motion (such as shaking of the arm with the cuff on) or Pulse is weak during a measuring.	Relax for 5 minutes, and then keep still, measure again.
	E 3 shows	Pulse is not detected during measuring.	Loosen the clothing on the arm and then measure again.
	E 4 shows	The measurement failed.	Relax for 5 minutes and measure again.
	E 5 shows	Failed to communicate with the server	Try a place with better signal, or contact customer service
	E 6 shows	Radio communication failure	Contact customer service
	EExx shows	Hardware error (xx can be some digital symbol, such as 1, 2, etc.)	Turn off monitor and measure again. If EEx still appears on the display, please contact the retailer or our customer service.
Warning message	out shows	Out of measurement range	Relax for a moment. Refasten the cuff and then measure again. If the problem persists, contact your physician.

NOTE: If the product still does not work, contact the Customer Service. Under no circumstance should you disassemble or attempt to repair the unit by yourself.

External dimensions	Approx.159.2 mm × 121.5 mm × 68.1 mm
Display mode	Digital LCD V.A. 78 mm × 92 mm
Weight	Approx.393 g (Excluding the batteries and cuff)
Measurement mode	Oscillographic testing mode
Mode of operation	Continuous operation
Measurement range	Rated cuff pressure: 0 mmHg ~ 299 mmHg Measurement pressure: SYS: 60 mmHg ~ 230 mmHg DIA: 40 mmHg ~ 130 mmHg Pulse value: (40-199) beat/minute
Accuracy	Pressure: 5°C-40°C within ±3 mmHg Pulse value: ±5%
Normal working condition	Temperature: +5°C to +40°C Relative humidity: 15% to 90%, non-condensing, but not requiring a water vapour partial pressure greater than 50 hPa Atmospheric pressure: 700 hPa to 1060 hPa
Storage & transportation condition	Temperature: -20°C to +60°C Relative humidity: ≤93%, non-condensing, at a water vapour pressure up to 50 hPa
Measurement perimeter of the upper arm	About 22-32cm, 22-42 cm, 22-45cm
Degree of protection	Type BF applied part
Protection against ingress of water	IP21, It means the device could protected against solid foreign objects of 12.5 mm and greater, and protect against vertically falling water drops.
Device Classification	Battery Powered Mode: Internally Powered ME Equipment AC Adaptor Powered Mode: Class II ME Equipment

WARNING: No modification of this equipment is allowed.

♥ Authorized Component

Please use the authorized adapter (Not included).

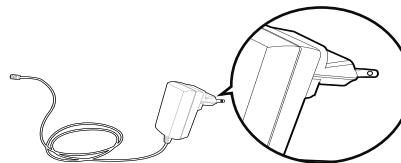

Adapter

Type: BLJ06L060100P-U

Input: 100-240V, 50-60Hz, 0.2A max

Output: 6V $\overline{\text{---}}$ 1000 mA

♥ Contact Information

For more information about our products, please visit www.transtekcorp.com.

Company: Guangdong Transtek Medical Electronics Co., Ltd.

Address: Zone A, No.105, Dongli Road, Torch Development District, Zhongshan, 528437, Guangdong, China

♥ FCC Statement

FCC ID: OU9LS802GPM3

This device complies with Part 15 of the FCC Rules. Operation is subject to the following two conditions: (1) this device may not cause harmful interference, and (2) this device must accept any interference received, including interference that may cause undesired operation.

Caution: The user is cautioned that changes or modifications not expressly approved by the party responsible for compliance could void the user's authority to operate the equipment.

NOTE: This equipment has been tested and found to comply with the limits for a Class B digital device, pursuant to Part 15 of the FCC Rules. These limits are designed to provide reasonable protection against harmful interference in a residential installation. This equipment generates, uses and can radiate radio frequency energy and, if not installed and used in accordance with the instructions, may cause harmful interference to radio communications. However, there is no guarantee that interference will not occur in a particular installation.

If this equipment does cause harmful interference to radio or television reception, which can be determined by turning the equipment off and on, the user is encouraged to try to correct the interference by one or more of the following measures:

- Reorient or relocate the receiving antenna.
- Increase the separation between the equipment and receiver.
- Connect the equipment into an outlet on a circuit different from that to which the receiver is connected.
- Consult the dealer or an experienced radio/TV technician for help.

FCC Radiation Exposure Statement:

To maintain compliance with FCC's RF Exposure guidelines, this equipment should be installed and operated with minimum distance between 20cm the radiator your body: Use only the supplied antenna.

♥ EMC Guidance

The ME EQUIPMENT or ME SYSTEM is suitable for home healthcare environments.

Warning: Don't be near the active HF surgical equipment and the RF shielded room of an ME system for magnetic resonance imaging, where the intensity of EM disturbances is high.

Warning: Use of this equipment adjacent to or stacked with other equipment should be avoided because it could result in improper operation. If such use is necessary, this equipment and the other equipment should be observed to verify that they are operating normally.

Warning: Use of accessories, transducers and cables other than those specified or provided by the manufacturer of this equipment could result in increased electromagnetic emissions or decreased electromagnetic immunity of this equipment and result in improper operation.

Warning: Portable RF communications equipment (including peripherals such as antenna cables and external antennas) should be used no closer than 30 cm (12 inches) to any part of the equipment LS802-GP, including cables specified by the manufacturer. Otherwise, degradation of the performance of this equipment could result.

Technical description:

1. All necessary instructions for maintaining BASIC SAFETY and ESSENTIAL PERFORMANCE with regard to electromagnetic disturbances for the excepted service life.
2. Guidance and manufacturer's declaration-electromagnetic emissions and Immunity.

Table 1

Guidance and manufacturer's declaration - electromagnetic emissions	
Emissions test	Compliance
RF emissions CISPR 11	Group 1
RF emissions CISPR 11	Class B
Harmonic emissions IEC 61000-3-2	Class A
Voltage fluctuations / flicker emissions IEC 61000-3-3	Comply

Table 2

Guidance and manufacturer's declaration – electromagnetic Immunity		
Immunity Test	IEC 60601-1-2 Test level	Compliance level
Electrostatic discharge (ESD) IEC 61000-4-2	±8 kV contact ±2 kV, ±4 kV, ±8 kV, ±15 kV air	±8 kV contact ±2 kV, ±4 kV, ±8 kV, ±15 kV air
Electrical fast transient/burst IEC 61000-4-4	±1 kV ±2 kV, 100 kHz repetition frequency	For AC power port: Power supply lines: ±2 kV
Surge IEC61000-4-5	±1 kV (Line to ±0.5 kV line) ±0.5 kV ±1 kV ±2 kV (Line to ground) ±2 kV Signal line (LAN line)	For AC power port: Line to lines: ±1 kV
Voltage dips, short interruptions and voltage variations on power supply input lines IEC 61000-4-11	0%, 70%, 0% of U _T	For AC power port: 0% for 0,5 cycle, 0" for 1 cycle 70% for 25 cycles; Single phase: 0% for 250 cycle
Power frequency magnetic field IEC 61000-4-8	30 A/m 50 Hz / 60 Hz	30 A/m 50 Hz / 60 Hz
Conducted RF IEC61000-4-6	0,15 MHz – 80 MHz 3 V ISM and amateur radio bands between 0,15 MHz and 80 MHz 6 V	For AC power port: 3 Vrms 6 Vrms (in ISM and amateur radio bands) 80% AM at 1 KHz
Radiated RF IEC61000-4-3	10 V/m 80 MHz – 2,7 GHz 80% AM at 1 kHz	10 V/m 80 MHz – 2,7 GHz 80% AM at 1 kHz
NOTE U _T is the a.c. mains voltage prior to application of the test level.		

Table 3

Guidance and manufacturer's declaration - electromagnetic immunity								
Radiated RF IEC61000-4-3 (Test specifications for ENCLOSURE PORT IMMUNITY to RF wireless communications equipment)	Test Frequency (MHz)	Band (MHz)	Service	Modulation	Maximum Power (W)	Distance (m)	IEC 60601-1-2 Test Level (V/m)	Compliance level (V/m)
	385	380-390	TETRA 400	Pulse modulation 18 Hz	1.8	0.3	27	27
	450	430-470	GMRS 460, FRS 460	FM ± 5k Hz deviation 1 kHz sine	2	0.3	28	28
	710	704-787	LTE Band 13, 17	Pulse modulation 217 Hz	0.2	0.3	9	9
	745							
	780							
	810	800-960	GSM 800/900, TETRA 800, iDEN 820, CDMA 850, LTE Band 5	Pulse modulation 18 Hz	2	0.3	28	28
	870							
	930							
	1720	1700-1990	GSM 1800; CDMA 1900; GSM 1900; DECT; LTE Band 1, 3, 4, 25; UMTS	Pulse modulation 217 Hz	2	0.3	28	28
	1845							
	1970							
	2450	2400-2570	Bluetooth, WLAN, 802.11 b/g/n, RFID 2450, LTE Band 7	Pulse modulation 217 Hz	2	0.3	28	28
5240	5100-5800	WLAN 802.11 a/n	Pulse modulation 217 Hz	0.2	0.3	9	9	
5500								
5785								