



CFR 47 FCC PART 15 SUBPART C

CERTIFICATION TEST REPORT

For

Blood Pressure Monitor

MODEL NUMBER: LC-BP01

FCC ID: OU9LC-BP01-B

REPORT NUMBER: 4789859486-1

ISSUE DATE: March 26, 2021

Prepared for

**Guangdong Transtek Medical Electronics Co.,Ltd
Zone A, No.105, Dongli Road, Torch Development
District, Zhongshan, 528437, Guangdong, China**

Prepared by

UL Verification Services (Guangzhou) Co., Ltd, Song Shan Lake Branch

Building 10, Innovation Technology Park, No. 1, Li Bin Road, Song Shan Lake Hi-Tech Development Zone Dongguan, 523808, People's Republic of China

Tel: +86 769 22038881

Fax: +86 769 33244054

Website: www.ul.com



Revision History

<u>Rev.</u>	<u>Issue Date</u>	<u>Revisions</u>	<u>Revised By</u>
V0	03/26/2021	Initial Issue	



Summary of Test Results			
Clause	Test Items	FCC Rules	Test Results
1	6dB Bandwidth and 99% Occupied Bandwidth	FCC Part 15.247 (a) (2)	Pass
2	Peak Conducted Output Power	FCC Part 15.247 (b) (3)	Pass
3	Power Spectral Density	FCC Part 15.247 (e)	Pass
4	Conducted Bandedge and Spurious Emission	FCC Part 15.247 (d)	Pass
5	Radiated Bandedge and Spurious Emission	FCC Part 15.247 (d) FCC Part 15.209 FCC Part 15.205	Pass
6	Conducted Emission Test for AC Power Port	FCC Part 15.207	Pass
7	Antenna Requirement	FCC Part 15.203	Pass
Note: 1. This test report is only published to and used by the applicant, and it is not for evidence purpose in China. 2. The measurement result for the sample received is <Pass> according to < CFR 47 FCC PART 15 SUBPART C > when <Accuracy Method> decision rule is applied.			



TABLE OF CONTENTS

1. ATTESTATION OF TEST RESULTS.....	6
2. TEST METHODOLOGY	7
3. FACILITIES AND ACCREDITATION.....	7
4. CALIBRATION AND UNCERTAINTY	8
4.1. <i>MEASURING INSTRUMENT CALIBRATION</i>	<i>8</i>
4.2. <i>MEASUREMENT UNCERTAINTY</i>	<i>8</i>
5. EQUIPMENT UNDER TEST	9
5.1. <i>DESCRIPTION OF EUT</i>	<i>9</i>
5.2. <i>CHANNEL LIST.....</i>	<i>9</i>
5.3. <i>MAXIMUM PEAK OUTPUT POWER</i>	<i>9</i>
5.4. <i>TEST CHANNEL CONFIGURATION.....</i>	<i>9</i>
5.5. <i>THE WORSE CASE POWER SETTING PARAMETER.....</i>	<i>10</i>
5.6. <i>DESCRIPTION OF AVAILABLE ANTENNAS</i>	<i>10</i>
5.7. <i>DESCRIPTION OF TEST SETUP</i>	<i>11</i>
6. MEASURING INSTRUMENT AND SOFTWARE USED.....	12
7. ANTENNA PORT TEST RESULTS	14
7.1. <i>ON TIME AND DUTY CYCLE</i>	<i>14</i>
7.2. <i>6 dB DTS BANDWIDTH AND 99 % OCCUPIED BANDWIDTH.....</i>	<i>15</i>
7.3. <i>CONDUCTED OUTPUT POWER</i>	<i>17</i>
7.4. <i>POWER SPECTRAL DENSITY</i>	<i>18</i>
7.5. <i>CONDUCTED BANDEDGE AND SPURIOUS EMISSIONS</i>	<i>20</i>
8. RADIATED TEST RESULTS	22
8.1. <i>RESTRICTED BANDEDGE</i>	<i>27</i>
8.1.1. <i>LE 1M MODE</i>	<i>27</i>
8.2. <i>SPURIOUS EMISSIONS (1 GHz ~ 3 GHz).....</i>	<i>30</i>
8.2.1. <i>LE 1M MODE</i>	<i>30</i>
8.3. <i>SPURIOUS EMISSIONS (3 GHz ~ 18 GHz).....</i>	<i>36</i>
8.3.1. <i>LE 1M MODE</i>	<i>36</i>
8.4. <i>SPURIOUS EMISSIONS (18 GHz ~ 26 GHz).....</i>	<i>42</i>
8.4.1. <i>LE 1M MODE</i>	<i>42</i>
8.5. <i>SPURIOUS EMISSIONS (30 MHz ~ 1 GHz).....</i>	<i>44</i>
8.5.1. <i>LE 1M MODE</i>	<i>44</i>
8.6. <i>SPURIOUS EMISSIONS BELOW 30 MHz</i>	<i>46</i>
8.6.1. <i>LE 1M MODE</i>	<i>46</i>



9. AC POWER LINE CONDUCTED EMISSIONS	49
9.1. LE 1M MODE	50
10. ANTENNA REQUIREMENTS	52
11. Appendix	53
11.1. Appendix A: DTS Bandwidth.....	53
11.1.1. Test Result.....	53
11.1.2. Test Graphs	54
11.2. Appendix B: Occupied Channel Bandwidth	55
11.2.1. Test Result.....	55
11.2.2. Test Graphs	56
11.3. Appendix C: Maximum peak conducted output power.....	57
11.3.1. Test Result.....	57
11.4. Appendix D: Maximum power spectral density.....	58
11.4.1. Test Result.....	58
11.4.2. Test Graphs	59
11.5. Appendix E: Band edge measurements	60
11.5.1. Test Result.....	60
11.5.2. Test Graphs	61
11.6. Appendix F: Conducted Spurious Emission.....	62
11.6.1. Test Result.....	62
11.6.2. Test Graphs	63
11.7. Appendix G: Duty Cycle.....	66
11.7.1. Test Result.....	66
11.7.2. Test Graphs	67



1. ATTESTATION OF TEST RESULTS

Applicant Information

Company Name: Guangdong Transtek Medical Electronics Co.,Ltd
Address: Zone A,No.105,Dongli Road,Torch Development District,Zhongshan,528437,Guangdong,China

Manufacturer Information

Company Name: Guangdong Transtek Medical Electronics Co.,Ltd
Address: Zone A,No.105,Dongli Road,Torch Development District,Zhongshan,528437,Guangdong,China

EUT Information

EUT Name: Blood Pressure Monitor
Model: LC-BP01
Brand: APEMAN
Serial Number: BA552112010120006
Sample Received Date: March 16, 2021
Sample Status: Normal
Sample ID: 3713835
Date of Tested: March 17, 2021 ~ March 25, 2021

APPLICABLE STANDARDS	
STANDARD	TEST RESULTS
CFR 47 FCC PART 15 SUBPART C	PASS

Prepared By:

Denny Huang
Project Engineer

Checked By:

Shawn Wen
Laboratory Leader

Approved By:

Stephen Guo
Laboratory Manager



2. TEST METHODOLOGY

The tests documented in this report were performed in accordance with KDB 558074 D01 15.247 Meas Guidance v05r02, 414788 D01 Radiated Test Site v01r01, CFR 47 FCC Part 2, CFR 47 FCC Part 15, ANSI C63.10-2013

3. FACILITIES AND ACCREDITATION

Accreditation Certificate	<p>A2LA (Certificate No.: 4102.01) UL Verification Services (Guangzhou) Co., Ltd. Song Shan Lake Branch. has been assessed and proved to be in compliance with A2LA.</p> <p>FCC (FCC Designation No.: CN1187) UL Verification Services (Guangzhou) Co., Ltd. Song Shan Lake Branch. Has been recognized to perform compliance testing on equipment subject to the Commission's Declaration of Conformity (DoC) and Certification rules</p> <p>ISED (Company No.: 21320) UL Verification Services (Guangzhou) Co., Ltd. Song Shan Lake Branch. has been registered and fully described in a report filed with ISED. The Company Number is 21320 and the test lab Conformity Assessment Body Identifier (CABID) is CN0046.</p> <p>VCCI (Registration No.: G-20019, R-20004, C-20012 and T-20011) UL Verification Services (Guangzhou) Co., Ltd. Song Shan Lake Branch. has been assessed and proved to be in compliance with VCCI, the Membership No. is 3793. Facility Name: Chamber D, the VCCI registration No. is G-20019 and R-20004 Shielding Room B, the VCCI registration No. is C-20012 and T-20011</p>
---------------------------	--

Note 1: All tests measurement facilities use to collect the measurement data are located at Building 10, Innovation Technology Park, Song Shan Lake Hi tech Development Zone, Dongguan, 523808, China

Note 2: The test anechoic chamber in UL Verification Services (Guangzhou) Co., Ltd. Song Shan Lake Branch had been calibrated and compared to the open field sites and the test anechoic chamber is shown to be equivalent to or worst case from the open field site.

Note 3: For below 30 MHz, lab had performed measurements at test anechoic chamber and comparing to measurements obtained on an open field site. And these measurements below 30 MHz had been correlated to measurements performed on an OFS.



4. CALIBRATION AND UNCERTAINTY

4.1. MEASURING INSTRUMENT CALIBRATION

The measuring equipment utilized to perform the tests documented in this report has been calibrated in accordance with the manufacturer's recommendations and is traceable to recognize national standards.

4.2. MEASUREMENT UNCERTAINTY

Where relevant, the following measurement uncertainty levels have been estimated for tests performed on the apparatus:

Test Item	Uncertainty
Conduction emission	3.62 dB
Radiated Emission (Included Fundamental Emission) (9 kHz ~ 30 MHz)	2.2 dB
Radiated Emission (Included Fundamental Emission) (30 MHz ~ 1 GHz)	4.00 dB
Radiated Emission (Included Fundamental Emission) (1 GHz to 26 GHz)	5.78 dB (1 GHz ~ 18 GHz)
	5.23 dB (18 GHz ~ 26 GHz)
Duty Cycle	±0.028%
DTS and 99% Occupied Bandwidth	±0.0196%
Maximum Conducted Output Power	±0.686 dB
Maximum Power Spectral Density Level	±0.743 dB
Conducted Band-edge Compliance	±1.328 dB
Conducted Unwanted Emissions In Non-restricted Frequency Bands	±0.746 dB (9 kHz ~ 1 GHz)
	±1.328dB (1 GHz ~ 26 GHz)
Note: This uncertainty represents an expanded uncertainty expressed at approximately the 95% confidence level using a coverage factor of k=2.	

5. EQUIPMENT UNDER TEST

5.1. DESCRIPTION OF EUT

EUT Name	Blood Pressure Monitor	
Test Model	LC-BP01	
Technology	Bluetooth - Low Energy	
Transmit Frequency Range	2402 MHz ~ 2480 MHz	
Modulation	GFSK	
Data Rate	LE 1M	1 Mbps
Power Supply	DC 5 V by USB	
Battery	DC 3.7 V, 1000 mAh	

5.2. CHANNEL LIST

Channel	Frequency (MHz)	Channel	Frequency (MHz)	Channel	Frequency (MHz)	Channel	Frequency (MHz)
0	2402	11	2424	22	2446	33	2468
1	2404	12	2426	23	2448	34	2470
2	2406	13	2428	24	2450	35	2472
3	2408	14	2430	25	2452	36	2474
4	2410	15	2432	26	2454	37	2476
5	2412	16	2434	27	2456	38	2478
6	2414	17	2436	28	2458	39	2480
7	2416	18	2438	29	2460	/	/
8	2418	19	2440	30	2462	/	/
9	2420	20	2442	31	2464	/	/
10	2422	21	2444	32	2468	/	/

5.3. MAXIMUM PEAK OUTPUT POWER

Test Mode	Frequency (MHz)	Channel Number	Maximum Peak Output Power (dBm)
LE 1M	2402 ~ 2480	0-39[40]	5.33

5.4. TEST CHANNEL CONFIGURATION

Test Mode	Test Channel	Frequency
LE 1M	CH 0(Low Channel), CH 19(MID Channel), CH 39(High Channel)	2402 MHz, 2440 MHz, 2480 MHz

**5.5. THE WORSE CASE POWER SETTING PARAMETER**

The Worst Case Power Setting Parameter under 2402 ~ 2480MHz Band				
Test Software Version		ESP_RF_test_tool_v2.5		
Test Mode	Transmit Antenna Number	Test Software Setting Value		
		CH 0	CH 19	CH 39
LE 1M	1	4	4	4

5.6. DESCRIPTION OF AVAILABLE ANTENNAS

Antenna	Frequency (MHz)	Antenna Type	MAX Antenna Gain (dBi)
1	2402-2480	PCB	3.71

Test Mode	Transmit and Receive Mode	Description
LE 1M	<input checked="" type="checkbox"/> 1TX, 1RX	Antenna 1 can be used as transmitting/receiving antenna.

Note: The value of the antenna gain was declared by customer.

5.7. DESCRIPTION OF TEST SETUP

SUPPORT EQUIPMENT

Item	Equipment	Brand Name	Model Name	P/N
1	Laptop	ThinkPad	E480	/
2	Serial to USB Board	/	/	/

I/O CABLES

Cable No	Port	Connector Type	Cable Type	Cable Length(m)	Remarks
1	USB	USB	Unshielded	1.0	/

ACCESSORIES

Item	Accessory	Brand Name	Model Name	Description
1	AC Adapter	/	BLJ06L0501 00U-U	Input: 100-240 V ~ 50/60 Hz 0.2 A Max Output: DC 5.0 V 1.0 A

TEST SETUP

The EUT can work in engineering mode with a software through a Laptop.

SETUP DIAGRAM FOR TESTS

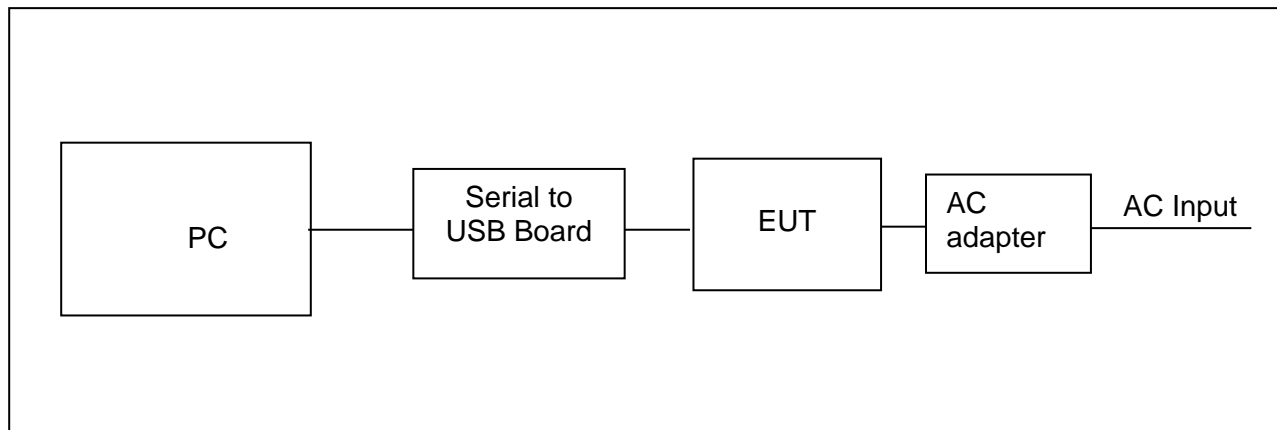

**6. MEASURING INSTRUMENT AND SOFTWARE USED**

Conducted Emissions					
Equipment	Manufacturer	Model No.	Serial No.	Last Cal.	Due Date
EMI Test Receiver	R&S	ESR3	101961	Nov. 12, 2020	Nov. 11, 2021
Two-Line V-Network	R&S	ENV216	101983	Nov. 12, 2020	Nov. 11, 2021
Software					
Description		Manufacturer	Name	Version	
Test Software for Conducted Emissions		Farad	EZ-EMC	Ver. UL-3A1	

Radiated Emissions					
Equipment	Manufacturer	Model No.	Serial No.	Last Cal.	Due Date
MXE EMI Receiver	KESIGHT	N9038A	MY56400036	Nov. 12, 2020	Nov. 11, 2021
Hybrid Log Periodic Antenna	TDK	HLP-3003C	130960	Aug. 11, 2018	Aug. 10, 2021
Preamplifier	HP	8447D	2944A09099	Nov. 12, 2020	Nov. 11, 2021
EMI Measurement Receiver	R&S	ESR26	101377	Nov. 12, 2020	Nov. 11, 2021
Horn Antenna	TDK	HRN-0118	130939	Sept. 17, 2018	Sept. 17, 2021
Preamplifier	TDK	PA-02-0118	TRS-305-00067	Nov. 20, 2020	Nov. 19, 2021
Horn Antenna	Schwarzbeck	BBHA9170	#691	Aug. 11, 2018	Aug. 11, 2021
Preamplifier	TDK	PA-02-2	TRS-307-00003	Nov. 12, 2020	Nov. 11, 2021
Loop antenna	Schwarzbeck	1519B	00008	Jan.17, 2019	Jan.17,2022
Preamplifier	TDK	PA-02-001-3000	TRS-302-00050	Nov. 12, 2020	Nov. 11, 2021
Preamplifier	Mini-Circuits	ZX60-83LN-S+	SUP01201941	Nov. 20, 2020	Nov. 19, 2021
High Pass Filter	Wi	WHKX10-2700-3000-18000-40SS	23	Nov. 12, 2020	Nov. 11, 2021
Band Reject Filter	Wainwright	WRCJV8-2350-2400-2483.5-2533.5-40SS	4	Nov. 12, 2020	Nov. 11, 2021
Software					
Description		Manufacturer	Name	Version	
Test Software for Radiated Emissions		Farad	EZ-EMC	Ver. UL-3A1	



Other instruments					
Equipment	Manufacturer	Model No.	Serial No.	Last Cal.	Next Cal.
Spectrum Analyzer	Keysight	N9030A	MY55410512	Nov. 20, 2020	Nov. 19, 2021
Dual Channel Power Meter	Keysight	N1912A	MY55416024	Nov. 20, 2020	Nov. 19, 2021
Power Sensor	Keysight	USB Wideband Power Sensor	MY5100022	Nov. 20, 2020	Nov. 19, 2021

7. ANTENNA PORT TEST RESULTS

7.1. ON TIME AND DUTY CYCLE

LIMITS

None; for reporting purposes only.

PROCEDURE

Refer to ANSI C63.10-2013 clause 11.6 Zero – Span Spectrum Analyzer method.

TEST SETUP

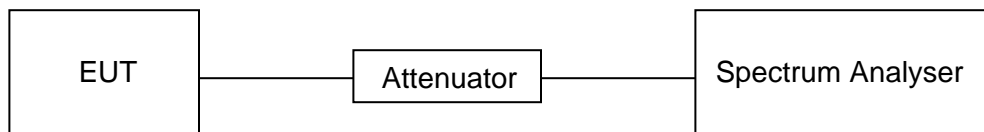

TEST ENVIRONMENT

Temperature	25.1 °C	Relative Humidity	51.6 %
Atmosphere Pressure	101 kPa	Test Voltage	DC 5 V

RESULTS

Please refer to appendix G.

7.2. 6 dB DTS BANDWIDTH AND 99 % OCCUPIED BANDWIDTH

LIMITS

CFR 47FCC Part15 (15.247) Subpart C			
Section	Test Item	Limit	Frequency Range (MHz)
CFR 47 FCC 15.247(a)(2)	6 dB Bandwidth	≥ 500 kHz	2400-2483.5

TEST PROCEDURE

Refer to ANSI C63.10-2013 clause 11.8 for DTS bandwidth and clause 6.9 for Occupied Bandwidth.

Connect the EUT to the spectrum analyser and use the following settings:

Center Frequency	The center frequency of the channel under test
Frequency Span	For 6 dB Bandwidth: Enough to capture all products of the modulation carrier emission For 99 % Occupied Bandwidth: Between 1.5 times and 5.0 times the OBW
Detector	Peak
RBW	For 6 dB Bandwidth: 100 kHz For 99 % Occupied Bandwidth: 1 % to 5 % of the occupied bandwidth
VBW	For 6 dB Bandwidth: ≥3 × RBW For 99 % Occupied Bandwidth: ≥3 × RBW
Trace	Max hold
Sweep	Auto couple

a) Use the 99 % power bandwidth function of the instrument, allow the trace to stabilize and report the measured bandwidth.

b) Allow the trace to stabilize and measure the maximum width of the emission that is constrained by the frequencies associated with the two outermost amplitude points (upper and lower frequencies) that are attenuated by 6 dB relative to the maximum level measured in the fundamental emission.

TEST SETUP

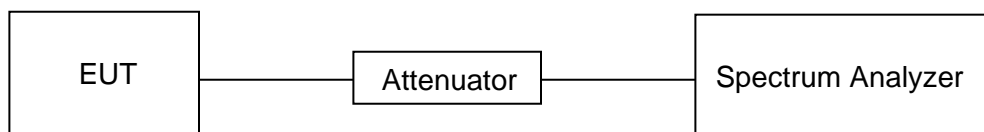



TEST ENVIRONMENT

Temperature	25.1 °C	Relative Humidity	51.6 %
Atmosphere Pressure	101 kPa	Test Voltage	DC 5 V

RESULTS

Please refer to appendix A & B.

7.3. CONDUCTED OUTPUT POWER

LIMITS

CFR 47 FCC Part15 (15.247) Subpart C			
Section	Test Item	Limit	Frequency Range (MHz)
CFR 47 FCC 15.247(b)(3)	Peak Conducted Output Power	1 watt or 30 dBm	2400-2483.5

TEST PROCEDURE

Connect the EUT to a low loss RF cable from the antenna port to the power sensor (video bandwidth is greater than the occupied bandwidth). Measure peak emission level, the indicated level is the peak output power, after any corrections for external attenuators and cables.

TEST SETUP

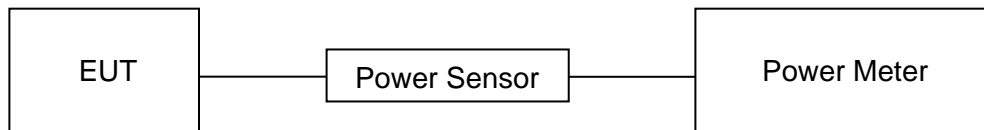

TEST ENVIRONMENT

Temperature	25.1 °C	Relative Humidity	51.6 %
Atmosphere Pressure	101 kPa	Test Voltage	DC 5 V

RESULTS

Please refer to appendix C.

7.4. POWER SPECTRAL DENSITY

LIMITS

CFR 47 FCC Part15 (15.247) Subpart C			
Section	Test Item	Limit	Frequency Range (MHz)
CFR 47 FCC §15.247 (e)	Power Spectral Density	8 dBm in any 3 kHz band	2400-2483.5

TEST PROCEDURE

Refer to ANSI C63.10-2013 clause 11.10.

Connect the EUT to the spectrum analyser and use the following settings:

Center Frequency	The center frequency of the channel under test
Detector	Peak
RBW	$3 \text{ kHz} \leq \text{RBW} \leq 100 \text{ kHz}$
VBW	$\geq 3 \times \text{RBW}$
Span	1.5 x DTS bandwidth
Trace	Max hold
Sweep time	Auto couple

Allow trace to fully stabilize and use the peak marker function to determine the maximum amplitude level within the RBW.

If measured value exceeds limit, reduce RBW (no less than 3 kHz) and repeat.

TEST SETUP

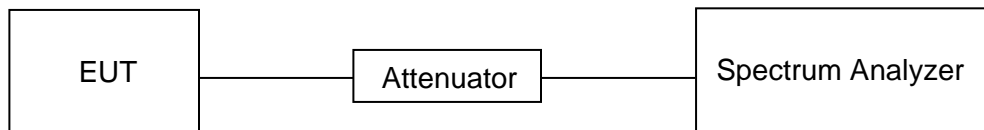

TEST ENVIRONMENT

Temperature	25.1 °C	Relative Humidity	51.6 %
Atmosphere Pressure	101 kPa	Test Voltage	DC 5 V



RESULTS

Please refer to appendix D.



7.5. CONDUCTED BANDEGE AND SPURIOUS EMISSIONS

LIMITS

CFR 47 FCC Part15 (15.247) Subpart C		
Section	Test Item	Limit
CFR 47 FCC §15.247 (d)	Conducted Bandedge and Spurious Emissions	at least 20 dB below that in the 100 kHz bandwidth within the band that contains the highest level of the desired power

TEST PROCEDURE

Refer to ANSI C63.10-2013 clause 11.11 and 11.13.

Connect the EUT to the spectrum analyser and use the following settings for reference level measurement:

Center Frequency	The center frequency of the channel under test
Detector	Peak
RBW	100 kHz
VBW	$\geq 3 \times \text{RBW}$
Span	1.5 x DTS bandwidth
Trace	Max hold
Sweep time	Auto couple.

Allow trace to fully stabilize and use the peak marker function to determine the maximum PSD level.

Change the settings for emission level measurement:

Span	Set the center frequency and span to encompass frequency range to be measured
Detector	Peak
RBW	100 kHz
VBW	$\geq 3 \times \text{RBW}$
measurement points	$\geq \text{span}/\text{RBW}$
Trace	Max hold
Sweep time	Auto couple.

Allow trace to fully stabilize and use the peak marker function to determine the maximum PSD level. Ensure that the amplitude of all unwanted emissions outside of the authorized frequency band (excluding restricted frequency bands) is attenuated by at least the minimum requirements specified in 11.11.

TEST SETUP

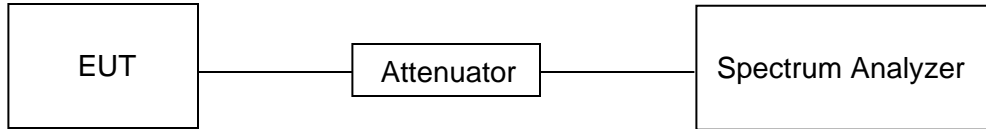

TEST ENVIRONMENT

Temperature	25.1 °C	Relative Humidity	51.6 %
Atmosphere Pressure	101 kPa	Test Voltage	DC 5 V

RESULTS

Please refer to appendix E & F.



8. RADIATED TEST RESULTS

LIMITS

Please refer to CFR 47 FCC §15.205 and §15.209.

Radiation Disturbance Test Limit for FCC (Class B) (9 kHz-1 GHz)

Emissions radiated outside of the specified frequency bands above 30 MHz			
Frequency Range (MHz)	Field Strength Limit (uV/m) at 3 m	Field Strength Limit (dBuV/m) at 3 m	
		Quasi-Peak	
30 - 88	100	40	
88 - 216	150	43.5	
216 - 960	200	46	
Above 960	500	54	
Above 1000	500	Peak	Average
		74	54

FCC Emissions radiated outside of the specified frequency bands below 30 MHz		
Frequency (MHz)	Field strength (microvolts/meter)	Measurement distance (meters)
0.009-0.490	2400/F(kHz)	300
0.490-1.705	24000/F(kHz)	30
1.705-30.0	30	30

FCC Restricted bands of operation refer to FCC §15.205 (a):

MHz	MHz	MHz	GHz
0.090-0.110	16.42-16.423	399.9-410	4.5-5.15
¹ 0.495-0.505	16.69475-16.69525	608-614	5.35-5.46
2.1735-2.1905	16.80425-16.80475	960-1240	7.25-7.75
4.125-4.128	25.5-25.67	1300-1427	8.025-8.5
4.17725-4.17775	37.5-38.25	1435-1626.5	9.0-9.2
4.20725-4.20775	73-74.6	1645.5-1646.5	9.3-9.5
6.215-6.218	74.8-75.2	1660-1710	10.6-12.7
6.26775-6.26825	108-121.94	1718.8-1722.2	13.25-13.4
6.31175-6.31225	123-138	2200-2300	14.47-14.5
8.291-8.294	149.9-150.05	2310-2390	15.35-16.2
8.362-8.366	156.52475-156.52525	2483.5-2500	17.7-21.4
8.37625-8.38675	156.7-156.9	2690-2900	22.01-23.12
8.41425-8.41475	162.0125-167.17	3260-3267	23.6-24.0
12.29-12.293	167.72-173.2	3332-3339	31.2-31.8
12.51975-12.52025	240-285	3345.8-3358	36.43-36.5
12.57675-12.57725	322-335.4	3600-4400	(²)
13.36-13.41			

Note: ¹Until February 1, 1999, this restricted band shall be 0.490-0.510 MHz.

²Above 38.6c

TEST SETUP AND PROCEDURE

Below 30 MHz

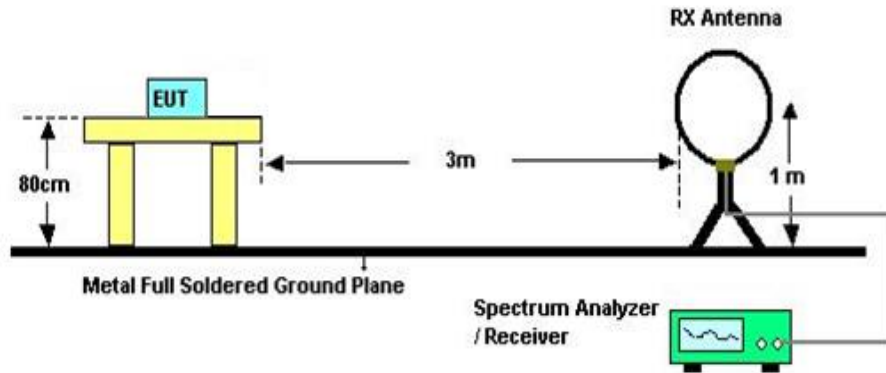

The setting of the spectrum analyser

RBW	200 Hz (From 9 kHz to 0.15 MHz)/ 9 kHz (From 0.15 MHz to 30 MHz)
VBW	200 Hz (From 9 kHz to 0.15 MHz)/ 9 kHz (From 0.15 MHz to 30 MHz)
Sweep	Auto
Trace	Max hold

1. The testing follows the guidelines in ANSI C63.10-2013 clause 11.11.
2. The EUT was arranged to its worst case and then turntable (from 0 degree to 360 degrees) to find the maximum reading. A pre-amp and a high pass filter are used for the test in order to get better signal level. Both Horizontal, Face-on and Face-off polarizations of the antenna are set to make the measurement.
3. The EUT was placed on a turntable with 80 cm above ground.
4. The EUT was set 3 meters from the interference receiving antenna, which was mounted on the top of a 1 m height antenna tower.
5. The radiated emission limits are based on measurements employing a CISPR quasi-peak detector except for the frequency bands 9-90 kHz, 110-490 kHz and above 1000 MHz. Radiated emission limits in these three bands are based on measurements employing an average detector.
6. For measurement below 1 GHz, the initial step in collecting conducted emission data is a spectrum analyzer peak detector mode pre-scanning the measurement frequency range. Significant peaks are then marked and then Quasi Peak and average detector mode re-measured. If the emission level of the EUT measured by the peak detector is 3 dB lower than the applicable limit, the peak emission level will be reported. Otherwise, the emission measurement will be repeated using the quasi-peak and average detector and reported.
7. Although these tests were performed other than open field site, adequate comparison measurements were confirmed against 30m open field site. Therefore sufficient tests were made to demonstrate that the alternative site produces results that correlate with the ones of tests made in an open field site based on KDB 414788.

Below 1 GHz and above 30 MHz

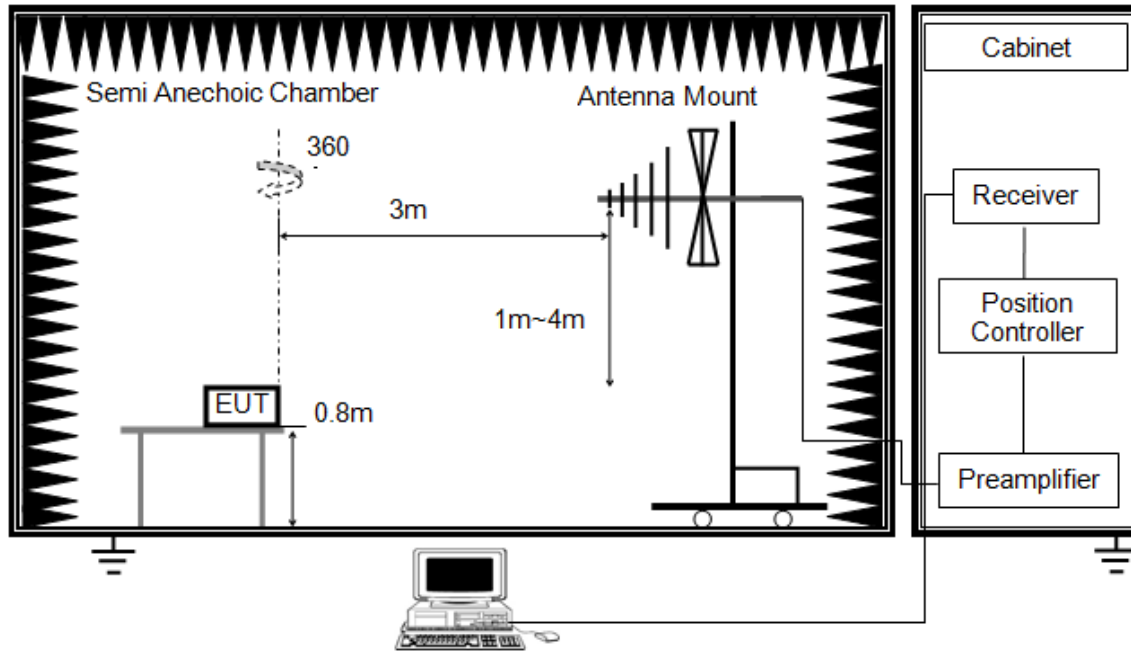

The setting of the spectrum analyser

RBW	120 kHz
VBW	300 kHz
Sweep	Auto
Detector	Peak/QP
Trace	Max hold

1. The testing follows the guidelines in ANSI C63.10-2013 clause 11.11.
2. The EUT was arranged to its worst case and then tune the antenna tower (from 1 m to 4 m) and turntable (from 0 degree to 360 degrees) to find the maximum reading. A pre-amp and a high pass filter are used for the test in order to get better signal level. Both horizontal and vertical polarizations of the antenna are set to make the measurement.
3. The EUT was placed on a turntable with 80 cm above ground.
4. The EUT was set 3 meters from the interference receiving antenna, which was mounted on the top of a variable height antenna tower.
5. For measurement below 1 GHz, the initial step in collecting conducted emission data is a spectrum analyzer peak detector mode pre-scanning the measurement frequency range. Significant peaks are then marked and then Quasi Peak detector mode re-measured. If the emission level of the EUT measured by the peak detector is 3 dB lower than the applicable limit, the peak emission level will be reported. Otherwise, the emission measurement will be repeated using the quasi-peak detector and reported.

Above 1GHz

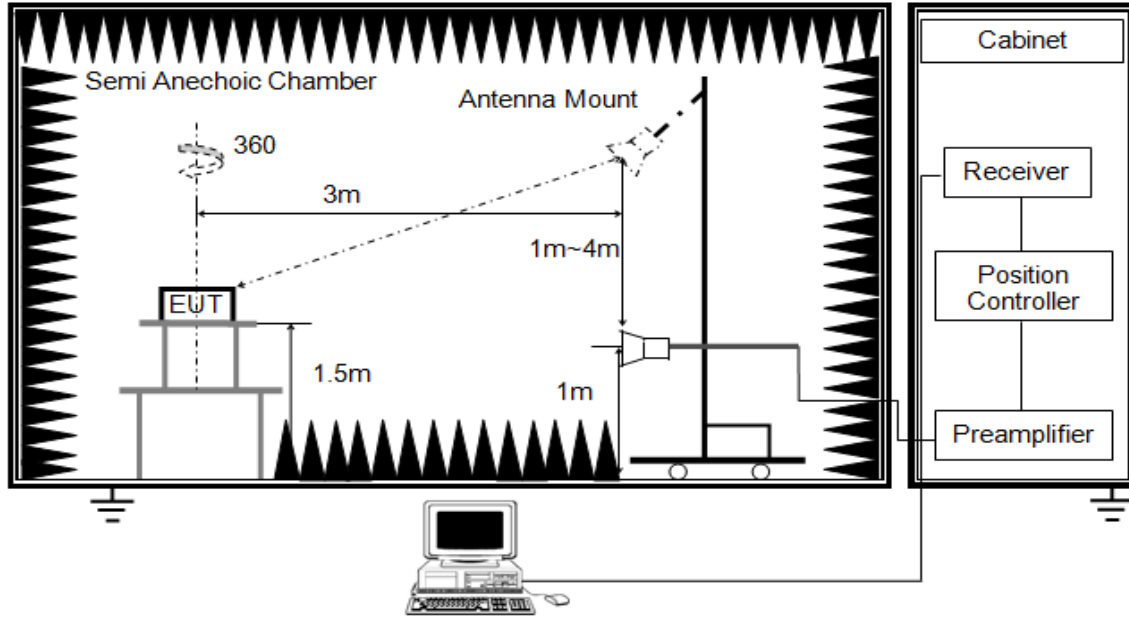

The setting of the spectrum analyser

RBW	1 MHz
VBW	PEAK: 3 MHz AVG: see note 6
Sweep	Auto
Detector	Peak
Trace	Max hold

1. The testing follows the guidelines in ANSI C63.10-2013 clause 11.11 and 11.12.
2. The EUT was arranged to its worst case and then tune the antenna tower (1.5 m) and turntable (from 0 degree to 360 degrees) to find the maximum reading. A pre-amp and a high pass filter are used for the test in order to get better signal level. Both horizontal and vertical polarizations of the antenna are set to make the measurement.
3. The EUT was placed on a turntable with 1.5 m above ground.
4. The EUT was set 3 meters from the interference receiving antenna, which was mounted on the top of a variable height antenna tower.
5. For measurement above 1 GHz, the emission measurement will be measured by the peak detector. This peak level, once corrected, must comply with the limit specified in Section 15.209.
6. For measurements above 1 GHz the resolution bandwidth is set to 1 MHz, then the video bandwidth is set to 3 MHz for peak measurements and 1 MHz resolution bandwidth with 1/T video bandwidth with peak detector for average measurements. For the Duty Cycle please refer to clause 7.1.ON TIME AND DUTY CYCLE.

Note: The EUT was fully exercised with external accessories during the test. In the case of multiple accessory external ports, an external accessory shall be connected to one of each type of port.



TEST ENVIRONMENT

Temperature	23.5 °C	Relative Humidity	61.2 %
Atmosphere Pressure	101 kPa	Test Voltage	DC 5 V

RESULTS

8.1. RESTRICTED BANDEDGE

8.1.1. LE 1M MODE

RESTRICTED BANDEDGE (LOW CHANNEL, HORIZONTAL)

PEAK

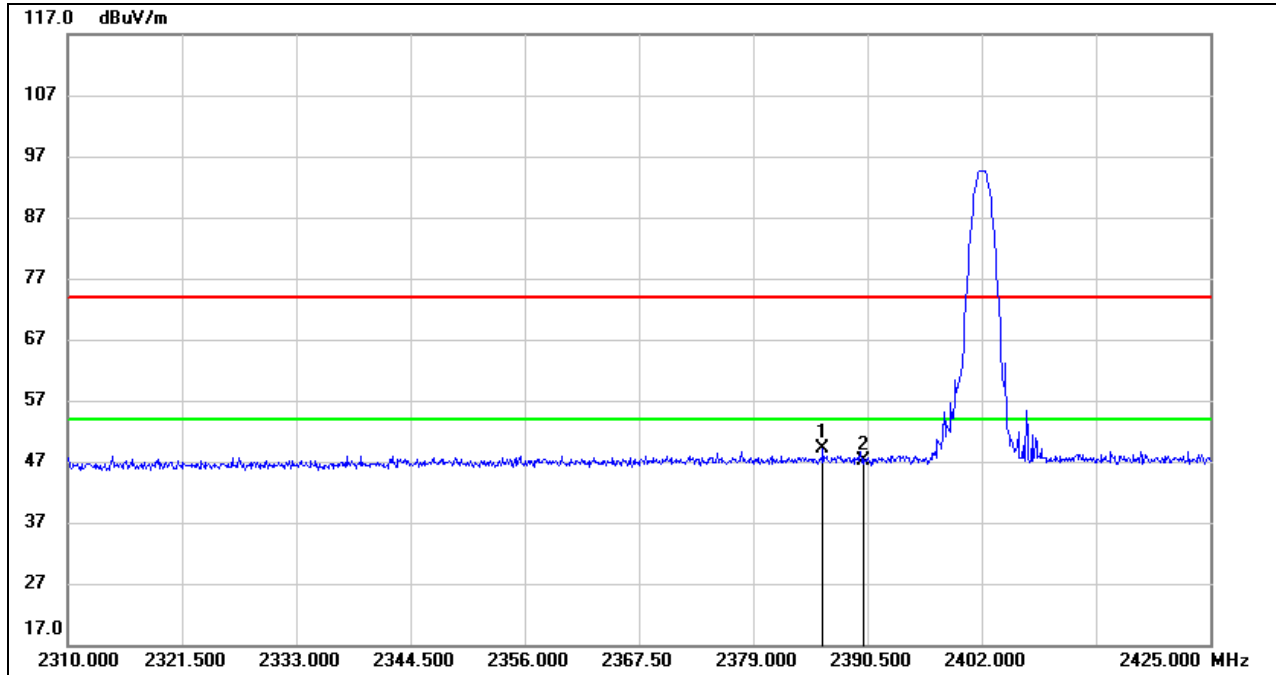

No.	Frequency (MHz)	Reading (dBuV)	Correct (dB/m)	Result (dBuV/m)	Limit (dBuV/m)	Margin (dB)	Remark
1	2386.015	15.90	33.32	49.22	74.00	-24.78	peak
2	2390.000	13.90	33.35	47.25	74.00	-26.75	peak

- Note: 1. Measurement = Reading Level + Correct Factor.
 2. If Peak Result complies with AV limit, AV Result is deemed to comply with AV limit.
 3. Peak: Peak detector.
 4. Only the worst data was recorded, if it complies with the limit, the other emissions deemed to comply with the limit.



RESTRICTED BANDEDGE (HIGH CHANNEL, HORIZONTAL)

PEAK

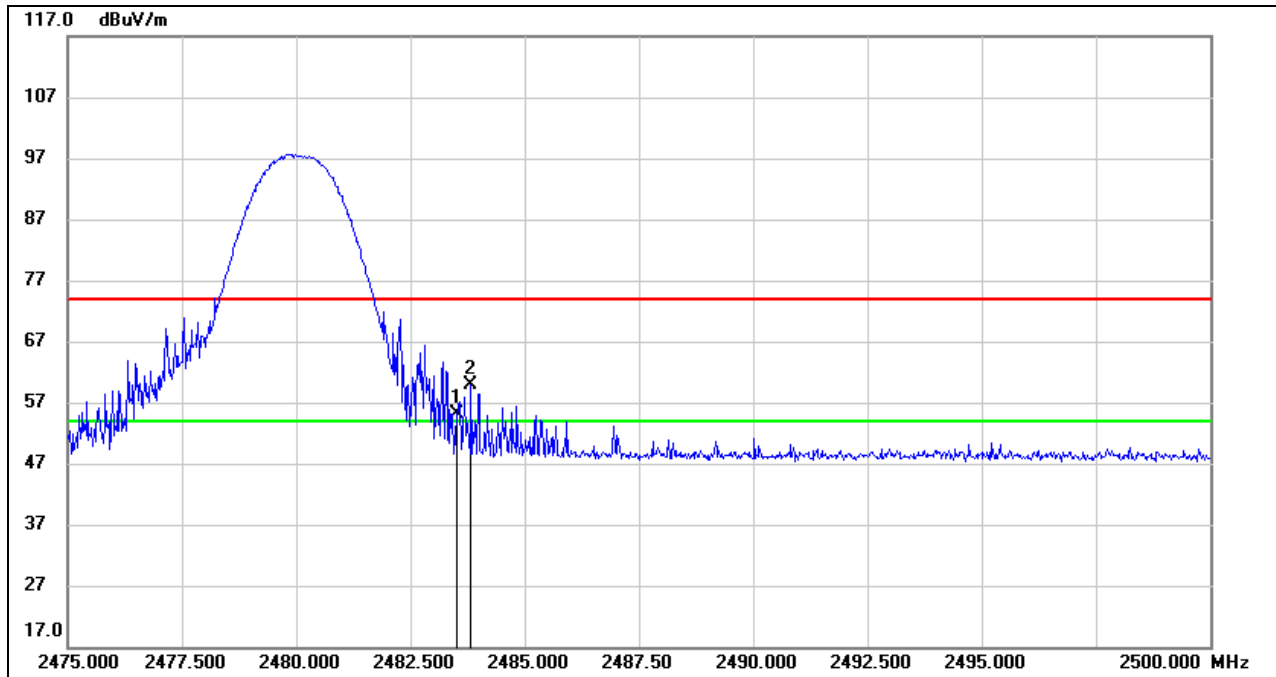

No.	Frequency (MHz)	Reading (dBuV)	Correct (dB/m)	Result (dBuV/m)	Limit (dBuV/m)	Margin (dB)	Remark
1	2483.500	21.52	33.71	55.23	74.00	-18.77	peak
2	2483.825	26.05	33.71	59.76	74.00	-14.24	peak

- Note:
1. Measurement = Reading Level + Correct Factor.
 2. If Peak Result complies with AV limit, AV Result is deemed to comply with AV limit.
 3. Peak: Peak detector.
 4. Only the worst data was recorded, if it complies with the limit, the other emissions deemed to comply with the limit.

AVG

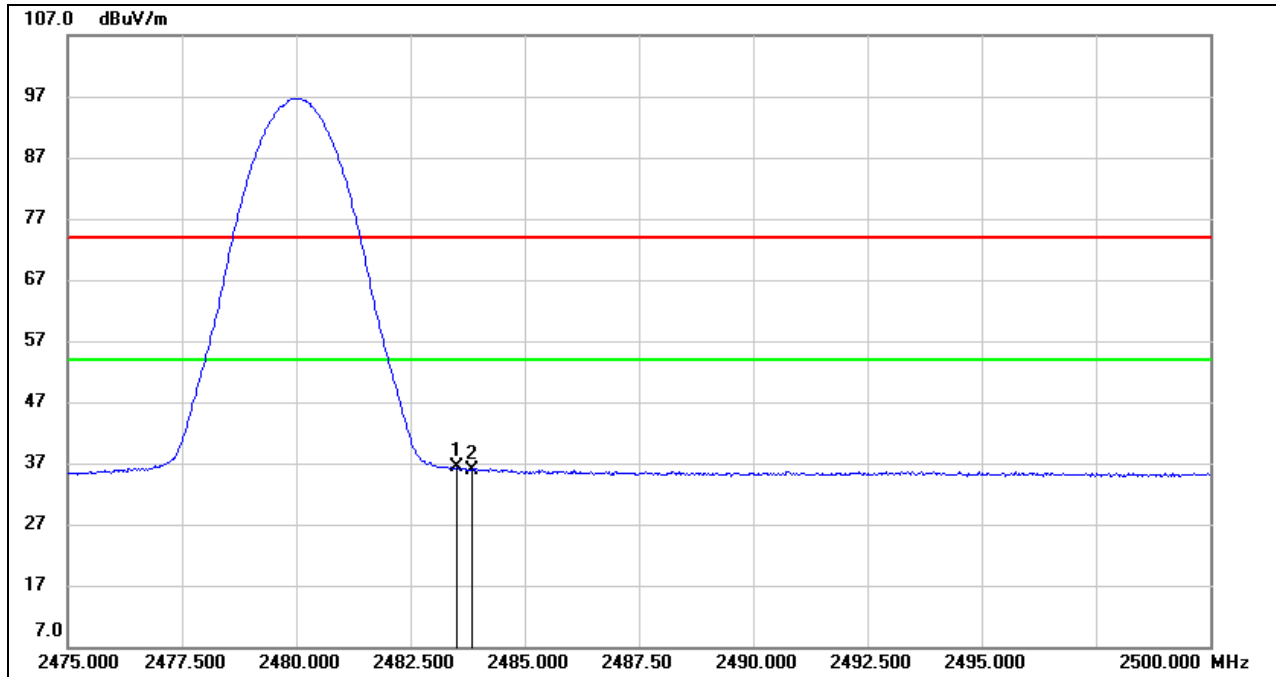

No.	Frequency (MHz)	Reading (dBuV)	Correct (dB/m)	Result (dBuV/m)	Limit (dBuV/m)	Margin (dB)	Remark
1	2483.500	2.59	33.71	36.30	54.00	-17.70	AVG
2	2483.825	2.18	33.71	35.89	54.00	-18.11	AVG

- Note:
1. Measurement = Reading Level + Correct Factor.
 2. If Peak Result complies with AV limit, AV Result is deemed to comply with AV limit.
 3. Peak: Peak detector.
 4. AVG: $VBW=1/Ton$, where: Ton is the transmitting duration.
 5. For the transmitting duration, please refer to clause 7.1.
 6. Only the worst data was recorded, if it complies with the limit, the other emissions deemed to comply with the limit.

Note: Both the horizontal and vertical polarities had been tested, but only the worst data was recorded in the report.

8.2. SPURIOUS EMISSIONS (1 GHz ~ 3 GHz)

8.2.1. LE 1M MODE

HARMONICS AND SPURIOUS EMISSIONS (LOW CHANNEL, HORIZONTAL)

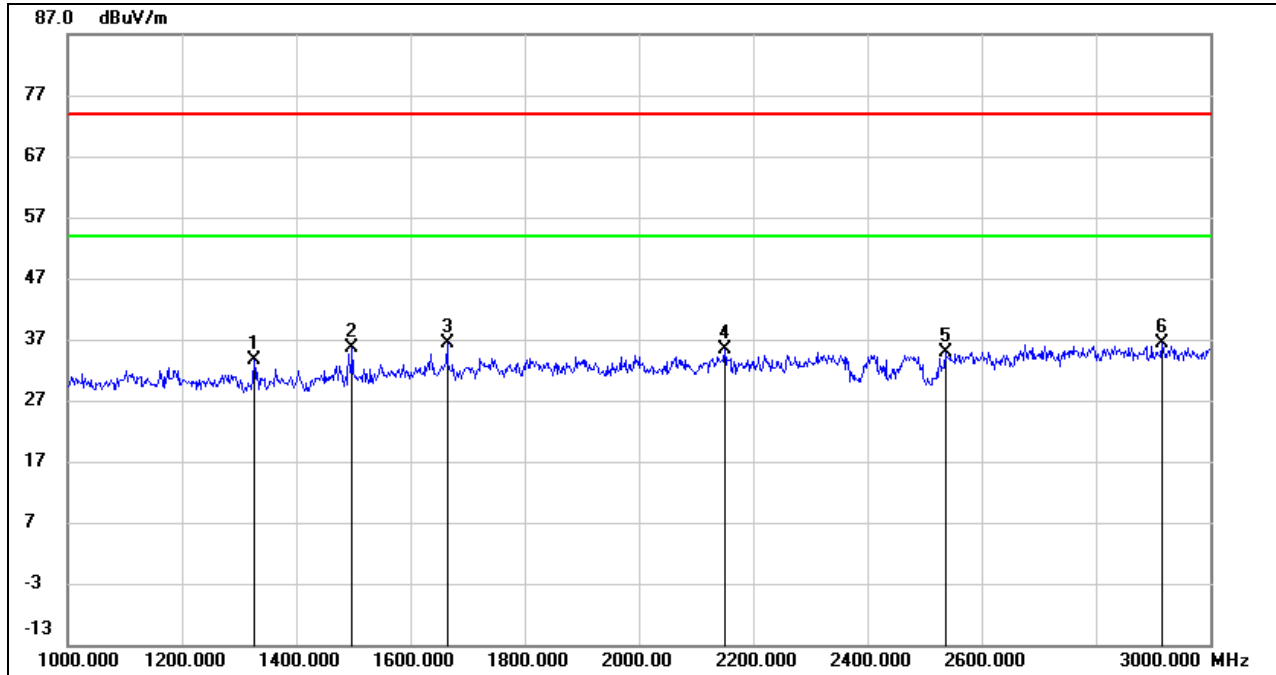

No.	Frequency (MHz)	Reading (dBuV)	Correct (dB/m)	Result (dBuV/m)	Limit (dBuV/m)	Margin (dB)	Remark
1	1326.000	46.37	-12.81	33.56	74.00	-40.44	peak
2	1498.000	47.93	-12.23	35.70	74.00	-38.30	peak
3	1664.000	47.36	-11.08	36.28	74.00	-37.72	peak
4	2150.000	44.73	-9.34	35.39	74.00	-38.61	peak
5	2536.000	42.90	-8.10	34.80	74.00	-39.20	peak
6	2916.000	42.29	-5.99	36.30	74.00	-37.70	peak

- Note:
1. Peak Result = Reading Level + Correct Factor.
 2. If Peak Result complies with AV limit, AV Result is deemed to comply with AV limit.
 3. Peak: Peak detector.
 4. Filter losses were only considered in then spurious frequency bands and the authorized band was not corrected for BRF losses.
 5. Proper operation of the transmitter prior to adding the filter to the measurement chain.

HARMONICS AND SPURIOUS EMISSIONS (LOW CHANNEL, VERTICAL)

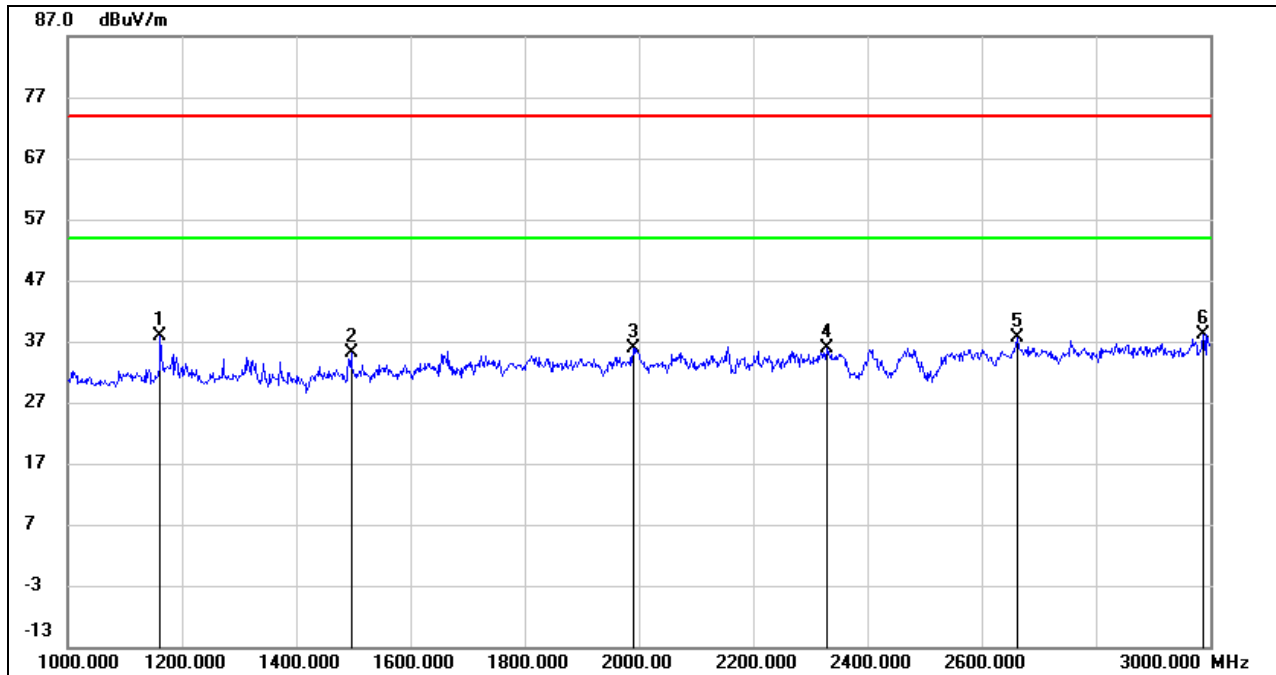

No.	Frequency (MHz)	Reading (dBuV)	Correct (dB/m)	Result (dBuV/m)	Limit (dBuV/m)	Margin (dB)	Remark
1	1162.000	51.17	-13.18	37.99	74.00	-36.01	peak
2	1496.000	47.37	-12.25	35.12	74.00	-38.88	peak
3	1990.000	46.17	-10.19	35.98	74.00	-38.02	peak
4	2328.000	44.63	-8.64	35.99	74.00	-38.01	peak
5	2662.000	45.14	-7.46	37.68	74.00	-36.32	peak
6	2988.000	43.81	-5.64	38.17	74.00	-35.83	peak

- Note:
1. Peak Result = Reading Level + Correct Factor.
 2. If Peak Result complies with AV limit, AV Result is deemed to comply with AV limit.
 3. Peak: Peak detector.
 4. Filter losses were only considered in then spurious frequency bands and the authorized band was not corrected for BRF losses.
 5. Proper operation of the transmitter prior to adding the filter to the measurement chain.

HARMONICS AND SPURIOUS EMISSIONS (MID CHANNEL, HORIZONTAL)

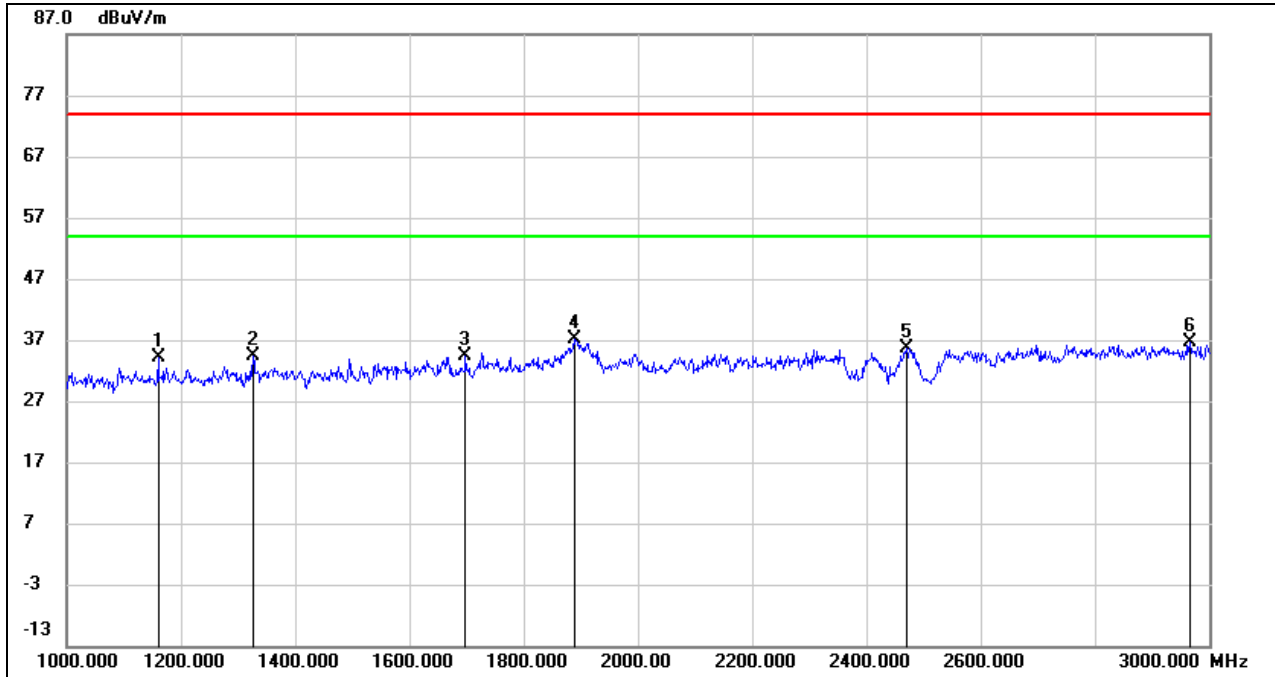

No.	Frequency (MHz)	Reading (dBuV)	Correct (dB/m)	Result (dBuV/m)	Limit (dBuV/m)	Margin (dB)	Remark
1	1160.000	47.28	-13.18	34.10	74.00	-39.90	peak
2	1326.000	47.16	-12.81	34.35	74.00	-39.65	peak
3	1698.000	45.12	-10.82	34.30	74.00	-39.70	peak
4	1888.000	47.29	-10.12	37.17	74.00	-36.83	peak
5	2470.000	43.85	-8.27	35.58	74.00	-38.42	peak
6	2966.000	42.41	-5.75	36.66	74.00	-37.34	peak

- Note: 1. Peak Result = Reading Level + Correct Factor.
 2. If Peak Result complies with AV limit, AV Result is deemed to comply with AV limit.
 3. Peak: Peak detector.
 4. Filter losses were only considered in then spurious frequency bands and the authorized band was not corrected for BRF losses.
 5. Proper operation of the transmitter prior to adding the filter to the measurement chain.

HARMONICS AND SPURIOUS EMISSIONS (MID CHANNEL, VERTICAL)

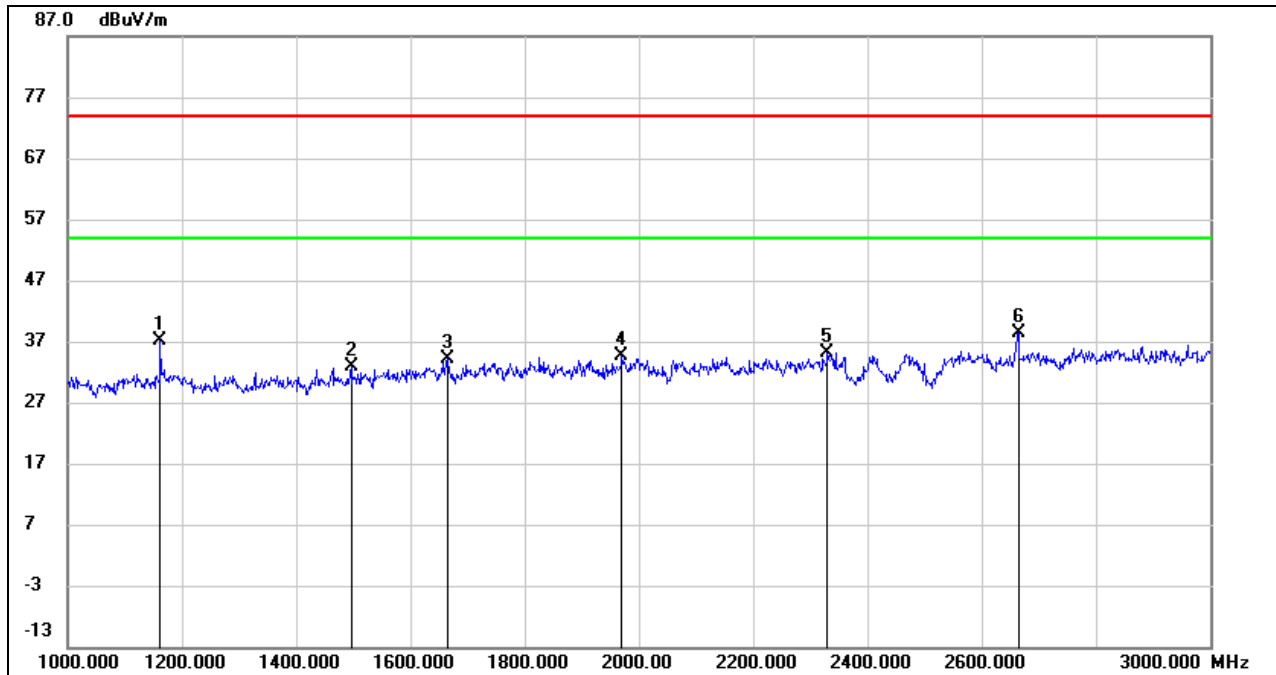

No.	Frequency (MHz)	Reading (dBuV)	Correct (dB/m)	Result (dBuV/m)	Limit (dBuV/m)	Margin (dB)	Remark
1	1162.000	50.26	-13.18	37.08	74.00	-36.92	peak
2	1496.000	45.23	-12.25	32.98	74.00	-41.02	peak
3	1664.000	45.26	-11.08	34.18	74.00	-39.82	peak
4	1970.000	44.78	-10.16	34.62	74.00	-39.38	peak
5	2330.000	43.82	-8.63	35.19	74.00	-38.81	peak
6	2664.000	45.70	-7.44	38.26	74.00	-35.74	peak

- Note: 1. Peak Result = Reading Level + Correct Factor.
 2. If Peak Result complies with AV limit, AV Result is deemed to comply with AV limit.
 3. Peak: Peak detector.
 4. Filter losses were only considered in then spurious frequency bands and the authorized band was not corrected for BRF losses.
 5. Proper operation of the transmitter prior to adding the filter to the measurement chain.

HARMONICS AND SPURIOUS EMISSIONS (HIGH CHANNEL, HORIZONTAL)

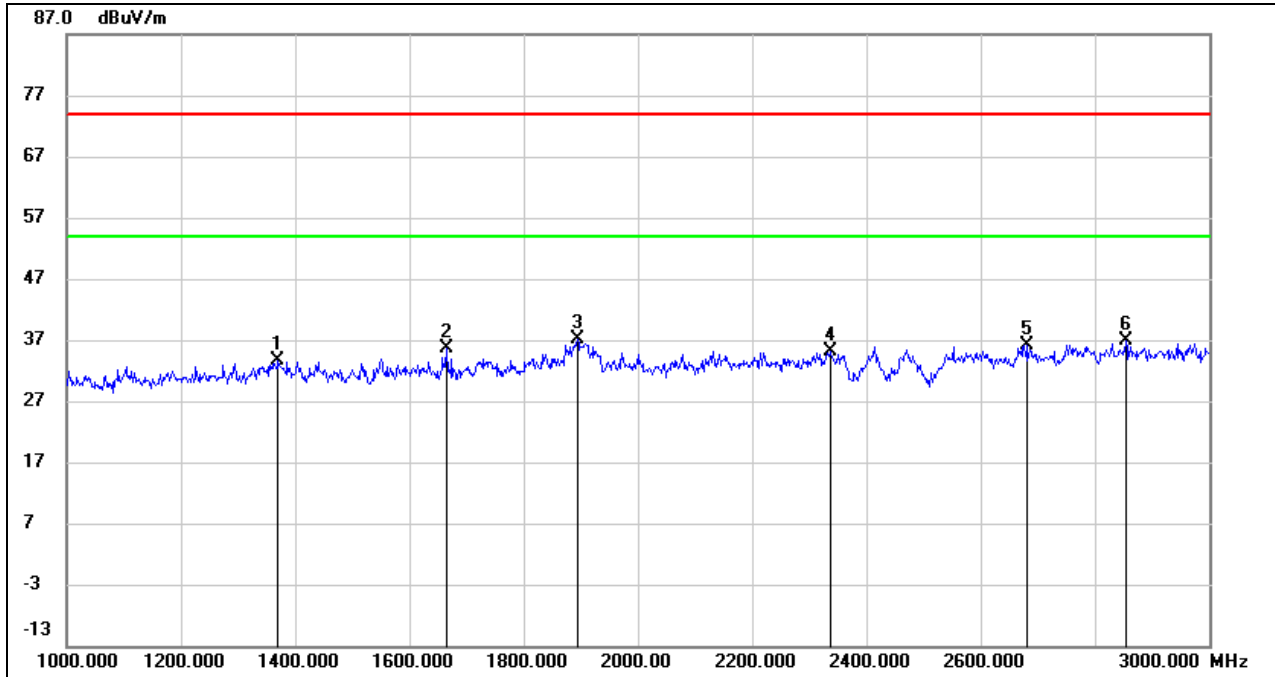

No.	Frequency (MHz)	Reading (dBuV)	Correct (dB/m)	Result (dBuV/m)	Limit (dBuV/m)	Margin (dB)	Remark
1	1370.000	46.37	-12.75	33.62	74.00	-40.38	peak
2	1664.000	46.78	-11.08	35.70	74.00	-38.30	peak
3	1894.000	47.20	-10.11	37.09	74.00	-36.91	peak
4	2336.000	43.80	-8.61	35.19	74.00	-38.81	peak
5	2680.000	43.37	-7.34	36.03	74.00	-37.97	peak
6	2854.000	43.20	-6.30	36.90	74.00	-37.10	peak

- Note: 1. Peak Result = Reading Level + Correct Factor.
 2. If Peak Result complies with AV limit, AV Result is deemed to comply with AV limit.
 3. Peak: Peak detector.
 4. Filter losses were only considered in then spurious frequency bands and the authorized band was not corrected for BRF losses.
 5. Proper operation of the transmitter prior to adding the filter to the measurement chain.

HARMONICS AND SPURIOUS EMISSIONS (HIGH CHANNEL, VERTICAL)

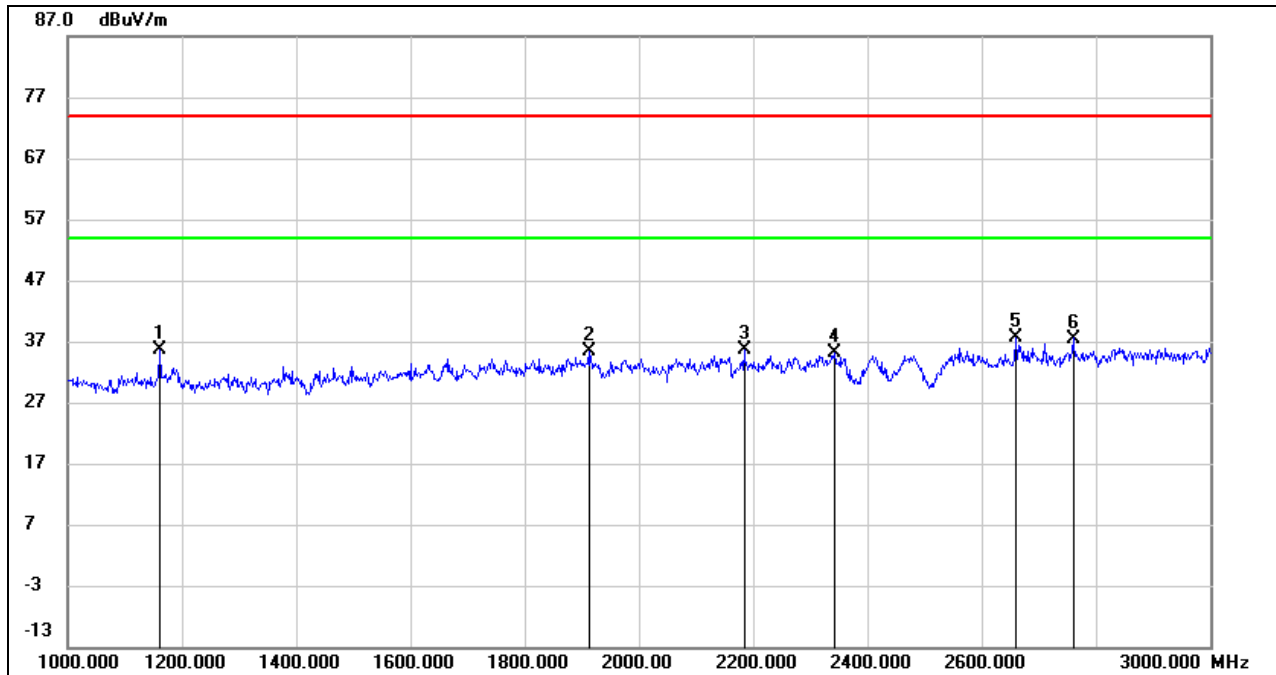

No.	Frequency (MHz)	Reading (dBuV)	Correct (dB/m)	Result (dBuV/m)	Limit (dBuV/m)	Margin (dB)	Remark
1	1162.000	48.88	-13.18	35.70	74.00	-38.30	peak
2	1912.000	45.61	-10.12	35.49	74.00	-38.51	peak
3	2184.000	44.89	-9.14	35.75	74.00	-38.25	peak
4	2342.000	43.71	-8.58	35.13	74.00	-38.87	peak
5	2660.000	44.99	-7.47	37.52	74.00	-36.48	peak
6	2760.000	44.31	-6.81	37.50	74.00	-36.50	peak

- Note: 1. Peak Result = Reading Level + Correct Factor.
 2. If Peak Result complies with AV limit, AV Result is deemed to comply with AV limit.
 3. Peak: Peak detector.
 4. Filter losses were only considered in then spurious frequency bands and the authorized band was not corrected for BRF losses.
 5. Proper operation of the transmitter prior to adding the filter to the measurement chain.

Note: All the modes have been tested, only the worst data was recorded in the report.

8.3. SPURIOUS EMISSIONS (3 GHz ~ 18 GHz)

8.3.1. LE 1M MODE

HARMONICS AND SPURIOUS EMISSIONS (LOW CHANNEL, HORIZONTAL)

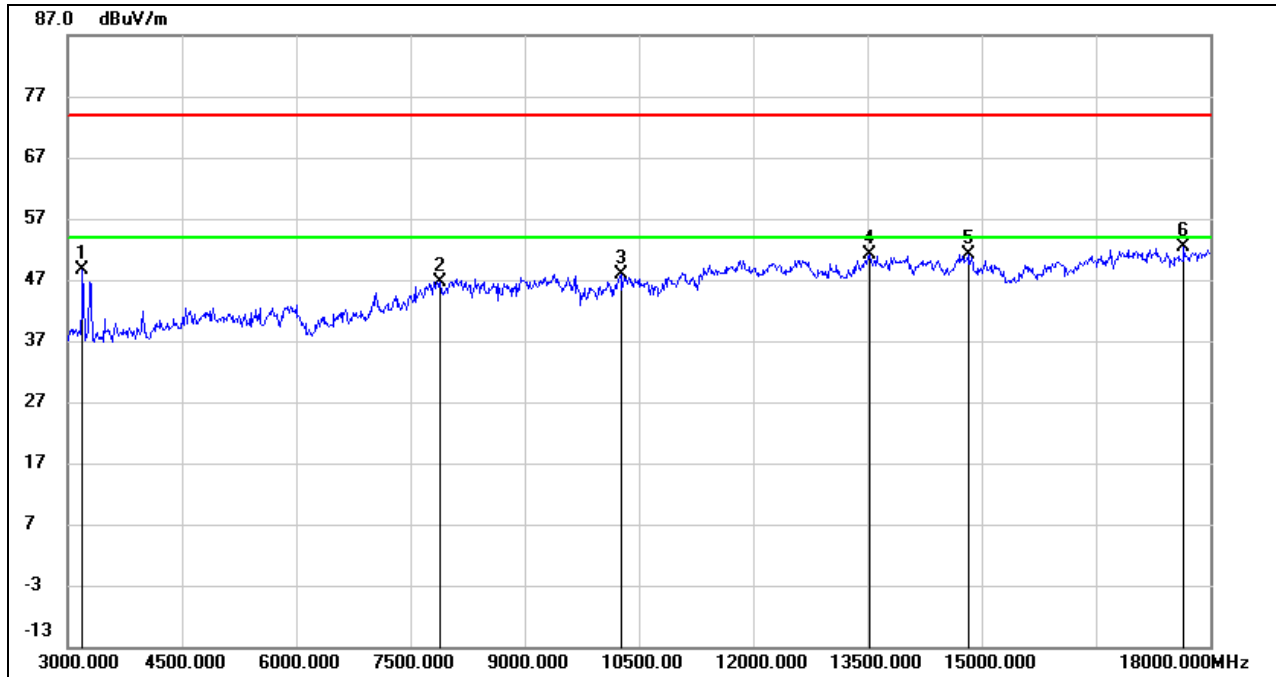

No.	Frequency (MHz)	Reading (dBuV)	Correct (dB/m)	Result (dBuV/m)	Limit (dBuV/m)	Margin (dB)	Remark
1	3195.000	52.61	-3.91	48.70	74.00	-25.30	peak
2	7890.000	37.80	8.91	46.71	74.00	-27.29	peak
3	10260.000	36.23	11.68	47.91	74.00	-26.09	peak
4	13530.000	33.87	17.19	51.06	74.00	-22.94	peak
5	14820.000	33.32	17.91	51.23	74.00	-22.77	peak
6	17655.000	29.21	23.14	52.35	74.00	-21.65	peak

- Note: 1. Peak Result = Reading Level + Correct Factor.
 2. If Peak Result complies with AV limit, AV Result is deemed to comply with AV limit.
 3. Peak: Peak detector.
 4. Filter losses were only considered in the spurious frequency bands and the authorized band was not corrected for High Pass Filter losses.
 5. Proper operation of the transmitter prior to adding the filter to the measurement chain.

HARMONICS AND SPURIOUS EMISSIONS (LOW CHANNEL, VERTICAL)

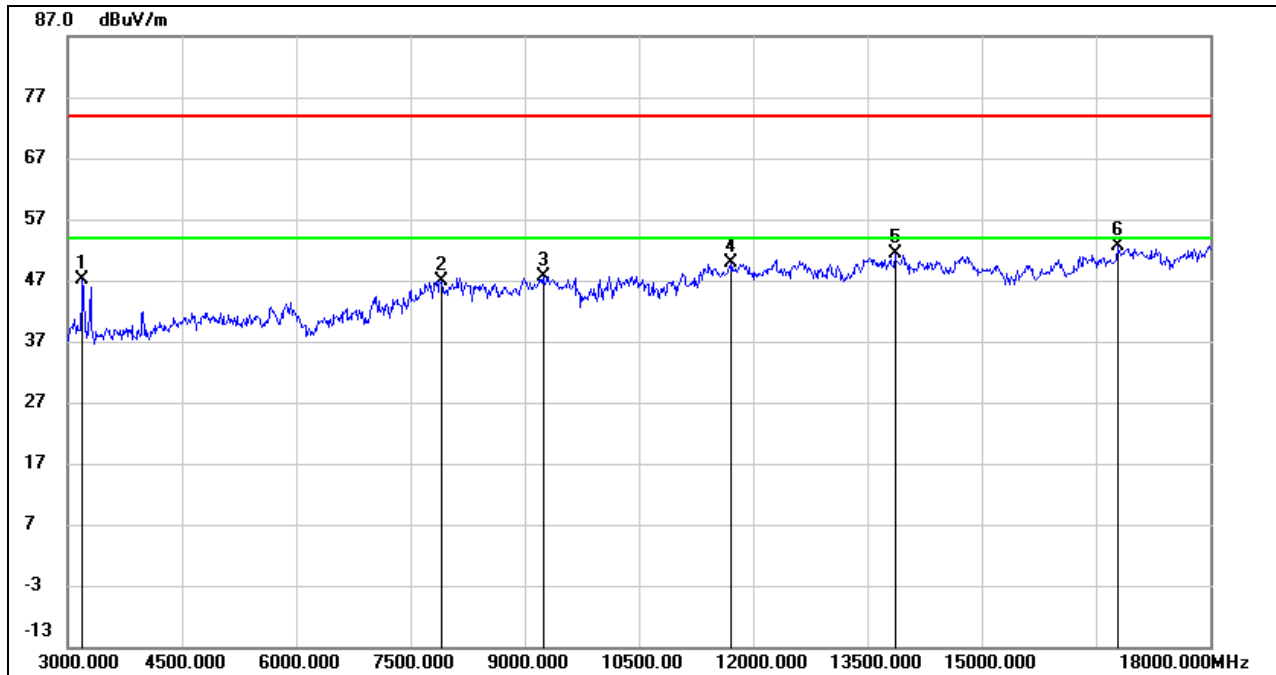

No.	Frequency (MHz)	Reading (dBuV)	Correct (dB/m)	Result (dBuV/m)	Limit (dBuV/m)	Margin (dB)	Remark
1	3195.000	50.96	-3.91	47.05	74.00	-26.95	peak
2	7905.000	38.01	8.84	46.85	74.00	-27.15	peak
3	9240.000	37.63	10.10	47.73	74.00	-26.27	peak
4	11715.000	34.60	15.34	49.94	74.00	-24.06	peak
5	13860.000	33.87	17.55	51.42	74.00	-22.58	peak
6	16785.000	32.04	20.59	52.63	74.00	-21.37	peak

- Note: 1. Peak Result = Reading Level + Correct Factor.
 2. If Peak Result complies with AV limit, AV Result is deemed to comply with AV limit.
 3. Peak: Peak detector.
 4. Filter losses were only considered in the spurious frequency bands and the authorized band was not corrected for High Pass Filter losses.
 5. Proper operation of the transmitter prior to adding the filter to the measurement chain.

HARMONICS AND SPURIOUS EMISSIONS (MID CHANNEL, HORIZONTAL)

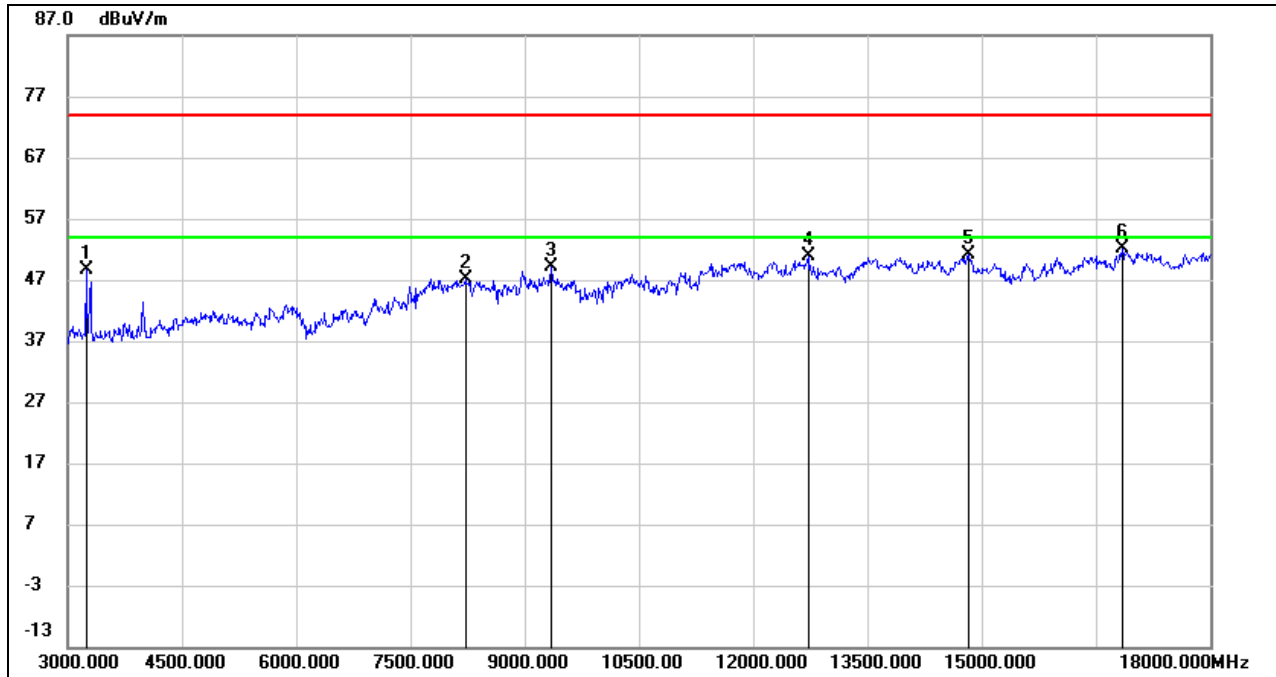

No.	Frequency (MHz)	Reading (dBuV)	Correct (dB/m)	Result (dBuV/m)	Limit (dBuV/m)	Margin (dB)	Remark
1	3240.000	52.56	-3.82	48.74	74.00	-25.26	peak
2	8220.000	37.37	9.79	47.16	74.00	-26.84	peak
3	9345.000	38.42	10.66	49.08	74.00	-24.92	peak
4	12720.000	35.15	15.70	50.85	74.00	-23.15	peak
5	14820.000	33.30	17.91	51.21	74.00	-22.79	peak
6	16845.000	31.02	21.10	52.12	74.00	-21.88	peak

- Note:
1. Peak Result = Reading Level + Correct Factor.
 2. If Peak Result complies with AV limit, AV Result is deemed to comply with AV limit.
 3. Peak: Peak detector.
 4. Filter losses were only considered in the spurious frequency bands and the authorized band was not corrected for High Pass Filter losses.
 5. Proper operation of the transmitter prior to adding the filter to the measurement chain.

HARMONICS AND SPURIOUS EMISSIONS (MID CHANNEL, VERTICAL)

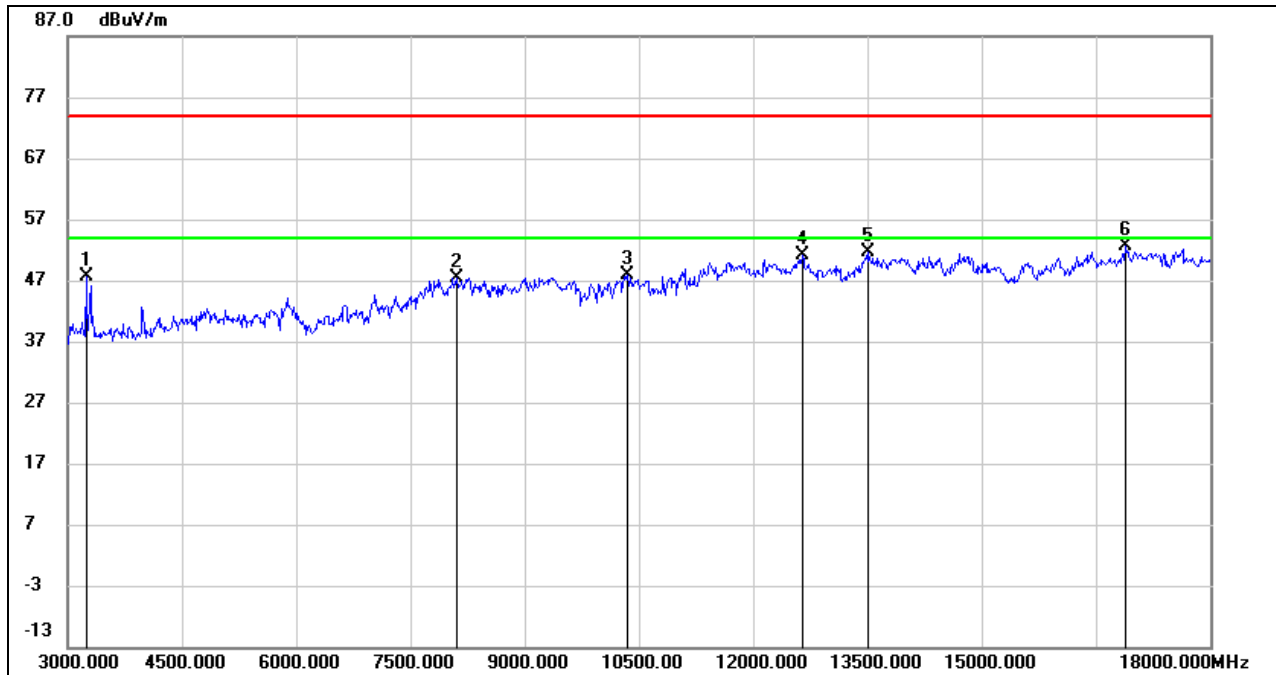

No.	Frequency (MHz)	Reading (dBuV)	Correct (dB/m)	Result (dBuV/m)	Limit (dBuV/m)	Margin (dB)	Remark
1	3240.000	51.50	-3.82	47.68	74.00	-26.32	peak
2	8100.000	37.26	10.18	47.44	74.00	-26.56	peak
3	10350.000	35.96	12.02	47.98	74.00	-26.02	peak
4	12645.000	35.38	15.71	51.09	74.00	-22.91	peak
5	13500.000	34.52	17.22	51.74	74.00	-22.26	peak
6	16890.000	31.13	21.49	52.62	74.00	-21.38	peak

- Note: 1. Peak Result = Reading Level + Correct Factor.
 2. If Peak Result complies with AV limit, AV Result is deemed to comply with AV limit.
 3. Peak: Peak detector.
 4. Filter losses were only considered in the spurious frequency bands and the authorized band was not corrected for High Pass Filter losses.
 5. Proper operation of the transmitter prior to adding the filter to the measurement chain.

HARMONICS AND SPURIOUS EMISSIONS (HIGH CHANNEL, HORIZONTAL)

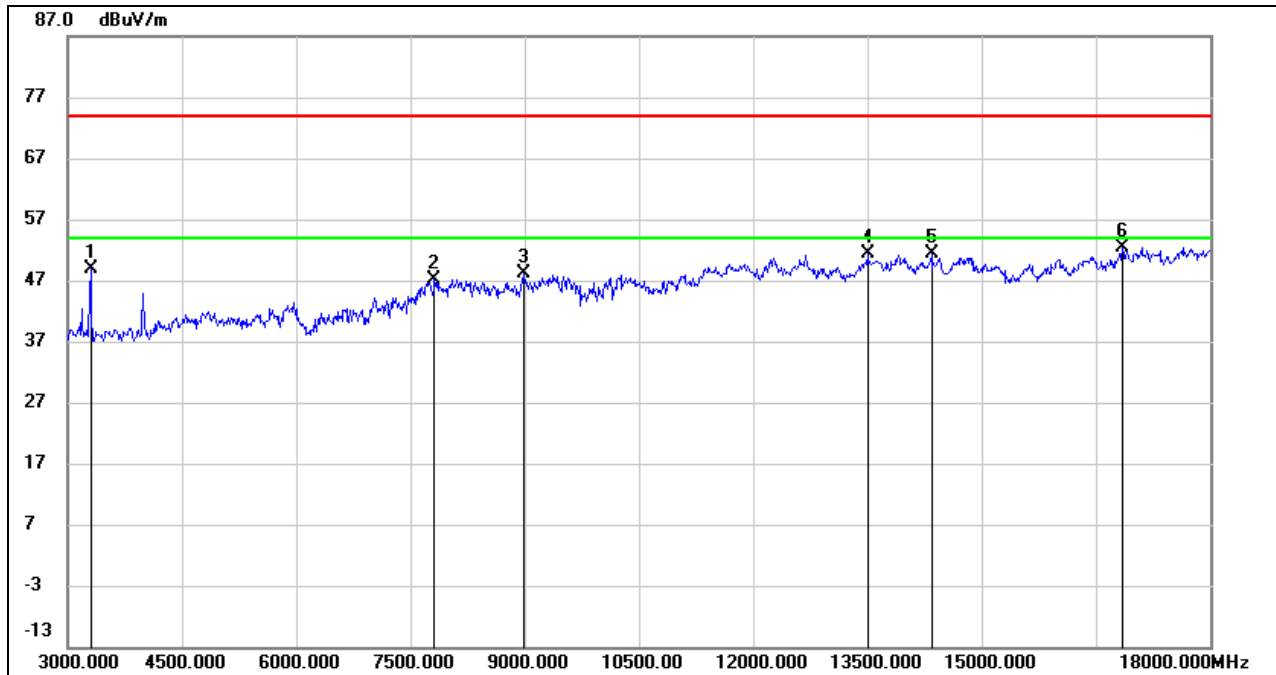

No.	Frequency (MHz)	Reading (dBuV)	Correct (dB/m)	Result (dBuV/m)	Limit (dBuV/m)	Margin (dB)	Remark
1	3300.000	52.45	-3.60	48.85	74.00	-25.15	peak
2	7815.000	37.97	9.28	47.25	74.00	-26.75	peak
3	8985.000	37.21	10.99	48.20	74.00	-25.80	peak
4	13500.000	34.04	17.22	51.26	74.00	-22.74	peak
5	14340.000	33.60	17.84	51.44	74.00	-22.56	peak
6	16845.000	31.38	21.10	52.48	74.00	-21.52	peak

- Note: 1. Peak Result = Reading Level + Correct Factor.
 2. If Peak Result complies with AV limit, AV Result is deemed to comply with AV limit.
 3. Peak: Peak detector.
 4. Filter losses were only considered in the spurious frequency bands and the authorized band was not corrected for High Pass Filter losses.
 5. Proper operation of the transmitter prior to adding the filter to the measurement chain.

HARMONICS AND SPURIOUS EMISSIONS (HIGH CHANNEL, VERTICAL)

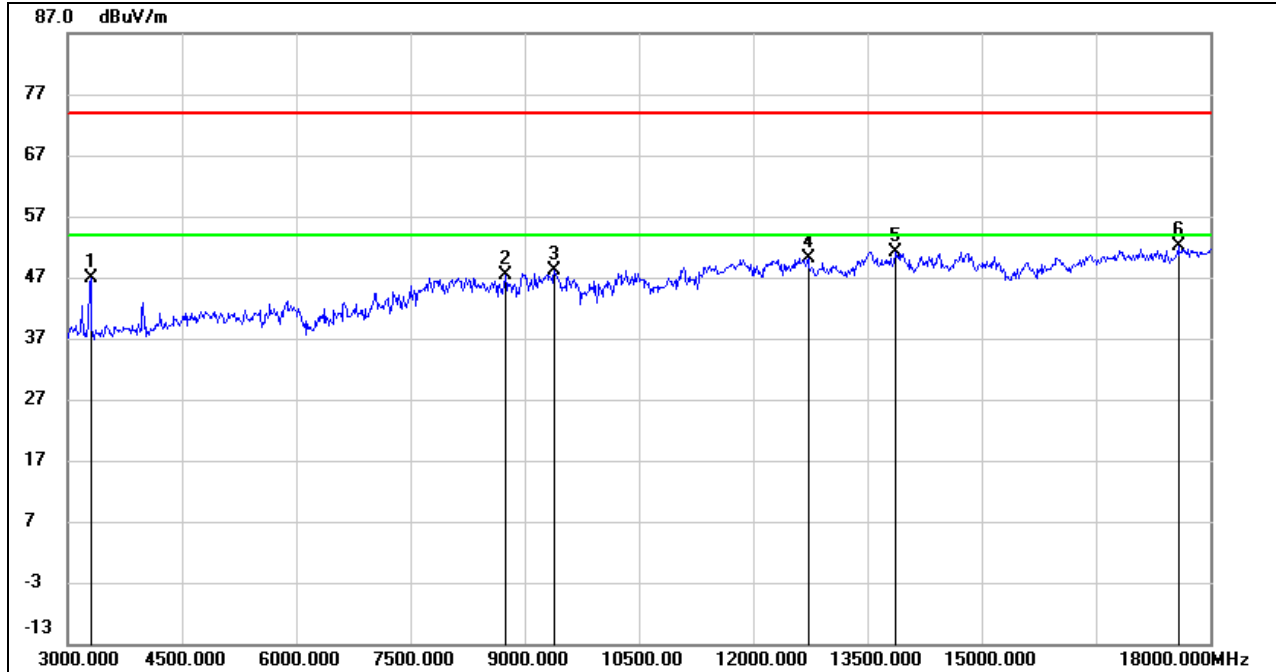

No.	Frequency (MHz)	Reading (dBuV)	Correct (dB/m)	Result (dBuV/m)	Limit (dBuV/m)	Margin (dB)	Remark
1	3300.000	50.48	-3.60	46.88	74.00	-27.12	peak
2	8745.000	38.25	9.13	47.38	74.00	-26.62	peak
3	9390.000	37.30	10.92	48.22	74.00	-25.78	peak
4	12720.000	34.52	15.70	50.22	74.00	-23.78	peak
5	13875.000	33.69	17.55	51.24	74.00	-22.76	peak
6	17580.000	29.55	22.60	52.15	74.00	-21.85	peak

- Note: 1. Peak Result = Reading Level + Correct Factor.
 2. If Peak Result complies with AV limit, AV Result is deemed to comply with AV limit.
 3. Peak: Peak detector.
 4. Filter losses were only considered in the spurious frequency bands and the authorized band was not corrected for High Pass Filter losses.
 5. Proper operation of the transmitter prior to adding the filter to the measurement chain.

8.4. SPURIOUS EMISSIONS (18 GHz ~ 26 GHz)

8.4.1. LE 1M MODE

SPURIOUS EMISSIONS (HIGH CHANNEL, WORST-CASE CONFIGURATION, HORIZONTAL)

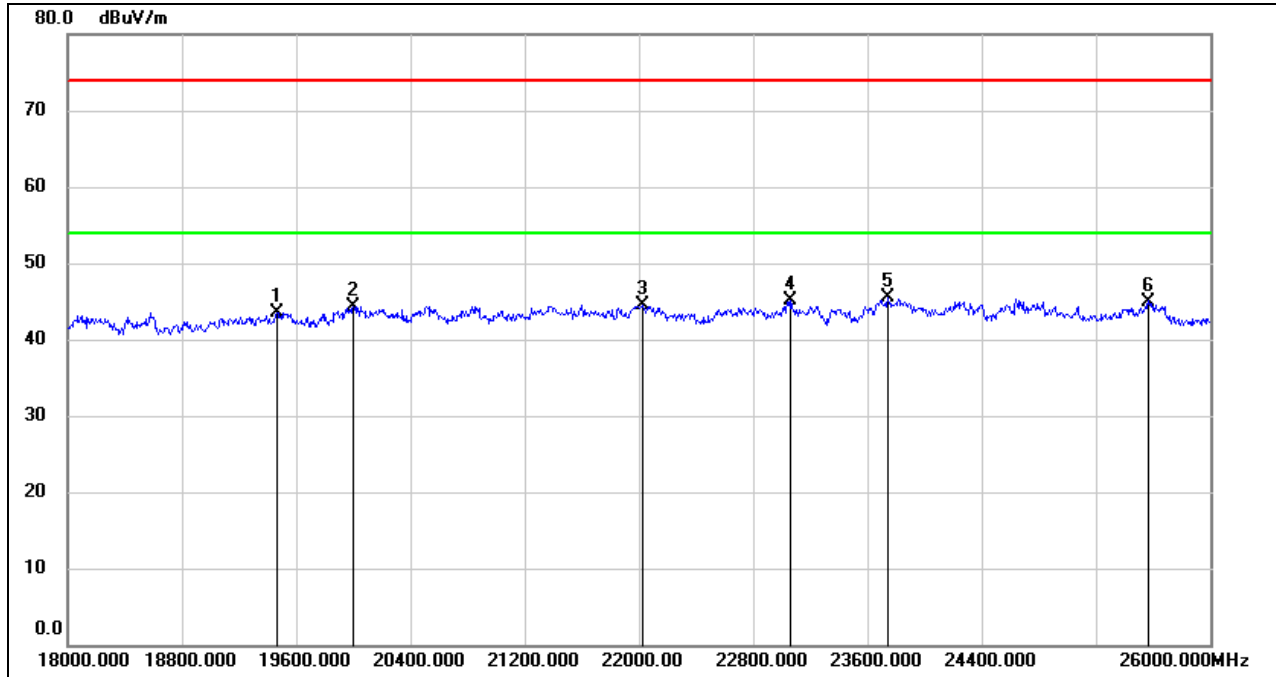

No.	Frequency (MHz)	Reading (dBuV)	Correct (dB/m)	Result (dBuV/m)	Limit (dBuV/m)	Margin (dB)	Remark
1	19464.000	49.14	-5.55	43.59	74.00	-30.41	peak
2	20000.000	49.81	-5.45	44.36	74.00	-29.64	peak
3	22024.000	49.04	-4.46	44.58	74.00	-29.42	peak
4	23064.000	48.49	-3.42	45.07	74.00	-28.93	peak
5	23744.000	48.65	-3.20	45.45	74.00	-28.55	peak
6	25568.000	46.46	-1.46	45.00	74.00	-29.00	peak

Note: 1. Peak Result = Reading Level + Correct Factor.

2. If Peak Result complies with AV limit, AV Result is deemed to comply with AV limit.

3. Peak: Peak detector.

SPURIOUS EMISSIONS (HIGH CHANNEL, WORST-CASE CONFIGURATION, VERTICAL)

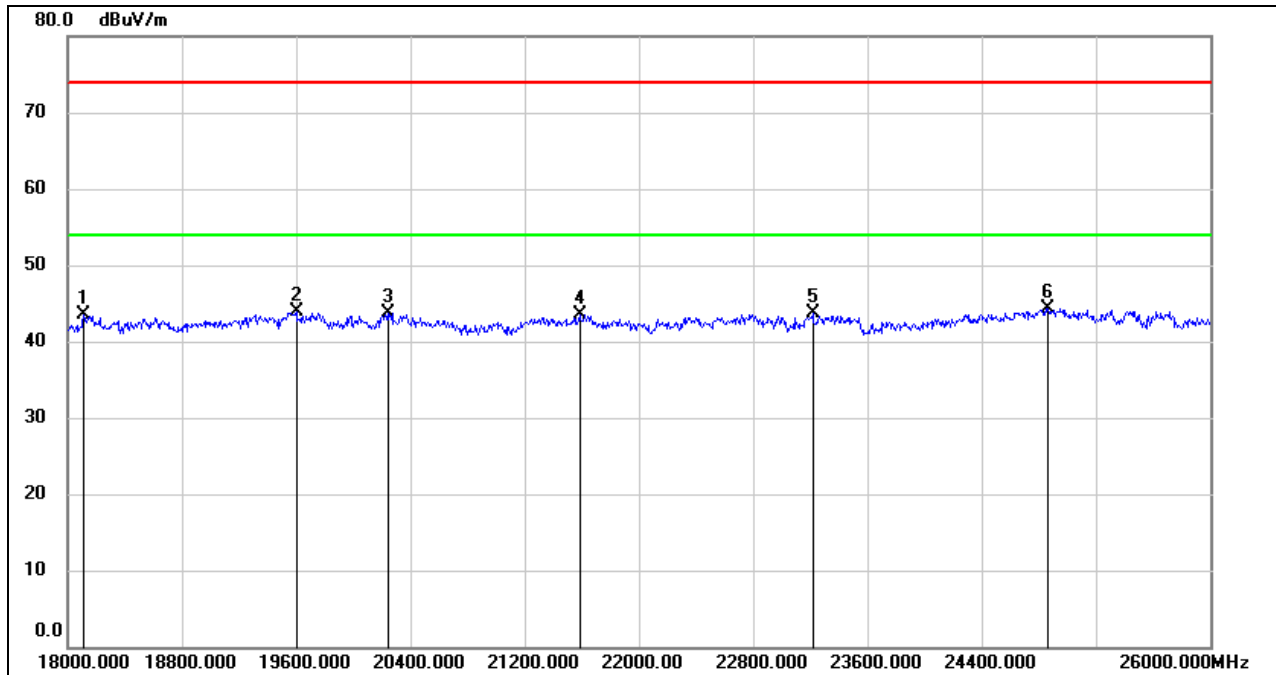

No.	Frequency (MHz)	Reading (dBuV)	Correct (dB/m)	Result (dBuV/m)	Limit (dBuV/m)	Margin (dB)	Remark
1	18112.000	48.96	-5.47	43.49	74.00	-30.51	peak
2	19600.000	49.29	-5.43	43.86	74.00	-30.14	peak
3	20240.000	49.32	-5.61	43.71	74.00	-30.29	peak
4	21584.000	48.10	-4.56	43.54	74.00	-30.46	peak
5	23216.000	47.01	-3.38	43.63	74.00	-30.37	peak
6	24864.000	46.53	-2.23	44.30	74.00	-29.70	peak

- Note: 1. Peak Result = Reading Level + Correct Factor.
 2. If Peak Result complies with AV limit, AV Result is deemed to comply with AV limit.
 3. Peak: Peak detector.

Note: All the modes have been tested, only the worst data was recorded in the report.

8.5. SPURIOUS EMISSIONS (30 MHz ~ 1 GHz)

8.5.1. LE 1M MODE

SPURIOUS EMISSIONS (HIGH CHANNEL, WORST-CASE CONFIGURATION, HORIZONTAL)

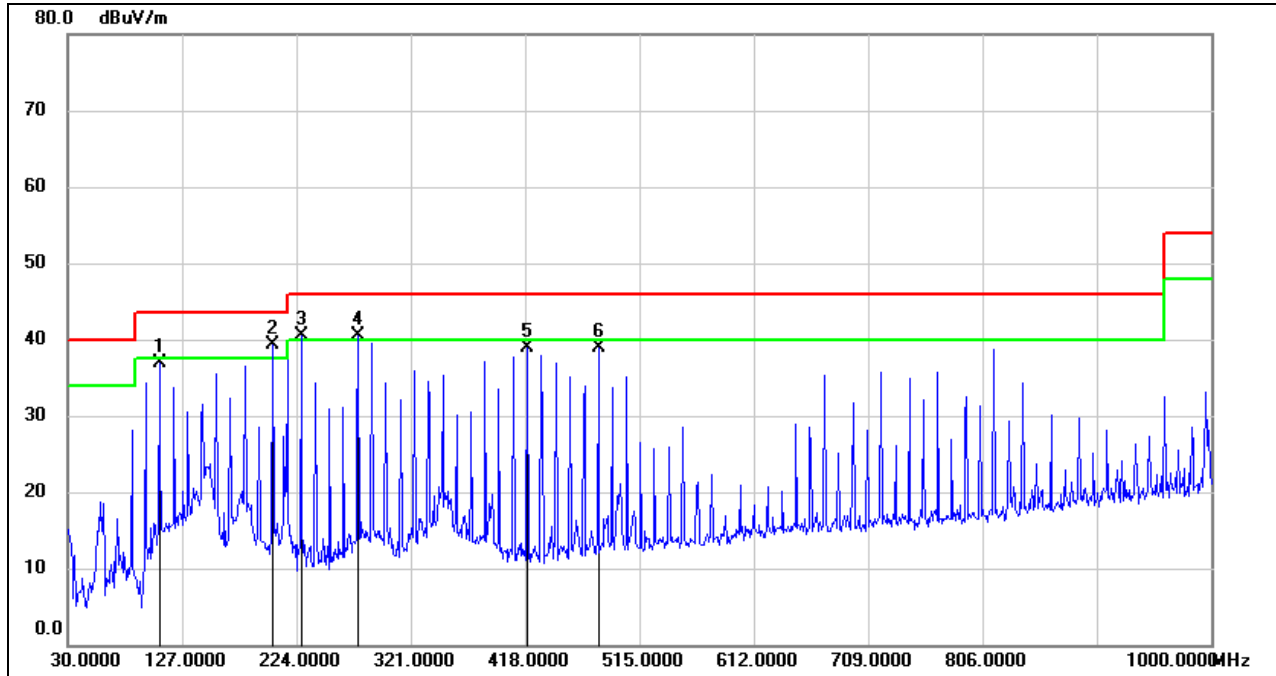

No.	Frequency (MHz)	Reading (dBuV)	Correct (dB/m)	Result (dBuV/m)	Limit (dBuV/m)	Margin (dB)	Remark
1	107.6000	57.46	-20.58	36.88	43.50	-6.62	QP
2	203.6300	55.98	-16.70	39.28	43.50	-4.22	QP
3	227.8800	59.06	-18.55	40.51	46.00	-5.49	QP
4	276.3800	57.64	-17.06	40.58	46.00	-5.42	QP
5	419.9400	51.96	-12.99	38.97	46.00	-7.03	QP
6	480.0800	50.64	-11.79	38.85	46.00	-7.15	QP

- Note: 1. Result Level = Read Level + Correct Factor.
 2. If Peak Result complies with QP limit, QP Result is deemed to comply with QP limit.
 3. Test setup: RBW: 120 kHz, VBW: 300 kHz, Sweep time: auto.

SPURIOUS EMISSIONS (HIGH CHANNEL, WORST-CASE CONFIGURATION, VERTICAL)

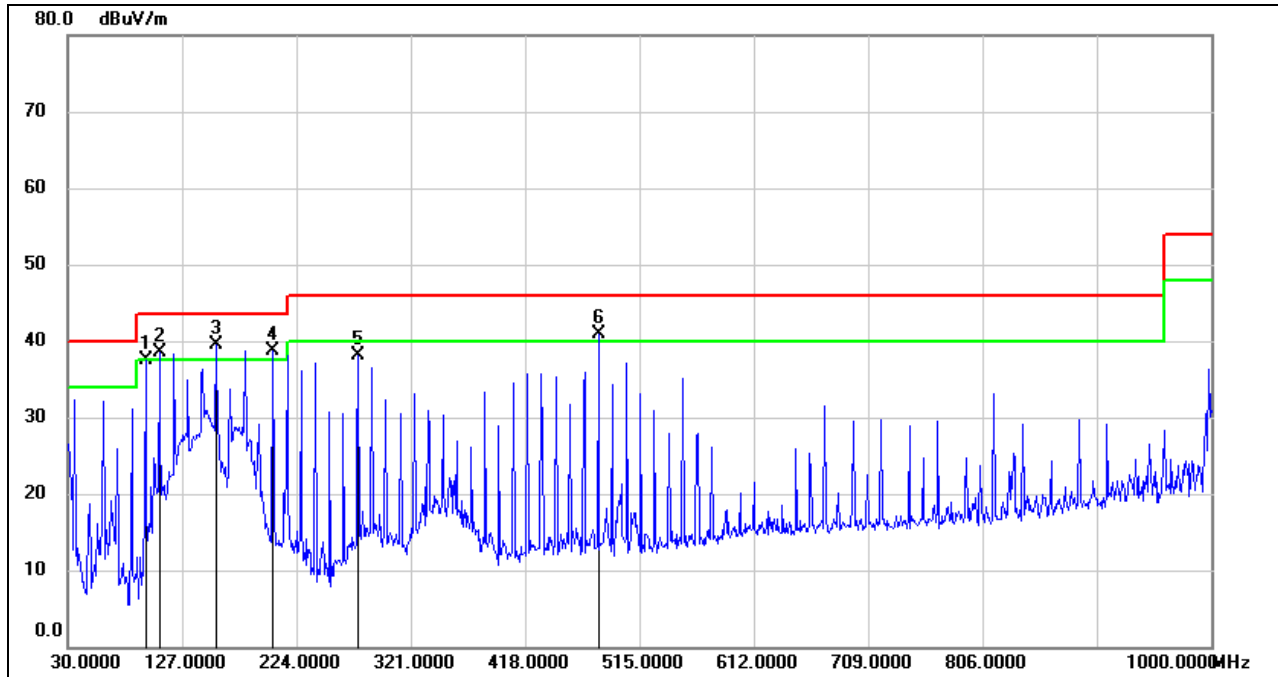

No.	Frequency (MHz)	Reading (dBuV)	Correct (dB/m)	Result (dBuV/m)	Limit (dBuV/m)	Margin (dB)	Remark
1	95.9600	59.00	-21.44	37.56	43.50	-5.94	QP
2	107.6000	59.15	-20.58	38.57	43.50	-4.93	QP
3	156.1000	57.55	-17.96	39.59	43.50	-3.91	QP
4	203.6300	55.34	-16.70	38.64	43.50	-4.86	QP
5	276.3800	55.12	-17.06	38.06	46.00	-7.94	QP
6	480.0800	52.68	-11.79	40.89	46.00	-5.11	QP

- Note: 1. Result Level = Read Level + Correct Factor.
 2. If Peak Result complies with QP limit, QP Result is deemed to comply with QP limit.
 3. Test setup: RBW: 120 kHz, VBW: 300 kHz, Sweep time: auto

Note: All the modes have been tested, only the worst data was recorded in the report.

8.6. SPURIOUS EMISSIONS BELOW 30 MHz

8.6.1. LE 1M MODE

SPURIOUS EMISSIONS (HIGH CHANNEL, LOOP ANTENNA FACE ON TO THE EUT, WORST-CASE CONFIGURATION)

9 kHz~ 150 kHz

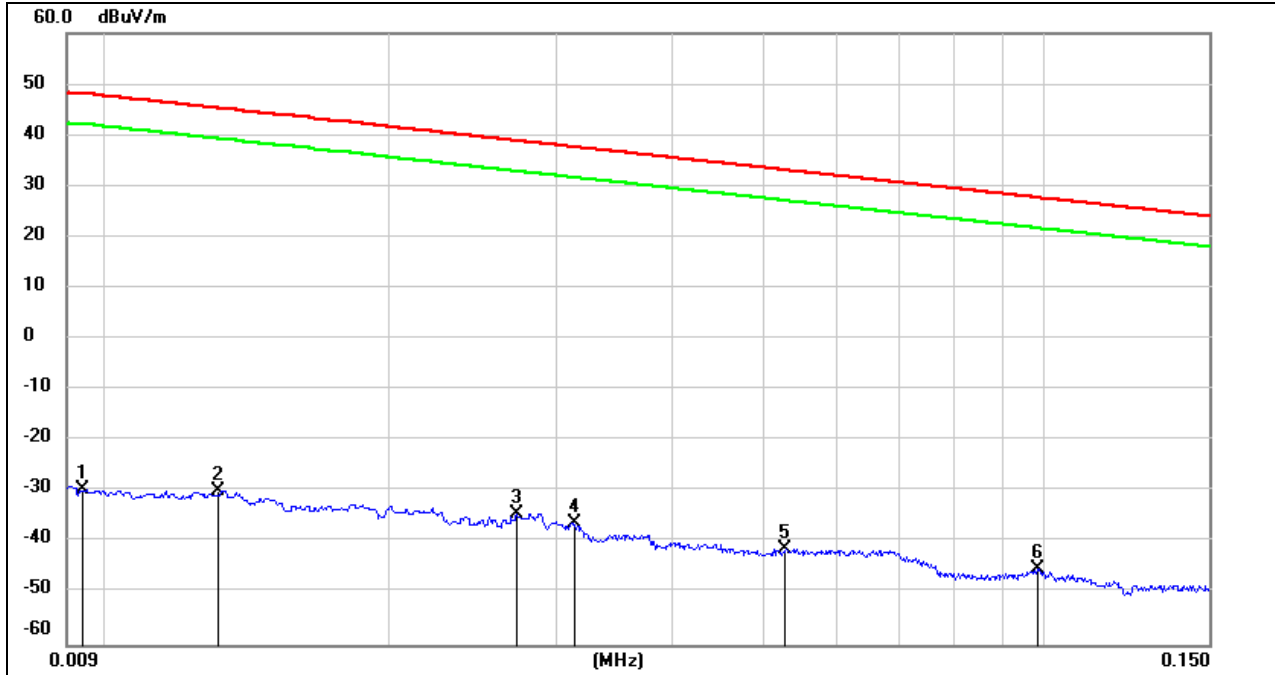

No.	Frequency (MHz)	Reading (dBuV)	Correct (dB/m)	FCC Result (dBuV/m)	FCC Limit (dBuV/m)	ISED Result (dBuA/m)	ISED Limit (dBuA/m)	Margin (dB)	Remark
1	0.0094	71.66	-101.35	-29.69	48.05	-81.19	-3.45	-77.74	peak
2	0.0131	71.47	-101.38	-29.91	45.25	-81.41	-6.25	-75.16	peak
3	0.0273	66.99	-101.38	-34.39	38.88	-85.89	-12.62	-73.27	peak
4	0.0314	65.10	-101.40	-36.3	37.66	-87.80	-13.84	-73.96	peak
5	0.0529	60.27	-101.49	-41.22	33.13	-92.72	-18.37	-74.35	peak
6	0.0985	56.55	-101.78	-45.23	27.73	-96.73	-23.77	-72.96	peak

Note: 1. If Peak Result complies with AV and QP limit, AV and QP Result are deemed to comply with AV limit.

2. All 3 polarizations (Horizontal, Face-on and Face-off) of the loop antenna had been tested, but only the worst data recorded in the report.

150 kHz ~ 490 kHz

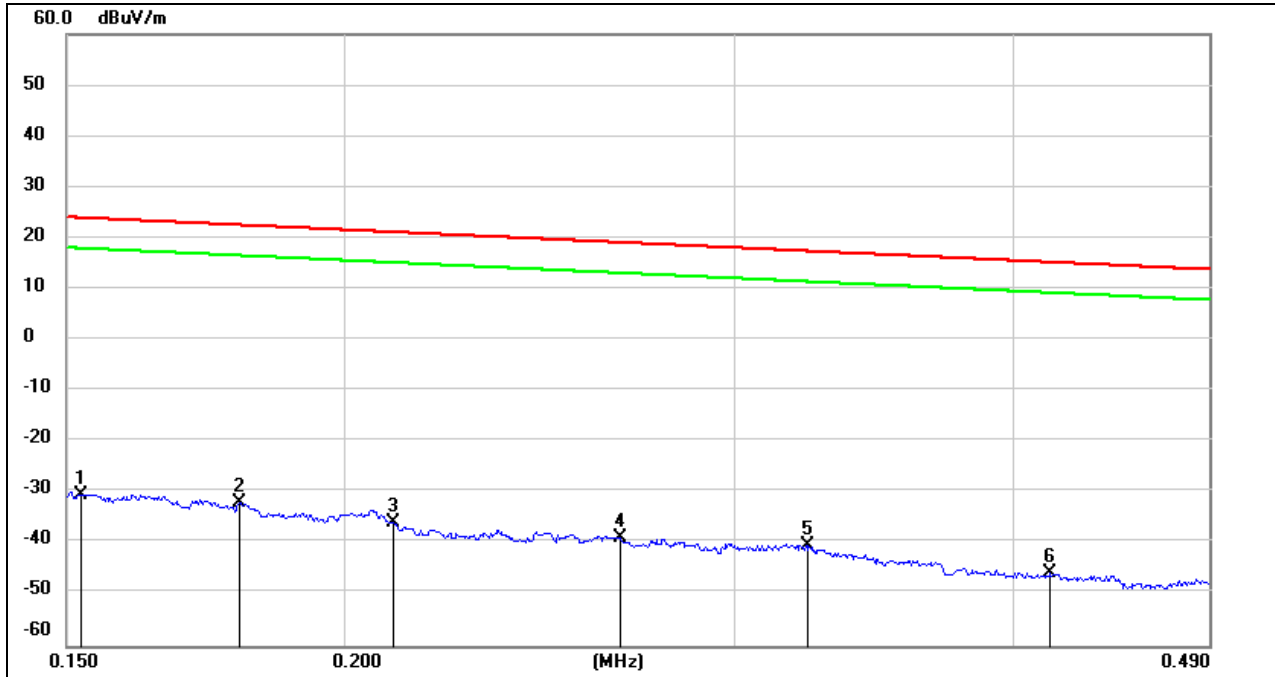

No.	Frequency (MHz)	Reading (dBuV)	Correct (dB/m)	FCC Result (dBuV/m)	FCC Limit (dBuV/m)	ISED Result (dBuA/m)	ISED Limit (dBuA/m)	Margin (dB)	Remark
1	0.1524	71.30	-101.63	-30.33	23.94	-81.83	-27.56	-54.27	peak
2	0.1794	69.77	-101.68	-31.91	22.53	-83.41	-28.97	-54.44	peak
3	0.2104	65.97	-101.73	-35.76	21.14	-87.26	-30.36	-56.90	peak
4	0.2661	62.98	-101.82	-38.84	19.1	-90.34	-32.40	-57.94	peak
5	0.3234	61.48	-101.88	-40.4	17.41	-91.90	-34.09	-57.81	peak
6	0.4158	56.19	-101.98	-45.79	15.22	-97.29	-36.28	-61.01	peak

Note: 1. If Peak Result complies with AV and QP limit, AV and QP Result are deemed to comply with AV limit.
 2. All 3 polarizations (Horizontal, Face-on and Face-off) of the loop antenna had been tested, but only the worst data recorded in the report.

490 kHz ~ 30 MHz

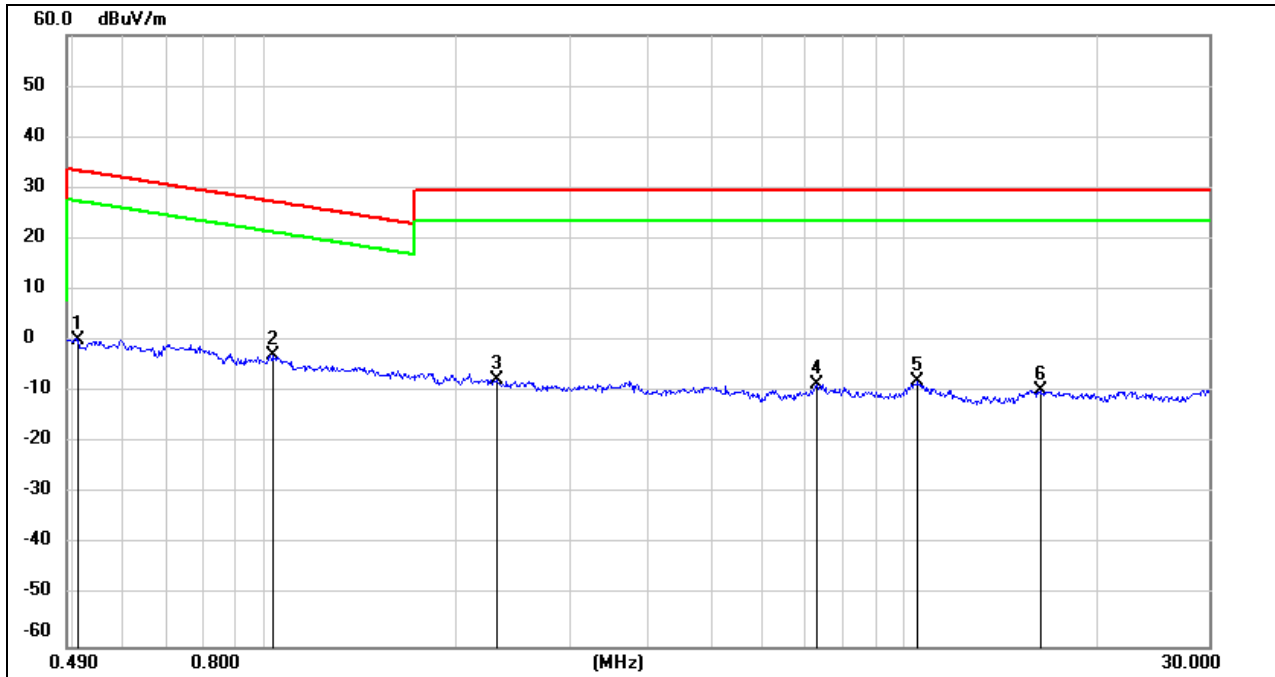

No.	Frequency (MHz)	Reading (dBuV)	Correct (dB/m)	FCC Result (dBuV/m)	FCC Limit (dBuV/m)	ISED Result (dBuA/m)	ISED Limit (dBuA/m)	Margin (dB)	Remark
1	0.5106	62.30	-62.07	0.23	33.44	-51.27	-18.06	-33.21	peak
2	1.0319	59.28	-62.25	-2.97	27.33	-54.47	-24.17	-30.30	peak
3	2.3195	54.04	-61.75	-7.71	29.54	-59.21	-21.96	-37.25	peak
4	7.3361	52.58	-61.17	-8.59	29.54	-60.09	-21.96	-38.13	peak
5	10.5234	52.80	-60.82	-8.02	29.54	-59.52	-21.96	-37.56	peak
6	16.3959	51.17	-60.96	-9.79	29.54	-61.29	-21.96	-39.33	peak

Note: 1. If Peak Result complies with AV and QP limit, AV and QP Result are deemed to comply with AV limit.

2. All 3 polarizations (Horizontal, Face-on and Face-off) of the loop antenna had been tested, but only the worst data recorded in the report.

Note: All the modes have been tested, but only the worst data was recorded in the report.

9. AC POWER LINE CONDUCTED EMISSIONS

LIMITS

Please refer to CFR 47 FCC §15.207 (a) and ISED RSS-Gen Clause 8.8

FREQUENCY (MHz)	Quasi-peak	Average
0.15 -0.5	66 - 56 *	56 - 46 *
0.50 -5.0	56.00	46.00
5.0 -30.0	60.00	50.00

TEST SETUP AND PROCEDURE

Refer to ANSI C63.10-2013 clause 6.2.

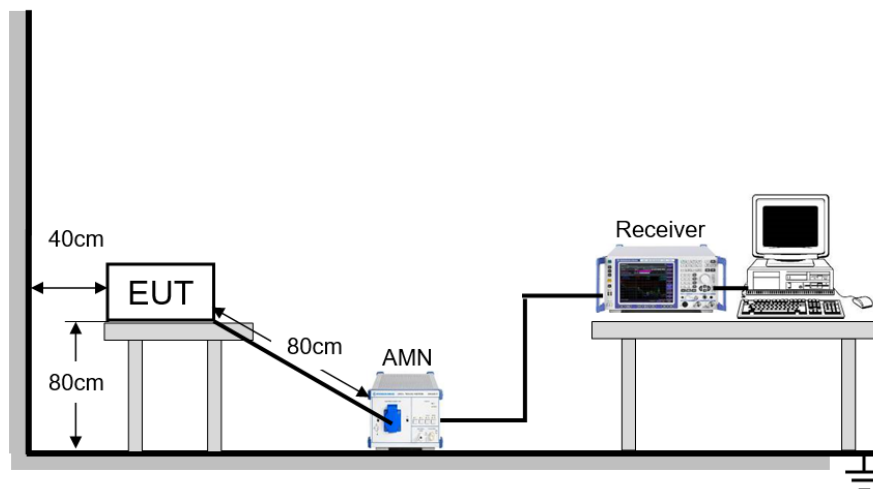

The EUT is put on a table of non-conducting material that is 80 cm high. The vertical conducting wall of shielding is located 40 cm to the rear of the EUT. The power line of the EUT is connected to the AC mains through a Artificial Mains Network (A.M.N.). A EMI Measurement Receiver (R&S Test Receiver ESR3) is used to test the emissions from both sides of AC line. According to the requirements in Section 6.2 of ANSI C63.10-2013. Conducted emissions from the EUT measured in the frequency range between 0.15 MHz and 30 MHz using CISPR Quasi-Peak and average detector mode. The bandwidth of EMI test receiver is set at 9 kHz.

The arrangement of the equipment is installed to meet the standards and operating in a manner, which tends to maximize its emission characteristics in a normal application.

TEST ENVIRONMENT

Temperature	24.3 °C	Relative Humidity	62.1 %
Atmosphere Pressure	101 kPa	Test Voltage	DC 5 V

RESULTS

9.1. LE 1M MODE

LINE L RESULTS (HIGH CHANNEL, WORST-CASE CONFIGURATION)

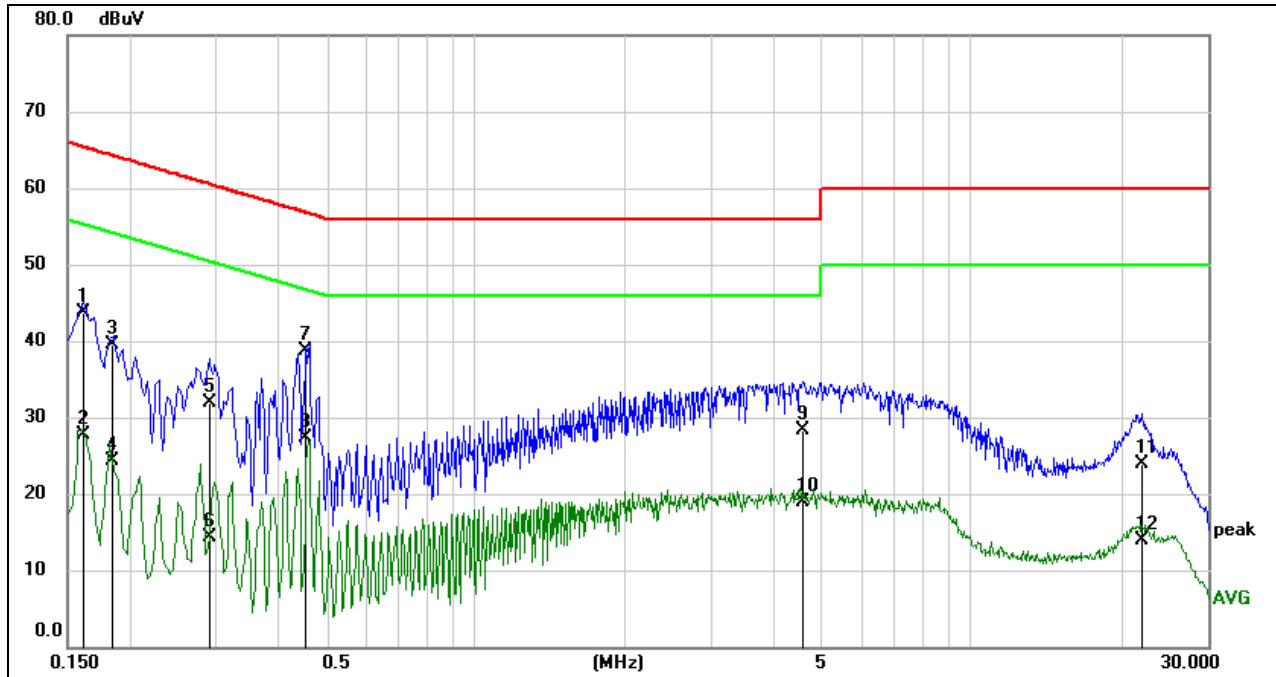

No.	Frequency (MHz)	Reading (dBuV)	Correct (dB)	Result (dBuV)	Limit (dBuV)	Margin (dB)	Remark
1	0.1619	34.03	9.59	43.62	65.37	-21.75	QP
2	0.1619	18.15	9.59	27.74	55.37	-27.63	AVG
3	0.1844	30.01	9.59	39.60	64.29	-24.69	QP
4	0.1844	14.79	9.59	24.38	54.29	-29.91	AVG
5	0.2912	22.27	9.59	31.86	60.49	-28.63	QP
6	0.2912	4.62	9.59	14.21	50.49	-36.28	AVG
7	0.4572	29.09	9.60	38.69	56.74	-18.05	QP
8	0.4572	17.64	9.60	27.24	46.74	-19.50	AVG
9	4.5669	18.75	9.61	28.36	56.00	-27.64	QP
10	4.5669	9.22	9.61	18.83	46.00	-27.17	AVG
11	22.1267	14.03	9.86	23.89	60.00	-36.11	QP
12	22.1267	4.08	9.86	13.94	50.00	-36.06	AVG

Note: 1. Result = Reading + Correct Factor.
 2. If QP Result complies with AV limit, AV Result is deemed to comply with AV limit.
 3. Test setup: RBW: 200 Hz (9 kHz ~ 150 kHz), 9 kHz (150 kHz ~ 30 MHz).
 4. Step size: 80 Hz (0.009 MHz ~ 0.15 MHz), 4 kHz (0.15 MHz ~ 30 MHz), Scan time: auto.

LINE N RESULTS (HIGH CHANNEL, WORST-CASE CONFIGURATION)

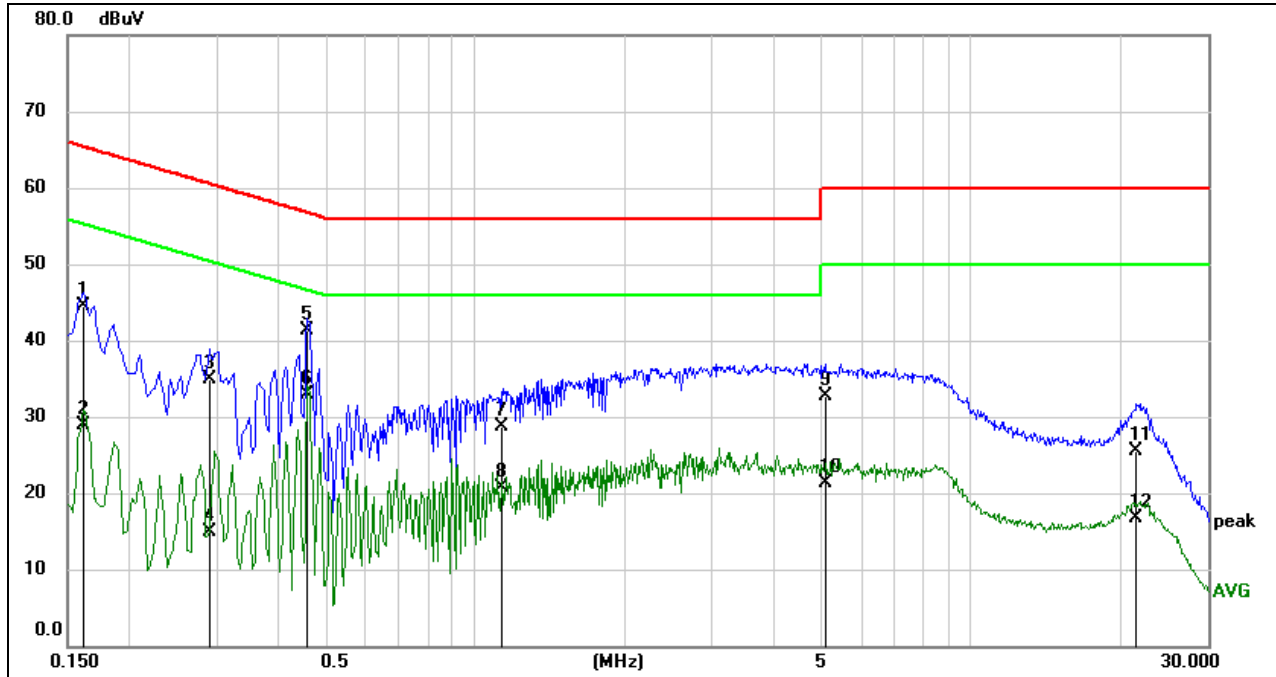

No.	Frequency (MHz)	Reading (dBuV)	Correct (dB)	Result (dBuV)	Limit (dBuV)	Margin (dB)	Remark
1	0.1615	35.00	9.59	44.59	65.39	-20.80	QP
2	0.1615	19.35	9.59	28.94	55.39	-26.45	AVG
3	0.2891	25.23	9.59	34.82	60.55	-25.73	QP
4	0.2891	5.37	9.59	14.96	50.55	-35.59	AVG
5	0.4582	31.77	9.60	41.37	56.73	-15.36	QP
6	0.4582	23.39	9.60	32.99	46.73	-13.74	AVG
7	1.1281	19.19	9.61	28.80	56.00	-27.20	QP
8	1.1281	11.18	9.61	20.79	46.00	-25.21	AVG
9	5.0780	23.07	9.62	32.69	60.00	-27.31	QP
10	5.0780	11.72	9.62	21.34	50.00	-28.66	AVG
11	21.6397	15.79	9.75	25.54	60.00	-34.46	QP
12	21.6397	7.04	9.75	16.79	50.00	-33.21	AVG

Note: 1. Result = Reading + Correct Factor.
 2. If QP Result complies with AV limit, AV Result is deemed to comply with AV limit.
 3. Test setup: RBW: 200 Hz (9 kHz ~ 150 kHz), 9 kHz (150 kHz ~ 30 MHz).
 4. Step size: 80 Hz (0.009 MHz ~ 0.15 MHz), 4 kHz (0.15 MHz ~ 30 MHz), Scan time: auto.

Note: All the modes have been tested, but only the worst data was recorded in the report.



10. ANTENNA REQUIREMENTS

APPLICABLE REQUIREMENTS

Please refer to FCC §15.203

An intentional radiator shall be designed to ensure that no antenna other than that furnished by the responsible party shall be used with the device. The use of a permanently attached antenna or of an antenna that uses a unique coupling to the intentional radiator shall be considered sufficient to comply with the provisions of this section. The manufacturer may design the unit so that a broken antenna can be replaced by the user, but the use of a standard antenna jack or electrical connector is prohibited.

Please refer to FCC §15.247(b)(4)

The conducted output power limit specified in paragraph (b) of this section is based on the use of antennas with directional gains that do not exceed 6 dBi. Except as shown in paragraph (c) of this section, if transmitting antennas of directional gain greater than 6 dBi are used, the conducted output power from the intentional radiator shall be reduced below the stated values in paragraphs (b)(1), (b)(2), and (b)(3) of this section, as appropriate, by the amount in dB that the directional gain of the antenna exceeds 6 dBi.

RESULTS

Complies



11. Appendix

11.1. Appendix A: DTS Bandwidth

11.1.1. Test Result

Test Mode	Antenna	Channel	DTS BW [MHz]	FL[MHz]	FH[MHz]	Limit[MHz]	Verdict
LE 1M	Ant1	2402	0.642	2401.694	2402.336	0.5	PASS
		2440	0.639	2439.703	2440.342	0.5	PASS
		2480	0.669	2479.685	2480.354	0.5	PASS



11.1.2. Test Graphs

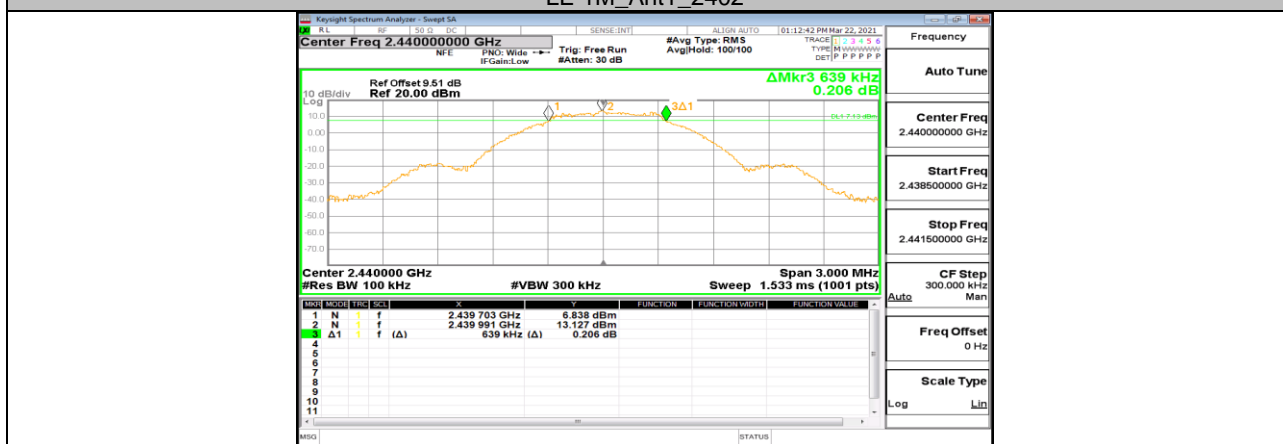



11.2. Appendix B: Occupied Channel Bandwidth

11.2.1. Test Result

Test Mode	Antenna	Channel	OCB [MHz]	FL[MHz]	FH[MHz]	Verdict
LE 1M	Ant1	2402	1.0040	2401.516	2402.520	PASS
		2440	1.0220	2439.503	2440.525	PASS
		2480	1.0125	2479.512	2480.525	PASS



11.2.2. Test Graphs





11.3. Appendix C: Maximum peak conducted output power

11.3.1. Test Result

Test Mode	Antenna	Channel	Result[dBm]	Limit[dBm]	Verdict
LE 1M	Ant1	2402	3.77	<=30	PASS
		2440	5.04	<=30	PASS
		2480	5.33	<=30	PASS



11.4. Appendix D: Maximum power spectral density

11.4.1. Test Result

Test Mode	Antenna	Channel	Result[dBm/3kHz]	Limit[dBm/3kHz]	Verdict
LE 1M	Ant1	2402	-12.95	<=8	PASS
		2440	-11.26	<=8	PASS
		2480	-10.32	<=8	PASS



11.4.2. Test Graphs

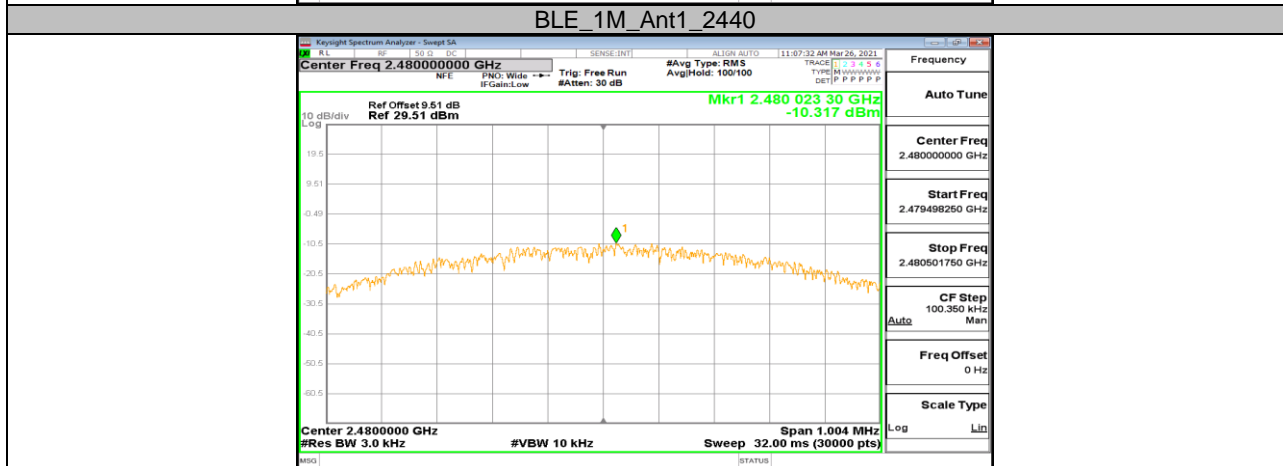
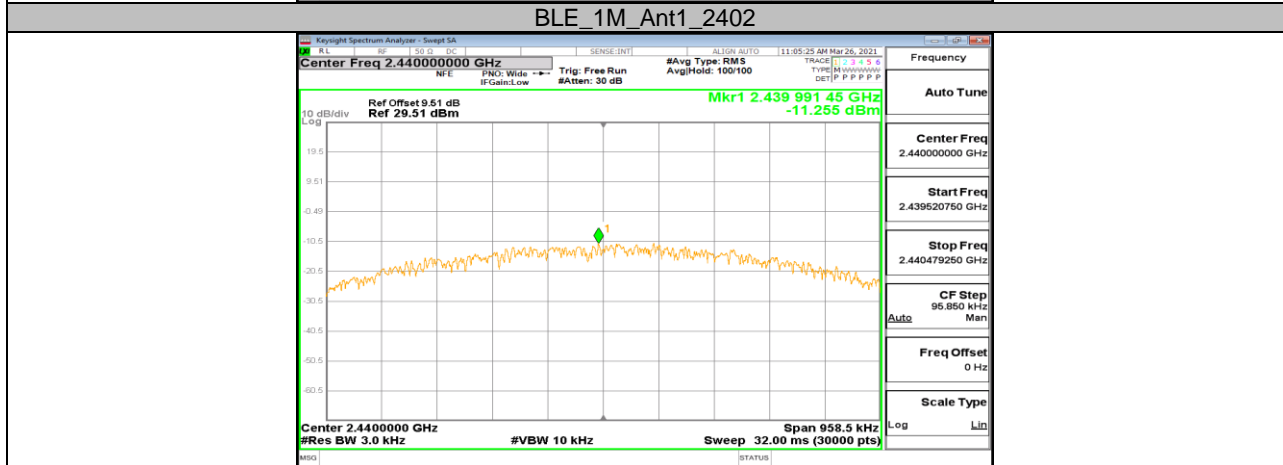
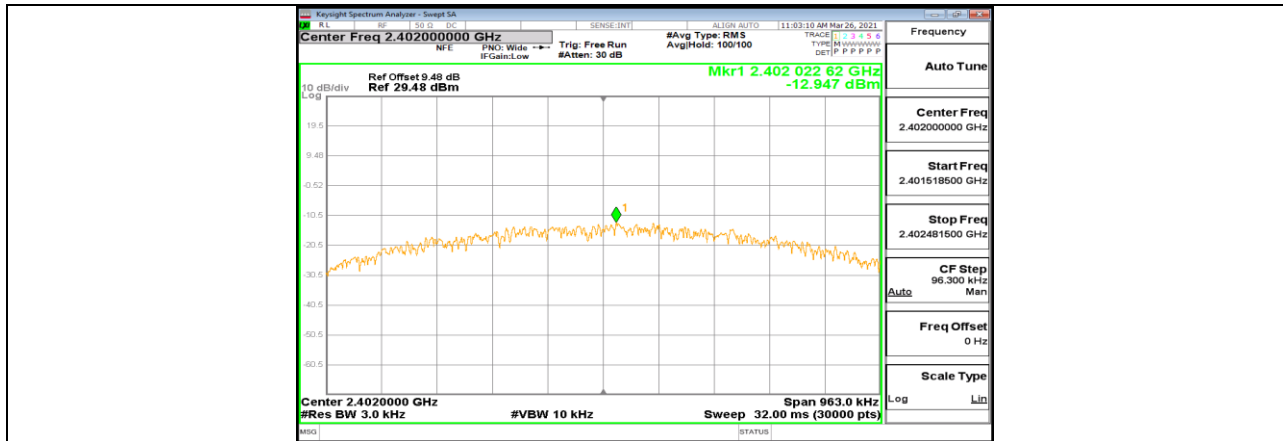



11.5. Appendix E: Band edge measurements

11.5.1. Test Result

Test Mode	Antenna	ChName	Channel	RefLevel[dBm]	Result[dBm]	Limit[dBm]	Verdict
BLE_1M	Ant1	Low	2402	2.84	-49.56	<=-17.16	PASS
		High	2480	5.86	-50.81	<=-14.14	PASS



11.5.2. Test Graphs





11.6. Appendix F: Conducted Spurious Emission

11.6.1. Test Result

Test Mode	Antenna	Channel	FreqRange [MHz]	RefLevel [dBm]	Result[dBm]	Limit[dBm]	Verdict
LE 1M	Ant1	2402	Reference	3.01	3.01	---	PASS
			30~1000	3.01	-49.37	<=-16.99	PASS
			1000~26500	3.01	-47.94	<=-16.99	PASS
		2440	Reference	4.95	4.95	---	PASS
			30~1000	4.95	-46.65	<=-15.05	PASS
			1000~26500	4.95	-46.7	<=-15.05	PASS
		2480	Reference	5.65	5.65	---	PASS
			30~1000	5.65	-46.74	<=-14.35	PASS
			1000~26500	5.65	-49.21	<=-14.35	PASS



11.6.2. Test Graphs

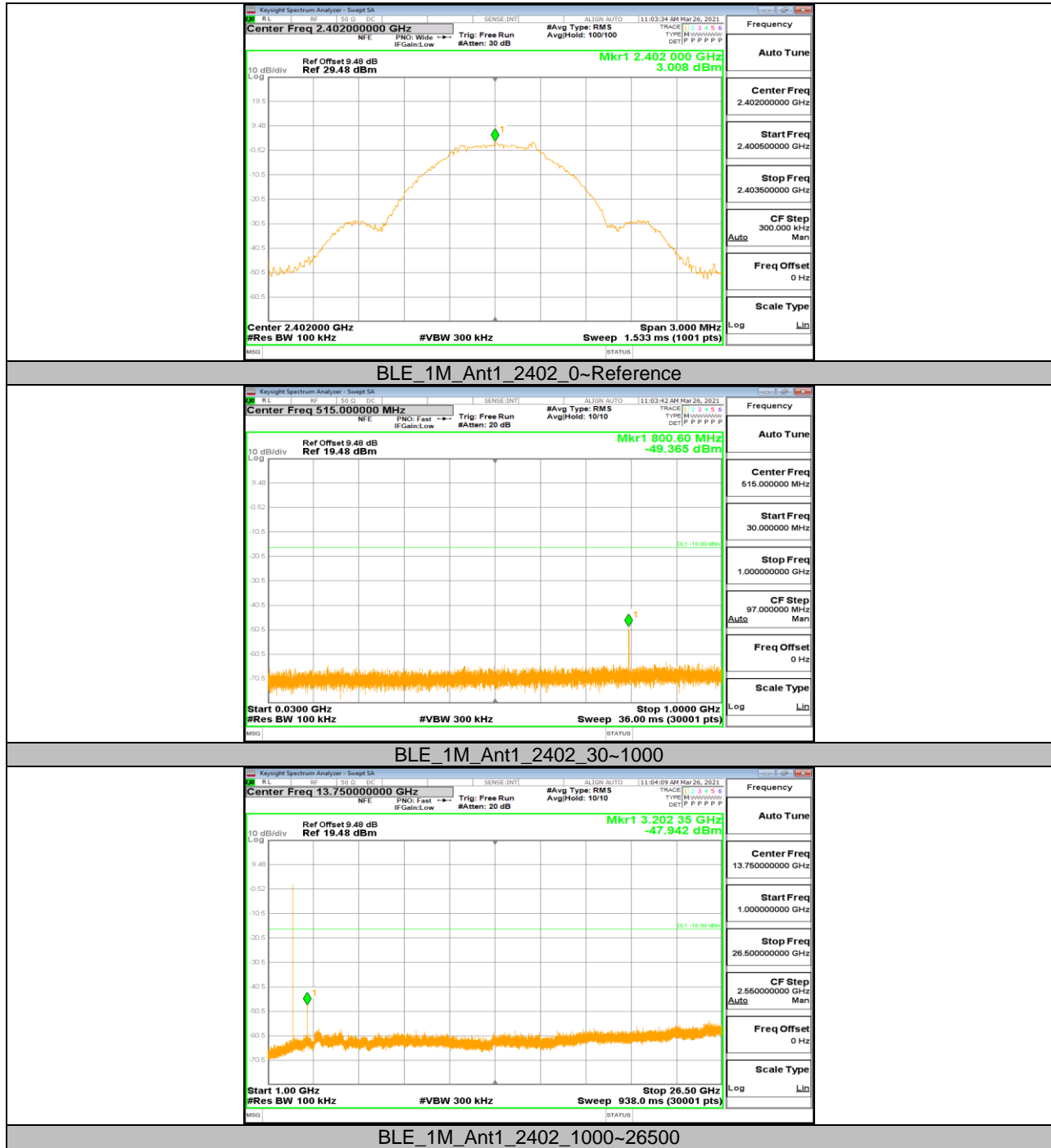

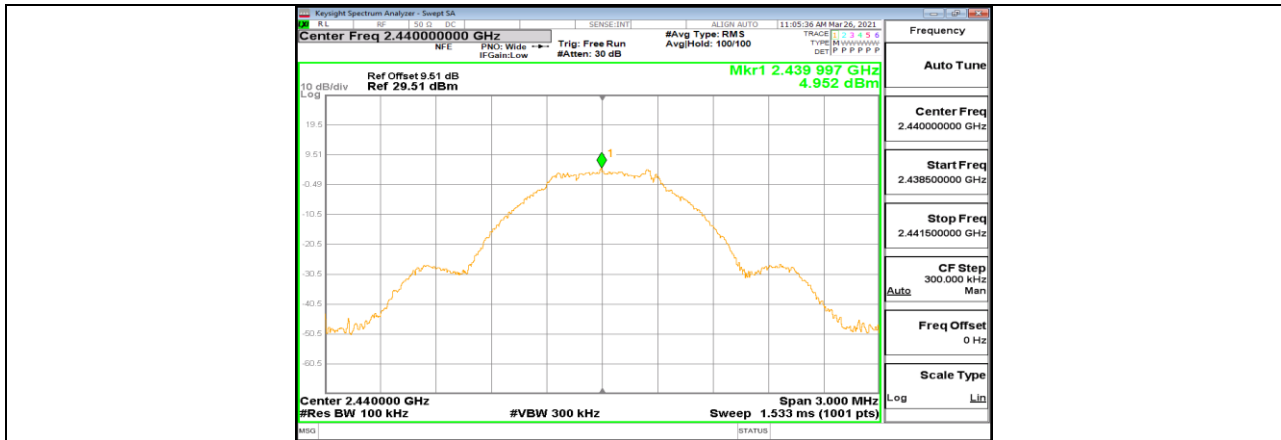

BLE_1M_Ant1_2440_0~Reference

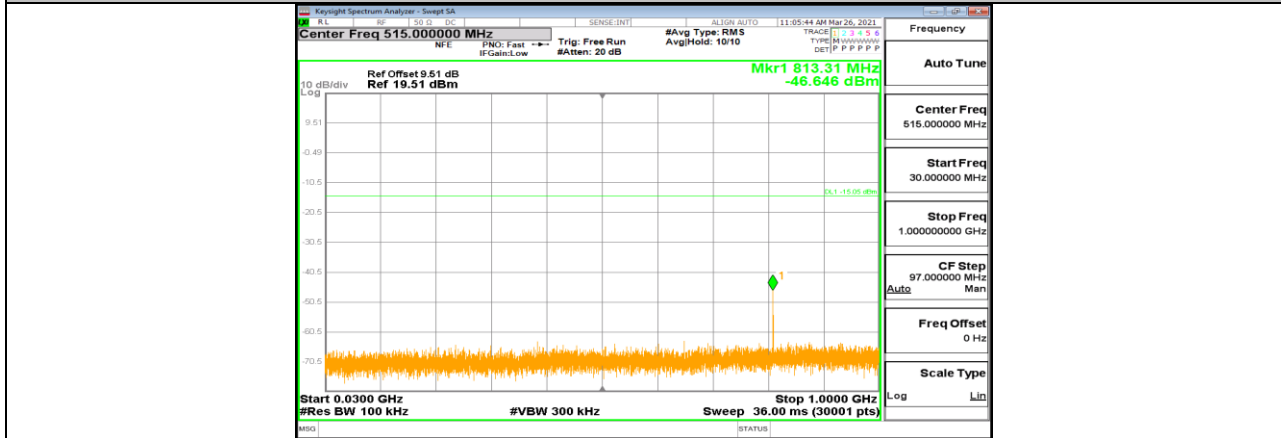

BLE_1M_Ant1_2440_30~1000

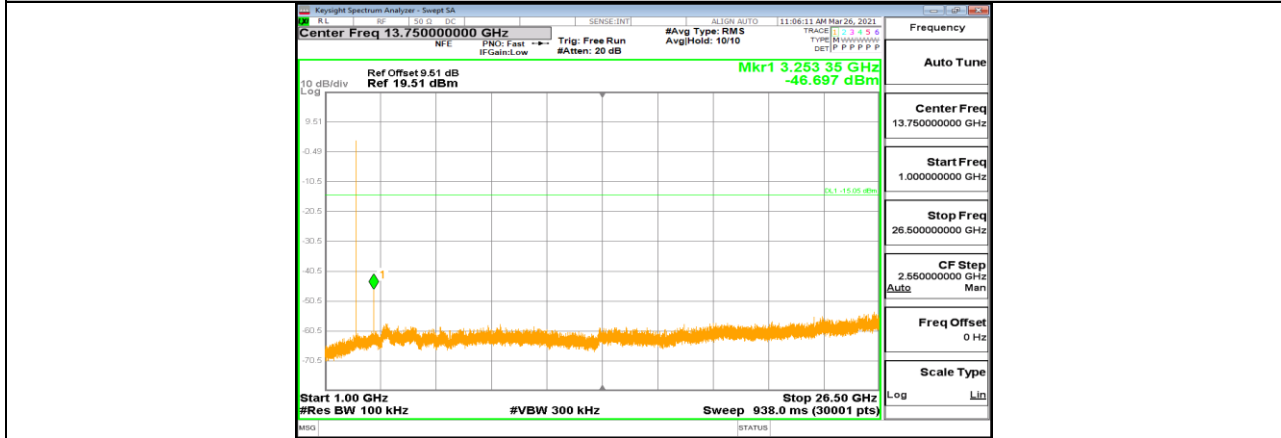

BLE_1M_Ant1_2440_1000~26500

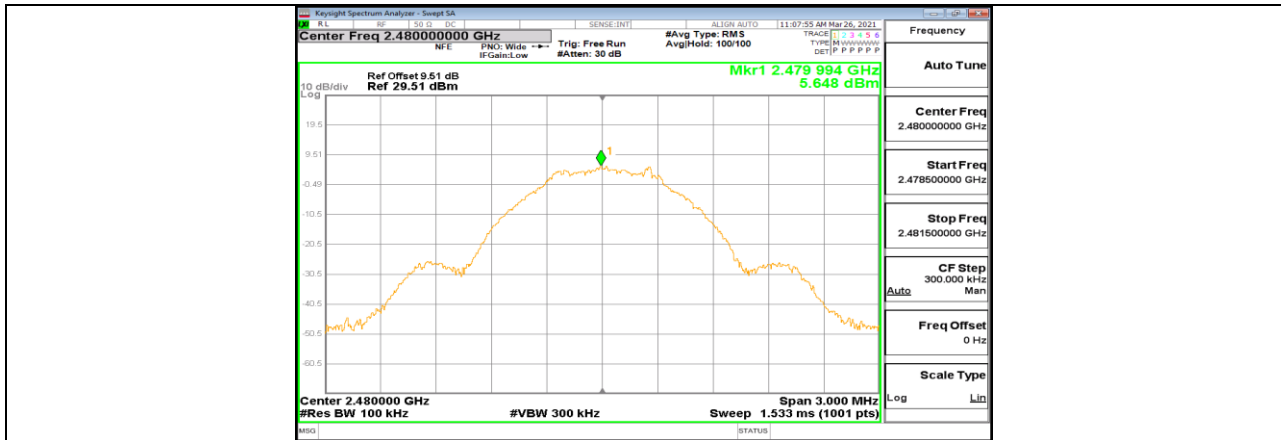

BLE_1M_Ant1_2480_0~Reference

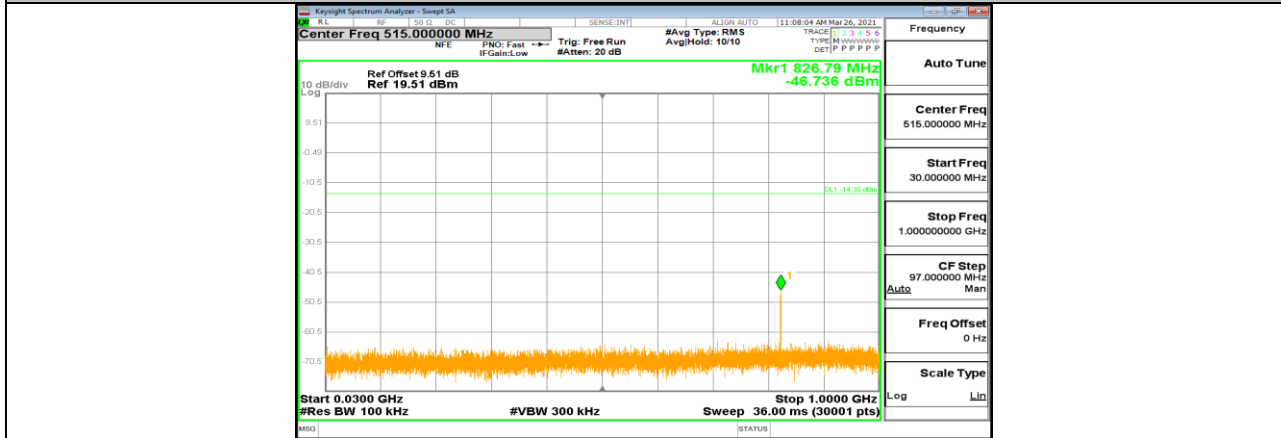

BLE_1M_Ant1_2480_30~1000

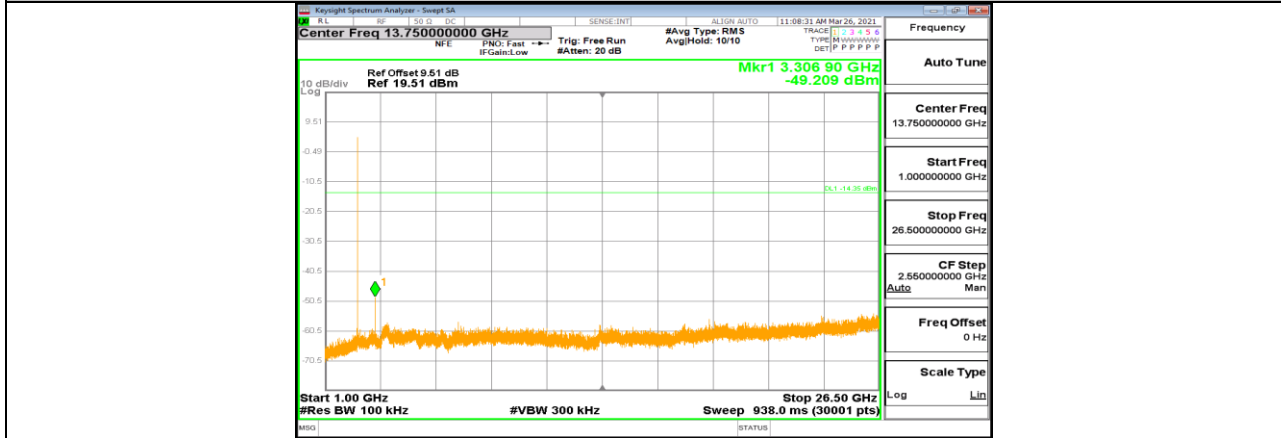



11.7. Appendix G: Duty Cycle

11.7.1. Test Result

Mode	On Time (msec)	Period (msec)	Duty Cycle x (Linear)	Duty Cycle (%)	Duty Cycle Correction Factor (dB)	1/T Minimum VBW (kHz)	Final setting For VBW (kHz)
LE 1M	2.09	2.50	0.8360	83.60	0.78	0.48	0.5

Note:

Duty Cycle Correction Factor= $10\log(1/x)$.

Where: x is Duty Cycle (Linear)

Where: T is On Time

If that calculated VBW is not available on the analyzer then the next higher value should be used.



11.7.2. Test Graphs

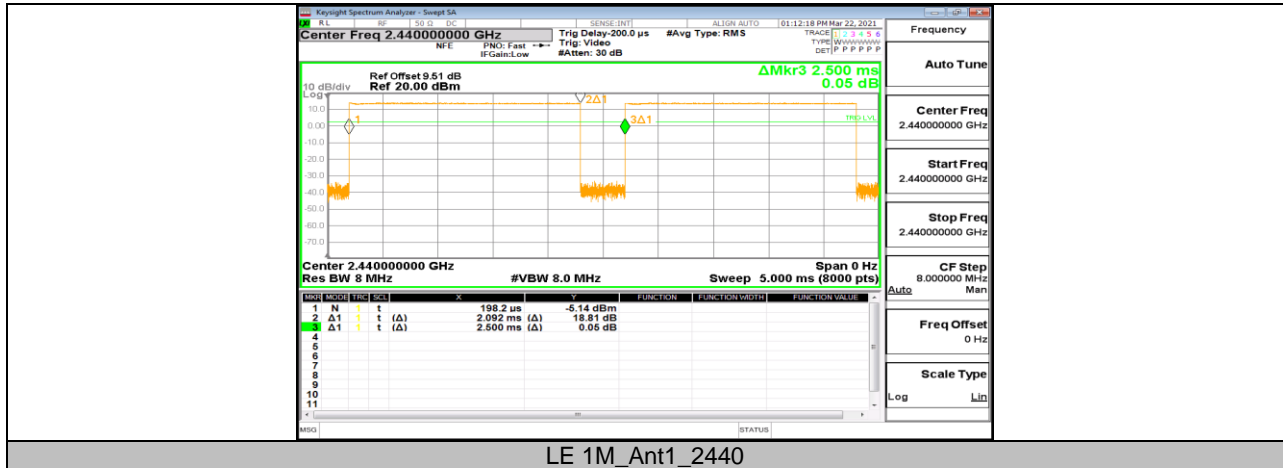

END OF REPORT