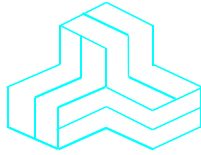


# ENGINEERING TEST REPORT



## Wireless LAN Card Model No.: ISL39000M

### Tested For

#### Intersil Corporation

Rembrandtlaan 1a  
3723 BG Bilthoven  
P.O. Box 343  
3720 AH Bilthoven  
The Netherlands

### In Accordance With

**SAR (Specific Absorption Rate) Requirements  
using guidelines established in IEEE C95.1-1991,  
FCC OET Bulletin 65 (Supplement C),  
Industry Canada RSS-102(Issue 1) and  
ACA Radiocommunications (Electromagnetic Radiation – Human Exposure)  
Amendment Standard 2000 (No. 1)**

UltraTech's File No.: ITS-006-SAR

This Test report is Issued under the Authority of  
Tri M. Luu, Professional Engineer,  
Vice President of Engineering  
UltraTech Group of Labs



Date: June 9, 2003

Report Prepared by: JaeWook Choi

Tested by: JaeWook Choi

Issued Date: June 5, 2003

Test Dates: May 22, 2003

*The results in this Test Report apply only to the sample(s) tested, which has been randomly selected.*

## UltraTech

3000 Bristol Circle, Oakville, Ontario, Canada, L6H 6G4

Telephone (905) 829-1570

Facsimile (905) 829-8050

Website: [www.ultratech-labs.com](http://www.ultratech-labs.com)

Email: [vic@ultratech-labs.com](mailto:vic@ultratech-labs.com)

## TABLE OF CONTENTS

<b>EXHIBIT 1. INTRODUCTION</b> .....	<b>4</b>
1.1. SCOPE .....	4
1.2. REFERENCES.....	4
<b>EXHIBIT 2. PERFORMANCE ASSESSMENT</b> .....	<b>5</b>
2.1. CLIENT AND MANUFACTURER INFORMATION .....	5
2.2. DEVICE UNDER TEST (D.U.T.) DESCRIPTION.....	5
2.3. LIST OF D.U.T.'S ACCESSORIES:.....	6
2.4. SPECIAL CHANGES ON THE D.U.T.'S HARDWARE/SOFTWARE FOR TESTING PURPOSES .....	6
2.5. ANCILLARY EQUIPMENT .....	6
2.6. GENERAL TEST CONFIGURATIONS .....	6
2.6.1. <i>Equipment Configuration</i> .....	6
2.6.2. <i>Exercising Equipment</i> .....	6
2.7. SPECIFIC OPERATING CONDITIONS.....	6
2.8. BLOCK DIAGRAM OF TEST SETUP .....	7
<b>EXHIBIT 3. SUMMARY OF TEST RESULTS</b> .....	<b>8</b>
3.1. LOCATION OF TESTS .....	8
3.2. APPLICABILITY & SUMMARY OF SAR RESULTS.....	8
<b>EXHIBIT 4. MEASUREMENTS, EXAMINATIONS &amp; TEST DATA</b> .....	<b>9</b>
4.1. TEST SETUP .....	9
4.2. PHOTOGRAPH OF D.U.T. AND ALL ACCESORIES.....	10
4.3. PHOTOGRAPHS OF D.U.T. POSITION .....	15
4.3.1. <i>Body-Worn(By stander) Configuration</i> .....	15
4.3.1.1. Top side of the lid of the host PC in contact with the phantom .....	15
4.3.1.2. Front edge of the lid of the host PC in contact with the phantom (prescans).....	16
4.4. MAXIMUM PEAK SPATIAL-AVERAGE SAR.....	17
4.4.1. <i>Maximum Peak Spatial-average SAR Data</i> .....	17
4.4.2. <i>Maximum Peak Spatial-Average SAR Location</i> .....	17
4.5. SAR MEASUREMENT DATA .....	18
4.5.1. <i>Body-Worn (By stander) Configuration Result</i> .....	18
4.5.1.1. Top side of the lid of the host PC in contact with the phantom .....	18
4.5.2. <i>Power Measurement</i> .....	19
4.5.2.1. IEEE802.11g (2.4 GHz) mode.....	19
4.5.2.2. IEEE802.11a (5 GHz) mode .....	19
<b>EXHIBIT 5. SAR SYSTEM CONFIGURATION &amp; TEST METHODOLOGY</b> .....	<b>20</b>
5.1. MEASUREMENT SYSTEM SPECIFICATIONS.....	20
5.2. TEST PROCEDURES .....	20
5.3. PHANTOM .....	20
5.4. SIMULATED TISSUE .....	21
5.4.1. <i>Preparation</i> .....	22
5.5. MEASUREMENT OF ELECTRICAL CHARACTERISTICS OF SIMULATED TISSUE.....	22
5.5.1. <i>Slotted Coaxial Waveguide</i> .....	22
5.5.1.1. Equipment set-up.....	22
5.5.1.2. Measurement procedure.....	23

5.5.2.	<i>HP Dielectric Strength Probe System (open-ended coaxial transmission-line probe/sensor)</i> .....	23
5.5.2.1.	Equipment set-up .....	23
5.5.2.2.	Measurement procedure .....	24
5.6.	SYSTEM CALIBRATION .....	26
5.6.1.	<i>Probe linearity</i> .....	26
5.6.2.	<i>Free Space Calibration</i> .....	26
5.6.2.1.	Method.....	26
5.6.2.2.	Measurement procedure.....	27
5.6.2.3.	Definition of Amplifier Settings .....	28
5.6.3.	<i>Thermal Transfer Calibration</i> .....	29
5.6.3.1.	Measurement procedure.....	29
5.6.3.2.	Determination of Conversion Factor ( $\gamma$ ) in the simulated tissue .....	31
5.6.4.	<i>Data Acquisition Methodology</i> .....	32
5.6.4.1.	E-Field Measurement.....	32
5.6.4.2.	Sensitivity( $\zeta$ ) of probe in the simulated tissue .....	33
5.6.4.3.	SAR Measurement.....	34
5.6.4.4.	Data Extrapolation and boundary effect .....	35
5.6.5.	<i>Determining the Heat Capacity of Simulated Tissue</i> .....	36
5.6.5.1.	Instruments and Materials.....	36
5.6.5.2.	Method.....	36
5.6.5.3.	Rationale.....	37
5.7.	SAR MEASUREMENT SYSTEM VERIFICATION .....	38
5.7.1.	<i>Standard Source</i> .....	38
5.7.2.	<i>Standard Source Input Power Measurement</i> .....	38
5.7.3.	<i>System Validation Procedure</i> .....	39
5.8.	POWER MEASUREMENT .....	40
5.9.	POSITIONING OF D.U.T. ....	41
5.10.	SAR MEASUREMENT UNCERTAINTY .....	43
5.10.1.	<i>Measurement Uncertainty</i> .....	44
5.10.1.1.	Measurement Uncertainty evaluation for handset SAR test .....	44
5.10.1.2.	Measurement Uncertainty for System Performance Check .....	45
<b>EXHIBIT 6.</b>	<b>SAR PRESCANS</b> .....	<b>46</b>
6.1.1.	<i>Body-Worn Configuration</i> .....	46
6.1.1.1.	Test configurations used .....	46
6.1.1.2.	Equipment permutation investigated for each orientation.....	46
6.1.1.3.	Comments on non-tested configurations.....	46
6.2.	RECOMMENDED CAUTION STATEMENTS TO BE INCLUDED IN USERS MANUAL .....	47
6.3.	PRESCAN DATA FOR WORST CONFIGURATION OF RF EXPOSURE.....	48
6.3.1.	<i>Body-Worn (By stander) Configuration</i> .....	48
6.3.1.1.	2.4 GHz.....	48
6.3.1.2.	5.24 GHz.....	48
<b>EXHIBIT 7.</b>	<b>SAR MEASUREMENT</b> .....	<b>50</b>
7.1.	BODY-WORN (BY STANDER) CONFIGURATION .....	50
7.1.1.	<i>Top of the lid of the host PC in contact with the phantom</i> .....	50
7.1.1.1.	2437 MHz.....	51
7.1.1.2.	5260 MHz.....	53
<b>EXHIBIT 8.</b>	<b>TISSUE DIELECTRIC PARAMETER CALIBRATION</b> .....	<b>54</b>
<b>EXHIBIT 9.</b>	<b>SAR SYSTEM CALIBRATION</b> .....	<b>55</b>

**ULTRATECH GROUP OF LABS**

3000 Bristol Circle, Oakville, Ontario, Canada L6H 6G4  
 Tel. #: 905-829-1570, Fax. #: 905-829-8050, Email: vic@ultratech-labs.com, Website: http://www.ultratech-labs.com

**File #: ITS-006-SAR**  
**June 5, 2003**

- Assessed by ITI (UK) Competent Body, NVLAP (USA) Accreditation Body & ACA/AUSTEL (Australia), VCCI (Japan)
- Accredited by Industry Canada (Canada) under ACC-LAB (Europe/Canada MRA and APEC/Canada MRA)
- Recognized/Listed by FCC (USA)
- All test results contained in this engineering test report are traceable to National Institute of Standards and Technology (NIST)

9.1.	GENERAL INFORMATION OF THE PROBE .....	55
9.2.	PROBE LINEARITY AND DYNAMIC RANGE .....	55
9.2.1.	Channel 1 .....	56
9.2.2.	Channel 2 .....	56
9.2.3.	Channel 3 .....	57
9.3.	PROBE FREE SPACE CALIBRATION .....	58
9.3.1.	Calibration Setup .....	58
9.3.1.1.	2.45 GHz .....	58
9.3.1.2.	5.24 GHz .....	58
9.3.2.	Amplifier Settings .....	58
9.3.2.1.	2.45 GHz .....	58
9.3.2.2.	5.24 GHz .....	58
9.3.3.	Isotropic response .....	60
9.4.	PROBE THERMAL TRANSFER CALIBRATION .....	61
9.4.1.	2.45 GHz .....	61
9.4.1.1.	Calibration Setup .....	61
9.4.1.2.	Simulated Tissue .....	61
9.4.1.3.	Conversion Factor for brain tissue .....	62
9.4.1.4.	Conversion Factor for muscle tissue .....	63
9.4.2.	5.24 GHz .....	64
9.4.2.1.	Calibration Setup .....	64
9.4.2.2.	Simulated Tissue .....	64
9.4.2.3.	Conversion Factor .....	65
<b>EXHIBIT 10.</b>	<b>SAR SYSTEM VERIFICATION USING DIPOLE REFERENCE .....</b>	<b>66</b>
10.1.	2.45 GHz .....	66
10.1.1.	Verification Setup .....	66
10.1.2.	Simulated Tissue .....	66
10.1.2.1.	BRAIN TISSUE .....	66
10.1.3.	Verification Result .....	67
10.1.3.1.	Reference SAR values .....	67
10.1.3.2.	Brain tissue .....	67
10.2.	5.24 GHz .....	69
10.2.1.	Verification Setup .....	69
10.2.2.	Simulated Tissue .....	69
10.2.3.	Verification Result .....	70
<b>EXHIBIT 11.</b>	<b>MANUFACTURER’S DECLARATION ANTENNA ASSEMBLIES .....</b>	<b>72</b>
<b>EXHIBIT 12.</b>	<b>SAR CALCULATION SUMMARY .....</b>	<b>74</b>
12.1.	TERMINOLOGY .....	74
12.1.1.	Sensor factor ( $\eta_{pd}$ and $\eta_{Ez}$ ) in the air ( $Z_0 = 377[\Omega]$ ) .....	74
12.1.2.	Amplifier settings ( $AS_i$ ) and probe output .....	74
12.1.3.	Conversion factor ( $\gamma$ ) in the simulated tissue .....	75
12.1.4.	Conversion factor ( $\gamma$ ) Calculation .....	75
12.1.5.	Sensitivity ( $\zeta$ ) in the simulated tissue .....	75
12.1.6.	SAR calculation .....	75

**ULTRATECH GROUP OF LABS**

3000 Bristol Circle, Oakville, Ontario, Canada L6H 6G4  
 Tel. #: 905-829-1570, Fax. #: 905-829-8050, Email: vic@ultratech-labs.com, Website: http://www.ultratech-labs.com

**File #: ITS-006-SAR**  
**June 5, 2003**

- Assessed by ITI (UK) Competent Body, NVLAP (USA) Accreditation Body & ACA/AUSTEL (Australia), VCCI (Japan)
- Accredited by Industry Canada (Canada) under ACC-LAB (Europe/Canada MRA and APEC/Canada MRA)
- Recognized/Listed by FCC (USA)
- All test results contained in this engineering test report are traceable to National Institute of Standards and Technology (NIST)

# EXHIBIT 1. INTRODUCTION

## 1.1. SCOPE

Reference:	SAR (Specific Absorption Rate) Requirements IEEE C95.1-1991, FCC OET Bulletin 65 (Supplement C) Industry Canada RSS-102 (Issue 1). ACA Radiocommunications (Electromagnetic Radiation – Human Exposure), Amendment Standard 2000 (No. 1)
Title	Safety Levels with respect to human exposure to Radio Frequency Electromagnetic Fields Guideline for Evaluating the Environmental Effects of Radio Frequency Radiation
Purpose of Test:	To verify compliance with Federal regulated SAR requirements in Canada, Australia and the US.
Method of Measurements:	IEEE C95.1-1991, FCC OET Bulletin 65 (Supplement C) and Industry Canada RSS-102 (Issue 1)
Exposure Category	General Population/Uncontrolled

## 1.2. REFERENCES

The methods and procedures used for the measurements contained in this report are details in the following reference standards:

Publications	Year	Title
IEEE Std. 1528-2001 Draft	2001	Draft Recommended practice for determining the Peak Spatial-Average Specific Absorption rate (SAR) in the Human Body Due to Wireless Communications Devices: Experimental Techniques.
Industry Canada RSS102	1999	"Evaluation Procedure for Mobile and Portable Radio Transmitters with respect to Health Canada's Safety Code 6 for Exposure of Humans to Radio Frequency Fields"
ACA	2000	ACA Radiocommunications (Electromagnetic Radiation – Human Exposure) Amendment Standard 2000 (No. 1)
NCRP Report No.86	1986	"Biological Effects and Exposure Criteria for radio Frequency Electromagnetic Fields"
FCC OET Bulletin 65	1997	"Evaluating Compliance with FCC Guidelines for Human Exposure to radio Frequency Fields"
ANSI/IEEE C95.3	1992	"Recommended Practice for the Measurement of Potentially Hazardous Electromagnetic Fields - RF and Microwave"
ANSI/IEEE C95.1	1992	"Safety Levels with Respect to Human Exposure to Radio Frequency Electromagnetic Fields, 3kHz to 300GHz"
AS/NZS 2722.1	1998	Interim Australian/New Zealand Standard. "Radiofrequency fields, Part 1:Maximum exposure levels – 3kHz to 300GHz "

- Assessed by ITI (UK) Competent Body, NVLAP (USA) Accreditation Body & ACA/AUSTEL (Australia), VCCI (Japan)
- Accredited by Industry Canada (Canada) under ACC-LAB (Europe/Canada MRA and APEC/Canada MRA)
- Recognized/Listed by FCC (USA)
- All test results contained in this engineering test report are traceable to National Institute of Standards and Technology (NIST)

## EXHIBIT 2. PERFORMANCE ASSESSMENT

### 2.1. CLIENT AND MANUFACTURER INFORMATION

<b>APPLICANT:</b>	
<b>Name:</b>	Intersil Corporation
<b>Address:</b>	Rembrandtlaan 1a 3723 BG Bilthoven P.O. Box 343 3720 AH Bilthoven The Netherlands
<b>Contact Person:</b>	Mr. Derick Sariredjo Phone #: +1-905-812-6200 Fax #: +1-905-812-6301 Email Address: <a href="mailto:derick.sariredjo@intersil.com">derick.sariredjo@intersil.com</a>

<b>MANUFACTURER:</b>	
<b>Name:</b>	Intersil Corporation
<b>Address:</b>	Rembrandtlaan 1a 3723 BG Bilthoven P.O. Box 343 3720 AH Bilthoven The Netherlands
<b>Contact Person:</b>	Mr. Derick Sariredjo Phone #: +1-905-812-6200 Fax #: +1-905-812-6301 Email Address: <a href="mailto:derick.sariredjo@intersil.com">derick.sariredjo@intersil.com</a>

### 2.2. DEVICE UNDER TEST (D.U.T.) DESCRIPTION

The following is the information provided by the applicant.

<b>Trade Name</b>	PRISM Duette
<b>Type/Model Number</b>	ISL39000M
<b>Type of Equipment</b>	Wireless LAN Card
<b>Frequency of Operation</b>	2412 MHz ~ 2462MHz, 5180 MHz ~ 5320 MHz
<b>Rated RF Power</b>	21.3 dBm <sub>pk</sub> conducted at 2.4 GHz 17.6 dBm <sub>pk</sub> conducted at 5 GHz
<b>Modulation Employed</b>	DSSS at 2.4 GHz OFDM at 5 GHz
<b>Antenna Type + Gain</b>	KOSAN Dual band WLAN antenna (Manufacturer: KOSAN, M/N: KBWI-CO-04)*
<b>Power Supply</b>	Power supplied through the laptop computer
<b>Primary User Functions of D.U.T.:</b>	Data radio communication through air

\* Refer to EXHIBIT 11. manufacturer’s declaration antenna assembly / configuration statement

- Assessed by ITI (UK) Competent Body, NVLAP (USA) Accreditation Body & ACA/AUSTEL (Australia), VCCI (Japan)
- Accredited by Industry Canada (Canada) under ACC-LAB (Europe/Canada MRA and APEC/Canada MRA)
- Recognized/Listed by FCC (USA)
- All test results contained in this engineering test report are traceable to National Institute of Standards and Technology (NIST)

**2.3. LIST OF D.U.T.'S ACCESSORIES:**

N/A

**2.4. SPECIAL CHANGES ON THE D.U.T.'S HARDWARE/SOFTWARE FOR TESTING PURPOSES**

N/A

**2.5. ANCILLARY EQUIPMENT**

Laptop computer (Toshiba Satellite Pro, M/N: SP6100, S/N: 52324105G), Hirose UFL to SMA adapter.

**2.6. GENERAL TEST CONFIGURATIONS****2.6.1. Equipment Configuration**

Power and signal distribution, grounding, interconnecting cabling and physical placement of equipment of a test system shall simulate the typical application and usage in so far as is practicable, and shall be in accordance with the relevant product specifications of the manufacturer.

The configuration that tends to maximize the D.U.T.'s emission or minimize its immunity is not usually intuitively obvious and in most instances selection will involve some trial and error testing. For example, interface cables may be moved or equipment re-orientated during initial stages of testing and the effects on the results observed.

Only configurations within the range of positions likely to occur in normal use need to be considered.

The configuration selected shall be fully detailed and documented in the test report, together with the justification for selecting that particular configuration.

**2.6.2. Exercising Equipment**

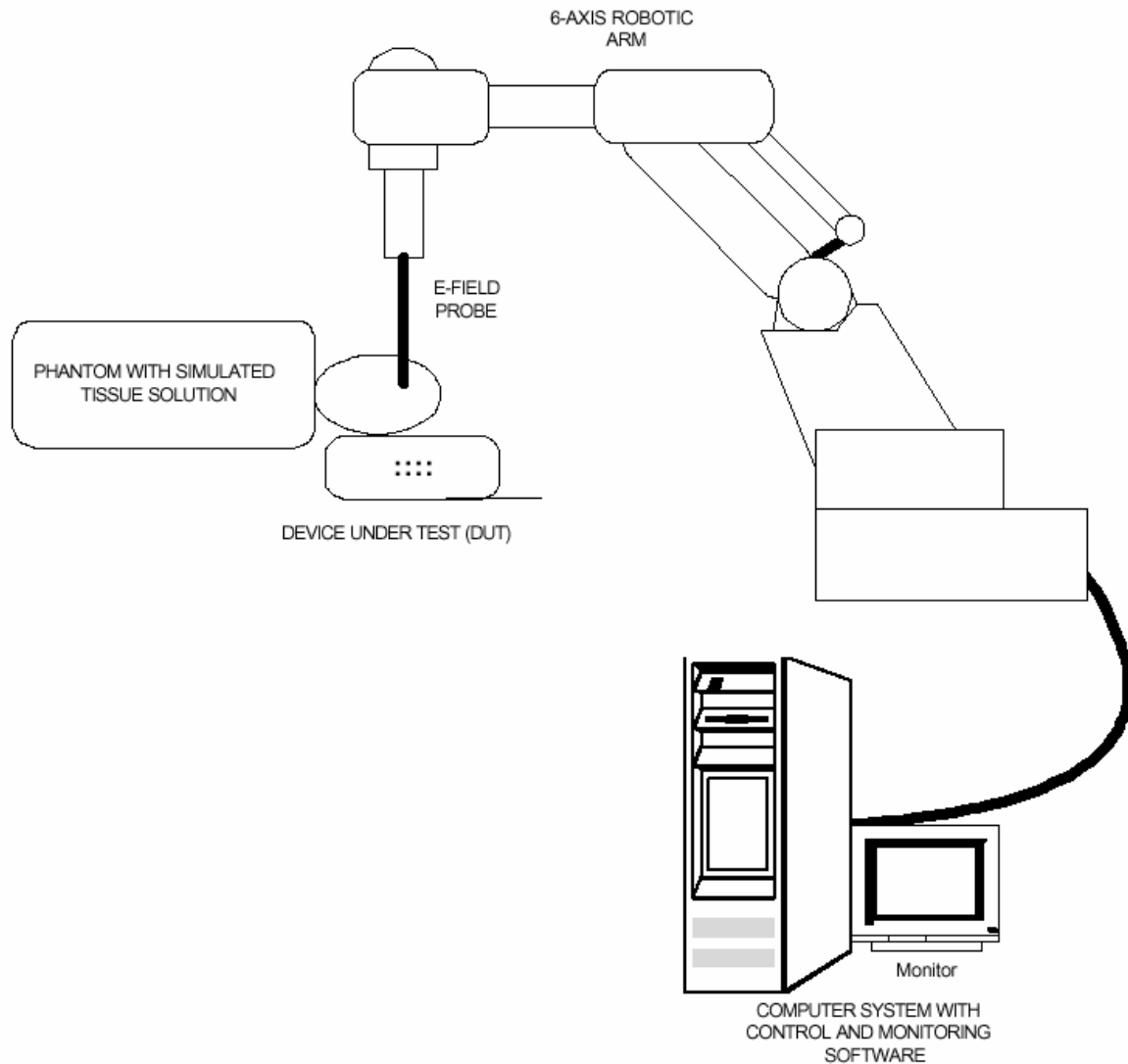
The exercising equipment and other auxiliary equipment shall be sufficiently decoupled from the D.U.T. so that the performance of such equipment does not significantly influence the test results.

**2.7. SPECIFIC OPERATING CONDITIONS**

D.U.T. was mad to transmit with 100 % duty cycle, in other words continuously, instead of its actual duty cycle, using the exclusive controlling software for SAR test provided by the manufacturer.

## 2.8. BLOCK DIAGRAM OF TEST SETUP

The D.U.T. was configured as normal intended use. The following block diagram shows a representative equipment arrangement during tests:



### ULTRATECH GROUP OF LABS

3000 Bristol Circle, Oakville, Ontario, Canada L6H 6G4  
Tel. #: 905-829-1570, Fax. #: 905-829-8050, Email: vic@ultratech-labs.com, Website: http://www.ultratech-labs.com

File #: ITS-006-SAR  
June 5, 2003

- Assessed by ITI (UK) Competent Body, NVLAP (USA) Accreditation Body & ACA/AUSTEL (Australia), VCCI (Japan)
- Accredited by Industry Canada (Canada) under ACC-LAB (Europe/Canada MRA and APEC/Canada MRA)
- Recognized/Listed by FCC (USA)
- All test results contained in this engineering test report are traceable to National Institute of Standards and Technology (NIST)



## EXHIBIT 3. SUMMARY OF TEST RESULTS

### 3.1. LOCATION OF TESTS

All of the measurements described in this report were performed at UltraTech Group of Labs located at:

3000 Bristol Circle, in the city of Oakville, Province of Ontario, Canada.

All measurements were performed in UltraTech’s shielded chamber, 24’ x 16’ x 8’.

### 3.2. APPLICABILITY & SUMMARY OF SAR RESULTS

The maximum peak spatial - average SAR measured was found to be 0.02 W/Kg.

Exposure Category and SAR Limits	Test Requirements	Compliance (Yes/No)
<p><b>General population/Uncontrolled exposure</b>                      0.08W/kg whole body average and <b>spatial peak SAR of 1.6W/kg</b>, averaged over 1gram of tissue                      Hands, wrist, feet and ankles have a peak SAR not to exceed 4 W/kg, averaged over 10 grams of tissue.</p>	<p>Requirements using guidelines established in IEEE C95.1-1991                      FCC OET Bulletin 65 (Supplement C)                      Industry Canada RSS-102 (Issue 1).                      ACA Radiocommunications (Electromagnetic Radiation – Human Exposure) Amendment Standard 2000 (No. 1)</p>	<p>YES</p>
<p><b>Occupational/Controlled Exposure</b>                      0.4W/kg whole body average and <b>spatial peak SAR of 8W/kg</b>, averaged over 1gram of tissue                      Hands, wrist, feet and ankles have a peak SAR not to exceed 20 W/kg, averaged over 10 grams of tissue.</p>	<p>Requirements using guidelines established in IEEE C95.1-1991                      FCC OET Bulletin 65 (Supplement C),                      Industry Canada RSS-102 (Issue 1)                      ACA Radiocommunications (Electromagnetic Radiation – Human Exposure) Amendment Standard 2000 (No. 1)</p>	<p>N/A</p>

### ULTRATECH GROUP OF LABS

3000 Bristol Circle, Oakville, Ontario, Canada L6H 6G4  
 Tel. #: 905-829-1570, Fax. #: 905-829-8050, Email: vic@ultratech-labs.com, Website: http://www.ultratech-labs.com

**File #: ITS-006-SAR**  
**June 5, 2003**

- Assessed by ITI (UK) Competent Body, NVLAP (USA) Accreditation Body & ACA/AUSTEL (Australia), VCCI (Japan)
- Accredited by Industry Canada (Canada) under ACC-LAB (Europe/Canada MRA and APEC/Canada MRA)
- Recognized/Listed by FCC (USA)
- All test results contained in this engineering test report are traceable to National Institute of Standards and Technology (NIST)

## EXHIBIT 4. MEASUREMENTS, EXAMINATIONS & TEST DATA

### 4.1. TEST SETUP

D.U.T. Information		Condition	
Product Name	Wireless LAN Card	Robot Type	6 Axis
Model Number	ISL39000M	Scan Type	SAR – Area/Zoom/Att Vs Depth
Serial Number	B014	Measured Field	E
Frequency Band [MHz]	2412 ~ 2462 5180 ~ 5320	Phantom Type	2 <sub>mm</sub> base Flat Phantom
Frequency Tested [MHz]	2437, 5260	Phantom Position	Waist
Rated RF Output Power [dBm]	21.3 peak conducted @ 2.4 GHz 17.6 peak conducted @ 5 GHz	Room Temperature [°C]	22 ± 1
Antenna Type	Dual band WLAN antenna	Room Humidity [%]	30 ± 10
Modulation	DSSS @ 2.4 GHz OFDM @ 5 GHz	Tissue Temperature [°C]	22 ± 1
Duty Cycle	100 %*		

Type of Tissue	Muscle	Muscle
Test Frequency [MHz]	2450	5240
Measured Dielectric Constant	54.6 (+3.6 %)	47.3 (-2.5 %)
Measured Conductivity [S/m]	1.95 (+0.0 %)	5.56 (+3.0 %)
Penetration Depth (Plane Wave Excitation) [mm]	20.3	6.7
Probe Model Number	E-TR	E-TR
Probe Serial Number	UT-0200-1	UT-0200-1
Probe Orientation	Isotropic	Isotropic
Probe Offset [mm]	2.00	2.00
Probe Tip Diameter [mm]	4.00	4.00
Sensor Factor ( $\eta_{pd}$ ) [mV/(mW/cm <sup>2</sup> )]	10.8	10.8
Conversion Factor ( $\gamma$ )	4.028	2.721
Sensitivity ( $\zeta$ ) [W/Kg/mV]	1.690E-01	7.133E-01

\* Refer to 2.7

### ULTRATECH GROUP OF LABS

3000 Bristol Circle, Oakville, Ontario, Canada L6H 6G4  
 Tel. #: 905-829-1570, Fax. #: 905-829-8050, Email: vic@ultratech-labs.com, Website: http://www.ultratech-labs.com

**File #: ITS-006-SAR**  
**June 5, 2003**

- Assessed by ITI (UK) Competent Body, NVLAP (USA) Accreditation Body & ACA/AUSTEL (Australia), VCCI (Japan)
- Accredited by Industry Canada (Canada) under ACC-LAB (Europe/Canada MRA and APEC/Canada MRA)
- Recognized/Listed by FCC (USA)
- All test results contained in this engineering test report are traceable to National Institute of Standards and Technology (NIST)

## 4.2. PHOTOGRAPH OF D.U.T. AND ALL ACCESORIES



< D.U.T. installed in the miniPCI slot >

---

### ULTRATECH GROUP OF LABS

3000 Bristol Circle, Oakville, Ontario, Canada L6H 6G4  
Tel. #: 905-829-1570, Fax. #: 905-829-8050, Email: vic@ultratech-labs.com, Website: <http://www.ultratech-labs.com>

**File #: ITS-006-SAR**  
**June 5, 2003**

- Assessed by ITI (UK) Competent Body, NVLAP (USA) Accreditation Body & ACA/AUSTEL (Australia), VCCI (Japan)
- Accredited by Industry Canada (Canada) under ACC-LAB (Europe/Canada MRA and APEC/Canada MRA)
- Recognized/Listed by FCC (USA )
- *All test results contained in this engineering test report are traceable to National Institute of Standards and Technology (NIST)*



< D.U.T. installed in the miniPCI slot – Close-up view >

---

**ULTRATECH GROUP OF LABS**

3000 Bristol Circle, Oakville, Ontario, Canada L6H 6G4  
Tel. #: 905-829-1570, Fax. #: 905-829-8050, Email: vic@ultratech-labs.com, Website: <http://www.ultratech-labs.com>

**File #: ITS-006-SAR**  
**June 5, 2003**

- Assessed by ITI (UK) Competent Body, NVLAP (USA) Accreditation Body & ACA/AUSTEL (Australia), VCCI (Japan)
- Accredited by Industry Canada (Canada) under ACC-LAB (Europe/Canada MRA and APEC/Canada MRA)
- Recognized/Listed by FCC (USA )
- All test results contained in this engineering test report are traceable to National Institute of Standards and Technology (NIST)



< Host laptop PC and antenna location >

**ULTRATECH GROUP OF LABS**

3000 Bristol Circle, Oakville, Ontario, Canada L6H 6G4  
Tel. #: 905-829-1570, Fax. #: 905-829-8050, Email: vic@ultratech-labs.com, Website: http://www.ultratech-labs.com

**File #: ITS-006-SAR**  
**June 5, 2003**

- Assessed by ITI (UK) Competent Body, NVLAP (USA) Accreditation Body & ACA/AUSTEL (Australia), VCCI (Japan)
- Accredited by Industry Canada (Canada) under ACC-LAB (Europe/Canada MRA and APEC/Canada MRA)
- Recognized/Listed by FCC (USA)
- All test results contained in this engineering test report are traceable to National Institute of Standards and Technology (NIST)

**SPECIFIC ABSORPTION RATE (SAR)**

IEEE C95.1-1991, FCC OET Bulletin 65 (Supplement C), Industry Canada RSS-102(Issue 1) and ACA Radiocommunications (Electromagnetic Radiation – Human Exposure) Amendment Standard 2000 (No. 1)

**Wireless LAN Card M/N: ISL3900M**



**< 2.4 GHz\* and 5 GHz WLAN antenna assemblies >**

\* Refer to EXHIBIT 11. manufacturer’s declaration antenna assembly / configuration statement

**ULTRATECH GROUP OF LABS**

3000 Bristol Circle, Oakville, Ontario, Canada L6H 6G4  
Tel. #: 905-829-1570, Fax. #: 905-829-8050, Email: vic@ultratech-labs.com, Website: http://www.ultratech-labs.com

**File #: ITS-006-SAR**  
**June 5, 2003**

- Assessed by ITI (UK) Competent Body, NVLAP (USA) Accreditation Body & ACA/AUSTEL (Australia), VCCI (Japan)
- Accredited by Industry Canada (Canada) under ACC-LAB (Europe/Canada MRA and APEC/Canada MRA)
- Recognized/Listed by FCC (USA )
- All test results contained in this engineering test report are traceable to National Institute of Standards and Technology (NIST)

**SPECIFIC ABSORPTION RATE (SAR)**

IEEE C95.1-1991, FCC OET Bulletin 65 (Supplement C), Industry Canada RSS-102(Issue 1) and ACA Radiocommunications (Electromagnetic Radiation – Human Exposure) Amendment Standard 2000 (No. 1)

**Wireless LAN Card M/N: ISL39000M**

---



< 2.4 GHz / 5 GHz Dual band KOSAN WLAN antenna (M/N: KBWI-CO-04) >

---

**ULTRATECH GROUP OF LABS**

3000 Bristol Circle, Oakville, Ontario, Canada L6H 6G4  
Tel. #: 905-829-1570, Fax. #: 905-829-8050, Email: vic@ultratech-labs.com, Website: <http://www.ultratech-labs.com>

**File #: ITS-006-SAR**  
**June 5, 2003**

- Assessed by ITI (UK) Competent Body, NVLAP (USA) Accreditation Body & ACA/AUSTEL (Australia), VCCI (Japan)
- Accredited by Industry Canada (Canada) under ACC-LAB (Europe/Canada MRA and APEC/Canada MRA)
- Recognized/Listed by FCC (USA)
- All test results contained in this engineering test report are traceable to National Institute of Standards and Technology (NIST)

### **4.3. PHOTOGRAPHS OF D.U.T. POSITION**

#### **4.3.1. Body-Worn(By stander) Configuration**

##### **4.3.1.1. Top side of the lid of the host PC in contact with the phantom**



---

### **ULTRATECH GROUP OF LABS**

3000 Bristol Circle, Oakville, Ontario, Canada L6H 6G4  
Tel. #: 905-829-1570, Fax. #: 905-829-8050, Email: vic@ultratech-labs.com, Website: <http://www.ultratech-labs.com>

**File #: ITS-006-SAR**  
**June 5, 2003**

- Assessed by ITI (UK) Competent Body, NVLAP (USA) Accreditation Body & ACA/AUSTEL (Australia), VCCI (Japan)
- Accredited by Industry Canada (Canada) under ACC-LAB (Europe/Canada MRA and APEC/Canada MRA)
- Recognized/Listed by FCC (USA)
- All test results contained in this engineering test report are traceable to National Institute of Standards and Technology (NIST)



**4.3.1.2. Front edge of the lid of the host PC in contact with the phantom (prescans)**



**ULTRATECH GROUP OF LABS**

3000 Bristol Circle, Oakville, Ontario, Canada L6H 6G4  
Tel. #: 905-829-1570, Fax. #: 905-829-8050, Email: vic@ultratech-labs.com, Website: http://www.ultratech-labs.com

**File #: ITS-006-SAR**  
**June 5, 2003**

- Assessed by ITI (UK) Competent Body, NVLAP (USA) Accreditation Body & ACA/AUSTEL (Australia), VCCI (Japan)
- Accredited by Industry Canada (Canada) under ACC-LAB (Europe/Canada MRA and APEC/Canada MRA)
- Recognized/Listed by FCC (USA)
- All test results contained in this engineering test report are traceable to National Institute of Standards and Technology (NIST)

**4.4. MAXIMUM PEAK SPATIAL-AVERAGE SAR**

**4.4.1. Maximum Peak Spatial-average SAR Data**

#	Configuration	Device Test Positions	Antenna Position	Freq. [MHz]	Channel	MAX. 1g SAR [W/Kg]
02	2.4 GHz DSSS 54 Mbps data rate 21.3 [dBm] conducted Top side of the lid of the host PC in contact with the phantom 0 mm separation	Body-Worn (By stander)	Integrated	2437	06	0.02

**4.4.2. Maximum Peak Spatial-Average SAR Location**

Complete area prescan was conducted to determine the location of the highest SAR and the device was repositioned to allow the identified hot-spots to be orientated with as large an area around the hot-spots to come into contact with the phantom surface. This procedure ensured that the maximum SAR readings would be obtained from the hot-spot areas identified.



- Assessed by ITI (UK) Competent Body, NVLAP (USA) Accreditation Body & ACA/AUSTEL (Australia), VCCI (Japan)
- Accredited by Industry Canada (Canada) under ACC-LAB (Europe/Canada MRA and APEC/Canada MRA)
- Recognized/Listed by FCC (USA)
- All test results contained in this engineering test report are traceable to National Institute of Standards and Technology (NIST)

**4.5. SAR MEASUREMENT DATA**

**4.5.1. Body-Worn (By stander) Configuration Result\***

**4.5.1.1. Top side of the lid of the host PC in contact with the phantom**

#	Configuration	Device Test Positions	Antenna Position	Freq. [MHz]	Channel	Ref. SAR Before [W/Kg]	Ref. SAR After [W/Kg]	MAX 1g SAR [W/Kg]
01	2.4 GHz DSSS 54 Mbps data rate 21.3 [dBm] conducted Top side of the lid of the host PC in contact with the phantom 0 mm separation	0 mm	Integrated	2412	01			
02		0 mm	Integrated	2437	06	0.01	0.01 (-0.0 %)	0.02
03		0 mm	Integrated	2462	11			
04	5 GHz OFDM 36 Mbps data rate 17.5 [dBm] conducted Top side of the lid of the host PC in contact with the phantom 0 mm separation	0 mm	Integrated	5180	36			
05		0 mm	Integrated	5260	52	0.00	0.00 (-0.0 %)	Less than 0.01**
06		0 mm	Integrated	5320	64			

\* If the SAR measured at the middle channel for each test configuration is at least 3.0 dB lower than the SAR limit, testing at the high and low channels is optional for such test configuration(s).

\*\* It was found to be below the SAR measurement system’s sensitivity (less than 0.01 [W/Kg]).

- Assessed by ITI (UK) Competent Body, NVLAP (USA) Accreditation Body & ACA/AUSTEL (Australia), VCCI (Japan)
- Accredited by Industry Canada (Canada) under ACC-LAB (Europe/Canada MRA and APEC/Canada MRA)
- Recognized/Listed by FCC (USA)
- All test results contained in this engineering test report are traceable to National Institute of Standards and Technology (NIST)

**4.5.2. Power Measurement**

**4.5.2.1. IEEE802.11g (2.4 GHz) mode**

Bit rate [Mbps]	Measured Power [dBm] conducted		
	CH 01, 2412 MHz	CH 06, 2437 MHz	CH11, 2462 MHz
1	18.8	18.1	17.9
2	18.8	18.3	17.9
5.5	18.4	17.8	17.6
11	18.5	18.1	17.9
9	20.2	20.3	19.3
18	20.8	20.5	19.7
36	21.2	20.9	19.2
54	21.3	21.3	20.3

**4.5.2.2. IEEE802.11a (5 GHz) mode**

Bit rate [Mbps]	Measured Power [dBm] conducted			
	CH36, 5180 MHz	CH48, 5240 MHz	CH52, 5260 MHz	CH64, 5320 MHz
9	16.7	16.7	17.5	17.6
18	16.8	16.8	17.1	17.2
36	16.9	16.8	17.5	17.5
54	16.5	16.3	16.3	16.2

**ULTRATECH GROUP OF LABS**

3000 Bristol Circle, Oakville, Ontario, Canada L6H 6G4  
 Tel. #: 905-829-1570, Fax. #: 905-829-8050, Email: vic@ultratech-labs.com, Website: http://www.ultratech-labs.com

**File #: ITS-006-SAR**  
**June 5, 2003**

- Assessed by ITI (UK) Competent Body, NVLAP (USA) Accreditation Body & ACA/AUSTEL (Australia), VCCI (Japan)
- Accredited by Industry Canada (Canada) under ACC-LAB (Europe/Canada MRA and APEC/Canada MRA)
- Recognized/Listed by FCC (USA)
- All test results contained in this engineering test report are traceable to National Institute of Standards and Technology (NIST)

## **EXHIBIT 5. SAR SYSTEM CONFIGURATION & TEST METHODOLOGY**

### **5.1. MEASUREMENT SYSTEM SPECIFICATIONS**

<b>Positioning Equipment</b>	<b>Probe</b>
Type : 3D Near Field Scanner	Sensor : E-Field
Location Repeatability : 0.1 [mm]	Spatial Resolution : 1 [mm <sup>3</sup> ]
Speed 180 [°/sec]	Isotropic Response : ±0.25 [dB]
AC motors	Dynamic Range : 0.01 to 100 [W/Kg]
<b>Computer</b>	<b>Phantom</b>
Type : Pentium III 500MHz	Tissue : Simulated Tissue with electrical characteristics similar to those of the human at normal body temperature.
Memory : 256 MB RAM	Left/Right Head: IEEE P1528 Compliant SAM manufactured by Aprel
Operating System : Windows 2000 Pro	Body/Frontal Head: IEEE Flat Phantom 2 [mm] Base
Monitor : 19" SVGA	

### **5.2. TEST PROCEDURES**

In the SAR measurement, the positioning of the probes must be performed with sufficient accuracy to obtain repeatable measurements in the presence of rapid spatial attenuation phenomena. The accurate positioning of the E-field probe is accomplished by using a high precision robot. The robot can be taught to position the probe sensor following a specific pattern of points. In a first sweep, the sensor is positioned as close as possible to the interface, with the sensor enclosure touching the inside of the phantom shell. The SAR is measured on a grid of points, which covers the curved surface of the phantom in an area larger than the size of the D.U.T. After the initial scan, a high-resolution volume grid is used to locate the absolute maximum measured energy point and to calculate the peak spatial-average SAR. At this location, attenuation versus depth scan will be accomplished by the measurement system in order to verify the peak spatial-average SAR measured.

### **5.3. PHANTOM**

For Head mounted devices placed next to the ear, the phantom used in the evaluation of the RF exposure of the user of the wireless device is a IEEE P1528 compliant SAM phantom, shaped like a human head and filled with a mixture simulating the dielectric characteristics of the brain. A left sided head and a right sided head are evaluated to determine the worst case orientation for SAR. For body mounted and frontal held push-to-talk devices, a flat phantom of dimensions 70x42x20cm with a base plate thickness of 2mm is used.

- Assessed by ITI (UK) Competent Body, NVLAP (USA) Accreditation Body & ACA/AUSTEL (Australia), VCCI (Japan)
- Accredited by Industry Canada (Canada) under ACC-LAB (Europe/Canada MRA and APEC/Canada MRA)
- Recognized/Listed by FCC (USA)
- All test results contained in this engineering test report are traceable to National Institute of Standards and Technology (NIST)

**5.4. SIMULATED TISSUE**

Simulated Tissue: Suggested in a paper by George Hartsgrove and colleagues in University of Ottawa Ref.: Bioelectromagnetics 8:29-36 (1987)

<b>Ingredient</b>	<b>Quantity</b>
Water	40.4 %
Sugar	56.0 %
Salt	2.5 %
HEC	1.0 %
Bactericide	0.1 %

**Table 5.4. Example of composition of simulated tissue**

This simulated tissue is mainly composed of water, sugar and salt. At higher frequencies, in order to achieve the proper conductivity, the solution does not contain salt. Also, at these frequencies, D.I. water and alcohol is preferred.

Target Frequency (MHz)	Head		Body	
	$\epsilon_r$	$\sigma$ (S/m)	$\epsilon_r$	$\sigma$ (S/m)
150	52.3	0.76	61.9	0.80
300	45.3	0.87	58.2	0.92
450	43.5	0.87	56.7	0.94
835	41.5	0.90	55.2	0.97
900	41.5	0.97	55.0	1.05
915	41.5	0.98	55.0	1.06
1450	40.5	1.20	54.0	1.30
1610	40.3	1.29	53.8	1.40
1800 – 2000	40.0	1.40	53.3	1.52
2450	39.2	1.80	52.7	1.95
3000	310.93	2.40	52.0	2.73
5800	35.3	5.27	48.2	6.00

( $\epsilon_r$  = relative permittivity,  $\sigma$  = conductivity and  $\rho = 1000 \text{ Kg/m}^3$ \*)

\* The actual mass density of the equivalent tissue vary based on the composition of the tissue from 990 Kg/m<sup>3</sup> to 1,300 Kg/m<sup>3</sup>.

- Assessed by ITI (UK) Competent Body, NVLAP (USA) Accreditation Body & ACA/AUSTEL (Australia), VCCI (Japan)
- Accredited by Industry Canada (Canada) under ACC-LAB (Europe/Canada MRA and APEC/Canada MRA)
- Recognized/Listed by FCC (USA)
- All test results contained in this engineering test report are traceable to National Institute of Standards and Technology (NIST)

**5.4.1. Preparation**

The weight requirements is determined and measured carefully for all the components. A clean container is used where the ingredients will be mixed. A stirring paddle mounted to a drill press is used to stir the mixture. First the heat is applied to the DI water to approximately 40 °C to help the ingredients dissolve well and then the salt and the bactericide are added. It is stirred until all the ingredients are completely dissolved. It is continuously stirred slowly while adding the sugar. Rotation of stirring paddle at a high RPM is avoided to prevent air bubbles in the mixture. Later on, the HEC is added to maintain the solution homogeneous. Mixing time is approximately 2 hours.

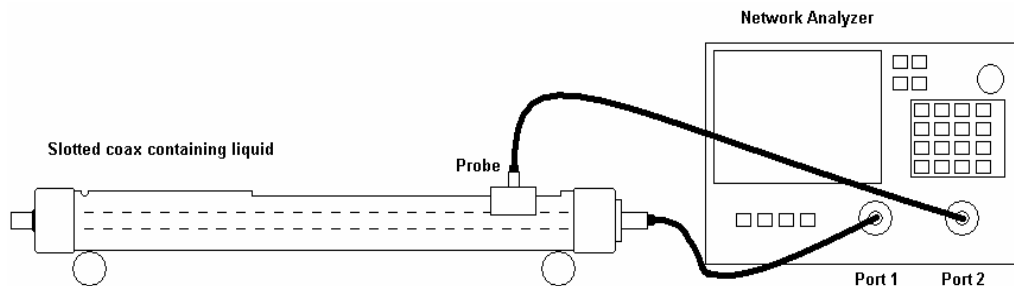
**5.5. MEASUREMENT OF ELECTRICAL CHARACTERISTICS OF SIMULATED TISSUE**

- 1) Slotted Coaxial Waveguide
- 2) HP Dielectric Strength Probe System

**5.5.1. Slotted Coaxial Waveguide**

**5.5.1.1. Equipment set-up**

The test equipment consists of a slotted coaxial transmission line with a probe connected to a vector network analyzer, as shown in Figure 4.5.1.1. The log-magnitude and phase of  $S_{21}$  should be displayed simultaneously. Source power should be set to a level high enough to provide good signal-to-noise ratio. Periodically (annually or whenever the measuring scale along the line length is changed) a measurement is made on a reference liquid to validate the system. Since the measured quantities are magnitude and phase changes versus distance, the accuracy of the scale is very critical.



**Figure 5.5.1.1. Slotted line set-up**

The network analyzer injects a signal into one end of the slotted coaxial transmission line. The probe inserted through the slot into the tissue-equivalent material detects the RF amplitude and phase for each measurement position along the length of the line. A full two-port calibration of the network analyzer should be carried out prior to connecting the sample holder, and the following precautions should be observed:

- a) Fill the slotted line carefully to avoid trapping air bubbles. This operation should be performed while the slotted line is horizontal.

- b) The probe should be inserted into the slot at the end nearest to the input connector of the slotted line, ensuring that the tissue-equivalent liquid is flush with the inside surface of the line, and aligned with a well-defined position on the distance scale of the slotted line.
- c) The probe should be inserted perpendicular to the slotted-line longitudinal axis until a stable and adequate amplitude response is achieved. Do not insert the probe too deeply into the coaxial line, because it can overly perturb the field distribution.

**5.5.1.2. Measurement procedure.**

- a) Configure and calibrate the network analyzer.
- b) Measure 10 to 20 log-magnitude and phase data points along the slotted line corresponding to about a 30 dB change in magnitude.
- c) Plot  $S_{21}$  log-magnitude and phase vs. measurement distance.
- d) Determine if the graphed points closely follow a straight-line approximation, based on the correlation coefficient or a similar statistical measure. The data should produce a good linear curve fit (expected correlation coefficient  $r^2 > 0.99$  for lossy materials). If not, re-measure the liquid by increasing the sample points to extend the magnitude change from 30 to 40 dB. Note: for low loss materials, ensure that the slotted line is long enough to avoid reflections from the load-terminated end.
- e) Calculate the conductivity and relative permittivity of the tissue-equivalent material using Equations (5.5.1.2.) derived from

$$\begin{aligned} \bar{\alpha} &= \frac{m_m \ln(10)}{20} && \text{Np/cm} \\ \bar{\beta} &= \frac{m_p \pi}{180} && \text{rad/cm} \\ \epsilon'_r &= \frac{(\bar{\beta})^2 - (\bar{\alpha})^2}{\omega^2 \mu_0 \epsilon_0} && (5.5.1.2.) \\ \sigma &= \frac{2\bar{\alpha}\bar{\beta}}{\omega\epsilon_0} \left( \frac{100 \text{ cm}}{\text{m}} \right) && \text{S/m} \end{aligned}$$

where,  $m_m$  and  $m_p$  are the slopes of the least-squares linear fits of the log-magnitude and phase plots, respectively, and  $\bar{\alpha}$  and  $\bar{\beta}$  are the average attenuation and propagation coefficients along the line.

**5.5.2. HP Dielectric Strength Probe System (open-ended coaxial transmission-line probe/sensor)**

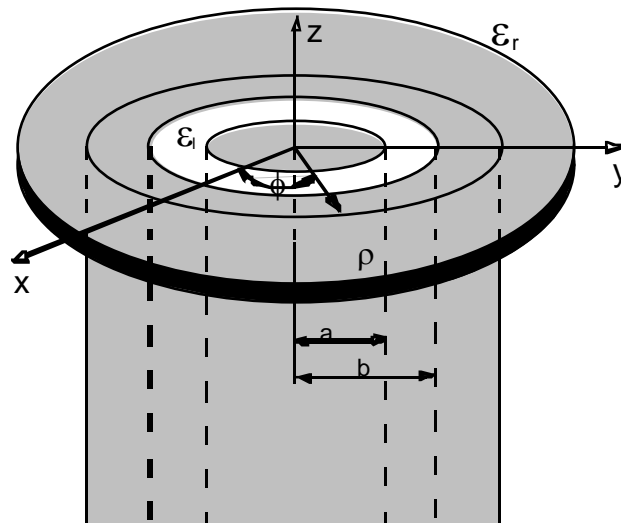
**5.5.2.1. Equipment set-up**

The equipment consists of a probe connected to one port of a vector network analyzer. The probe is an open-ended coaxial line, as shown in Figure B.2. Cylindrical coordinates ( $\rho, \phi, z$ ) are used where  $\rho$  is the radial distance from the axis,  $\phi$  is the angular displacement around the axis,  $z$  is the displacement along the axis,  $a$  is the inner conductor radius, and  $b$  is the outer conductor inner radius.

- Assessed by ITI (UK) Competent Body, NVLAP (USA) Accreditation Body & ACA/AUSTEL (Australia), VCCI (Japan)
- Accredited by Industry Canada (Canada) under ACC-LAB (Europe/Canada MRA and APEC/Canada MRA)
- Recognized/Listed by FCC (USA)
- All test results contained in this engineering test report are traceable to National Institute of Standards and Technology (NIST)



The sample holder is a non-metallic container that is large compared with the size of the probe immersed in it. A probe with an outer diameter  $b$  of 2 to 4 mm is suitable for the measurement of tissue-equivalent materials in the 300 MHz to 3 GHz frequency range. This probe size is commensurate with sample volumes of 50 cc or higher. Larger probes of up to 7 mm outer diameter  $b$  may be used with larger sample volumes. A flange is typically included to better represent the infinite ground-plane assumption used in admittance calculations.



**Figure 5.5.2.1. An open-ended coaxial probe with inner and outer radii  $a$  and  $b$ , respectively**

The accuracy of the short-circuit measurement should be verified for each calibration at a number of frequencies. A short circuit can be achieved by gently pressing a piece of aluminum foil against the open end. For best electrical contact, the probe end should be flat and free of oxidation. Larger the sensors generally have better foil short-circuit repeatability. It is possible to obtain good contact with some commercial 4.6 mm probes using the metal-disk short-circuit supplied with the kit. For best repeatability, it may be necessary to press the disk by hand.

The network analyzer is configured to measure the magnitude and phase of the admittance. A one-port reflection calibration is performed at the plane of the probe by placing materials for which the reflection coefficient can be calculated in contact with the probe. Three standards are needed for the calibration, typically a short circuit, air, and de-ionized water at a well-defined temperature (other reference liquids such as methanol or ethanol may be used for calibration). The calibration is a key part of the measurement procedure, and it is therefore important to ensure that it has been performed correctly. It can be checked by re-measuring the short circuit to ensure that a reflection coefficient of  $\Gamma = -1.0$  (linear units) is obtained consistently.

**5.5.2.2. Measurement procedure**

- a) Configure and calibrate the network analyzer and probe system.

- b) Place the sample in a non-metallic container and immerse the probe. A fixture or clamp is recommended to stabilize the probe, mounted such that the probe face is at an angle with respect to the liquid surface to minimize trapped air bubbles beneath the flange.
- c) Measure the complex admittance with respect to the probe aperture.
- d) Compute the complex relative permittivity  $\epsilon_r = \epsilon_r' - j\sigma/\omega\epsilon_0$ .

---

**ULTRATECH GROUP OF LABS**

3000 Bristol Circle, Oakville, Ontario, Canada L6H 6G4  
Tel. #: 905-829-1570, Fax. #: 905-829-8050, Email: vic@ultratech-labs.com, Website: <http://www.ultratech-labs.com>

**File #: ITS-006-SAR**  
**June 5, 2003**

- Assessed by ITI (UK) Competent Body, NVLAP (USA) Accreditation Body & ACA/AUSTEL (Australia), VCCI (Japan)
- Accredited by Industry Canada (Canada) under ACC-LAB (Europe/Canada MRA and APEC/Canada MRA)
- Recognized/Listed by FCC (USA)
- *All test results contained in this engineering test report are traceable to National Institute of Standards and Technology (NIST)*

## 5.6. SYSTEM CALIBRATION

The SAR measurement system has two main components:

- a) the probe, which is connected to the inputs of
- b) the instrumentation amplifier whose outputs are connected through the optical transmission line to
- c) the computer.

The system is calibrated as one unit not as individual components. If any components is modified or replaced, the system must be re-calibrated.

The system calibration is performed by two steps:

- 1) determination of the sensitivity of the probe in the air by introducing it into the well-defined RF field, and
- 2) correlation of the measured E-field in the dielectric medium to the temperature rise in a dielectric medium.

### 5.6.1. Probe linearity

Detector diodes at the dipole feed-point are used to rectify the sensor voltage output. The rectified signal is transmitted through resistive (RF-transparent) lines to the sensor amplifier. At low field strength levels the output voltage is proportional to the square of the amplitude of the incident field; at higher signal levels, the output voltage is not linearly proportional to  $|E|^2$ , but becomes proportional to E. The compensation for diode compression is carried out for the each detector diode using the 3-rd order polynomial least-square fit algorithm before any further evaluation.

### 5.6.2. Free Space Calibration

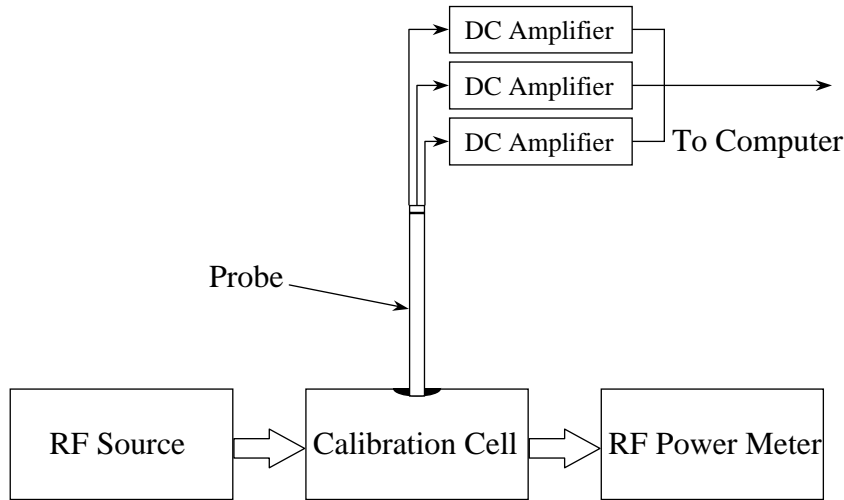
Note: Equipment must be regularly calibrated.

- RF Signal Generator - frequency range to at least 6 GHz,
- RF Amplifier – if needed to generate the required power density in the test cell,
- Test Cell - TEM (Crawford) cell, waveguide, or other device capable of maintaining a uniform field,
- RF Power Meter - capable of measuring at least 5 Watts (current calibration is mandatory!) if possible traceable to the National Institute of Standards and Technology (NIST).
- E-Field Probe (under calibration)
- Probe Support Fixture
- Instrumentation Amplifier
- Transmission Line
- Computer Program with the Automated Calibration System Program

#### 5.6.2.1. Method

Due to impedance variations in the diodes and the transmission line, and slight differences in gain among the channels of the instrumentation amplifier, a normalization method had been designed. The calibration method actually used is to determine the factors necessary adjust each channel of the system so it's indicated output can then be equated to the well-defined RF field. These factors are referred to as "Amplifier Settings".

- Assessed by ITI (UK) Competent Body, NVLAP (USA) Accreditation Body & ACA/AUSTEL (Australia), VCCI (Japan)
- Accredited by Industry Canada (Canada) under ACC-LAB (Europe/Canada MRA and APEC/Canada MRA)
- Recognized/Listed by FCC (USA)
- All test results contained in this engineering test report are traceable to National Institute of Standards and Technology (NIST)

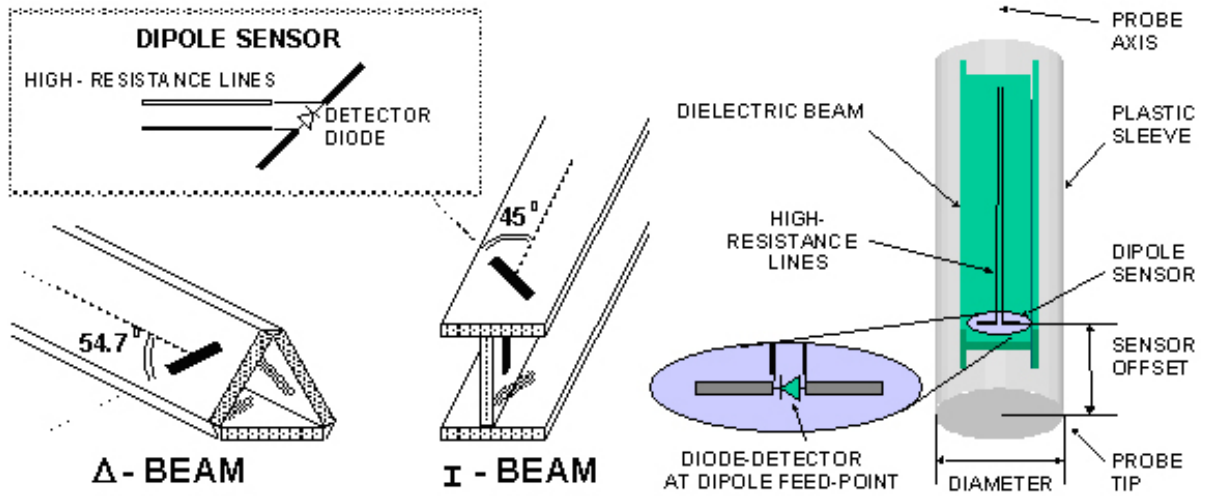


**Figure 5.6.2.1. Free Space Calibration Setup for Amplifier Setting**

**5.6.2.2. Measurement procedure**

Free Space Calibration of E-field probes can be performed using a TEM cell manufactured by IFI (Instrumentation for Industry, Farmingdale, NY 11735) with operating frequency at or below 1 GHz. Above 1 GHz, waveguides are used to calibrate the probes in free space.

- Connect the equipments as shown in Figure 5.6.2.1;
- Adjust the RF generator output so that the power density at the calibration point inside the TEM cell is well-defined. (For the IFI model CC-110 cell, the uniform power density of 1.0 [mW/cm<sup>2</sup>] requires the power level of 271.0 [mW]);
- Mount the probe of the system to calibrate in the support fixture. Insert the probe through the aperture of the TEM cell. The probe handle should be at the geometric center of the aperture, i.e. midway between the septum and the upper surface, and orthogonal to the side of the cell. The sensing portion of the probe should be located at a point halfway across the depth of the cell (volumetric center).
- Once the prescribed position is obtained, it must be maintained during the rest of the measurement. The only movement of the probe allowed is rotation on its axis to position the dipole in the plane of the E-field and, for channel 3 only, parallel to the vertical uniform field (max./min. output).
- Verify that the RF power level remains constant throughout the measurement. While the probe is being rotated through 360 degrees, software indicators will show the maximum measured on each channel.



**Figure 5.6.2.2. E-field probe construction**

**5.6.2.3. Definition of Amplifier Settings**

The initial sequence of probe calibrations steps performed with SAR determinations produces the factors used in scaling probe output voltage to RF power density. For historical reasons all probes factors are compared to a factor 10.8 [mV] per [mW/cm<sup>2</sup>] that was typical of a prototype probe, but is in fact an arbitrary number used as an intermediately constant. The factor of 10.8 [mV/(mW/cm<sup>2</sup>)] is known as the sensor factor to the uniform power density ( $\eta_{pd}$ ), but does not change. Also we can derive 10.8/3,770 [mV/(V/m)<sup>2</sup>] of the sensor factor to the  $|E|^2$  ( $\eta_{E2}$ ), providing 377 [ $\Omega$ ] as free space impedance.

$$\eta_{pd} = 10.8 [mV / (mW / cm^2)] \equiv \eta_{E2} = \frac{10.8}{3770} [mV / (V / m)^2]$$

$$Pd [mW / cm^2] = \frac{PO_{tot}}{\eta_{pd}}, |E|^2 [(V / m)^2] = \frac{PO_{tot}}{\eta_{E2}} \text{ and } SAR = \frac{\sigma \times PO_{tot}}{\rho \eta_{E2}}$$

To calibrate a probe, each channel is assigned an amplifier setting. This factor is obtained from the maximum probe output voltage measured during probe calibration. This probe output voltage is corrected for any DC offset of the instrumentation amplifier, usually a very small amount.

During calibration, the sensitivity for the E-field tangential to the dipole axis caused by the geometry of the probe construction is carefully considered to obtain the correct amplifier setting for each channel. Thus, the amplifier settings for each channel are as follows:

**ULTRATECH GROUP OF LABS**

3000 Bristol Circle, Oakville, Ontario, Canada L6H 6G4  
 Tel. #: 905-829-1570, Fax. #: 905-829-8050, Email: vic@ultratech-labs.com, Website: http://www.ultratech-labs.com

**File #: ITS-006-SAR**  
**June 5, 2003**

- Assessed by ITI (UK) Competent Body, NVLAP (USA) Accreditation Body & ACA/AUSTEL (Australia), VCCI (Japan)
- Accredited by Industry Canada (Canada) under ACC-LAB (Europe/Canada MRA and APEC/Canada MRA)
- Recognized/Listed by FCC (USA)
- All test results contained in this engineering test report are traceable to National Institute of Standards and Technology (NIST)

$$AS_i = \frac{\eta_{Pd}}{V_{\max_i} - DC_i} \times \cos^2(\varphi - \theta_i) \times Pd$$

Where,

$AS_i$	Amplifier Setting for channel i
$\eta_{pd}$	Sensor Factor to the uniform power density, an arbitrary value 10.8 [mV/(mW/cm <sup>2</sup> )]
$V_{\max_i}$	Maximum probe raw output recorded for channel i by rotation about the probe axis with the probe in a test cell
$DC_i$	Ambient DC offset of channel i (the voltage output of the transmission line with the instrumentation amplifier on and RF power off, recorded at the beginning of the probe calibration)
$\varphi$	Smaller angle between the probe axis and the direction of the E-field (90° providing the probe axis is parallel to the plane of the septum inside TEM cell)
$\theta_i$	Smaller angle between the probe axis and the dipole sensor axis of the channel i ( $\theta_1 = \theta_2 = 45^\circ$ , $\theta_3 = 90^\circ$ for I-beam probe, and $\theta_1 = \theta_2 = \theta_3 = 54.7^\circ$ for triangular-beam probe)
$Pd$	Well-defined power density [mW/cm <sup>2</sup> ] at the calibration point in a test cell

### 5.6.3. Thermal Transfer Calibration

#### 5.6.3.1. Measurement procedure

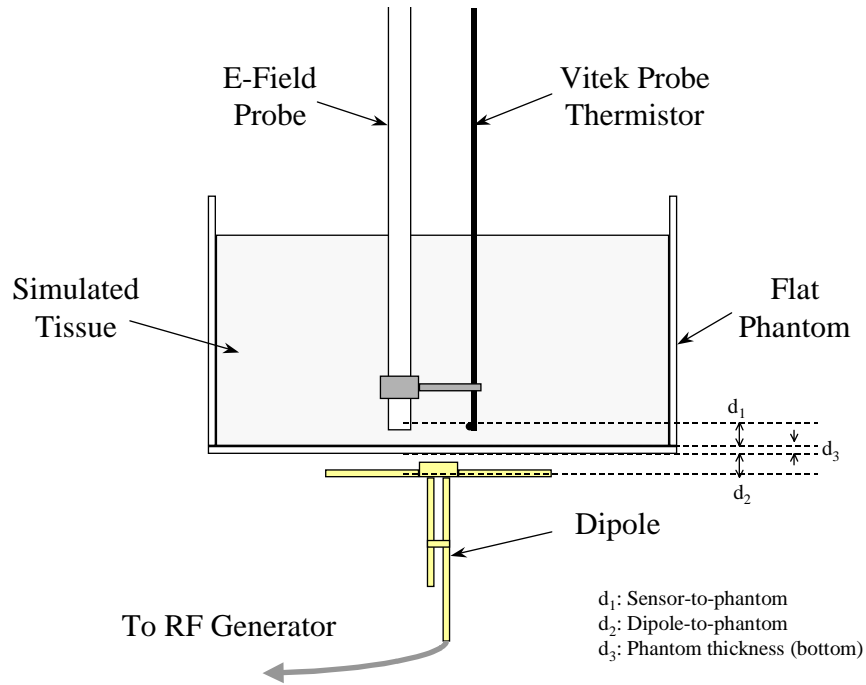
An RF transparent thermistor-based temperature probe and a isotropic E-field probe are placed side-by-side in a planar phantom while both are exposed to RF energy from a half wave dipole antenna located below the phantom. The E-field probe and amplifiers were previously calibrated.

First, the location of the maximum E-field close to the phantom’s bottom is determined as a function of power into the dipole.

Then, the E-field probe is moved sideways so that the temperature probe, while affixed to the E-field probe is placed at the previous location of the E-field probe.

Finally, temperature changes for a certain amount of time (generally 10 to 30 seconds) exposures at the same RF power levels used for the E-field are recorded. Care is taken to allow cooling down to the original temperature and temperature stabilization between tests.

- Assessed by ITI (UK) Competent Body, NVLAP (USA) Accreditation Body & ACA/AUSTEL (Australia), VCCI (Japan)
- Accredited by Industry Canada (Canada) under ACC-LAB (Europe/Canada MRA and APEC/Canada MRA)
- Recognized/Listed by FCC (USA)
- All test results contained in this engineering test report are traceable to National Institute of Standards and Technology (NIST)



**Figure 5.6.3.1. Flat Phantom, Thermistor and E-Field Probe**

The following simple equation relates SAR to the initial temperature slope:

$$SAR_t = \frac{c \cdot \Delta T}{\Delta t} \tag{Eq. 1}$$

In (Eq.1)  $\Delta t$  is the exposure time [sec],  $c$  is the specific heat capacity of the simulated tissue [J/Kg/°C] and  $\Delta T$  is the temperature increase [°C] due to the RF exposure. SAR is proportional to  $\Delta T/\Delta t$ , the initial rate of tissue heating, before thermal diffusion takes place.

From (Eq.1) it is possible to quantify the electric field in the simulated tissue by equating the thermally-derived SAR to the E-field:

$$SAR = \frac{|E|^2 \cdot \sigma}{\rho} \tag{Eq. 2}$$

where  $\sigma$  is the simulated tissue conductivity [S/m] and  $\rho$  its mass density [Kg/m<sup>3</sup>]; The actual mass density of the simulated tissue is required during the thermal transfer calibration, while mass density of 1,000 [Kg/m<sup>3</sup>] is conventionally chosen during the SAR measurements.

- Assessed by ITI (UK) Competent Body, NVLAP (USA) Accreditation Body & ACA/AUSTEL (Australia), VCCI (Japan)
- Accredited by Industry Canada (Canada) under ACC-LAB (Europe/Canada MRA and APEC/Canada MRA)
- Recognized/Listed by FCC (USA)
- All test results contained in this engineering test report are traceable to National Institute of Standards and Technology (NIST)

**5.6.3.2. Determination of Conversion Factor ( $\gamma$ ) in the simulated tissue**

The sensitivity of the probe in the dielectric media compared to its sensitivity in the air, is different. Conversion Factor ( $\gamma$ ) is defined to determine the degree of the enhancement of sensitivity in the different dielectric media and relate it to its sensitivity in the air.

$$PO_{tot\_tissue} \equiv PO_{tot\_air} \times \gamma$$

Thus,

$$|E_{tissue}|^2 = \frac{PO_{tot\_tissue}}{\eta_{E2}} \times \frac{1}{\gamma}, \text{ and } SAR_{tissue} = \frac{\sigma \times \frac{PO_{tot\_tissue}}{\eta_{E2}} \times \frac{1}{\gamma}}{\rho}$$

where,

$ E_{tissue} ^2$	RMS E-field level [(V/m) <sup>2</sup> ] induced within the exposed tissue
$PO_{tot\_tissue}$	Probe voltage output measured in the simulated tissue [mV]
$PO_{tot\_air}$	Probe voltage output measured in the air ( $Z_{air} = 377[\Omega]$ ) [mV]
$\eta_{E2}$	Sensor Factor to the $ E ^2$ , an arbitrary value 10.8/3,770 [mV/(V/m) <sup>2</sup> ]
$\gamma$	Conversion factor; ratio of sensor response in air to response in the dielectric media

The conversion factor ( $\gamma$ ) can be used to scale the E-field in terms of the thermally-derived SAR. It is the quotient of  $SAR_t$ , the SAR determined from temperature measurements in the flat phantom, and  $PO_{tot\_tissue}$ , the E-field probe output voltage obtained at the same location in the phantom

$$SAR_t = SAR_{tissue}$$

$$\frac{c \cdot \Delta T}{\Delta t} = \frac{\sigma_{@cal} \times |E_{tissue}|^2}{\rho}$$

$$= \frac{\sigma_{@cal} \times \frac{PO_{tot\_tissue}}{\eta_{E2}} \times \frac{1}{\gamma}}{\rho}$$

Thus,

$$\gamma = \frac{\sigma_{@cal}}{\eta_{E2} \times \rho} \times \frac{PO_{tot\_tissue}}{SAR_t} = \frac{\sigma_{@cal} \times 3,770}{10.8 \times c \times \rho} \times \frac{PO_{tot\_tissue}}{\Delta T / \Delta t} \tag{Eq. 3}$$

where,

- Assessed by ITI (UK) Competent Body, NVLAP (USA) Accreditation Body & ACA/AUSTEL (Australia), VCCI (Japan)
- Accredited by Industry Canada (Canada) under ACC-LAB (Europe/Canada MRA and APEC/Canada MRA)
- Recognized/Listed by FCC (USA)
- All test results contained in this engineering test report are traceable to National Institute of Standards and Technology (NIST)



$\gamma$	Conversion factor; ratio of sensor response in air to response in the dielectric media
$SAR_t$	Thermally-derived SAR [W/Kg] (Eq. 1)
$ E_{tissue} ^2$	RMS E-field level [(V/m) <sup>2</sup> ] induced within the exposed tissue
$PO_{tot\_tissue}$	Probe voltage output measured in the simulated tissue [mV]
$\eta_{E2}$	Sensor Factor to the $ E ^2$ , an intermediately constant, 10.8/3,770 [mV/(V/m) <sup>2</sup> ]
$c$	Specific heat capacity of the simulated tissue [J/Kg/°C]
$\sigma_{@cal}$	Conductivity of the simulated tissue during the calibration procedure [S/m]
$\rho$	Actual mass density of the simulated tissue [Kg/m <sup>3</sup> ]
$\Delta T/\Delta t$	Initial rate of tissue heating, before thermal diffusion takes place [°C /sec]

The temperature E-field correlation is illustrated below (for simulated brain tissue) for an example in which the thermal quantities were,

$$\begin{aligned}
 \text{RF power input} &= 0.5 \text{ [W]} \\
 \Delta T &= 0.0163 \text{ [}^\circ\text{C]} \text{ (from thermistor-base temperature probe)} \\
 \sigma_{@cal} &= 0.97 \text{ [S/m]} \\
 \rho &= 1,200 \text{ [Kg/m}^3\text{]} \\
 c &= 2,700 \text{ [J/Kg/}^\circ\text{C]} \\
 \Delta t &= 30 \text{ [sec]}
 \end{aligned}$$

The resulting  $SAR_t$  was (Eq. 1)

$$SAR_t = \frac{2,700 \times 0.0163}{30} = 1.467 \text{ [W/Kg]}$$

In this case the output of the E-field probe when at the same position as the thermistor probe was

$$PO_{tot\_tissue} = 210.93 \text{ [mV]}$$

The calculation of conversion factor ( $\gamma$ ) from (Eq. 3) follows:

$$\gamma = \frac{0.97}{\frac{10.8}{3,770} \times 1,200} \times \frac{28.5}{1.467} = 5.482$$

## 5.6.4. Data Acquisition Methodology

### 5.6.4.1. E-Field Measurement

The probe calibration must be current before starting measurements. Instrumentation amplifier batteries must be charged. This can be monitored by observing DC offset voltages. A daily log of the DC offset voltages should be kept for this purpose.

Measurements in the phantom are automatically calculated for each location by summation of the three dipole outputs. Because each dipole produces an output voltage proportional to the square of the electric field component along the dipole, the sum of dipole voltages represents the RMS values for the total electric field. Thus, taking into consideration the amplifier settings and the DC offset voltages, the total electric field strength at a measurement location is as follows.

- Assessed by ITI (UK) Competent Body, NVLAP (USA) Accreditation Body & ACA/AUSTEL (Australia), VCCI (Japan)
- Accredited by Industry Canada (Canada) under ACC-LAB (Europe/Canada MRA and APEC/Canada MRA)
- Recognized/Listed by FCC (USA)
- All test results contained in this engineering test report are traceable to National Institute of Standards and Technology (NIST)

See Appendix C.  $PO_{tot}$  is labeled by the software as measure of values (voltages). The SAR for calculations that are derived from the measure of values are discussed below.

At each measurement point, the program records the output of the three channels:

$$PO_1 = (V_1 - DC_1) \times AS_1 \equiv |E_1|^2 \times \eta_{E2}$$

$$PO_2 = (V_2 - DC_2) \times AS_2 \equiv |E_2|^2 \times \eta_{E2}$$

$$PO_3 = (V_3 - DC_3) \times AS_3 \equiv |E_3|^2 \times \eta_{E2}$$

$$PO_{tot} \equiv |E|^2 \times \eta_{E2} = (|E_1|^2 + |E_2|^2 + |E_3|^2) \times \eta_{E2} = |E_1|^2 \times \eta_{E2} + |E_2|^2 \times \eta_{E2} + |E_3|^2 \times \eta_{E2}$$

$$\equiv PO_1 + PO_2 + PO_3$$

Where,

$V_i$	Actual raw reading of channel i at a measurement point
$DC_i$	Ambient DC offset of channel i at a measurement point
$AS_i$	Amplifier setting of channel i
$\eta_{E2}$	Sensor Factor to the $ E ^2$ , an arbitrary value 10.8/3,770 [mV/(V/m) <sup>2</sup> ]
$PO_i$	Probe output of channel i at a measurement point [mV]
$PO_{tot}$	Total probe output at a measurement point [mV]

**5.6.4.2. Sensitivity( $\zeta$ ) of probe in the simulated tissue**

The sensitivity( $\zeta$ ) of the probe in the simulated tissue is rendered in terms of Sensor Enhancement Factor in the simulated tissue.

$$\zeta = \frac{\sigma_{@meas}}{\eta_{E2} \times \rho \times \gamma} = \frac{\sigma_{@meas}}{\frac{10.8}{3,770} \times 1,000 \times \gamma} = \frac{3,770 \times \sigma_{@meas}}{10,800 \times \gamma} \quad \text{(Eq. 5)}$$

Where,

$\zeta$	Sensitivity of the probe in the simulated tissue [W/Kg/mV]
$\gamma$	Conversion factor; ratio of sensor response in air to response in the dielectric media
$\eta_{E2}$	Sensor Factor to the $ E ^2$ , an arbitrary value 10.8/3,770 [mV/(V/m) <sup>2</sup> ]
$\sigma_{@meas}$	Conductivity of the simulated tissue during the measurement [S/m]
$\rho$	Mass density of the simulated tissue [Kg/m <sup>3</sup> ]; 1,000 [Kg/m <sup>3</sup> ] is conventionally chosen.

Therefore, SAR can be yielded from

$$SAR = \zeta \times PO_{tot\_tissue} \quad \text{(Eq. 6)}$$

Where,

$\zeta$	Sensitivity of the probe in the simulated tissue [W/Kg/mV]
$PO_{tot\_tissue}$	Probe voltage output measured in the simulated tissue [mV]

- Assessed by ITI (UK) Competent Body, NVLAP (USA) Accreditation Body & ACA/AUSTEL (Australia), VCCI (Japan)
- Accredited by Industry Canada (Canada) under ACC-LAB (Europe/Canada MRA and APEC/Canada MRA)
- Recognized/Listed by FCC (USA)
- All test results contained in this engineering test report are traceable to National Institute of Standards and Technology (NIST)

To continue the example illustrated above,

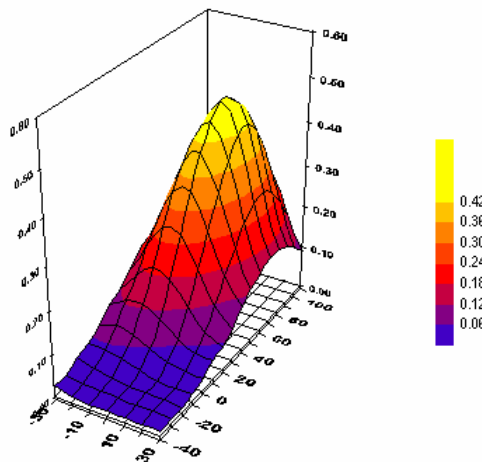
$$\begin{aligned} \sigma_{@meas} &= 0.99 \text{ [S/m]} \\ PO_{tot\_tissue} &= 11.5 \text{ [mV]} \end{aligned}$$

$$\zeta = \frac{3,770 \times \sigma_{@meas}}{10,800 \times \eta} = \frac{3,770 \times 0.99}{10,800 \times 5.482} = 0.063 \text{ [W/Kg/mV]}$$

$$SAR = \zeta \times PO_{tot\_tissue} = 0.063 \times 11.5 = 0.725 \text{ [W/Kg]}$$

**5.6.4.3. SAR Measurement**

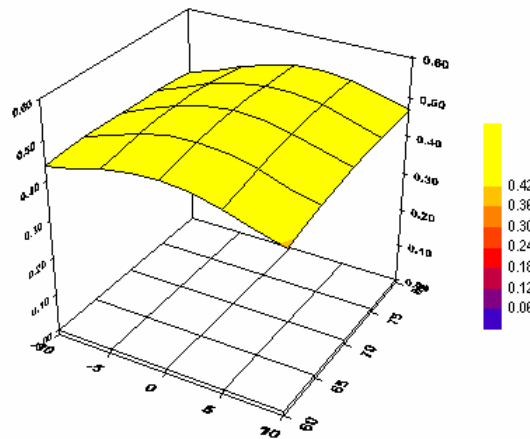
The goal of the measurement process is to scan the phantom over a selected area in order to find the region of highest levels of RF energy and then to obtain a single value for the peak spatial-average of SAR over a volume that would contain one gram (in the shape of a cube) of biological tissue. The test procedure, of course, measures SAR in the simulated tissue.



**Figure 5.6.4.3.a. Area scan**

The software request the user to move the probe to locations at two extreme corners of a rectangle that encloses the area to be scanned. An arbitrary origin and the spatial resolution for the scan are also specified. Under program control, the scan is performed automatically by the robot-guided probe.

- Assessed by ITI (UK) Competent Body, NVLAP (USA) Accreditation Body & ACA/AUSTEL (Australia), VCCI (Japan)
- Accredited by Industry Canada (Canada) under ACC-LAB (Europe/Canada MRA and APEC/Canada MRA)
- Recognized/Listed by FCC (USA)
- All test results contained in this engineering test report are traceable to National Institute of Standards and Technology (NIST)



**Figure 5.6.4.3.b. Zoom Scan**

The fine resolution volume scan region is centered at the peak SAR locations determined by the interpolated (cubic spline) data from the area scan measurements. The number of measurement point required in a zoom scan is defined to provide an accurate one-gram averaged SAR in terms of both the number of points ( $PT_x \times PT_y \times PT_z$ ) and the size ( $SZ_x[\text{mm}] \times SZ_y[\text{mm}] \times SZ_z[\text{mm}]$ ) of the cubic. For one-gram SAR,  $(5 \times 5 \times 7)$  and  $(32[\text{mm}] \times 32[\text{mm}] \times 30[\text{mm}])$  is preferred to select below 1 GHz. The zoom scan region extends in each direction for at least 1.5 times the linear dimensions of 1- or 10-gram cube of tissue from each peak. The zoom scan spatial resolution is interpolated down to SAR values on a 1mm grid by using the tri-linear interpolation algorithm.

The peak field values near the surface of a homogeneous phantom are usually not measurable because the sensors in a field probe are located at 2-4 mm behind the tip of the probe and the measurement point is defined at the geometric center of the sensors where the calibration is defined. These SAR values are computed by extrapolating the closest measured points to the surface of the phantom to determine the highest one-gram averaged SAR. The extrapolation coefficients are determined with a multi-order curve-fitting algorithm. Generally the 4-th order polynomial least-square fit is sufficient to extrapolate to the surface if the number of the valid measurements, that are non-zero, along the probe axis is greater than 4.

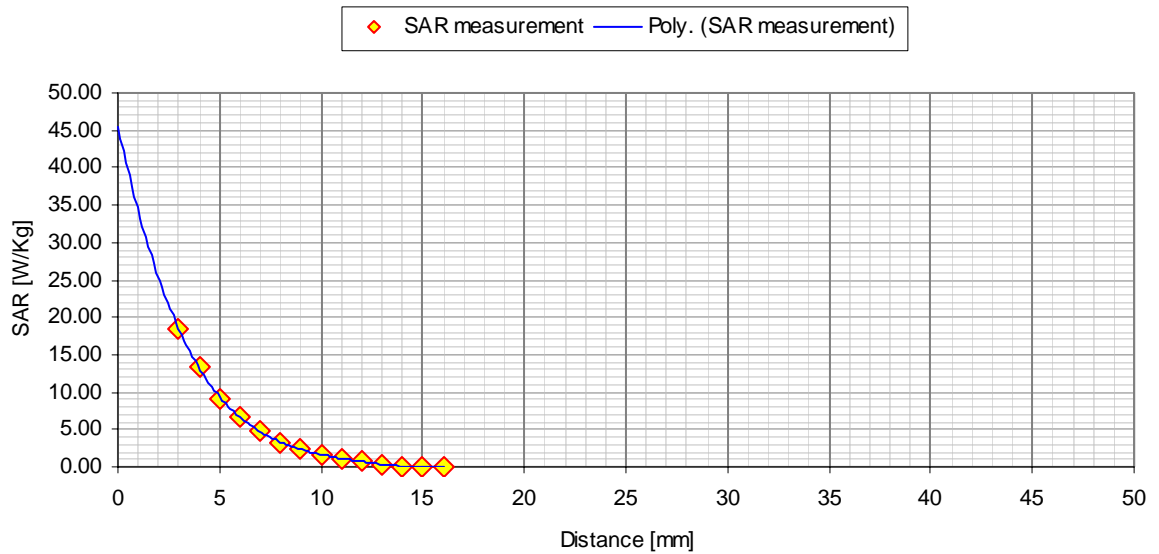
The interpolated and extrapolated SAR values from the zoom scan measurements are integrated in the shape of 1- or 10-gram cube then traversed to determine the highest peak spatial-average SAR in the zoom scan region.

This peak spatial-averaged SAR is reported as SAR [W/kg] for compliance.

**5.6.4.4. Data Extrapolation and boundary effect**

The distance from the center of the sensor (diode) to the end of the protective tube is called the ‘probe offset’ or ‘sensor offset’. To compensate we use a multi-order polynomial least-square curve fitting to obtain the peak surface value from the voltages measured at the distance from the inner surface of the phantom. The field is measured as close as possible to the phantom’s surface and every pre-defined separation distance (1 [mm] to 5 [mm]) along the probe axis (z) for a distance of at least 50 mm until they are not measurable. The appropriate curve is obtained from all the points measured and used to define an exponential decay of the energy density versus depth.

- Assessed by ITI (UK) Competent Body, NVLAP (USA) Accreditation Body & ACA/AUSTEL (Australia), VCCI (Japan)
- Accredited by Industry Canada (Canada) under ACC-LAB (Europe/Canada MRA and APEC/Canada MRA)
- Recognized/Listed by FCC (USA)
- All test results contained in this engineering test report are traceable to National Institute of Standards and Technology (NIST)



**Figure 5.6.4.4. Exponential decay of the energy density versus depth**

Boundary effects arise when the tip of an electric field probe approaches the interface between two dielectric media. Under these conditions, the external field is strongly perturbed by the superposition of a scattered field from the probe. The effect of the boundary on the peak spatial-average SAR values strongly depends on the probe dimensions, especially the diameter of the tip of the probe. It is known that the error due to boundary effects is very small if the distance between the probe tip and the surface is greater than half the probe diameter. Therefore the first one or two measurements at the vicinity to the phantom surface are excluded for evaluating the exponential decay curve in order to compensate for the boundary effect.

**5.6.5. Determining the Heat Capacity of Simulated Tissue**

**5.6.5.1. Instruments and Materials**

- Calibrated differential thermometer (Vitek or BAT-8 or equivalent)
- Two identical 500 ml containers
- A thermally insulated vessel (thick styrofoam, with a form fitting hole for one container)
- Hot and cold tap water
- Solution under test
- Hot plate
- Temperature vs. time (chart recorder, or data logger)

**5.6.5.2. Method**

Heat can be propagated by conduction, convection and radiation. In the case of liquids heated from below, gravity convection is the main and predominant heating mechanism of the fluid mass.

- Assessed by ITI (UK) Competent Body, NVLAP (USA) Accreditation Body & ACA/AUSTEL (Australia), VCCI (Japan)
- Accredited by Industry Canada (Canada) under ACC-LAB (Europe/Canada MRA and APEC/Canada MRA)
- Recognized/Listed by FCC (USA)
- All test results contained in this engineering test report are traceable to National Institute of Standards and Technology (NIST)

Obtain two containers that can be rapidly heated (e.g. glass or suitable plastic). Fill one container with 250 ml of water, the other with the same mass of simulated tissue. The initial temperature of the water should be the same as that of the simulated tissue ( $\pm 1^\circ\text{C}$ ). Since we are dealing with heating by electromagnetic sources at ambient temperature, it is essential that we eliminate the chance of any direct infrared heating of the temperature sensor. To ensure this, position the tip of the sensor 2 mm from the bottom of the center of the container. Turn on the heat source and wait at least 5 minutes for its temperature to stabilize. Record the initial temperature of the water. Place the container of water 5 mm above the center of the hot plate and monitor the temperature increase.

After 30 seconds of heating, the water temperature should have increased by at least  $5^\circ\text{C}$ . Record the time and temperature. Remove the container from the heat source and place it in the thermally insulated vessel. Stir the liquid thoroughly and record the steady state temperature 1-2 minutes after stirring.

Repeat the above procedure using the container of simulated tissue. Ensure that the container is placed on the same area of the hot plate, is heated for the identical length of time, and the steady state temperature is recorded after the identical time interval.

Since the heat capacity of water is  $C_w = 1,000$  [cal/Kg/ $^\circ\text{C}$ ] or  $4,189$  [J/Kg/ $^\circ\text{C}$ ] with excellent approximation ( $\sim 1\%$ ) in the temperature range of interest, the heat capacity ( $C_s$ ) of the solution is given by:

$$C_s = C_w \cdot \frac{\Delta T_w}{\Delta T_s}$$

where  $\Delta T_w$  is the temperature increase of water and  $\Delta T_s$  the temperature increase of the solution. The ration of the values,  $\Delta T_w / \Delta T_s$ , should be the same (within the sensitivity of the thermometer) at the end of the heating and stirring. This ensures that the liquids have been uniformly heated.

### 5.6.5.3. Rationale

$$C \cdot \Delta T = \text{Heat\_Flow} \cdot \text{Time} = \text{Total\_Heating\_Energy}$$

If the heat flow, sample mass, and absorption (heat transfer) are the same for both liquids, then:

$$C_w \cdot \Delta T_w = C_s \cdot \Delta T_s$$

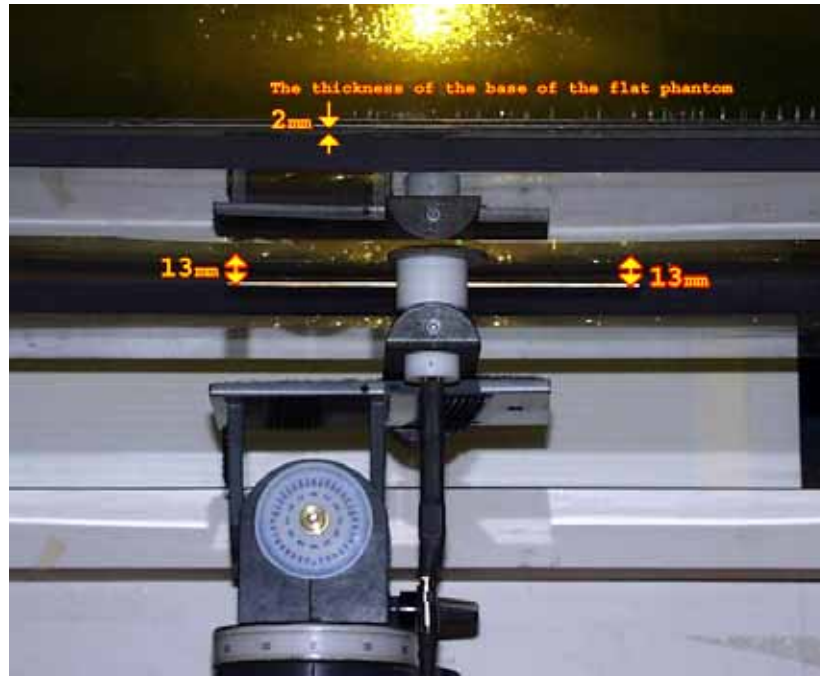
The heat flow and total heating are kept constant by using the same source for the same amount of time. If the heat transfer mechanisms for the two liquids are about the same, with insignificant differences in convective and conductive characteristics, then any differences in temperature increase are a direct measure of the specific heat capacity,  $C$ .

- Assessed by ITI (UK) Competent Body, NVLAP (USA) Accreditation Body & ACA/AUSTEL (Australia), VCCI (Japan)
- Accredited by Industry Canada (Canada) under ACC-LAB (Europe/Canada MRA and APEC/Canada MRA)
- Recognized/Listed by FCC (USA)
- All test results contained in this engineering test report are traceable to National Institute of Standards and Technology (NIST)

## 5.7. SAR MEASUREMENT SYSTEM VERIFICATION

### 5.7.1. Standard Source

A half-wave dipole is positioned below the bottom of the phantom and centered with its axis parallel to the longest side of the phantom. The distance between the liquid filled phantom bottom surface and the center of the dipole axis,  $s$ , is chosen as specified IEEE 1528 at the specific test frequency (i.e. 15 mm at 835 MHz). A low loss and low dielectric constant spacer is used to establish the correct distance between the top surface of the dipole and the bottom surface of the phantom.



### 5.7.2. Standard Source Input Power Measurement

The system validation is performed as shown below or in Figure 7.1 in IEEE 1528.

## ULTRATECH GROUP OF LABS

3000 Bristol Circle, Oakville, Ontario, Canada L6H 6G4  
Tel. #: 905-829-1570, Fax. #: 905-829-8050, Email: vic@ultratech-labs.com, Website: <http://www.ultratech-labs.com>

File #: ITS-006-SAR  
June 5, 2003

- Assessed by ITI (UK) Competent Body, NVLAP (USA) Accreditation Body & ACA/AUSTEL (Australia), VCCI (Japan)
- Accredited by Industry Canada (Canada) under ACC-LAB (Europe/Canada MRA and APEC/Canada MRA)
- Recognized/Listed by FCC (USA)
- All test results contained in this engineering test report are traceable to National Institute of Standards and Technology (NIST)



First the power meter PM1 (including attenuator Att1) is connected to the cable to measure the forward power at the location of the dipole connector (X). The signal generator is adjusted for the desired forward power at the dipole connector (taking into account the attenuation of Att1) as read by power meter PM2. After connecting the cable to the dipole, the signal generator is readjusted for the same reading at power meter PM2. If the signal generator does not allow adjustment in 0.01dB steps, the remaining difference at PM2 must be taken into consideration. PM3 records the reflected power from the dipole to ensure that the value is not changed from the previous value. The reflected power was verified to be at least 20dB below the forward power.

### 5.7.3. System Validation Procedure

A complete 1g-averaged SAR measurement is performed. The measured 1g-averaged SAR value is normalized to a forward power of 1W to a half-wave dipole and compared with the reference SAR value for the reference dipole and flat phantom shown in columns 2 and 3 of Table 7.1 in IEEE 1528.

---

## ULTRATECH GROUP OF LABS

3000 Bristol Circle, Oakville, Ontario, Canada L6H 6G4  
Tel. #: 905-829-1570, Fax. #: 905-829-8050, Email: vic@ultratech-labs.com, Website: <http://www.ultratech-labs.com>

File #: ITS-006-SAR  
June 5, 2003

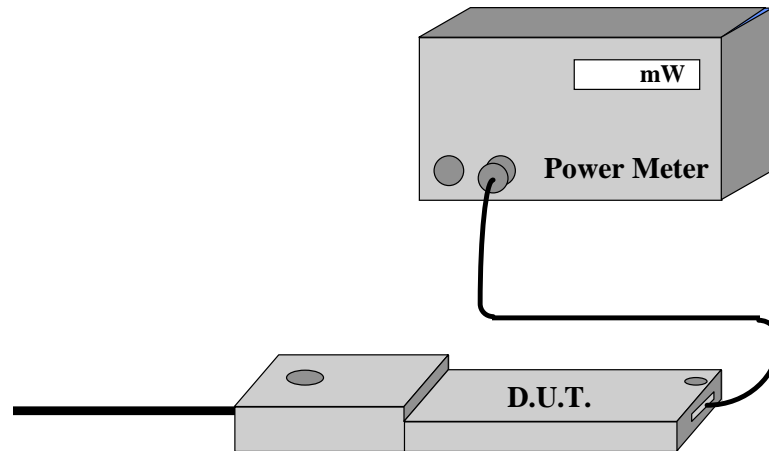
- Assessed by ITI (UK) Competent Body, NVLAP (USA) Accreditation Body & ACA/AUSTEL (Australia), VCCI (Japan)
- Accredited by Industry Canada (Canada) under ACC-LAB (Europe/Canada MRA and APEC/Canada MRA)
- Recognized/Listed by FCC (USA)
- All test results contained in this engineering test report are traceable to National Institute of Standards and Technology (NIST)



## 5.8. POWER MEASUREMENT

Whenever possible, a conducted power measurement is performed. To accomplish this, we utilize a fully charged battery, a calibrated power meter and a cable adapter provided by the manufacturer. The data of the cable and related circuit losses are also provided by the manufacturer. The power measurement is then performed across the operational band and the channel with the highest output power is recorded.

Power measurement is performed before and after the SAR to verify if the battery was delivering full power at the time of testing. A difference in output power would determine a need for battery replacement and to repeat the SAR test.



**Figure 5.8. Measured Power + Cable and Switching Mechanism Loss**

## ULTRATECH GROUP OF LABS

3000 Bristol Circle, Oakville, Ontario, Canada L6H 6G4  
Tel. #: 905-829-1570, Fax. #: 905-829-8050, Email: vic@ultratech-labs.com, Website: <http://www.ultratech-labs.com>

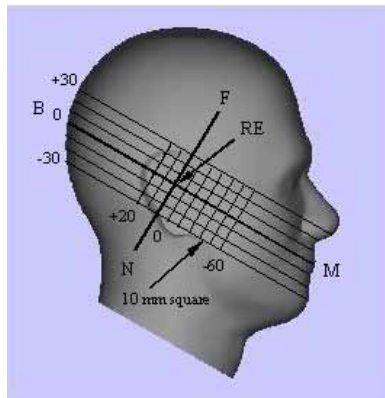
**File #: ITS-006-SAR**  
**June 5, 2003**

- Assessed by ITI (UK) Competent Body, NVLAP (USA) Accreditation Body & ACA/AUSTEL (Australia), VCCI (Japan)
- Accredited by Industry Canada (Canada) under ACC-LAB (Europe/Canada MRA and APEC/Canada MRA)
- Recognized/Listed by FCC (USA)
- All test results contained in this engineering test report are traceable to National Institute of Standards and Technology (NIST)

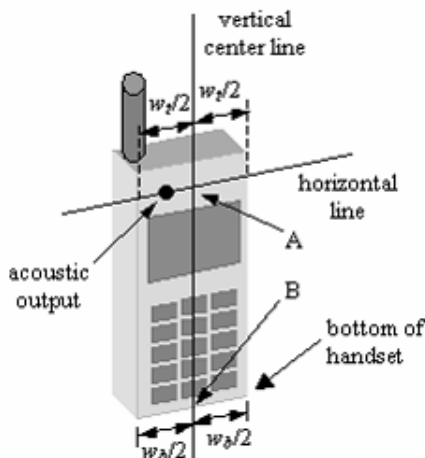
### 5.9. POSITIONING OF D.U.T.

The clear SAM phantom shell have been previously marked with a highly visible grid with a defined centre line, so it can easily be seen through the liquid simulated tissue. In the case of testing a cellular phone, this line is connecting the ear channel with the corner of the lips. The D.U.T. is then placed by centering the speaker with the ear channel and the center of the radio width with the corner of the mouth.

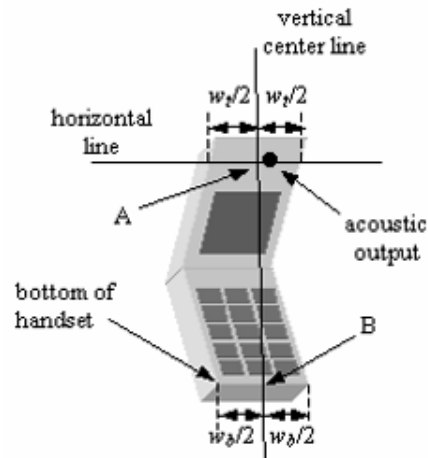
For HAND HELD devices (push-to-talk), or any other type of wireless transmitters positioned in front of the face, the D.U.T. will be positioned 2.5cm distance from a flat phantom to simulate the frontal facial position in use. All body-worn operating configurations are tested using a flat phantom. The length and width of the phantom is at least twice the corresponding dimensions of the test device, including its antenna.



**Figure 5.9.a. Side view of the phantom showing relevant marking**

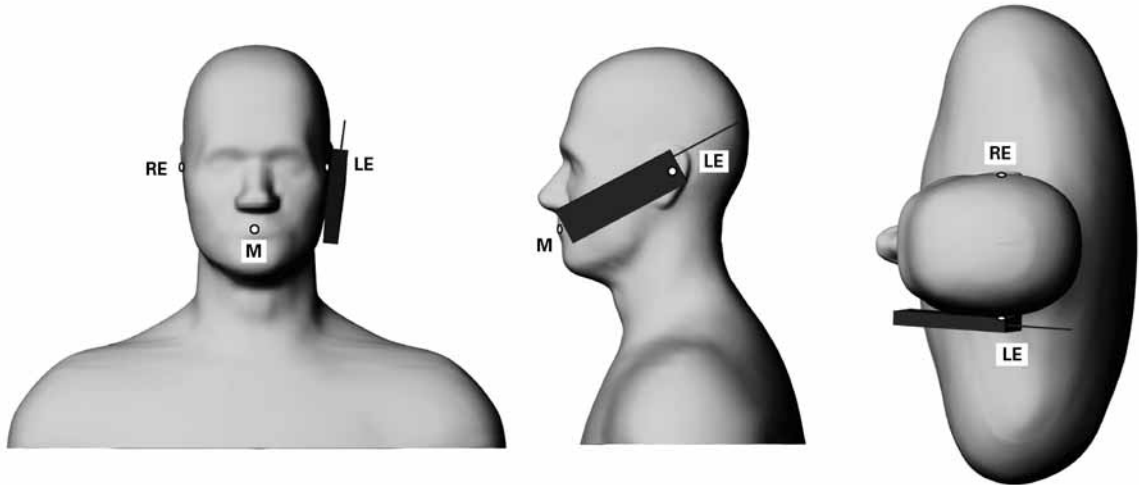


**Figure 5.9.b. Handset vertical and horizontal reference lines – fixed case**

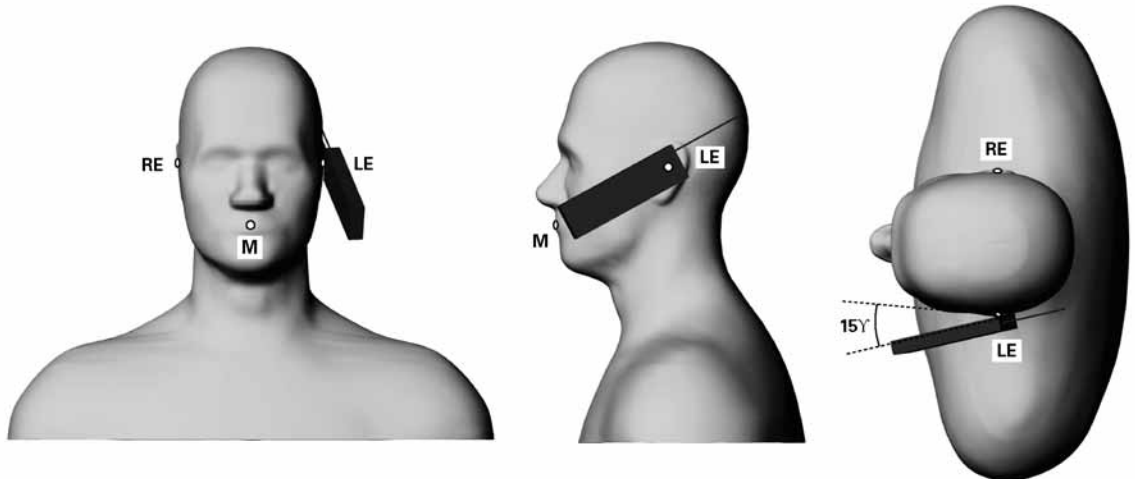


**Figure 5.9.c. Handset vertical and horizontal reference lines – “clam-shell”**

- Assessed by ITI (UK) Competent Body, NVLAP (USA) Accreditation Body & ACA/AUSTEL (Australia), VCCI (Japan)
- Accredited by Industry Canada (Canada) under ACC-LAB (Europe/Canada MRA and APEC/Canada MRA)
- Recognized/Listed by FCC (USA)
- All test results contained in this engineering test report are traceable to National Institute of Standards and Technology (NIST)



**Figure 5.9.d. Phone position 1, “cheek” or “touch” position.** The reference points for the right ear (RE), left ear (LE) and mouth (M), which define the reference plane for phone positioning, are indicated. The shoulders are shown for illustration purposes only.



**Figure 5.9.e. Phone position 2, “tilted position.”** The reference points for the right ear (RE), left ear (LE) and mouth (M), which define the reference plane for phone positioning, are indicated. The shoulders are shown for illustration purposes only.

**ULTRATECH GROUP OF LABS**

3000 Bristol Circle, Oakville, Ontario, Canada L6H 6G4  
Tel. #: 905-829-1570, Fax. #: 905-829-8050, Email: vic@ultratech-labs.com, Website: http://www.ultratech-labs.com

**File #: ITS-006-SAR**  
**June 5, 2003**

- Assessed by ITI (UK) Competent Body, NVLAP (USA) Accreditation Body & ACA/AUSTEL (Australia), VCCI (Japan)
- Accredited by Industry Canada (Canada) under ACC-LAB (Europe/Canada MRA and APEC/Canada MRA)
- Recognized/Listed by FCC (USA)
- All test results contained in this engineering test report are traceable to National Institute of Standards and Technology (NIST)

## 5.10. SAR MEASUREMENT UNCERTAINTY

This uncertainty analysis covers the 3D-EMC Laboratory test procedure for Specific Absorption Rate (SAR) associated with wireless telephones and similar devices.

### Standards Covered Are:

WGMTE 96/4 - Secretary SC211/B

FCC 96-326, ET Docket No. 93-62

Industry Canada RSS 102

ACA Radiocommunications (Electromagnetic Radiation – Human Exposure) Amendment Standard 2000 (No. 1)

The laboratory test procedure, and this uncertainty analysis, may be used to cover all standards above. It is based on test equipment and procedures specified by 3D-EMC Laboratories, Inc. located in Ft. Lauderdale, Florida.

---

## ULTRATECH GROUP OF LABS

3000 Bristol Circle, Oakville, Ontario, Canada L6H 6G4

Tel. #: 905-829-1570, Fax. #: 905-829-8050, Email: vic@ultratech-labs.com, Website: <http://www.ultratech-labs.com>

**File #: ITS-006-SAR**

**June 5, 2003**

- Assessed by ITI (UK) Competent Body, NVLAP (USA) Accreditation Body & ACA/AUSTEL (Australia), VCCI (Japan)
- Accredited by Industry Canada (Canada) under ACC-LAB (Europe/Canada MRA and APEC/Canada MRA)
- Recognized/Listed by FCC (USA)
- *All test results contained in this engineering test report are traceable to National Institute of Standards and Technology (NIST)*

**5.10.1. Measurement Uncertainty**

**5.10.1.1. Measurement Uncertainty evaluation for handset SAR test**

<i>a</i>	<i>b</i>	<i>c</i>	<i>d</i>	<i>e = f(d,k)</i>	<i>F</i>	<i>g</i>	<i>h = c x f / e</i>	<i>i = c x g / e</i>	<i>k</i>
Uncertainty Component	Sec.	Tol. (± %)	Prob. Dist.	Div.	<i>c<sub>i</sub></i> (1-g)	<i>c<sub>i</sub></i> (10-g)	1-g <i>u<sub>i</sub></i> (±%)	10-g <i>u<sub>i</sub></i> (±%)	<i>v<sub>i</sub></i>
<b>Measurement System</b>									
Probe Calibration	E1.1	3.0	N	1	1	1	3.0	3.0	∞
Axial Isotropy	E1.2	5.0	R	√3	0.7	0.7	2.0	2.0	∞
Hemispherical Isotropy	E1.2	8.0	R	√3	1	1	4.6	4.6	∞
Boundary Effect	E1.3	10.0	R	√3	1	1	5.8	5.8	∞
Linearity	E1.4	4.2	R	√3	1	1	2.4	2.4	∞
System Detection Limits	E1.5	2.0	R	√3	1	1	1.2	1.2	∞
Readout Electronics	E1.6	1.0	N	1	1	1	1.0	1.0	∞
Response Time	E1.7	1.5	R	√3	1	1	0.9	0.9	∞
Integration Time	E1.8	2.0	R	√3	1	1	1.2	1.2	∞
RF Ambient Conditions	E5.1	3.0	R	√3	1	1	1.7	1.7	∞
Probe Positioner Mechanical Tolerance	E5.2	<sup>1.0</sup>	R	√3	1	1	0.6	0.6	∞
Probe Positioning with respect to Phantom Shell	E5.3	3.0	R	√3	1	1	1.7	1.7	∞
Extrapolation, interpolation and Integration Algorithms for Max. SAR Evaluation	E4.2	<sup>3.5</sup>	R	√3	1	1	2.0	2.0	∞
<b>Test sample Related</b>									
Test Sample Positioning	E3.2.1	7.5	N	1	1	1	7.5	7.5	11
Device Holder Uncertainty	E3.1.1	6.5	N	1	1	1	6.5	6.5	8
Output Power Variation - SAR drift measurement	5.6.2	5.0	R	√3	1	1	2.9	2.9	∞
<b>Phantom and Tissue Parameters</b>									
Phantom Uncertainty (shape and thickness tolerances)	E2.1	4.0	R	√3	1	1	2.3	2.3	∞
Liquid Conductivity Target - tolerance	E2.2	5.0	R	√3	0.7	0.5	2.0	1.4	∞
Liquid Conductivity - measurement uncertainty	E2.2	4.0	R	√3	0.7	0.5	1.6	1.2	∞
Liquid Permittivity Target tolerance	E2.2	5.0	R	√3	0.6	0.5	1.7	1.4	∞
Liquid Permittivity - measurement uncertainty	E2.2	4.0	R	√3	0.6	0.5	1.4	1.2	∞
<b>Combined Standard Uncertainty</b>			RSS				14.3	14.2	
<b>Expanded Uncertainty</b> (95% confidence interval)							<b>28.5</b>	<b>28.3</b>	

- Assessed by ITI (UK) Competent Body, NVLAP (USA) Accreditation Body & ACA/AUSTEL (Australia), VCCI (Japan)
- Accredited by Industry Canada (Canada) under ACC-LAB (Europe/Canada MRA and APEC/Canada MRA)
- Recognized/Listed by FCC (USA)
- All test results contained in this engineering test report are traceable to National Institute of Standards and Technology (NIST)

**5.10.1.2. Measurement Uncertainty for System Performance Check**

<i>a</i>	<i>b</i>	<i>c</i>	<i>d</i>	<i>e = f(d,k)</i>	<i>f</i>	<i>g</i>	<i>h = c x f / e</i>	<i>i = c x g / e</i>	<i>k</i>
<b>Uncertainty</b>		<b>Tol.</b>	<b>Prob.</b>		<i>c<sub>i</sub></i>	<i>c<sub>i</sub></i>	<b>1-g</b>	<b>10-g</b>	<i>v<sub>i</sub></i>
<b>Component</b>	Sec.	(± %)	<b>Dist.</b>	<b>Div.</b>	<b>(1-g)</b>	<b>(10-g)</b>	<i>u<sub>i</sub></i> (±%)	<i>u<sub>i</sub></i> (±%)	<b>or v<sub>eff</sub></b>
<b>Measurement System</b>									
Probe Calibration	E1.1	3.0	N	1	1	1	3.0	3.0	∞
Axial Isotropy	E1.2	5.0	R	√3	0.7	0.7	2.0	2.0	∞
Hemispherical Isotropy	E1.2	8.0	R	√3	1	1	4.6	4.6	∞
Boundary Effect	E1.3	10.0	R	√3	1	1	5.8	5.8	∞
Linearity	E1.4	4.2	R	√3	1	1	2.4	2.4	∞
System Detection Limits	E1.5	2.0	R	√3	1	1	1.2	1.2	∞
Readout Electronics	E1.6	1.0	N	1	1	1	1.0	1.0	∞
Response Time	E1.7	1.5	R	√3	1	1	0.9	0.9	∞
Integration Time	E1.8	2.0	R	√3	1	1	1.2	1.2	∞
RF Ambient Conditions	E5.1	3.0	R	√3	1	1	1.7	1.7	∞
Probe Positioner Mechanical Tolerance	E5.2	0.4	R	√3	1	1	0.2	0.2	∞
Probe Positioning with respect to Phantom Shell	E5.3	3.0	R	√3	1	1	1.7	1.7	∞
Extrapolation, interpolation and Integration Algorithms for Max. SAR Evaluation	E4.2	3.5	R	√3	1	1	2.0	2.0	∞
<b>Dipole</b>									
Dipole Axis to Liquid Distance	7, X3.2	2.0	R	√3	1	1	1.2	1.2	∞
Input Power and SAR Drift Measurement	7, 5.6.2	3.0	R	√3	1	1	1.7	1.7	∞
<b>Phantom and Tissue Parameters</b>									
Phantom Uncertainty - shell thickness tolerance	E2.1	4.0	R	√3	1	1	2.3	2.3	∞
Liquid Conductivity – deviation from target values	E2.2	5.0	R	√3	0.7	0.5	2.0	1.4	∞
Liquid Conductivity - measurement uncertainty	E2.2	4.0	R	√3	0.7	0.5	1.6	1.2	∞
Liquid Permittivity – deviation from target values	E2.2	5.0	R	√3	0.6	0.5	1.7	1.4	∞
Liquid Permittivity - measurement uncertainty	E2.2	4.0	R	√3	0.6	0.5	1.4	1.2	∞
<b>Combined Standard Uncertainty</b>			RSS				10.0	9.9	
<b>Expanded Uncertainty</b> (95% confidence interval)							<b>20.1</b>	<b>19.8</b>	

**ULTRATECH GROUP OF LABS**

3000 Bristol Circle, Oakville, Ontario, Canada L6H 6G4  
 Tel. #: 905-829-1570, Fax. #: 905-829-8050, Email: vic@ultratech-labs.com, Website: http://www.ultratech-labs.com

**File #: ITS-006-SAR**  
**June 5, 2003**

- Assessed by ITI (UK) Competent Body, NVLAP (USA) Accreditation Body & ACA/AUSTEL (Australia), VCCI (Japan)
- Accredited by Industry Canada (Canada) under ACC-LAB (Europe/Canada MRA and APEC/Canada MRA)
- Recognized/Listed by FCC (USA)
- All test results contained in this engineering test report are traceable to National Institute of Standards and Technology (NIST)

## **EXHIBIT 6. SAR PRESCANS**

### **6.1.1. Body-Worn Configuration**

#### **6.1.1.1. Test configurations used**

Body-worn operating configurations should be tested with the belt-clips and holsters attached to the device and positioned against a flat phantom in normal use configurations. Devices with a headset output should be tested with a headset connected to the device. The D.U.T. was placed against the phantom and tested in its appropriate holster as would normally be used by the end user. If the SAR measured at the middle channel for each test is at least 32.0 dB lower than the SAR limit, testing at the high and low channels is optional for such test configuration(s).

If the transmission band of the test device is less than 10 MHz, testing at the high and low frequency channels is optional.

When multiple accessories that do not contain metallic components are supplied with the device, the device may be tested with only the accessory that dictates the closest spacing to the body. When multiple accessories that contain metallic components are supplied with the device, the device must be tested with each accessory that contains a unique metallic component. If multiple accessories share an identical metallic component (e.g., the same metallic belt-clip used with different holsters with no other metallic components), only the accessory that dictates the closest spacing to the body must be tested.

Body-worn accessories may not always be supplied or available as options for some devices that are intended to be authorized for body-worn use. A separation distance of 1.5 cm between the back of the device and a flat phantom is recommended for testing body-worn SAR compliance under such circumstances. Other separation distances may be used, but they should not exceed 2.5 cm. In these cases, the device may use body-worn accessories that provide a separation distance greater than that tested for the device provided however that the accessory contains no metallic components..

#### **6.1.1.2. Equipment permutation investigated for each orientation**

Three configurations, the front of the D.U.T. against the phantom with the tip of the antenna in contact, the rear of the D.U.T. against the phantom with the tip of the antenna in contact and the top of the D.U.T. against the phantom with the tip of the antenna in contact, were investigated in order to find the worst case exposure.

#### **6.1.1.3. Comments on non-tested configurations**

N/A

---

### **ULTRATECH GROUP OF LABS**

3000 Bristol Circle, Oakville, Ontario, Canada L6H 6G4  
Tel. #: 905-829-1570, Fax. #: 905-829-8050, Email: vic@ultratech-labs.com, Website: <http://www.ultratech-labs.com>

**File #: ITS-006-SAR**  
**June 5, 2003**

- Assessed by ITI (UK) Competent Body, NVLAP (USA) Accreditation Body & ACA/AUSTEL (Australia), VCCI (Japan)
- Accredited by Industry Canada (Canada) under ACC-LAB (Europe/Canada MRA and APEC/Canada MRA)
- Recognized/Listed by FCC (USA)
- All test results contained in this engineering test report are traceable to National Institute of Standards and Technology (NIST)

## 6.2. RECOMMENDED CAUTION STATEMENTS TO BE INCLUDED IN USERS MANUAL

In order for users to be aware of the body-worn operating requirements for meeting RF exposure compliance, operating instructions and caution statements should be included in the manual. The information should allow users to make informed decisions on the type of body-worn accessories and operating configurations that are appropriate for the device. The following are *examples* of typical statements that provide end-users with the necessary information about body-worn accessories:

Example 1. For a product that has the potential to be used in a body worn configuration and has been tested and certified with a specific accessory device(s):

“For body worn operation, this phone has been tested and meets the FCC RF exposure guidelines when used with the (*manufacturer name*) accessories supplied or designated for this product. Use of other accessories may not ensure compliance with FCC RF exposure guidelines.”

Example 2. For a product that has the potential to be used in a body worn configuration and has not been certified with a specific accessory device(s):

“For body worn operation, this phone has been tested and meets FCC RF exposure guidelines when used with an accessory that contains no metal and that positions the handset a minimum of (specified distance) from the body. Use of other accessories may not ensure compliance with FCC RF exposure guidelines.”

Example 3. For a product that has the potential to be used in a body worn configuration with future manufacturer designed accessories:

“For body worn operation, this phone has been tested and meets the FCC RF exposure guidelines when used with a (*manufacturer name*) accessory designated for this product or when used with an accessory that contains no metal and that positions the handset a minimum of (specified distance) from the body.”

---

### ULTRATECH GROUP OF LABS

3000 Bristol Circle, Oakville, Ontario, Canada L6H 6G4

Tel. #: 905-829-1570, Fax. #: 905-829-8050, Email: vic@ultratech-labs.com, Website: <http://www.ultratech-labs.com>

File #: ITS-006-SAR

June 5, 2003

- Assessed by ITI (UK) Competent Body, NVLAP (USA) Accreditation Body & ACA/AUSTEL (Australia), VCCI (Japan)
- Accredited by Industry Canada (Canada) under ACC-LAB (Europe/Canada MRA and APEC/Canada MRA)
- Recognized/Listed by FCC (USA)
- All test results contained in this engineering test report are traceable to National Institute of Standards and Technology (NIST)



**6.3. PRESCAN DATA FOR WORST CONFIGURATION OF RF EXPOSURE**

**6.3.1. Body-Worn (By stander) Configuration**

**6.3.1.1. 2.4 GHz**

Configuration	Antenna Position	Peak spatial-average SAR <sub>1g</sub> (W/kg)
Front edge of the lid of the host PC in contact with the phantom, 54 Mbps data rate, 21.3 dBm conducted, 0 mm separation	Integrated	Less than 0.01
Top side of the lid of the host PC in contact with the phantom, 54 Mbps data rate, 21.3 dBm conducted, 0 mm separation	Integrated	0.02
Top side of the lid of the host PC in contact with the phantom, 9 Mbps data rate, 20.3 dBm conducted, 0 mm separation	Integrated	Less than 0.01
Top side of the lid of the host PC in contact with the phantom, 11 Mbps data rate, 18.1 dBm conducted, 0 mm separation	Integrated	Less than 0.01
Top side of the lid of the host PC in contact with the phantom, 1 Mbps data rate, 18.1 dBm conducted, 0 mm separation	Integrated	Less than 0.01

**6.3.1.2. 5.24 GHz**

Configuration	Antenna Position	Peak spatial-average SAR <sub>1g</sub> (W/kg)
Front edge of the lid of the host PC in contact with the phantom, 36 Mbps data rate, 17.5 conducted, 0 mm separation	Integrated	Less than 0.01
Top side of the lid of the host PC in contact with the phantom, 36 Mbps data rate, 17.5 conducted, 0 mm separation	Integrated	Less than 0.01
Top side of the lid of the host PC in contact with the phantom, 9 Mbps data rate, 17.5 conducted, 0 mm separation	Integrated	Less than 0.01
Top side of the lid of the host PC in contact with the phantom, 54 Mbps data rate, 16.3 conducted, 0 mm separation	Integrated	Less than 0.01

Prescans for the feasible configurations had been performed in order to determine the worst case under the specific configurations as described in the above table.

- Assessed by ITI (UK) Competent Body, NVLAP (USA) Accreditation Body & ACA/AUSTEL (Australia), VCCI (Japan)
- Accredited by Industry Canada (Canada) under ACC-LAB (Europe/Canada MRA and APEC/Canada MRA)
- Recognized/Listed by FCC (USA)
- All test results contained in this engineering test report are traceable to National Institute of Standards and Technology (NIST)

**SPECIFIC ABSORPTION RATE (SAR)**

IEEE C95.1-1991, FCC OET Bulletin 65 (Supplement C), Industry Canada RSS-102(Issue 1) and ACA Radiocommunications (Electromagnetic Radiation – Human Exposure) Amendment Standard 2000 (No. 1)

**Wireless LAN Card M/N: ISL3900M**



**ULTRATECH GROUP OF LABS**

3000 Bristol Circle, Oakville, Ontario, Canada L6H 6G4  
Tel. #: 905-829-1570, Fax. #: 905-829-8050, Email: vic@ultratech-labs.com, Website: http://www.ultratech-labs.com

**File #: ITS-006-SAR**  
**June 5, 2003**

- Assessed by ITI (UK) Competent Body, NVLAP (USA) Accreditation Body & ACA/AUSTEL (Australia), VCCI (Japan)
- Accredited by Industry Canada (Canada) under ACC-LAB (Europe/Canada MRA and APEC/Canada MRA)
- Recognized/Listed by FCC (USA)
- All test results contained in this engineering test report are traceable to National Institute of Standards and Technology (NIST)

## EXHIBIT 7. SAR MEASUREMENT

### 7.1. BODY-WORN (BY STANDER) CONFIGURATION

#### 7.1.1. Top of the lid of the host PC in contact with the phantom\*

#	Configuration	Device Test Positions	Antenna Position	Freq. [MHz]	Channel	Ref. SAR Before [W/Kg]	Ref. SAR After [W/Kg]	MAX 1g SAR [W/Kg]
01	2.4 GHz DSSS 54 Mbps data rate 21.3 [dBm] conducted Top side of the lid of the host PC in contact with the phantom 0 mm separation	0 mm	Integrated	2412	01			
02		0 mm	Integrated	2437	06	0.01	0.01 (-0.0 %)	0.02
03		0 mm	Integrated	2462	11			
04	5 GHz OFDM 36 Mbps data rate 17.5 [dBm] conducted Top side of the lid of the host PC in contact with the phantom 0 mm separation	0 mm	Integrated	5180	36			
05		0 mm	Integrated	5260	52	0.00	0.00 (-0.0 %)	Less than 0.01**
06		0 mm	Integrated	5320	64			



\* If the SAR measured at the middle channel for each test configuration is at least 3.0 dB lower than the SAR limit, testing at the high and low channels is optional for such test configuration(s).

\*\* It was found to be below the SAR measurement system's sensitivity (less than 0.01 [W/Kg]).

### ULTRATECH GROUP OF LABS

3000 Bristol Circle, Oakville, Ontario, Canada L6H 6G4  
Tel. #: 905-829-1570, Fax. #: 905-829-8050, Email: vic@ultratech-labs.com, Website: http://www.ultratech-labs.com

**File #: ITS-006-SAR**  
**June 5, 2003**

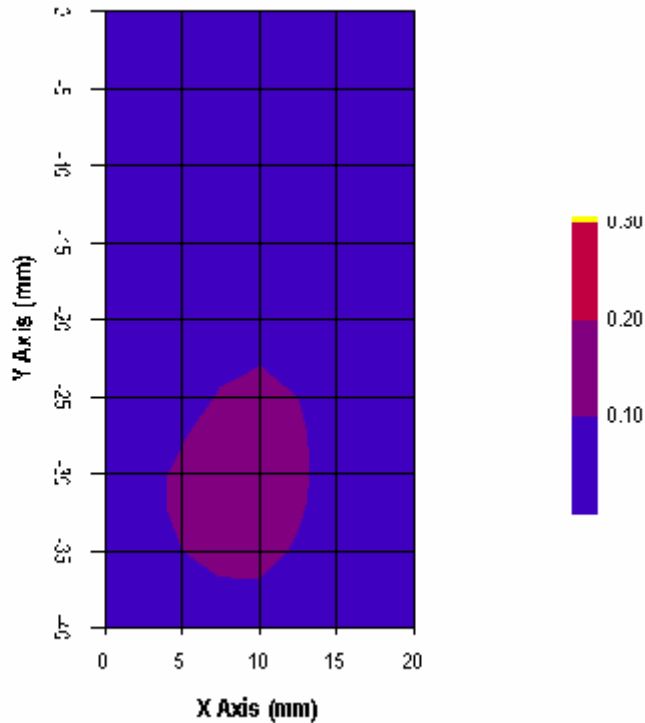
- Assessed by ITI (UK) Competent Body, NVLAP (USA) Accreditation Body & ACA/AUSTEL (Australia), VCCI (Japan)
- Accredited by Industry Canada (Canada) under ACC-LAB (Europe/Canada MRA and APEC/Canada MRA)
- Recognized/Listed by FCC (USA)
- All test results contained in this engineering test report are traceable to National Institute of Standards and Technology (NIST)

**SPECIFIC ABSORPTION RATE (SAR)**

IEEE C95.1-1991, FCC OET Bulletin 65 (Supplement C), Industry Canada RSS-102(Issue 1) and ACA Radiocommunications (Electromagnetic Radiation – Human Exposure) Amendment Standard 2000 (No. 1)

**Wireless LAN Card M/N: ISL39000M****7.1.1.1. 2437 MHz**

Test date [MM/DD/YYYY]	05/22/2003
Test by	JaeWook Choi
Room temperature [°C]	22
Room humidity [%]	30
Simulated tissue temperature [°C]	22
Separation distance, d [mm]	0
Test frequency [MHz]	2437
E-field Probe	M/N: E-TR, S/N: UT-0200-1, Sensor Offset: 2.0 mm
Sensor Factor ( $\eta_{Pd}$ ) [mV/(mW/cm <sup>2</sup> )]	10.8
Amplifier Settings (AS <sub>1</sub> , AS <sub>2</sub> , AS <sub>3</sub> )	0.00660854, 0.00622568, 0.008540925
Tissue Type	Muscle
Measured conductivity [S/m]	1.95 (0.0 %)
Measured dielectric constant	54.6 (+3.6 %)
Conversion Factor ( $\gamma$ )	4.028
Sensitivity ( $\zeta$ ) [W/Kg/mV]	1.690E-01
Power [dBm]	21.3 conducted
Measurement Volume Specification (X × Y × Z)	5 pts × 5 pts × 9 pts, 16 mm × 16 mm × 32 mm; Resolution: 4 mm × 4 mm × 4 mm
SAR <sub>1g</sub> [W/Kg]	0.02

**ULTRATECH GROUP OF LABS**

3000 Bristol Circle, Oakville, Ontario, Canada L6H 6G4  
 Tel. #: 905-829-1570, Fax. #: 905-829-8050, Email: vic@ultratech-labs.com, Website: http://www.ultratech-labs.com

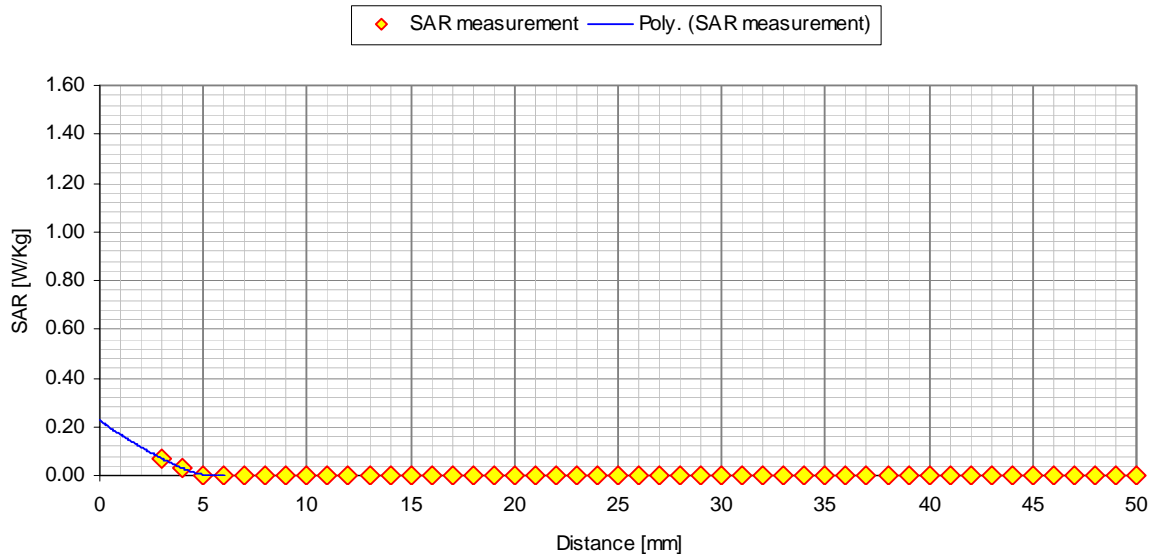
File #: ITS-006-SAR  
 June 5, 2003

- Assessed by ITI (UK) Competent Body, NVLAP (USA) Accreditation Body & ACA/AUSTEL (Australia), VCCI (Japan)
- Accredited by Industry Canada (Canada) under ACC-LAB (Europe/Canada MRA and APEC/Canada MRA)
- Recognized/Listed by FCC (USA)
- All test results contained in this engineering test report are traceable to National Institute of Standards and Technology (NIST)

**SPECIFIC ABSORPTION RATE (SAR)**

IEEE C95.1-1991, FCC OET Bulletin 65 (Supplement C), Industry Canada RSS-102(Issue 1) and ACA Radiocommunications (Electromagnetic Radiation – Human Exposure) Amendment Standard 2000 (No. 1)

**Wireless LAN Card M/N: ISL39000M**



**ULTRATECH GROUP OF LABS**

3000 Bristol Circle, Oakville, Ontario, Canada L6H 6G4  
Tel. #: 905-829-1570, Fax. #: 905-829-8050, Email: vic@ultratech-labs.com, Website: http://www.ultratech-labs.com

File #: ITS-006-SAR  
June 5, 2003

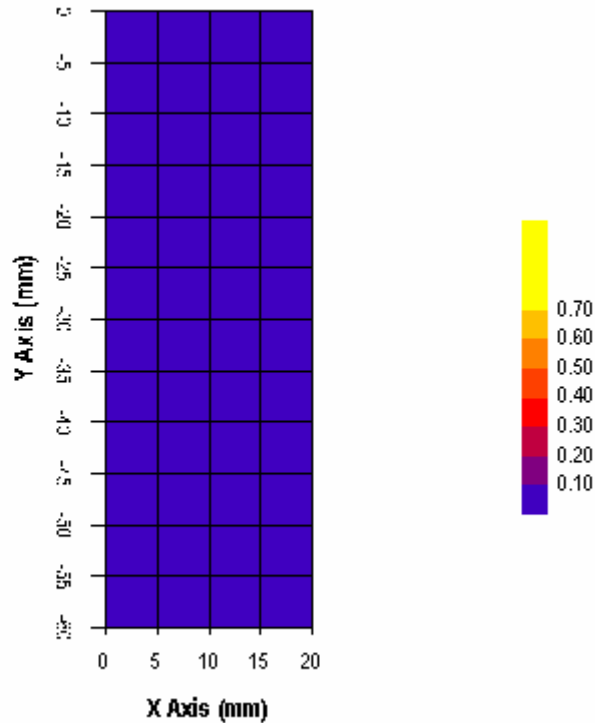
- Assessed by ITI (UK) Competent Body, NVLAP (USA) Accreditation Body & ACA/AUSTEL (Australia), VCCI (Japan)
- Accredited by Industry Canada (Canada) under ACC-LAB (Europe/Canada MRA and APEC/Canada MRA)
- Recognized/Listed by FCC (USA)
- All test results contained in this engineering test report are traceable to National Institute of Standards and Technology (NIST)

**SPECIFIC ABSORPTION RATE (SAR)**

IEEE C95.1-1991, FCC OET Bulletin 65 (Supplement C), Industry Canada RSS-102(Issue 1) and ACA Radiocommunications (Electromagnetic Radiation – Human Exposure) Amendment Standard 2000 (No. 1)

**Wireless LAN Card M/N: ISL39000M****7.1.1.2. 5260 MHz**

Test date [MM/DD/YYYY]	05/23/2003
Test by	JaeWook Choi
Room temperature [°C]	22
Room humidity [%]	30
Simulated tissue temperature [°C]	22
Separation distance, d [mm]	0
Test frequency [MHz]	5260
E-field Probe	M/N: E-TR, S/N: UT-0200-1, Sensor Offset: 2.0 mm
Sensor Factor ( $\eta_{Pd}$ ) [mV/(mW/cm <sup>2</sup> )]	10.8
Amplifier Settings (AS <sub>1</sub> , AS <sub>2</sub> , AS <sub>3</sub> )	0.00596768, 0.00563160, 0.00779221
Tissue Type	Muscle
Measured conductivity [S/m]	5.56 (3.0 %)
Measured dielectric constant	47.3 (-2.5 %)
Conversion Factor ( $\gamma$ )	2.721
Sensitivity ( $\zeta$ ) [W/Kg/mV]	7.133E-01
Power [dBm]	17.5 conducted
Measurement Volume Specification (X × Y × Z)	5 pts × 5 pts × 13 pts, 12 mm × 12 mm × 12 mm; Resolution: 3 mm × 3 mm × 1 mm
SAR <sub>1g</sub> [W/Kg]	Less than 0.01

**ULTRATECH GROUP OF LABS**

3000 Bristol Circle, Oakville, Ontario, Canada L6H 6G4  
 Tel. #: 905-829-1570, Fax. #: 905-829-8050, Email: vic@ultratech-labs.com, Website: http://www.ultratech-labs.com

File #: ITS-006-SAR  
 June 5, 2003

- Assessed by ITI (UK) Competent Body, NVLAP (USA) Accreditation Body & ACA/AUSTEL (Australia), VCCI (Japan)
- Accredited by Industry Canada (Canada) under ACC-LAB (Europe/Canada MRA and APEC/Canada MRA)
- Recognized/Listed by FCC (USA)
- All test results contained in this engineering test report are traceable to National Institute of Standards and Technology (NIST)

## EXHIBIT 8. TISSUE DIELECTRIC PARAMETER CALIBRATION

The tissue conductivity was calibrated in accordance with IEEE Std 1528-200X, Draft 6.1 November 14, 2000, Sponsor IEEE SCC 34

<b>Tissue calibration type</b>	HP Dielectric Strength Probe System (M/N: 85070C)		
<b>Tissue calibration date</b> [MM/DD/YYYY]	05/22/2003	05/22/2003	05/23/2003
<b>Tissue calibrated by</b>	JaeWook Choi	JaeWook Choi	JaeWook Choi
<b>Room temperature</b> [°C]	22	22	22
<b>Room humidity</b> [%]	30	30	30
<b>Simulated tissue temperature</b> [°C]	20	22	22
<b>Tissue calibration frequency</b> [MHz]	2450	2450	5240
<b>Tissue Type</b>	Brain	Muscle	Muscle
<b>Target conductivity</b> [S/m]	1.80	1.95	5.40
<b>Target dielectric constant</b>	39.2	52.7	48.5
<b>Composition (by weight)</b> [%]	DI Water (59.70 %) DGBE (4.76 %) Salt (0.50 %) Triton X-100 (35.04 %)	DI Water (76.19 %) DGBE (9.52 %) Triton X-100 (14.29 %)	DI Water (77.67 %) DGBE (2.91 %) Triton X-100 (19.42 %)
<b>Measured conductivity</b> [S/m]	1.81 (+0.6 %)	1.95 (0.0 %)	5.56 (+3.0 %)
<b>Measured dielectric constant</b>	39.8 (+1.5 %)	54.6 (+3.6 %)	47.3 (-2.5 %)
<b>Penetration depth (plane wave excitation)</b> [mm]	18.8	20.3	6.7

### ULTRATECH GROUP OF LABS

3000 Bristol Circle, Oakville, Ontario, Canada L6H 6G4  
 Tel. #: 905-829-1570, Fax. #: 905-829-8050, Email: vic@ultratech-labs.com, Website: http://www.ultratech-labs.com

**File #: ITS-006-SAR**  
**June 5, 2003**

- Assessed by ITI (UK) Competent Body, NVLAP (USA) Accreditation Body & ACA/AUSTEL (Australia), VCCI (Japan)
- Accredited by Industry Canada (Canada) under ACC-LAB (Europe/Canada MRA and APEC/Canada MRA)
- Recognized/Listed by FCC (USA)
- All test results contained in this engineering test report are traceable to National Institute of Standards and Technology (NIST)

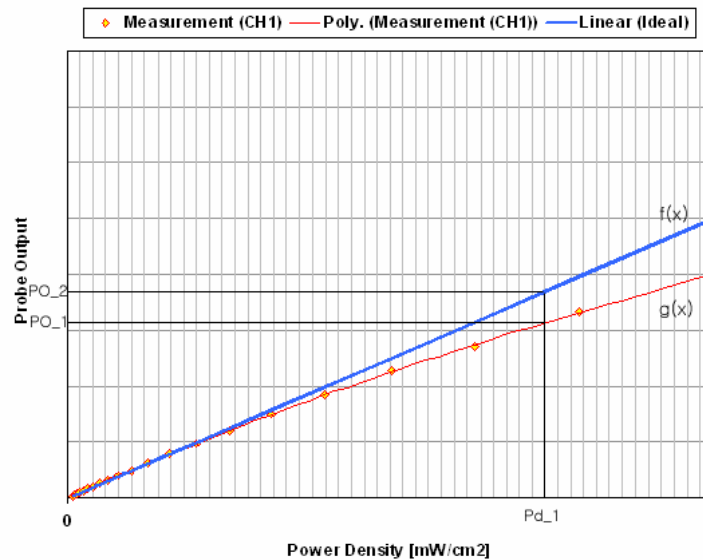
## EXHIBIT 9. SAR SYSTEM CALIBRATION

### 9.1. GENERAL INFORMATION OF THE PROBE

<b>Probe Type</b>	E-Field Triangle, Isotropic
<b>Model Number</b>	E-TR
<b>Serial Number</b>	UT-0200-01
<b>Manufacturer</b>	3D-EMC Laboratory Inc.
<b>Manufactured Date</b>	February 2000
<b>Probe Length</b> [mm]	270
<b>Probe offset</b> [mm]	2.0
<b>Probe Tip diameter</b> [mm]	4.0
<b>Sensor Factor (<math>\eta_{Pd}</math>)</b> [mV/(mW/cm <sup>2</sup> )]	10.8
<b>Sensor Factor (<math>\eta_{E2}</math>)</b> [mV/(V/m) <sup>2</sup> ]	10.8 / 3770

### 9.2. PROBE LINEARITY AND DYNAMIC RANGE

Each channel of the probe output over the range of the generated field’s power density is recorded and stored as a diode compensation table to yield the polynomial equations, using the curve fitting algorithm, for the ideal diode response (linear) and the saturated diode response (the 3<sup>rd</sup> order). The linear equation and the inverse of the 3<sup>rd</sup> order polynomial equation are used to compensate for the saturated diode response to the ideal diode response.



For example, Provided that linear equation, f, the 3<sup>rd</sup> order polynomial equation, g, and its inverse, g<sup>-1</sup>, the saturated diode output PO<sub>1</sub> can be compensated to the ideal diode output PO<sub>2</sub> by the calculation as shown below.

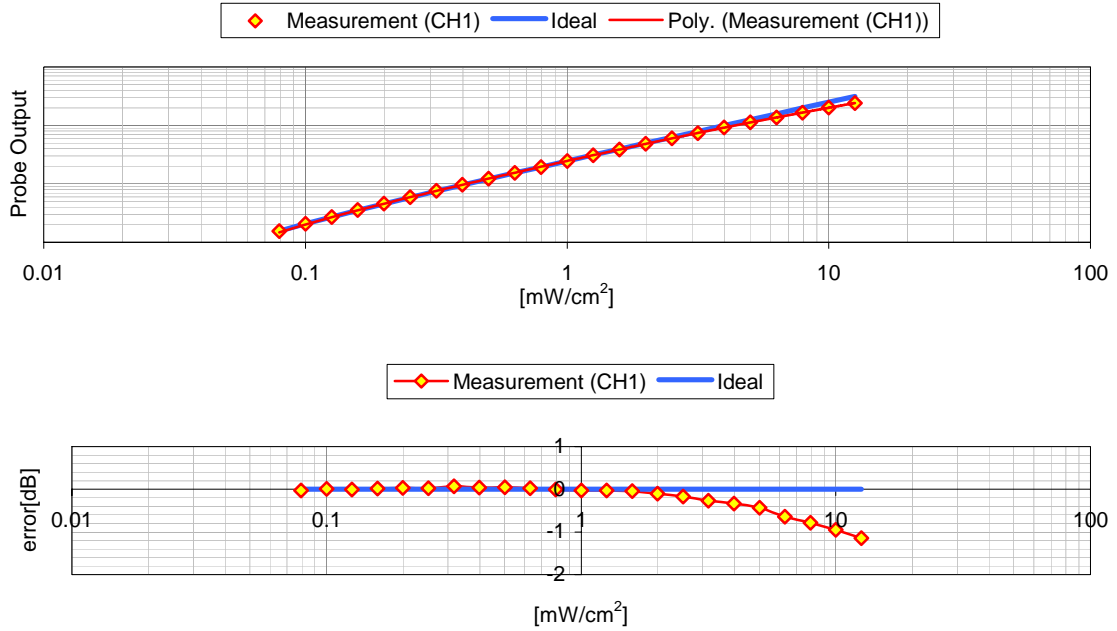
$$Pd_1 = g^{-1}(PO_1),$$

$$PO_2 = f(Pd_1) = f(g^{-1}(PO_1))$$

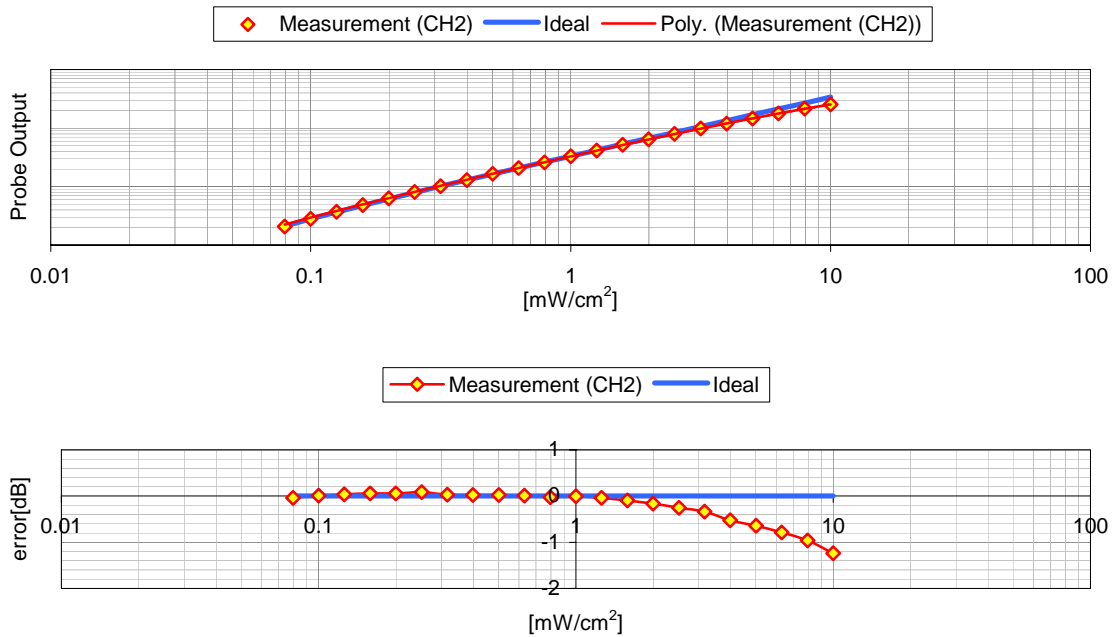
- Assessed by ITI (UK) Competent Body, NVLAP (USA) Accreditation Body & ACA/AUSTEL (Australia), VCCI (Japan)
- Accredited by Industry Canada (Canada) under ACC-LAB (Europe/Canada MRA and APEC/Canada MRA)
- Recognized/Listed by FCC (USA)
- All test results contained in this engineering test report are traceable to National Institute of Standards and Technology (NIST)



**9.2.1. Channel 1**



**9.2.2. Channel 2**



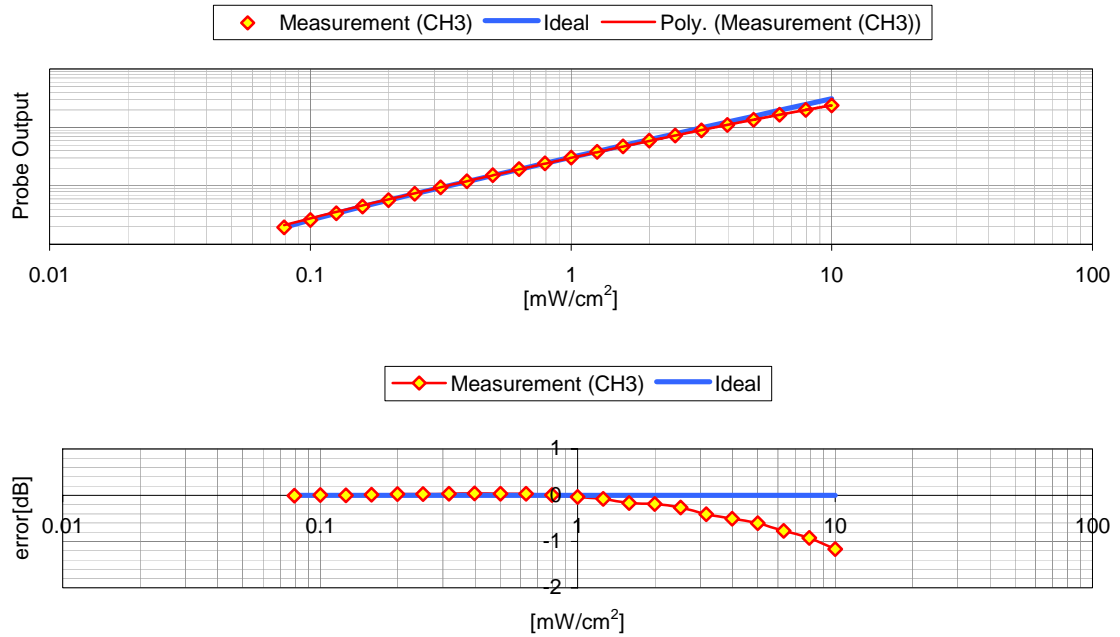
**ULTRATECH GROUP OF LABS**

3000 Bristol Circle, Oakville, Ontario, Canada L6H 6G4  
 Tel. #: 905-829-1570, Fax. #: 905-829-8050, Email: vic@ultratech-labs.com, Website: http://www.ultratech-labs.com

**File #: ITS-006-SAR**  
**June 5, 2003**

- Assessed by ITI (UK) Competent Body, NVLAP (USA) Accreditation Body & ACA/AUSTEL (Australia), VCCI (Japan)
- Accredited by Industry Canada (Canada) under ACC-LAB (Europe/Canada MRA and APEC/Canada MRA)
- Recognized/Listed by FCC (USA)
- All test results contained in this engineering test report are traceable to National Institute of Standards and Technology (NIST)

**9.2.3. Channel 3**



**ULTRATECH GROUP OF LABS**

3000 Bristol Circle, Oakville, Ontario, Canada L6H 6G4  
Tel. #: 905-829-1570, Fax. #: 905-829-8050, Email: vic@ultratech-labs.com, Website: http://www.ultratech-labs.com

**File #: ITS-006-SAR**  
**June 5, 2003**

- Assessed by ITI (UK) Competent Body, NVLAP (USA) Accreditation Body & ACA/AUSTEL (Australia), VCCI (Japan)
- Accredited by Industry Canada (Canada) under ACC-LAB (Europe/Canada MRA and APEC/Canada MRA)
- Recognized/Listed by FCC (USA)
- All test results contained in this engineering test report are traceable to National Institute of Standards and Technology (NIST)

### 9.3. PROBE FREE SPACE CALIBRATION

#### 9.3.1. Calibration Setup

##### 9.3.1.1. 2.45 GHz

Calibration cell type	Waveguide
Model Number	13492
Serial Number	12463-1, 12463-2
Manufacturer	APOLLO
Input Power / Power Density $_{[mW/(mW/cm^2)] @ 2450 [MHz]}$	24.7

##### 9.3.1.2. 5.24 GHz

Calibration cell type	Waveguide
Model Number	11457-2
Serial Number	CO-05721-01, CO-05721-02
Manufacturer	APOLLO
Input Power / Power Density $_{[mW/(mW/cm^2)] @ 5240 [MHz]}$	2.794

#### 9.3.2. Amplifier Settings

##### 9.3.2.1. 2.45 GHz

Calibration Date $_{[MM/DD/YYYY]}$	09/23/2002
Calibrated by	JaeWook Choi
Calibration Frequency $_{[MHz]}$	2450
Room Temperature $_{[°C]}$	24
Room Humidity $_{[%]}$	50
$\phi$ $_{[°]}$	90
$\theta_1, \theta_2, \theta_3$ $_{[°]}$	54.7, 54.7, 54.7
$Pd$ $_{[mW/cm^2]}$	2.0
$V_{max1}$	2,179
$V_{max2}$	2,313
$V_{max3}$	1,686
$AS_1$	0.00660854
$AS_2$	0.00622568
$AS_3$	0.00854093

##### 9.3.2.2. 5.24 GHz

Calibration Date $_{[MM/DD/YYYY]}$	07/31/2002
Calibrated by	JaeWook Choi
Calibration Frequency $_{[MHz]}$	5,240
Room Temperature $_{[°C]}$	24
Room Humidity $_{[%]}$	30
$\phi$ $_{[°]}$	90
$\theta_1, \theta_2, \theta_3$ $_{[°]}$	54.7, 54.7, 54.7

### ULTRATECH GROUP OF LABS

3000 Bristol Circle, Oakville, Ontario, Canada L6H 6G4  
 Tel. #: 905-829-1570, Fax. #: 905-829-8050, Email: vic@ultratech-labs.com, Website: http://www.ultratech-labs.com

File #: ITS-006-SAR  
 June 5, 2003

- Assessed by ITI (UK) Competent Body, NVLAP (USA) Accreditation Body & ACA/AUSTEL (Australia), VCCI (Japan)
- Accredited by Industry Canada (Canada) under ACC-LAB (Europe/Canada MRA and APEC/Canada MRA)
- Recognized/Listed by FCC (USA)
- All test results contained in this engineering test report are traceable to National Institute of Standards and Technology (NIST)

**SPECIFIC ABSORPTION RATE (SAR)**

IEEE C95.1-1991, FCC OET Bulletin 65 (Supplement C), Industry Canada RSS-102(Issue 1) and ACA Radiocommunications (Electromagnetic Radiation – Human Exposure) Amendment Standard 2000 (No. 1)

**Wireless LAN Card M/N: ISL39000M**

<b>Pd</b> [mW/cm <sup>2</sup> ]	2.0
<b>V<sub>max1</sub></b>	2413
<b>V<sub>max2</sub></b>	2557
<b>V<sub>max3</sub></b>	1848
<b>AS<sub>1</sub></b>	0.00596768
<b>AS<sub>2</sub></b>	0.00563160
<b>AS<sub>3</sub></b>	0.00779221

**ULTRATECH GROUP OF LABS**

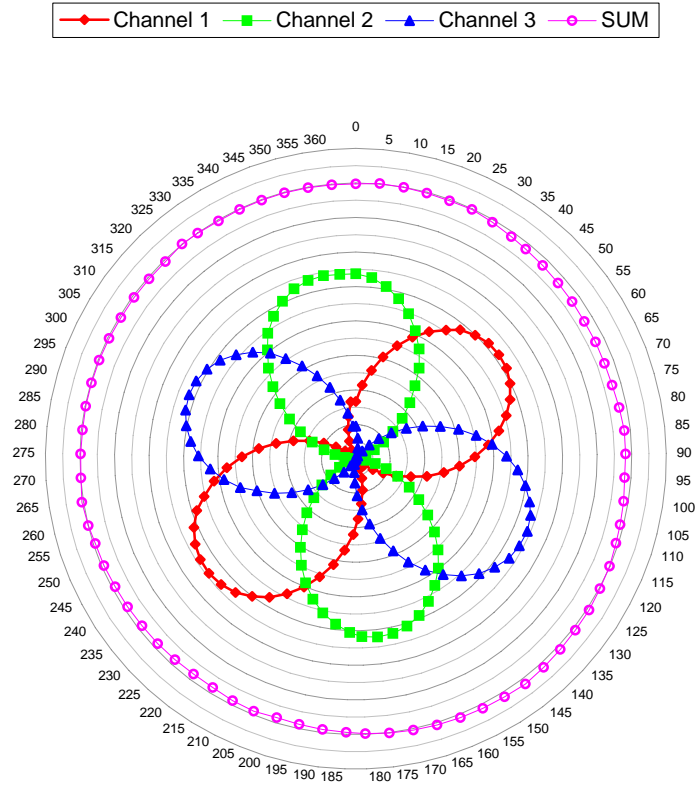
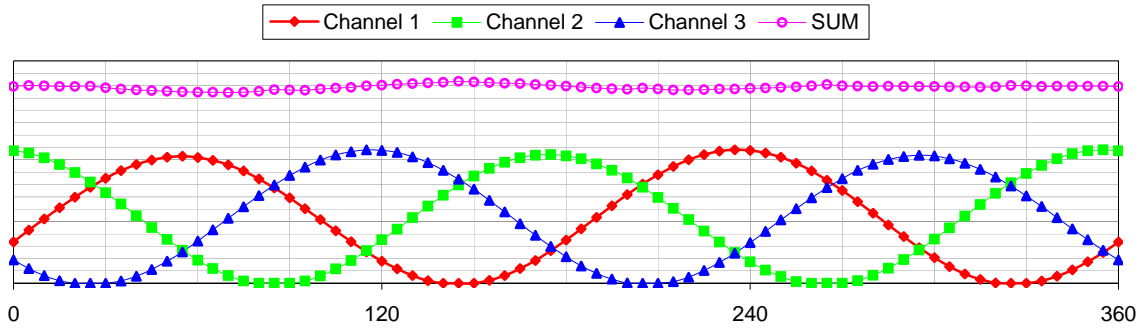
3000 Bristol Circle, Oakville, Ontario, Canada L6H 6G4

Tel. #: 905-829-1570, Fax. #: 905-829-8050, Email: vic@ultratech-labs.com, Website: http://www.ultratech-labs.com

**File #: ITS-006-SAR****June 5, 2003**

- Assessed by ITI (UK) Competent Body, NVLAP (USA) Accreditation Body & ACA/AUSTEL (Australia), VCCI (Japan)
- Accredited by Industry Canada (Canada) under ACC-LAB (Europe/Canada MRA and APEC/Canada MRA)
- Recognized/Listed by FCC (USA)
- *All test results contained in this engineering test report are traceable to National Institute of Standards and Technology (NIST)*

**9.3.3. Isotropic response**



**ULTRATECH GROUP OF LABS**

3000 Bristol Circle, Oakville, Ontario, Canada L6H 6G4  
Tel. #: 905-829-1570, Fax. #: 905-829-8050, Email: vic@ultratech-labs.com, Website: http://www.ultratech-labs.com

**File #: ITS-006-SAR**  
**June 5, 2003**

- Assessed by ITI (UK) Competent Body, NVLAP (USA) Accreditation Body & ACA/AUSTEL (Australia), VCCI (Japan)
- Accredited by Industry Canada (Canada) under ACC-LAB (Europe/Canada MRA and APEC/Canada MRA)
- Recognized/Listed by FCC (USA)
- All test results contained in this engineering test report are traceable to National Institute of Standards and Technology (NIST)

## 9.4. PROBE THERMAL TRANSFER CALIBRATION

### 9.4.1. 2.45 GHz

#### 9.4.1.1. Calibration Setup

<b>Calibration type</b>	Thermal transfer calibration
<b>Flat phantom dimension (W × L × H) [mm]</b>	420 × 700 × 200
<b>Flat phantom shell thickness (d<sub>3</sub>) [mm]</b>	2.0
<b>Flat phantom shell permittivity</b>	2.98
<b>Calibration dipole dimension (L × h × d) [mm]</b>	51.7 × 30.4 × 3.6
<b>Sensor-to-Phantom (d<sub>1</sub>) [mm]</b>	5.0
<b>Dipole-to-Phantom (d<sub>2</sub>) [mm]</b>	8.0
<b>Sensor-to-Dipole (d<sub>1</sub> + d<sub>2</sub> + d<sub>3</sub>) [mm]</b>	15.0 (5.0 + 8.0 + 2.0)
<b>Return Loss (at test frequency) [dB]</b>	-24.0

#### 9.4.1.2. Simulated Tissue

<b>Tissue calibration type</b>	HP Dielectric Strength Probe System	
<b>Tissue calibration date [MM/DD/YYYY]</b>	09/23/2002	09/23/2002
<b>Tissue calibrated by</b>	JaeWook Choi	JaeWook Choi
<b>Room temperature [°C]</b>	24	24
<b>Room humidity [%]</b>	50	50
<b>Simulated tissue temperature [°C]</b>	24	24
<b>Tissue calibration frequency [MHz]</b>	2450	2450
<b>Tissue Type</b>	Brain	Muscle
<b>Target conductivity [S/m]</b>	1.80	1.95
<b>Target dielectric constant</b>	39.2	52.7
<b>Specific Heat Capacity [J/Kg/°C]</b>	3,702	3,979
<b>Mass Density [Kg/m<sup>3</sup>]</b>	1,016	1,004
<b>Measured conductivity [S/m]</b>	1.88 (+4.6 %)	1.91 (-2.1 %)
<b>Measured dielectric constant</b>	37.6 (-4.0 %)	55.5 (+5.0 %)
<b>Penetration depth (plane wave excitation) [mm]</b>	17.6	20.9

## ULTRATECH GROUP OF LABS

3000 Bristol Circle, Oakville, Ontario, Canada L6H 6G4  
 Tel. #: 905-829-1570, Fax. #: 905-829-8050, Email: vic@ultratech-labs.com, Website: http://www.ultratech-labs.com

**File #: ITS-006-SAR**  
**June 5, 2003**

- Assessed by ITI (UK) Competent Body, NVLAP (USA) Accreditation Body & ACA/AUSTEL (Australia), VCCI (Japan)
- Accredited by Industry Canada (Canada) under ACC-LAB (Europe/Canada MRA and APEC/Canada MRA)
- Recognized/Listed by FCC (USA)
- All test results contained in this engineering test report are traceable to National Institute of Standards and Technology (NIST)

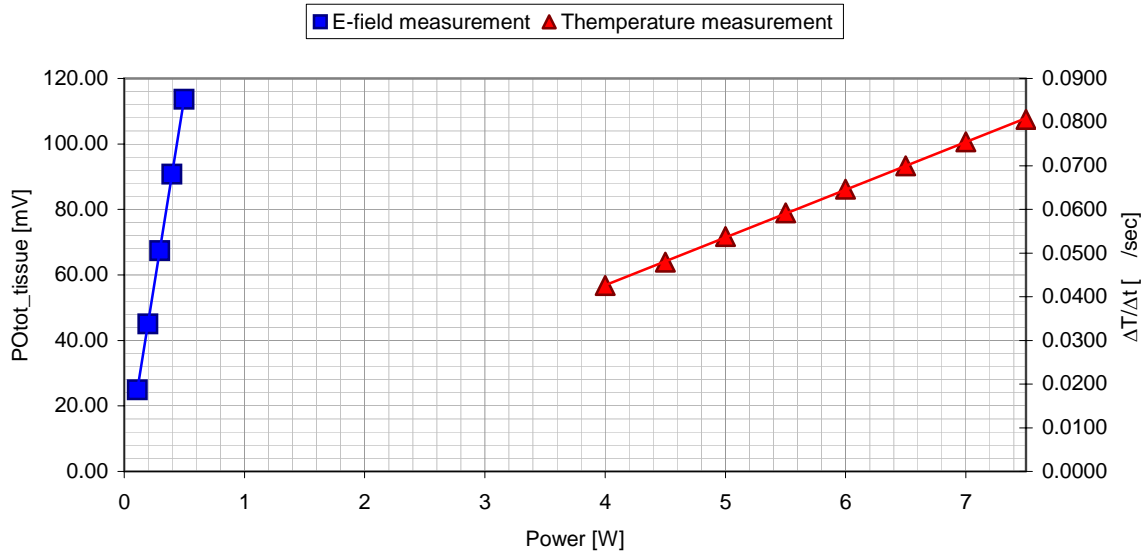
**SPECIFIC ABSORPTION RATE (SAR)**

IEEE C95.1-1991, FCC OET Bulletin 65 (Supplement C), Industry Canada RSS-102(Issue 1) and ACA Radiocommunications (Electromagnetic Radiation – Human Exposure) Amendment Standard 2000 (No. 1)

**Wireless LAN Card M/N: ISL39000M**

**9.4.1.3. Conversion Factor for brain tissue**

<b>Calibration Date</b> [MM/DD/YYYY]	09/25/2002
<b>Calibration by</b>	JaeWook Choi
<b>Calibration Frequency</b> [MHz]	2450
<b>Room Temperature</b> [°C]	24
<b>Room Humidity</b> [%]	45
<b>Simulated Tissue Temperature</b> [°C]	24
<b>PO<sub>tot_tissue</sub></b> [mV]	24.914 @ 0.11 [W] 45.029 @ 0.20 [W] 67.429 @ 0.30 [W] 90.743 @ 0.40 [W] 113.600 @ 0.50 [W]
<b>δ(PO<sub>tot_tissue</sub>)/δP</b> [mV/W]	2210.9371429
<b>ΔT/Δt</b> [°C/sec]	0.04255 @ 4.0 [W] 0.04791 @ 4.5 [W] 0.05381 @ 5.0 [W] 0.05921 @ 5.5 [W] 0.06463 @ 6.0 [W] 0.06998 @ 6.5 [W] 0.07551 @ 7.0 [W] 0.08063 @ 7.5 [W]
<b>δ(ΔT/Δt)/δP</b> [°C/sec/W]	0.01091643
<b>Conversion Factor (γ)</b>	3.653



**ULTRATECH GROUP OF LABS**

3000 Bristol Circle, Oakville, Ontario, Canada L6H 6G4  
 Tel. #: 905-829-1570, Fax. #: 905-829-8050, Email: vic@ultratech-labs.com, Website: http://www.ultratech-labs.com

File #: ITS-006-SAR  
 June 5, 2003

- Assessed by ITI (UK) Competent Body, NVLAP (USA) Accreditation Body & ACA/AUSTEL (Australia), VCCI (Japan)
- Accredited by Industry Canada (Canada) under ACC-LAB (Europe/Canada MRA and APEC/Canada MRA)
- Recognized/Listed by FCC (USA)
- All test results contained in this engineering test report are traceable to National Institute of Standards and Technology (NIST)

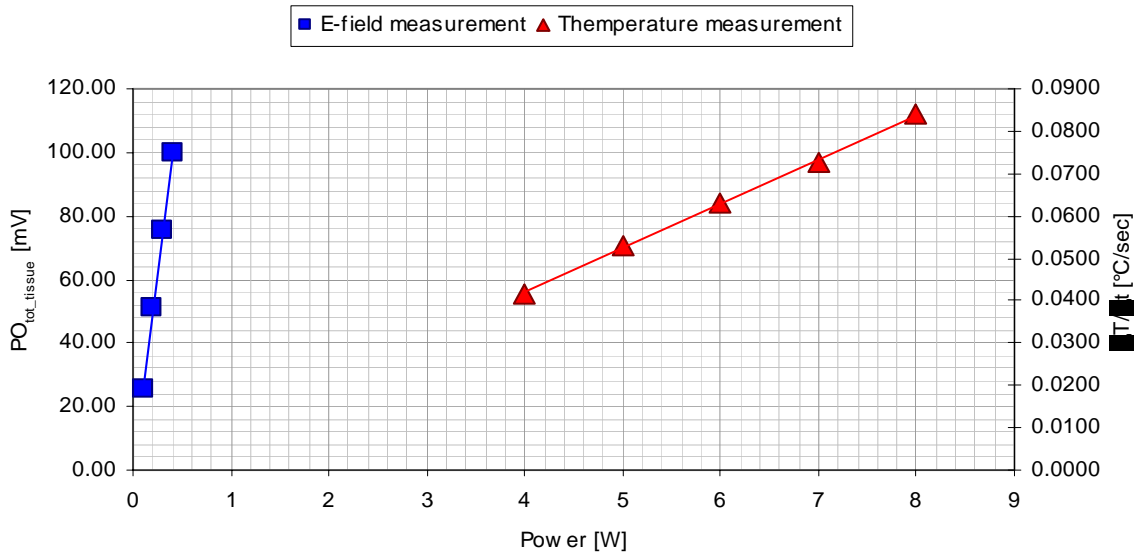
**SPECIFIC ABSORPTION RATE (SAR)**

IEEE C95.1-1991, FCC OET Bulletin 65 (Supplement C), Industry Canada RSS-102(Issue 1) and ACA Radiocommunications (Electromagnetic Radiation – Human Exposure) Amendment Standard 2000 (No. 1)

Wireless LAN Card M/N: ISL39000M

**9.4.1.4. Conversion Factor for muscle tissue**

<b>Calibration Date</b> [MM/DD/YYYY]	09/25/2002	
<b>Calibration by</b>	JaeWook Choi	
<b>Calibration Frequency</b> [MHz]	2450	
<b>Room Temperature</b> [°C]	24	
<b>Room Humidity</b> [%]	45	
<b>Simulated Tissue Temperature</b> [°C]	24	
<b>PO<sub>tot_tissue</sub></b> [mV]	25.569	@ 0.10 [W]
	51.166	@ 0.20 [W]
	75.544	@ 0.30 [W]
	99.802	@ 0.40 [W]
<b>δ(PO<sub>tot_tissue</sub>)/δP</b> [mV/W]	251.2469333	
<b>ΔT/Δt</b> [°C/sec]	0.04164	@ 4.0 [W]
	0.05296	@ 5.0 [W]
	0.06284	@ 6.0 [W]
	0.07272	@ 7.0 [W]
	0.08398	@ 8.0 [W]
<b>δ(ΔT/Δt)/δP</b> [°C/sec/W]	0.010444000	
<b>Conversion Factor (γ)</b>	4.028	



**ULTRATECH GROUP OF LABS**

3000 Bristol Circle, Oakville, Ontario, Canada L6H 6G4  
 Tel. #: 905-829-1570, Fax. #: 905-829-8050, Email: vic@ultratech-labs.com, Website: http://www.ultratech-labs.com

File #: ITS-006-SAR  
 June 5, 2003

- Assessed by ITI (UK) Competent Body, NVLAP (USA) Accreditation Body & ACA/AUSTEL (Australia), VCCI (Japan)
- Accredited by Industry Canada (Canada) under ACC-LAB (Europe/Canada MRA and APEC/Canada MRA)
- Recognized/Listed by FCC (USA)
- All test results contained in this engineering test report are traceable to National Institute of Standards and Technology (NIST)



**9.4.2. 5.24 GHz**

**9.4.2.1. Calibration Setup**

<b>Calibration type</b>	Thermal transfer calibration
<b>Flat phantom dimension (W × L × H) [mm]</b>	420 × 700 × 200
<b>Flat phantom shell thickness (d<sub>3</sub>) [mm]</b>	2.0
<b>Flat phantom shell permittivity</b>	2.98
<b>Calibration dipole dimension (L × h × d) [mm]</b>	25.1 × 13.4 × 3.6
<b>Sensor-to-Phantom (d<sub>1</sub>) [mm]</b>	5.0
<b>Dipole-to-Phantom (d<sub>2</sub>) [mm]</b>	8.0
<b>Sensor-to-Dipole (d<sub>1</sub> + d<sub>2</sub> + d<sub>3</sub>) [mm]</b>	15.0 (5.0 + 8.0 + 2.0)
<b>Return Loss (at test frequency) [dB]</b>	-21.0

**9.4.2.2. Simulated Tissue**

<b>Tissue calibration type</b>	HP Dielectric Strength Probe System
<b>Tissue calibration date [MM/DD/YYYY]</b>	07/31/2002
<b>Tissue calibrated by</b>	JaeWook Choi
<b>Room temperature [°C]</b>	24
<b>Room humidity [%]</b>	30
<b>Simulated tissue temperature [°C]</b>	24
<b>Tissue calibration frequency [MHz]</b>	5240
<b>Tissue Type</b>	Muscle
<b>Target conductivity [S/m]</b>	5.40
<b>Target dielectric constant</b>	48.5
<b>Measured conductivity [S/m]</b>	5.43 (+0.6 %)
<b>Measured dielectric constant</b>	48.8 (+0.6 %)
<b>Penetration depth (plane wave excitation) [mm]</b>	6.95

**ULTRATECH GROUP OF LABS**

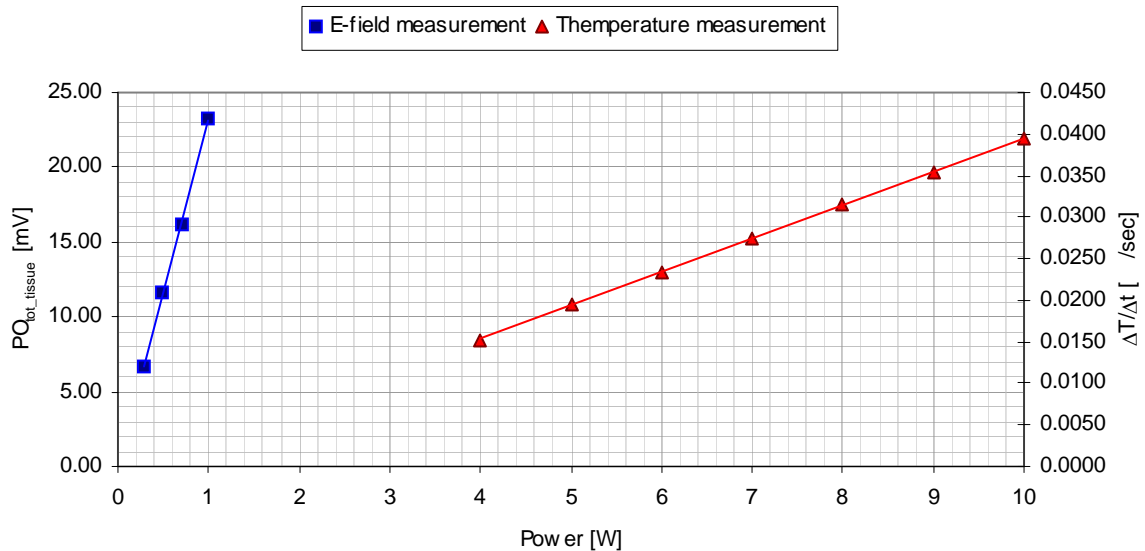
3000 Bristol Circle, Oakville, Ontario, Canada L6H 6G4  
 Tel. #: 905-829-1570, Fax. #: 905-829-8050, Email: vic@ultratech-labs.com, Website: http://www.ultratech-labs.com

**File #: ITS-006-SAR**  
**June 5, 2003**

- Assessed by ITI (UK) Competent Body, NVLAP (USA) Accreditation Body & ACA/AUSTEL (Australia), VCCI (Japan)
- Accredited by Industry Canada (Canada) under ACC-LAB (Europe/Canada MRA and APEC/Canada MRA)
- Recognized/Listed by FCC (USA)
- All test results contained in this engineering test report are traceable to National Institute of Standards and Technology (NIST)

**9.4.2.3. Conversion Factor**

<b>Calibration Date</b> [MM/DD/YYYY]	07/31/2002
<b>Calibration by</b>	JaeWook Choi
<b>Calibration Frequency</b> [MHz]	5,240
<b>Room Temperature</b> [°C]	24
<b>Room Humidity</b> [%]	30
<b>Simulated Tissue Temperature</b> [°C]	23
<b>PO<sub>tot_tissue</sub></b> [mV]	6.668 @ 0.28 [W] 11.609 @ 0.49 [W] 16.193 @ 0.70 [W] 23.278 @ 0.99 [W]
<b>δ(PO<sub>tot_tissue</sub>)/δP</b> [mV/W]	23.44599
<b>ΔT/Δt</b> [°C/sec]	0.01525 @ 4.0 [W] 0.01940 @ 5.0 [W] 0.02343 @ 6.0 [W] 0.02732 @ 7.0 [W] 0.03152 @ 8.0 [W] 0.03549 @ 9.0 [W] 0.03943 @ 10.0 [W]
<b>δ(ΔT/Δt)/δP</b> [°C/sec/W]	0.004029
<b>Conversion Factor (γ)</b>	2.721



**ULTRATECH GROUP OF LABS**

3000 Bristol Circle, Oakville, Ontario, Canada L6H 6G4  
 Tel. #: 905-829-1570, Fax. #: 905-829-8050, Email: vic@ultratech-labs.com, Website: http://www.ultratech-labs.com

**File #: ITS-006-SAR**  
**June 5, 2003**

- Assessed by ITI (UK) Competent Body, NVLAP (USA) Accreditation Body & ACA/AUSTEL (Australia), VCCI (Japan)
- Accredited by Industry Canada (Canada) under ACC-LAB (Europe/Canada MRA and APEC/Canada MRA)
- Recognized/Listed by FCC (USA)
- All test results contained in this engineering test report are traceable to National Institute of Standards and Technology (NIST)

## EXHIBIT 10. SAR SYSTEM VERIFICATION USING DIPOLE REFERENCE

### 10.1. 2.45 GHZ

#### 10.1.1. Verification Setup

<b>Flat phantom dimension (W × L × H)</b> [mm]	420 × 700 × 200
<b>Flat phantom shell thickness (d<sub>3</sub>)</b> [mm]	2.0
<b>Flat phantom shell permittivity</b>	2.98
<b>Reference dipole dimension (L × h × d)</b> [mm]	51.7 × 30.4 × 3.6
<b>Dipole-to-Phantom (d<sub>2</sub>)</b> [mm]	8.0
<b>Dipole-to-Liquid (d<sub>2</sub> + d<sub>3</sub>)</b> [mm]	10.0 (8.0 + 2.0)
<b>Return Loss (at test frequency)</b> [dB]	-24.0

#### 10.1.2. Simulated Tissue

##### 10.1.2.1. BRAIN TISSUE

<b>Tissue calibration type</b>	HP Dielectric Strength Probe System
<b>Tissue calibration date</b> [MM/DD/YYYY]	05/22/2003
<b>Tissue calibrated by</b>	JaeWook Choi
<b>Room temperature</b> [°C]	22
<b>Room humidity</b> [%]	30
<b>Simulated tissue temperature</b> [°C]	22
<b>Tissue calibration frequency</b> [MHz]	2450
<b>Tissue Type</b>	Brain
<b>Target conductivity</b> [S/m]	1.81
<b>Target dielectric constant</b>	39.2
<b>Specific Heat Capacity</b> [J/Kg/°C]	3,702
<b>Mass Density</b> [Kg/m <sup>3</sup> ]	1,016
<b>Measured conductivity</b> [S/m]	1.81 (+0.6 %)
<b>Measured dielectric constant</b>	39.8 (+1.5 %)
<b>Penetration depth (plane wave excitation)</b> [mm]	17.6

### ULTRATECH GROUP OF LABS

3000 Bristol Circle, Oakville, Ontario, Canada L6H 6G4  
 Tel. #: 905-829-1570, Fax. #: 905-829-8050, Email: vic@ultratech-labs.com, Website: http://www.ultratech-labs.com

File #: ITS-006-SAR  
 June 5, 2003

- Assessed by ITI (UK) Competent Body, NVLAP (USA) Accreditation Body & ACA/AUSTEL (Australia), VCCI (Japan)
- Accredited by Industry Canada (Canada) under ACC-LAB (Europe/Canada MRA and APEC/Canada MRA)
- Recognized/Listed by FCC (USA)
- All test results contained in this engineering test report are traceable to National Institute of Standards and Technology (NIST)

**10.1.3. Verification Result**

**10.1.3.1. Reference SAR values\***

Reference SAR <sub>Ig</sub> [W/Kg]	52.4
Reference SAR <sub>s</sub> [W/Kg]	104.2
Measured SAR <sub>Ig</sub> [W/Kg]	49.1
Measured SAR <sub>s</sub> [W/Kg]	108.7

**10.1.3.2. Brain tissue**

Test date [MM/DD/YYYY]	05/22/2003
Test by	JaeWook Choi
Room temperature [°C]	22
Room humidity [%]	30
Simulated tissue temperature [°C]	22
Test frequency [MHz]	2450
E-field Probe	M/N: E-TR, S/N: UT-0200-1, Sensor Offset: 2.0 mm
Sensor Factor (η <sub>pa</sub> ) [mV/(mW/cm <sup>2</sup> )]	10.8
Amplifier Settings (AS <sub>1</sub> , AS <sub>2</sub> , AS <sub>3</sub> )	0.00660854, 0.00622568, 0.008540925
Tissue Type	Brain
Measured conductivity [S/m]	1.81 (+0.6 %)
Measured dielectric constant	39.8 (+1.5 %)
Specific Heat Capacity [J/Kg/°C]	3,702
Mass Density [Kg/m <sup>3</sup> ]	1,016
Conversion Factor (γ)	3.653
Sensitivity (ζ) [W/Kg/mV]	1.730E-01
Power [mW]	100 (forward power)
Measurement Volume Specification (X × Y × Z)	5 <sub>pts</sub> × 5 <sub>pts</sub> × 9 <sub>pts</sub> , 16 <sub>mm</sub> × 16 <sub>mm</sub> × 32 <sub>mm</sub> ; Resolution: 4 <sub>mm</sub> × 4 <sub>mm</sub> × 4 <sub>mm</sub>
SAR <sub>Ig</sub> [W/Kg]	4.91
SAR <sub>s</sub> [W/Kg]	10.87
Penetration Depth [mm]	13.8

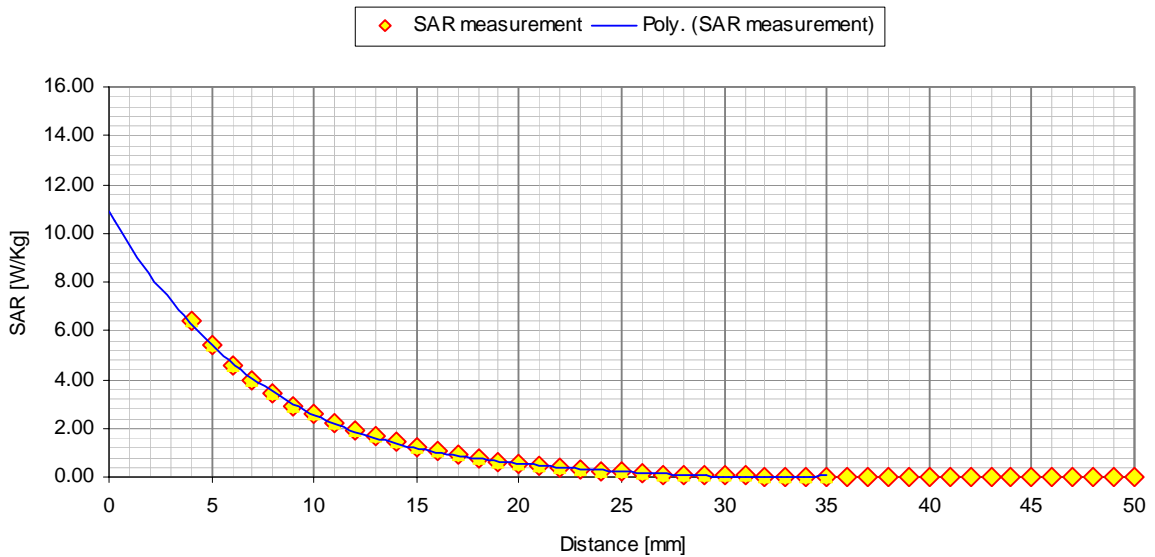
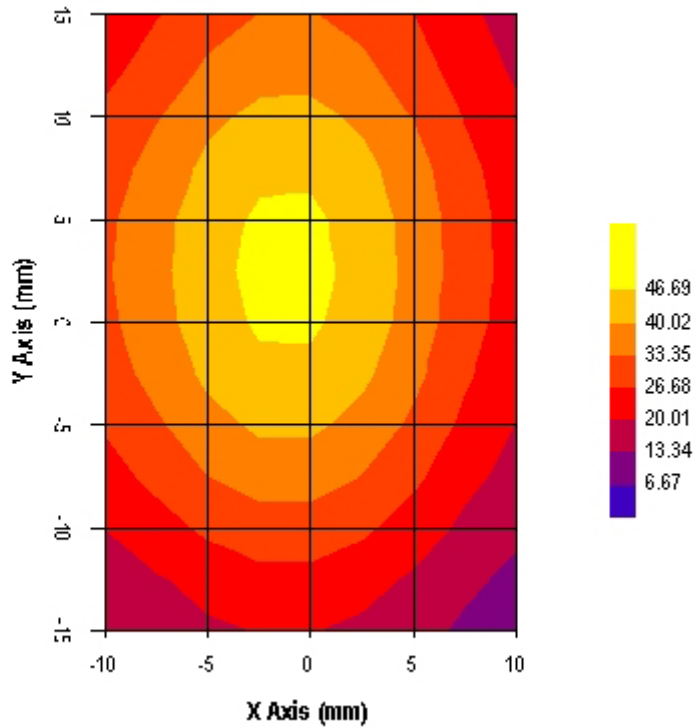
\* All SAR values in 10.1.3.1 are normalized to a forward power of 1 W.

- Assessed by ITI (UK) Competent Body, NVLAP (USA) Accreditation Body & ACA/AUSTEL (Australia), VCCI (Japan)
- Accredited by Industry Canada (Canada) under ACC-LAB (Europe/Canada MRA and APEC/Canada MRA)
- Recognized/Listed by FCC (USA)
- All test results contained in this engineering test report are traceable to National Institute of Standards and Technology (NIST)

**SPECIFIC ABSORPTION RATE (SAR)**

IEEE C95.1-1991, FCC OET Bulletin 65 (Supplement C), Industry Canada RSS-102(Issue 1) and ACA Radiocommunications (Electromagnetic Radiation – Human Exposure) Amendment Standard 2000 (No. 1)

**Wireless LAN Card M/N: ISL3900M**



**ULTRATECH GROUP OF LABS**

3000 Bristol Circle, Oakville, Ontario, Canada L6H 6G4  
Tel. #: 905-829-1570, Fax. #: 905-829-8050, Email: vic@ultratech-labs.com, Website: http://www.ultratech-labs.com

File #: ITS-006-SAR  
June 5, 2003

- Assessed by ITI (UK) Competent Body, NVLAP (USA) Accreditation Body & ACA/AUSTEL (Australia), VCCI (Japan)
- Accredited by Industry Canada (Canada) under ACC-LAB (Europe/Canada MRA and APEC/Canada MRA)
- Recognized/Listed by FCC (USA)
- All test results contained in this engineering test report are traceable to National Institute of Standards and Technology (NIST)

## 10.2. 5.24 GHZ

### 10.2.1. Verification Setup

<b>Flat phantom dimension (W × L × H)</b> [mm]	420 × 700 × 200
<b>Flat phantom shell thickness (d<sub>3</sub>)</b> [mm]	2.0
<b>Flat phantom shell permittivity</b>	2.98
<b>Reference dipole dimension (L × h × d)</b> [mm]	25.1 × 13.4 × 3.6
<b>Dipole-to-Phantom (d<sub>2</sub>)</b> [mm]	8.0
<b>Dipole-to-Liquid (d<sub>2</sub> + d<sub>3</sub>)</b> [mm]	10.0 (8.0 + 2.0)
<b>Return Loss (at test frequency)</b> [dB]	-21.0

### 10.2.2. Simulated Tissue

<b>Tissue calibration type</b>	HP Dielectric Strength Probe System
<b>Tissue calibration date</b> [MM/DD/YYYY]	05/23/2003
<b>Tissue calibrated by</b>	JaeWook Choi
<b>Room temperature</b> [°C]	22
<b>Room humidity</b> [%]	30
<b>Simulated tissue temperature</b> [°C]	22
<b>Tissue calibration frequency</b> [MHz]	5240
<b>Tissue Type</b>	Muscle
<b>Target conductivity</b> [S/m]	5.40
<b>Target dielectric constant</b>	48.5
<b>Measured conductivity</b> [S/m]	5.56 (+3.0 %)
<b>Measured dielectric constant</b>	47.3 (-2.5 %)
<b>Penetration depth (plane wave excitation)</b> [mm]	6.7

## ULTRATECH GROUP OF LABS

3000 Bristol Circle, Oakville, Ontario, Canada L6H 6G4  
 Tel. #: 905-829-1570, Fax. #: 905-829-8050, Email: vic@ultratech-labs.com, Website: http://www.ultratech-labs.com

**File #: ITS-006-SAR**  
**June 5, 2003**

- Assessed by ITI (UK) Competent Body, NVLAP (USA) Accreditation Body & ACA/AUSTEL (Australia), VCCI (Japan)
- Accredited by Industry Canada (Canada) under ACC-LAB (Europe/Canada MRA and APEC/Canada MRA)
- Recognized/Listed by FCC (USA)
- All test results contained in this engineering test report are traceable to National Institute of Standards and Technology (NIST)

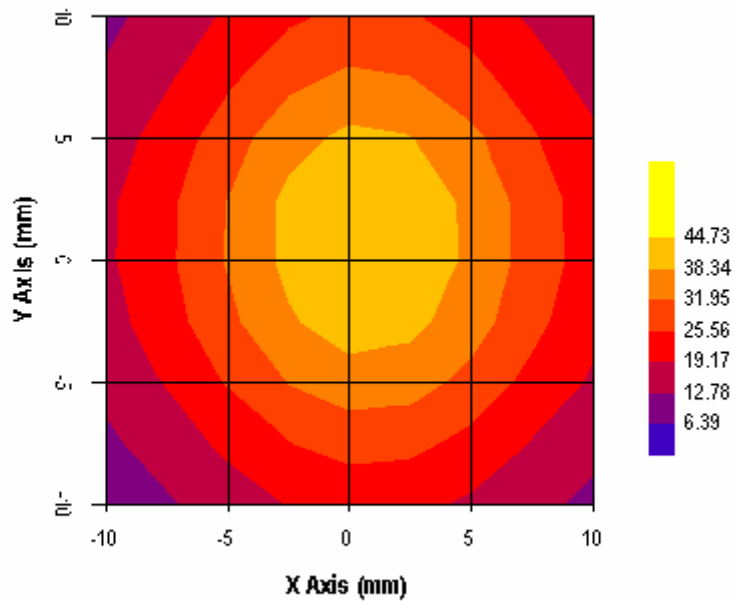
## SPECIFIC ABSORPTION RATE (SAR)

IEEE C95.1-1991, FCC OET Bulletin 65 (Supplement C), Industry Canada RSS-102(Issue 1) and ACA Radiocommunications (Electromagnetic Radiation – Human Exposure) Amendment Standard 2000 (No. 1)

Wireless LAN Card M/N: ISL39000M

### 10.2.3. Verification Result

Test date [MM/DD/YYYY]	05/23/2003
Test by	JaeWook Choi
Room temperature [°C]	22
Room humidity [%]	30
Simulated tissue temperature [°C]	22
Separation distance, d [mm]	10 (8 + 2)
Test frequency [MHz]	5240
E-field Probe	M/N: E-TR, S/N: UT-0200-1, Sensor Offset: 2.0 mm
Sensor Factor ( $\eta_{pd}$ ) [mV/(mW/cm <sup>2</sup> )]	10.8
Amplifier Settings (AS <sub>1</sub> , AS <sub>2</sub> , AS <sub>3</sub> )	0.00596768, 0.00563160, 0.00779221
Tissue Type	Muscle
Measured conductivity [S/m]	5.56 (+3.0 %)
Measured dielectric constant	47.3 (-2.5 %)
Conversion Factor ( $\gamma$ )	2.721
Sensitivity ( $\zeta$ ) [W/Kg/mV]	7.133E-01
Power [mW]	250 (forward power)
Measurement Volume Specification (X × Y × Z)	5 pts × 5 pts × 13 pts, 12 mm × 12 mm × 12 mm; Resolution: 3 mm × 3 mm × 1 mm
SAR <sub>lg</sub> [W/Kg]	13.143
SAR <sub>s</sub> [W/Kg]	67.915
Penetration Depth [mm]	5.96



## ULTRATECH GROUP OF LABS

3000 Bristol Circle, Oakville, Ontario, Canada L6H 6G4  
Tel. #: 905-829-1570, Fax. #: 905-829-8050, Email: vic@ultratech-labs.com, Website: http://www.ultratech-labs.com

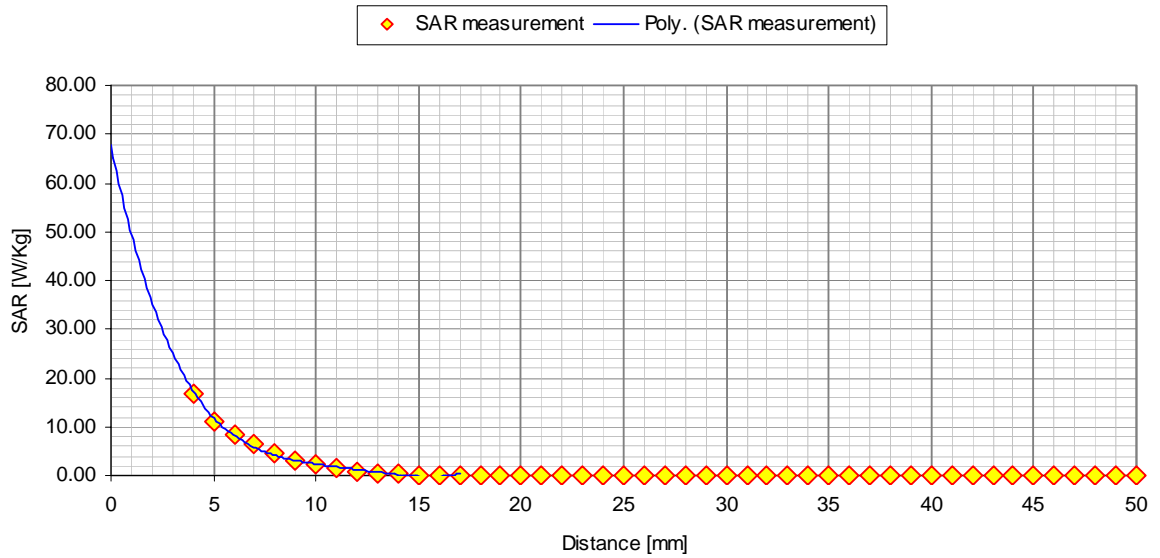
File #: ITS-006-SAR  
June 5, 2003

- Assessed by ITI (UK) Competent Body, NVLAP (USA) Accreditation Body & ACA/AUSTEL (Australia), VCCI (Japan)
- Accredited by Industry Canada (Canada) under ACC-LAB (Europe/Canada MRA and APEC/Canada MRA)
- Recognized/Listed by FCC (USA)
- All test results contained in this engineering test report are traceable to National Institute of Standards and Technology (NIST)

**SPECIFIC ABSORPTION RATE (SAR)**

IEEE C95.1-1991, FCC OET Bulletin 65 (Supplement C), Industry Canada RSS-102(Issue 1) and ACA Radiocommunications (Electromagnetic Radiation – Human Exposure) Amendment Standard 2000 (No. 1)

**Wireless LAN Card M/N: ISL39000M**



**ULTRATECH GROUP OF LABS**

3000 Bristol Circle, Oakville, Ontario, Canada L6H 6G4  
Tel. #: 905-829-1570, Fax. #: 905-829-8050, Email: vic@ultratech-labs.com, Website: http://www.ultratech-labs.com

File #: ITS-006-SAR  
June 5, 2003

- Assessed by ITI (UK) Competent Body, NVLAP (USA) Accreditation Body & ACA/AUSTEL (Australia), VCCI (Japan)
- Accredited by Industry Canada (Canada) under ACC-LAB (Europe/Canada MRA and APEC/Canada MRA)
- Recognized/Listed by FCC (USA)
- All test results contained in this engineering test report are traceable to National Institute of Standards and Technology (NIST)



## **EXHIBIT 11. MANUFACTURER’S DECLARATION ANTENNA ASSEMBLIES**

---

### **ULTRATECH GROUP OF LABS**

3000 Bristol Circle, Oakville, Ontario, Canada L6H 6G4

Tel. #: 905-829-1570, Fax. #: 905-829-8050, Email: vic@ultratech-labs.com, Website: <http://www.ultratech-labs.com>

**File #: ITS-006-SAR**

**June 5, 2003**

- Assessed by ITI (UK) Competent Body, NVLAP (USA) Accreditation Body & ACA/AUSTEL (Australia), VCCI (Japan)
- Accredited by Industry Canada (Canada) under ACC-LAB (Europe/Canada MRA and APEC/Canada MRA)
- Recognized/Listed by FCC (USA )
- *All test results contained in this engineering test report are traceable to National Institute of Standards and Technology (NIST)*

## SPECIFIC ABSORPTION RATE (SAR)

Page 73

IEEE C95.1-1991, FCC OET Bulletin 65 (Supplement C), Industry Canada RSS-102(Issue 1) and ACA Radiocommunications (Electromagnetic Radiation – Human Exposure) Amendment Standard 2000 (No. 1)

**Wireless LAN Card M/N: ISL39000M**

---

---

## ULTRATECH GROUP OF LABS

3000 Bristol Circle, Oakville, Ontario, Canada L6H 6G4

Tel. #: 905-829-1570, Fax. #: 905-829-8050, Email: vic@ultratech-labs.com, Website: <http://www.ultratech-labs.com>

File #: ITS-006-SAR

June 5, 2003

- Assessed by ITI (UK) Competent Body, NVLAP (USA) Accreditation Body & ACA/AUSTEL (Australia), VCCI (Japan)
- Accredited by Industry Canada (Canada) under ACC-LAB (Europe/Canada MRA and APEC/Canada MRA)
- Recognized/Listed by FCC (USA )
- *All test results contained in this engineering test report are traceable to National Institute of Standards and Technology (NIST)*

## EXHIBIT 12. SAR CALCULATION SUMMARY

### 12.1. TERMINOLOGY

$AS_i$	Amplifier Setting for channel $i$ ( $i = 1, 2, 3$ )
$Pd$	Power density at the measurement point [ $mW/cm^2$ ]
$PO_{tot\_air}$	Probe Output in the air [ $mV$ ]
$PO_{tot\_tissue}$	Probe Output in the simulated tissue [ $mV$ ]
$\eta_{E2}$	Sensor Factor to the $ E ^2$ , an arbitrary value $10.8/3,770$ [ $mV/(V/m)^2$ ]
$\eta_{pd}$	Sensor Factor to the uniform power density, an arbitrary value $10.8$ [ $mV/(mW/cm^2)$ ]
$\gamma$	Conversion factor; ratio of sensor response in air to response in the dielectric media
$\zeta$	Sensitivity of the probe in the simulated tissue [ $W/Kg/mV$ ]
$c$	Specific heat capacity of the simulated tissue [ $J/Kg/^\circ C$ ]
$\sigma_{@cal}$	Conductivity of the simulated tissue during the thermal transfer calibration [ $S/m$ ]
$\sigma_{@meas}$	Conductivity of the simulated tissue during the SAR measurement [ $S/m$ ]
$\rho$	Mass density of the simulated tissue [ $Kg/m^3$ ]
$\Delta T/\Delta t$	Initial rate of tissue heating, before thermal diffusion takes place [ $^\circ C/sec$ ]

#### 12.1.1. Sensor factor( $\eta_{pd}$ and $\eta_{E2}$ ) in the air ( $Z_0 = 377[\Omega]$ )

$$\eta_{Pd} = 10.8[mV/(mW/cm^2)] \equiv \eta_{E2} = \frac{10.8}{3,770}[mV/(V/m)^2]$$

$$Pd[mW/cm^2] = \frac{PO_{tot}}{\eta_{Pd}}, \quad |E|^2[(V/m)^2] = \frac{PO_{tot}}{\eta_{E2}} \quad \text{and} \quad SAR[W/Kg] = \frac{\sigma \times \frac{PO_{tot}}{\eta_{E2}}}{\rho}$$

#### 12.1.2. Amplifier settings( $AS_i$ ) and probe output

$$AS_i = \frac{\eta_{Pd}}{V_{max_i} - DC_i} \times \cos^2(\varphi - \theta_i) \times Pd$$

$$PO_1[mV] = (V_1 - DC_1) \times AS_1 \equiv |E_1|^2 \times \eta_{E2}$$

$$PO_2[mV] = (V_2 - DC_2) \times AS_2 \equiv |E_2|^2 \times \eta_{E2}$$

$$PO_3[mV] = (V_3 - DC_3) \times AS_3 \equiv |E_3|^2 \times \eta_{E2}$$

$$PO_{tot}[mV] \equiv |E|^2 \times \eta_{E2} = (|E_1|^2 + |E_2|^2 + |E_3|^2) \times \eta_{E2} = |E_1|^2 \times \eta_{E2} + |E_2|^2 \times \eta_{E2} + |E_3|^2 \times \eta_{E2}$$

$$\equiv PO_1 + PO_2 + PO_3$$

**12.1.3. Conversion factor ( $\gamma$ ) in the simulated tissue**

$$|E_{tissue}|^2 = \frac{PO_{tot\_tissue}}{\eta_{E2}} \times \frac{1}{\gamma}$$

$$SAR_t = SAR_{tissue} = \frac{\sigma_{@cal} \times |E_{tissue}|^2}{\rho} = \frac{\sigma_{@cal} \times \frac{PO_{tot\_tissue}}{\eta_{E2}} \times \frac{1}{\gamma}}{\rho [Kg / m^3]} = \left( \frac{\sigma_{@cal} \times \frac{PO_{tot\_tissue}}{\eta_{E2}}}{\rho} \right) \times \frac{1}{\gamma} = SAR_{PO_{tot\_tissue}} \times \frac{1}{\gamma}$$

**12.1.4. Conversion factor ( $\gamma$ ) Calculation**

$$\frac{\delta}{\delta P} SAR_t = \frac{\delta}{\delta P} SAR_{tissue}$$

$$\frac{\delta}{\delta P} \left( c \times \frac{\Delta T}{\Delta t} \right) = \frac{\delta}{\delta P} \left( \frac{\sigma_{@cal} \times |E_{tissue}|^2}{\rho} \right) = \frac{\delta}{\delta P} \left( \frac{\sigma_{@cal} \times \frac{PO_{tot\_tissue}}{\eta_{E2}} \times \frac{1}{\gamma}}{\rho} \right)$$

$$\gamma = \frac{\frac{\delta}{\delta P} SAR_{PO_{tot\_tissue}}}{\frac{\delta}{\delta P} SAR_t} = \frac{\frac{\sigma_{@cal} \times \frac{\delta}{\delta P} PO_{tot\_tissue}}{\eta_{E2}}}{c \times \frac{\delta}{\delta P} \frac{\Delta T}{\Delta t}} = \frac{\sigma_{@cal}}{\eta_{E2} \times c \times \rho} \times \frac{\delta}{\delta P} \frac{PO_{tot\_tissue}}{\frac{\delta}{\delta P} \frac{\Delta T}{\Delta t}}$$

**12.1.5. Sensitivity ( $\zeta$ ) in the simulated tissue**

$$\zeta [W / Kg / mV] = \frac{\sigma_{@meas}}{\eta_{E2} \times 1,000 [Kg / m^3] \times \gamma}$$

**12.1.6. SAR calculation**

$$SAR [W / Kg] = \zeta [W / Kg / mV] \times PO_{tot\_tissue} [mV]$$

- Assessed by ITI (UK) Competent Body, NVLAP (USA) Accreditation Body & ACA/AUSTEL (Australia), VCCI (Japan)
- Accredited by Industry Canada (Canada) under ACC-LAB (Europe/Canada MRA and APEC/Canada MRA)
- Recognized/Listed by FCC (USA)
- All test results contained in this engineering test report are traceable to National Institute of Standards and Technology (NIST)