



LS Research Inc.

**Intersil Access Point: Appendix D to Report
Number 301270A2-TX**

AP ISL 36356

• • • • • • • • • •

FCC ID: OSZ36356A1, OSZ36356A2

Part 15.247 Type Acceptance, Conducted Measurements

prepared for

Intersil

Revision 1.0



Table of Contents

- I. Project Information 3
- II. Declaration of Compliance – 15.247 Measurement Summary..... 5
 - A. Part 15.247 (a)(2) Minimum Emission 6 dB Bandwidth..... 5
 - B. Part 15.247 (b) (1) Maximum Conducted Emission Output Power 5
 - C. Part 15.247 (c) Minimum Relative Spurious Power Spectral Density Level 5
 - D. Part 15.247 (d) Maximum Power Spectral Density..... 6
- III. FCC Conducted Measurements..... 7
 - A. Part 15.247 7
 - 1. 15.247 (a) (2) Emission 6 dB Bandwidth..... 7
 - 2. 15.247 (b) (1) Output Power 15
 - 3. 15.247 (b) (3) Effective Radiated Power..... 22
 - 4. 15.247 (c) Spurious Modulation Products..... 22
 - 5. 15.247 (d) Power Spectral Density..... 33
- IV. Critical Equipment List 43
- V. Equipment Uncertainties 43

Intersil Access Point

I. Project Information

Project: Intersil Access Point

Intersil Contact:

Company: Intersil Corporation.
Full Name: Bartow Willingham
Title: System Engineer
Bus: (321)-729-4955
FAX: (321)-724-7094
E-mail: mailto:bwilli08@intersil.com

LS Research Contact:

Bill Steinike, Operations Manager
Brian Petted, Vice President of Engineering
Voice: 262-375-4400
Fax: 262-375-4248
Email: bsteinike@lsr.com

Report Date: 8/2/01
Revision: 1.0
Proposal #:
Proposal File: Intersil
Job Number:



Signatures:

A handwritten signature in black ink, appearing to be 'MCA', is centered on the page.

Technical Approval

II. Declaration of Compliance – 15.247 Measurement Summary

Presented below is a compliance matrix showing the test conditions, test indications, test limits and test outcomes associated with the part 15.247 conducted tests performed on the Equipment Under Test: Intersil Access Point AP ISL 36356 FCC Conducted Tests:

A. Part 15.247 (a)(2) Minimum Emission 6 dB Bandwidth

EUT Test Conditions \ FCC Test Type	15.247 (a) (2)	15.247 (a) (2)	15.247 (a) (2)
	Limit	Indication	Outcome
Channel 1 (2412 MHz), 11 Mbps	500 kHz, min	10.97 MHz	PASS
Channel 6 (2437 MHz), 1 Mbps	500 kHz, min	10.97 MHz	PASS
Channel 6 (2437 MHz), 2 Mbps	500 kHz, min	10.97 MHz	PASS
Channel 6 (2437 MHz), 5.5 Mbps	500 kHz, min	11.97 MHz	PASS
Channel 6 (2437 MHz), 11 Mbps	500 kHz, min	10.97 MHz	PASS
Channel 11 (2462MHz), 11 Mbps	500 kHz, min	12.34 MHz	PASS

B. Part 15.247 (b) (1) Maximum Conducted Emission Output Power

EUT Test Conditions \ FCC Test Type	15.247 (b) (1)	15.247 (b) (1)	15.247 (b) (1)
	Limit	Indication	Outcome
Channel 1 (2412 MHz), 11 Mbps	30 dBm, Max	15.9 dBm	PASS
Channel 6 (2437 MHz), 1 Mbps	30 dBm, Max	15.9 dBm	PASS
Channel 6 (2437 MHz), 2 Mbps	30 dBm, Max	15.9 dBm	PASS
Channel 6 (2437 MHz), 5.5 Mbps	30 dBm, Max	16.3 dBm	PASS
Channel 6 (2437 MHz), 11 Mbps	30 dBm, Max	16.1 dBm	PASS
Channel 11 (2462MHz), 11 Mbps	30 dBm, Max	16.1 dBm	PASS

C. Part 15.247 (c) Minimum Relative Spurious Power Spectral Density Level

EUT Test Conditions \ FCC Test Type	15.247 (c)	15.247 (c)	15.247 (c)
	Limit	Indication	Outcome
Channel 11 (2462 MHz), 11 Mbps, Wide Scan	20 dBc, min	50.7 dBc	PASS
Channel 1 (2412 MHz), 1 Mbps, Band Edge	20 dBc, min	38.1 dBc	PASS
Channel 1 (2412 MHz), 2 Mbps, Band Edge	20 dBc, min	36.8 dBc	PASS
Channel 1 (2412 MHz), 5.5 Mbps, Band Edge	20 dBc, min	30.4 dBc	PASS
Channel 1 (2412 MHz), 11 Mbps, Band Edge	20 dBc, min	33.1 dBc	PASS
Channel 11 (2462 MHz), 1 Mbps, Band Edge	20 dBc, min	39.6 dBc	PASS
Channel 11 (2462 MHz), 2 Mbps, Band Edge	20 dBc, min	40.0 dBc	PASS
Channel 11 (2462 MHz), 5.5 Mbps, Band Edge	20 dBc, min	45.1 dBc	PASS
Channel 11 (2462MHz), 11 Mbps, Band Edge	20 dBc, min	44.7 dBc	PASS



D. Part 15.247 (d) Maximum Power Spectral Density

FCC Test Type	15.247 (d)	15.247 (d)	15.247 (d)
EUT Test Conditions	Limit	Indication	Outcome
Channel 1 (2412 MHz), 1Mbps	8 dBm/kHz, Max	-25.1 dBm/3 kHz	PASS
Channel 1 (2412 MHz), 11 Mbps	8 dBm/kHz, Max	-9.5 dBm/3 kHz	PASS
Channel 6 (2437 MHz), 1 Mbps	8 dBm/kHz, Max	-25.2 dBm/3 kHz	PASS
Channel 6 (2437 MHz), 2 Mbps	8 dBm/kHz, Max	-21.8 dBm/3 kHz	PASS
Channel 6 (2437 MHz), 5.5 Mbps	8 dBm/kHz, Max	-11.4 dBm/3 kHz	PASS
Channel 6 (2437 MHz), 11 Mbps	8 dBm/kHz, Max	-8.2 dBm/3 kHz	PASS
Channel 11 (2462MHz), 1 Mbps	8 dBm/kHz, Max	-25.2 dBm/3 kHz	PASS
Channel 11 (2462MHz), 11 Mbps	8 dBm/kHz, Max	-16.7 dBm/3 kHz	PASS



III. FCC Conducted Measurements

A. Part 15.247

1. 15.247 (a) (2) Emission 6 dB Bandwidth

a) Test Requirement

The 6 dB bandwidth of the Equipment emission must be greater than 500 kHz.

$$B_{-6\text{ dB}} > 500\text{ kHz}$$

b) Test Configuration

The test configuration is presented below:

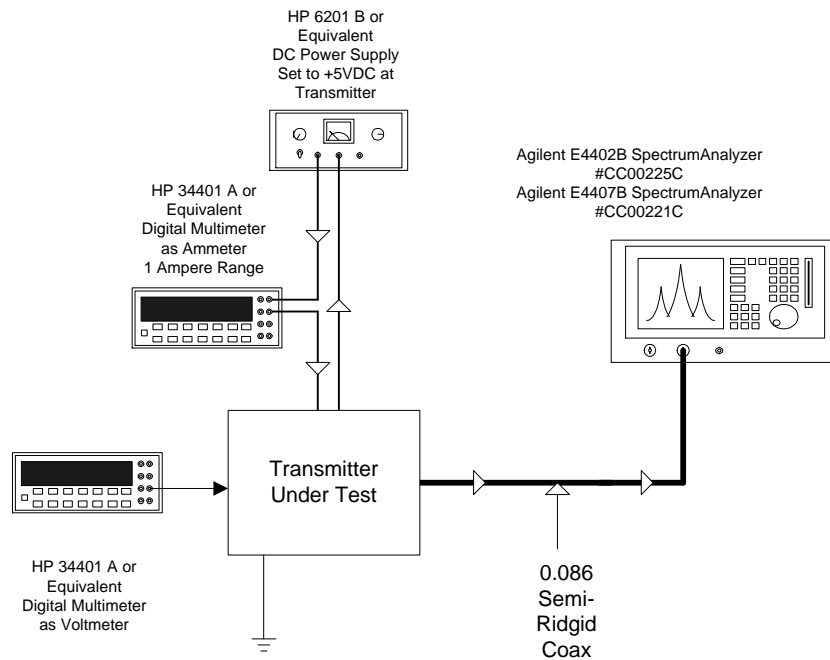



c) Test Conditions: Equipment Under Test

The equipment under test is tunable and is set to 3 different channels, one representing the minimum tunable frequency, one representing a midband frequency and one representing the maximum tunable frequency. The frequencies and their channel designators are presented below for reference. Secondly, since the access point is a multi-rate radio, the data (bit) rate test cases are also listed.

Channel 1: 2412 MHz , 11 Mbps

Channel 6: 2437 MHz, 1,2,5.5,11 Mbps

Channel 11: 2462 MHz , 11 Mbps

Test indications under these six frequency and bit rate conditions are presented.

The output power is fixed to its maximum, worst-case value.

d) Test Conditions: Instrumentation Conditions

The readings indicated on the spectrum analyzer are a result of a marker search function which determines the 6 dB bandwidth of the indicated spectrum. The spectrum analyzer display indicates its conditions as follows:

Center: Center Frequency

Span: Frequency Span

Res BW: Resolution Bandwidth

VBW: Video (averaging) Bandwidth

Sweep: Frequency Sweep time over indicated frequency Span.



e) Test Indications

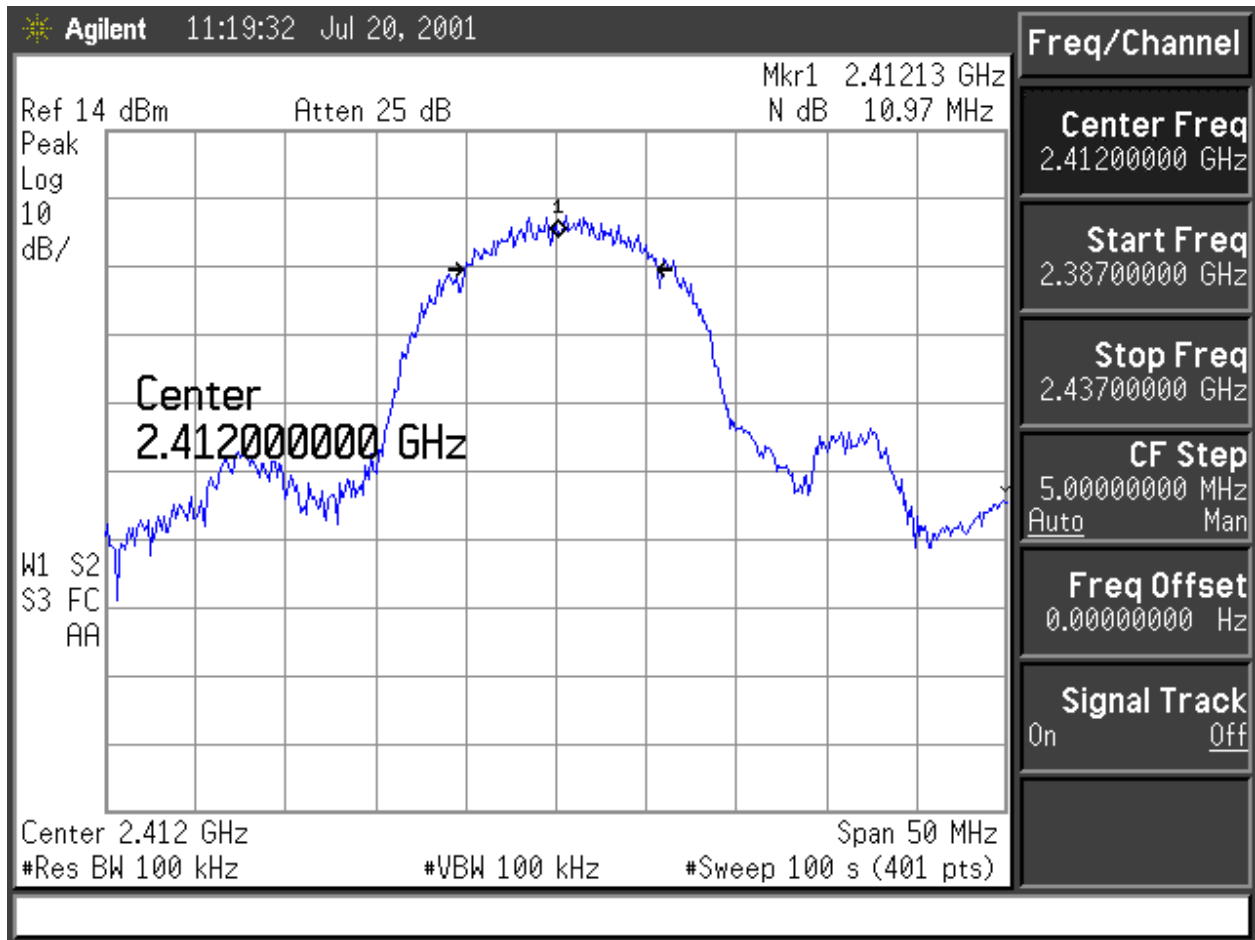

Test Condition: Channel 1: 2412 MHz, 11 Mbps

Test Limit: 500 kHz, minimum.

Test Indication: 10.97 MHz

Test Outcome: 10.97 MHz > 500 kHz →PASS

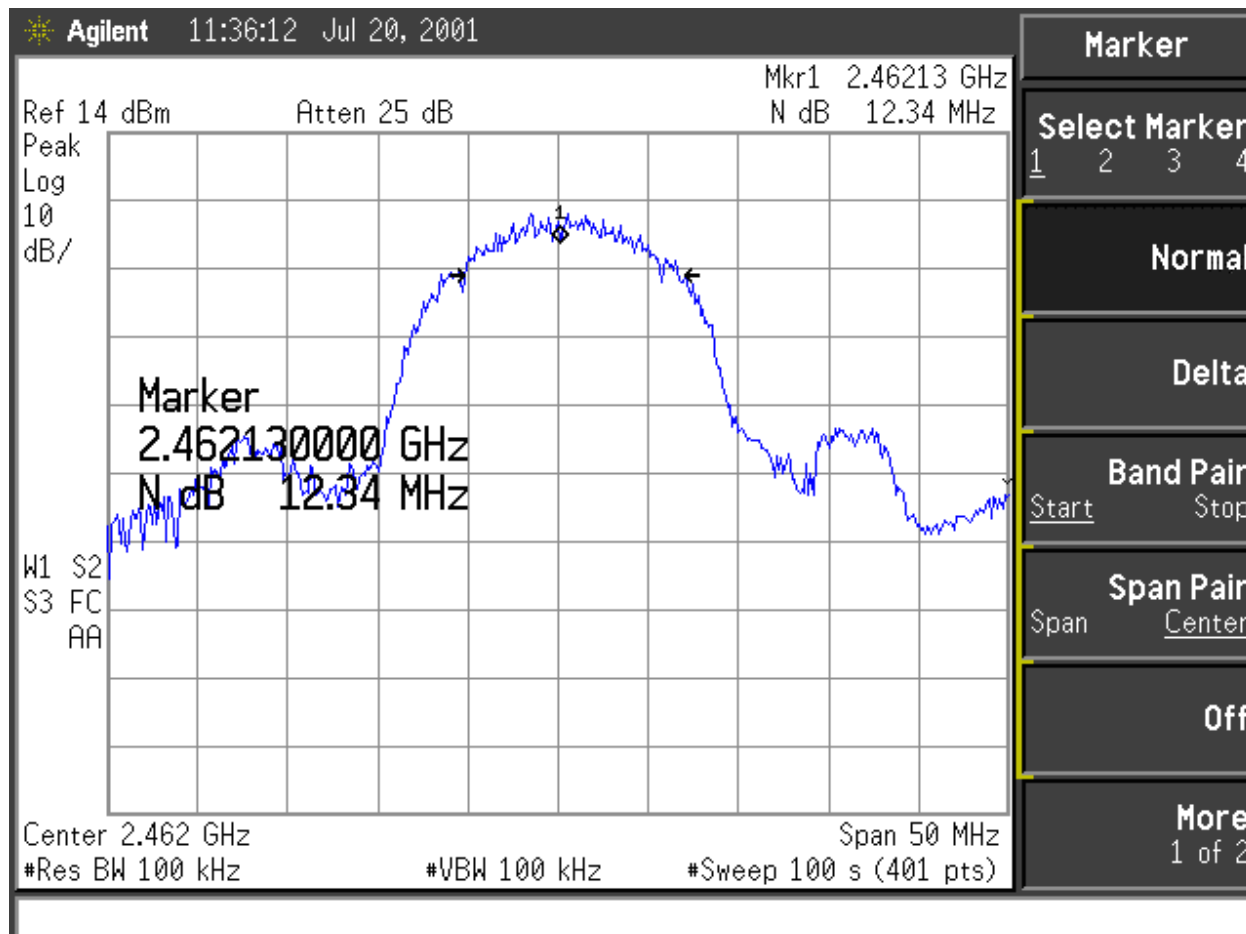

Test Condition: Channel 11: 2462 MHz, 11 Mbps

Test Limit: 500 kHz, minimum.

Test Indication: 12.34 MHz

Test Outcome: 12.34 MHz > 500 kHz →PASS

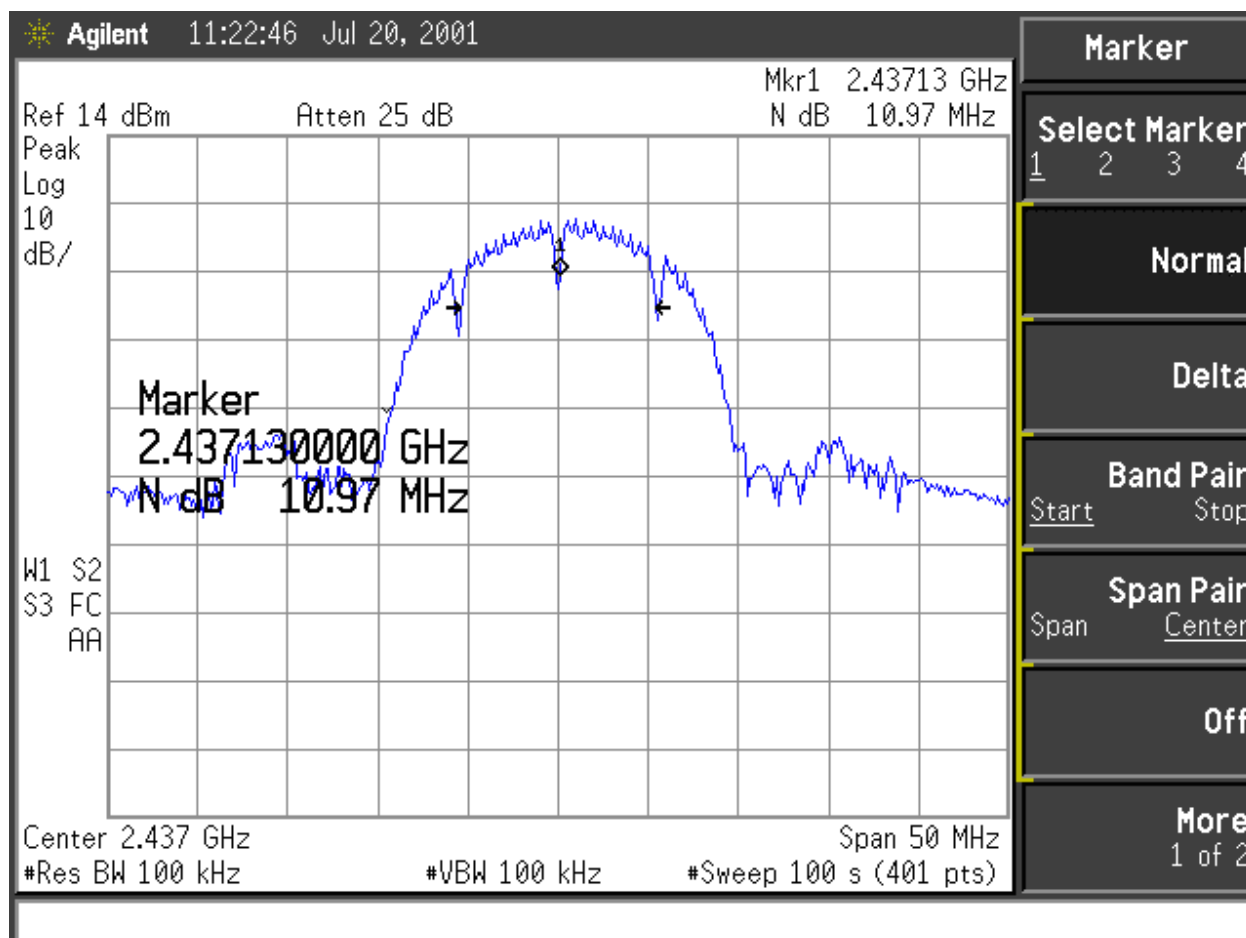

Test Condition: Channel 6: 2437 MHz, 1Mbps

Test Limit: 500 kHz, minimum.

Test Indication: 10.97 MHz

Test Outcome: 10.97 MHz > 500 kHz → PASS

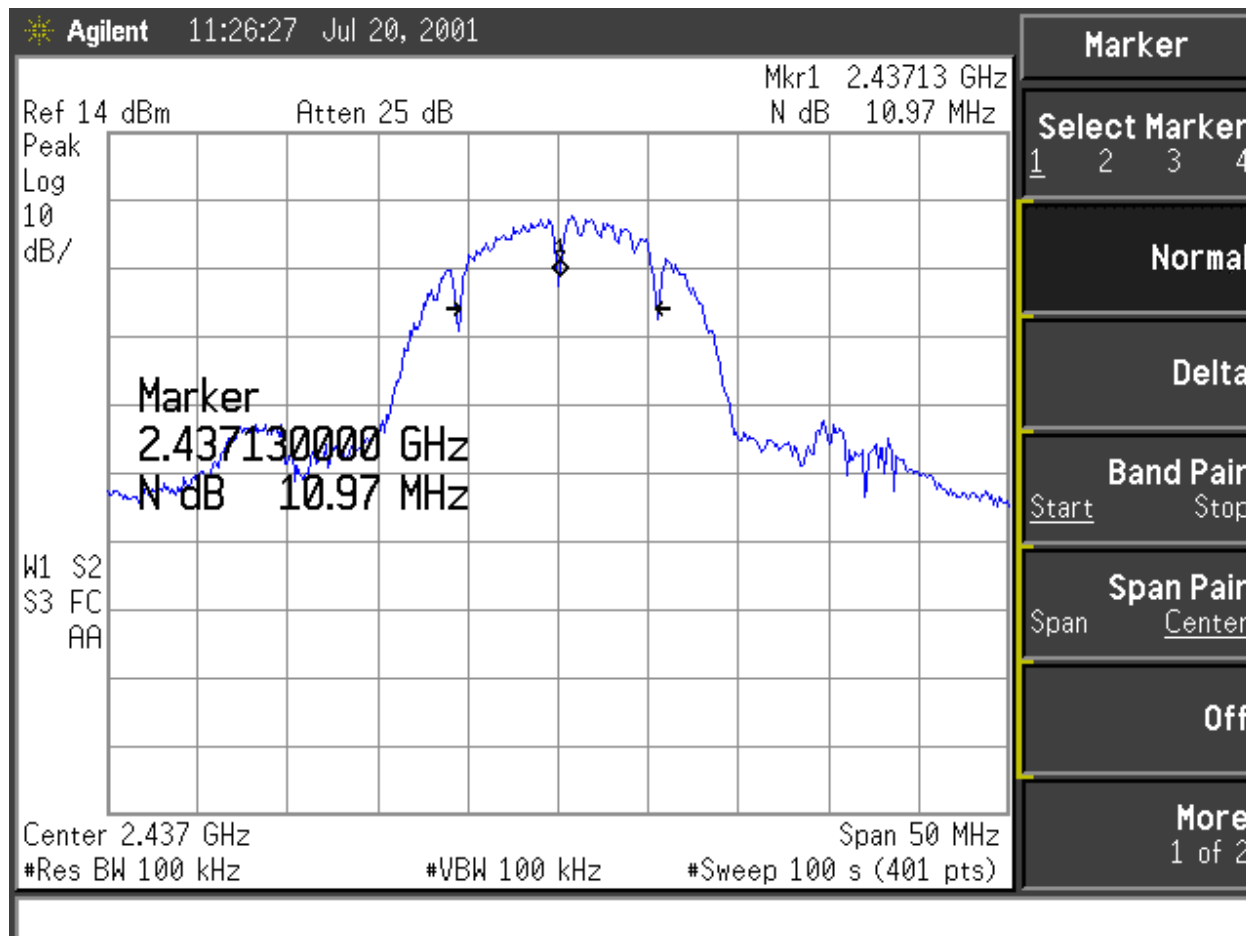

Test Condition: Channel 6: 2437 MHz, 2 Mbps

Test Limit: 500 kHz, minimum.

Test Indication: 10.97 MHz

Test Outcome: 10.97 MHz > 500 kHz → PASS

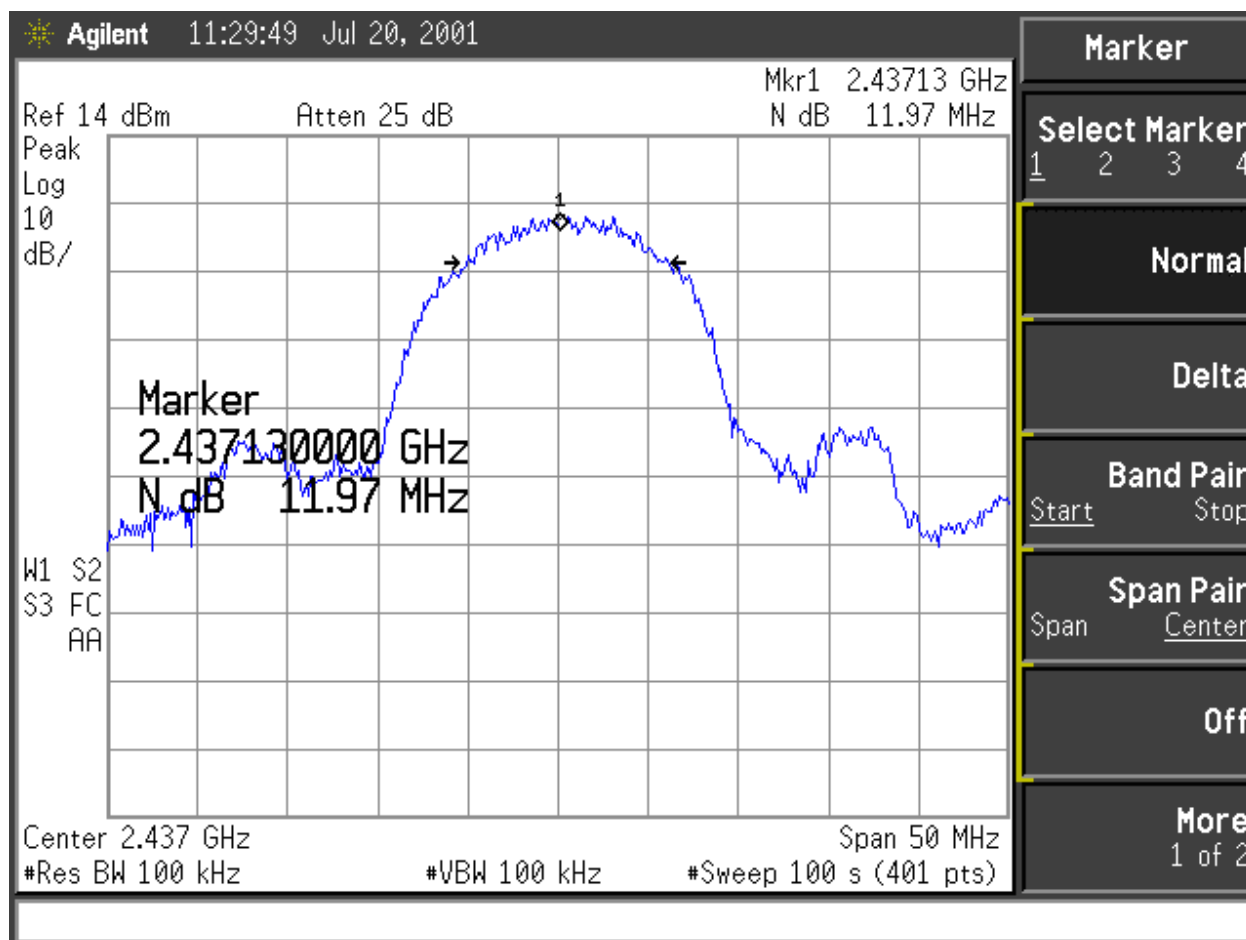

Test Condition: Channel 6: 2437 MHz, 5.5 Mbps

Test Limit: 500 kHz, minimum.

Test Indication: 11.97 MHz

Test Outcome: 11.97 MHz > 500 kHz → PASS

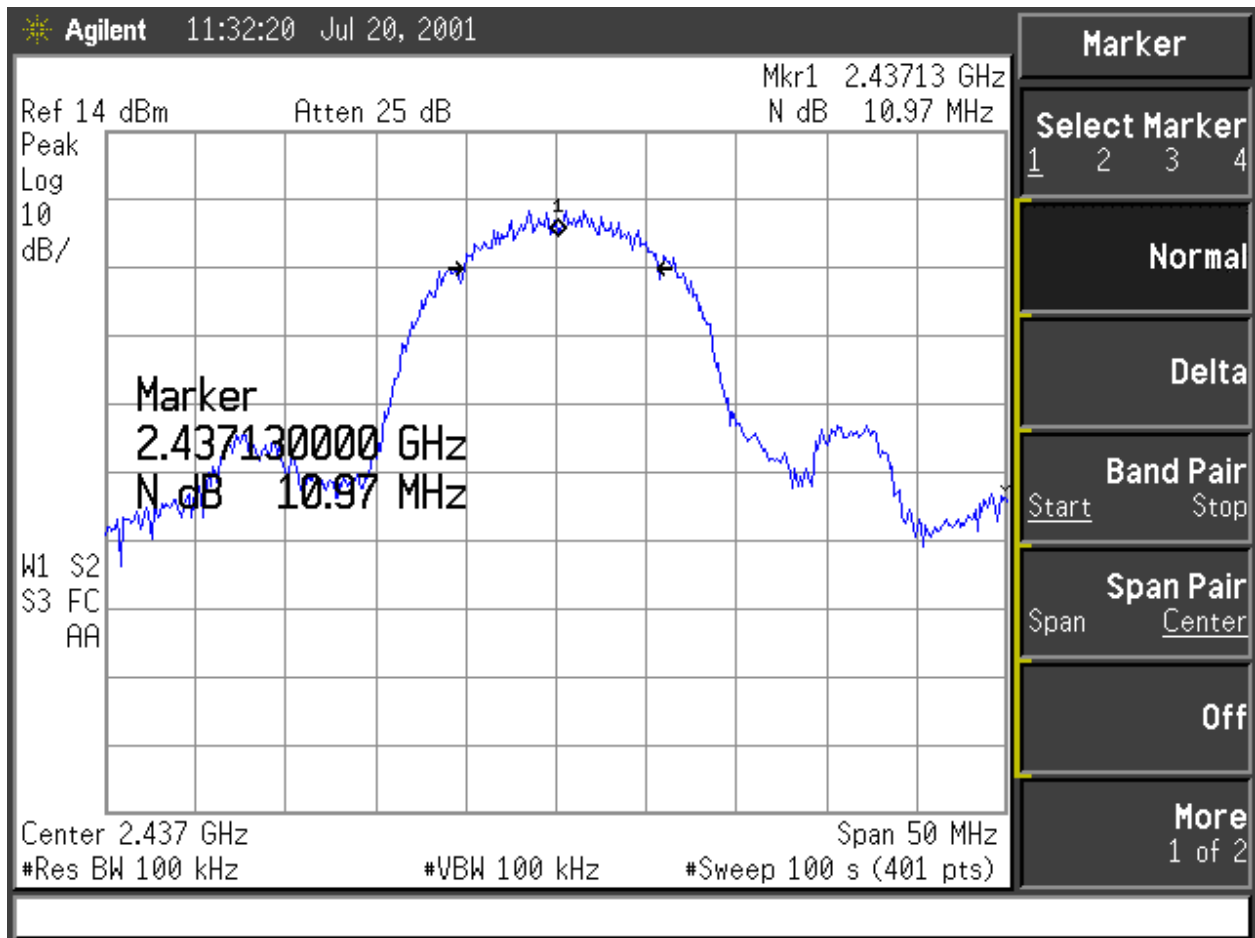

h

Test Condition: Channel 6: 2437 MHz, 11 Mbps

Test Limit: 500 kHz, minimum.

Test Indication: 10.97 MHz

Test Outcome: 10.97 MHz > 500 kHz → PASS



2. 15.247 (b) (1) Output Power

a) Test Requirement

The conducted output power of the Equipment emission must be less than 1 W (30 dBm).

$$P_o < 30 \text{ dBm}$$

b) Test Configuration

The test configuration is presented in section II-A-1b.

c) Test Conditions: Equipment Under Test

The equipment under test is tunable and is set to 3 different channels, one representing the minimum tunable frequency, one representing a midband frequency and one representing the maximum tunable frequency. The frequencies and their channel designators are presented below for reference. Secondly, since the access point is a multi-rate radio, the data (bit) rate test cases are also listed.

Channel 1: 2412 MHz , 11 Mbps

Channel 6: 2437 MHz, 1,2,5.5,11 Mbps

Channel 11: 2462 MHz , 11 Mbps

Test indications under these three frequency conditions are presented.

d) Test Conditions: Instrumentation Conditions

The readings indicated on the spectrum analyzer are a result of a direct spectrum analyzer measurement where the indications are a result of a measurement function which detects the integrated channel power between the indicated frequency limits.

Center: Center Frequency

Span: Frequency Span

Res BW: Resolution Bandwidth

VBW: Video (averaging) Bandwidth

Sweep: Frequency Sweep time over indicated frequency Span.

Integration BW: Bandwidth over which power spectral density is integrated to determine integrated channel power.

e) Test Indications

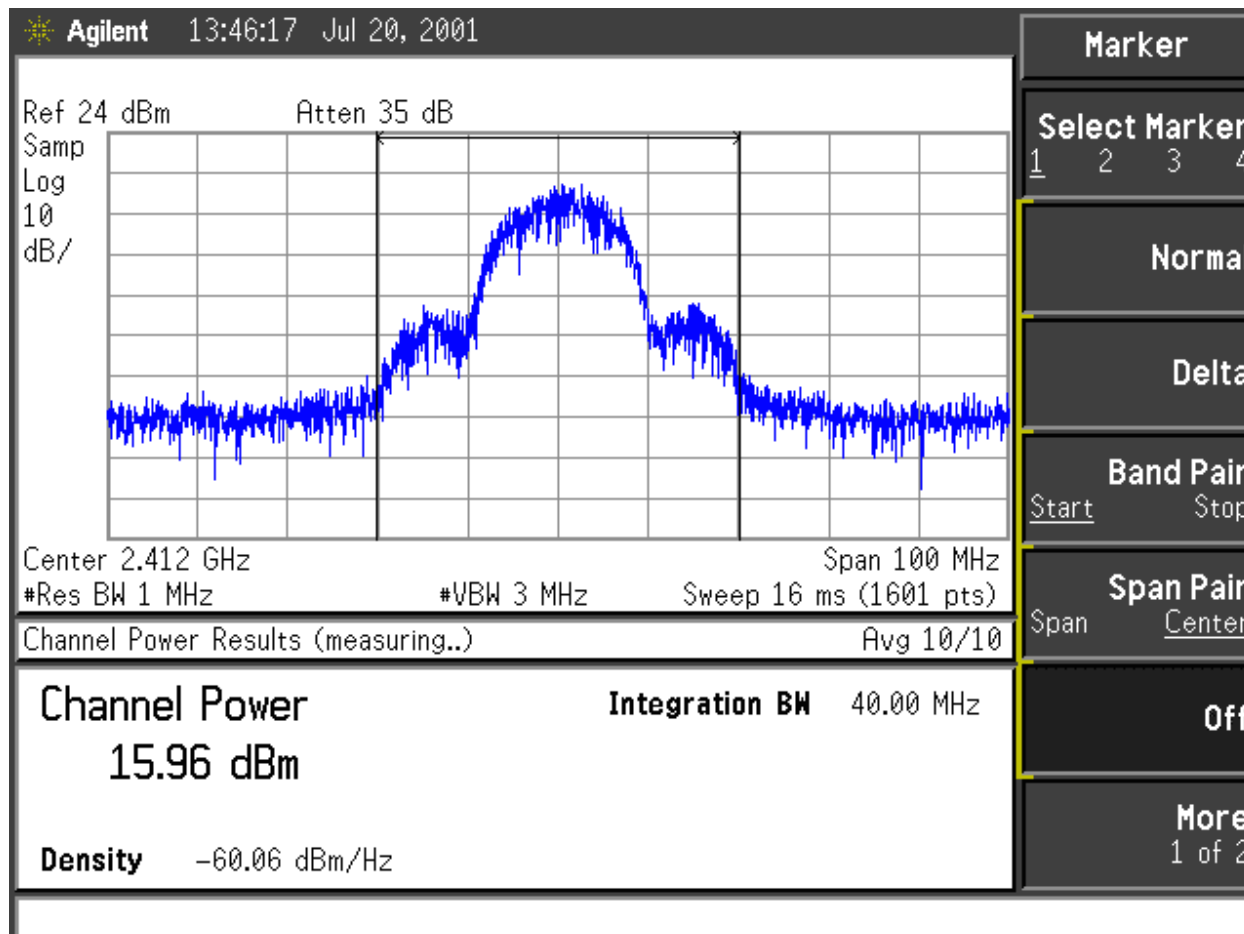

Test Condition: Channel 1: 2412 MHz, 11 Mbps

Test Limit: 30 dBm, Maximum.

Test Indication: 15.96 dBm

Test Outcome: 15.96 dBm < 30 dBm → PASS

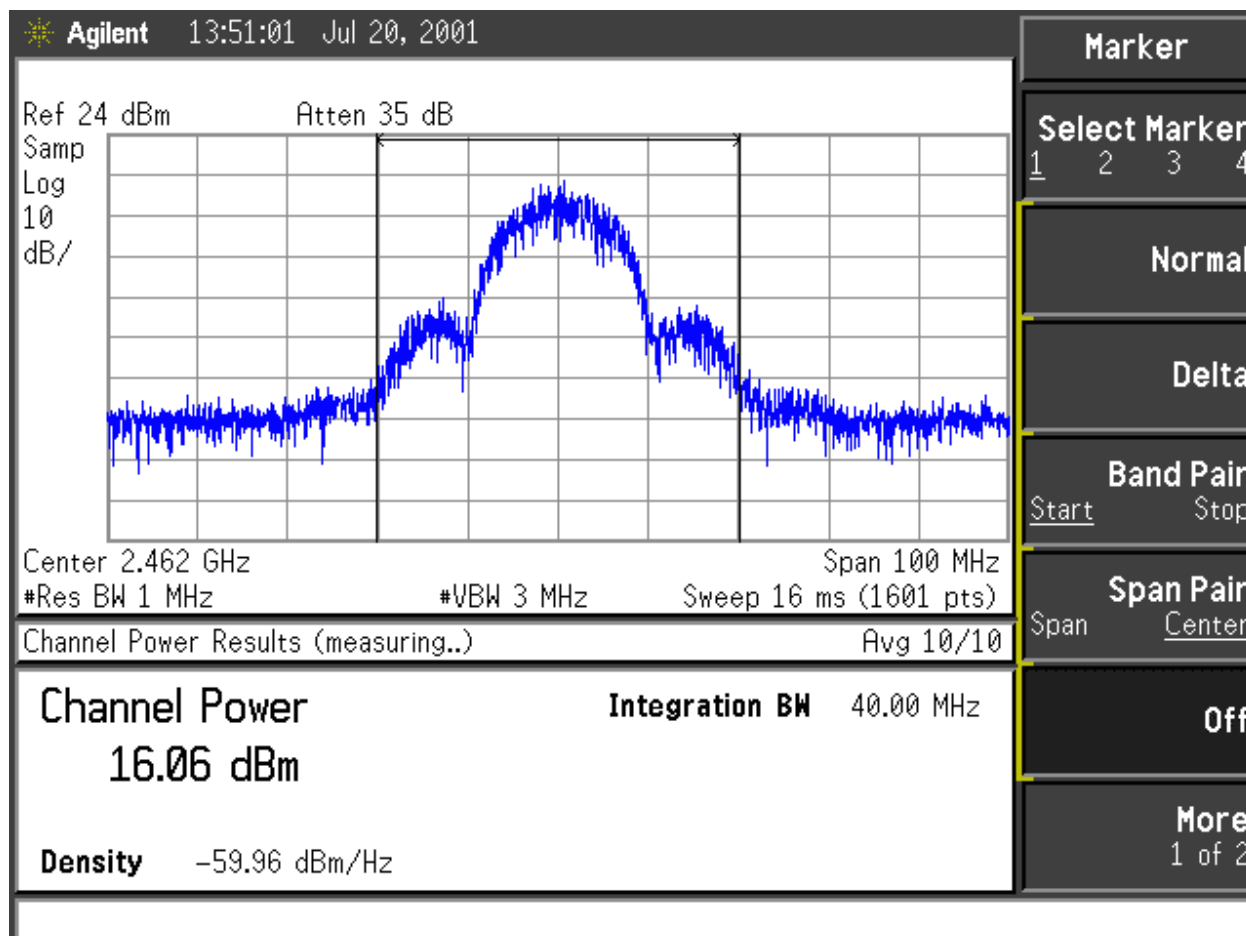

Test Condition: Channel 11: 2462 MHz, 11 Mbps

Test Limit: 30 dBm, Maximum.

Test Indication: 16.1 dBm

Test Outcome: 16.1 dBm < 30 dBm → PASS

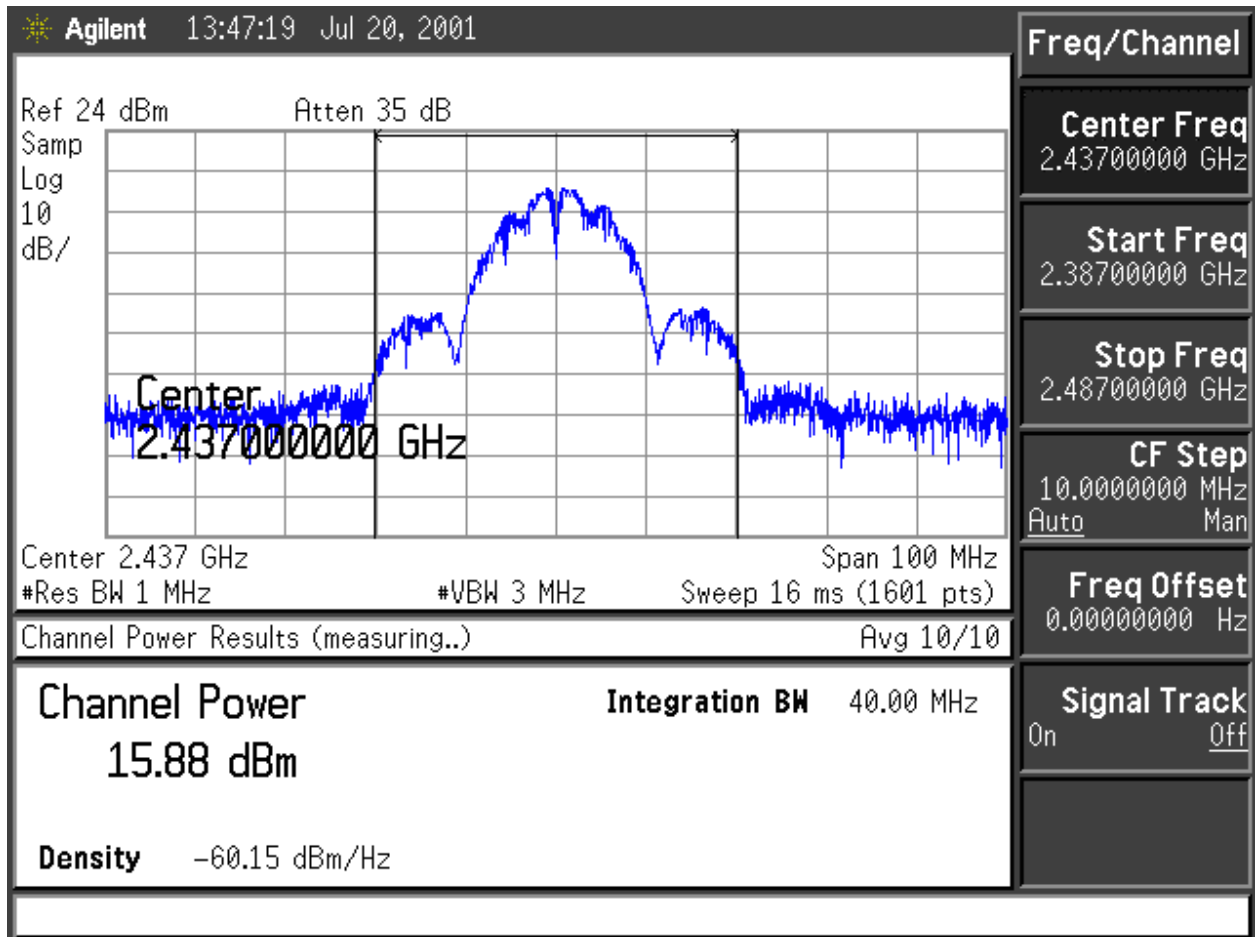

Test Condition: Channel 6: 2437 MHz, 1 Mbps

Test Limit: 30 dBm, Maximum.

Test Indication: 15.9 dBm

Test Outcome: 15.9 dBm < 30 dBm → PASS

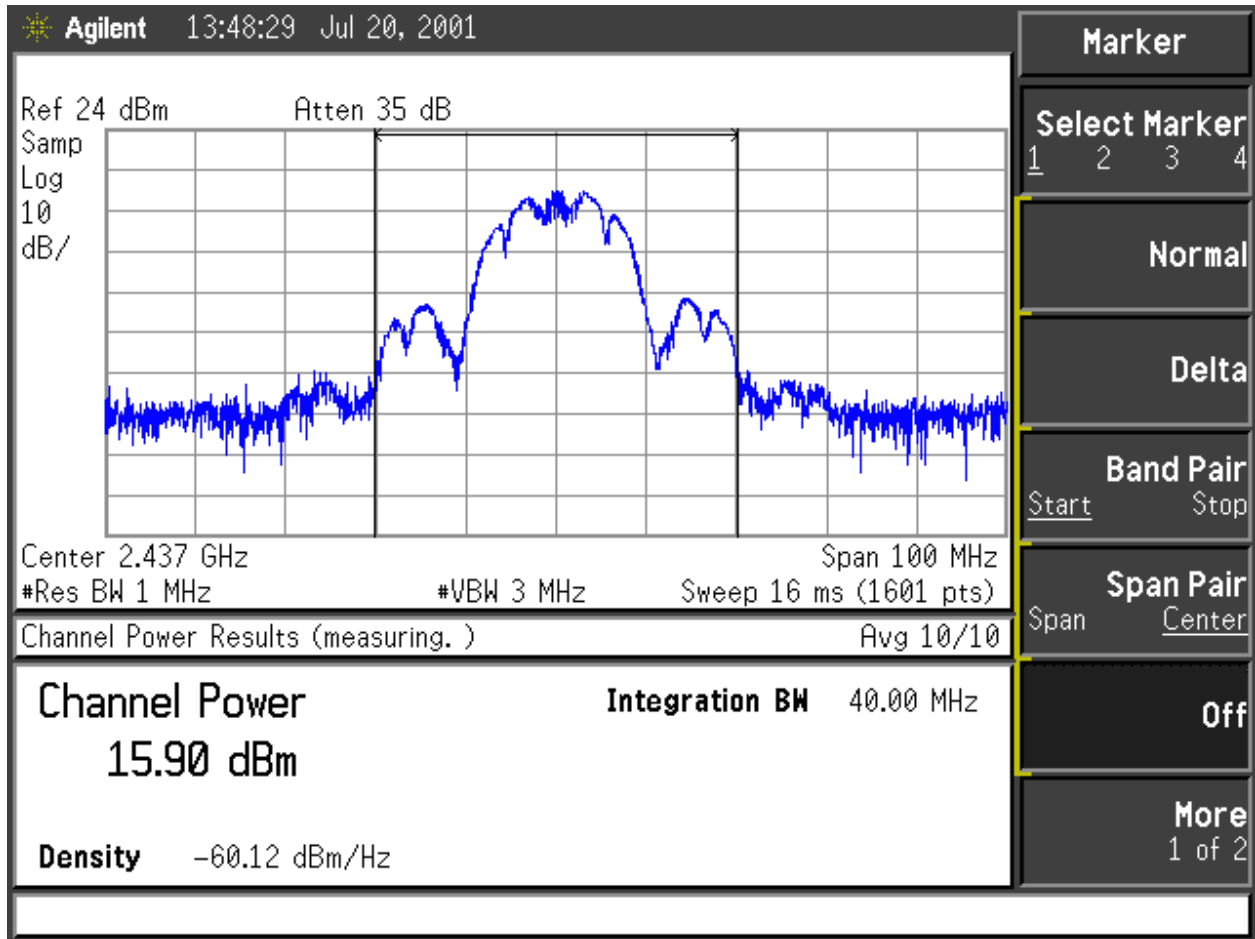

Test Condition: Channel 6: 2437 MHz, 2 Mbps

Test Limit: 30 dBm, Maximum.

Test Indication: 15.9 dBm

Test Outcome: 15.9 dBm < 30 dBm → PASS

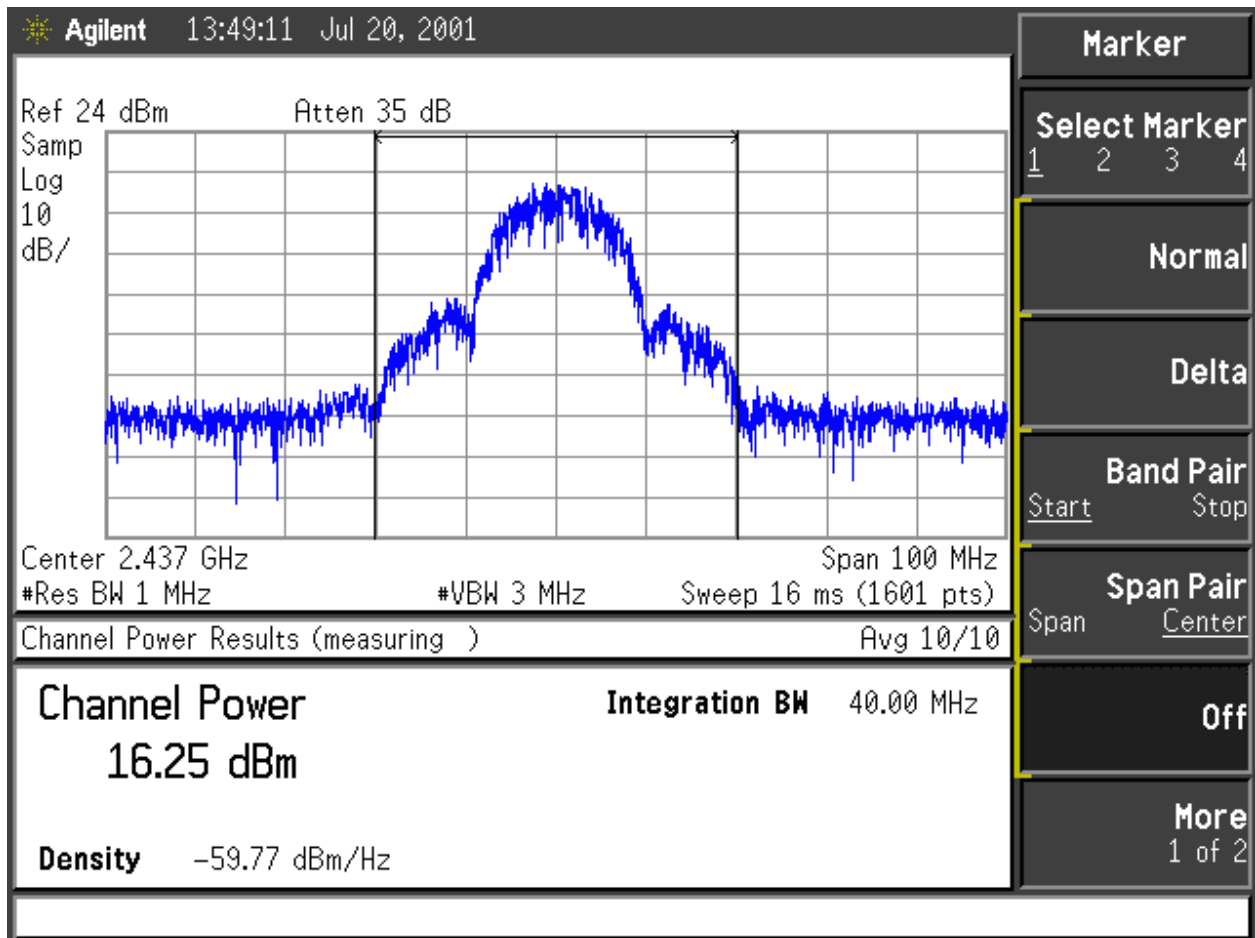

Test Condition: Channel 6: 2437 MHz, 5.5 Mbps

Test Limit: 30 dBm, Maximum.

Test Indication: 16.3 dBm

Test Outcome: 16.3 dBm < 30 dBm → PASS

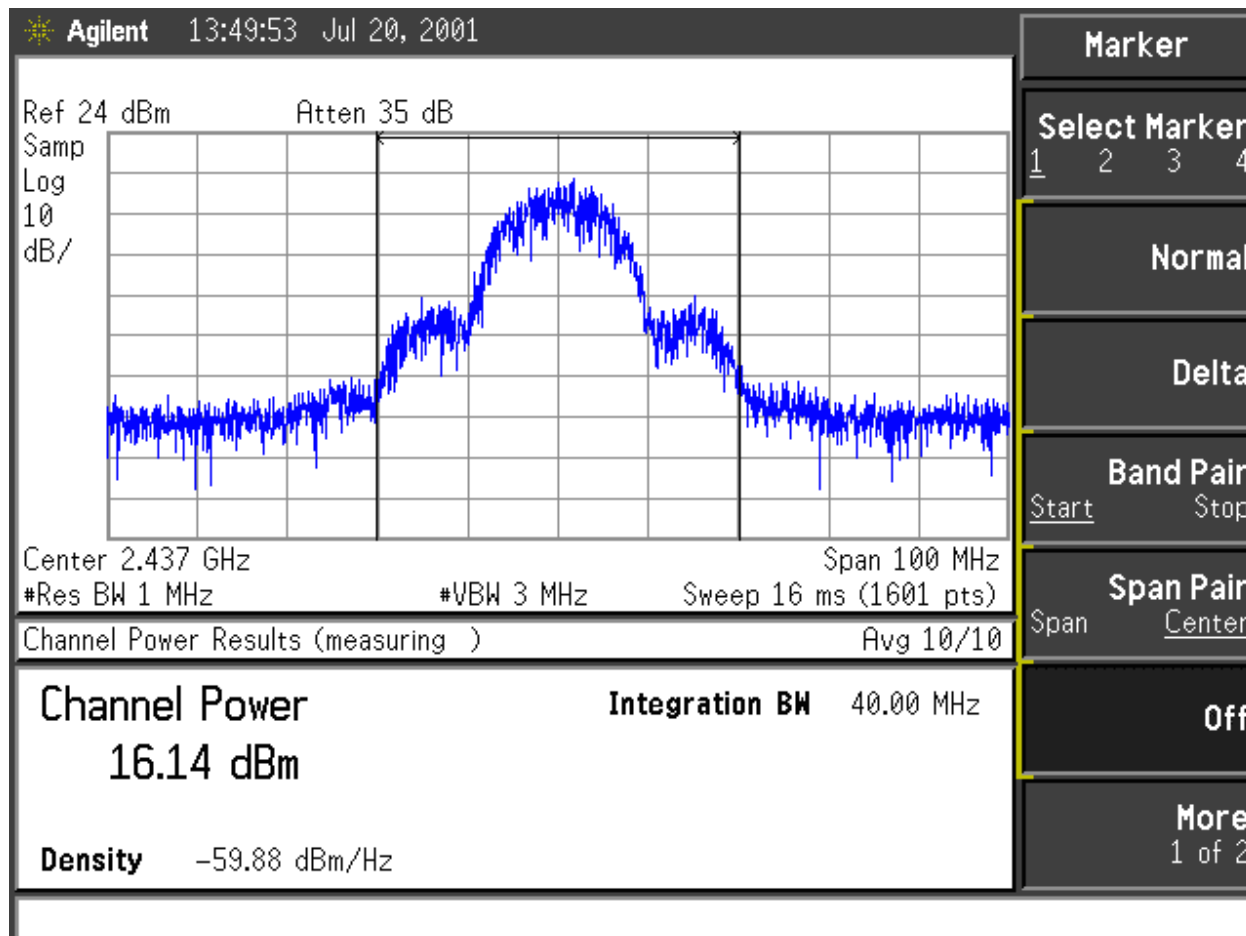

Test Condition: Channel 6: 2437 MHz, 11 Mbps

Test Limit: 30 dBm, Maximum.

Test Indication: 16.1 dBm

Test Outcome: 16.1 dBm < 30 dBm → PASS



3. 15.247 (b) (3) Effective Radiated Power

The indicated conducted power is connected to one of two sleeve dipoles. The expected power gain of the dipole antenna is 2.14 dBi. Given the maximum conducted output power and the fact that the antenna exhibits 2.14 dB of power or directive gain, the device will comply with the ERP requirement

4. 15.247 (c) Spurious Modulation Products

a) Test Requirement

The conducted spurious modulation products outside of the authorized band measured within a 100 kHz bandwidth shall be 20 dB below the authorized band peak emission measured within a 100 kHz bandwidth.

$$10 \log_{10} \left(\frac{P_{Authorized} / 100 kHz}{P_{spurious} / 100 kHz} \right) > 20 \text{ dBc}$$

b) Test Configuration

The test configuration is presented in section II-A-1b.

c) Test Conditions: Equipment Under Test

The equipment under test is tunable and is set to 3 different channels, one representing the minimum tunable frequency, one representing a midband frequency and one representing the maximum tunable frequency. The frequencies and their channel designators are presented below for reference. Secondly, since the access point is a multi-rate radio, the data (bit) rate test cases are also listed. These test conditions are for the test indications which demonstrate compliance at the authorized band-edges.

Channel 1: 2412 MHz , 11 Mbps

Channel 6: 2437 MHz, 1,2,5.5,11 Mbps

Channel 11: 2462 MHz , 11 Mbps

A wideband scan of the harmonic content is presented for channel 11 (2462 MHz) and 11 Mbps rate. This represents the declared worst-case harmonic output of the transmitter.



d) Test Conditions: Instrumentation Conditions

The following conducted spurious emissions are measured for each of the following channel and data rate settings:

Wide-band Scan of Emissions with peak emission table, 9 kHz to 24 GHz in the packet mode transmission. Peak hold mode.

In-band Scan of Emissions showing band-edge compliance in both continuous transmission and in packet mode transmission. Peak Hold Mode.

Center: Center Frequency

Span: Frequency Span

Res BW: Resolution Bandwidth

VBW: Video (averaging) Bandwidth

Sweep: Frequency Sweep time over indicated frequency Span.



e) Test Indications:

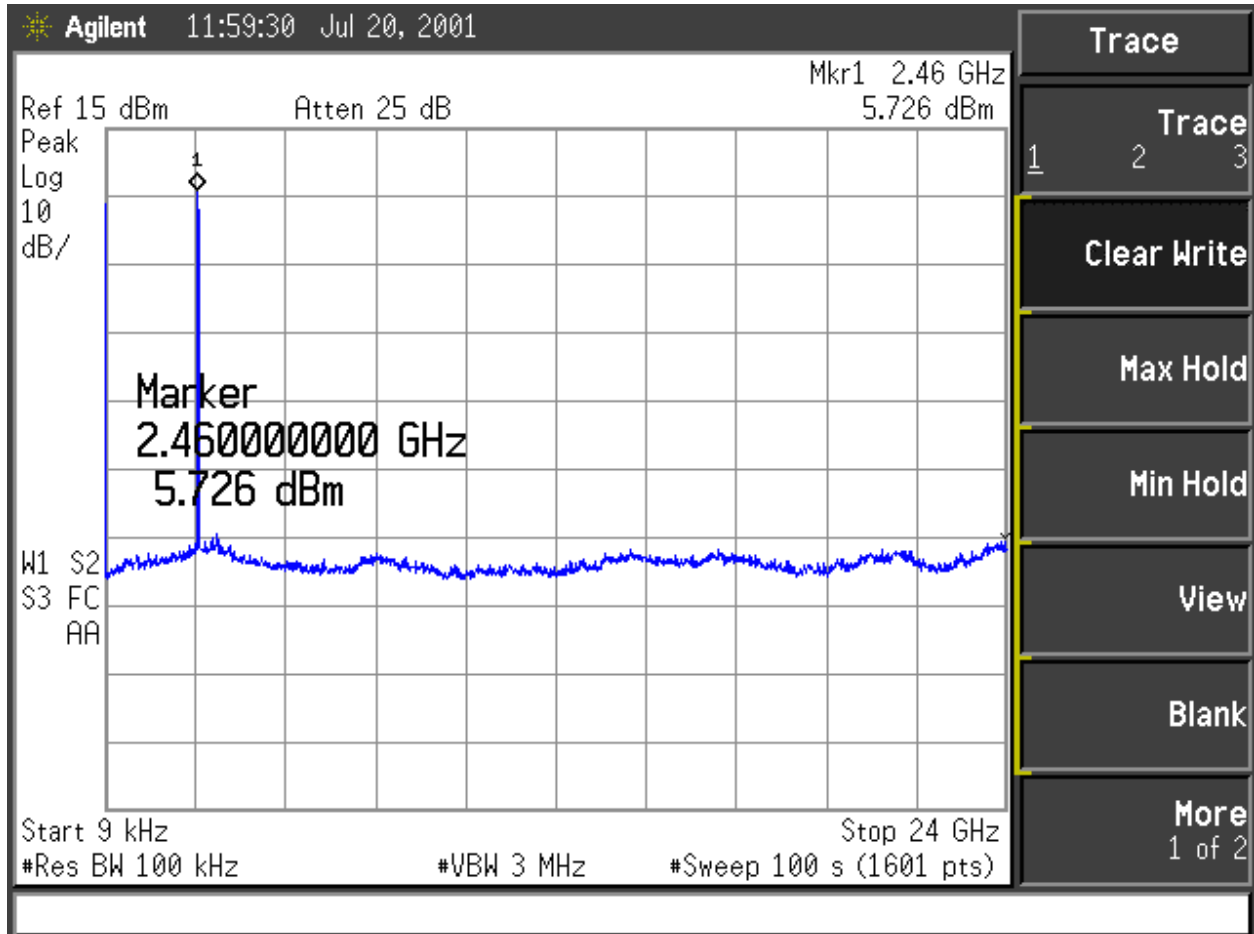

Test Condition: Channel 11: 2462 MHz, 11 Mbps, Wide Scan.

Test Limit: 20 dBc, Minimum.

Test Indication: 5.7 dBm/100 kHz-(-45 dBm/100 kHz)

= 50.7 dBc

Test Outcome: 50.7 dBc > 20 dBc → PASS

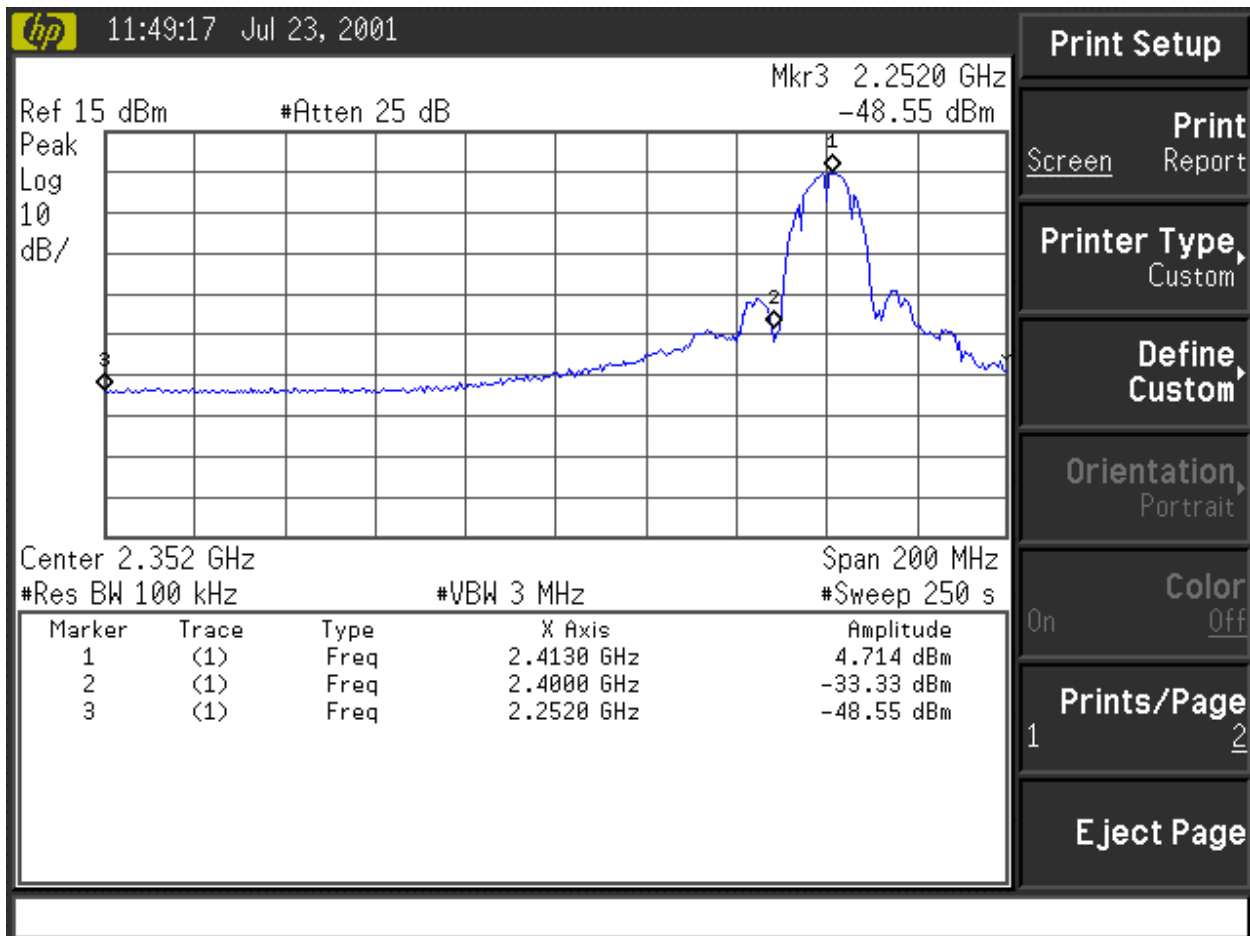

Test Condition: Channel 1: 2412 MHz, 1 Mbps

Test Limit: 20 dBc, Minimum.

Test Indication: 4.7 dBm/100 kHz-(-33.3 dBm/100 kHz)

= 38.0 dBc

Test Outcome: 38.0 dBc > 20 dBc → PASS

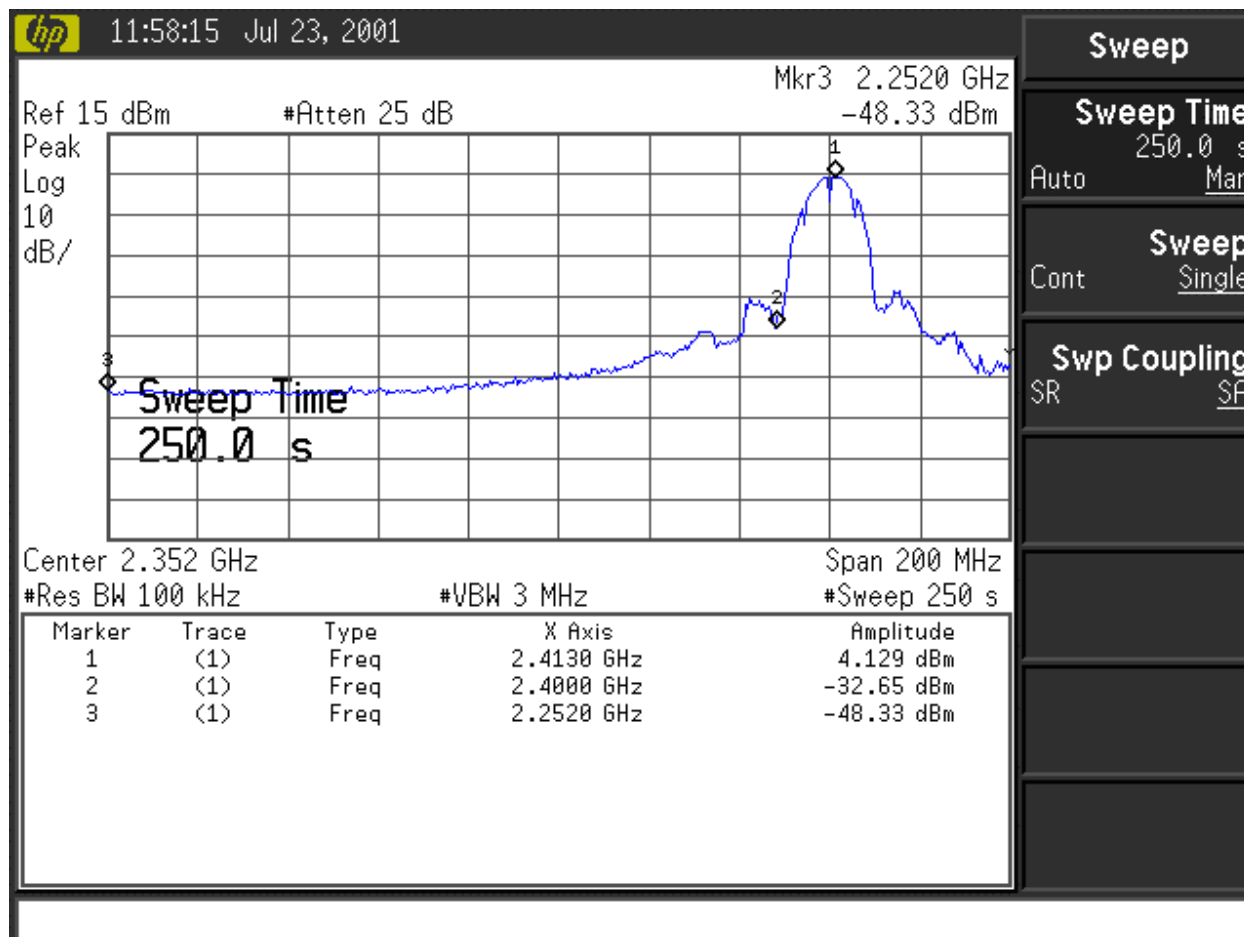

Test Condition: Channel 1: 2412 MHz, 2 Mbps

Test Limit: 20 dBc, Minimum.

Test Indication: 4.1 dBm/100 kHz-(-32.7 dBm/100 kHz)

= 36.8 dBc

Test Outcome: 36.8 dBc > 20 dBc → PASS

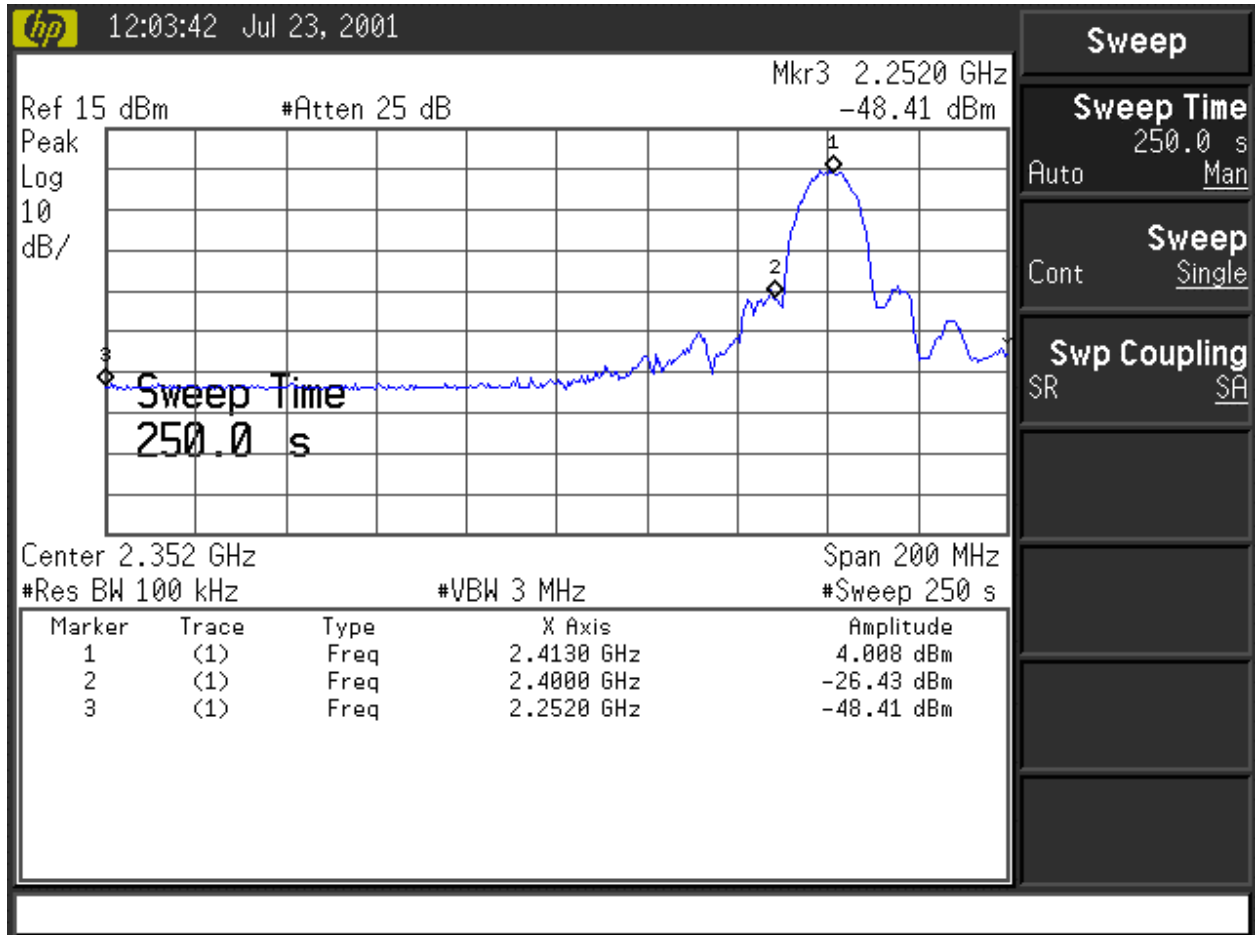

Test Condition: Channel 1: 2412 MHz, 5.5 Mbps

Test Limit: 20 dBc, Minimum.

Test Indication: 4.0 dBm/100 kHz-(-26.4 dBm/100 kHz)

= 30.4 dBc

Test Outcome: 30.4 dBc > 20 dBc → PASS

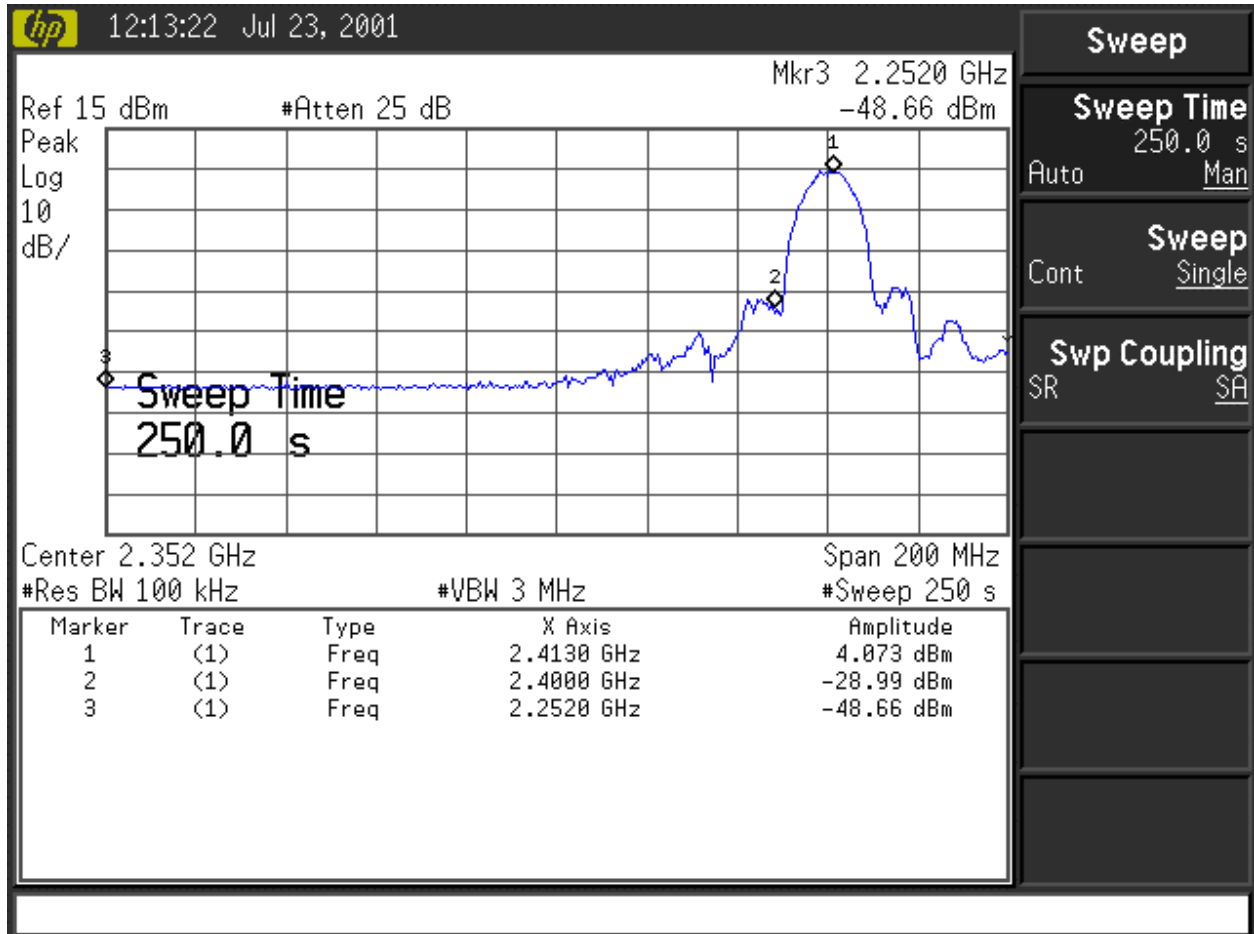

Test Condition: Channel 1: 2412 MHz, 11 Mbps

Test Limit: 20 dBc, Minimum.

Test Indication: 4.1 dBm/100 kHz-(-29 dBm/100 kHz)

= 33.1 dBc

Test Outcome: 33.1 dBc > 20 dBc → PASS

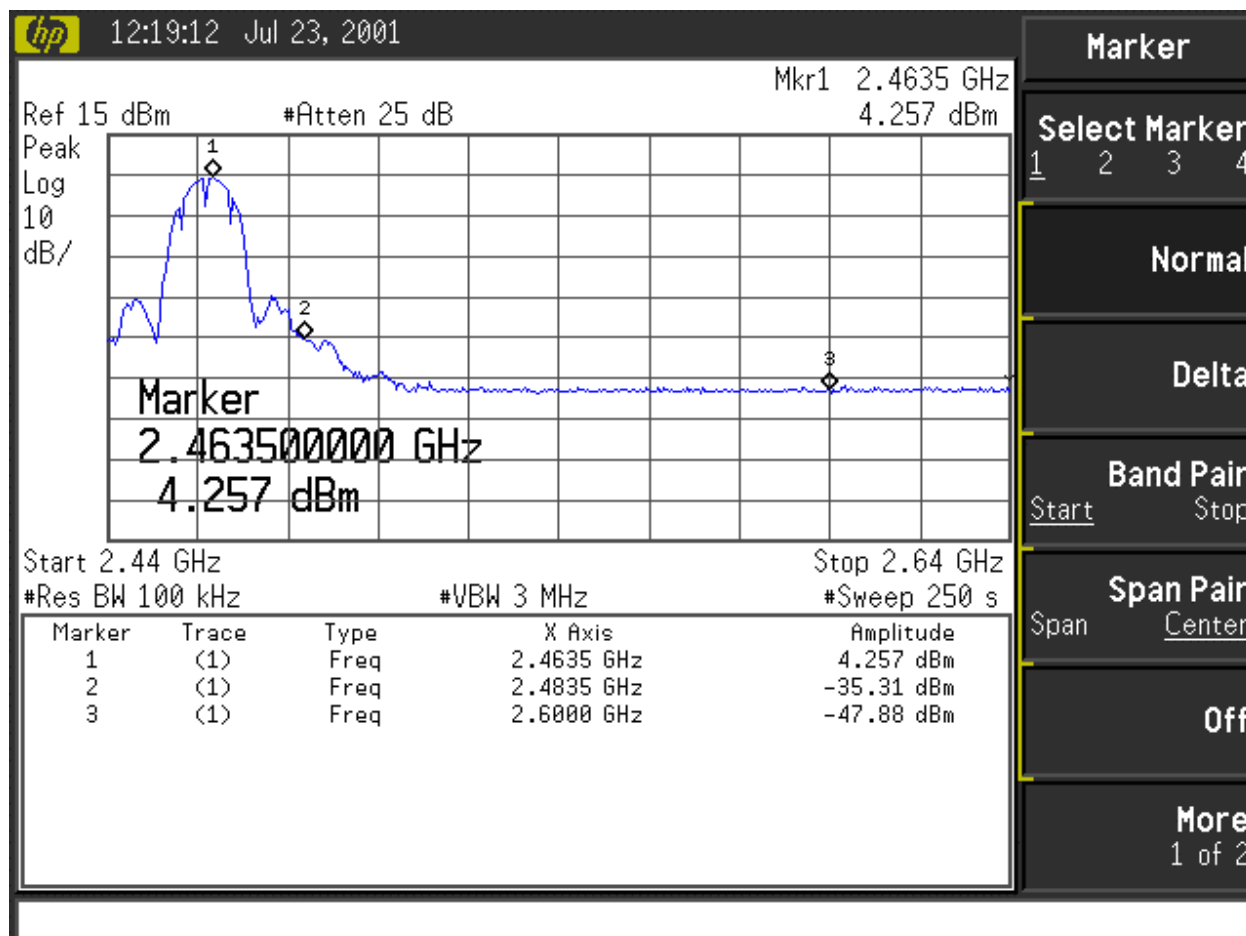

Test Condition: Channel 11: 2462 MHz, 1 Mbps

Test Limit: 20 dBc, Minimum.

Test Indication: 4.3 dBm/100 kHz-(-35.3 dBm/100 kHz)

= 39.6 dBc

Test Outcome: 39.6 dBc > 20 dBc → PASS

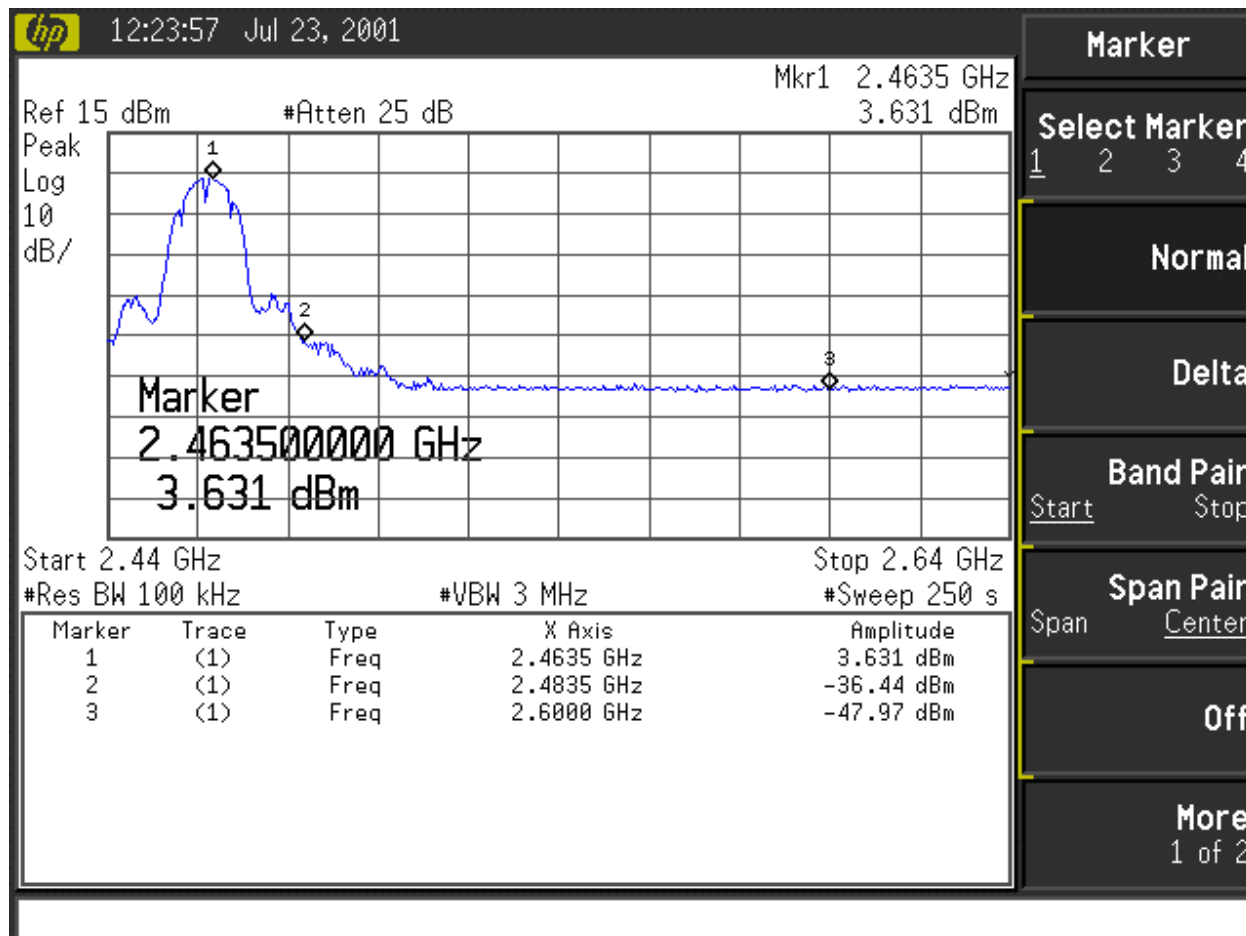

Test Condition: Channel 11: 2462 MHz, 2 Mbps

Test Limit: 20 dBc, Minimum.

Test Indication: 3.6 dBm/100 kHz-(-36.4 dBm/100 kHz)

= 40.0 dBc

Test Outcome: 40.0 dBc > 20 dBc → PASS

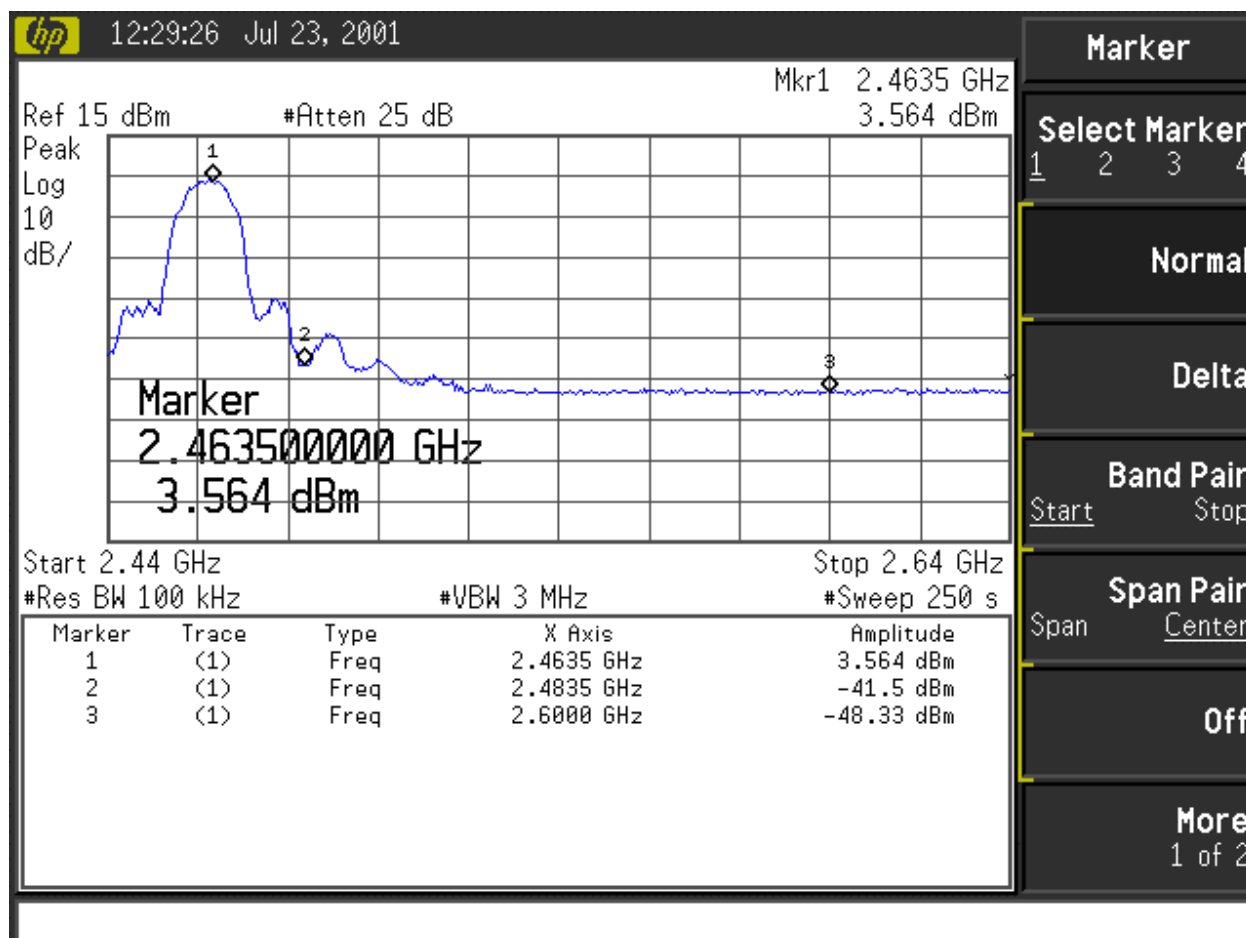

Test Condition: Channel 11: 2462 MHz, 5.5 Mbps

Test Limit: 20 dBc, Minimum.

Test Indication: 3.6 dBm/100 kHz-(-41.5 dBm/100 kHz)

= 45.1 dBc

Test Outcome: 45.1 dBc > 20 dBc → PASS

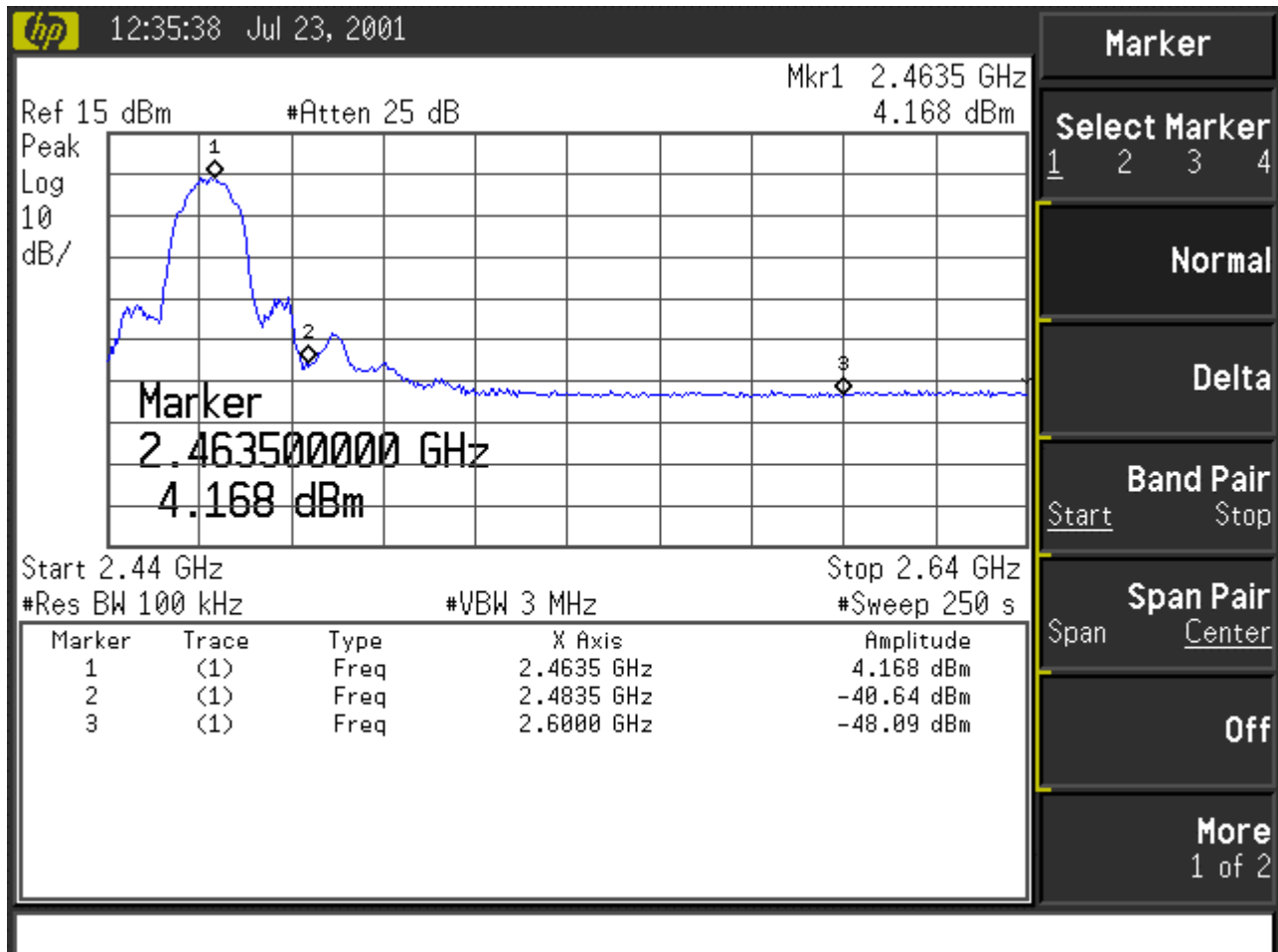

Test Condition: Channel 11: 2462 MHz, 11 Mbps

Test Limit: 20 dBc, Minimum.

Test Indication: 4.1 dBm/100 kHz-(-40.6 dBm/100 kHz)

= 44.7 dBc

Test Outcome: 44.7 dBc > 20 dBc → PASS



5. 15.247 (d) Power Spectral Density

a) Test Requirement

The maximum power spectral density allowed in the authorized band is 8 dBm/3kHz.

$$P_{authorized} / 3kHz < 8 \text{ dBm} / 3kHz$$

b) Test Configuration

The test configuration is presented in section II-A-1b.

c) Test Conditions: Equipment Under Test

The equipment under test is tunable and is set to 3 different channels, one representing the minimum tunable frequency, one representing a midband frequency and one representing the maximum tunable frequency. The frequencies and their channel designators are presented below for reference. Secondly, since the access point is a multi-rate radio, the data (bit) rate test cases are also listed.

Channel 1: 2412 MHz , 1,11 Mbps

Channel 6: 2437 MHz, 1,2,5.5,11 Mbps

Channel 11: 2462 MHz , 1,11 Mbps

Test indications under these eight frequency and bit rate conditions are presented.

The following conducted power spectral densities are measured for each channel setting:



d) Test Conditions: Instrumentation

The localized peak in the emission spectrum is examined using the noise marker function implemented by the spectrum analyzer. The noise marker method is chosen, since the spectral lines of the emission are not resolvable and have noise-like properties. The power spectral density as indicated is measured in a 1 Hz bandwidth and is corrected for measurement artifacts such as noise bandwidth, and logarithmic amplification weighting. The test indication is then re-normalized to a 3 kHz bandwidth by adding the following correction factor:

$$10 \log_{10} \left(\frac{3 \text{ kHz}}{1 \text{ Hz}} \right) = 34.8 \text{ dB}$$

Center: Center Frequency

Span: Frequency Span

Res BW: Resolution Bandwidth

VBW: Video (averaging) Bandwidth

Sweep: Frequency Sweep time over indicated frequency Span.

e) Test Indications

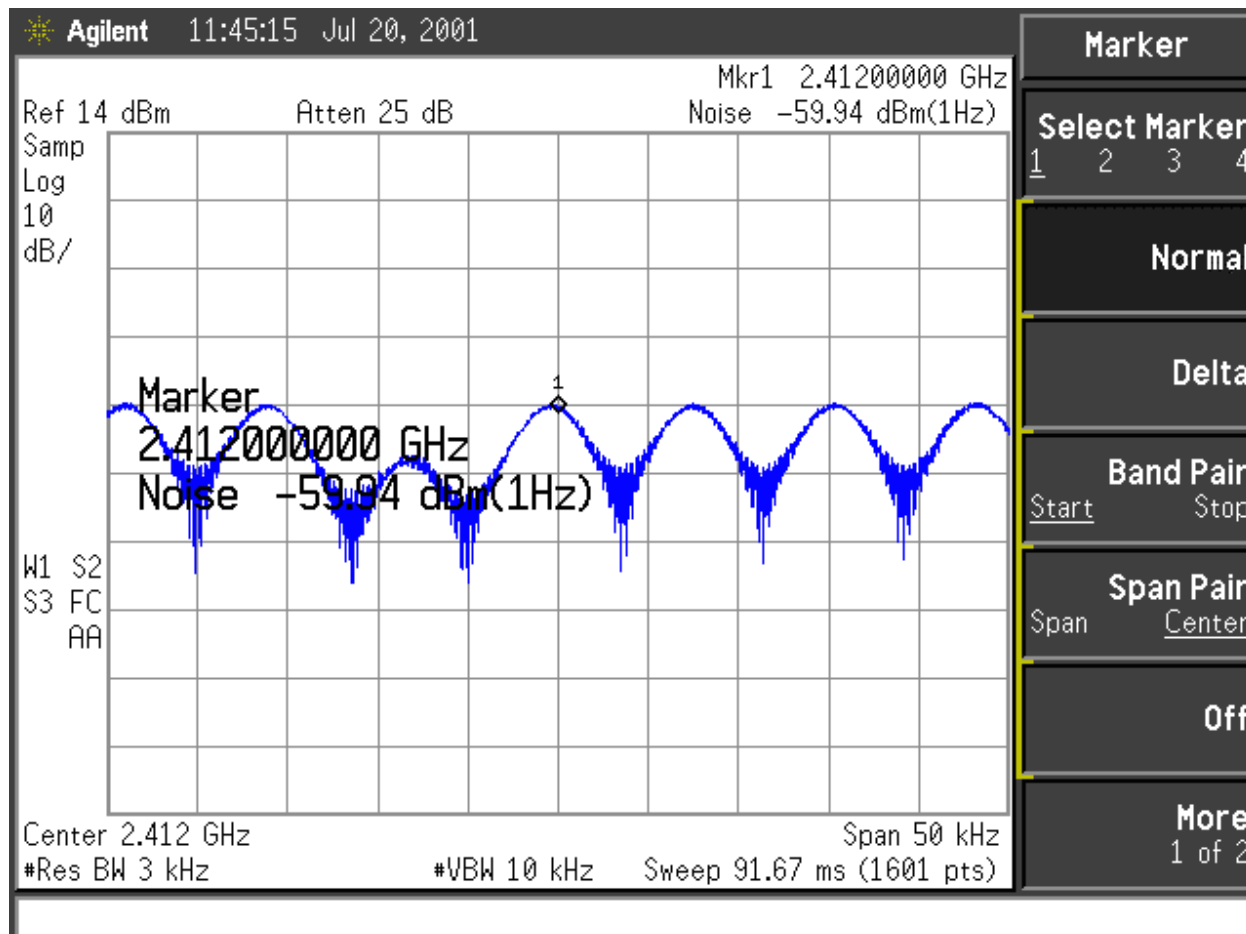

Test Condition: Channel 1: 2412 MHz, 1 Mbps

Test Limit: 8 dBm/3 kHz, Maximum.

Test Indication: -59.94 dBm/Hz + 34.8 dB = -25.14 dBm/3kHz

Test Outcome: -25.14 dBm/3kHz < 8 dBm/3kHz → PASS

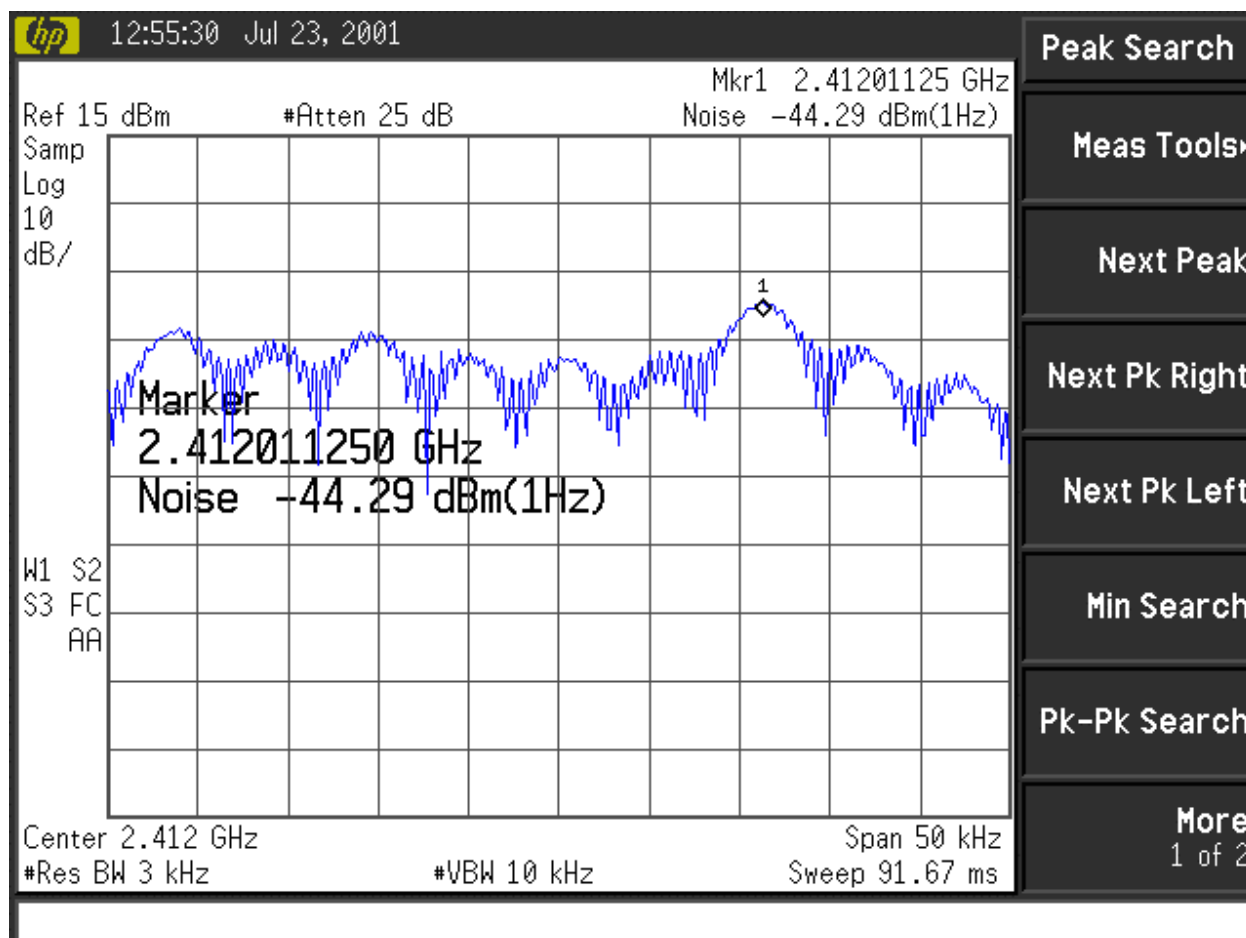

Test Condition: Channel 1: 2412 MHz, 11 Mbps

Test Limit: 8 dBm/3 kHz, Maximum.

Test Indication: -44.29 dBm/Hz + 34.8 dB = -9.49 dBm/3kHz

Test Outcome: -9.49 dBm/3kHz < 8 dBm/3kHz → PASS

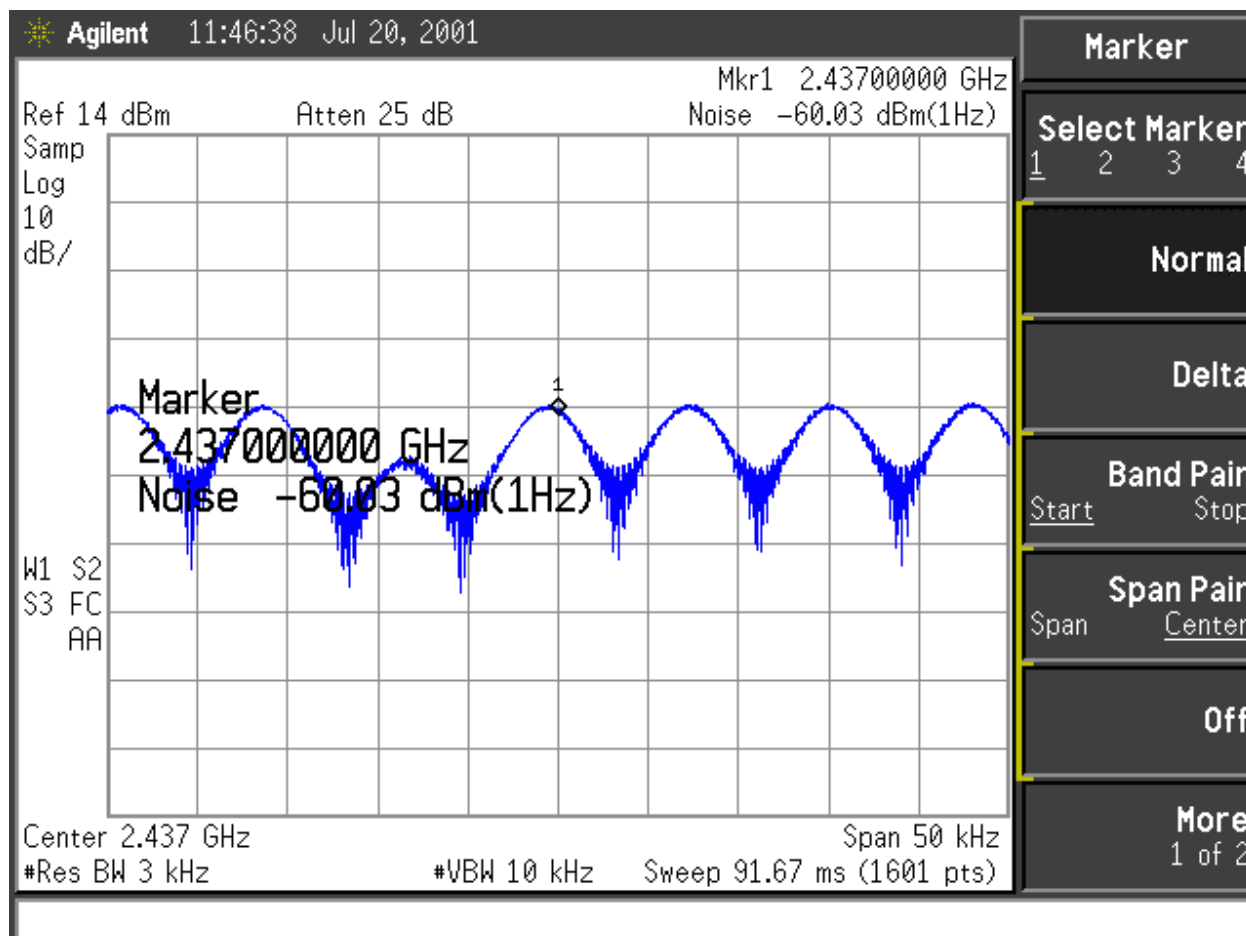

Test Condition: Channel 6: 2437 MHz, 1 Mbps

Test Limit: 8 dBm/3 kHz, Maximum.

Test Indication: -60.03 dBm/Hz + 34.8 dB = -25.23 dBm/3kHz

Test Outcome: -25.23 dBm/3kHz < 8 dBm/3kHz → PASS

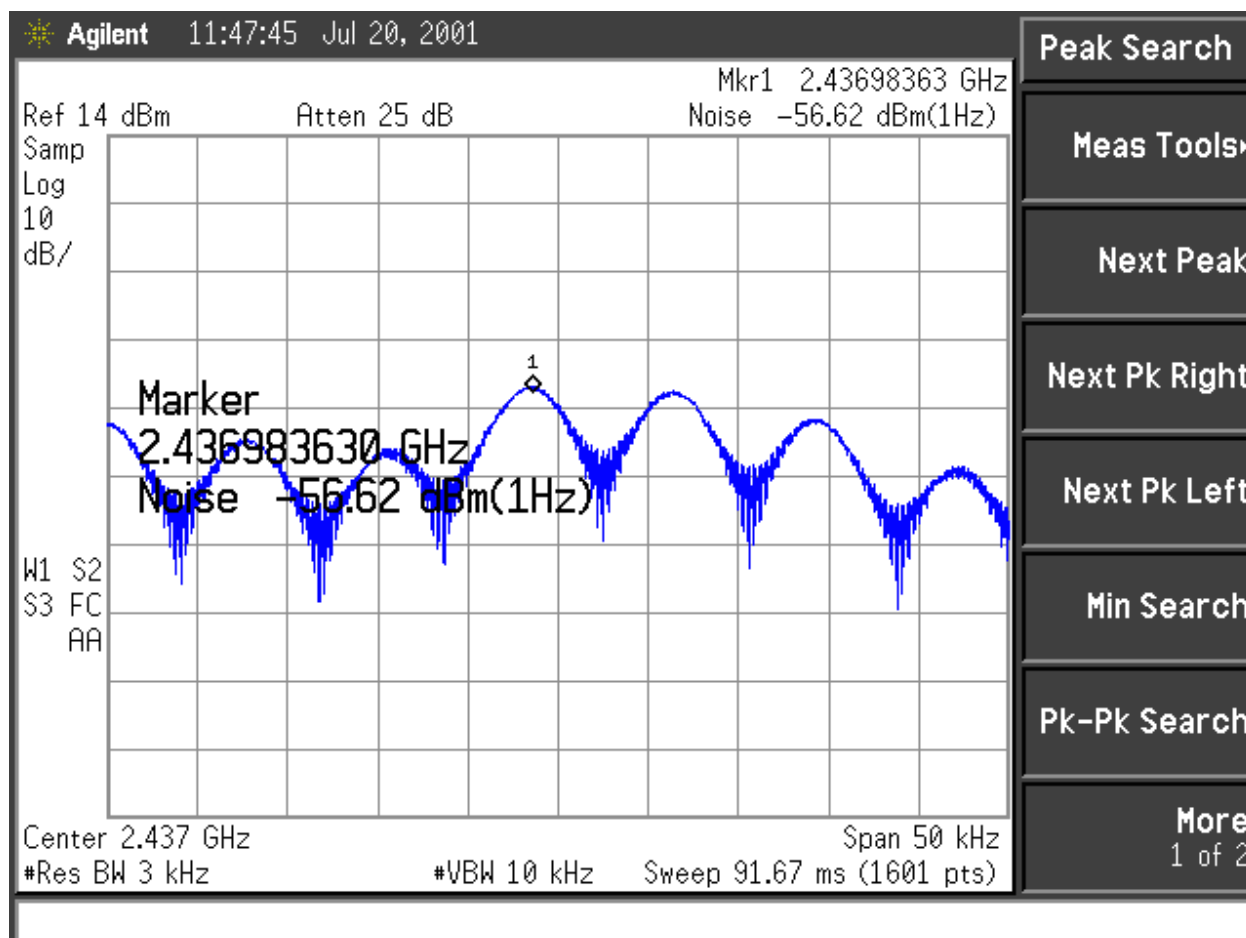

Test Condition: Channel 6: 2437 MHz, 2 Mbps

Test Limit: 8 dBm/3 kHz, Maximum.

Test Indication: -56.62 dBm/Hz + 34.8 dB = -21.82 dBm/3kHz

Test Outcome: -21.82 dBm/3kHz < 8 dBm/3kHz → PASS

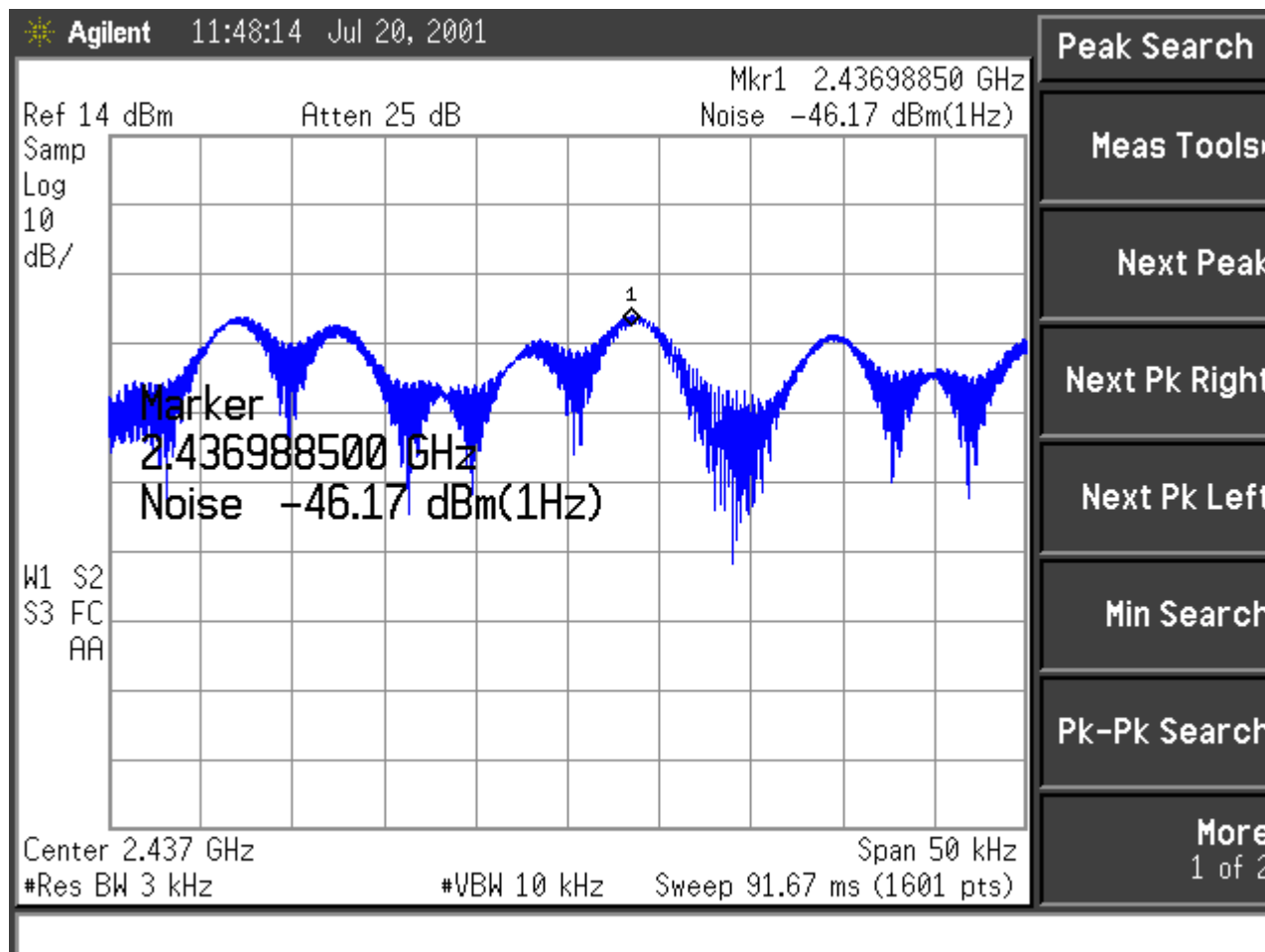

Test Condition: Channel 6: 2437 MHz, 5.5 Mbps

Test Limit: 8 dBm/3 kHz, Maximum.

Test Indication: -46.17 dBm/Hz + 34.8 dB = -11.37 dBm/3kHz

Test Outcome: -11.37 dBm/3kHz < 8 dBm/3kHz → PASS

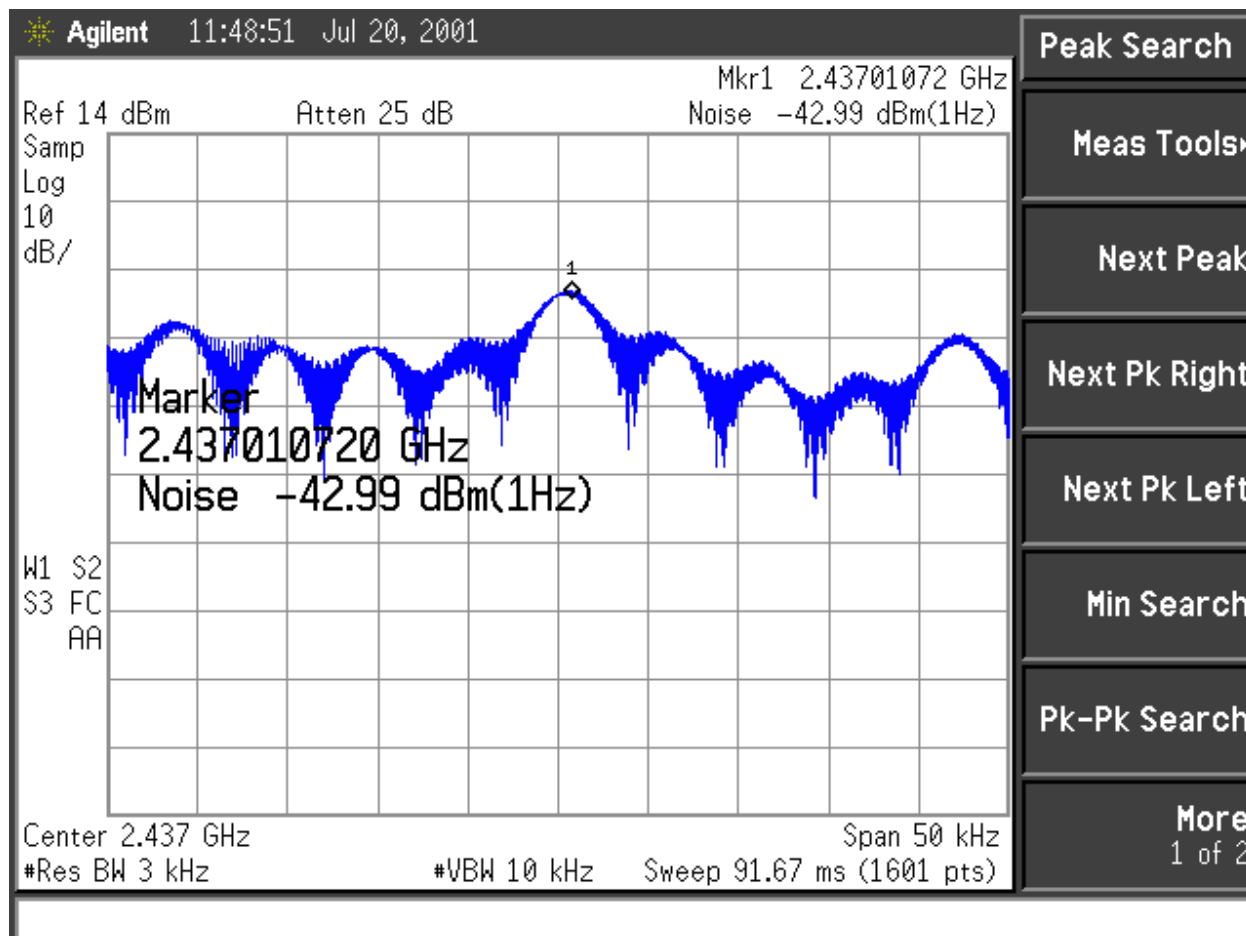

Test Condition: Channel 6: 2437 MHz, 11 Mbps

Test Limit: 8 dBm/3 kHz, Maximum.

Test Indication: -42.99 dBm/Hz + 34.8 dB = -8.19 dBm/3kHz

Test Outcome: -8.19 dBm/3kHz < 8 dBm/3kHz → PASS

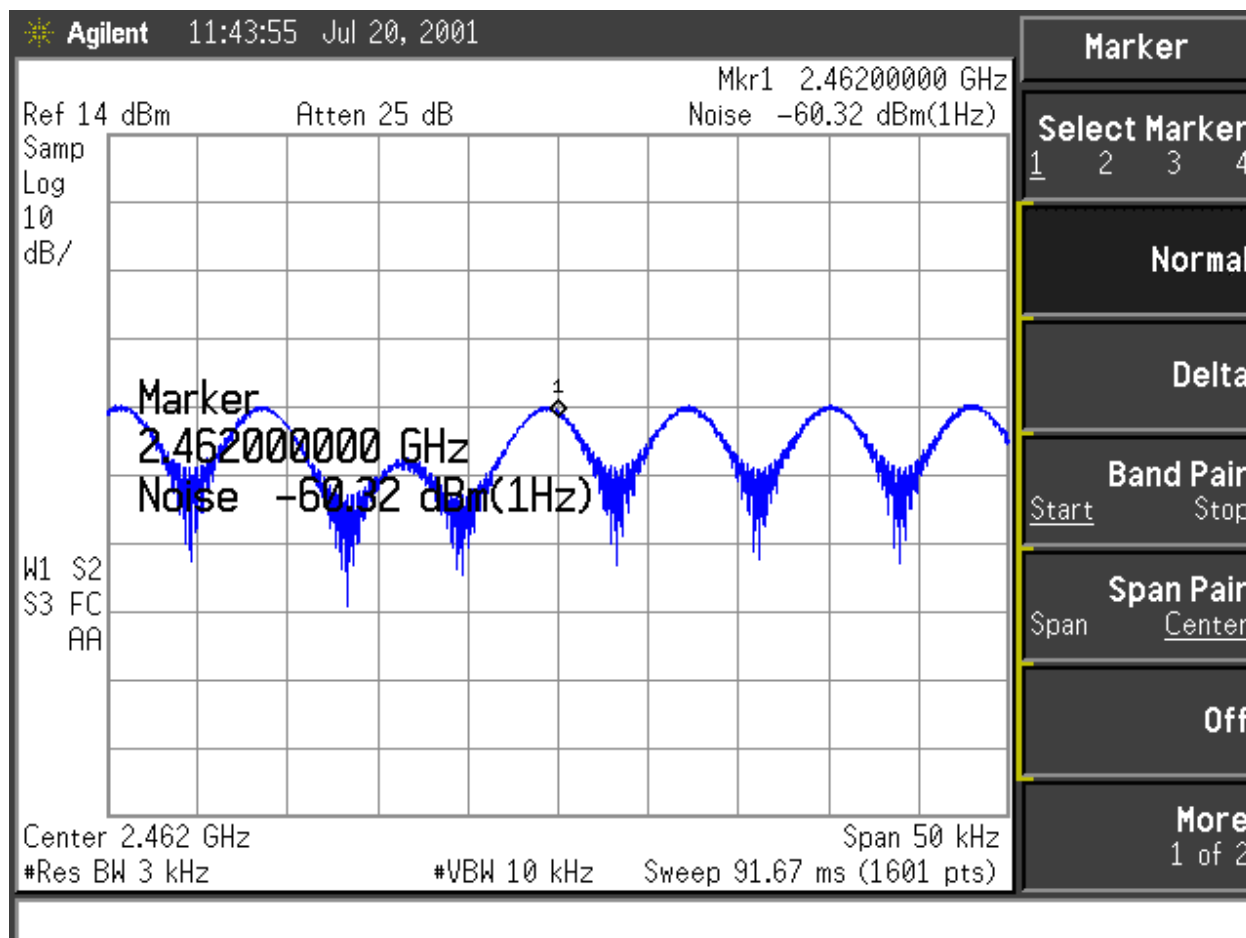

Test Condition: Channel 11: 2462 MHz, 1 Mbps

Test Limit: 8 dBm/3 kHz, Maximum.

Test Indication: -60.32 dBm/Hz + 34.8 dB = -25.52 dBm/3kHz

Test Outcome: -25.52 dBm/3kHz < 8 dBm/3kHz → PASS

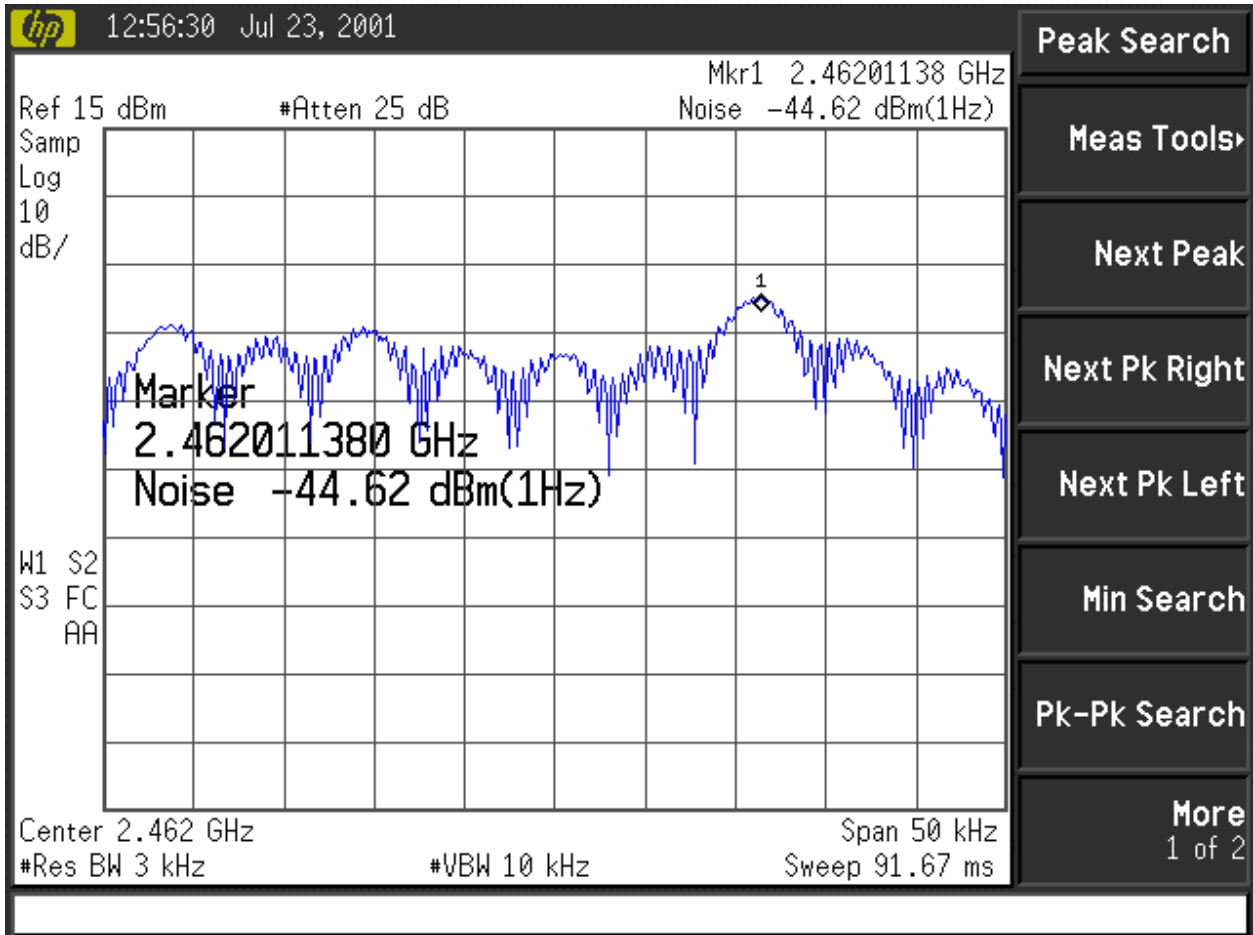

Test Condition: Channel 11: 2462 MHz, 11 Mbps

Test Limit: 8 dBm/3 kHz, Maximum.

Test Indication: -44.62 dBm/Hz + 34.8 dB = -9.82 dBm/3kHz

Test Outcome: -16.68 dBm/3kHz < 8 dBm/3kHz → PASS



IV. Critical Equipment List

EQUIPMENT DESCRIPTION	LSR Serial Number	Serial Number	Calibration
Agilent E4402B Spectrum Analyzer	CC00225C	US390102040	4/3/2000
Agilent E4407B Spectrum Analyzer	CC000221C	US39160256	11/8/2000

V. Equipment Uncertainties

Specified Characteristic	Specified Probability Density	Specified Uncertainty
Agilent E4407B Spectrum Analyzer		
Agilent E4402B Spectrum Analyzer		
Total Absolute Amplitude Uncertainty	Uniform	+/-0.35 dB