**CETECOM™****CETECOM ICT Services**
consulting - testing - certification >>>

TEST REPORT

Test report no.: 1-3897/11-01-12-A



Testing laboratory

CETECOM ICT Services GmbH
Untertuerkheimer Strasse 6 – 10
66117 Saarbruecken / Germany
Phone: + 49 681 5 98 - 0
Fax: + 49 681 5 98 - 9075
Internet: <http://www.cetecom.com>
e-mail: ict@cetecom.com**Accredited Testing Laboratory:**The testing laboratory (area of testing) is accredited according to DIN EN ISO/IEC 17025 (2005) by the Deutsche Akkreditierungsstelle GmbH (DAkkS). The accreditation is valid for the scope of testing procedures as stated in the accreditation certificate with the registration number: D-PL-12076-01-01
Area of Testing: Radio/Satellite Communications

Applicant

beyerdynamic GmbH & Co. KG
Theresienstraße 8
74072 Heilbronn / GERMANY
Phone: +49 7131 617-0
Fax: +49 7131 617-215
Contact: Ulrich Roth
e-mail: roth@beyerdynamic.de
Phone: +49 7131 617-155

Manufacturer

beyerdynamic GmbH & Co. KG
Theresienstraße 8
74072 Heilbronn / GERMANY

Test standard/s

47 CFR Part 74 Title 47 of the Code of Federal Regulations; Chapter I
Part 74 - Experimental radio, auxiliary, special broadcast and other program distribution services
RSS - 123 Issue 1 Spectrum Management and Telecommunications Policy - Radio Standards
Rev. 2 Specification
Low Power Licensed Radiocommunication Devices

For further applied test standards please refer to section 3 of this test report.

Test Item

Kind of test item: Digital Wireless Microphone System
Model name: TG 1000 Handheld Transmitter
FCC ID: OSDTG1000H
IC: 3628A-TG1000H
Frequency: 470 MHz – 698 MHz
Technology tested: Proprietary
Antenna: Internal antenna
Power Supply: 2.6 V DC, battery powered
Temperature Range: -30°C to +55 °C

This test report is electronically signed and valid without handwriting signature. For verification of the electronic signatures, the public keys can be requested at the testing laboratory.

Test report authorised:

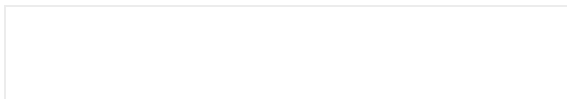
Michael Berg
Senior Testing Manager

Test performed:

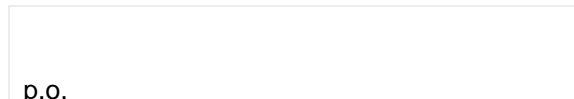
p.o.
Christoph Schneider

1 Table of contents

1 Table of contents2

2 General information3

 2.1 Notes and disclaimer3

 2.2 Application details.....3

3 Test standard/s3

4 Test environment.....4

5 Test item4

6 Test laboratories sub-contracted4

7 Summary of measurement results5

 7.1 RSP100 test report cover sheet / performance test data6

8 RF measurements7

 8.1 Description of test setup7

 8.1.1 Radiated measurements.....7

 8.1.2 Conducted measurements.....8

 8.2 Additional comments8

9 Measurement results.....9

 9.1 Output power (radiated).....9

 9.2 Frequency stability10

 9.2.1 Frequency error vs. temperature10

 9.2.2 Frequency error vs. voltage14

 9.3 Modulation characteristics17

 9.4 Occupied bandwidth18

 9.5 Unwanted radiation (spectrum mask)22

 9.6 Field strength of spurious radiation.....26

 9.7 Receiver spurious emissions (radiated)30

10 Test equipment and ancillaries used for tests31

11 Observations32

Annex A Photographs of the test setup33

Annex B External photographs of the EUT.....35

Annex C Internal photographs of the EUT36

Annex D Document history40

Annex E Further information.....40

Annex F Accreditation Certificate41

2 General information

2.1 Notes and disclaimer

The test results of this test report relate exclusively to the test item specified in this test report. CETECOM ICT Services GmbH does not assume responsibility for any conclusions and generalizations drawn from the test results with regard to other specimens or samples of the type of the equipment represented by the test item.

The test report may only be reproduced or published in full. Reproduction or publication of extracts from the report requires the prior written approval of CETECOM ICT Services GmbH.

The testing service provided by CETECOM ICT Services GmbH has been rendered under the current "General Terms and Conditions for CETECOM ICT Services GmbH".

CETECOM ICT Services GmbH will not be liable for any loss or damage resulting from false, inaccurate, inappropriate or incomplete product information provided by the customer.

Under no circumstances does the CETECOM ICT Services GmbH test report include any endorsement or warranty regarding the functionality, quality or performance of any other product or service provided.

Under no circumstances does the CETECOM ICT Services GmbH test report include or imply any product or service warranties from CETECOM ICT Services GmbH, including, without limitation, any implied warranties of merchantability, fitness for purpose, or non-infringement, all of which are expressly disclaimed by CETECOM ICT Services GmbH.

All rights and remedies regarding vendor's products and services for which CETECOM ICT Services GmbH has prepared this test report shall be provided by the party offering such products or services and not by CETECOM ICT Services GmbH.

In no case this test report can be considered as a Letter of Approval.

This test report is electronically signed and valid without handwritten signature. For verification of the electronic signatures, the public keys can be requested at the testing laboratory.

2.2 Application details

Date of receipt of order:	2012-02-02
Date of receipt of test item:	2012-06-18
Start of test:	2012-06-18
End of test:	2012-06-20
Person(s) present during the test:	Tobias Gmoser

3 Test standard/s

Test standard	Date	Test standard description
47 CFR Part 74	2010-10	Title 47 of the Code of Federal Regulations; Chapter I Part 74 - Experimental radio, auxiliary, special broadcast and other program distribution services
RSS - 123 Issue 1 Rev. 2	2000-03	Spectrum Management and Telecommunications Policy - Radio Standards Specification Low Power Licensed Radiocommunication Devices

4 Test environment

Temperature:	T_{nom}	+22 °C during room temperature tests
	T_{max}	+55 °C during high temperature tests
	T_{min}	-30 °C during low temperature tests
Relative humidity content:		55 %
Barometric pressure:		not relevant for this kind of testing
Power supply:	V_{nom}	2.6 V DC, battery powered
	V_{max}	3.0 V
	V_{min}	2.0 V

5 Test item

Kind of test item	:	Digital Wireless Microphone System
Type identification	:	TG 1000 Handheld Transmitter
S/N serial number	:	Erlkönig 0006
HW hardware status	:	PST1006A
SW software status	:	V 0.15
Frequency band [MHz]	:	470.00 MHz – 608.00 MHz; 615.00 MHz – 698.00 MHz
Type of modulation	:	FSK
Number of channels	:	150
Antenna	:	Integrated antenna
Power supply	:	2.6 V DC, battery powered
Temperature range	:	-30°C to +55 °C

6 Test laboratories sub-contracted

None

7 Summary of measurement results

- No deviations from the technical specifications were ascertained
 There were deviations from the technical specifications ascertained

TC Identifier	Description	Verdict	Date	Remark
RF-Testing	FCC 47 CFR § 74.861 RSS-123 Issue 2	Passed	2012-09-12	-/-

Test Specification Clause	Test Case	Temperature Conditions	Power Source Voltages	Pass	Fail	NA	NP	Results (max.)
FCC 47 CFR § 74.861 (e)(1)(ii) RSS-123 §6.2 Issue 2	Output power (radiated)	Nominal	Nominal	<input checked="" type="checkbox"/>	<input type="checkbox"/>	<input type="checkbox"/>	<input type="checkbox"/>	complies
FCC 47 CFR § 74.861 RSS-123 §7 Issue 2	Frequency stability	Nominal	Extreme	<input checked="" type="checkbox"/>	<input type="checkbox"/>	<input type="checkbox"/>	<input type="checkbox"/>	complies
		Extreme	Nominal	<input checked="" type="checkbox"/>	<input type="checkbox"/>	<input type="checkbox"/>	<input type="checkbox"/>	
FCC 47 CFR § 2.1049 § 74.861	Modulation characteristics	Nominal	Nominal	<input type="checkbox"/>	<input type="checkbox"/>	<input checked="" type="checkbox"/>	<input type="checkbox"/>	-/-
FCC 47 CFR § 2.1049 § 74.861 RSS-123 §6 Issue 2	Occupied bandwidth	Nominal	Nominal	<input checked="" type="checkbox"/>	<input type="checkbox"/>	<input type="checkbox"/>	<input type="checkbox"/>	complies
FCC 47 CFR § 74.861	Unwanted radiation (spectrum mask)	Nominal	Nominal	<input checked="" type="checkbox"/>	<input type="checkbox"/>	<input type="checkbox"/>	<input type="checkbox"/>	complies
FCC 47 CFR § 74 RSS-123 Issue 2	Field strength of spurious radiation Transmitter unwanted emissions	Nominal	Nominal	<input checked="" type="checkbox"/>	<input type="checkbox"/>	<input type="checkbox"/>	<input type="checkbox"/>	complies
FCC 47 CFR § 15.209 RSS-123 Issue 2	Receiver spurious emissions (radiated)	Nominal	Nominal	<input type="checkbox"/>	<input type="checkbox"/>	<input checked="" type="checkbox"/>	<input type="checkbox"/>	-/-

Note: NA = Not Applicable; NP = Not Performed

7.1 RSP100 test report cover sheet / performance test data

Test Report Number	:	1-3897/11-01-12-A	
Equipment Model Number	:	TG 1000 Handheld Transmitter	
Certification Number	:	3628A-TG1000H	
Manufacturer (complete Address)	:	beyerdynamic GmbH & Co. KG Theresienstraße 8 74072 Heilbronn / GERMANY	
Tested to radio standards specification no.	:	RSS-123 Issue 2	
Open Area Test Site IC No.	:	IC 3462C-1	
Frequency Range or fixed frequency	:	470.00 MHz – 608.00 MHz; 615.00 MHz – 698.00 MHz	
Output power [W]	:	470.00 MHz – 608.00 MHz:	29.2 mW
		615.00 MHz – 698.00 MHz:	32.8 mW
Occupied bandwidth (99%-BW) [kHz]	:	470.00 MHz – 608.00 MHz:	173.35 kHz
		615.00 MHz – 698.00 MHz:	172.35 kHz
Type of modulation	:	FSK	
Emission Designator (TRC-43)	:	470.00 MHz – 608.00 MHz:	173kF1E
		615.00 MHz – 698.00 MHz:	172kF1E
Antenna Information	:	Integrated pcb antenna	
Transmitter Spurious (worst case) [dB μ V/m @ 3m]:		51 μ V/m @ 12 GHz (noise floor)	
Receiver Spurious (worst case) [dB μ V/m @ 3m]:		No receiver integrated!	

ATTESTATION:

DECLARATION OF COMPLIANCE:

I attest that the testing was performed or supervised by me; that the test measurements were made in accordance with the above-mentioned Industry Canada standard(s); and that the equipment identified in this application has been subjected to all the applicable test conditions specified in the Industry Canada standards and all of the requirements of the standard have been met.

Laboratory Manager:

2012-09-12
Date

Christoph Schneider
Name

p.o.
Signature



8 RF measurements

8.1 Description of test setup

8.1.1 Radiated measurements

The radiated measurements are performed in vertical and horizontal plane in the frequency range from 9 kHz to 25 GHz in semi-anechoic chambers. The EUT is positioned on a non-conductive support with a height of 0.80 m above a conductive ground plane that covers the whole chamber. The receiving antennas are confirmed with specifications ANSI C63.2-1996 clause 15 and ANSI C63.4-2009 clause 4.1.5. These antennas can be moved over the height range between 1.0 m and 4.0 m in order to search for maximum field strength emitted from EUT. The measurement distances between EUT and receiving antennas are indicated in the test setups for the various frequency ranges. For each measurement, the EUT is rotated in all three axes until the maximum field strength is received. The wanted and unwanted emissions are received by spectrum analysers where the detector modes and resolution bandwidths over various frequency ranges are set according to requirement ANSI C63-4-2009 clause 4.2.

Antennas are confirmed with ANSI C63.2-1996 item 15.

Semi anechoic chamber

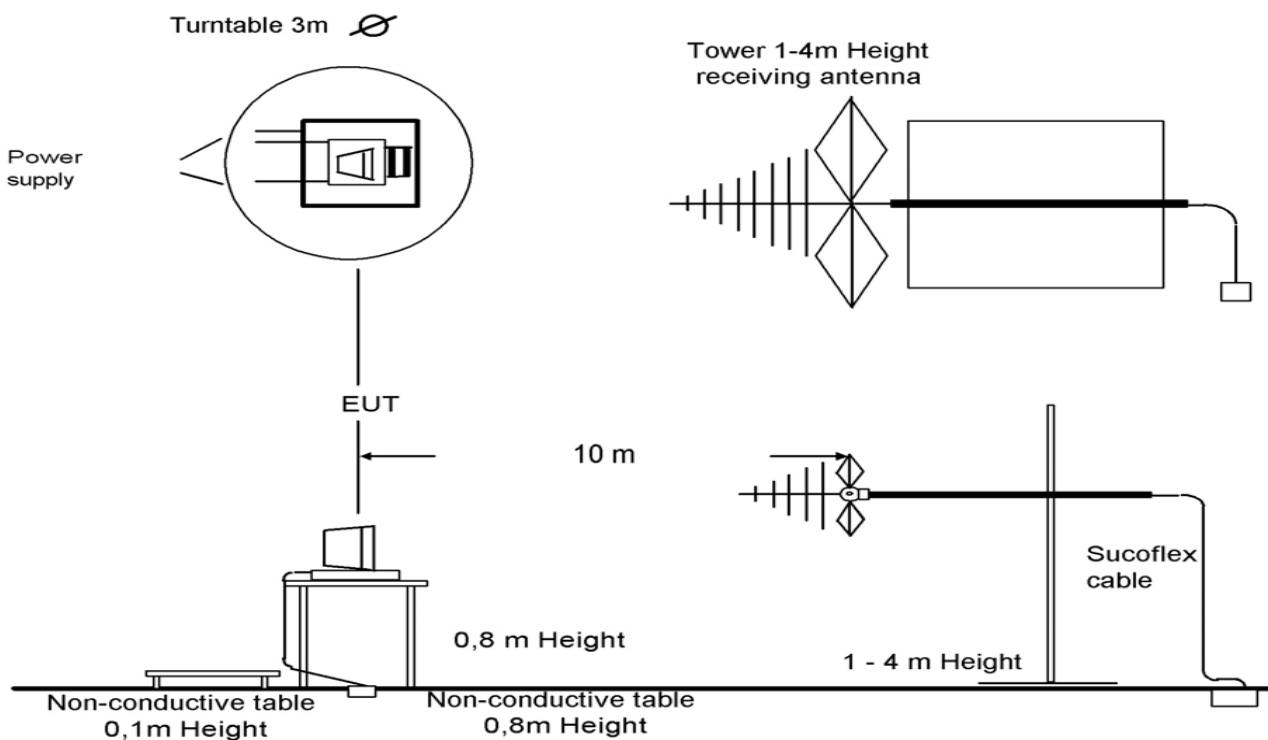

Picture 1: Diagram radiated measurements

9 kHz - 30 MHz:	active loop antenna
30 MHz – 1 GHz:	tri-log antenna
> 1 GHz:	horn antenna

The EUT is powered by an external power supply with nominal voltage. The signalling is performed from outside the chamber with a signalling unit (CMU200 or other) by air link using signalling antenna.

8.1.2 Conducted measurements

The EUT's RF signal is coupled out by the antenna connector which is supplied by the manufacturer. The signal is first 10dB attenuated before it is power divided (~6dB loss per branch). One of the signal paths is connected to the communication base Station (CMU200 or other), the other one is connected to the spectrum analyzer. The specific losses for both signal paths are first checked within a calibration. The measurement readings on the signalling unit/spectrum analyzer are corrected by the specific test set-up loss. The attenuator, power divider, signalling unit and the spectrum analyzer are impedance matched on 50 Ohm.

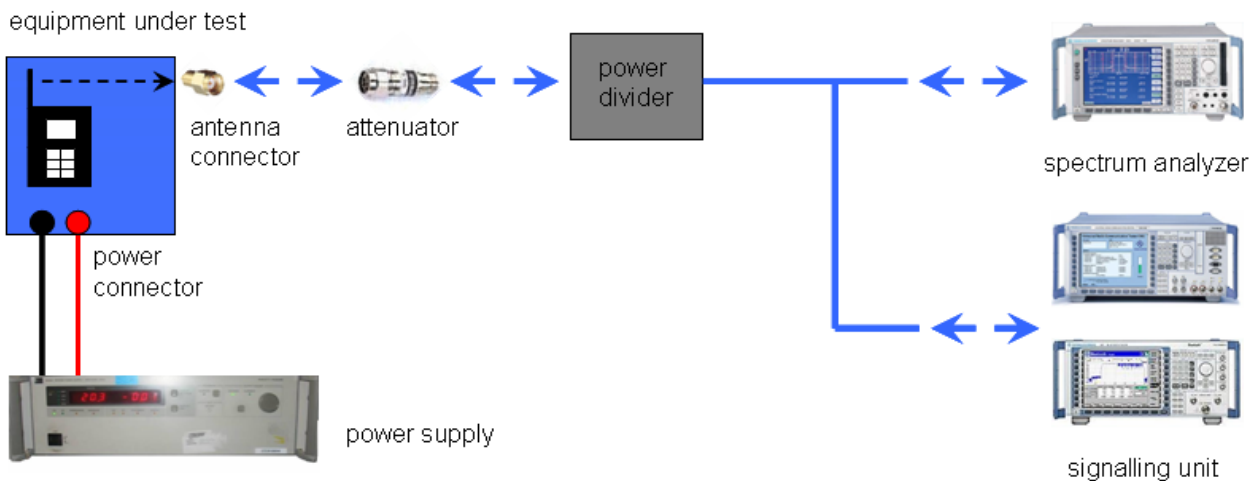

Picture 2: Diagram conducted measurements

8.2 Additional comments

Reference documents: None

Special test descriptions: None

Configuration descriptions: None

9 Measurement results

9.1 Output power (radiated)

Measurement:

Measurement parameter	
Detector:	Peak
Sweep time:	Auto
Resolution bandwidth:	3 MHz
Video bandwidth:	3 MHz
Span:	Zero Span
Trace-Mode:	Max. hold

Limits:

FCC	IC
47 CFR § 74.861 (e)(1)(ii)	RSS-123 §6.2 Issue 2
Maximum transmitter power	
470-608 and 614-698MHz bands - 250mW (23.98dBm)	

Result:

Frequency	Radiated output power
470.1 MHz	14.43 dBm
539.0 MHz	14.65 dBm
607.9 MHz	13.80 dBm
614.1 MHz	13.14 dBm
647.0 MHz	12.13 dBm
697.9 MHz	15.16 dBm

Result: Passed

9.2 Frequency stability

9.2.1 Frequency error vs. temperature

Measurement:

Measurement parameter	
Detector:	Peak
Sweep time:	Auto
Resolution bandwidth:	100 Hz
Video bandwidth:	100 Hz
Span:	1 kHz
Trace-Mode:	Max. hold
Voltage (nominal):	2.6 V

Limits:

FCC	IC
47 CFR § 74.861	RSS-123 §7 Issue 2
The frequency tolerance of the transmitter shall be 0.005 percent (50ppm)	

Results: 470.1 MHz

Temperature	Frequency (MHz)	Deviation (kHz / ppm)
-30 °C	470.099987	-0.01 / -0.03
-20 °C	470.099977	-0.02 / -0.05
-10 °C	470.099967	-0.03 / -0.07
0 °C	470.099931	-0.07 / -0.15
10 °C	470.099983	-0.02 / -0.04
20 °C	470.099989	-0.01 / -0.02
30 °C	470.099980	-0.02 / -0.04
40 °C	470.099940	-0.06 / -0.13
50 °C	470.099940	-0.06 / -0.13

Results: 539.0 MHz

Temperature	Frequency (MHz)	Deviation (kHz / ppm)
-30 °C	538.999993	-0.01 / -0.01
-20 °C	538.999969	-0.03 / -0.06
-10 °C	538.999961	-0.04 / -0.07
0 °C	538.999923	-0.08 / -0.14
10 °C	538.999970	-0.03 / -0.06
20 °C	538.999997	-0.003 / -0.01
30 °C	538.999970	-0.03 / -0.06
40 °C	538.999927	-0.07 / -0.14
50 °C	538.999925	-0.08 / -0.14

Results: 607.9 MHz

Temperature	Frequency (MHz)	Deviation (kHz / ppm)
-30 °C	607.899997	-0.003 / -0.01
-20 °C	607.899971	-0.03 / -0.05
-10 °C	607.899959	-0.04 / -0.07
0 °C	607.899903	-0.10 / -0.16
10 °C	607.899960	-0.04 / -0.07
20 °C	607.899990	-0.01 / -0.02
30 °C	607.899950	-0.05 / -0.08
40 °C	607.899921	-0.08 / -0.13
50 °C	607.899907	-0.09 / -0.15

Results: 614.1 MHz

Temperature	Frequency (MHz)	Deviation (kHz / ppm)
-30 °C	614.099995	-0.01 / -0.01
-20 °C	614.099975	-0.03 / -0.04
-10 °C	614.099955	-0.05 / -0.07
0 °C	614.099911	-0.09 / -0.15
10 °C	614.099965	-0.04 / -0.06
20 °C	614.099983	-0.02 / -0.03
30 °C	614.099949	-0.05 / -0.08
40 °C	614.099908	-0.09 / -0.15
50 °C	614.099907	-0.09 / -0.15

Results: 647.0 MHz

Temperature	Frequency (MHz)	Deviation (kHz / ppm)
-30 °C	646.999997	-0.003 / -0.01
-20 °C	646.999967	-0.03 / -0.05
-10 °C	646.999965	-0.04 / -0.05
0 °C	646.999909	-0.09 / -0.14
10 °C	646.999959	-0.04 / -0.06
20 °C	646.999973	-0.03 / -0.04
30 °C	646.999946	-0.05 / -0.08
40 °C	646.999917	-0.08 / -0.13
50 °C	646.999905	-0.10 / -0.15

Results: 697.9 MHz

Temperature	Frequency (MHz)	Deviation (kHz / ppm)
-30 °C	697.900001	0.001 / 0.001
-20 °C	697.899979	-0.02 / -0.03
-10 °C	697.899951	-0.05 / -0.07
0 °C	697.899897	-0.10 / -0.15
10 °C	697.899969	-0.03 / -0.04
20 °C	697.899994	-0.01 / -0.01
30 °C	697.899930	-0.07 / -0.10
40 °C	697.899910	-0.09 / -0.13
50 °C	697.899890	-0.11 / -0.16

Result: Passed

9.2.2 Frequency error vs. voltage

Measurement:

Measurement parameter	
Detector:	Peak
Sweep time:	Auto
Resolution bandwidth:	100 Hz
Video bandwidth:	100 Hz
Span:	1 kHz
Trace-Mode:	Max. hold
Temperature:	22°C

Limits:

FCC	IC
47 CFR § 74.861	RSS-123 §7 Issue 2
The frequency tolerance of the transmitter shall be 0.005 percent (50ppm)	

Results: 470.1 MHz

Voltage	Frequency (MHz)	Deviation (kHz / ppm)
2.2 V	470.1	0,00 / 0,00
2.3 V	470.1	0,00 / 0,00
2.4 V	470.1	0,00 / 0,00
2.5 V	470.1	0,00 / 0,00
2.6 V	470.1	0,00 / 0,00
2.7 V	470.1	0,00 / 0,00
2.8 V	470.1	0,00 / 0,00

Results: 539.0 MHz

Voltage	Frequency (MHz)	Deviation (kHz / ppm)
2.2 V	539.0	0,00 / 0,00
2.3 V	539.0	0,00 / 0,00
2.4 V	539.0	0,00 / 0,00
2.5 V	539.0	0,00 / 0,00
2.6 V	539.0	0,00 / 0,00
2.7 V	539.0	0,00 / 0,00
2.8 V	539.0	0,00 / 0,00

Results: 607.9 MHz

Voltage	Frequency (MHz)	Deviation (kHz / ppm)
2.2 V	607.900080	0.08 / 0.13
2.3 V	607.900005	0.005 / 0.01
2.4 V	607.900011	0.01 / 0.02
2.5 V	607.900011	0.01 / 0.02
2.6 V	607.900011	0.01 / 0.02
2.7 V	607.900011	0.01 / 0.02
2.8 V	607.900011	0.01 / 0.02

Results: 614.1 MHz

Voltage	Frequency (MHz)	Deviation (kHz / ppm)
2.2 V	614.100020	0.02 / 0.03
2.3 V	614.100017	0.02 / 0.03
2.4 V	614.100020	0.02 / 0.03
2.5 V	614.100020	0.02 / 0.03
2.6 V	614.100017	0.02 / 0.03
2.7 V	614.100014	0.01 / 0.02
2.8 V	614.100011	0.01 / 0.02

Results: 647.0 MHz

Voltage	Frequency (MHz)	Deviation (kHz / ppm)
2.2 V	647.000020	0.02 / 0.03
2.3 V	647.000024	0.02 / 0.04
2.4 V	647.000011	0.01 / 0.02
2.5 V	647.000014	0.01 / 0.02
2.6 V	647.000017	0.02 / 0.03
2.7 V	647.000014	0.01 / 0.02
2.8 V	647.000011	0.01 / 0.02

Results: 697.9 MHz

Voltage	Frequency (MHz)	Deviation (kHz / ppm)
2.2 V	697.900014	0.01 / 0.02
2.3 V	697.900008	0.01 / 0.01
2.4 V	697.900014	0.01 / 0.02
2.5 V	697.900017	0.02 / 0.02
2.6 V	697.900008	0.01 / 0.01
2.7 V	697.900024	0.02 / 0.03
2.8 V	697.900020	0.02 / 0.03

Result: Passed

9.3 Modulation characteristics

Due to digital systems - not applicable!

9.4 Occupied bandwidth

Measurement:

Measurement parameter	
Detector:	Peak
Sweep time:	Auto
Resolution bandwidth:	3 kHz
Video bandwidth:	3 kHz
Span:	500 kHz
Trace-Mode:	Max. hold

Limits:

FCC	IC
47 CFR § 74.861	RSS-123 §6 Issue 2
Occupied bandwidth 99%. Other than single sideband or independent sideband transmitters - when modulated by a 2500 Hz tone at an input level 16 dB greater than that necessary to produce 50 percent modulation. The input level shall be established at the frequency of maximum response of the audio modulating circuit.	
The operating bandwidth shall not exceed 200 kHz	

Result:

Frequency	20dB Bandwidth
470.1 MHz	173.35 kHz
539.0 MHz	169.34 kHz
607.9 MHz	169.34 kHz
614.1 MHz	170.34 kHz
647.0 MHz	171.34 kHz
697.9 MHz	172.35 kHz

Result: Passed

Plots of the measurements

Plot 1: 470.1 MHz

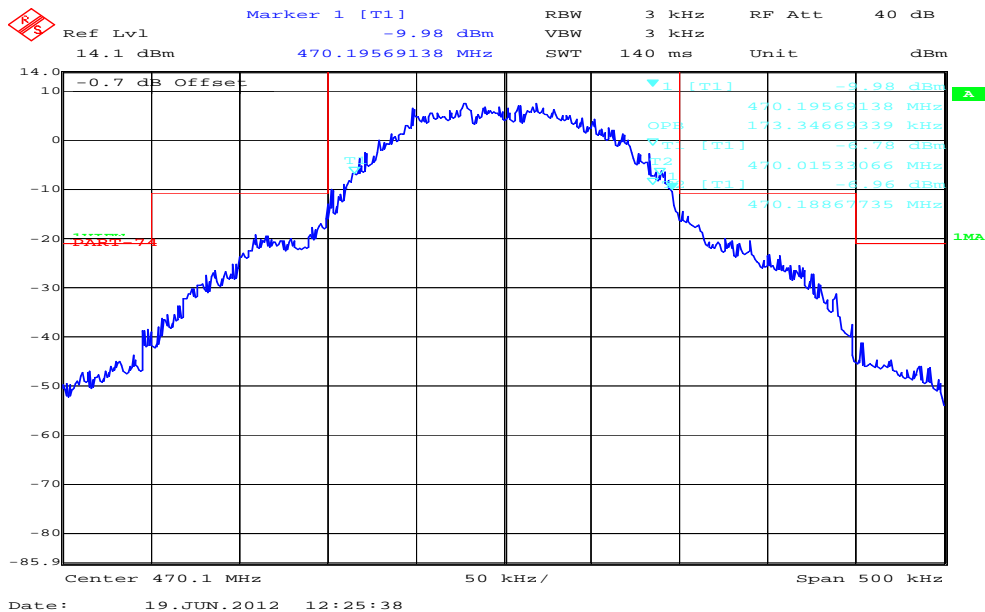

Plot 2: 539.0 MHz

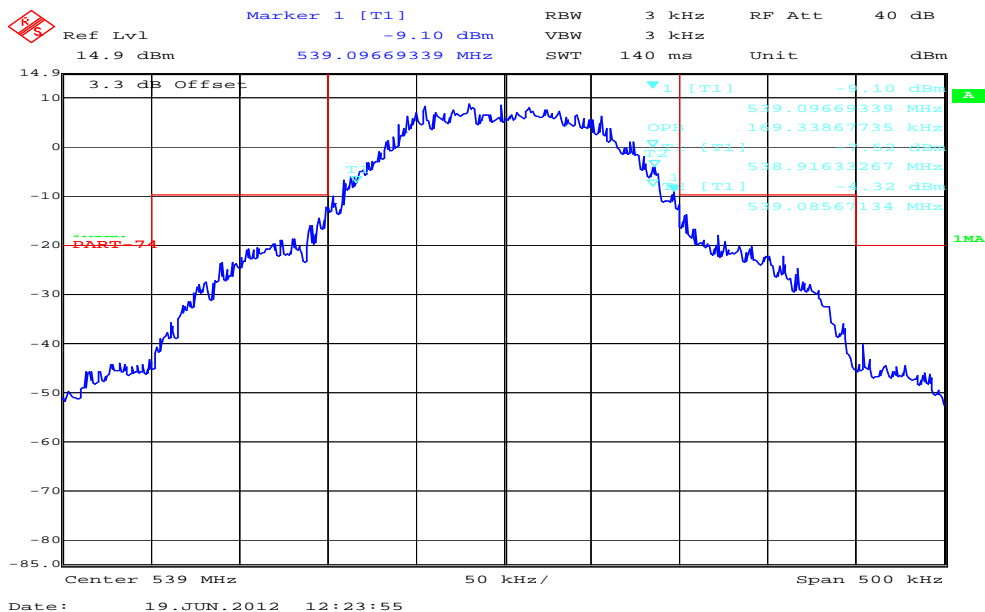

Plot 3: 607.9 MHz

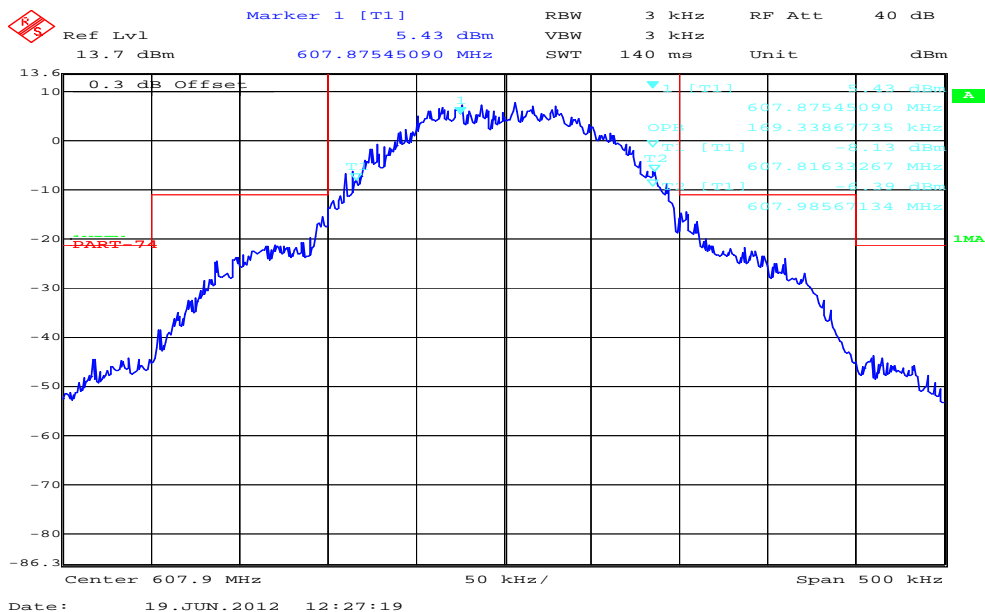

Plot 4: 614.1 MHz

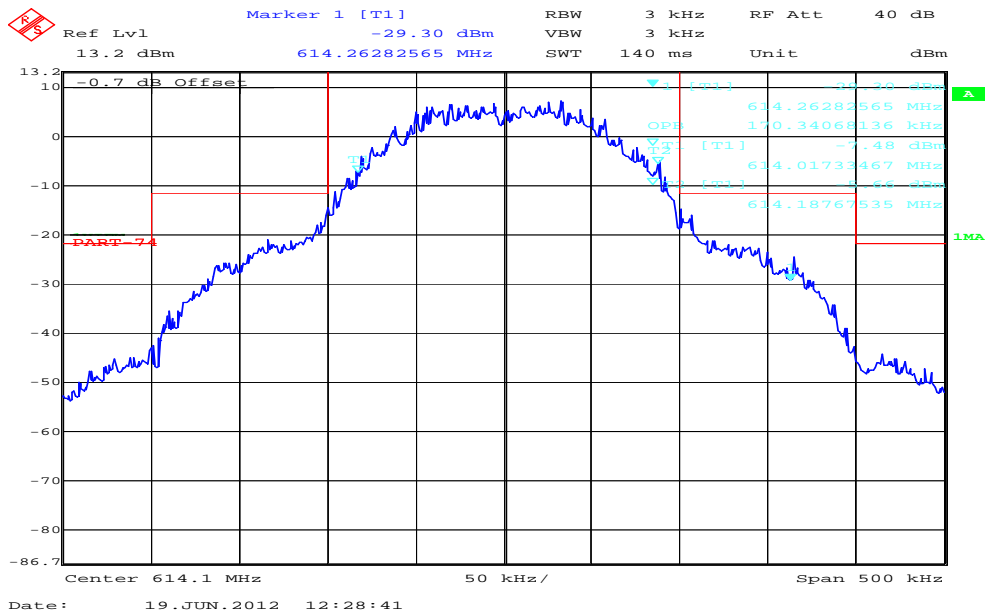

Plot 5: 647.0 MHz

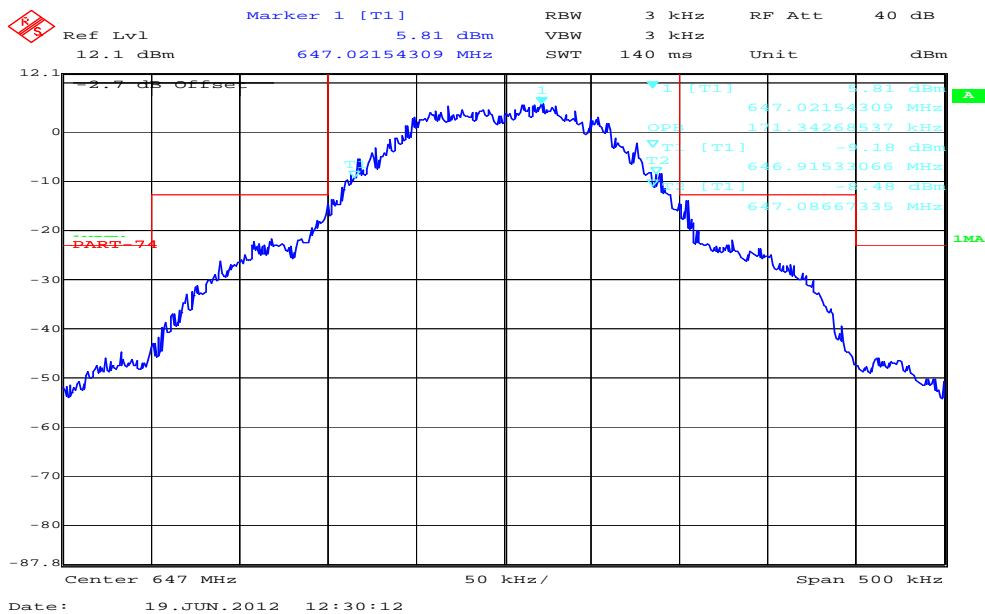

Plot 6: 697.0 MHz

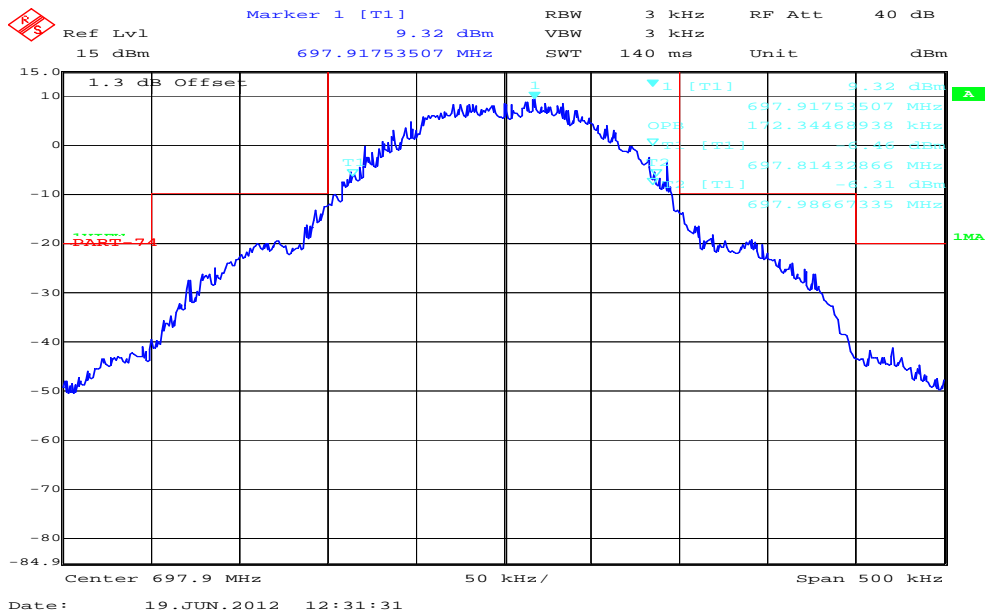

9.5 Unwanted radiation (spectrum mask)

Measurement:

Measurement parameter	
Detector:	Peak
Sweep time:	Auto
Resolution bandwidth:	3 kHz
Video bandwidth:	3 kHz
Span:	1.5 MHz
Trace-Mode:	Max. hold

Limits:

FCC	IC
47 CFR § 74.861	RSS-123 §5.5 Issue 2
<p>The mean power of emissions shall be attenuated below the mean output power of the transmitter in accordance with the following schedule:</p> <ul style="list-style-type: none"> (i) On any frequency removed from the operating frequency by more than 50 percent up to and including 100 percent of the authorized bandwidth: at least 25 dB; (ii) On any frequency removed from the operating frequency by more than 100 percent up to and including 250 percent of the authorized bandwidth: at least 35 dB; (iii) On any frequency removed from the operating frequency by more than 250 percent of the authorized bandwidth: at least $43 + 10 \log_{10}$ (mean output power in watts) dB. 	

Result: Passed

Plots of the measurements

Plot 1: 470.1 MHz

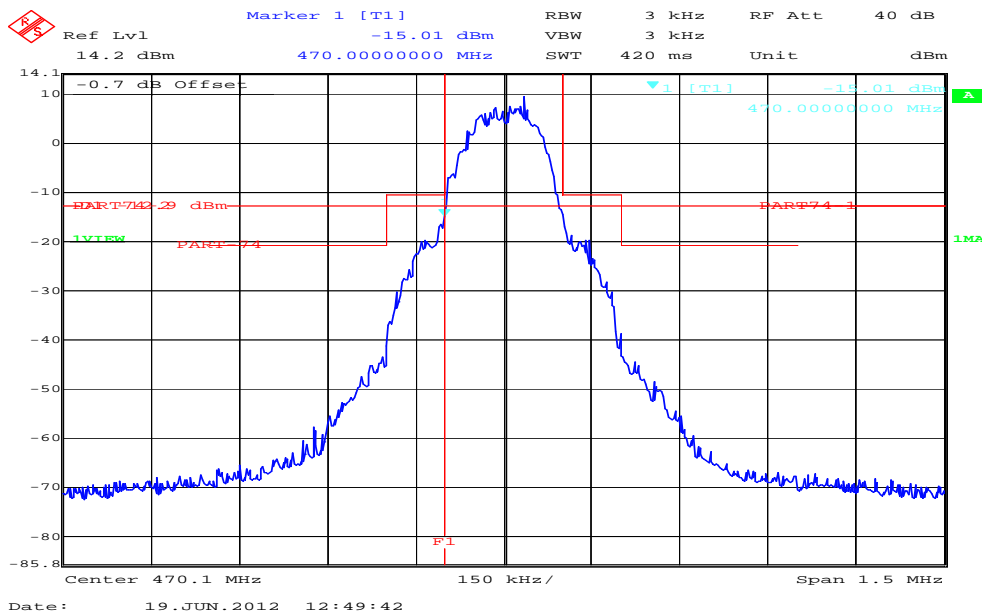

Plot 2: 539.0 MHz

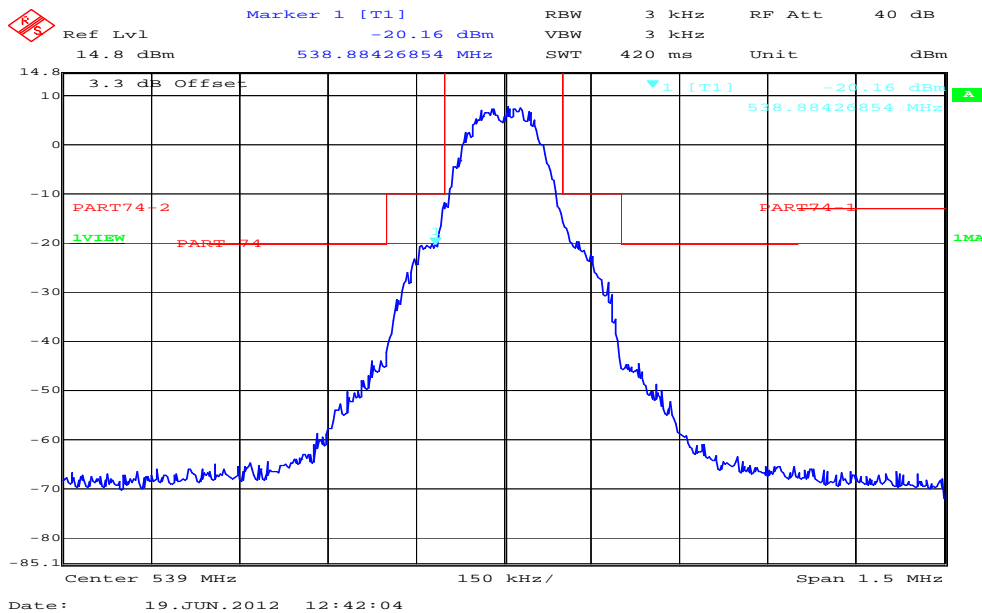

Plot 3: 607.9 MHz

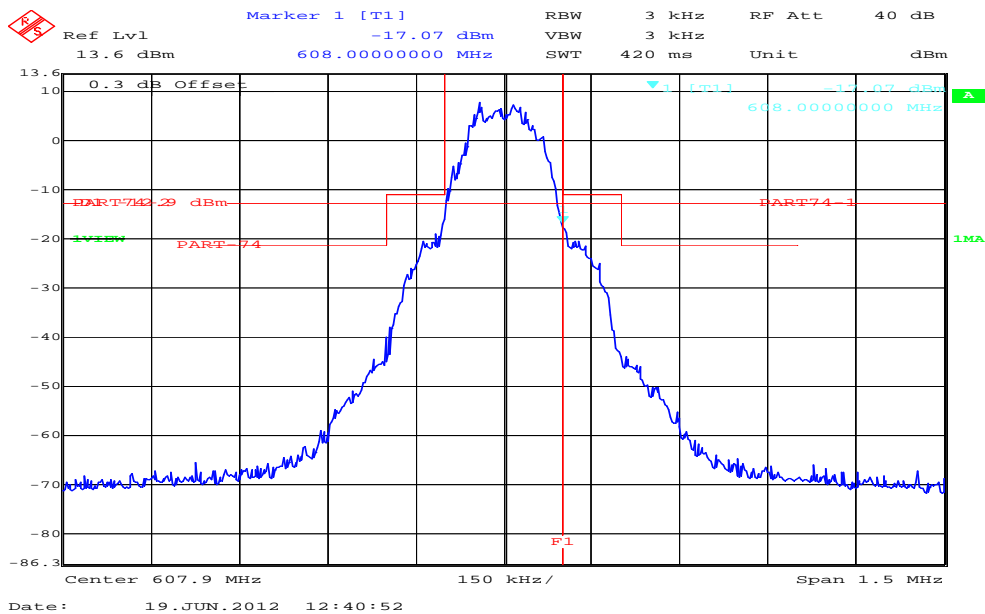

Plot 4: 614.1 MHz

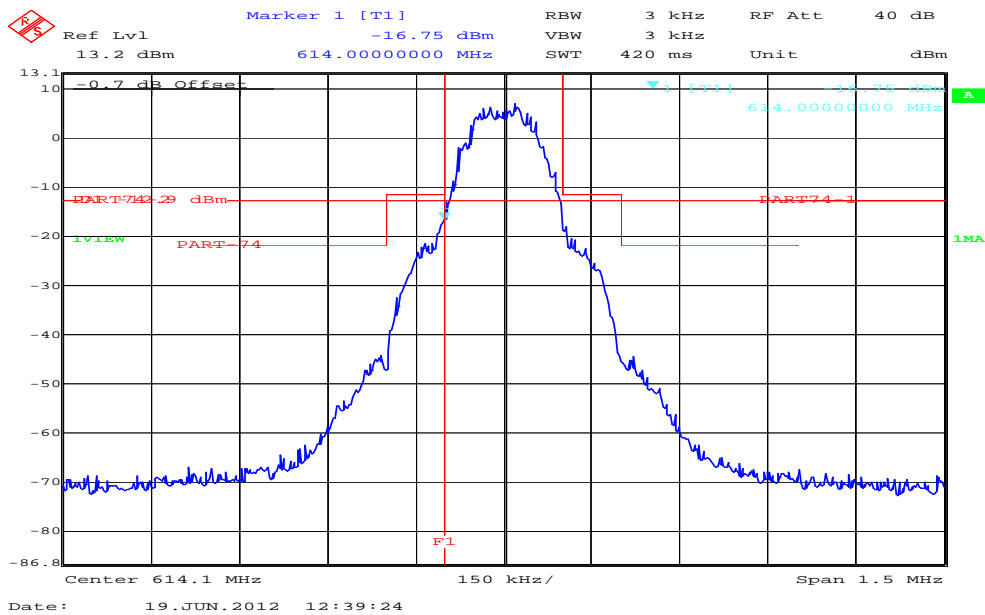

Plot 5: 647.0 MHz

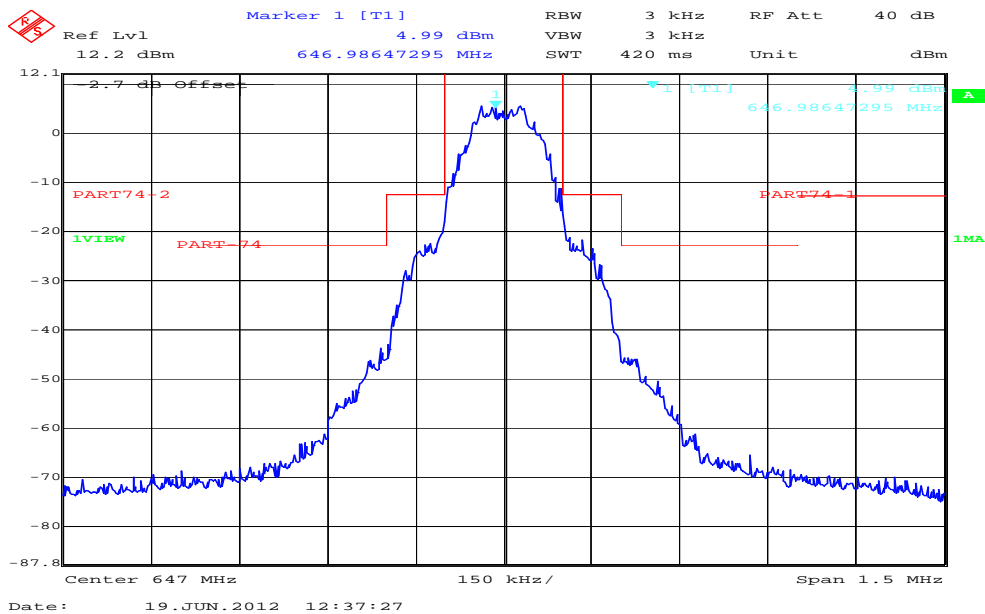

Plot 6: 697.0 MHz

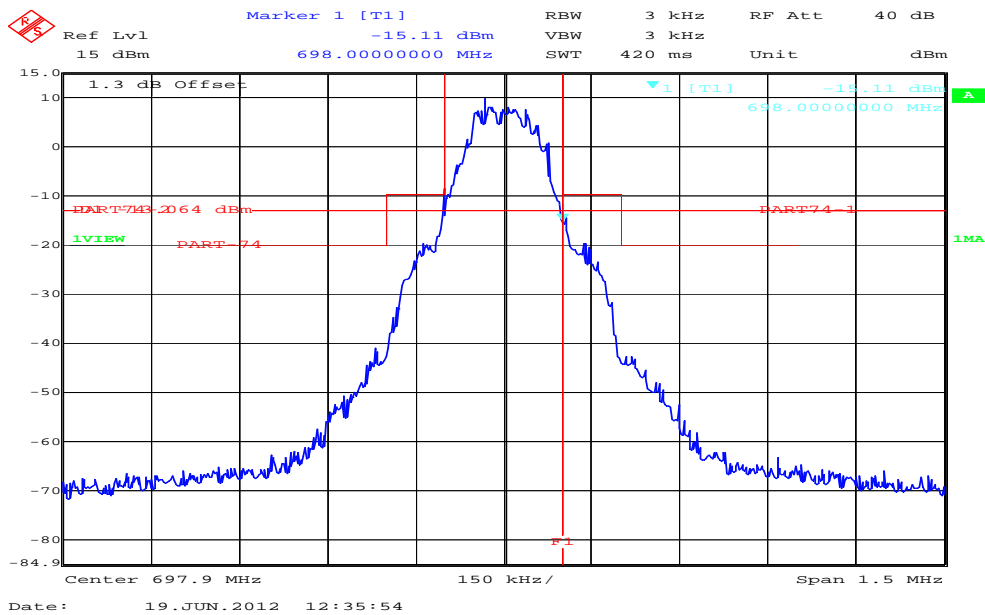

9.6 Field strength of spurious radiation.

Measurement:

Measurement parameter	
Detector:	Peak
Sweep time:	Auto
Resolution bandwidth:	f < 1 GHz : 100 kHz f ≥ 1GHz : 1 MHz
Video bandwidth:	f < 1 GHz : 100 kHz f ≥ 1GHz : 1 MHz
Span:	-/-
Trace-Mode:	Max. hold

Limits:

FCC	IC
47 CFR § 74.861	RSS-123 §5.5 Issue 2
FCC: at least 43 + 10log(carrier power in watts) dB IC: at least 55 + 10log(carrier power in watts) dB.	

SPURIOUS EMISSIONS LEVEL (dBm)								
470.1 MHz			539.0 MHz			607.9 MHz		
Frequency	Detector	Level	Frequency	Detector	Level	Frequency	Detector	Level
No critical peaks detected!			No critical peaks detected!			No critical peaks detected!		
Measurement uncertainty ± 3 dB								

SPURIOUS EMISSIONS LEVEL (dBm)								
614.1 MHz			647.0 MHz			697.9 MHz		
Frequency	Detector	Level	Frequency	Detector	Level	Frequency	Detector	Level
No critical peaks detected!			No critical peaks detected!			No critical peaks detected!		
Measurement uncertainty ± 3 dB								

Result: Passed

Plots of the measurements

Plot 1: 30 MHz – 12.75 GHz, 470.1 MHz, vertical and horizontal polarisation

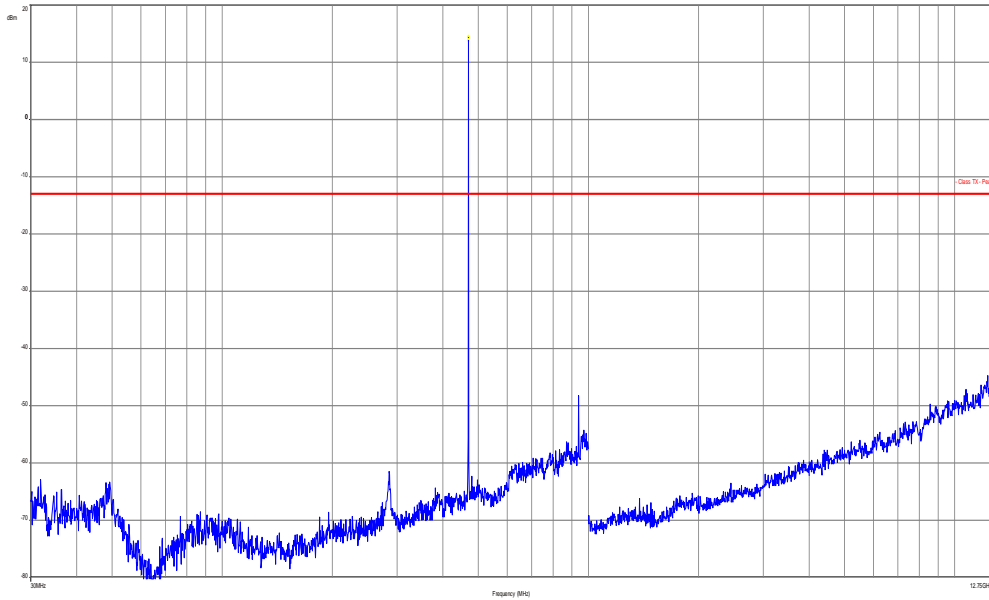

Plot 2: 30 MHz – 12.75 GHz, 539.0 MHz, vertical and horizontal polarisation

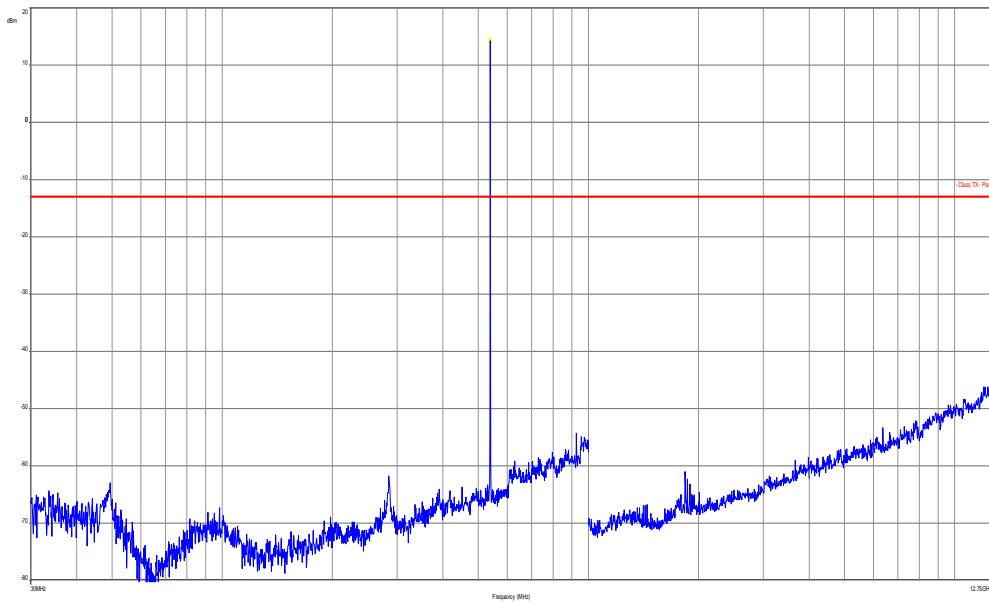

Plot 3: 30 MHz – 12.75 GHz, 607.9 MHz, vertical and horizontal polarisation

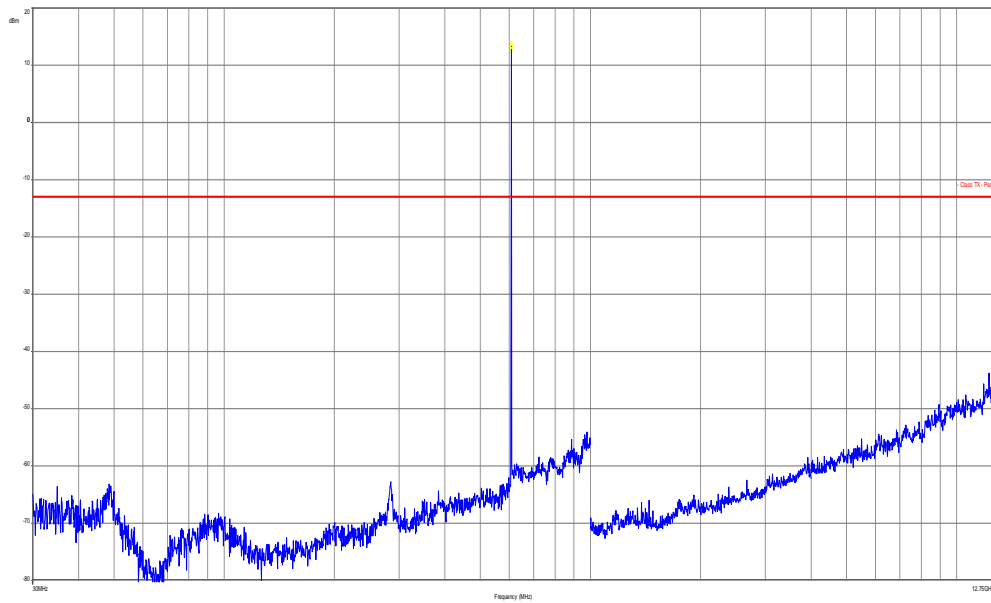

Plot 4: 30 MHz – 12.75 GHz, 614.1 MHz, vertical and horizontal polarisation

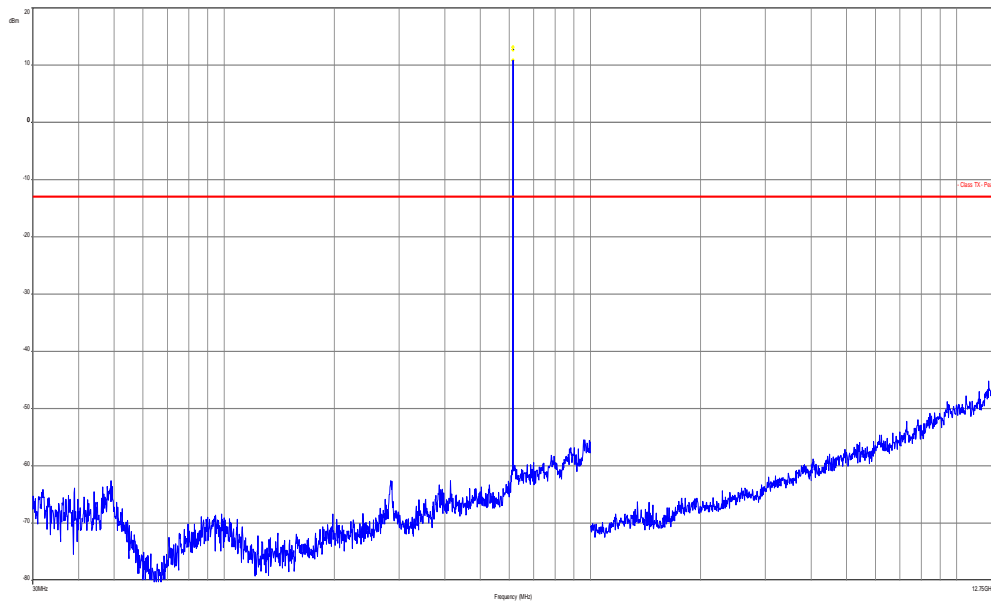

Plot 5: 30 MHz – 12.75 GHz, 647.0 MHz, vertical and horizontal polarisation

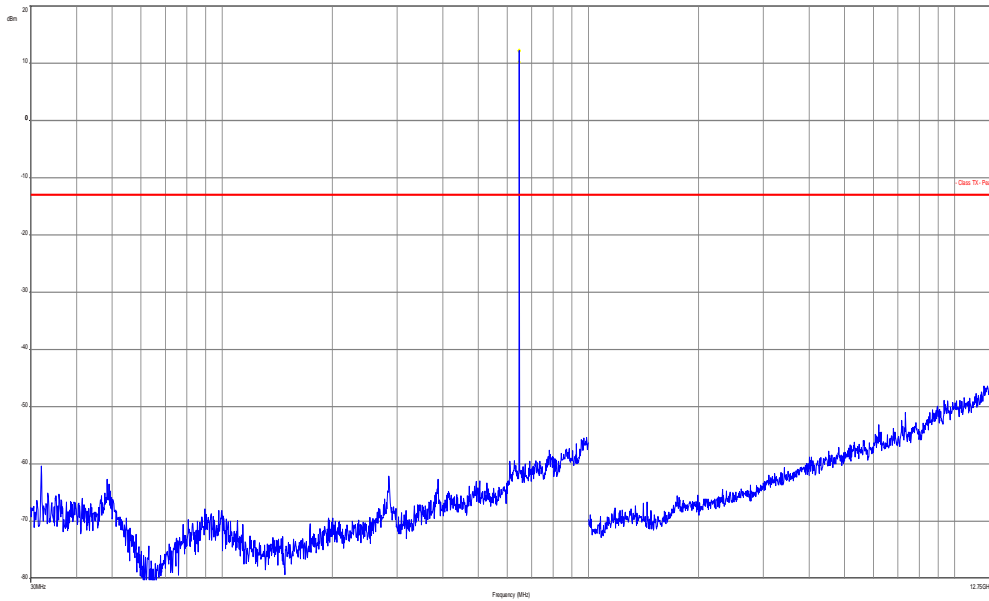

Plot 6: 30 MHz – 12.75 GHz, 697.9MHz, vertical and horizontal polarisation

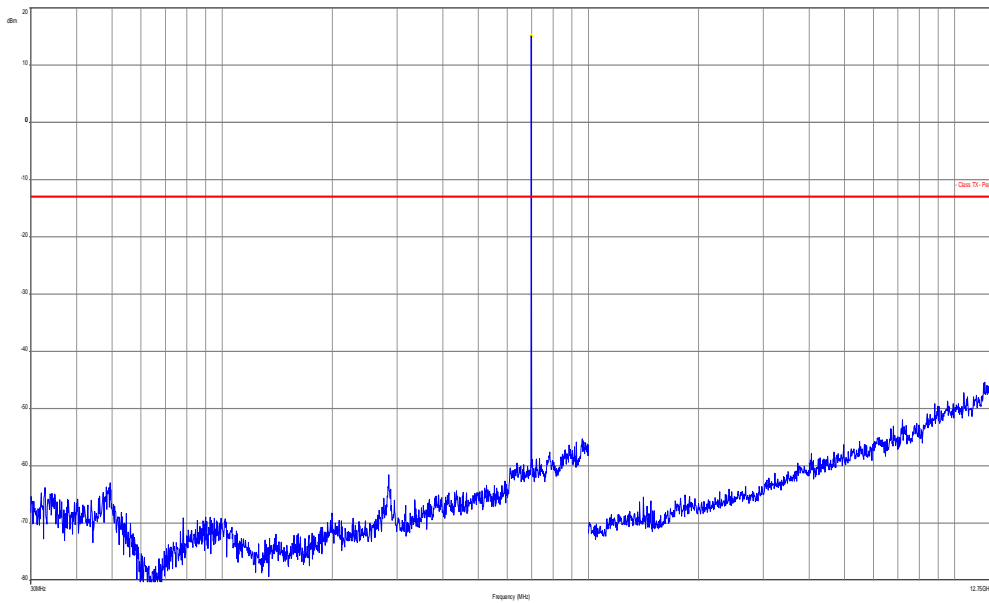

9.7 Receiver spurious emissions (radiated)

Not applicable!

10 Test equipment and ancillaries used for tests

Typically, the calibrations of the test apparatus are commissioned to and performed by an accredited calibration laboratory. The calibration intervals are determined in accordance with the DIN EN ISO/IEC 17025. In addition to the external calibrations, the laboratory executes comparison measurements with other calibrated test systems or effective verifications. Weekly chamber inspections and range calibrations are performed. Where possible, rf-generating and signalling equipment as well as measuring receivers and analyzers are connected to an external high-precision 10 MHz reference (GPS-based or rubidium frequency standard).

In order to simplify the identification of the equipment used at some special tests, some items of test equipment and ancillaries can be provided with an identifier or number in the equipment list below (Labor/Item).

No.	Lab / Item	Equipment	Type	Manufact.	Serial No.	INV. No Cetecom	Kind of Calibration	Last Calibration	Next Calibration
1	n. a.	Isolating Transformer	RT5A	Grundig	8041	300001626	g		
2	n. a.	DC power supply, 60Vdc, 50A, 1200 W	6032A	HP Meßtechnik	2818A03450	300001040	Ve	12.01.2012	12.01.2015
3	n. a.	Double-Ridged Waveguide Horn Antenna 1-18.0GHz	3115	EMCO	8812-3088	300001032	vIKI!	11.05.2011	11.05.2013
4	n. a.	Active Loop Antenna	6502	EMCO	2210	300001015	ne		
5	n. a.	Anechoic chamber	FAC 3/5m	MWB / TDK	87400/02	300000996	ev		
6	Spec.A. 2_2e	System rack for EMI measurement solution	85900	HP I.V.	*	300000222	ne		
7	9	Artificial Mains 9 kHz to 30 MHz	ESH3-Z5	R&S	828576/020	300001210	Ve	06.01.2012	06.01.2014
8	n. a.	Relais Matrix	3488A	HP Meßtechnik	2719A15013	300001156	ne		
9	n. a.	Relais Matrix	PSU	R&S	890167/024	300001168	ne		
10	n. a.	Isolating Transformer	RT5A	Grundig	9242	300001263	ne		
11	n. a.	Three-Way Power Splitter, 50 Ohm	11850C	HP Meßtechnik		300000997	ne		
12	n. a.	Switch / Control Unit	3488A	HP	2605e08770	300001443	ne		
13	n. a.	Amplifier	js42-00502650-28-5a	Parzich GMBH	928979	300003143	ne		
14	n. a.	Band Reject filter	WRCG1855/1910-1835/1925-40/8SS	Wainwright	7	300003350	ev		
15	n. a.	Band Reject filter	WRCG2400/2483-2375/2505-50/10SS	Wainwright	11	300003351	ev		
16	n. a.	TILE-Software Emission	Quantum Change, Modell TILE-ICS/FULL	EMCO	none	300003451	ne		
17	n. a.	Highpass Filter	WHKX2.9/18G-12SS	Wainwright	1	300003492	ev		
18	n. a.	Highpass Filter	WHK1.1/15G-10SS	Wainwright	3	300003255	ev		
19	n. a.	Highpass Filter	WHKX7.0/18G-8SS	Wainwright	18	300003789	ne		
20	n. a.	MXG Microwave Analog Signal Generator	N5183A	Agilent Technologies	MY47420220	300003813	k	13.09.2010	13.09.2012
21	n. a.	RF Filter Section 9kHz - 1GHz	N9039A	Agilent Technologies	MY48260003	300003825	vk	08.09.2010	
22	n. a.	TRILOG Broadband	VULB9163	Schwarzbeck	371	300003854	vIKI!	14.10.2011	14.10.2014

		Test-Antenna 30 MHz - 3 GHz							
23	n. a.	MXE EMI Receiver 20 Hz bis 26,5 GHz	N9038A	Agilent Technologi es	MY51210197	300004405	k	19.12.2011	19.12.2012
24	n. a.	DC power supply, 60Vdc, 50A, 1200 W	6032A	HP Meßtechnik	2920A04590	300001041	Ve	12.01.2012	12.01.2015
25	n. a.	Temperature Test Chamber	VT 4002	Heraeus Voetsch	521/83761	300002326	Ve	20.09.2011	20.09.2013
26	n. a.	Signal Analyzer 20Hz-26,5GHz- 150 to + 30 DBM	FSiQ26	R&S	835111/0004	300002678	Ve	04.11.2010	04.11.2012

Agenda: Kind of Calibration

k	calibration / calibrated	EK	limited calibration
ne	not required (k, ev, izw, zw not required)	zw	cyclical maintenance (external cyclical maintenance)
ev	periodic self verification	izw	internal cyclical maintenance
Ve	long-term stability recognized	g	blocked for accredited testing
vlk!	Attention: extended calibration interval		
NK!	Attention: not calibrated	*)	next calibration ordered / currently in progress

11 Observations

No observations exceeding those reported with the single test cases have been made.

Annex A Photographs of the test setup

Photo 1:

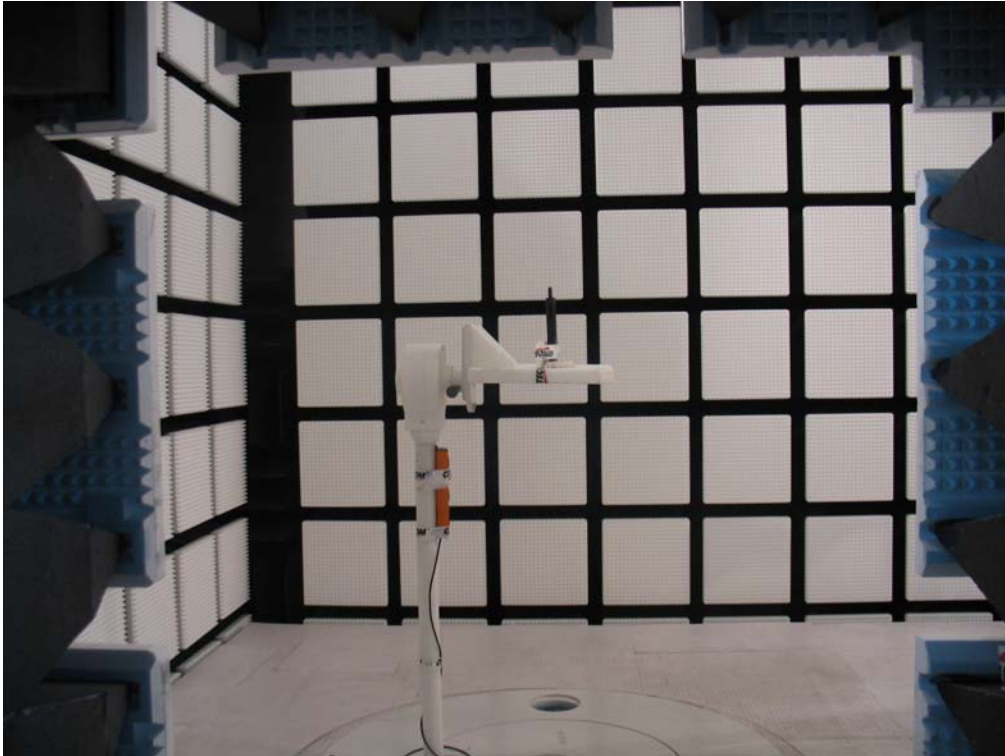

Photo 2:

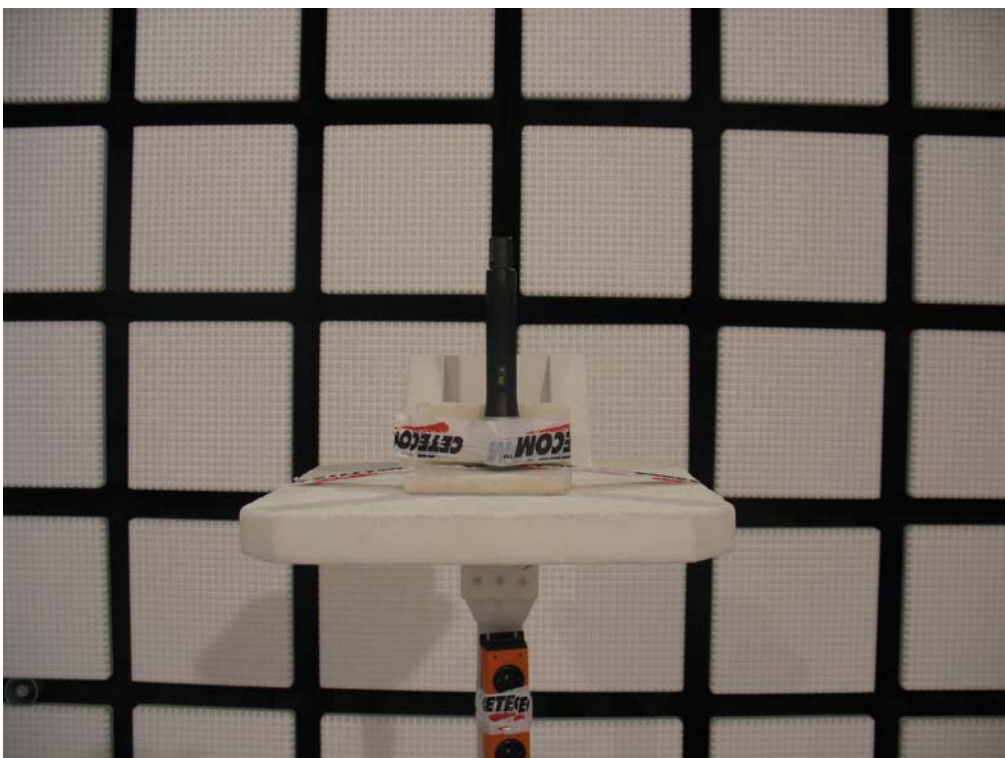

Photo 3:



Photo 4:



Annex B External photographs of the EUT

Photo 1:



Photo 2:



Annex C Internal photographs of the EUT

Photo 1:



Photo 2:



Photo 3:



Photo 4:



Photo 5:

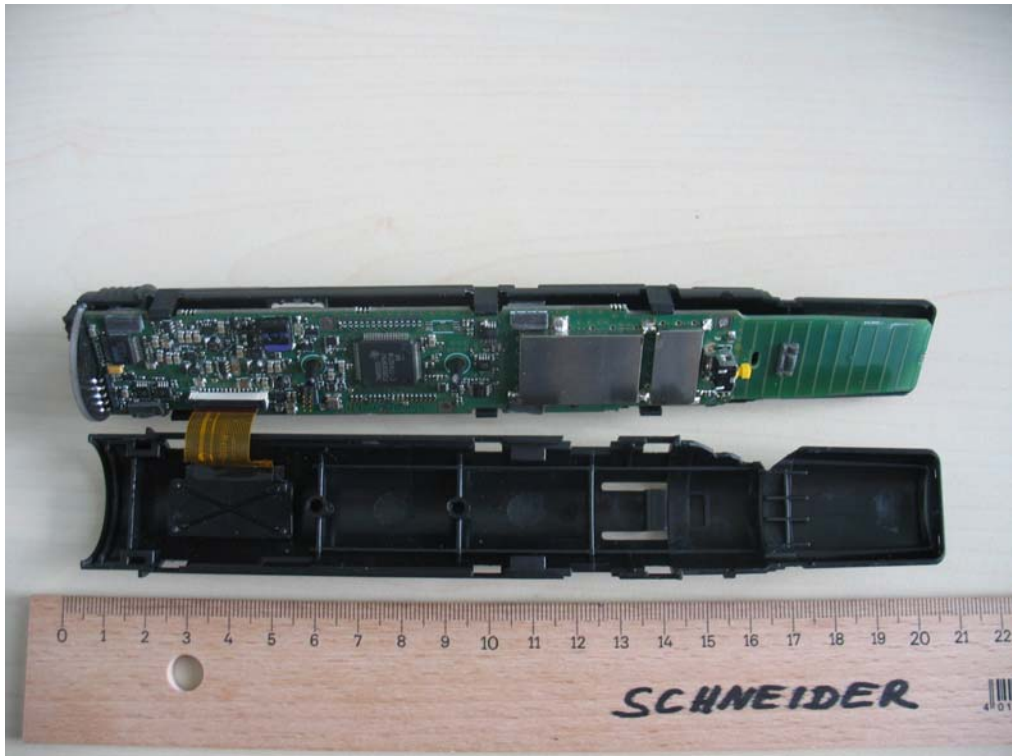

Photo 6:

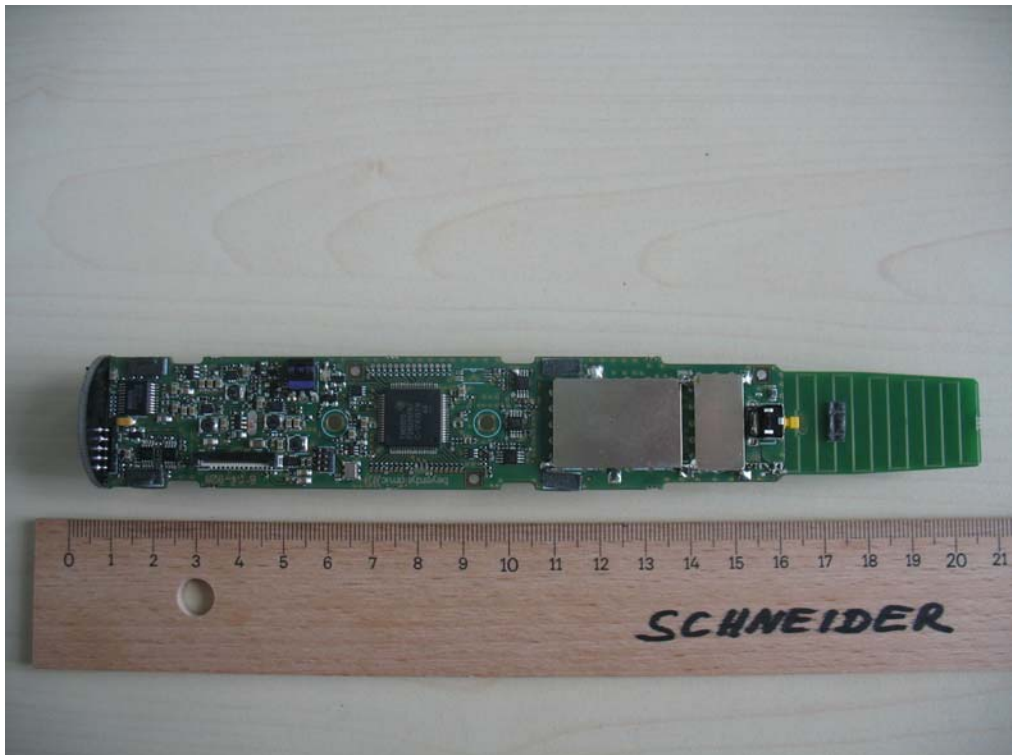
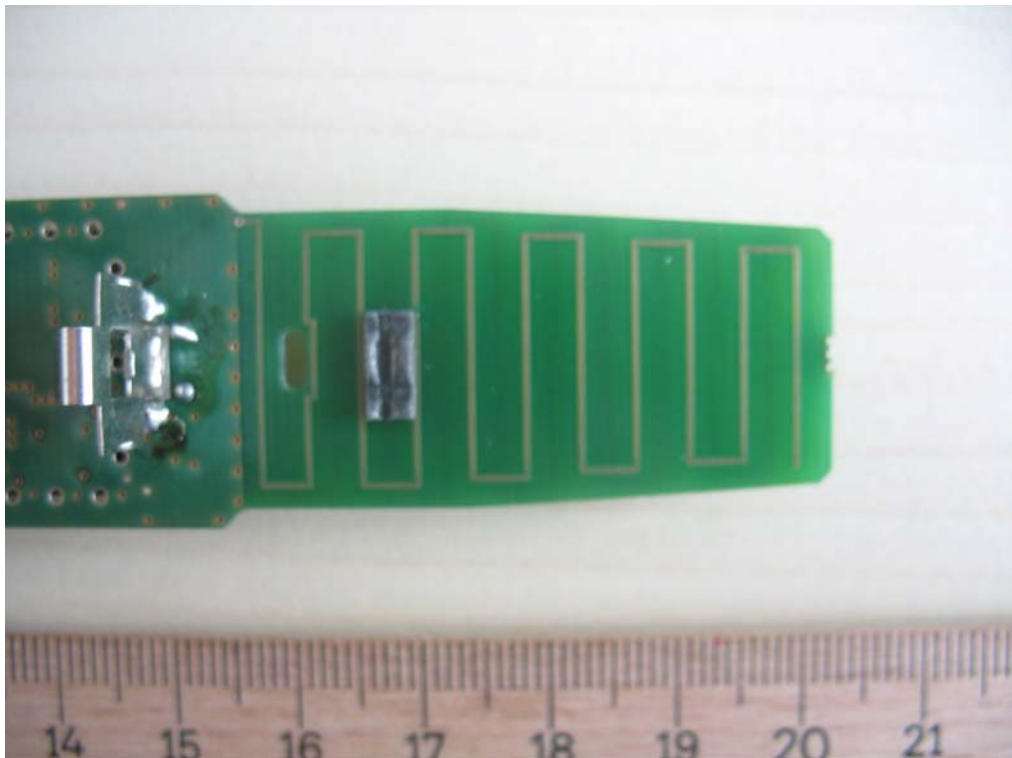

Photo 7:



Photo 8:



Annex D Document history

Version	Applied changes	Date of release
1.0	Initial release	2012-08-03
-A	Model Name changed	2012-09-12

Annex E Further information**Glossary**

AVG	-	Average
DUT	-	Device under test
EMC	-	Electromagnetic Compatibility
EN	-	European Standard
EUT	-	Equipment under test
ETSI	-	European Telecommunications Standard Institute
FCC	-	Federal Communication Commission
FCC ID	-	Company Identifier at FCC
HW	-	Hardware
IC	-	Industry Canada
Inv. No.	-	Inventory number
N/A	-	Not applicable
PP	-	Positive peak
QP	-	Quasi peak
S/N	-	Serial number
SW	-	Software

Annex F Accreditation Certificate



Front side of certificate



Back side of certificate

Note:

The current certificate including annex is published on our website (see link below) or may be received from CETECOM ICT Services on request.

http://www.cetecom.com/fileadmin/de/CETECOM_D_Saarbruecken/accreditations_Jan_2010/DAKKS_Akkredi_Urk_EN17025-En_incl_Annex.pdf