



OPERATING INSTRUCTIONS

Stegos

Wireless digital Boundary Microphone System

1.	Safety and environment.	4
1.1	Stegos RS receiver	4
1.2	Stegos TB boundary microphone	6
1.3	Disposal	6
2.	Stegos RS receiver	7
2.1	Controls and indicators	7
2.2	How to connect the antennae	8
2.3	Where to place the receiver	8
2.4	Connection	8
2.5	How to operate the receiver.	9
2.6	How to install a receiver into a 19" rack.	10
3.	Stegos TB boundary microphone	10
3.1	Controls and indicators	10
3.2	How to operate the microphone	11
3.3	How to recharge	12
3.4	Mains operated	12
4.	Stegos software.	13
4.1	System requirements	13
4.2	Installation	13
4.3	Putting into operation	14
4.4	Main menu	15
4.5	Settings	16
5.	Maintenance	17
6.	Service.	17
7.	Trouble shooting	18
8.	Simultaneous operation of the Stegos system and other 2.4 GHz devices	18
8.1	Physical laws	18
8.2	Stegos and WLAN or WiFi	19
8.3	Stegos and Bluetooth.	20
8.4	Example for Stegos, media control systems and WLAN.	20
9.	Components	21
10.	Technical specifications	21
	EC-Declaration of Conformity.	25
	FCC-Regulation	26

Thank you for selecting the Stegos wireless digital boundary microphone system. Please take some time to read carefully through this manual before setting up the equipment.

The wireless Stegos system includes receiver and boundary microphone and has been developed especially for the use with video conference systems. Up to three Stegos systems can be operated in neighbouring rooms simultaneously.

1. Safety and environment

1.1 Stegos RS receiver



The lightning flash within an equilateral triangle is intended to alert the user to the presence of uninsulated dangerous voltage within the device that may be sufficient enough to constitute a risk of electric shock to users.



The exclamation mark within an equilateral triangle is intended to alert the user to the presence of important operating and maintenance instructions in the literature accompanying the product.

1. Read these instructions.
2. Keep these instructions.
3. Heed all warnings.
4. Follow all instructions.
5. Do not use this apparatus near water.
6. Clean only with dry cloth.
7. Do not install near any heat sources such as radiators, heat registers, stoves, or other apparatus (including amplifiers) that produce heat.
8. Protect the power cord from being walked on or pinched particularly at plugs, convenience receptacles, and the point where they exit from the apparatus.
9. Only use attachments/accessories specified by the manufacturer.
10. Unplug this apparatus during lightning storms or when unused for long periods of time.
11. Refer all servicing to qualified service personnel. Servicing is required when the apparatus has been damaged in any way, such as power supply cord or plug is damaged, liquid has been spilled or objects have fallen into the apparatus, the apparatus has been exposed to rain or moisture, does not operate normally, or has been dropped.

Exemption from liability

- beyerdynamic GmbH & Co. KG will not be liable if any damage, injury or accident occurs due to negligent, incorrect or inappropriate operation of the product.

Location

- The equipment must be set up so that the mains switch, mains plug and all connections on the rear of the device are easily accessible.
- If you transport the equipment to another location take care to ensure that it is adequately secured and can never be damaged by being dropped or by impacts on the equipment.

Fire hazard

- Never place naked flames (e.g. candles) near the equipment.

Humidity / heat sources

- Never expose the equipment to rain or a high level of humidity. For this reason do not install it in the immediate vicinity of swimming pools, showers, damp basement rooms or other areas with unusually high atmospheric humidity.
- Never place objects containing liquid (e.g. vases or drinking glasses) on the equipment. Liquids in the equipment could cause a short circuit.
- Do not install near any heat sources such as radiators, heat registers, stoves or other apparatus (including amplifiers) that produce heat.

Connection

- The equipment must be connected to a mains socket that has an earth contact.
- Protect the power cord from being walked on or pinched particularly at plugs, convenience receptacles, and the point where they exit from the apparatus.
- Lay all connection cables so that they do not present a trip hazard.
- Whenever working on the equipment switch off all inputs and outputs to the power supply.
- Check whether the connection figures comply with the existing mains supply. Serious damage could occur due to connecting the system to the wrong power supply. An incorrect mains voltage could damage the equipment or cause an electric shock.
- Please note that different operating voltages require the use of different types of power cable and plugs.

Please refer to the following table:

Voltage	Power plug according to standard
110 - 125 V	UL817 and CSA C 22.2 no 42.
220 - 230 V	CEE 7 page VII, SR section 107-2-D1/IEC 83 page C4.
240 V	BS 1363 (1984): "Specification for 13A fused plugs and switched and un-switched socket outlets."

- If the equipment causes a blown fuse or a short circuit, disconnect it from the mains and have it checked and repaired.
- Do not hold the mains cable with wet hands. There must be no water or dust on the contact pins. In both cases you could receive an electric shock.
- The mains cable must be firmly connected. If it is loose there is a fire hazard.
- Always pull out the mains cable from the mains and/or from the equipment by the plug – never by the cable. The cable could be damaged and cause an electric shock or fire.
- Do not use the equipment if the mains plug is damaged.
- If you connect defective or unsuitable accessories, the equipment could be damaged. Only use connection cables available from or recommended by beyerdynamic. If you use cables you have made up yourself, all claim to warranty is null and void.

Maintenance

- Only clean the equipment with a slightly damp or dry cloth. Never use solvents as these damage the surface.

Troube shooting and servicing

- Do not open the equipment without authorisation. You could receive an electric shock. There are no user-serviceable parts inside.
- Leave all service work to authorised expert personnel.

1.2 Stegos TB boundary microphone

- Protect the boundary microphone from moisture and sudden impacts. You could either injure yourself or others or damage the microphone.
- Never take batteries apart yourself. The battery acid contained will damage skin and clothing.
- The boundary microphone does not contain any user-serviceable parts inside. Dismantling the microphone yourself may invalidate the guarantee.
- If the rechargeable battery is exhausted after several years, please contact your dealer for an appropriate exchange.

1.3 Disposal

- Old batteries may contain substances that are harmful to your health and environment.
- The device provides built-in rechargeable batteries, which you cannot remove yourself, therefore, return the device to your dealer for recycling when the batteries are exhausted.
- All batteries are recycled to reclaim valuable material such as iron, zinc or nickel.

2. Stegos RS receiver

The receiver provides three different connections for video conference systems: 3-pin Phoenix terminal strip, mini jack (3.5 mm) and 3-pin XLR. The individual microphone signals are available via a multipin Phoenix terminal strip. For the data exchange with media control systems or PC there is an RS 232 interface and a USB connection available. The channel LEDs display which channel is occupied (red) or available (green). Up to four acoustical boundary microphones can be operated with one receiver.

2.1 Controls and indicators

Front view

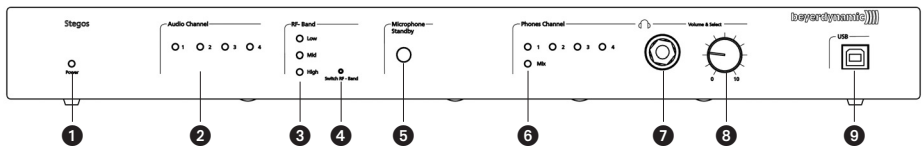

Rear view

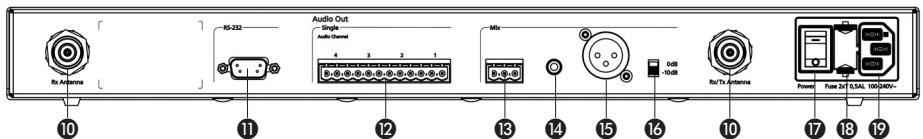

- 1 Power on LED
- 2 Audio channel LEDs 1 to 4 (green = channel vacant; red = channel occupied)
- 3 LEDs for RF band (high, mid, low)
- 4 Push-button for RF band selection
- 5 Standby button for microphone
- 6 LED for headphone channel
- 7 Headphone connection
- 8 Rotary potentiometer with push-button to select headphone channel and volume of the individual microphones
- 9 USB connection
- 10 Antenna connection
- 11 RS 232 interface
- 12 Output audio channels, 12-pin Phoenix terminal strip
- 13 Connection for video conference system, 3-pin Phoenix terminal strip
- 14 Connection for video conference system, mini jack (3.5 mm)
- 15 Connection for video conference system, 3-pin XLR
- 16 Changeover switch
- 17 On/Off switch
- 18 Fuse
- 19 Mains connection

2.2 How to connect the antennae

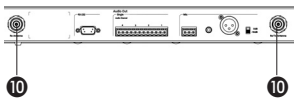

Connect the antennae to the antenna sockets **10**. Please note that for diversity operation both antennae have to be connected. A weighting circuit silently makes sure that the better antenna signal is received.

2.3 Where to place the receiver

- Place the Stegos RS receiver in the same room where the transmission takes place. Make sure that the receiver is placed on the same table height as the Stegos TB boundary microphone.
- Avoid shadowing effect of the Stegos RS antennae, especially by metallic surfaces.
- A free line of sight between the Stegos RS receiver and the Stegos TB microphone is ideal. Big obstacles in between can possibly affect the radio transmission. In such specific installations the use of remote antennae can possibly achieve an improvement of the RF situation.

2.4 Connection

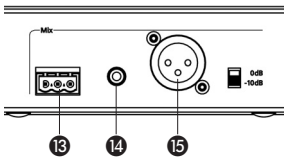

- Connect the Stegos RS receiver to your video conference system. There are three different connections:
3-pin Phoenix terminal strip **13**
Mini jack (3.5 mm) **14**
3-pin XLR **15**

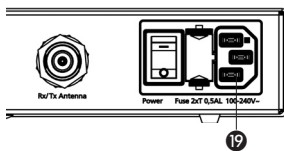

- Connect the power cable to the mains connection **19** and to the power socket.

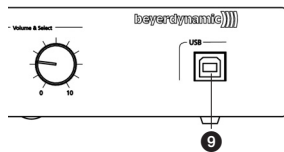

- If you want to control or monitor the system via PC connect the USB connection **9** to a PC.

Wiring Phoenix terminal strips – rear view Stegos RS

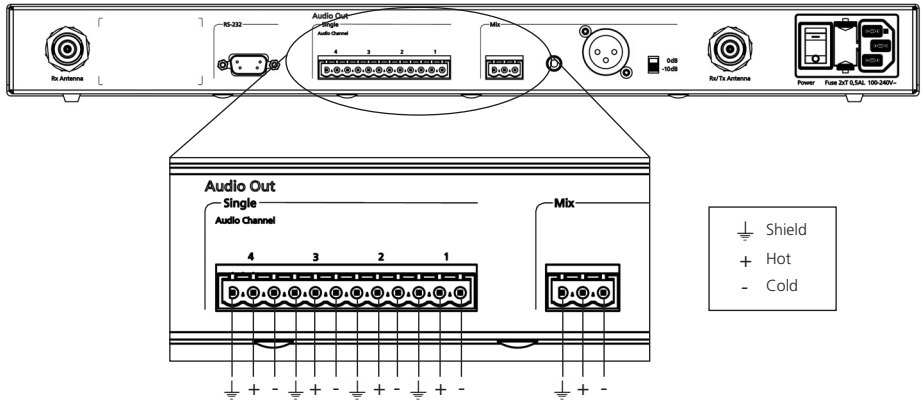

2.5 How to operate the receiver

- Turn on the receiver with the on/off switch 17. The green power on LED 1 will illuminate.

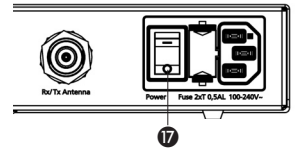

- The channel LEDs 1 to 4 will illuminate green to indicate the availability. As soon as you turn on the first Stegos TB boundary microphone, the channel LED 1 will illuminate 2 red to indicate that the channel is occupied.

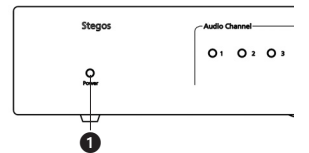

- At the factory the RF band “Low” has been adjusted. If interferences occur, you should change the frequency band. Use the tip of a pencil or a paper clip to press the countersunk push-button for RF band selection 4. The boundary microphones are automatically set to the selected frequency band.

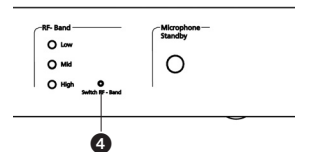
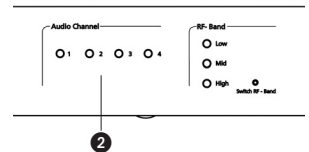

2.6 How to install a receiver into a 19" rack

- If you want to install a receiver into a 19" rack, mount the supplied brackets to the right and left hand side.

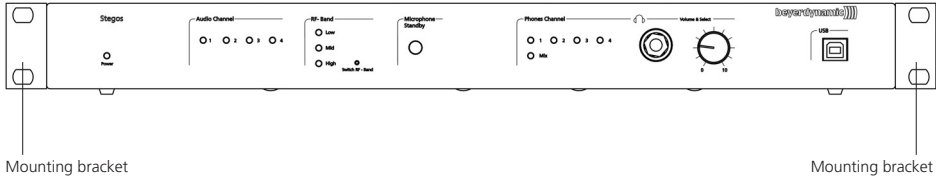

3. Stegos TB boundary microphone

The boundary microphone provides a semi-cardioid polar pattern with a high gain before feedback. The microphone is powered via integrated rechargeable NiMH batteries, which have to be recharged **before** using the microphone the **first** time. The operating time is 14 hours at minimum. The microphone can be recharged or operated permanently via a power supply unit connected to the DC connection. The maximum charging time is around 2 hours. The battery and charging state is displayed via an LED on the rear of the microphone.

3.1 Controls and indicators

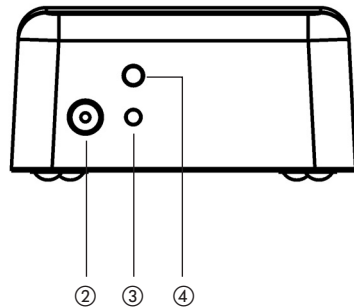
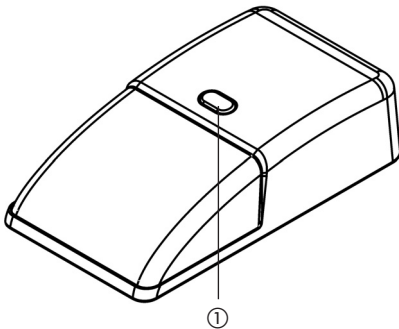

- ① Button for On / Off / Mute of the microphone
- ② DC connection for charging or DC-powered operation
- ③ Operating control LED
- ④ Button for On / Off of the device

3.2 How to operate the microphone

On/Off mode

- Turn on the Stegos TB boundary microphone with the push-button ①. The microphone that is turned on first, is always allocated to channel 1.
- The microphone is open and the push-button will illuminate red. If you press the push-button ① another time, the microphone is muted, but the channel still allocated. The push-button does not illuminate any more.

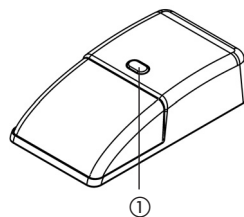

Push-To-Mute mode

- Turn on the Stegos TB boundary microphone with the push-button ①. The microphone that is turned on first, is always allocated to channel 1.
- The microphone is open and the push-button ① will illuminate red. If you hold down the push-button ①, the microphone is muted. The push-button ① does not illuminate any more. The microphone is still allocated to a channel.
- If you release the push-button ①, the microphone is open again.

Function test

- You can test if the boundary microphone are operating: Connect a headphone to the Stegos RS receiver ⑦. Turn the control ⑧ to set the volume and press the control ⑧ several times until you have listened to all channels from 1 to 4 or the Mix signal.

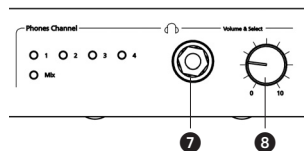

How to turn off

- There are several ways to turn off the microphone:
 - a) Press the on/off switch ① for about 3 seconds (only when the on/off mode has been selected).
 - b) Press the push-button ④ for about 3 seconds at the rear of the microphone unit.

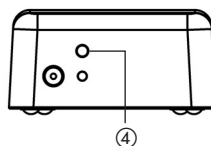
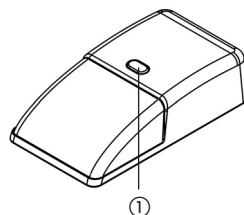

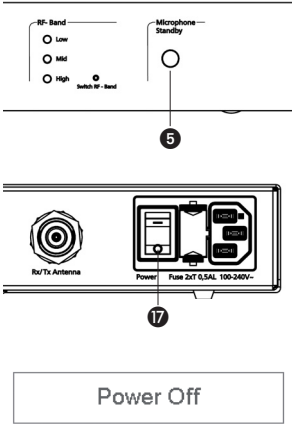

- c) Press the stand-by push-button 5 of the Stegos RS receiver.
- d) Turn off the Stegos RS receiver via the on/off switch 17 on the rear of the Stegos RS receiver.
- e) Select the "Power off" push-button in the Stegos software.

3.3 How to recharge

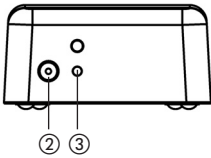

- **Before** the Stegos TB boundary microphone is used for the **first** time, you have to recharge the integrated rechargeable batteries.
- In order to recharge the batteries connect the supplied mains charger adapter to the microphone 2 and a power socket. The LED 3 will illuminate briefly for one time. The charging time is approx. 2 hours.
- The LED 3 displays the charging process:
 LED flashes red Charging in process
 LED illuminates permanently red . . . Battery is full
 LED flashes slowly red Normal charging process
 LED flashes rapidly red Error (in this case disconnect the mains charger adapter, then connect again; if needed phone the support staff)
- The operating time of the rechargeable batteries integrated in the Stegos TB boundary microphone is at least 14 hours.
 The LED 3 on the rear displays a reduced battery charge. When the LED 3 starts flashing green, the maximum operating time of the batteries is still approx. 1 hours. The Stegos software displays the battery status in per cent.

Important:

- Depending on the kind and time of use as well as the number of charging cycles, rechargeable batteries are subject to a natural aging process reducing the total capacity and the maximum operating time.
- It is normal that rechargeable batteries are heated up during the charging process.
- If the boundary microphone is turned on while charging, the LED 3 will illuminate green.

3.4 Mains operated

- The Stegos TB boundary microphone can also be powered via the supplied mains charger adapter.
- Connect the mains charger adapter to the DC socket ②. The LED ③ will illuminate briefly for once, afterwards the LED ③ will permanently illuminate green.
- The Stegos TB boundary microphone is also charged while the mains charger adapter is connected.

4. Stegos software

With the Stegos software you can configure and monitor many parameters for the Stegos TB boundary microphone and the Stegos RS receiver.

4.1 System requirements

- PC Pentium III 800 MHz or compatible
- Operating system: Windows® 2000 or XP
- Memory: 256 MB RAM at least
- HDD: > 256 MB free space
- Screen resolution: 1024 x 768 or higher
- Graphics card memory: 16 MB
- 1 free USB port or
- 1 free COM port (RS 232)

4.2 Installation

- Connect the Stegos RS receiver ⑱ and the PC to the mains.
- Connect the USB port ⑨ or the RS 232 interface ⑪ of the Stegos RS receiver to the appropriate port of your PC.
- Turn on the PC.
- Insert the CD-ROM with the Stegos Software into the CD-ROM drive, select “Setup.exe” and install the software into the requested directory on the hard drive.
- Follow the instructions of the installation program.

Rear view Stegos RS

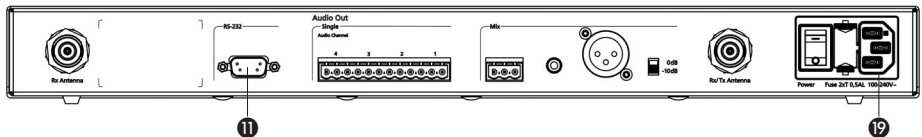

Front view Stegos RS

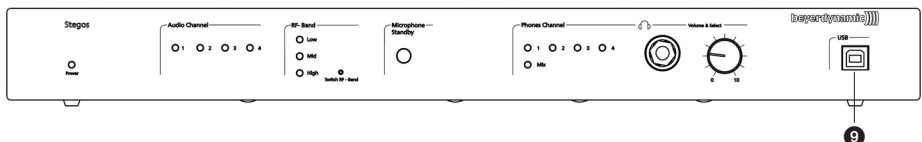

Rear view Stegos RS

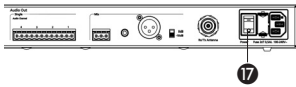

Front view Stegos RS

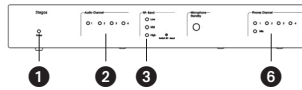

Stegos TB

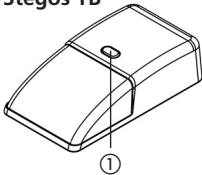

4.3 Putting into operation

- Turn on the Stegos RS receiver with the on/off switch 17 on the rear.
- When the receiver is ready for use, the green Power on LED 1, the audio channel LEDs 2, the RF band LED 3 and the appropriate LED 6 of the selected headphone channel will illuminate on the front.
- Turn on the Stegos TB boundary microphones by pressing the push-button 1.
- Start the software.
- When the Stegos RS receiver is connected to the RS 232 interface of your PC, select under "Connectivity Settings" in the "Settings" menu the appropriate "Com" port and then select "System Connect".

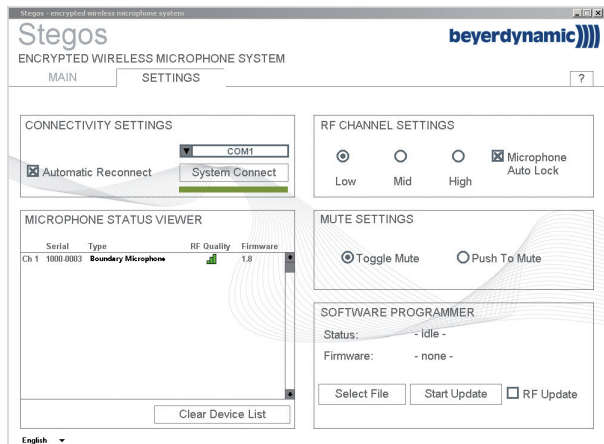

- For firmware and software updates please visit our homepage www.beyerdynamic.com

4.4 Main menu

System Control

- Here you can set the output volume of the individual channels or the master.
- The microphone which has been turned on first is always allocated to channel 1.
- If you would like to lock some channels, select the “ON” button which is changed into an “OFF” button.
- If the “Global Mute” function is selected, a loudspeaker symbol is displayed under the “Master” control. If the microphone is muted a crossed-out loudspeaker is displayed.

Microphone Battery Status

- The remaining battery power status of the individual microphones is displayed in per cent.

Connectivity

- An existing connectivity to a PC is displayed by a green bar.
- If the bar is grey, there is no connectivity. Turn on the receiver or select the appropriate Com port under “Connectivity Settings” in the “Settings” menu. Select the “System Connect” button.

Microphone Global Settings

- Here you can activate the “Global Mute” function. The function is activated when an orange bar is displayed below the “Global Mute” button.
- “Global Mute” means that when one microphone is muted via the push-button ①, the other Stegos TB boundary microphones in the room are also muted.
- With the “Power Off” button you can turn off the turned on Stegos TB boundary microphones.

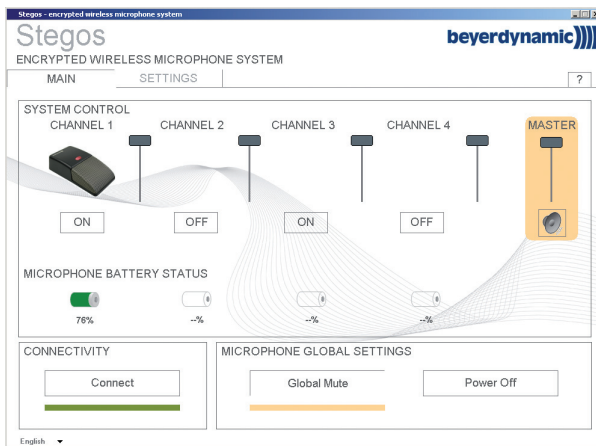

4.5 Settings

Connectivity Settings

- Depending if you have connected the Stegos RS receiver to the USB port or RS 232 interface, you can select the appropriate Com port.
- When you have selected the Com port, select “Connect”.
- If the connection is to be set automatically after a reboot, tick the “Automatic Reconnect” tick box.

Microphone Status Viewer

- Here you can recognise which microphones are currently active or which microphones were active. The active microphones display in addition to the serial number, device type and firmware as well as the channel and RF quality.
- If the RF quality is okay, three bars are displayed. If the RF quality drops, the bars are reduced correspondingly.

RF Channel Settings

- You can select among three frequency bands: Low, Mid, High.
- In order to set the microphones automatically to the selected frequency band, tick the “Microphone Auto Lock” tick box.
- If the microphones are configured according to your requests you can deactivate the “Microphone Auto Lock” tick box.

Tip

The function “Microphone Auto Lock” has the advantage that the microphones automatically search for a Stegos RS receiver when turned on and are configured to this one. If you change the frequency band (e.g. to avoid jamming sources such as Wireless LAN), the microphones automatically search for a receiver again and are configured to the changed frequency band.

Mute Settings

- If you activate the “Toggle Mute” option, the microphone is activated when the push-button ① is pressed and deactivated when the push-button is pressed again.
- If you activate the “Push-To-Mute (PTM)” option, the microphone is always open and only muted, when you hold down the push-button ①.

Software Programmer

- In the Software Programmer area you can update the firmware of the Stegos receiver and the boundary microphones.
- If you would like to update the firmware of the receiver, select the “Select File” button, select the appropriate file and then select the “Start Update” button.
- If you would like to update the firmware of the boundary microphones, tick the “RF Update” tick box, select the “Select File” button, choose the appropriate file and select the “Start Update” button.

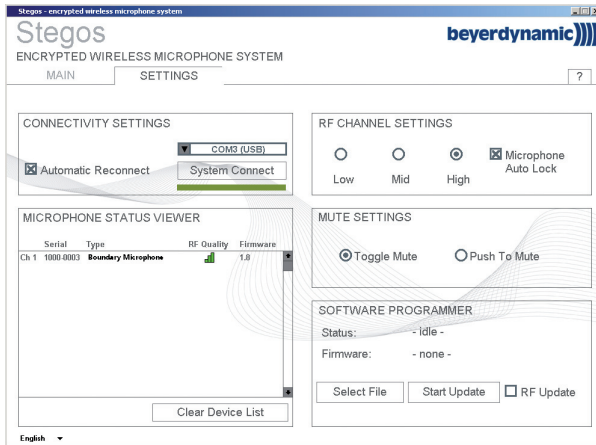

5. Maintenance

- Protect the handheld transmitter from humidity, knocks and shock. Avoid dropping the transmitter at all times
- For cleaning metal surfaces, use a soft cloth moistened with methylated spirits or alcohol.

6. Service

Servicing must be carried out by qualified service personnel only. Dismantling the microphone yourself will invalidate the guarantee.

7. Trouble shooting

Problem	Possible Cause	Solution
The green operating control LED ③ of the boundary microphone will flash.	<ul style="list-style-type: none"> The rechargeable battery is almost empty. 	<ul style="list-style-type: none"> Recharge the boundary microphone.
The boundary microphone goes off.	<ul style="list-style-type: none"> The rechargeable battery is empty. 	<ul style="list-style-type: none"> Recharge the boundary microphone.
It is not possible to allocate the microphone.	<ul style="list-style-type: none"> The microphone is not within the range of the receiver. Interference caused by WLAN 	<ul style="list-style-type: none"> Reduce the distance between receiver and boundary microphone. Select another frequency band with the push-button ④.
The boundary microphone cannot be turned on.	<ul style="list-style-type: none"> The rechargeable battery is empty. 	<ul style="list-style-type: none"> Recharge the boundary microphone.
The boundary microphone can be turned on, but not allocated.	<ul style="list-style-type: none"> The receiver is not turned on. The microphone is not within the range of the receiver. The channels in the Stegos Software are not activated. The number of the allowed microphones is exceeded. 	<ul style="list-style-type: none"> Turn on the receiver. Reduce the distance between receiver and boundary microphone. Activate the channels in the Stegos Software. Please note that 4 microphones can simultaneously be operated at maximum.

8. Simultaneous operation of the Stegos system and other 2.4 GHz devices (e.g. WLAN, Bluetooth)

8.1 Physical laws

Due to many physical laws it is not possible to guarantee a simultaneous interference-free operation of different devices using the same frequency band. Radio devices operating in the same frequency band will always disturb each other (the function can be disturbed as well).

For the use of UHF wireless microphones it is known that 2 devices can never be operated on the same frequency. It is only possible to operate a certain number of compatible radio devices within a defined frequency band.

This applies also to the 2.4 GHz-ISM band (2400 MHz - 2484 MHz). Due to digital transmission techniques and various transmission standards it is possible, but not recommended, to operate certain devices simultaneously within the same frequency band.

8.2 Stegos and WLAN or WiFi

Like WLAN, the Stegos system uses the same bandwidth of approx. 22 MHz for each RF channel (Low, Mid, High). This results in three compatible RF channels in the 2.4 GHz-ISM band. These are theoretically:

- Compatible channel 1: 2400 MHz - 2428 MHz (theoretical mid frequency: 2414 MHz)
- Compatible channel 2: 2428 MHz - 2456 MHz (theoretical mid frequency: 2442 MHz)
- Compatible channel 3: 2456 MHz - 2484 MHz (theoretical mid frequency: 2470 MHz)

The Stegos system uses RF channels (Low, Mid, High) compatible to each other. For WLAN the user has to configure compatible RF channels.

Frequencies Stegos / WLAN

Stegos

Channel	Centre frequency
Low	2412 MHz
Mid	2438 MHz
High	2464 MHz

WLAN

Channel	Centre frequency
1	2412
2	2417
3	2422
4	2427
5	2432
6	2437
7	2442
8	2447
9	2452
10	2457
11	2462
12	2467
13	2472
14	2484

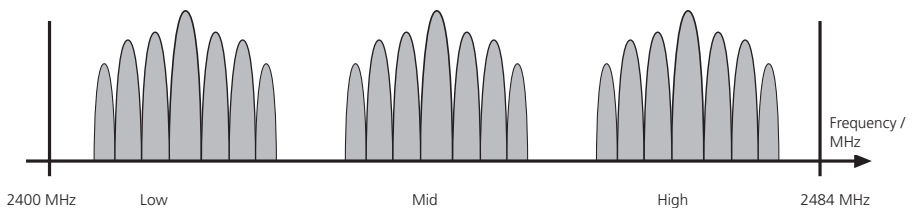

You can easily recognise that the individual WLAN channels overlap considerably due to their bandwidth. All neighbouring channels (e.g. channel 1 & 2 or channel 7 & 8) cannot be used simultaneously, because they would disturb each other. Furthermore, channel 12 and 13 are not approved for the use in the USA. In general, these channels are not used either. Within the remaining frequency bands only the WLAN channels 1, 6 and 11 can be used simultaneously.

For this reason the WLAN channels 1, 6 and 11 were selected for the RF channels Low, Mid and High used for the Stegos system. Due to this frequency compatibility the Stegos system is operated WLAN-friendly.

Due to careful frequency planning it is possible to operate one Stegos receiver and a maximum of two WLAN devices nearby simultaneously.

More tips for installation

- Keep a minimum distance of approx. 5 m between WLAN or WiFi devices (e.g. Router, Repeater) and the transmitting and receiving antennae of the Stegos RS receiver.
- If possible, deactivate all WLAN interfaces of laptops using the same frequency range as Stegos.
- The distance between the WLAN or WiFi and Stegos channels should be as large as possible.
- The channels of the Stegos system can be selected with the supplied Stegos software.

8.3 Stegos and Bluetooth

- Bluetooth devices make use of the whole 2.4 GHz range with changing carrier frequencies (frequency hopping).
- Interferences caused by Bluetooth devices (including microwave ovens) in normal operation can be excluded due to different measures inside the Stegos system and an advanced transmission protocol.
- It cannot be excluded, however, that an existing Bluetooth data traffic will be interfered by Stegos.

8.4 Example for Stegos, media control systems and WLAN

The 2.4 GHz technology is used for many applications in discussions and meetings. In addition to a wireless discussion system other functions (light or volume control etc.) are operated via a wireless 2.4 GHz touch screen of a media control system. Furthermore, the participants of a meeting often have direct internet access via a WLAN access point.

The Stegos system and WLAN make use of compatible transmission standards. This should be considered when also using a media control system with a touch screen. State-of-the-art devices correspond to the WLAN standard.

1. Configure the Stegos system to the RF channel "Low". The Stegos system then makes use of the frequency range of 2401 to 2423 MHz. This frequency range must be reserved for the Stegos exclusively.
2. Configure the touch screen of the media control system to the frequency range of 2426 to 2448 MHz. This corresponds to the WLAN channel 6. This frequency range must be reserved for the use of the touch screen exclusively.
3. Configure the WLAN access point to WLAN channel 11 making use of the frequency range 2451 to 2473 MHz. This frequency range must be reserved for the use by WLAN exclusively.

9. Components

Stegos TB	Wireless condenser boundary microphone, semi-cardioid, black, 128bit encryption, integrated antennae, rechargeable battery pack and operating/status indicators, with mains charger adapter	Order # 721.360
Stegos RS	Digital diversity receiver, 4 channels, 19" metal housing, 1 U, 128bit digital encryption, RS 232, USB port, with Stegos software and 2 x CA 2411 angled rod antennae.	Order # 721.379

10. Technical specifications

General

Frequency range	2400 – 2483.5 MHz (ISM Band)
Bandwidth	22MHz
Modulation.	Direct Sequence Spread Spectrum DSSS
Transmission protocol	Digital signal processing acc. to own standard, 128 bit encryption
Max. number of audio channels	4 usable channels per system
Signal-to-noise ratio	80 dB (digital transmission network)
Transmitter power.	max. 20 dBm
Range between TB and RS	> 100 m (328 ft) at line of sight
Approval.	world-wide

Stegos TB boundary microphone

Transducer type	Condenser (back electret)
Operating principle.	Pressure gradient
Polar pattern.	Semi-cardioid
Frequency response	20 Hz – 12 kHz
Dynamic range	68 dB (A-weighted)
Open circuit voltage	300 mV/Pa
Max. SPL at 1 kHz.	100 dB SPL
RFI proof.	Scudio™ technology
Power consumption	approx. 100 mA (microphone open)
Power supply	4.8 VDC via integrated NiMH rechargeable batteries (4 cells, each with 2100 mAh)
Operating time.	14 hours at least; DC powered permanent operation possible with CA 2458 mains charger adapter
Charging time with power supply unit (15 VDC, 1.6 A)	max. 2 hours
Temperature range (at < 90% humidity)	+10 °C – +40 °C (+50 °F – +104 °F)
Storage temperature (at < 90% humidity)	-20 °C – +55 °C (-4 °F – +133 °F)
Dimensions (L x W x H)	approx. 138 x 76 x 38 mm (5.4 x 3 x 1.5 in)
Weight	approx. 410 g (0.9 lbs)

Stegos RS receiver

Connections (on the rear)

Balanced, per channel (+6 dBu)	Phoenix terminals (4x3)
Balanced, Mix Signal (+6 dBu/-10dB switchable)	Phoenix terminals / XLR (male) / mini jack (3.5 mm)
Monitor headphone output	1/4" jack (6.35 mm)
Media control / Service	RS 232, 57.6 kbps, 8-N-1
Media control / PC	USB, type B (on the front)
Tx/Rx and Rx antennae	2 N(HF)-connectors (socket)
Power connection	IEC power connection, incl. power cable 1.5 m (4,9 ft)

Power supply unit

Voltage supply	100 – 240 VAC, 50/60 Hz
Fuse	0.5 A, slow-blow
Power consumption	typ. 3 W, max. 5 W

Indicators (on the front)

Power	LED (green)
Channel (active/occupied)	4x LED (green/red)
Frequency range	3x LED (green)
Monitor selection (Channel / Mix)	5x LED (green)

Controls (on the front)

Standby microphones	Push-button
Selection RF band	Countersunk push-button
Volume control monitor-headphone with monitor channel selection	Rotary potentiometer with push-button

General

Temperature range (at < 90% humidity)	+10 °C – +50 °C (+50 °F – +122 °F)
Storage temperature (at < 90% humidity)	-20 °C – +55 °C (-4 °F – +131 °F)
Dimensions (L x W x H)	19", 1 U (238 x 450 x 44mm / 9.4 x 17.7 x 1.7 in)
Weight	2.5 kg (5.5 lbs)

Dimensions

Stegos RS receiver

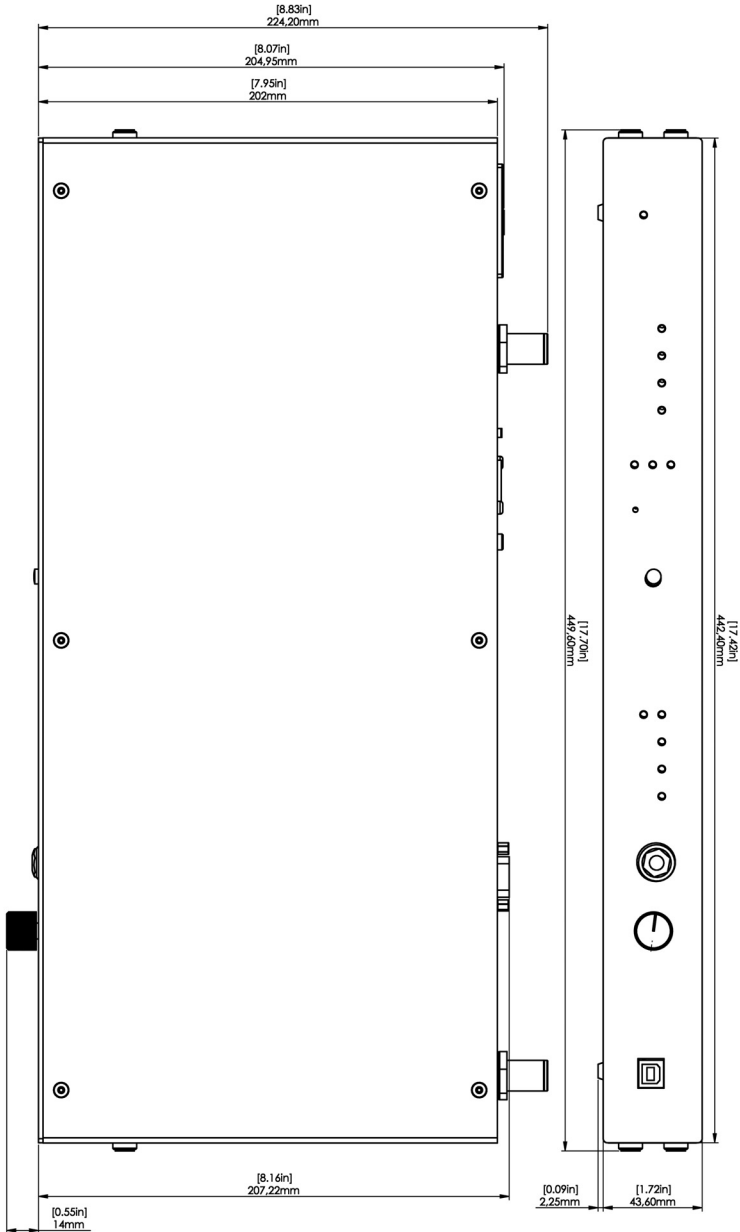

All dimensions in mm and [inch]

Dimensions

Stegos TB boundary microphone

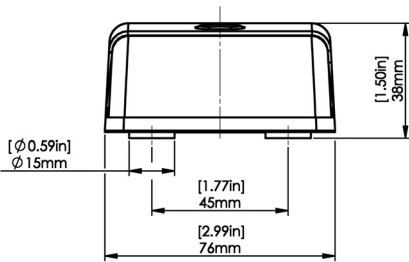
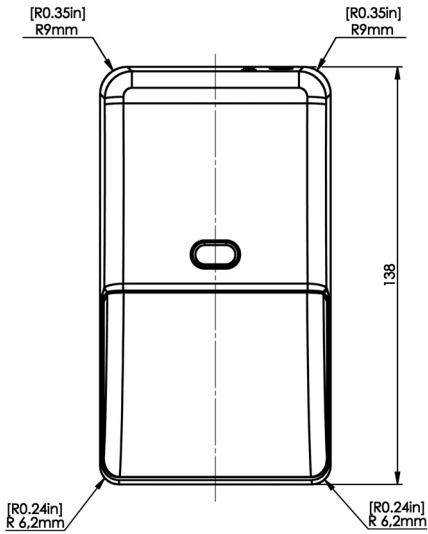

All dimensions in mm and [inch]

EC-DECLARATION OF CONFORMITY

**Application of
Council Directive:**

1999/5/EC
R&TTE Directive

2004/108/EC
Electromagnetic Compatibility

2006/95/EC
Low Voltage Directive

**Standards to which
Conformity is declared:**

EMC	EN 301 489-1	V1.8.1
	EN 301 489-17	V1.3.2
Radio Spectrum	EN 300 328	V1.7.1
Safety	EN 60 950-1	

Manufacturer's Name:

beyerdynamic GmbH & Co. KG

Manufacturer's Address:

Theresienstrasse 8, 74072 Heilbronn, Germany

Type of Equipment:

Digital Wireless Microphone System

Model Number/s:

Stegos TB, Stegos RS

I, the undersigned, as an employee of beyerdynamic, hereby declare that the equipment specified conforms to the above Directive and Standards.

Manufacturer's Signature:



Date:

August 1st, 2010

Full Name:

Ulrich Roth

Position:

Director of R&D

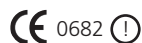

FCC Regulation

FCC ID: OSDSTEGOSTB for Stegos TB

FCC ID: OSDSTEGOSRS for Stegos RS

Canada: IC: 3628A-STEGOSTB for Stegos TB

Canada: IC: 3628A-STEGOSRS for Stegos RS

Part 15.19 Statement

NOTICE:

This device complies with Part 15 of the FCC Rules [and with RSS-210 of Industry Canada].

Operation is subject to the following two conditions:

- (1) this device may not cause harmful interference, and*
- (2) this device must accept any interference received, including interference that may cause undesired operation.*

Part 15.21 Statement

NOTICE:

Changes or modifications made to this equipment not expressly approved by (manufacturer name) may void the FCC authorization to operate this equipment.

Part 15.105 Statement

NOTE: *This equipment has been tested and found to comply with the limits for a Class B digital device, pursuant to Part 15 of the FCC Rules. These limits are designed to provide reasonable protection against harmful interference in a residential installation. This equipment generates, uses and can radiate radio frequency energy and, if not installed and used in accordance with the instructions, may cause harmful interference to radio communications. However, there is no guarantee that interference will not occur in a particular installation. If this equipment does cause harmful interference to radio or television reception, which can be determined by turning the equipment off and on, the user is encouraged to try to correct the interference by one or more of the following measures:*

- *Reorient or relocate the receiving antenna.*
- *Increase the separation between the equipment and receiver.*
- *Connect the equipment into an outlet on a circuit different from that to which the receiver is connected.*
- *Consult the dealer or an experienced radio/TV technician for help.*

RF Exposure Statement

Radiofrequency radiation exposure Information:

This equipment complies with FCC radiation exposure limits set forth for an uncontrolled environment. This equipment should be installed and operated with minimum distance of 20 cm between the radiator and your body.

This transmitter must not be co-located or operating in conjunction with any other antenna or transmitter.

beyerdynamic))))

beyerdynamic GmbH & Co. KG
Theresienstr. 8 | 74072 Heilbronn – Germany
Tel. +49 (0) 7131 / 617 - 0 | Fax +49 (0) 7131 / 617 - 204
info@beyerdynamic.de | www.beyerdynamic.com

For further distributors worldwide, please go to www.beyerdynamic.com

