

TEST REPORT

Test Report No.: 1-1762-01-05/09-A



Testing Laboratory

CETECOM ICT Services GmbH

Untertürkheimer Straße 6 – 10
 66117 Saarbrücken/Germany
 Phone: + 49 681 5 98 - 0
 Fax: + 49 681 5 98 - 9075
 Internet: <http://www.cetecom-ict.de>
 e-mail: info@ict.cetecom.de

Accredited Test Laboratory:

The test laboratory (area of testing) is accredited according to DIN EN ISO/IEC 17025
 DAR registration number: DGA-PL-176/94-D1

Area of Testing: Radio Satellite Communications

Applicant

beyerdynamic GmbH & Co. KG

Theresienstraße 8
 74072 Heilbronn/GERMANY
 Phone: +49 (0) 7131 61 71-0
 Fax: +49 (0) 7131 617 215
 Contact: Ulrich Roth
 e-mail: roth@beyerdynamic.de
 Phone: +49 (0) 7131 617 155

Manufacturer

beyerdynamic GmbH & Co. KG

Theresienstraße 8
 74072 Heilbronn/GERMANY

Test Standard/s

47 CFR Part 15	Title 47 of the Code of Federal Regulations; Chapter I-Federal Communications Commission subchapter A - general, Part 15-Radio frequency devices
RSS - 210 Issue 7	Spectrum Management and Telecommunications – Radio Standards Specification Low-power Licence-exempt Radiocommunication Devices (All Frequency Bands): Category I Equipment

For further applied test standards please refer to section 3 of this test report.

Test Item

Kind of test item:	Wireless microphone system
Model name:	STEGOS TB
FCC ID:	OSDSTEGOSTB
IC:	3628A-STEGOSTB
Frequency [MHz]:	2412MHz – 2438MHz – 2464MHz
Power supply:	115V MAIN/4.8V NiMH battery
Temperature range:	0 °C to +40 °C



Test performed:

Andreas Keller

Test Report authorised:

Stefan Bös

1 Table of contents

1 Table of contents2

2 General Information3

 2.1 Notes.....3

 2.2 Application details.....3

3 Test standard/s3

4 Test Environment4

5 Test item4

6 Test Laboratories sub-contracted4

7 Summary of measurement results5

8 RF measurement testing.....6

 8.1 Description of test setup6

 8.1.1 Radiated measurements.....6

 8.1.2 Conducted measurements.....7

 8.2 Additional comments8

 8.3 RSP100 Test Report Cover Sheet / Performance Test Data.....9

9 Measurement Results10

 9.1 Antenna Gain10

 9.2 Power Spectral Density.....11

 9.3 Spectrum Bandwidth of a DSSS System – 6 dB Bandwidth14

 9.4 Spectrum Bandwidth of a DSSS System – 20 dB Bandwidth15

 9.5 Maximum Output Power15

 9.6 Band Edge Compliance Conducted15

 9.7 Band Edge Compliance Radiated15

 9.8 TX Spurious Emissions Conducted15

 9.9 TX Spurious Emissions Radiated15

 9.10 RX Spurious Emissions Radiated15

 9.11 TX Spurious Emissions Radiated < 30 MHz.....15

 9.12 TX Spurious Emissions Conducted < 30 MHz15

10 Test equipment and ancillaries used for tests15

Annex A Photographs of the Test Set-up15

Annex B External Photographs of the EUT15

Annex C Internal Photographs of the EUT15

Annex D Document history15

Annex E Further information.....15

2 General Information

2.1 Notes

The test results of this test report relate exclusively to the test item specified in this test report. CETECOM ICT Services GmbH does not assume responsibility for any conclusions and generalisations drawn from the test results with regard to other specimens or samples of the type of the equipment represented by the test item. The test report may only be reproduced or published in full. Reproduction or publication of extracts from the report requires the prior written approval of CETECOM ICT Services GmbH.

This test report is electronically signed and valid without handwriting signature. For verification of the electronic signatures, the public keys can be requested at the testing laboratory.

2.2 Application details

Date of receipt of order:	2010-02-17
Date of receipt of test item:	2010-07-13
Start of test:	2010-07-13
End of test:	2010-08-13
Person(s) present during the test:	Mr. SPYCHALA, Mr. FORSTER

3 Test standard/s

Test Standard	Version	Test Standard Description
47 CFR Part 15	2009-10	Title 47 of the Code of Federal Regulations; Chapter I-Federal Communications Commission subchapter A - general, Part 15-Radio frequency devices
RSS - 210 Issue 7	2007-06	Spectrum Management and Telecommunications - Radio Standards Specification Low-power Licence-exempt Radiocommunication Devices (All Frequency Bands): Category I Equipment

4 Test Environment

Temperature:	T_{nom}	+24 °C during room temperature tests
	T_{max}	+40 °C during high temperature test
	T_{min}	0 °C during low temperature test
Relative humidity content:		58 %
Air pressure:		not relevant for this kind of testing
Power supply:	V_{nom}	115V AC-MAIN/4.8V NiMH battery
	V_{max}	-/-
	V_{min}	-/-

5 Test item

Kind of test item	:	Wireless microphone system
Type identification	:	Diskussionsfunkanlage STEGOS TB Art.-No.: 721360
S/N serial number	:	Radiated: 0000-0002, 0000-0004, 0000-0027 Conducted: Board (see photos Annex C)
HW hardware status	:	Release 1
SW software status	:	Release 1
Frequency Band [MHz]	:	2400.0 – 2483.5 3 channels 2412MHz, 2438MHz, 2464MHz
Type of Modulation	:	BPSK (15M8G1D)
Number of channels	:	3
Antenna	:	Ceramic chip antenna
Power Supply	:	Main adapter/NiMH battery pack 4HHR-210AA (4.8V)
Temperature Range	:	0°C to +40 °C

Max. power radiated: 12.7 dBm
Max. power conducted: 20.3 dBm

6 Test Laboratories sub-contracted

None

7 Summary of measurement results

- No deviations from the technical specifications were ascertained
- There were deviations from the technical specifications ascertained

TC Identifier	Description	Verdict	Date	Remark
RF-Testing	CFR Part 15 RSS 210, Issue 7, Annex 8	Passed	2010-09-08	-/-

Test Specification Clause	Test Case	Temperature Conditions	Power Source Voltages	Mode	Pass	Fail	NA	NP	Results (max.)
§15.247(b)(4) RSS 210 / A8.4(2)	Antenna Gain	Nominal	Nominal	DSSS	<input checked="" type="checkbox"/>	<input type="checkbox"/>	<input type="checkbox"/>	<input type="checkbox"/>	complies
§15.247(e) RSS 210 / A8.2(b)	Power spectral density	Nominal	Nominal	DSSS	<input checked="" type="checkbox"/>	<input type="checkbox"/>	<input type="checkbox"/>	<input type="checkbox"/>	complies
§15.247(a)(2) RSS 210 / A8.2(a)	Spectrum bandwidth of a FHSS system 6dB bandwidth	Nominal	Nominal	DSSS	<input checked="" type="checkbox"/>	<input type="checkbox"/>	<input type="checkbox"/>	<input type="checkbox"/>	complies
§15.247(a)(2) RSS 210 / A8.2(a)	Spectrum bandwidth of a FHSS system 20dB bandwidth	Nominal	Nominal	DSSS	<input checked="" type="checkbox"/>	<input type="checkbox"/>	<input type="checkbox"/>	<input type="checkbox"/>	complies
§15.247(b)(3) RSS-210 / A8.4(4)	Maximum output power	Nominal	Nominal	DSSS	<input checked="" type="checkbox"/>	<input type="checkbox"/>	<input type="checkbox"/>	<input type="checkbox"/>	complies
§15.247(d) RSS-210 / A8.5	Band edge compliance conducted	Nominal	Nominal	DSSS	<input checked="" type="checkbox"/>	<input type="checkbox"/>	<input type="checkbox"/>	<input type="checkbox"/>	complies
§15.205 RSS-210 / A8.5	Band edge compliance radiated	Nominal	Nominal	DSSS	<input checked="" type="checkbox"/>	<input type="checkbox"/>	<input type="checkbox"/>	<input type="checkbox"/>	complies
§15.247(d) RSS-210 / A8.5	TX spurious emissions conducted	Nominal	Nominal	DSSS	<input checked="" type="checkbox"/>	<input type="checkbox"/>	<input type="checkbox"/>	<input type="checkbox"/>	complies
§15.247(d) RSS-210 / A8.5	TX spurious emissions radiated	Nominal	Nominal	DSSS	<input checked="" type="checkbox"/>	<input type="checkbox"/>	<input type="checkbox"/>	<input type="checkbox"/>	complies
§15.109 RSS-Gen.	RX spurious emissions radiated	Nominal	Nominal	-/-	<input checked="" type="checkbox"/>	<input type="checkbox"/>	<input type="checkbox"/>	<input type="checkbox"/>	complies
§15.209(a) RSS-Gen	TX spurious emissions radiated < 30 MHz	Nominal	Nominal	DSSS	<input checked="" type="checkbox"/>	<input type="checkbox"/>	<input type="checkbox"/>	<input type="checkbox"/>	complies
§15.107(a)	Conducted emissions < 30 MHz	Nominal	Nominal	DSSS	<input checked="" type="checkbox"/>	<input type="checkbox"/>	<input type="checkbox"/>	<input type="checkbox"/>	complies

Note: NA = Not Applicable; NP = Not Performed

8 RF measurement testing

8.1 Description of test setup

8.1.1 Radiated measurements

The radiated measurements are performed in vertical and horizontal plane in the frequency range from 9 kHz to 25 GHz in semi-anechoic chambers. The EUT is positioned on a non-conductive support with a height of 0.80 m above a conductive ground plane that covers the whole chamber. The receiving antennas are confirmed with specifications ANSI C63.2-1996 clause 15 and ANSI C63.4-2003 clause 4.1.5. These antennas can be moved over the height range between 1.0 m and 4.0 m in order to search for maximum field strength emitted from EUT. The measurement distances between EUT and receiving antennas are indicated in the test setups for the various frequency ranges. For each measurement, the EUT is rotated in all three axes until the maximum field strength is received. The wanted and unwanted emissions are received by spectrum analysers where the detector modes and resolution bandwidths over various frequency ranges are set according to requirement ANSI C63-4-2003 clause 4.2.

Antennas are confirmed with ANSI C63.2-1996 item 15.

Semi anechoic chamber

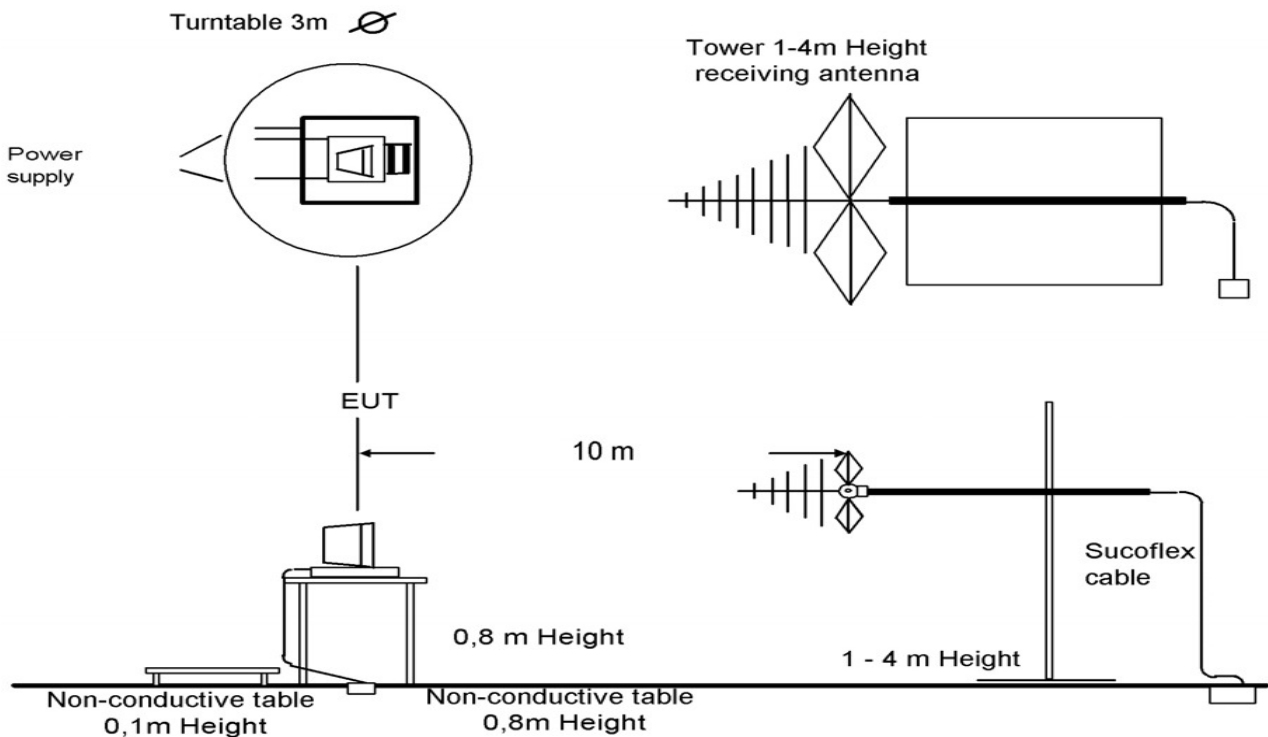

Picture 1: Diagram radiated measurements

9 kHz - 30 MHz:	active loop antenna
30 MHz – 1 GHz:	tri-log antenna
> 1 GHz:	horn antenna

The EUT is powered by an external power supply with nominal voltage. The signalling is performed from outside the chamber with a signalling unit (CMU200 or other) by air link using signalling antenna.

8.1.2 Conducted measurements

The EUT's RF signal is coupled out by the antenna connector which is supplied by the manufacturer. The signal is first 10dB attenuated before it is power divided (~6dB loss per branch). One of the signal paths is connected to the communication base Station (CMU200 or other), the other one is connected to the spectrum analyzer. The specific losses for both signal paths are first checked within a calibration. The measurement readings on the signalling unit/spectrum analyzer are corrected by the specific test set-up loss. The attenuator, power divider, signalling unit and the spectrum analyzer are impedance matched on 50 Ohm.

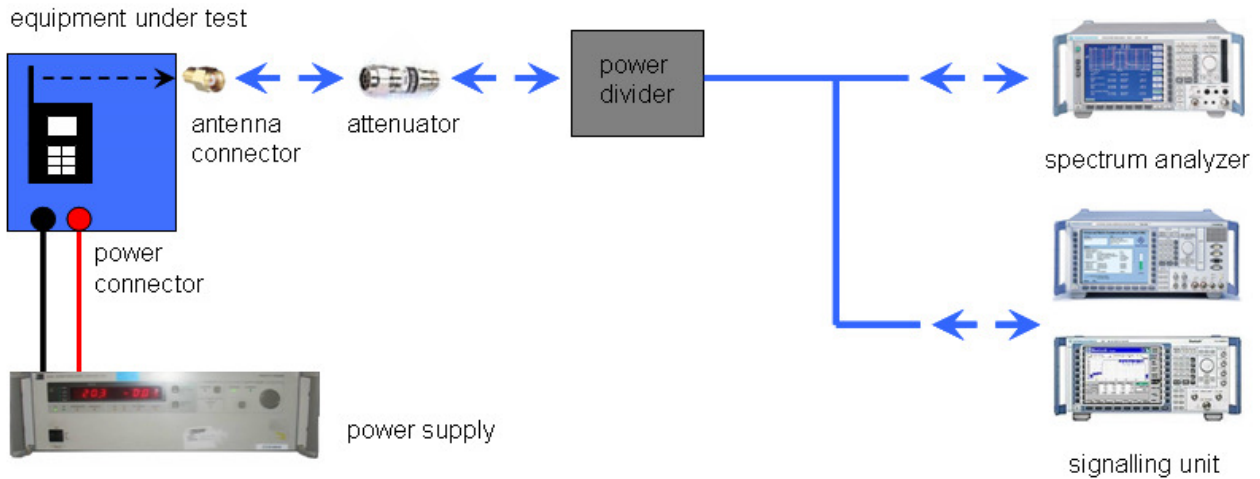

Picture 2: Diagram conducted measurements

8.2 Additional comments

Reference documents: Sendeleistung Stegos Stegos_PC Factory Version 1.0

Special test descriptions: None

Configuration descriptions: The duty cycle of the STEGOS_TB test sample is 8%.

Test mode: No test mode available.
 Factory software is used for power setting. Normal use modulation.

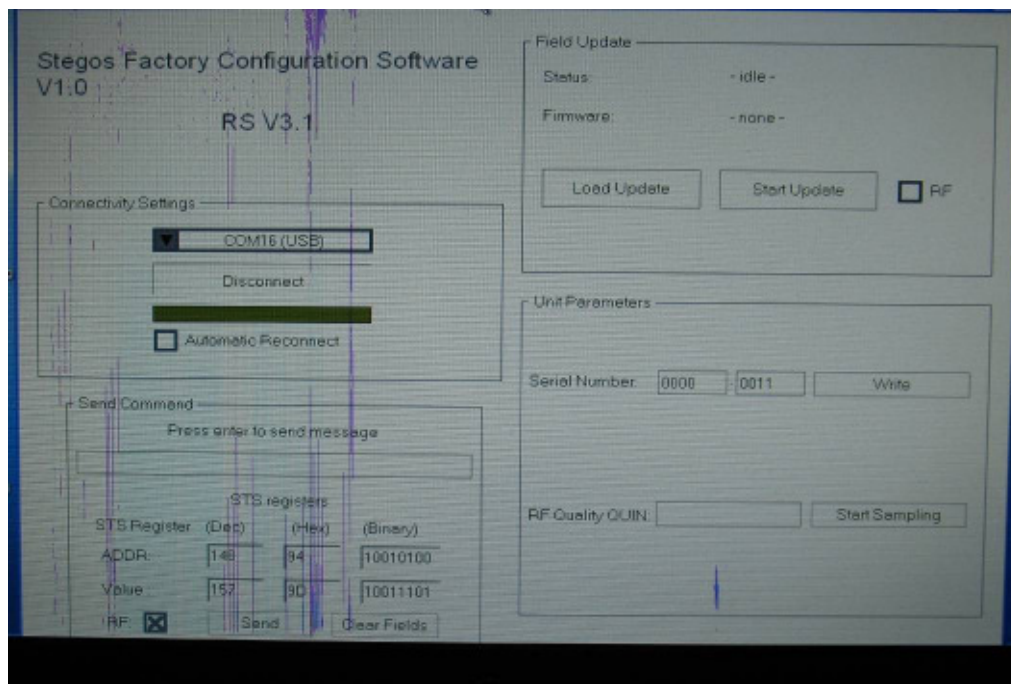

8.3 RSP100 Test Report Cover Sheet / Performance Test Data

Test Report Number	:	1-1762-01-05/09
Equipment Model Number	:	STEGOS TB Art.-No.: 721360
Certification Number	:	3628A-STEGOSTB
Manufacturer (complete Address)	:	beyerdynamic GmbH & Co. KG Theresienstraße 8 74072 Heilbronn / GERMANY
Tested to radio standards specification no.	:	RSS 210, Issue 7, Annex 8
Open Area Test Site IC No.	:	IC 3462C-1
Frequency Range	:	2400 – 2483.5 MHz-band (2412 – 2462 MHz)
RF-power [W] (max.)	:	cond.: 107.2mW EIRP: 18.6mW
Occupied bandwidth (99%-BW)	:	15.8 MHz
Type of modulation	:	BPSK
Emission Designator (TRC-43)	:	15M8G1D
Antenna Information	:	Ceramic chip antenna
Transmitter Spurious (worst case) [dBµV/m @ 3m]:		50 dBµV/m (noise floor)
Receiver Spurious (worst case) [dBµV/m @ 3m]:		50 dBµV/m (noise floor)

ATTESTATION:

DECLARATION OF COMPLIANCE:

I attest that the testing was performed or supervised by me; that the test measurements were made in accordance with the above-mentioned Industry Canada standard(s); and that the equipment identified in this application has been subjected to all the applicable test conditions specified in the Industry Canada standards and all of the requirements of the standard have been met.

Laboratory Manager:

2010-09-08
Date

Andreas Keller
Name

Signature

9 Measurement Results

9.1 Antenna Gain

Measurement:

The antenna gain of the complete system is calculated by the difference of radiated power in EIRP and the conducted power of the module. This measurement is performed only to evaluate the antenna gain.

Measurement parameters:

Measurement parameter	
Detector:	Peak
Sweep time:	Auto
Video bandwidth:	3 MHz
Resolution bandwidth:	3 MHz
Span:	30 MHz
Trace-Mode:	Max hold

Limits:

FCC	IC
CFR Part 15.247 (b)(4)	RSS 210, Issue 7, A 8.4(2)
Antenna Gain	
6 dBi	

Results:

T_{nom}	V_{nom}	lowest channel 2412 MHz	middle channel 2438 MHz	highest channel 2462 MHz
Conducted power [dBm]		20.0	19.4	19.1
Radiated power [dBm]		12.4	11.4	10.5
Gain [dBi] Calculated		-7.6	-8.0	-8.6

Result: The result of the measurement is passed.

9.2 Power Spectral Density

Description:

Measurement of the power spectral density of a digital modulated system. The measurement is repeated at the lowest, middle and highest channel.

Measurement:

Measurement parameter	
Detector:	Peak
Sweep time:	10 s
Video bandwidth:	3 kHz
Resolution bandwidth:	3 kHz
Span:	50 MHz
Trace-Mode:	Max Hold

Limits:

FCC	IC
CFR Part 15.247 (e)	RSS 210, Issue 7, A 8.2(b)
Power Spectral Density	
The transmitter power spectral density conducted from the transmitter to the antenna shall not be greater than 8 dBm in any 3 kHz band during any time interval of continuous transmission or over 1.0 second if the transmission exceeds 1.0-second duration.	

Result:

Modulation	Power Spectral density [dBm/3kHz]		
	2412 MHz	2438 MHz	2464 MHz
Frequency			
BPSK	-16.2	-16.5	-17.3
Measurement uncertainty	± 0.5 dB		

Result: The result of the measurement is passed.

Plot 1: Low channel

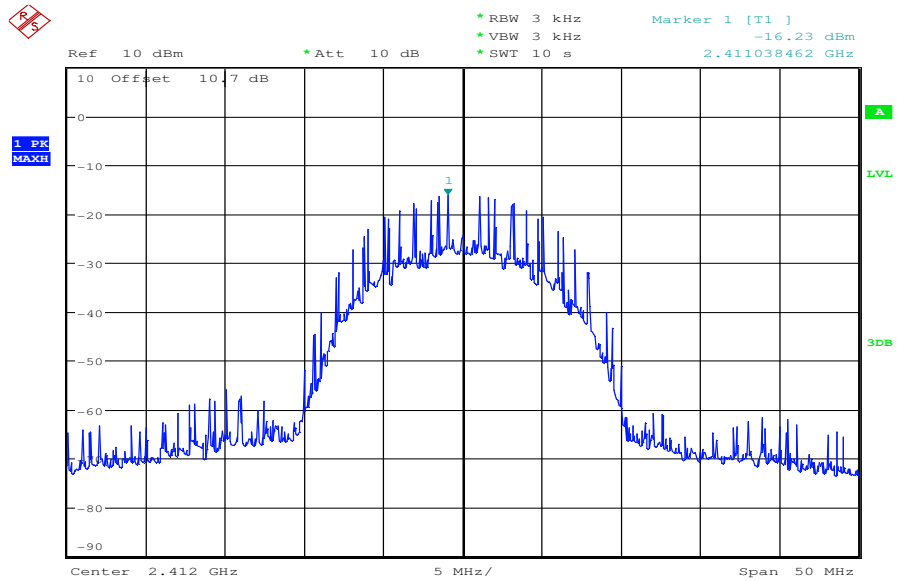

Date: 3.AUG.2010 14:51:35

Plot 2: Middle channel

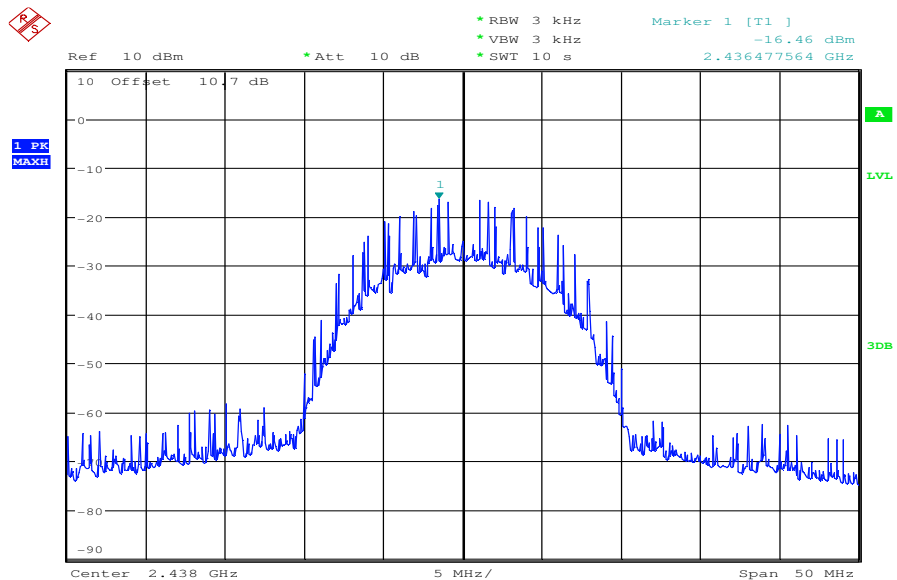

Date: 3.AUG.2010 14:53:00

Plot 3: High channel

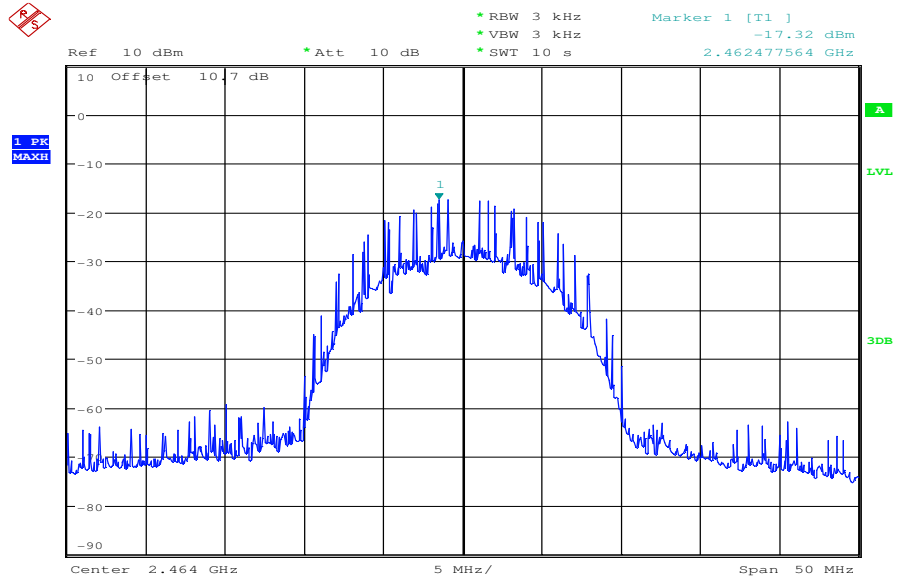

Date: 3.AUG.2010 14:55:07

9.3 Spectrum Bandwidth of a DSSS System – 6 dB Bandwidth

Description:

Measurement of the 6 dB bandwidth of the modulated signal.

Measurement:

Measurement parameter	
Detector:	Peak
Sweep time:	Auto
Video bandwidth:	10 kHz
Resolution bandwidth:	10 kHz
Span:	50 MHz
Trace-Mode:	Max Hold

Limits:

FCC	IC
CFR Part 15.247 (a)(2)	RSS 210, Issue 7, A 8.2(a)
Spectrum Bandwidth of a DSSS System – 6 dB Bandwidth	
Systems using digital modulation techniques may operate in the 2400–2483.5 MHz band. The minimum 6 dB bandwidth shall be at least 500 kHz.	

Result:

Modulation Frequency	6 dB BANDWIDTH [MHz]		
	2412 MHz	2438 MHz	2464 MHz
BPSK	8.01	8.01	7.85
Measurement uncertainty	± 100 kHz		

Result: The result of the measurement is passed.

Plot 1: Low channel

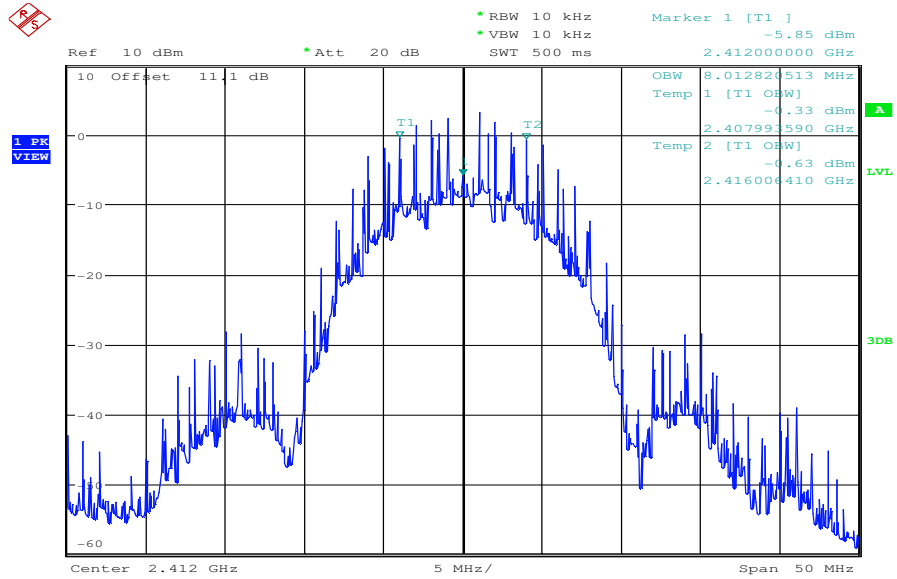

Date: 29.JUL.2010 15:26:56

Plot 2: Middle channel

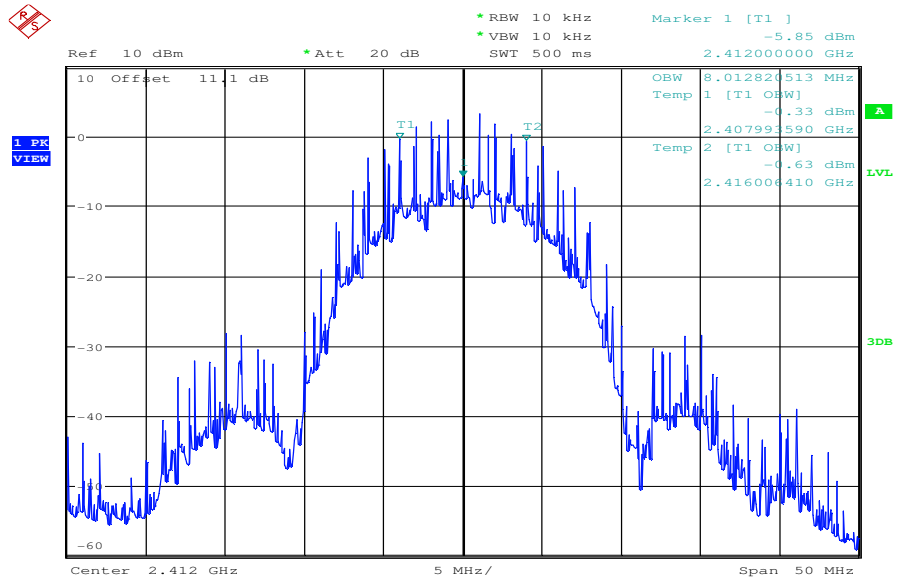

Date: 29.JUL.2010 15:26:56

Plot 3: High channel

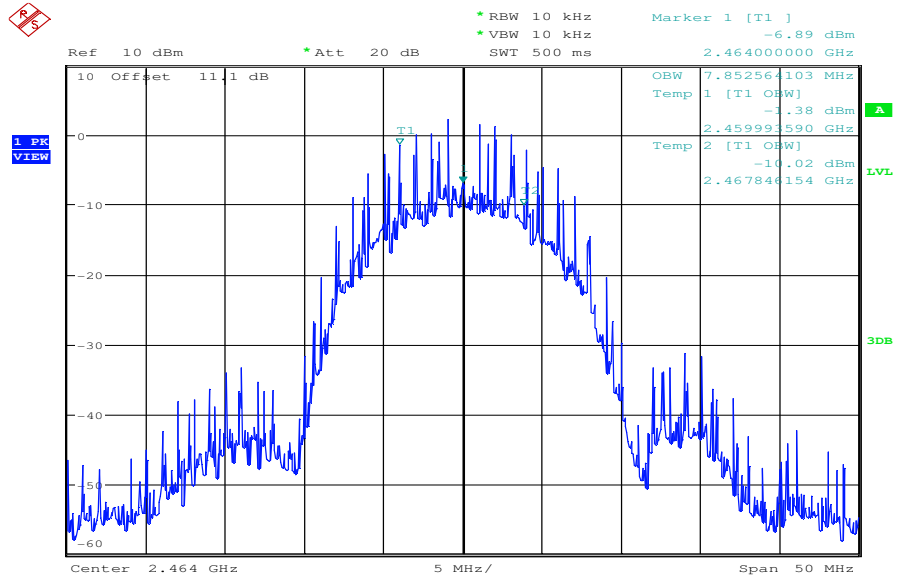

Date: 29.JUL.2010 15:28:17

9.4 Spectrum Bandwidth of a DSSS System – 20 dB Bandwidth

Description:

Measurement of the 20 dB bandwidth of the modulated signal.

Measurement:

Measurement parameter	
Detector:	Peak
Sweep time:	Auto
Video bandwidth:	10 kHz
Resolution bandwidth:	10 kHz
Span:	50 MHz
Trace-Mode:	Max Hold

Limits:

FCC	IC
CFR Part 15.247 (a)(2)	RSS 210, Issue 7, A 8.2(a)
Spectrum Bandwidth of a DSSS System – 20 dB Bandwidth	
Systems using digital modulation techniques may operate in the 2400–2483.5 MHz band. The minimum 6 dB bandwidth shall be at least 500 kHz.	

Result:

Modulation	20 dB BANDWIDTH [MHz]		
	2412 MHz	2438 MHz	2464 MHz
Frequency			
BPSK	15.79	15.54	15.63
Measurement uncertainty	± 100 kHz		

Result: The result of the measurement is passed.

Plot 1: Low channel

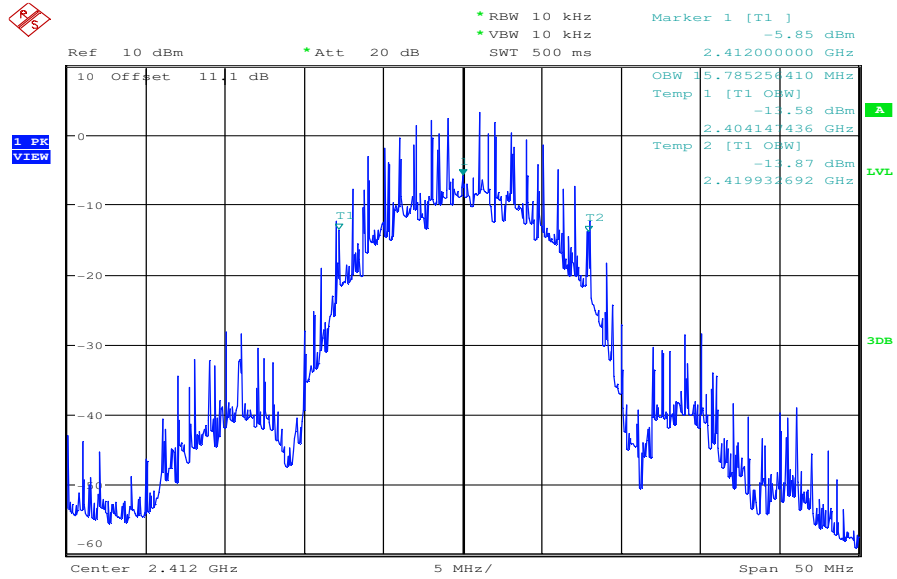

Date: 29.JUL.2010 15:26:30

Plot 2: Middle channel

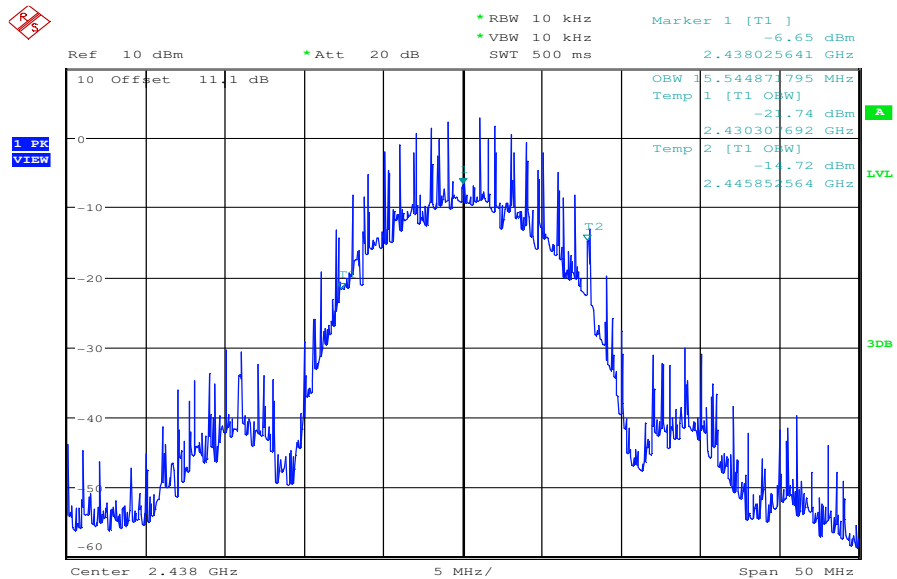

Date: 29.JUL.2010 15:25:25

Plot 3: High channel

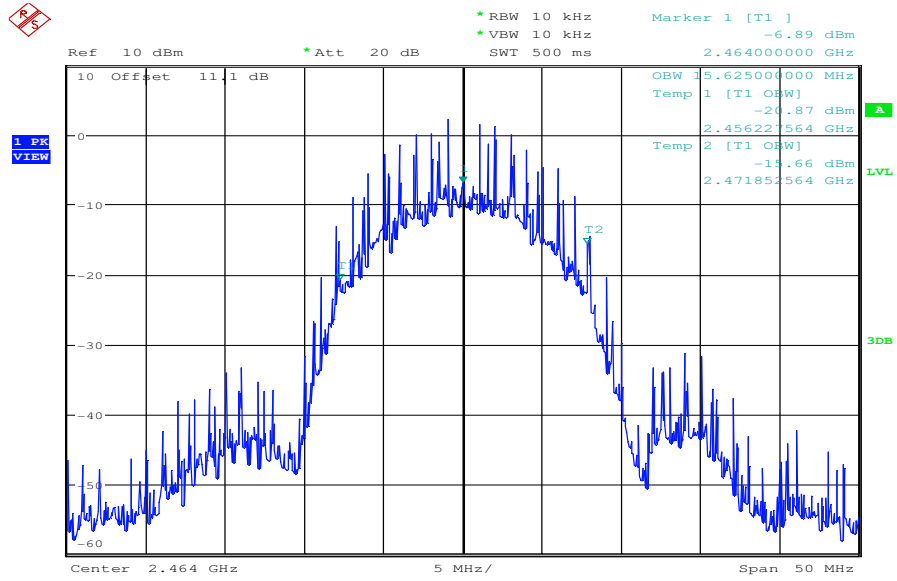

Date: 29.JUL.2010 15:28:41

9.5 Maximum Output Power

Description:

Measurement of the maximum output power conducted and radiated. The measurements are performed using normal use modulation the highest conducted output power.

Measurement:

Measurement parameter	
Detector:	Peak
Sweep time:	Auto
Video bandwidth:	30 MHz
Resolution bandwidth:	50 MHz
Span:	30 MHz
Trace-Mode:	Max Hold

Limits:

FCC	IC
CFR Part 15.247 (b)(3)	RSS 210, Issue 7, A 8.4(4)
Maximum Output Power	
Conducted: 1.0 W – Antenna Gain max. 6 dBi	

Result:

BPSK Frequency	Maximum Output Power [dBm]		
	2412 MHz	2438 MHz	2464 MHz
Peak Output Power Conducted	20.3	20.0	19.5
Output Power Radiated – EIRP calculated with antenna gain	12.7	12.0	10.9
Measurement uncertainty	± 0.5 dB (cond.) / ± 2 dB (rad.)		

Result: The result of the measurement is passed.

Plot 1: Low channel

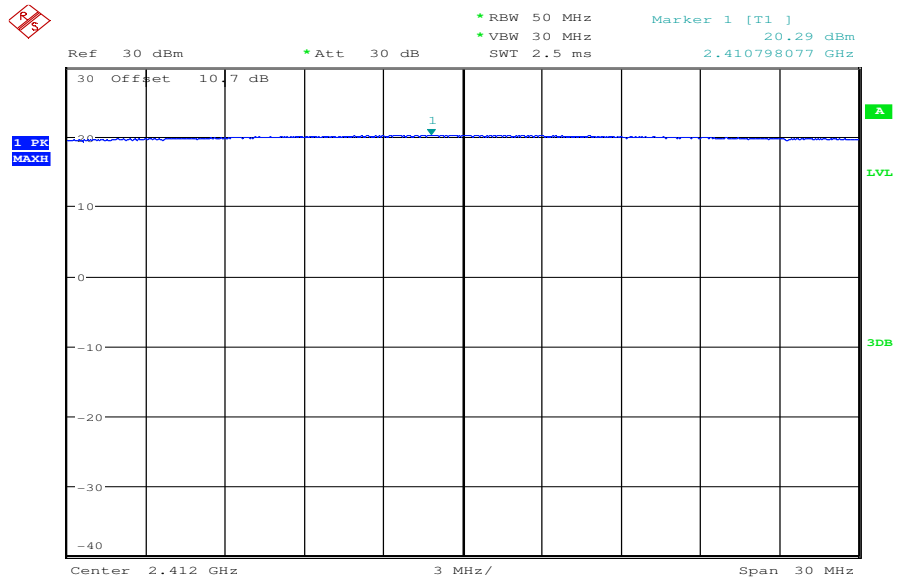

Date: 2.AUG.2010 15:08:46

Plot 2: Middle channel

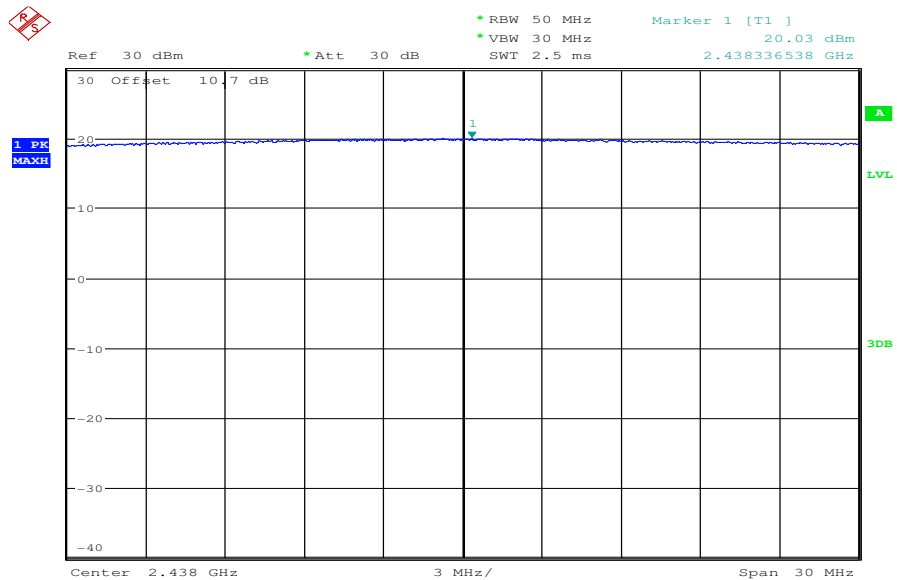

Date: 2.AUG.2010 15:09:12

Plot 3: High channel

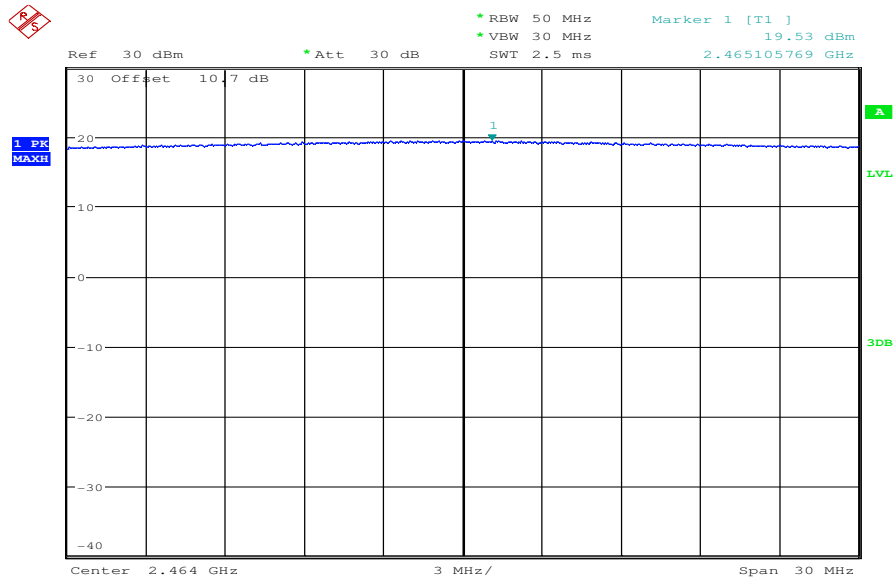

Date: 2.AUG.2010 15:09:42

9.6 Band Edge Compliance Conducted

Description:

Measurement of the conducted band edge compliance. EUT is measured at the lower and upper band edge.

Measurement:

Measurement parameter	
Detector:	Peak
Sweep time:	Auto
Video bandwidth:	100 kHz
Resolution bandwidth:	100 kHz
Span:	Lower Band Edge: 2300 – 2425 MHz Upper Band Edge: 2450 – 2525 MHz
Trace-Mode:	Max Hold

Limits:

FCC	IC
CFR Part 15.247 (d)	RSS 210, Issue 7, A 8.5
Band Edge Compliance Conducted	
<p>In any 100 kHz bandwidth outside the frequency band in which the spread spectrum or digitally modulated intentional radiator is operating, the radio frequency power that is produced by the intentional radiator shall be at least 20 dB below that in the 100 kHz bandwidth within the band that contains the highest level of the desired power, based on either an RF conducted or a radiated measurement. Attenuation below the general limits specified in Section 15.209(a) is not required.</p>	

Result:

Scenario	Band Edge Compliance Conducted [dB]	
	BPSK	-/-
Modulation		
Lower Band Edge – Channel LOW	> 20 dB (see plot 1)	
Upper Band Edge – Channel HIGH	> 20 dB (see plot 2)	
Measurement uncertainty	± 1.5 dB	

Result: The result of the measurement is passed.

Plot 1: Lower Band Edge

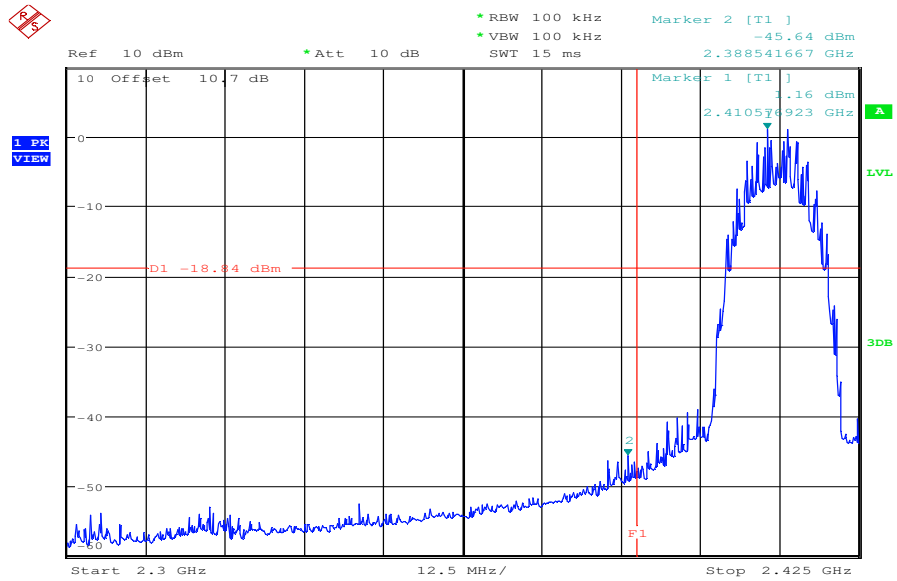

Date: 3.AUG.2010 15:02:51

Plot 2: Upper Band Edge

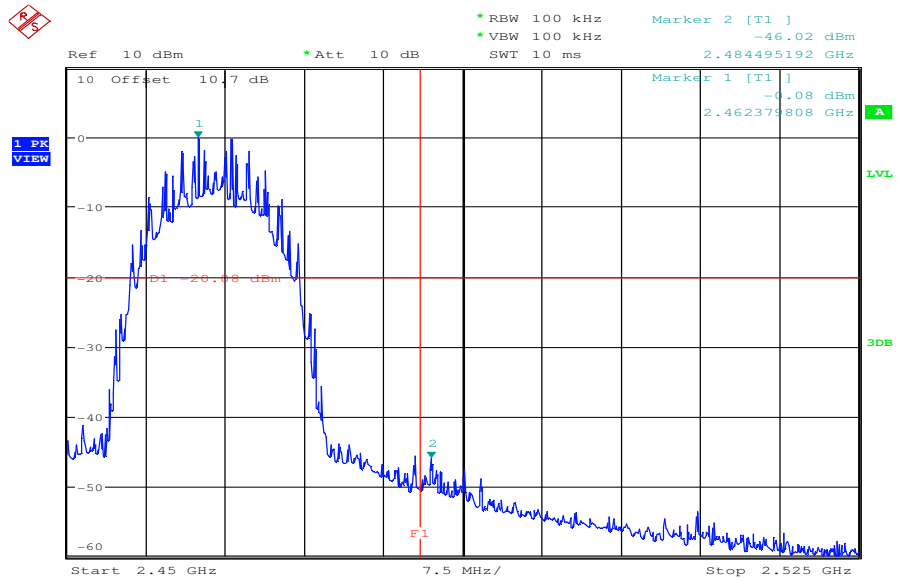

Date: 3.AUG.2010 15:06:18

9.7 Band Edge Compliance Radiated

Description:

Measurement of the radiated band edge compliance. The EUT is turned in the position that results in the maximum level at the band edge. Then a sweep over the corresponding restricted band is performed. The EUT is set to lowest channel for the lower restricted band and to highest channel for the upper restricted band. The measurement is repeated for all modulations. Measurement distance is 3m.

Measurement:

Measurement parameter	
Detector:	Peak
Sweep time:	Auto
Video bandwidth:	10 Hz
Resolution bandwidth:	1 MHz
Span:	Lower Band: 2300 – 2400 MHz higher Band: 2480 – 2500 MHz
Trace-Mode:	Max Hold

Limits:

FCC	IC
CFR Part 15.205	RSS 210, Issue 7, A 8.5
Band Edge Compliance Radiated	
<p>In any 100 kHz bandwidth outside the frequency band in which the spread spectrum or digitally modulated intentional radiator is operating, the radio frequency power that is produced by the intentional radiator shall be at least 20 dB below that in the 100 kHz bandwidth within the band that contains the highest level of the desired power, based on either an RF conducted or a radiated measurement. Attenuation below the general limits specified in Section 15.209(a) is not required. In addition, radiated emissions which fall in the restricted bands, as defined in Section 15.205(a), must also comply with the radiated emission limits specified in Section 15.209(a) (see Section 5.205(c)).</p>	
54 dB μ V/m AVG	

Result:

Scenario	Band Edge Compliance Radiated [dB μ V/m]	
	BPSK	-/-
Modulation		
Lower Band Edge – Channel LOW	< 54 dB μ V/m (see plot 1)	
Upper Band Edge – Channel HIGH	< 54 dB μ V/m (see plot 2)	
Measurement uncertainty	\pm 3 dB	

Result: The result of the measurement is passed.

Plot 1: Lower Band Edge

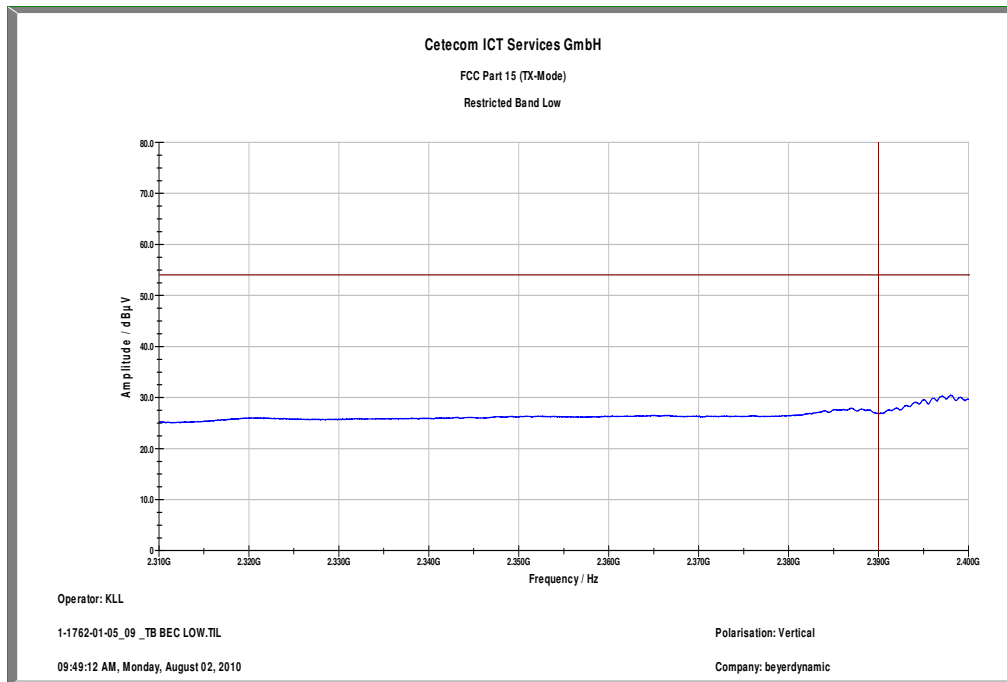

Plot 2: Upper Band Edge

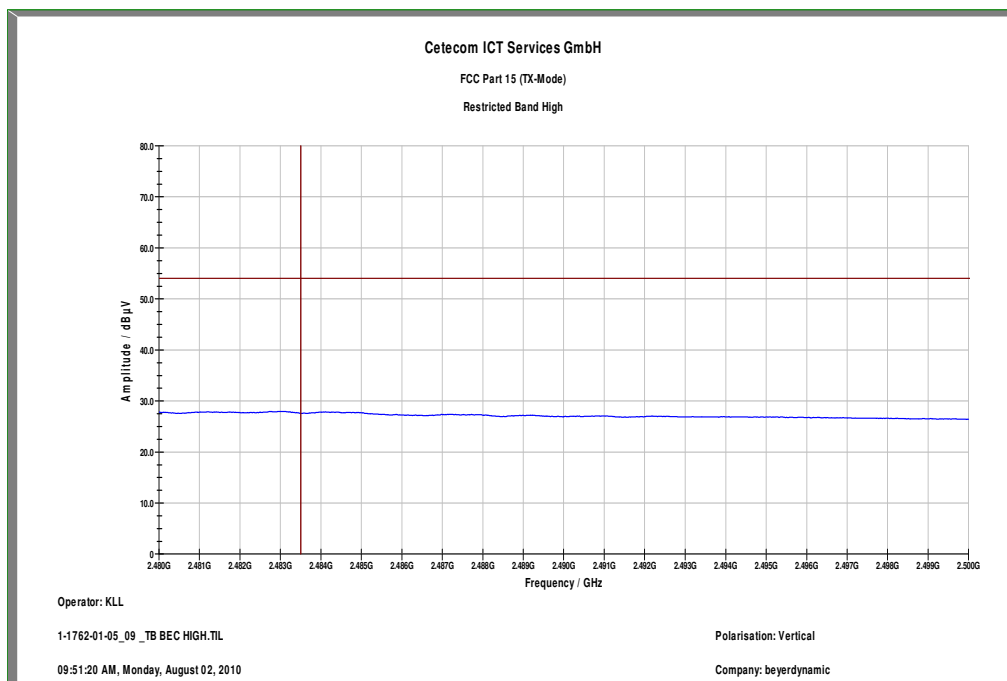

9.8 TX Spurious Emissions Conducted

Description:

Measurement of the conducted spurious emissions in transmit mode. The measurement is performed at low, mid and high channel.

Measurement:

Measurement parameter	
Detector:	Peak
Sweep time:	Auto
Video bandwidth:	F < 1 GHz: 100 kHz F > 1 GHz: 1 MHz
Resolution bandwidth:	F < 1 GHz: 100 kHz F > 1 GHz: 1 MHz
Span:	9 kHz to 25 GHz
Trace-Mode:	Max Hold

Limits:

FCC	IC
CFR Part 15.247(d)	RSS 210, Issue 7, A 8.5
TX Spurious Emissions Conducted	
In any 100 kHz bandwidth outside the frequency band in which the spread spectrum or digitally modulated intentional radiator is operating, the radio frequency power that is produced by the intentional radiator shall be at least 20 dB below that in the 100 kHz bandwidth within the band that contains the highest level of the desired power, based on either an RF conducted or a radiated measurement. Attenuation below the general limits specified in Section 15.209(a) is not required	

Result: Also see plots

TX Spurious Emissions Conducted					
BPSK					
f [MHz]		amplitude of emission [dBm]	limit max. allowed emission power	actual attenuation below frequency of operation [dB]	results
2412		0.8	30 dBm		Operating frequency
<i>No critical peaks detected</i>			-20 dBc		complies
2438		0.4	30 dBm		Operating frequency
<i>No critical peaks detected</i>			-20 dBc		complies
2464		0.1	30 dBm		Operating frequency
<i>No critical peaks detected</i>			-20 dBc		complies
Measurement uncertainty		± 3 dB			

Result: The result of the measurement is passed.

Plot 1: Low channel, 9kHz – 1GHz

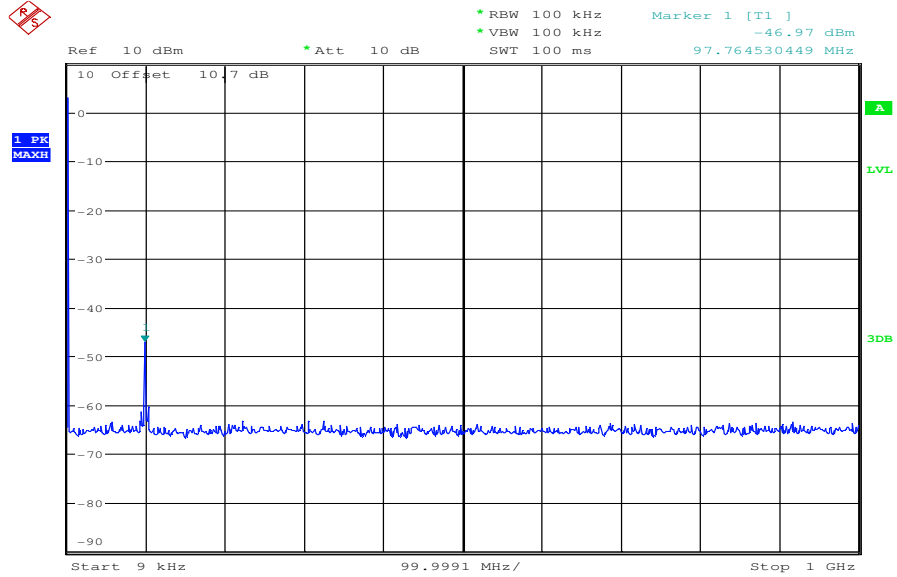

Date: 3.AUG.2010 15:10:21

The peak at the beginning of the plot is the LO from the SA

Plot 2: Low channel, 1GHz – 6GHz

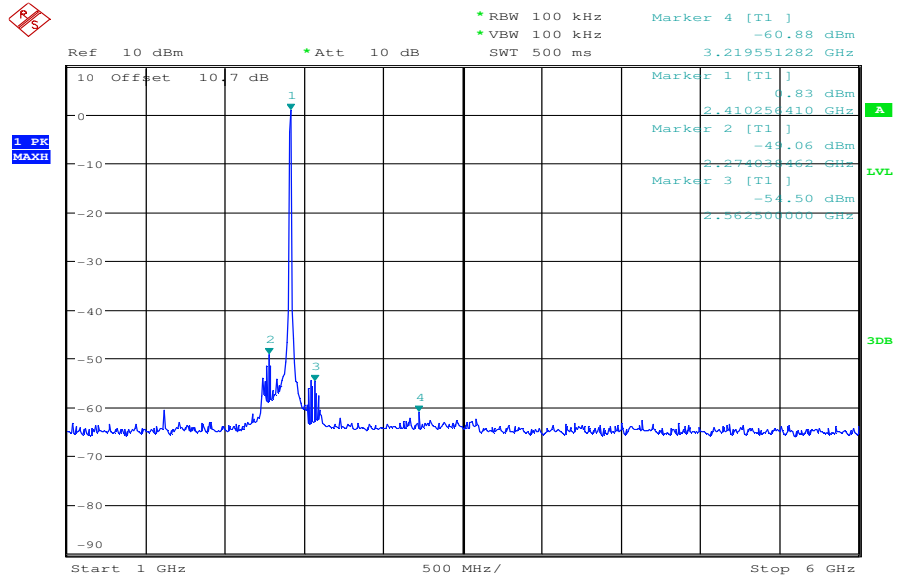

Date: 3.AUG.2010 15:15:01

Plot 3: Low channel, 6GHz – 14GHz

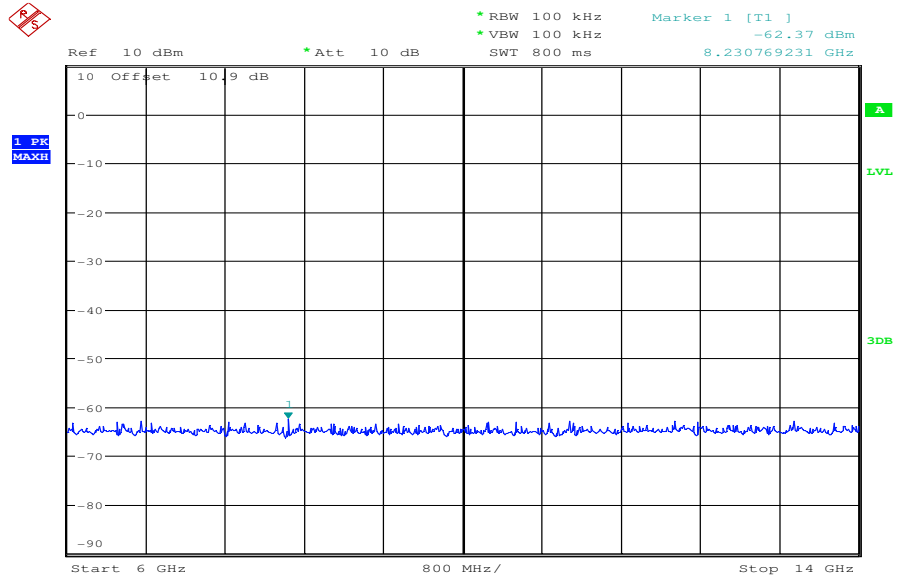

Date: 3.AUG.2010 15:21:28

Plot 4: Low channel, 14GHz – 25GHz

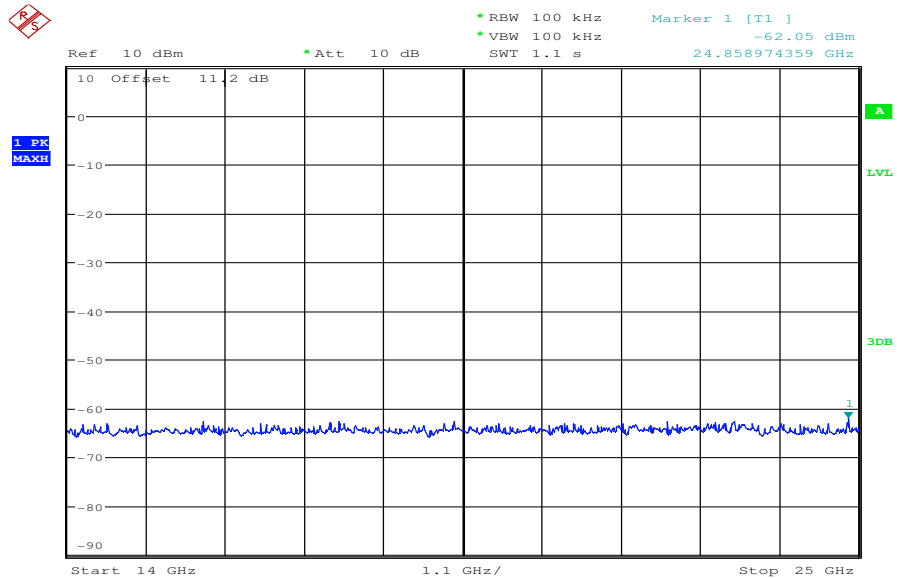

Date: 3.AUG.2010 15:23:32

Plot 5: Middle channel, 9kHz – 1GHz

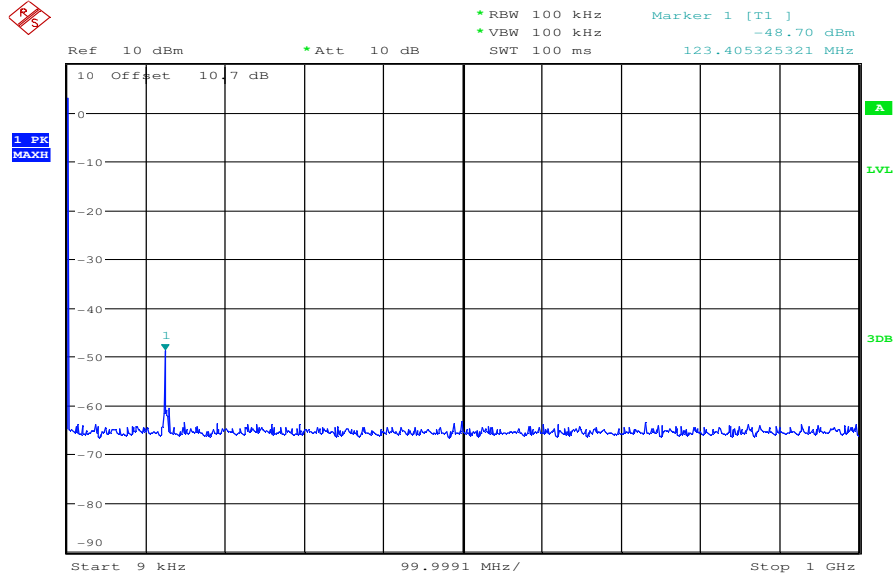

Date: 3.AUG.2010 15:10:53

The peak at the beginning of the plot is the LO from the SA

Plot 6: Middle channel, 1GHz – 6GHz

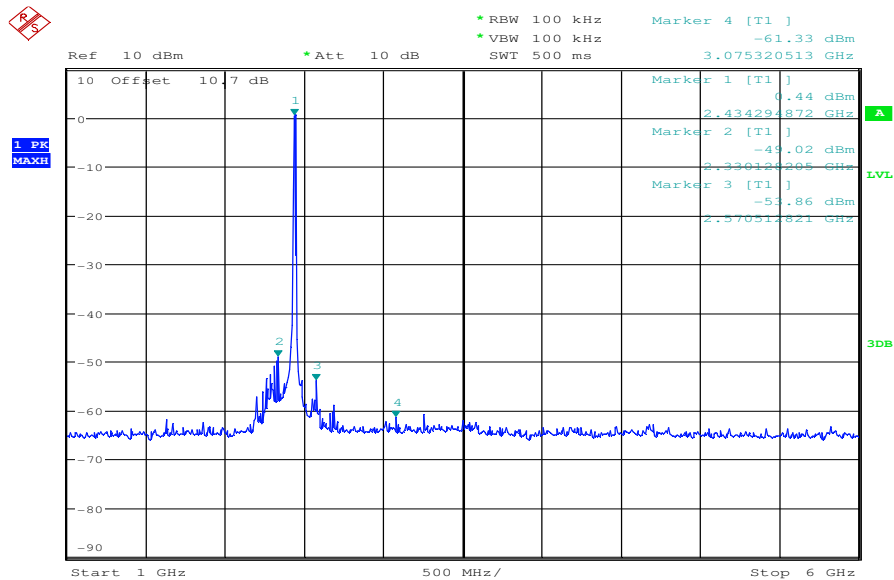

Date: 3.AUG.2010 15:16:22

Plot 7: Middle channel, 6GHz – 14GHz

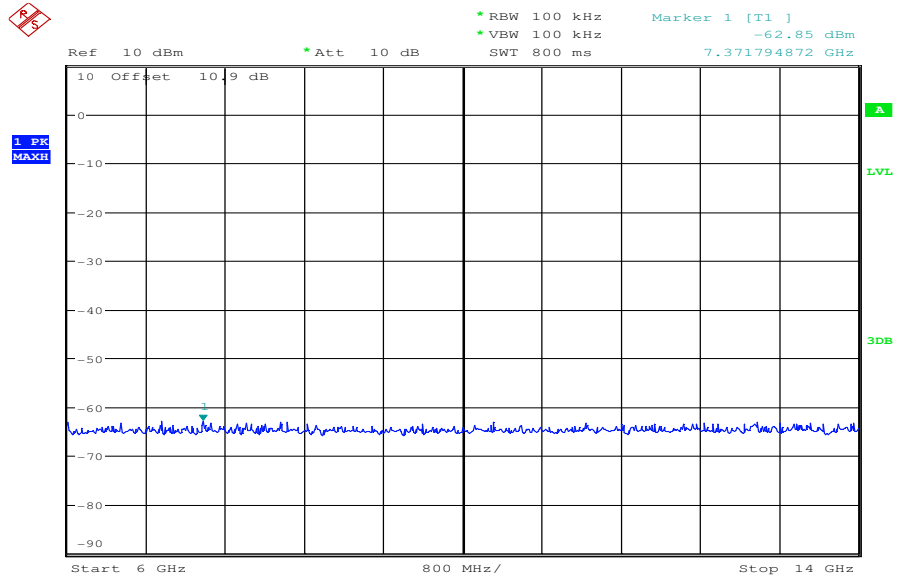

Date: 3.AUG.2010 15:19:00

Plot 8: Middle channel, 14GHz – 25GHz

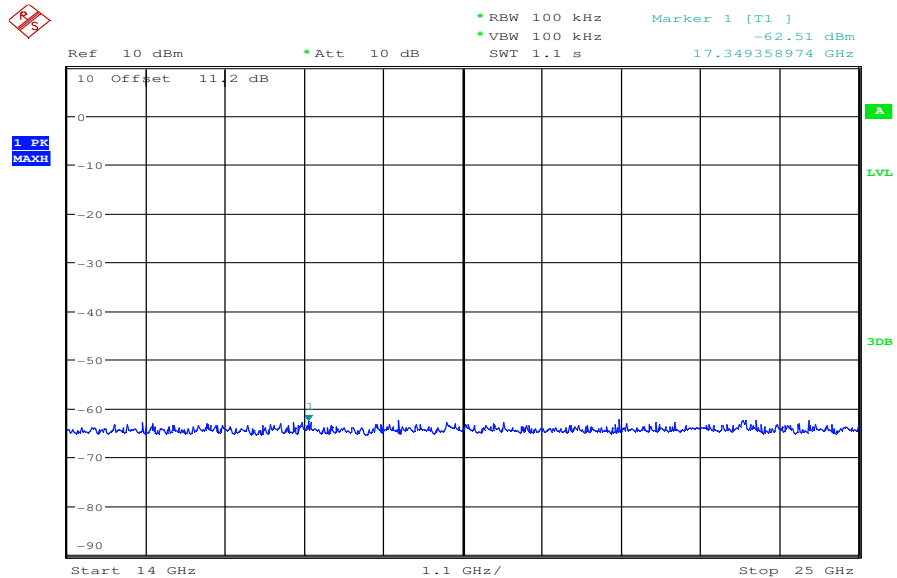

Date: 3.AUG.2010 15:24:38

Plot 9: High channel, 9kHz – 1GHz

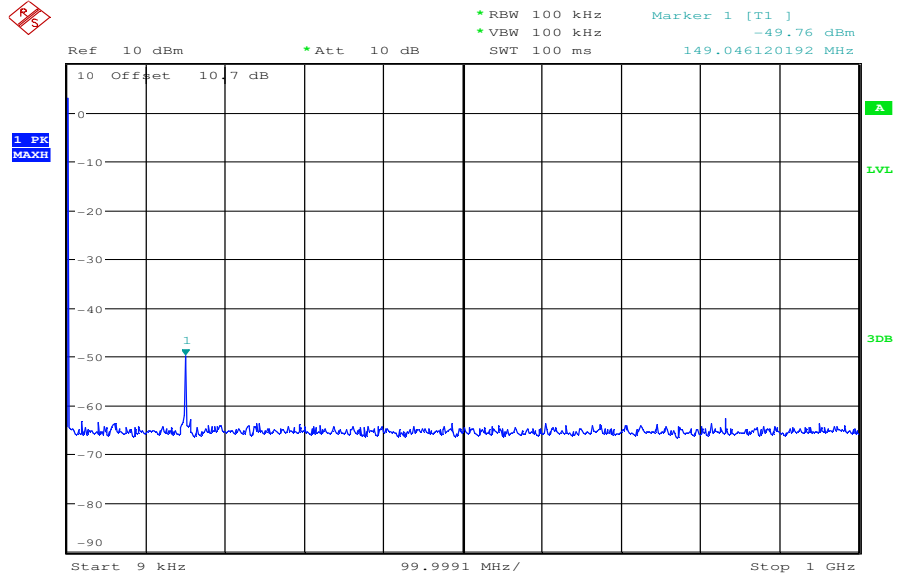

Date: 3.AUG.2010 15:11:34

The peak at the beginning of the plot is the LO from the SA

Plot 10: High channel, 1GHz – 6GHz

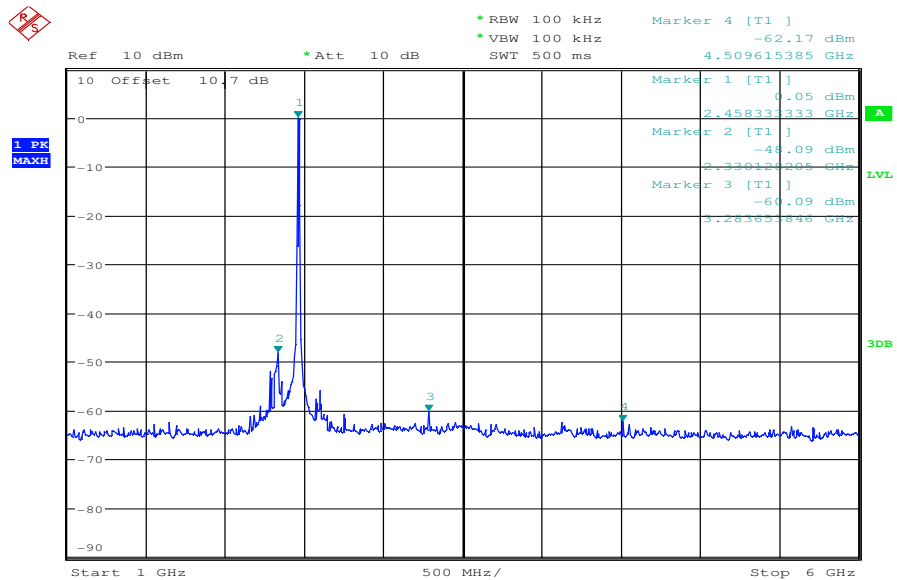

Date: 3.AUG.2010 15:13:43

Plot 11: High channel, 6GHz – 14GHz

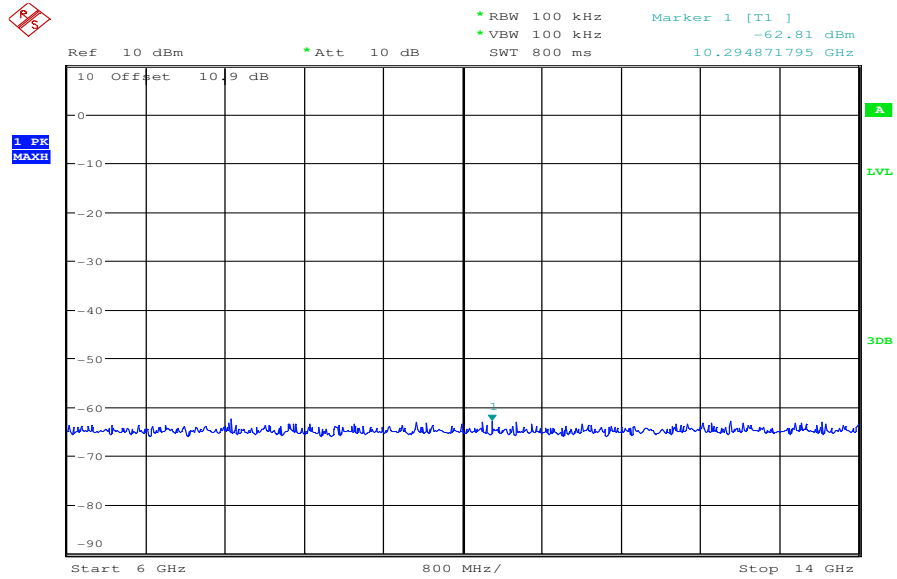

Date: 3.AUG.2010 15:19:56

Plot 12: High channel, 14GHz – 25GHz

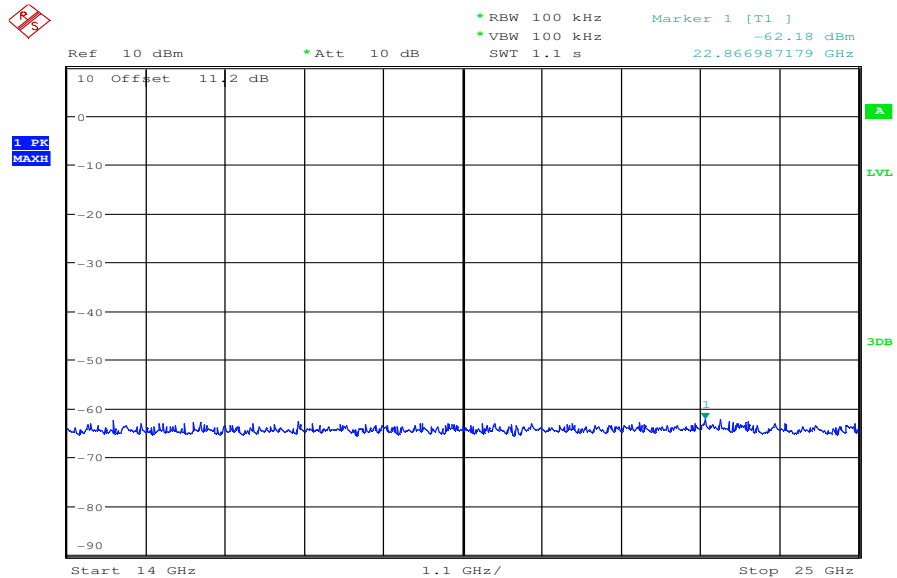

Date: 3.AUG.2010 15:25:45

9.9 TX Spurious Emissions Radiated

Description:

Measurement of the conducted spurious emissions in transmit mode. The measurement is performed at low, mid and high channel.

Measurement:

Measurement parameter	
Detector:	Peak / Quasi Peak
Sweep time:	Auto
Video bandwidth:	Sweep: 100 kHz Re-measurement: 10 Hz
Resolution bandwidth:	F < 1 GHz: 100 kHz F > 1 GHz: 1 MHz
Span:	30 MHz to 25 GHz
Trace-Mode:	Max Hold
Measured Modulation	<input checked="" type="checkbox"/> BPSK <input type="checkbox"/> OFDM

The modulation with the highest output power was used to perform the transmitter spurious emissions. If spurious were detected a re-measurement was performed on the detected frequency with each modulation.

Limits:

FCC		IC	
CFR Part 15.247(d)		RSS 210, Issue 7, A 8.5	
TX Spurious Emissions Radiated			
In any 100 kHz bandwidth outside the frequency band in which the spread spectrum or digitally modulated intentional radiator is operating, the radio frequency power that is produced by the intentional radiator shall be at least 20 dB below that in the 100 kHz bandwidth within the band that contains the highest level of the desired power, based on either an RF conducted or a radiated measurement. Attenuation below the general limits specified in Section 15.209(a) is not required. In addition, radiated emissions which fall in the restricted bands, as defined in §15.205(a), must also comply with the radiated emission limits specified in §15.209(a) (see §15.205(c)).			
§15.209			
Frequency (MHz)	Field Strength (dBµV/m)	Measurement distance	
30 - 88	30.0	10	
88 - 216	33.5	10	
216 - 960	36.0	10	
Above 960	54.0	3	

Sample # 0000-0027

Result: Also see plots

TX Spurious Emissions Radiated [dBμV/m]								
BPSK								
2412 MHz			2438 MHz			2464 MHz		
F [MHz]	Detector	Level [dBμV/m]	F [MHz]	Detector	Level [dBμV/m]	F [MHz]	Detector	Level [dBμV/m]
4824	PK	35.1	3250.7	PK	31.6	4928	PK	36.1
			4876.0	PK	36.1			
			6501.5	PK	39.8			
Measurement uncertainty			± 3 dB					

Result: The result of the measurement is passed.

Plot 1: 30 MHz to 1 GHz / Low channel, antenna

EUT: Stegos TB
 Serial Number: 0000-0027
 Test Description: FCC part 15 Class B @ 10 m
 Operating Conditions: cont. TX; low band
 Operator Name: HMN
 Comment: AC: 115 V / 60 Hz

Scan Setup: STAN_Fin [EMI radiated]

Hardware Setup: Electric Field (NOS)
 Level Unit: dBµV/m

Subrange	Detectors	IF Bandwidth	Meas. Time	Receiver
30 MHz - 1,05 GHz	QuasiPeak	120 kHz	15 s	Receiver

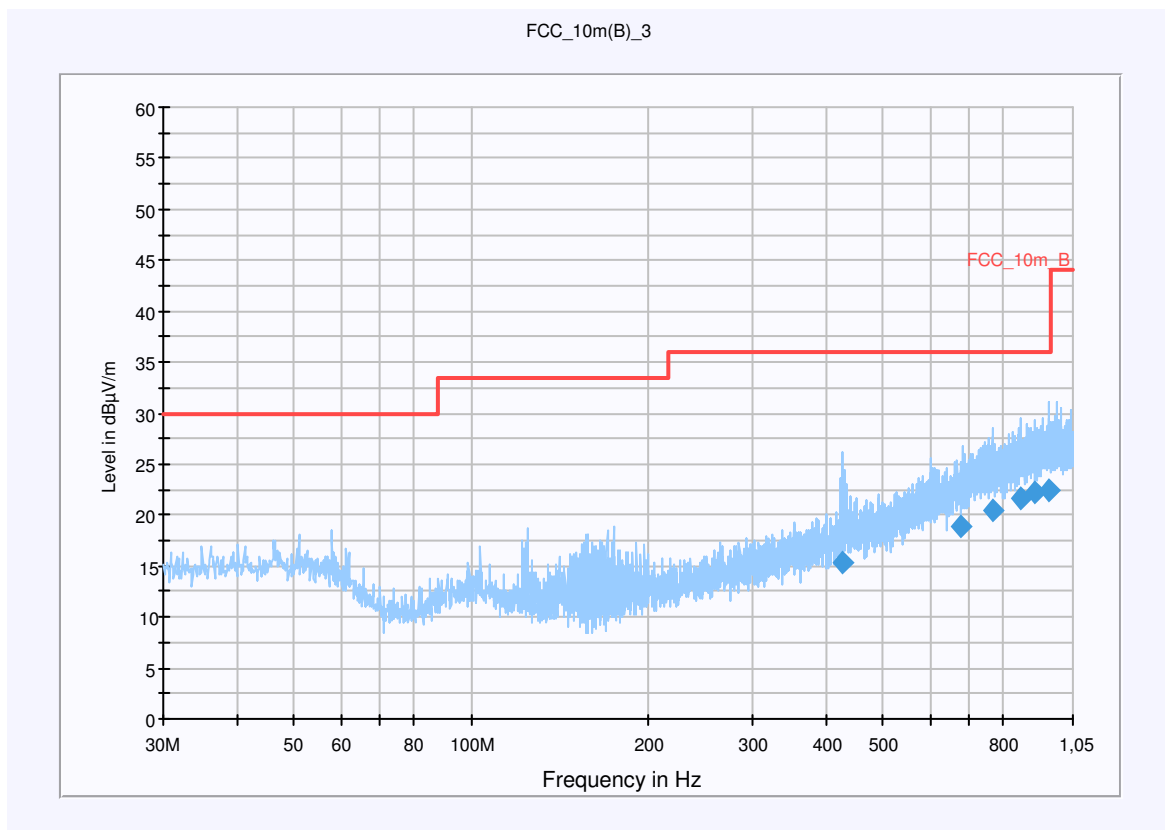

Final Result 1

Frequency (MHz)	QuasiPeak (dBµV/m)	Meas. Time (ms)	Bandwidth (kHz)	Antenna height (cm)	Polarity	Turntable position (deg)	Corr. (dB)	Margin (dB)	Limit (dBµV/m)	Comment
426.289650	15.3	15000.000	120.000	98.0	V	8.0	17.3	20.7	36.0	
679.565700	18.8	15000.000	120.000	220.0	V	291.0	21.9	17.2	36.0	
766.519950	20.5	15000.000	120.000	220.0	V	276.0	23.7	15.5	36.0	
859.449750	21.6	15000.000	120.000	104.0	H	193.0	24.7	14.4	36.0	
903.533850	22.2	15000.000	120.000	212.0	V	266.0	25.2	13.8	36.0	
958.052550	22.5	15000.000	120.000	220.0	H	18.0	25.4	13.5	36.0	

Hardware Setup: EMI radiated\Electric Field (NOS) - [EMI radiated]

Subrange 1

Frequency Range: 30 MHz - 2 GHz

Receiver: Receiver [ESCI 3]
@ GPIB0 (ADR 20), SN 100083/003, FW 4.32

Signal Path: without Notch
FW 1.0

Antenna: VULB 9163
SN 9163-295, FW ---
Correction Table (vertical): VULP6113
Correction Table (horizontal): VULP6113
Correction Table: Cable_EN_1GHz (1005)

Antenna Tower: Tower [EMCO 2090 Antenna Tower]
@ GPIB0 (ADR 8), FW REV 3.12

Turntable: Turntable [EMCO Turntable]
@ GPIB0 (ADR 9), FW REV 3.12

EMC 32 Version 8.10.00

Plot 2: 1 GHz to 12.75 GHz / Low channel, antenna vertical

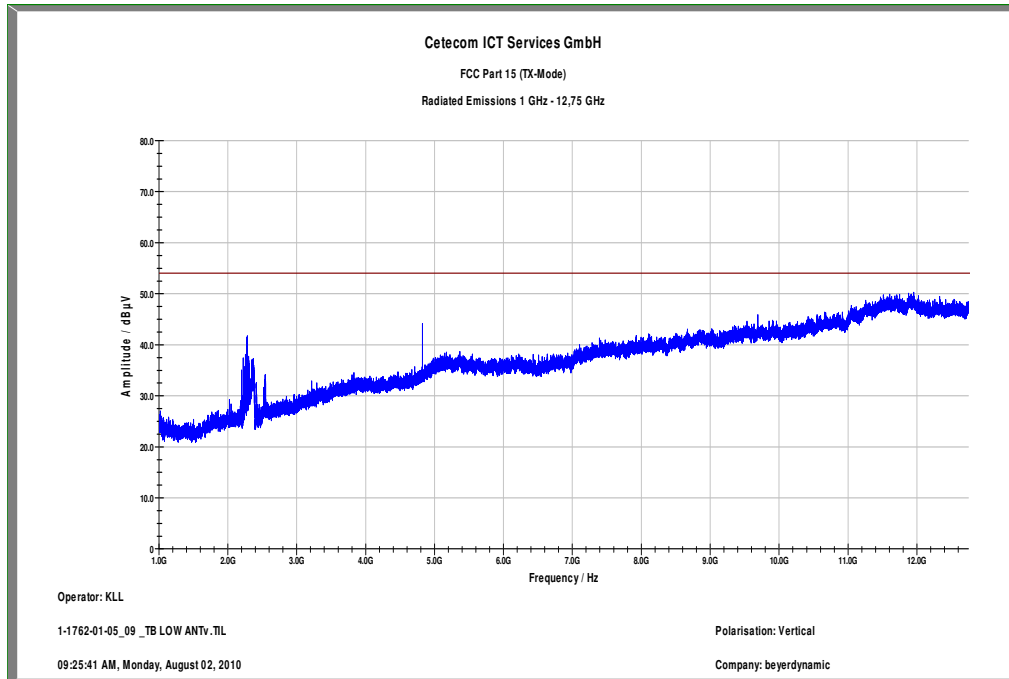

Carrier suppressed with a 2.4 GHz-band rejection filter.

Plot 3: 1 GHz to 12.75 GHz / Low channel, antenna horizontal

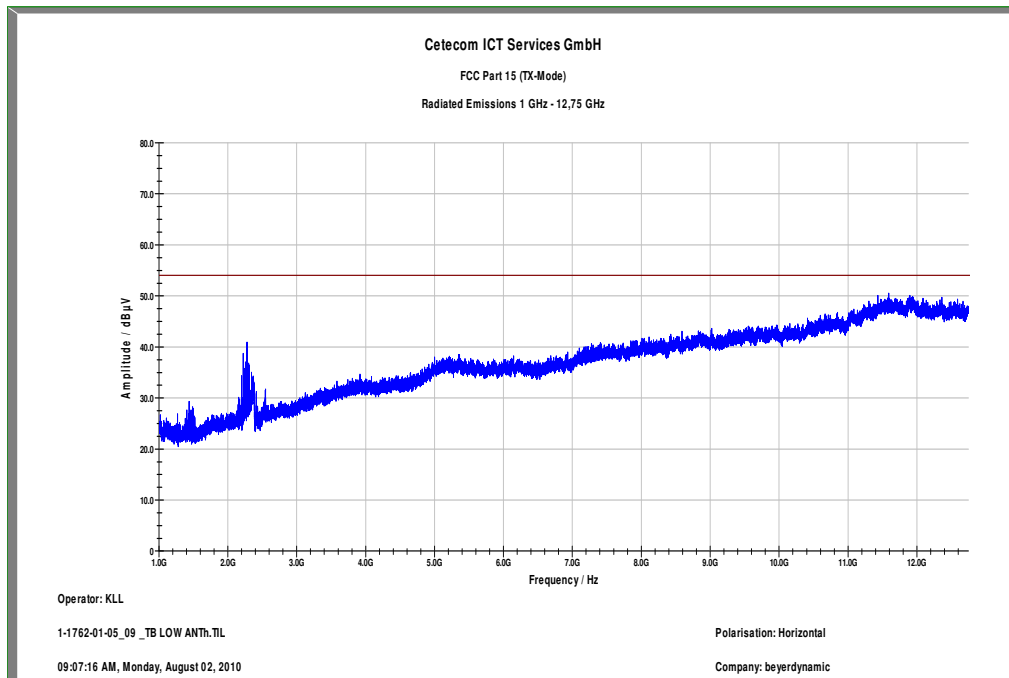

Carrier suppressed with a 2.4 GHz-band rejection filter.

Plot 4: 12 GHz to 26 GHz / Low channel (horizontal/vertical) – valid for all channels

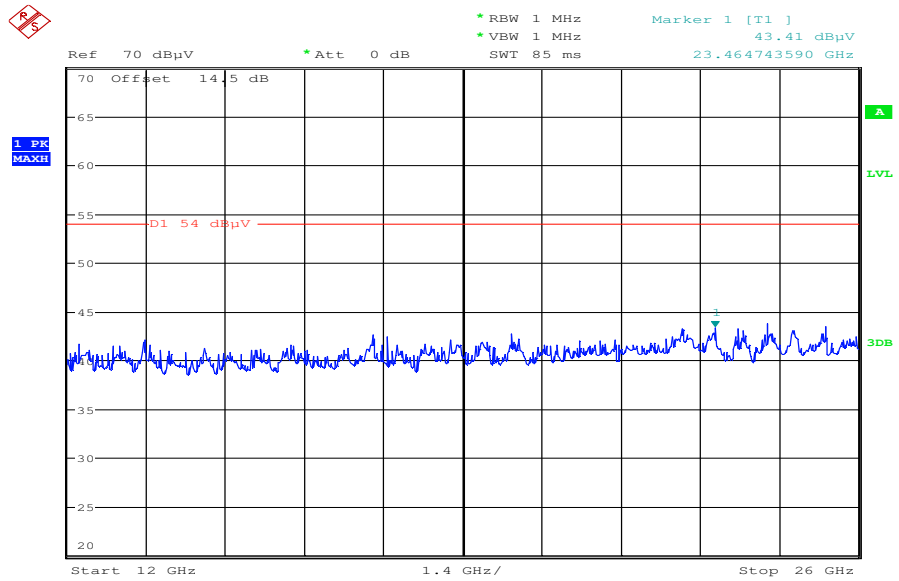

Date: 3.AUG.2010 09:20:13

Plot 5: 30 MHz to 1 GHz / Middle channel

EUT: Stegos TB
 Serial Number: 0000-0027
 Test Description: FCC part 15 Class B @ 10 m
 Operating Conditions: cont. TX; mid band
 Operator Name: HMN
 Comment: AC: 115 V / 60 Hz

Scan Setup: STAN_Fin [EMI radiated]

Hardware Setup: Electric Field (NOS)
 Level Unit: dBµV/m

ubrange **Detectors** **IF Bandwidth** **Meas. Time** **Receiver**
 30 MHz - 1,05 GHz QuasiPeak 120 kHz 15 s Receiver

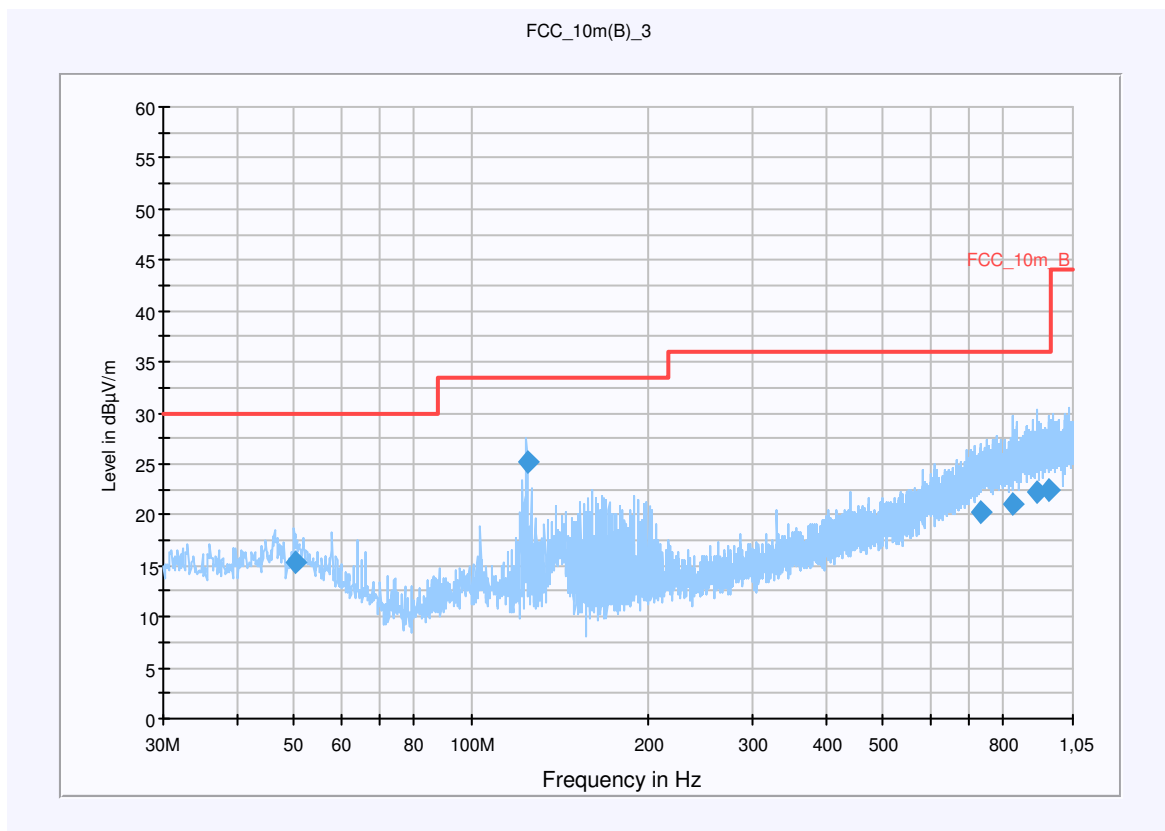

Final Result 1

Frequency (MHz)	QuasiPeak (dBµV/m)	Meas. Time (ms)	Bandwidth (kHz)	Antenna height (cm)	Polarity	Turntable position (deg)	Corr. (dB)	Margin (dB)	Limit (dBµV/m)	Comment
50.121900	15.3	15000.000	120.000	98.0	V	181.0	13.4	14.7	30.0	
124.289550	25.1	15000.000	120.000	98.0	V	107.0	9.9	8.4	33.5	
731.906550	20.2	15000.000	120.000	220.0	H	176.0	23.2	15.8	36.0	
829.825500	21.0	15000.000	120.000	98.0	V	291.0	24.3	15.0	36.0	
911.742150	22.2	15000.000	120.000	159.0	V	99.0	25.2	13.8	36.0	
953.464050	22.4	15000.000	120.000	220.0	V	78.0	25.4	13.6	36.0	

Hardware Setup: EMI radiated\Electric Field (NOS) - [EMI radiated]

Subrange 1

Frequency Range: 30 MHz - 2 GHz

Receiver: Receiver [ESCI 3]
@ GPIB0 (ADR 20), SN 100083/003, FW 4.32

Signal Path: without Notch
FW 1.0

Antenna: VULB 9163
SN 9163-295, FW ---
Correction Table (vertical): VULP6113
Correction Table (horizontal): VULP6113
Correction Table: Cable_EN_1GHz (1005)

Antenna Tower: Tower [EMCO 2090 Antenna Tower]
@ GPIB0 (ADR 8), FW REV 3.12

Turntable: Turntable [EMCO Turntable]
@ GPIB0 (ADR 9), FW REV 3.12

EMC 32 Version 8.10.00

Plot 6: 1 GHz to 12.75 GHz / Middle channel, antenna vertical

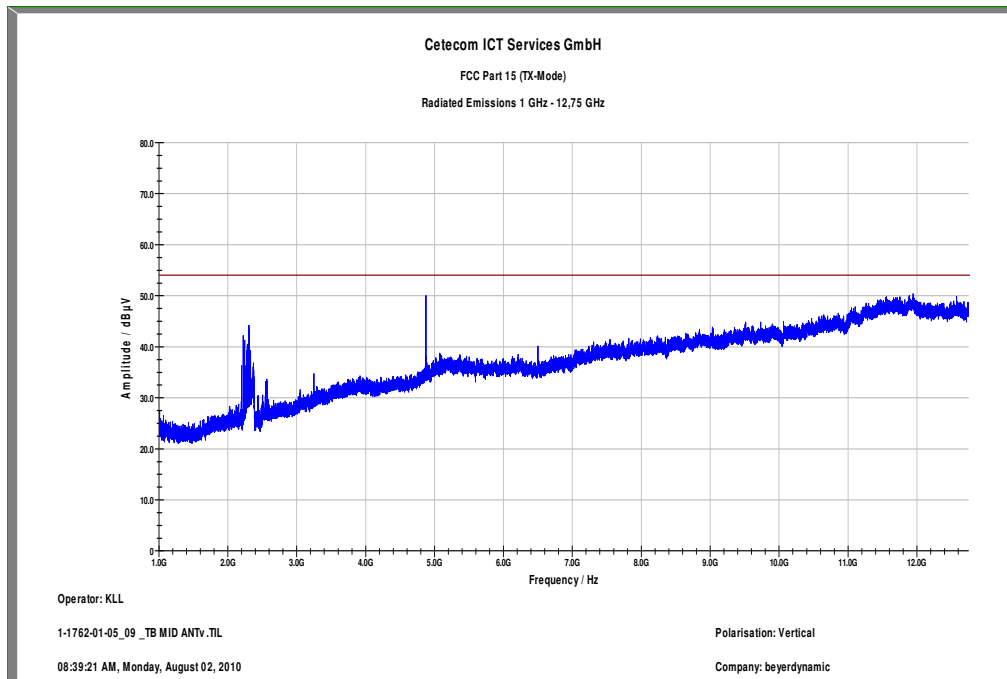

Carrier suppressed with a 2.4 GHz-band rejection filter.

Plot 7: 1 GHz to 12.75 GHz / Middle channel, antenna horizontal

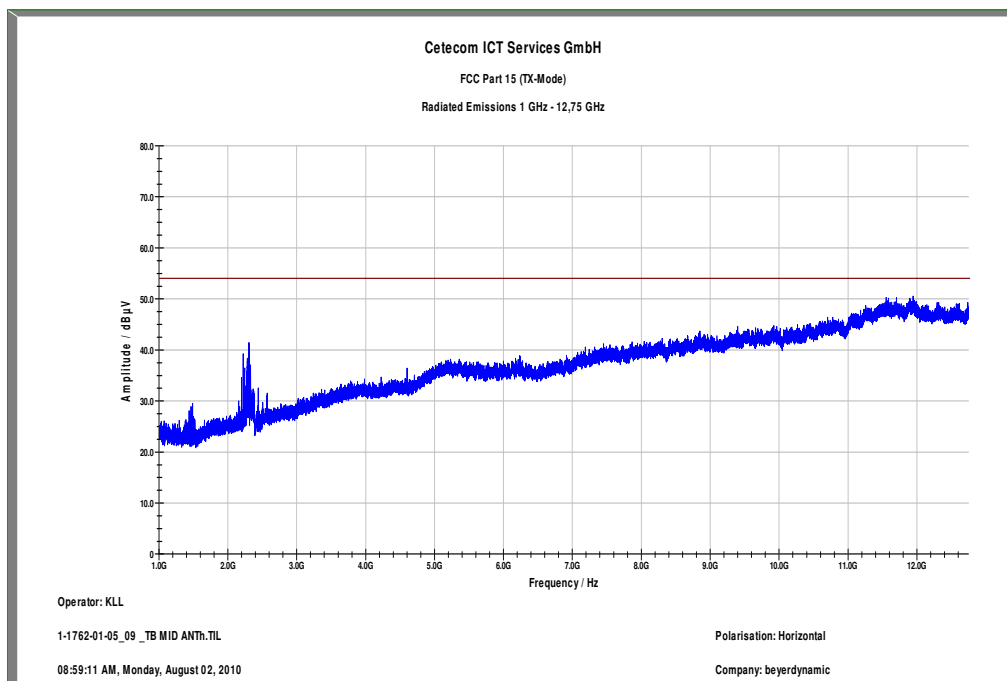

Carrier suppressed with a 2.4 GHz-band rejection filter

Plot 8: 30 MHz to 1 GHz / High channel

EUT: Stegos TB
 Serial Number: 0000-0027
 Test Description: FCC part 15 Class B @ 10 m
 Operating Conditions: cont. TX; high band
 Operator Name: HMN
 Comment: AC: 115 V / 60 Hz

Scan Setup: STAN_Fin [EMI radiated]

Hardware Setup: Electric Field (NOS)
 Level Unit: dBµV/m
Subrange **Detectors** **IF Bandwidth** **Meas. Time** **Receiver**
 30 MHz - 1,05 GHz QuasiPeak 120 kHz 15 s Receiver

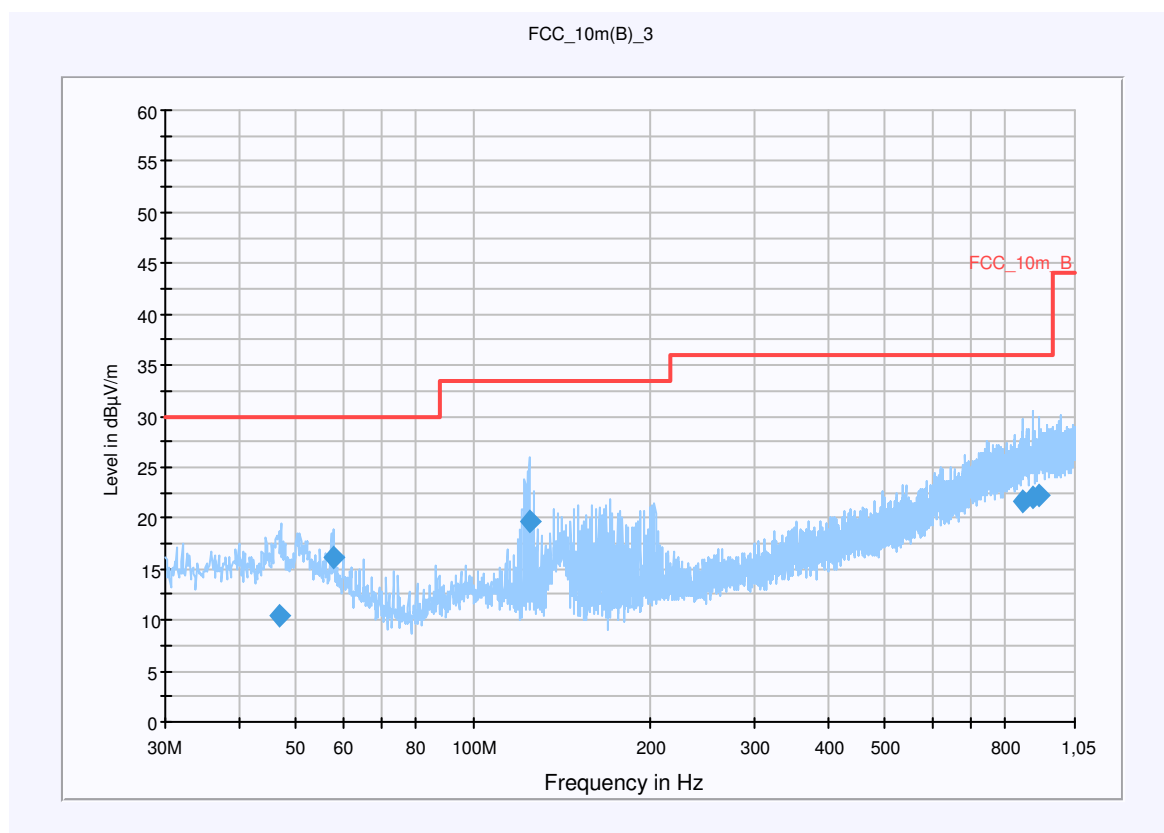

Final Result 1

Frequency (MHz)	QuasiPeak (dBµV/m)	Meas. Time (ms)	Bandwidth (kHz)	Antenna height (cm)	Polarity	Turntable position (deg)	Corr. (dB)	Margin (dB)	Limit (dBµV/m)	Comment
47.048700	10.5	15000.000	120.000	98.0	V	201.0	13.3	19.5	30.0	
57.975600	16.1	15000.000	120.000	98.0	V	110.0	12.1	13.9	30.0	
124.369200	19.6	15000.000	120.000	98.0	V	110.0	9.9	13.9	33.5	
858.938100	21.6	15000.000	120.000	220.0	V	270.0	24.7	14.4	36.0	
889.836900	22.1	15000.000	120.000	220.0	H	266.0	25.1	13.9	36.0	
911.409750	22.2	15000.000	120.000	189.0	H	-1.0	25.2	13.8	36.0	

Hardware Setup: EMI radiated\Electric Field (NOS) - [EMI radiated]

Subrange 1

Frequency Range: 30 MHz - 2 GHz

Receiver: Receiver [ESCI 3]
@ GPIB0 (ADR 20), SN 100083/003, FW 4.32

Signal Path: without Notch
FW 1.0

Antenna: VULB 9163
SN 9163-295, FW ---
Correction Table (vertical): VULP6113
Correction Table (horizontal): VULP6113
Correction Table: Cable_EN_1GHz (1005)

Antenna Tower: Tower [EMCO 2090 Antenna Tower]
@ GPIB0 (ADR 8), FW REV 3.12

Turntable: Turntable [EMCO Turntable]
@ GPIB0 (ADR 9), FW REV 3.12

EMC 32 Version 8.10.00

Plot 9: 1 GHz to 12.75 GHz / High channel, antenna vertical

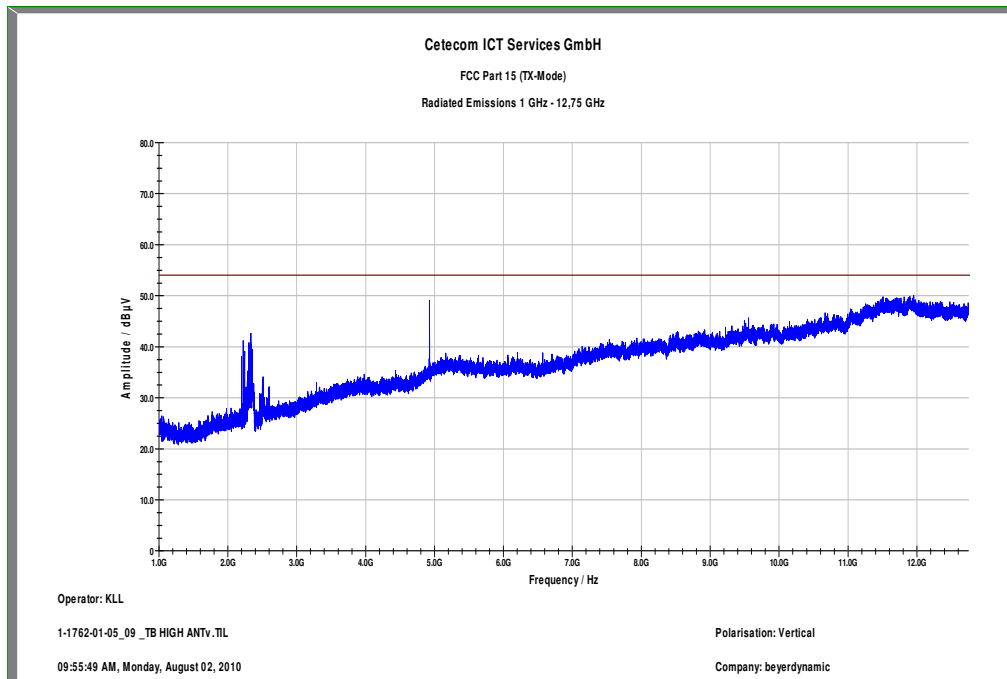

Carrier suppressed with a 2.4 GHz-band rejection filter.

Plot 10: 1 GHz to 12.75 GHz / High channel, antenna horizontal

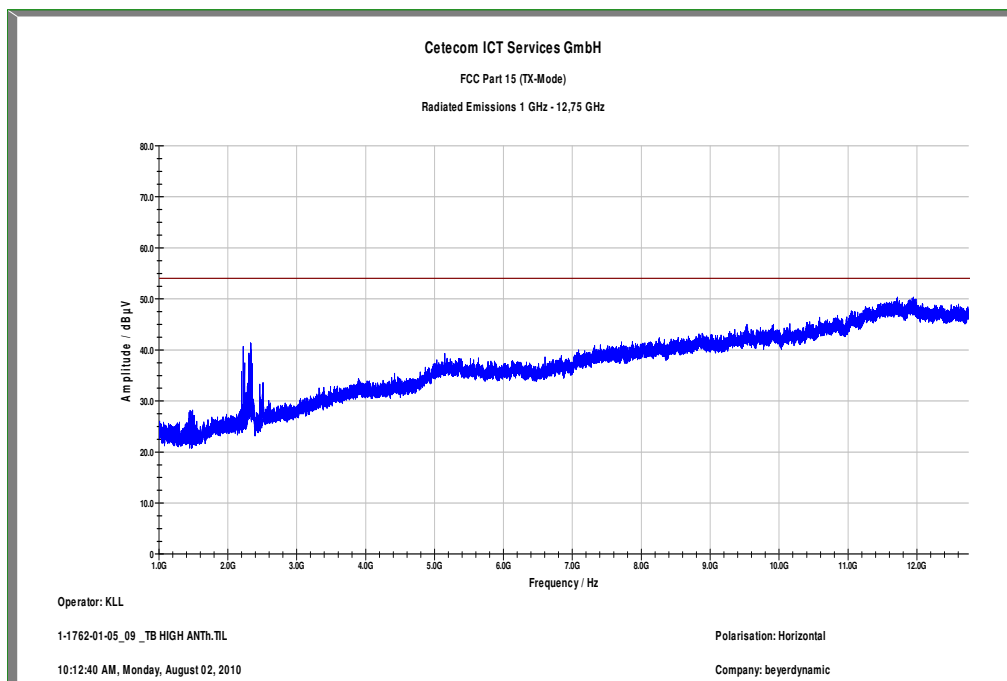

Carrier suppressed with a 2.4 GHz-band rejection filter

9.10 RX Spurious Emissions Radiated

Description:

Measurement of the radiated spurious emissions in idle/receive mode.

Measurement:

Measurement parameter	
Detector:	Peak / Quasi Peak
Sweep time:	Auto
Video bandwidth:	Sweep: 100 kHz Remeasurement: 10 Hz
Resolution bandwidth:	F < 1 GHz: 100 kHz F > 1 GHz: 1 MHz
Span:	30 MHz to 25 GHz
Trace-Mode:	Max Hold

Limits:

FCC		IC	
CFR Part 15.109		RSS Gen, Issue 2, 4.10	
RX Spurious Emissions Radiated			
Frequency (MHz)	Field Strength (dB μ V/m)	Measurement distance	
30 - 88	30.0	10	
88 - 216	33.5	10	
216 - 960	36.0	10	
Above 960	54.0	3	

Sample # 0000-0027

Result: Also see plots

RX Spurious Emissions Radiated [dBμV/m]		
F [MHz]	Detector	Level [dBμV/m]
No critical peaks detected		
Measurement uncertainty	± 3 dB	

Result: The result of the measurement is passed.

Plot 1: 30 MHz to 1 GHz / Idle-mode (horizontal/vertical)

EUT: Stegos TB
 Serial Number: 0000-0027
 Test Description: FCC part 15 class B @ 10 m
 Operating Conditions: RX
 Operator Name: HMN
 Comment: AC: 115 V / 60 Hz

Scan Setup: STAN_Fin [EMI radiated]

Hardware Setup: Electric Field (NOS)
 Level Unit: dBµV/m

Subrange **Detectors** **IF Bandwidth** **Meas. Time** **Receiver**
 30 MHz - 1,05 GHz QuasiPeak 120 kHz 15 s Receiver

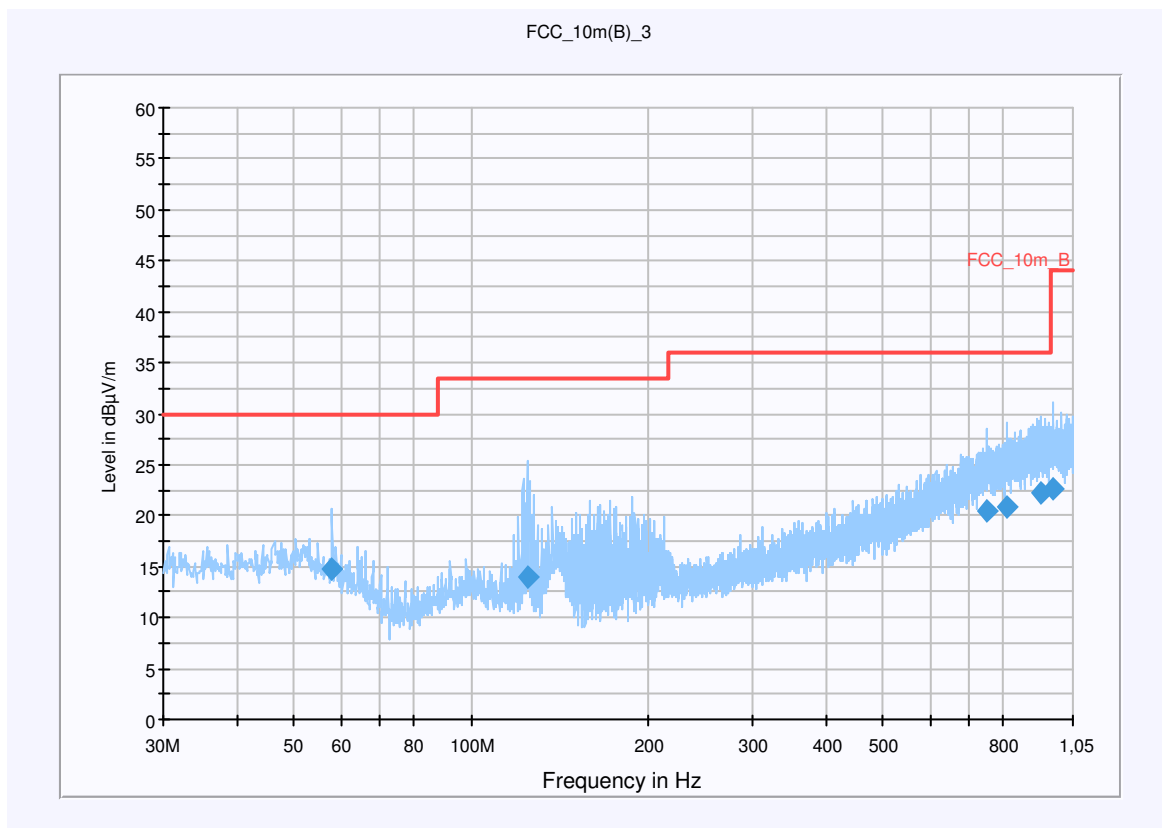

Final Result 1

Frequency (MHz)	QuasiPeak (dBµV/m)	Meas. Time (ms)	Bandwidth (kHz)	Antenna height (cm)	Polarity	Turntable position (deg)	Corr. (dB)	Margin (dB)	Limit (dBµV/m)	Comment
57.961350	14.8	15000.000	120.000	98.0	V	77.0	12.1	15.2	30.0	
124.443300	14.1	15000.000	120.000	98.0	V	94.0	9.9	19.4	33.5	
749.697600	20.5	15000.000	120.000	220.0	H	290.0	23.6	15.5	36.0	
812.878800	20.8	15000.000	120.000	98.0	V	96.0	24.0	15.2	36.0	
923.845950	22.2	15000.000	120.000	220.0	V	13.0	25.3	13.8	36.0	
967.393800	22.6	15000.000	120.000	98.0	H	82.0	25.5	21.4	44.0	

Hardware Setup: EMI radiated\Electric Field (NOS) - [EMI radiated]

Subrange 1

Frequency Range:	30 MHz - 2 GHz
Receiver:	Receiver [ESCI 3] @ GPIB0 (ADR 20), SN 100083/003, FW 4.32
Signal Path:	without Notch FW 1.0
Antenna:	VULB 9163 SN 9163-295, FW --- Correction Table (vertical): VULP6113 Correction Table (horizontal): VULP6113 Correction Table: Cable_EN_1GHz (1005)
Antenna Tower:	Tower [EMCO 2090 Antenna Tower] @ GPIB0 (ADR 8), FW REV 3.12
Turntable:	Turntable [EMCO Turntable] @ GPIB0 (ADR 9), FW REV 3.12

EMC 32 Version 8.10.00

Plot 2: 1 GHz to 12.75 GHz / Idle-mode antenna vertical

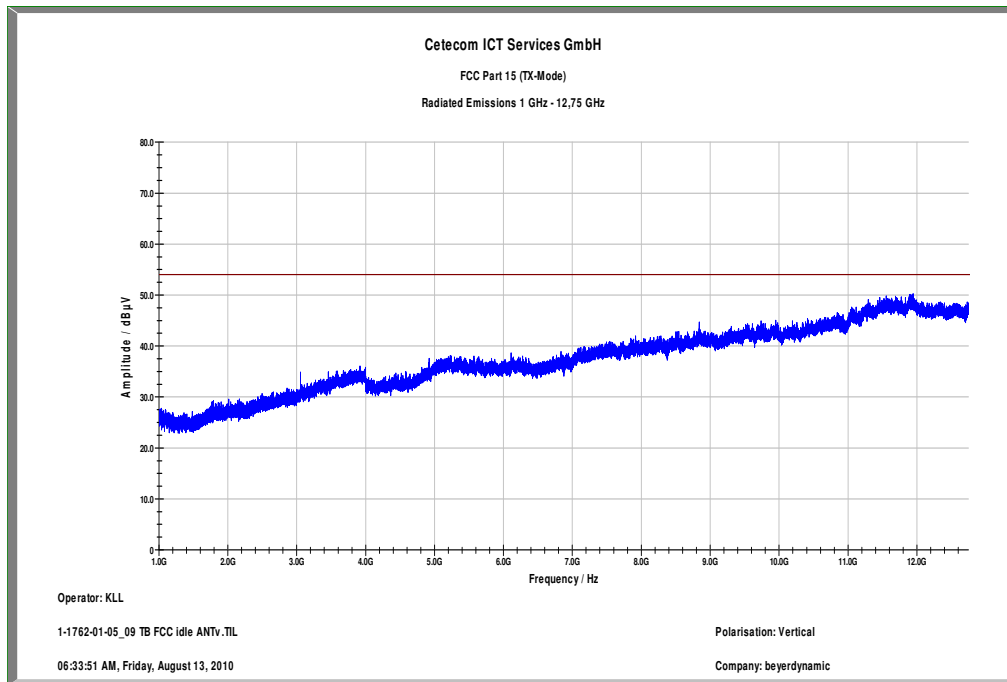

Plot 3: 1 GHz to 12.75 GHz / Idle-mode antenna horizontal

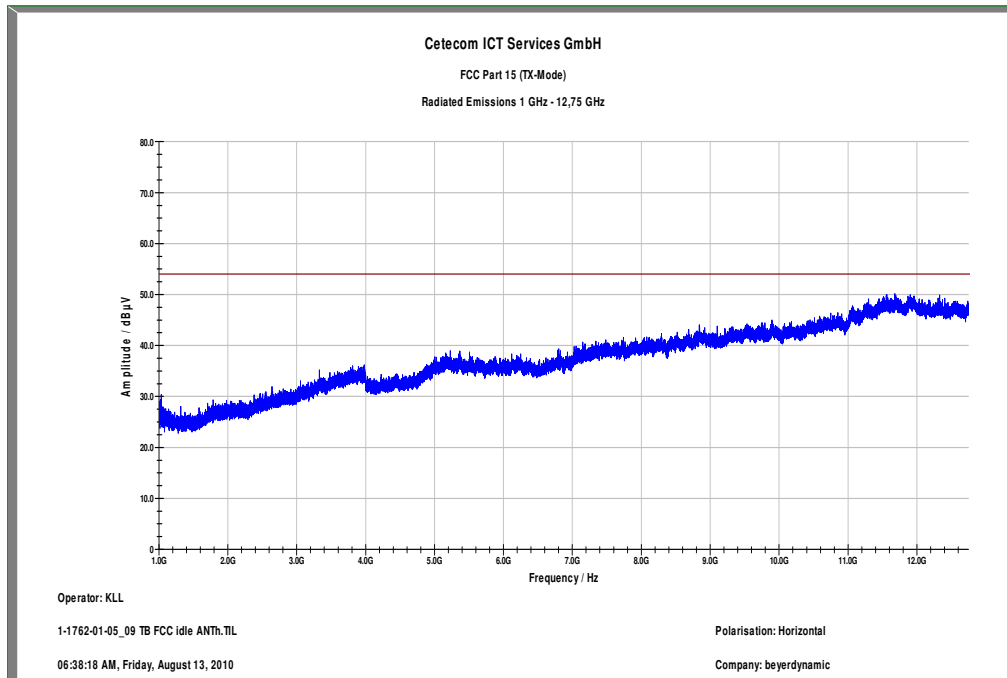

Plot 4: 12 GHz to 26 GHz / Idle-mode (horizontal/vertical)

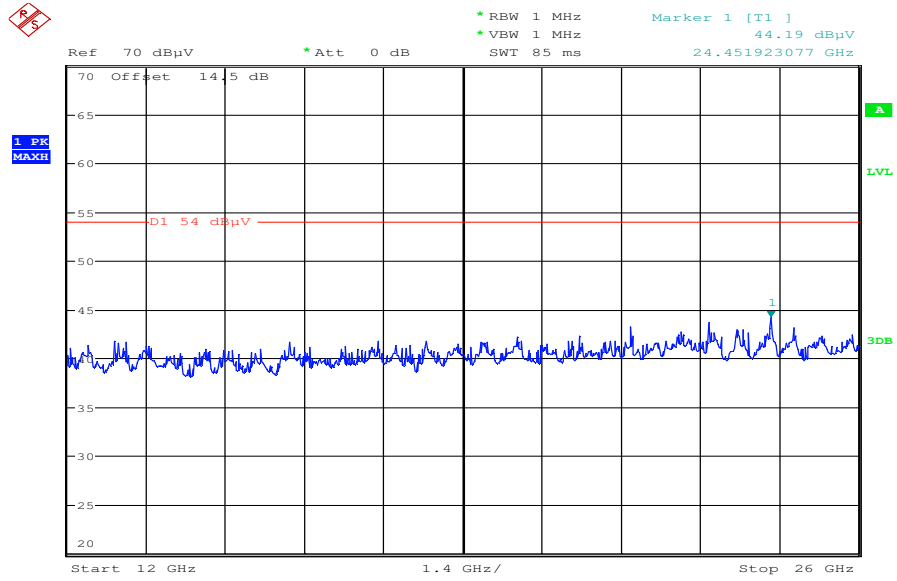

Date: 13.AUG.2010 06:44:26

9.11 TX Spurious Emissions Radiated < 30 MHz

Description:

Measurement of the radiated spurious emissions in transmit mode below 30 MHz. This measurement is representative for all channels and modes. If critical peaks are found lowest channel and highest channel will be measured too. The measurement is performed with the data rate producing the highest output power. The limits are recalculated to a measurement distance of 3 m with 40 dB/decade according CFR Part 2.

Measurement:

Measurement parameter	
Detector:	Peak / Quasi Peak
Sweep time:	Auto
Video bandwidth:	F < 150 kHz: 200 Hz F > 150 kHz: 9 kHz
Resolution bandwidth:	F < 150 kHz: 1 kHz F > 150 kHz: 100 kHz
Span:	9 kHz to 30 MHz
Trace-Mode:	Max Hold

Limits:

FCC		IC	
CFR Part 15.209(a)		RSS –Gen	
TX Spurious Emissions Radiated < 30 MHz			
Frequency (MHz)	Field Strength (dBμV/m)	Measurement distance	
0.009 – 0.490	2400/F(kHz)	300	
0.490 – 1.705	24000/F(kHz)	30	
1.705 – 30.0	30	30	

Sample # 0000-0027

Result: Also see plots

TX Spurious Emissions Radiated < 30 MHz [dBμV/m]		
F [MHz]	Detector	Level [dBμV/m]
No critical peaks found		
Measurement uncertainty	± 3 dB	

Result: The result of the measurement is passed.

Plot 1: 9 kHz to 30 MHz, TX

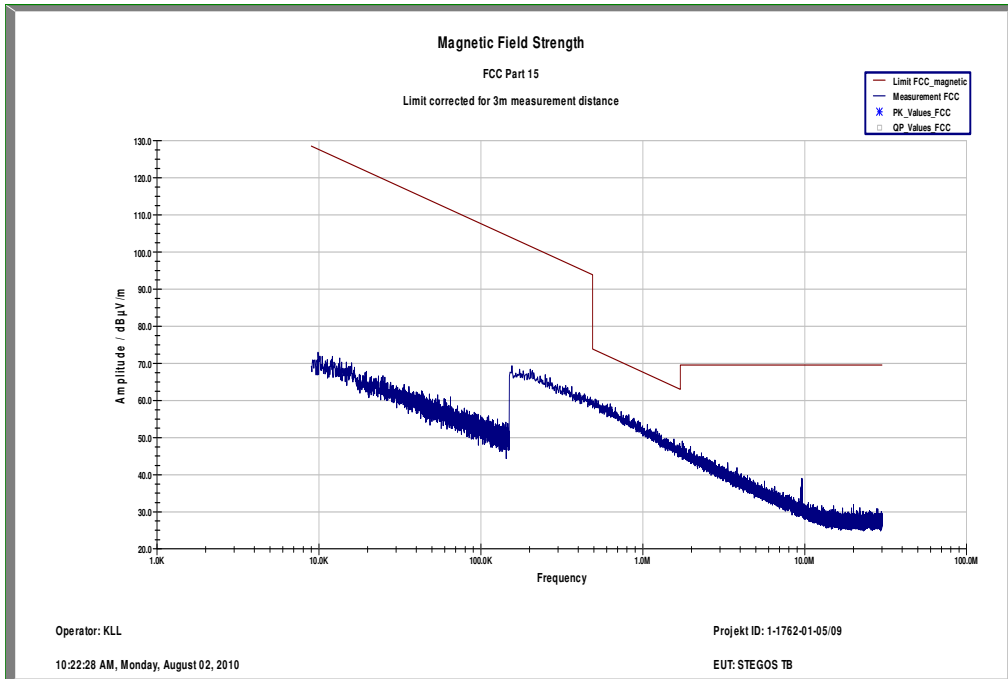

Plot 1: 9 kHz to 30 MHz, Idle

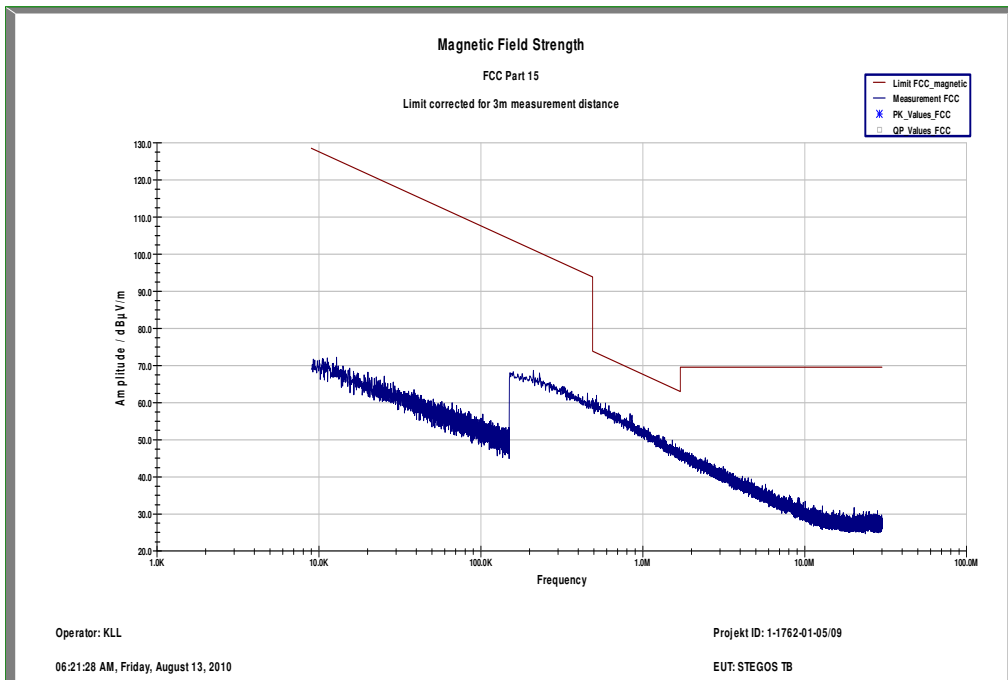

9.12 TX Spurious Emissions Conducted < 30 MHz

Description:

Measurement of the conducted spurious emissions in transmit mode below 30 MHz. The EUT is set to channel 6. This measurement is repeated for DSSS and OFDM modulation. If critical peaks are found channel 1 and channel 11 will be measured too. The measurement is performed with the data rate producing the highest output power. Both power lines, phase and neutral line, are measured. Found peaks are remeasured with average and quasi peak detection to show compliance to the limits.

Sample #0004

Measurement:

Measurement parameter	
Detector:	Peak - Quasi Peak / Average
Sweep time:	Auto
Video bandwidth:	F < 150 kHz: 200 Hz F > 150 kHz: 9 kHz
Resolution bandwidth:	F < 150 kHz: 1 kHz F > 150 kHz: 100 kHz
Span:	9 kHz to 30 MHz
Trace-Mode:	Max Hold

Limits:

FCC		IC
CFR Part 15.107(a)		-
TX Spurious Emissions Conducted < 30 MHz		
Frequency (MHz)	Quasi-Peak (dB μ V/m)	Average (dB μ V/m)
0.15 – 0.5	66 to 56*	56 to 46*
0.5 – 5	56	46
5 – 30	60	50

*Decreases with the logarithm of the frequency

Result: The result of the measurement is passed.

Plot 1: 9 kHz to 30 MHz / Phase Line

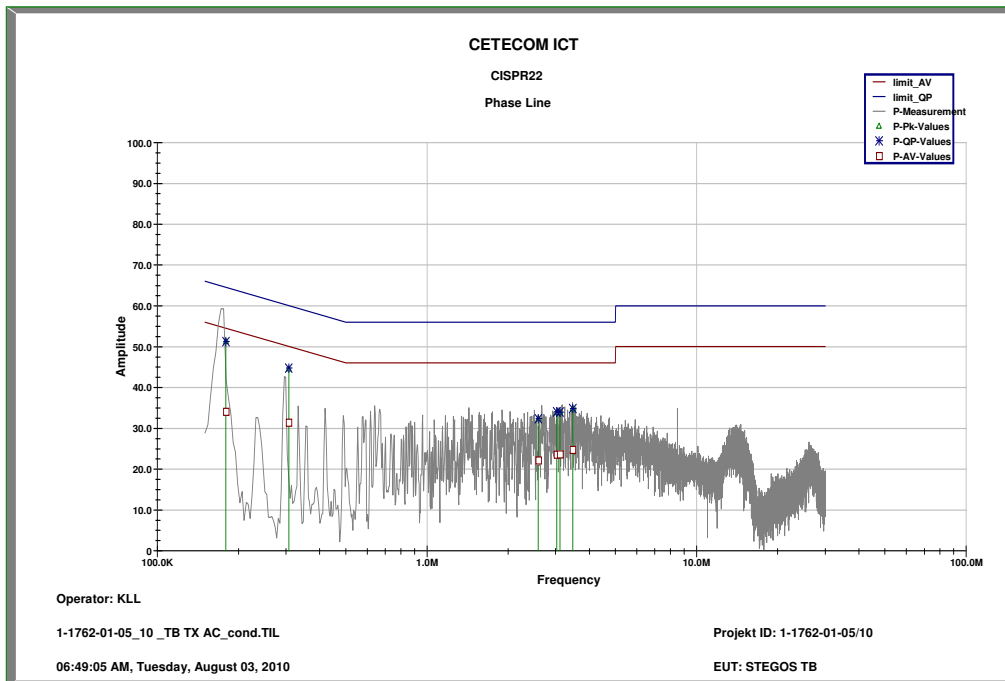

Plot 2: 9 kHz to 30 MHz / Neutral Line

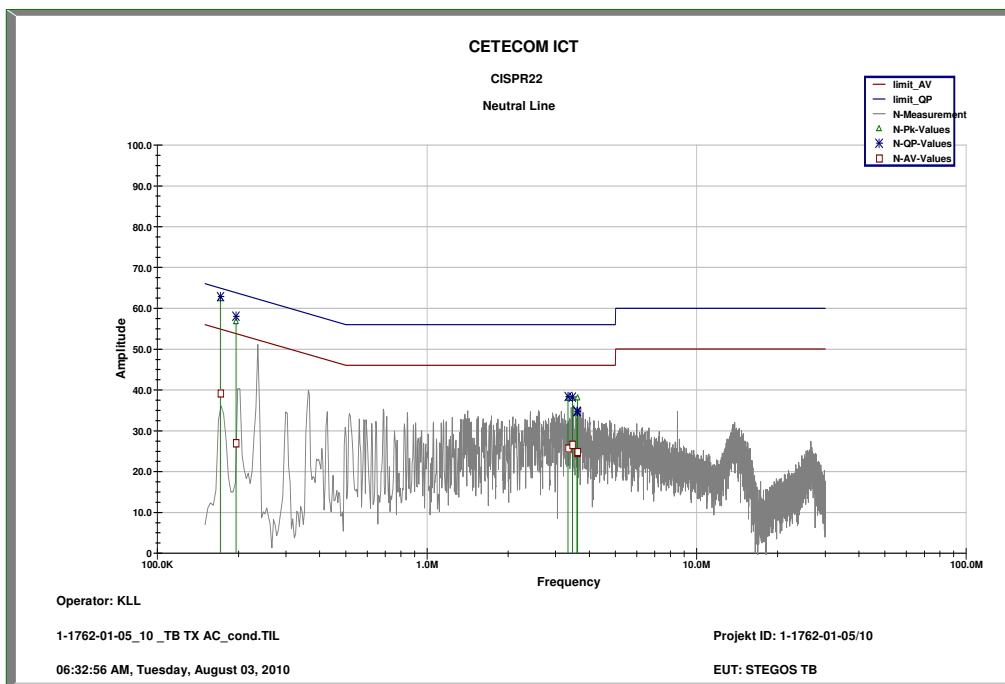

10 Test equipment and ancillaries used for tests

In order to simplify the identification of the equipment used at each specific test, each item of test equipment and ancillaries are provided with an identifier or number in the equipment list below.

Typically, the calibrations of the test apparatus are commissioned to and performed by an accredited calibration laboratory. The calibration intervals are determined in accordance with the DIN EN ISO/IEC 17025. In addition to the external calibrations, the laboratory executes comparison measurements with other calibrated test systems or effective verifications. Weekly chamber inspections and range calibrations are performed. Where possible, rf-generating and signalling equipment as well as measuring receivers and analyzers are connected to an external high-precision 10 MHz reference (GPS-based or rubidium frequency standard).

No.	Labor / Item	Equipment	Type	Manufact.	Serial No.	INV. No Cetecom	Kal. Art	Last Calibration	Next Calibration
1	45	Switch-Unit	3488A	HP Meßtechnik	2719A14505	300000368	g	30.06.2008	30.06.2010
2	50	DC power supply, 60Vdc, 50A, 1200 W	6032A	HP Meßtechnik	2920A04466	300000580	k	06.01.2009	06.01.2011
3	n. a.	EMI Test Receiver	ESCI 1166.5950.03	R&S	100083	300003312	k	08.01.2010	08.01.2012
4	n. a.	Amplifier	JS42-00502650-28-5A	MITEQ	1084532	300003379	ev	25.08.2008	25.08.2010
5	n. a.	Antenna Tower	Model 2175	ETS-LINDGREN	64762	300003745	izw	08.01.2009	08.01.2012
6	n. a.	Positioning Controller	Model 2090	ETS-LINDGREN	64672	300003746	izw		
7	n. a.	Turntable Interface-Box	Model 105637	ETS-LINDGREN	44583	300003747	izw	06.01.2010	06.01.2012
8	n. a.	TRILOG Broadband Test-Antenna 30 MHz - 3 GHz	VULB9163	Schwarzbeck	295	300003787	k	01.04.2010	01.04.2012
9	n. a.	Spectrum-Analyzer	FSU26	R&S	200809	300003874	k	08.01.2010	08.01.2012
10	n. a.	DC power supply, 60Vdc, 50A, 1200 W	6032A	HP Meßtechnik	2818A03450	300001040	Ve	08.01.2009	08.01.2012
11	n. a.	PowerAttenuator	8325	Byrd	1530	300001595	ne		
12	n. a.	Double-Ridged Waveguide Horn Antenna 1-18.0GHz	3115	EMCO	8812-3088	300001032	vIK!!	05.03.2009	05.03.2011
13	n. a.	Active Loop Antenna	6502	EMCO	2210	300001015	ne		
14	n. a.	Anechoic chamber	FAC 3/5m	MWB / TDK	87400/02	300000996	g	23.03.2009	
15	Spec.A. 2_2e	System rack for EMI measurement solution	85900	HP I.V.	*	300000222	ne		
16	9	Artificial Mains 9 kHz to 30 MHz, 4 x 25 Ampere	ESH3-Z5	R&S	828576/020	300001210	Ve	06.01.2010	06.01.2012
17	n. a.	Relais Matrix	3488A	HP Meßtechnik	2719A15013	300001156	ne		
18	n. a.	Relais Matrix	PSU	R&S	890167/024	300001168	ne		
19	n. a.	Isolating Transformer	RT5A	Grundig	9242	300001263	ne		
20	n. a.	Three-Way Power Splitter, 50 Ohm	11850C	HP Meßtechnik	MY47420220	300000997	ne		
21	n. a.	Switch / Control Unit	3488A	HP	2605e08770	300001443	ne		
22	n. a.	Band Reject filter	WRCG1855/1910-1835/1925-40/8SS	Wainwright	7	300003350	ev		
23	n. a.	Band Reject filter	WRCG2400/2483-2375/2505-50/10SS	Wainwright	11	300003351	ev	19.03.2010	19.03.2011
24	n. a.	TILE-Software Emission	Quantum Change, Modell TILE-ICS/FULL	EMCO	none	300003451	ne	28.05.2009	28.05.2011
25	n. a.	Highpass Filter	WHKX2.9/18G-12SS	Wainwright	1	300003492	ev	01.07.2010	01.07.2012
26	n. a.	Highpass Filter	WHK1.1/15G-10SS	Wainwright	3	300003255	ev		
27	n. a.	Highpass Filter	WHKX7.0/18G-8SS	Wainwright	18	300003789	ne		
28	n. a.	PSA Spectrum	E4440A	Agilent	MY48250080	300003812	k		

		Analyzer 3 Hz - 26.5 GHz		Technologies					
29	n. a.	MXG Microwave Analog Signal Generator	N5183A	Agilent Technologies	MY47420220	300003813	k		
30	n. a.	RF Filter Section 9kHz - 1GHz	N9039A	Agilent Technologies	MY48260003	300003825	vIK!!		
31	n. a.	TRILOG Broadband Test-Antenna 30 MHz - 3 GHz	VULB9163	Schwarzbeck	371	300003854	vIK!!	17.12.2008	17.12.2010
32	n. a.	Signal Analyzer 20Hz-26,5GHz-150 to + 30 DBM	FSIQ26	R&S	835540/018	300002681-0005	k	07.01.2010	07.01.2012
33	n. a.	Spectrum Analyzer 20 Hz - 50 GHz	FSU50	R&S	200012	300003443	ve	01.07.2010	01.07.2012

Annex A Photographs of the Test Set-up

Photo 1:



Photo 2:



Annex B External Photographs of the EUT

Photo 1:



Photo 2:



Photo 3:

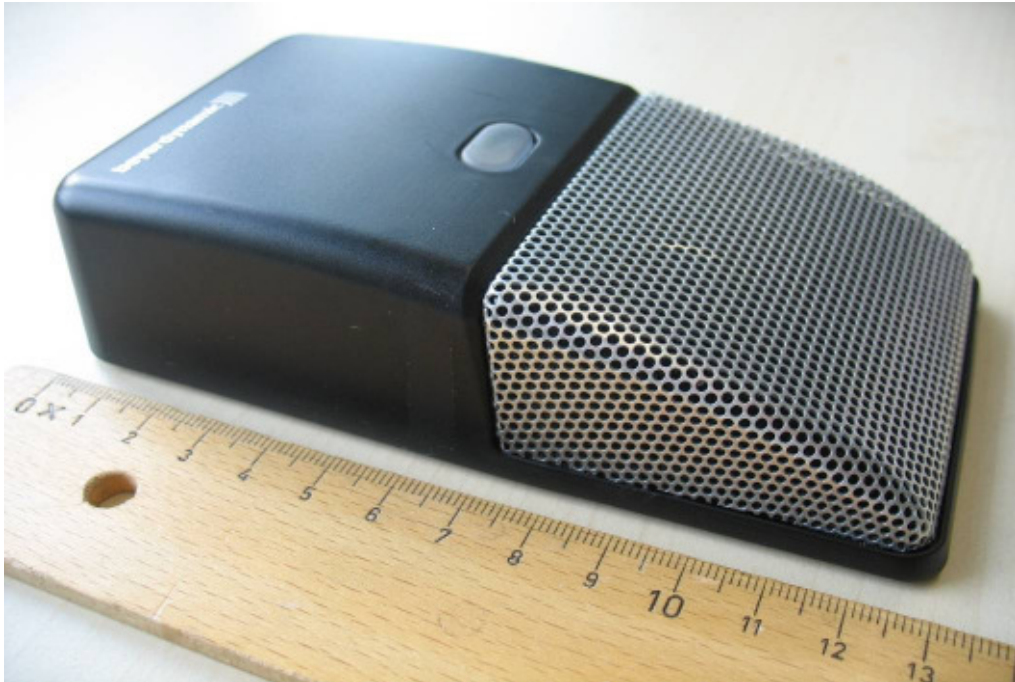

Photo 4:



Photo 5:



Photo 6:



Photo 7:



Annex C Internal Photographs of the EUT

Photo 1: (module for conducted measurements)

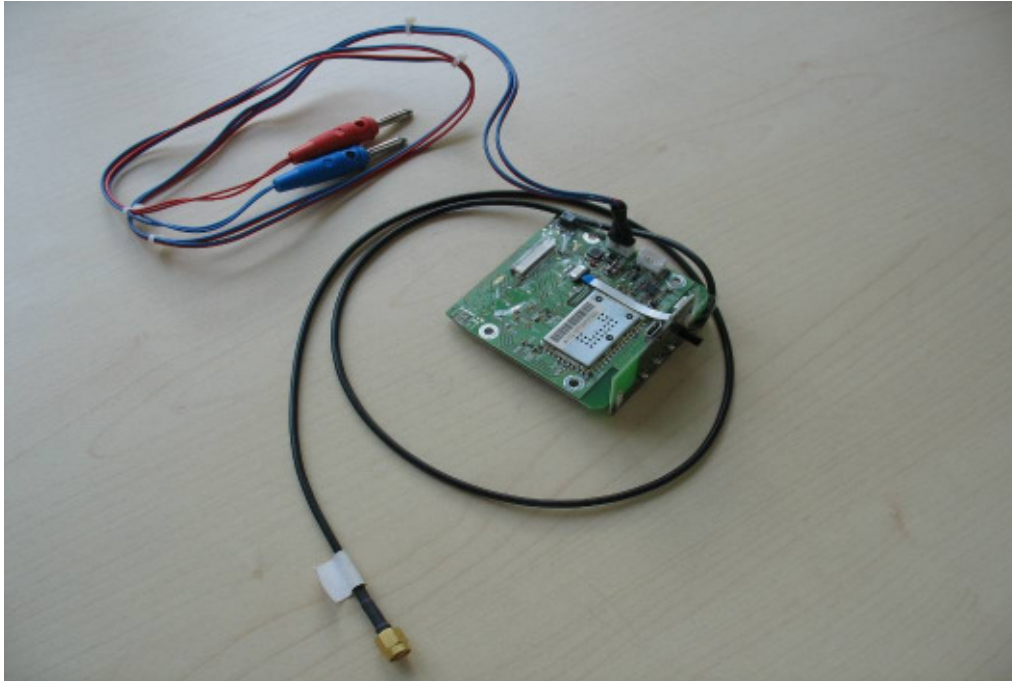

Photo 2: (module for conducted measurements)

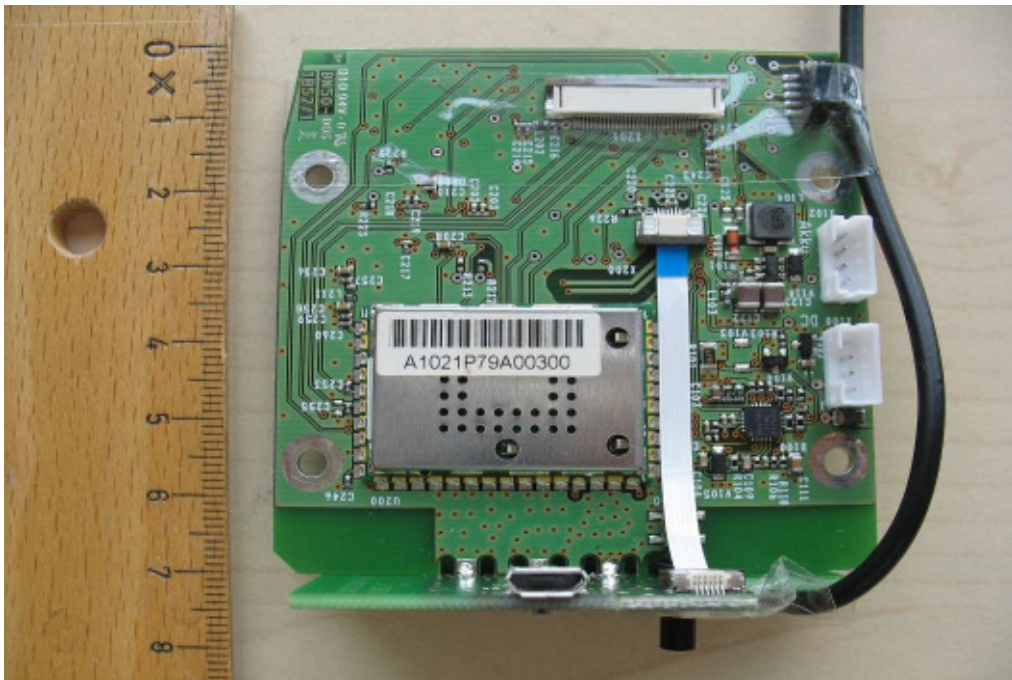

Photo 3: (module for conducted measurements)

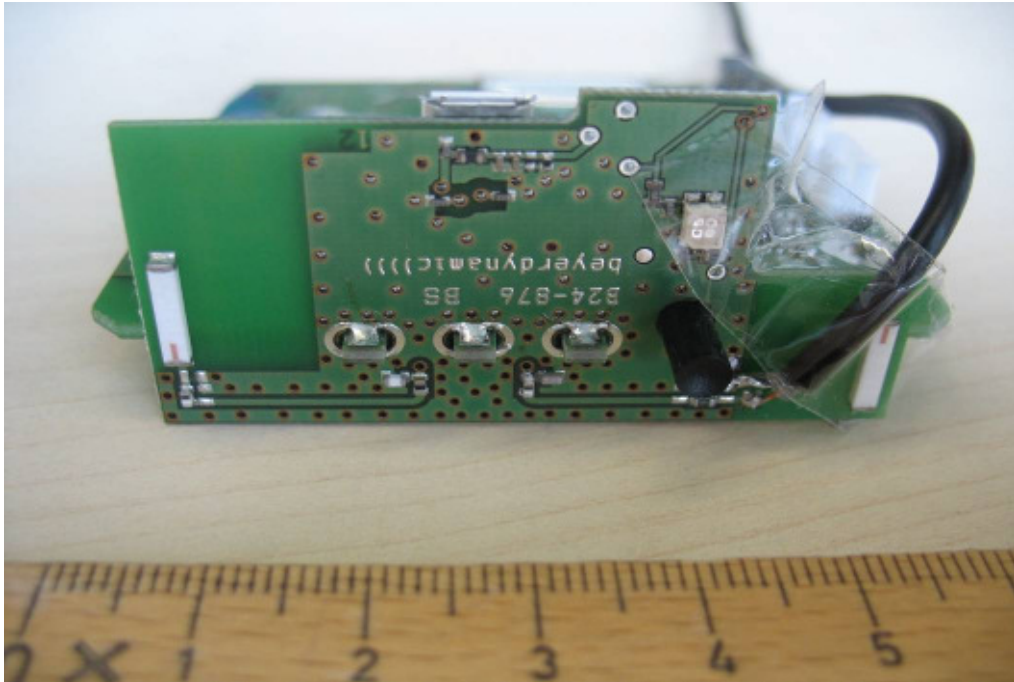

Photo 4: (module for conducted measurements)

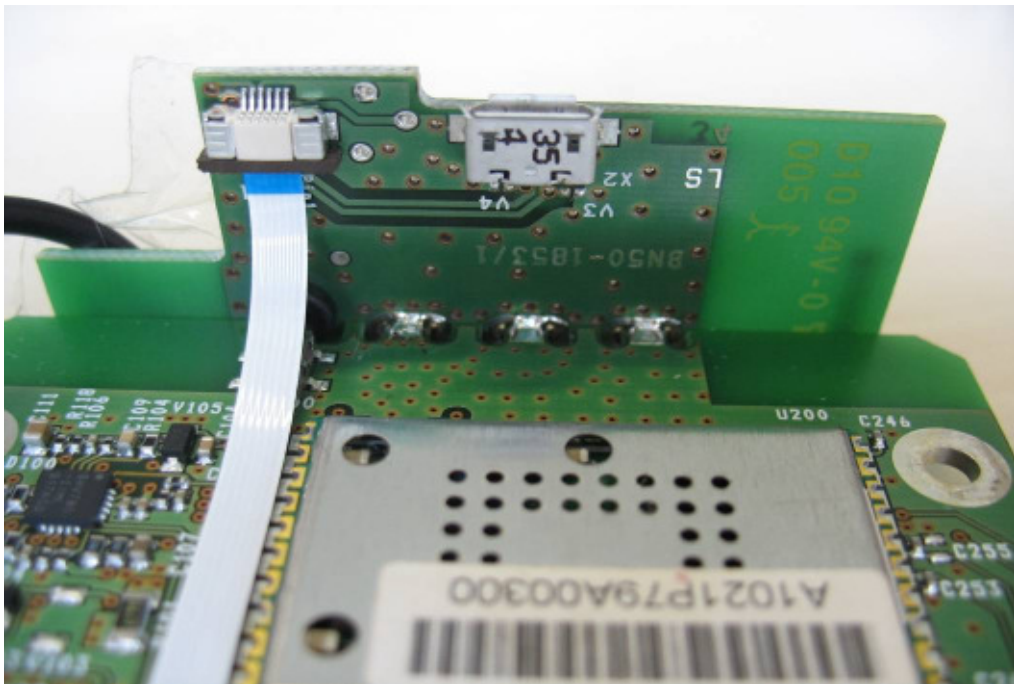

Photo 5: (module for conducted measurements)

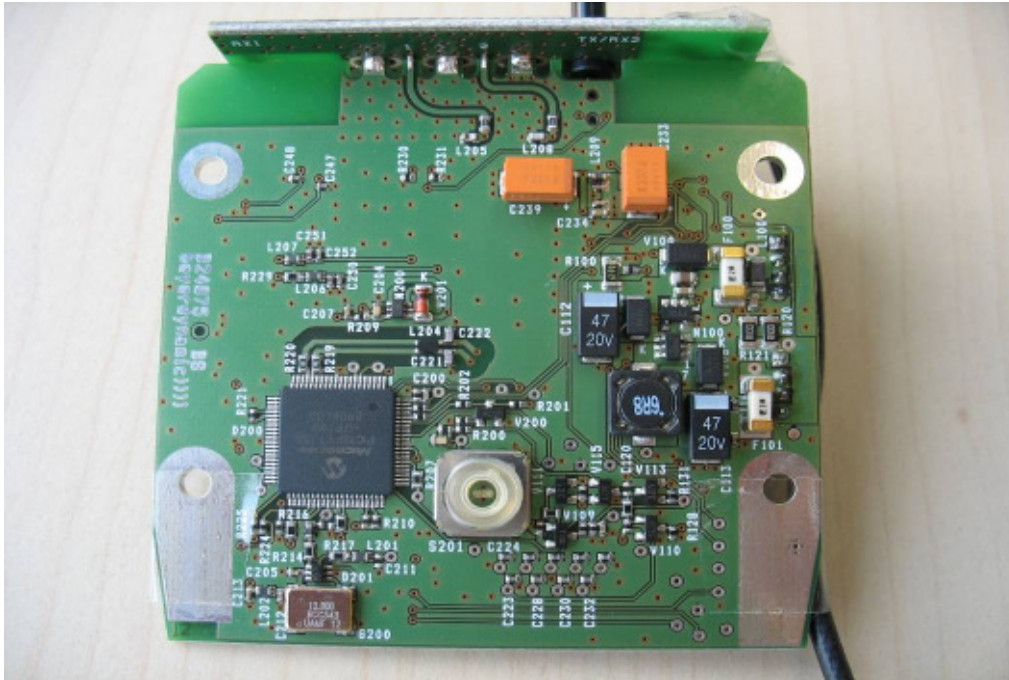

Photo 6: (sample for radiated measurements)



Photo 7: (sample for radiated measurements)

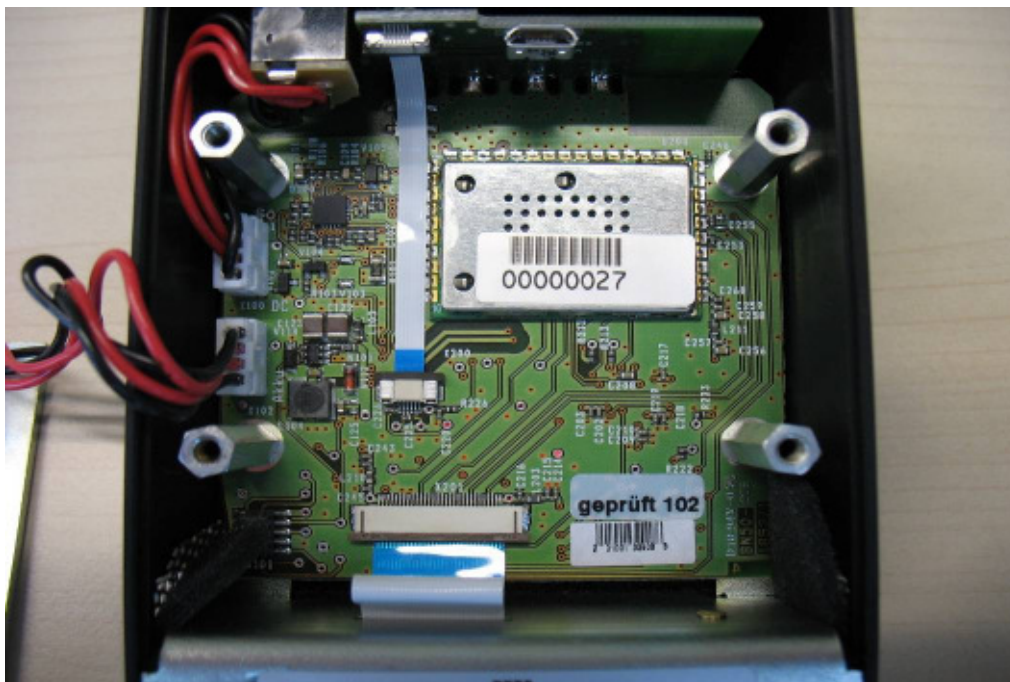

Photo 8: (sample for radiated measurements)



Photo 9: (sample for radiated measurements)

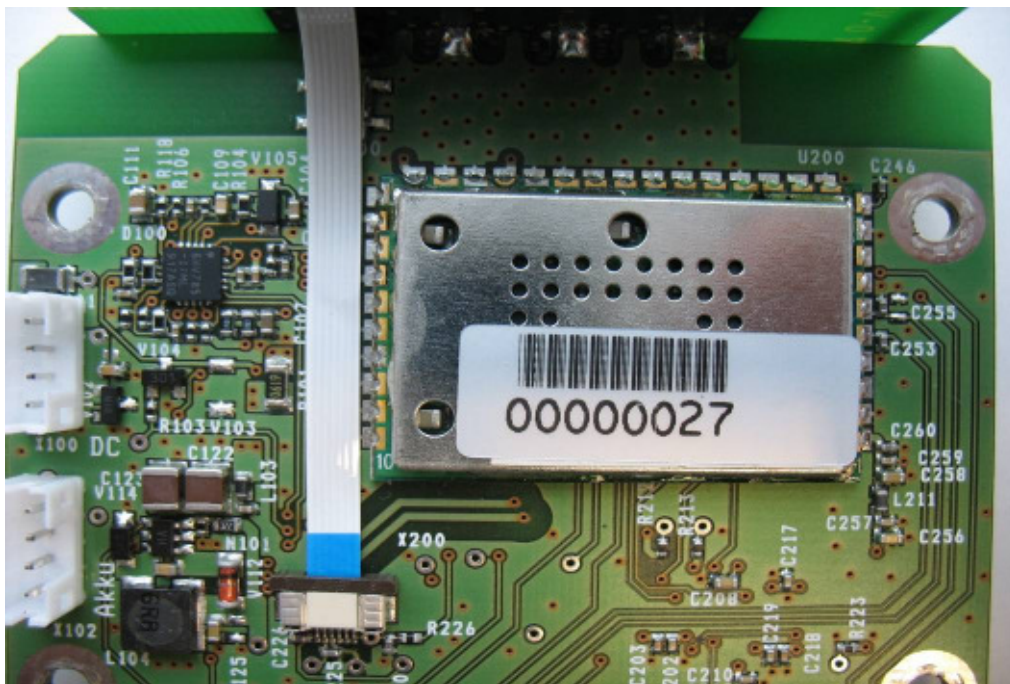

Photo 10: (sample for radiated measurements)



Photo 11: (sample for radiated measurements)

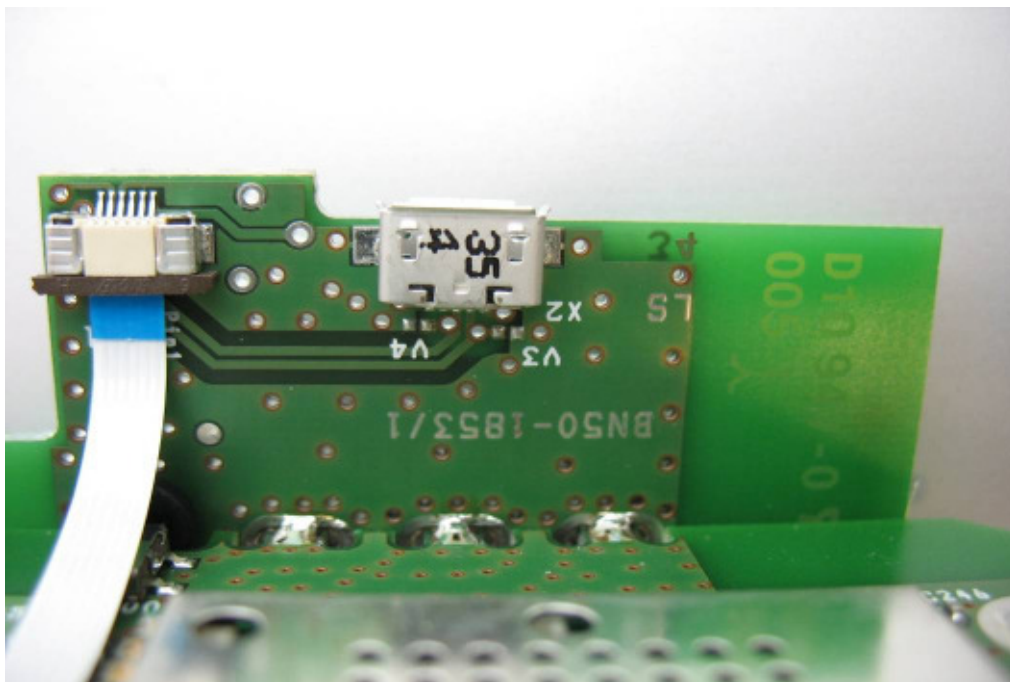

Photo 12: (sample for radiated measurements)

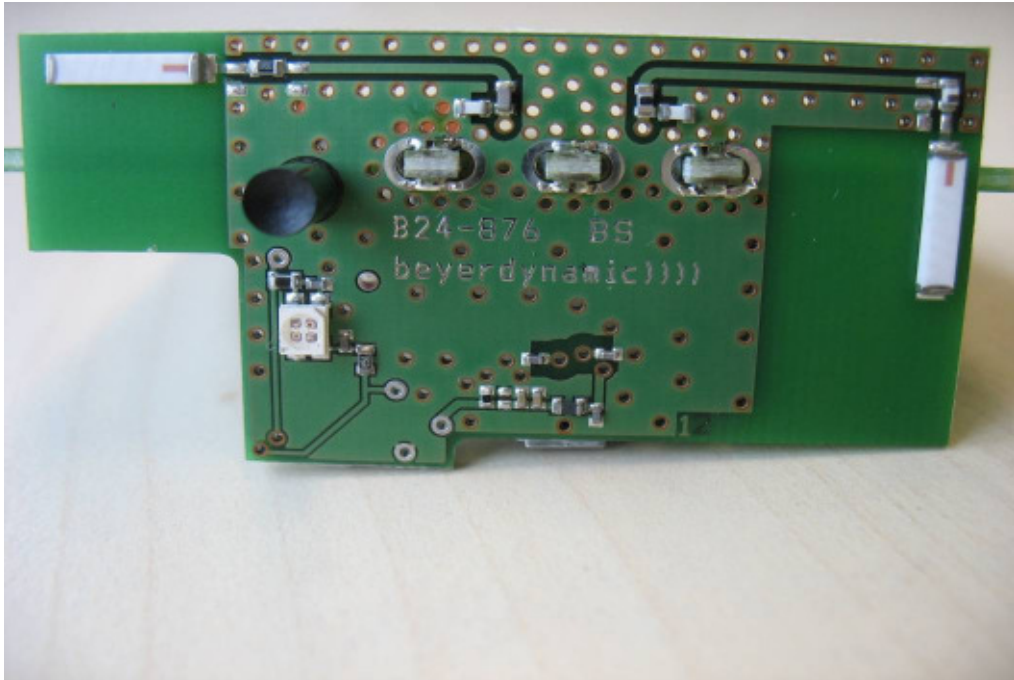

Photo 13: (sample for radiated measurements)

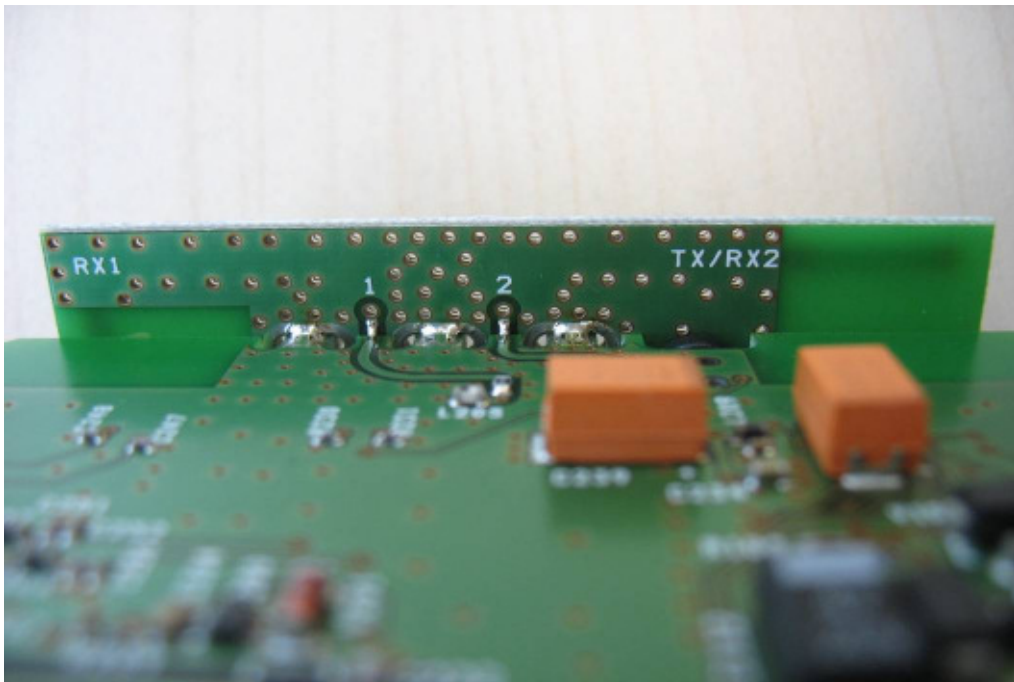

Photo 14: (sample for radiated measurements)

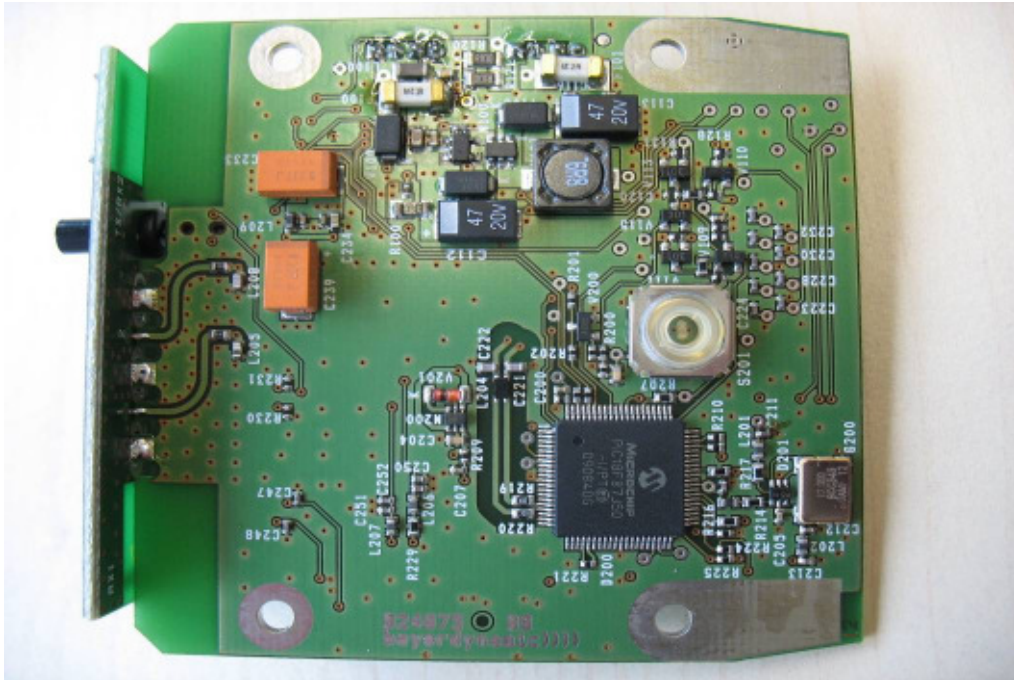

Photo 15: (sample for radiated measurements)
Module under the shield plate



Annex D Document history

Version	Applied changes	Date of release
1.0	Initial release	2010-08-17

Annex E Further information

Glossary

DUT	-	Device under Test
EMC	-	Electromagnetic Compatibility
EUT	-	Equipment under Test
FCC	-	Federal Communication Commission
FCC ID	-	Company Identifier at FCC
HW	-	Hardware
IC	-	Industry Canada
Inv. No.	-	Inventory number
N/A	-	not applicable
S/N	-	Serial Number
SW	-	Software