

# Quinta

— DIGITAL WIRELESS CONFERENCE SYSTEM

Operating Instructions

1.	Safety Instructions . . . . .	Page	4
1.1	Quinta CU Control Unit / Quinta Charger . . . . .	Page	4
1.2	Quinta MU Microphone Unit . . . . .	Page	5
1.3	Quinta TH Handheld Transmitter . . . . .	Page	5
1.4	Disposal . . . . .	Page	5
2.	Quinta CU Control Unit . . . . .	Page	7
2.1	Controls and Indicators . . . . .	Page	7
2.2	Where to Place the Control Unit . . . . .	Page	8
2.3	How to Connect the Antennae . . . . .	Page	8
	2.3.1 Direct Connection . . . . .	Page	8
	2.3.2 Remote Connection . . . . .	Page	8
2.4	Audio Connection . . . . .	Page	9
2.5	Power Supply . . . . .	Page	9
2.6	Connection of Media Control System and PC . . . . .	Page	9
2.7	How to Switch the Control Unit On/Off . . . . .	Page	10
2.8	Rack Mounting . . . . .	Page	10
2.9	Main Menu . . . . .	Page	11
	2.9.1 Master Volume . . . . .	Page	11
	2.9.2 Room Combining . . . . .	Page	12
	2.9.3 Ethernet Info . . . . .	Page	15
	2.9.4 AVB Info . . . . .	Page	16
	2.9.5 RF-Analyzer . . . . .	Page	16
	2.9.6 Firmware Versions . . . . .	Page	16
3.	Quinta MU Microphone Units . . . . .	Page	17
3.1	Controls and Indicators . . . . .	Page	17
3.2	How to Connect the Gooseneck Microphone . . . . .	Page	20
3.3	Switching On/Off . . . . .	Page	20
3.4	Powering / Operating Time . . . . .	Page	21
3.5	Powering with CA 2459 Mains Power Adapter . . . . .	Page	21
3.6	Operating Modes . . . . .	Page	22
	3.6.1 Normal Operating Mode . . . . .	Page	22
	3.6.2 FiFo Mode . . . . .	Page	22
	3.6.3 Push-To-Talk Mode . . . . .	Page	22
	3.6.4 Voice Activation Mode . . . . .	Page	22
3.7	Maintenance of the Microphone Units . . . . .	Page	23
4.	Programmable Functions of the Microphone Units with the Quinta Conference Software . . . . .	Page	23
4.1	Security Code . . . . .	Page	23
4.2	Programmable Function Button of the Chairman Microphone Unit . . . . .	Page	23
4.3	Request-To-Talk Mode . . . . .	Page	25
5.	Quinta CD 2 Charger in the Quinta CC 2   CC 2 / 600 Case . . . . .	Page	26
5.1	How to Use the Charger . . . . .	Page	26
5.2	Charging Process . . . . .	Page	26
6.	Battery Charging with External Mains Power Adapter . . . . .	Page	27
7.	Quinta TH Handheld Transmitter . . . . .	Page	28
7.1	Controls and Indicators . . . . .	Page	28
7.2	How to Attach the Microphone Head . . . . .	Page	29
7.3	How to Insert the Batteries . . . . .	Page	30
7.4	Switching On/Off . . . . .	Page	31
7.5	Operating Modes . . . . .	Page	31
7.6	Maintenance . . . . .	Page	32
7.7	Charging . . . . .	Page	33
8.	Trouble Shooting . . . . .	Page	34
8.1	Simultaneous Operation of the Quinta Conference System and other 2.4 GHz Devices . . . . .	Page	36
	8.1.1 Physical Laws . . . . .	Page	36
	8.1.2 Quinta and WLAN or WiFi . . . . .	Page	36
	8.1.3 Quinta and Bluetooth . . . . .	Page	37
	8.1.4 Example for Quinta, Media Control System and WLAN . . . . .	Page	37

---

9. Components . . . . .	Page 38
10 Accessories . . . . .	Page 38
11. Technical Specifications . . . . .	Page 39
EC-Declaration of Conformity . . . . .	Page 42
FCC Regulation . . . . .	Page 45
Special Instructions for Japan . . . . .	Page 45

Thank you for selecting the digital wireless Quinta conference system. Please take some time to read carefully through this manual before setting up the equipment.

Please register at [www.beyerdynamic.com/quinta/register](http://www.beyerdynamic.com/quinta/register). We will inform you about software updates and new developments of our Quinta product range. When registering you will be eligible to receive the Conference software control module (Quinta Conference Controller) free of charge.

## 1. Safety Instructions

### 1.1 Quinta CU Control Unit / Quinta Charger

1. Read these instructions.
2. Keep these instructions.
3. Heed all warnings.
4. Follow all instructions.
5. Do not use this apparatus near water.
6. Clean only with dry cloth.
7. Do not install near any heat sources such as radiators, heat registers, stoves, or other apparatus (including amplifiers) that produce heat.
8. Protect the power cord from being walked on or pinched particularly at plugs, convenience receptacles, and the point where they exit from the apparatus.
9. Only use attachments/accessories specified by the manufacturer.
10. Unplug this apparatus during lightning storms or when unused for long periods of time.
11. Refer all servicing to qualified service personnel. Servicing is required when the apparatus has been damaged in any way, such as power supply cord or plug is damaged, liquid has been spilled or objects have fallen into the apparatus, the apparatus has been exposed to rain or moisture, does not operate normally, or has been dropped.

#### Exemption from liability

- beyerdynamic GmbH & Co. KG will not be liable if any damage, injury or accident occurs due to negligent, incorrect or inappropriate operation of the product.

#### Location

- The equipment must be set up so that the mains switch, mains plug and all connections on the rear of the device are easily accessible.
- If you transport the equipment to another location take care to ensure that it is adequately secured and can never be damaged by being dropped or by impacts on the equipment.

#### Fire hazard

- Never place naked flames (e.g. candles) near the equipment.

#### Humidity / heat sources

- Never expose the equipment to rain or a high level of humidity. For this reason do not install it in the immediate vicinity of swimming pools, showers, damp basement rooms or other areas with unusually high atmospheric humidity.
- Never place objects containing liquid (e.g. vases or drinking glasses) on the equipment. Liquids in the equipment could cause a short circuit.
- Do not install near any heat sources such as radiators, heat registers, stoves or other apparatus (including amplifiers) that produce heat.

#### Connection

- The equipment must be connected to a mains socket that has an earth contact.
- Protect the power cord from being walked on or pinched particularly at plugs, convenience receptacles, and the point where they exit from the apparatus.

- Lay all connection cables so that they do not present a trip hazard.
- Whenever working on the inputs and outputs of the equipment switch off power.
- Check whether the connection figures comply with the existing mains supply. Serious damage could occur due to connecting the system to the wrong power supply. An incorrect mains voltage could damage the equipment or cause an electric shock.
- Please note that different operating voltages require the use of different types of power cable and plugs.

Please refer to the following table:

Voltage	Power plug according to standard
110 - 125 V	UL817 and CSA C 22.2 no 42.
220 - 230 V	CEE 7 page VII, SR section 107-2-D1/IEC 83 page C4.
240 V	BS 1363 (1984): "Specification for 13A fused plugs and switched and un-switched socket outlets."

- If the equipment causes a blown fuse or a short circuit, disconnect it from the mains and have it checked and repaired.
- Do not hold the mains cable with wet hands. There must be no water or dust on the contact pins. In both cases you could receive an electric shock.
- The mains cable must be firmly connected. If it is loose there is a fire hazard.
- Always pull out the mains cable from the mains and/or from the equipment by the plug – never by the cable. The cable could be damaged and cause an electric shock or fire.
- Do not use the equipment if the mains plug is damaged.
- If you connect defective or unsuitable accessories, the equipment could be damaged. Only use connection cables available from or recommended by beyerdynamic. If you use cables you have made up yourself, all claim to warranty is null and void.

#### Switching off

- In order to switch off the device disconnect the power plug from the power socket.

#### Disconnect

- For pluggable equipment, the socket-outlet shall be installed near the equipment and shall be easily accessible.

#### Maintenance

- Only clean the equipment with a slightly damp or dry cloth. Never use solvents as these damage the surface.

#### Troubleshooting and servicing

- Do not open the equipment without authorisation. You could receive an electric shock. There are no user-serviceable parts inside.
- Leave all service work to authorised expert personnel.

#### Charger

- Use only the CD2 charger or Quinta SC power supply unit to charge the rechargeable batteries integrated in the microphone units.
- Never remove the base foam section from the CD2 charger. There are no parts that can be serviced in the interior of the charger.
- The charger has been designed for charging the rechargeable batteries in the Quinta microphone stations. Only charge Quinta microphone units and no other battery operated equipment. The batteries could explode and injure you or damage the equipment.
- If you use the charger with accessories which have not been developed for it, this could result in a fire, an electric shock or physical injury.
- Never try to repair the charger yourself. There is a risk of an electric shock or causing a fire.

**Charger**

- Never use the charger as a mains power supply unit for electrical equipment.



- **Disconnect power plug first – then move charging case.**
- **In order to avoid damages to the mains connection and a possible electrical shock caused by this, you must not move the charging case when it is connected to an AC outlet.**

**1.2 Quinta MU Microphone Unit****Set up**

- Always position the microphone units on a secure surface. If the microphone unit falls down, you can hurt yourself or others or damage the microphone unit.
- **To align the gooseneck microphone on the microphone unit and to avoid twisting it too far and causing premature wear, please note that the gooseneck must be bent no further than an angle of 90° maximum.**

**Risk of injury**

- If the microphone stations have a gooseneck microphone take care that you do not injure yourself on this e.g. poke it into your eye.
- The charging contacts of the microphone units can cause damage to property, injuries or fire damage if they come into contact with conductive material such as jewellery, keys or chains. This closes the circuit and can thus cause the material to heat up. To avoid this sort of unwanted circuit, the charging contacts must be handled with caution. This applies particularly if the microphone units are transported in a bag or some other container together with metal objects.

**Charging / rechargeable batteries**

- When charging the microphone unit in the charger, take care to ensure that you do not injure yourself when putting the station in or taking it out.
- Only switch on the charger when you have inserted all microphone units. Empty charging compartments should never be touched during the charging process. You could receive an electric shock.
- Avoid letting the rechargeable batteries in the microphone unit become too deeply discharged. The rechargeable batteries could be damaged and the life of them could be reduced.
- If battery operated equipment is not used for a lengthy period (e.g. 1 year) the self-discharge of the battery could be accelerated. The temperature for long-term storage should be between +10° C and +30° C.
- If the microphone units are not used for several months, the rechargeable batteries in the microphone units should be charged up at least twice a year in order to avoid them running out and deterioration in the performance due to self discharge.

**Volume**

- **If the participants of a meeting use a headphone with the Quinta microphone stations, please make sure that the volume is not set too high via the Quinta Conference software or the microphone unit itself. Otherwise, the hearing of the participants could permanently be damaged.**

**1.3 Quinta TH Handheld Transmitter****Use**

- Protect the transmitter from moisture and sudden impacts. You, or others, could either injure yourself or damage the transmitter.
- Switch off the transmitter before changing the battery.

- Do not blow into the microphone. In a condenser microphone this could damage the transducer. It is preferable to carry out a speech trial.

**NiMH rechargeable batteries, alkaline batteries**

- The Quinta TH handheld transmitter can be operated with two NiMH rechargeable batteries or alkaline batteries (AA LR6 Mignon).
- The commercial batteries can have a length tolerance of 2 - 3 mm. When changing the battery always ensure a good contact.
- If the transmitter is not being used for weeks or months, please remove the batteries. Batteries can leak when not being used for a long time and corrode the conductor strips and components. Repair is no longer possible. In this case all warranty claims are null and void. The description "leak proof" on batteries is no guarantee that they will not run out.
- Never take batteries apart yourself. The battery acid contained will damage skin and clothing.
- If abused or misused, rechargeable batteries may leak. In extreme cases, they may even present an explosion, heat, fire, smoke or gas hazard.
- Never expose batteries to excessive heat such as sunshine, fire or the like.

**Charging/charging contacts**

- Avoid letting the rechargeable batteries become too deeply discharged. The rechargeable batteries could be damaged and the life of them could be reduced.
- If battery operated equipment is not used for a lengthy period (e.g. 1 year) the self-discharge of the battery could be accelerated. The temperature for long-term storage should be between +10° C and +30° C.
- If the handheld transmitter is not used for several months, the rechargeable batteries in the transmitter should be charged up at least twice a year in order to avoid them running out and deterioration in the performance due to self discharge.
- From time to time the battery and charging contacts of the Quinta TH handheld transmitter should be cleaned with a lint-free soft cloth moistened with spirits or alcohol. Please remove the batteries from the battery compartment before cleaning.
- The charging contacts of the handheld transmitter can cause damage to property, injuries or fire damage if they come into contact with conductive material such as jewellery, keys or chains. This closes the circuit and can thus cause the material to heat up. To avoid this sort of unwanted circuit, the charging contacts must be handled with caution. This applies particularly if the handheld transmitter is transported in a bag or some other container together with metal objects.

**1.4 Disposal**

- Old batteries may contain substances that are harmful to your health and environment.
- If you throw away the Quinta TH transmitter, please remove the batteries. For removing the batteries, please refer to chapter "How to insert the batteries".
- Dispose used batteries always according to the applicable disposal regulations. Please do not throw used battery packs into the fire (danger of explosion) or your household rubbish, take them to your local collection points. The return is free and required by law. Please dispose discharged batteries only.
- The device provides built-in rechargeable batteries, which you cannot remove yourself, therefore, return the device to your dealer for recycling when the batteries are exhausted.
- All batteries are recycled to reclaim valuable material such as iron, zinc or nickel.

- This symbol on the product, in the instructions or on the packaging means that your electrical and electronic equipment should be disposed at the end of its life separately from your household waste. There are separate collection systems for recycling in the EU. For more information, please contact the local authority or your retailer where you purchased the product.



## 2. Quinta CU Control Unit

The Quinta CU control unit is the heart of the system. It controls the delegate and chairman microphone units. With one control unit a maximum of 4 speakers (e.g. 3 delegates and 1 chairman) can speak simultaneously. The radio transmission is in the triple band (2.4 / 5.2 / 5.8 GHz frequency band).

The control unit has been designed for installations on tables or 19" rack mounting. When setting up the system, please follow the safety instructions mentioned in chapter 1.

Furthermore, please note

- the ambient temperature of the installation site must not exceed 35 °C [95 °F].
- there must not be exceeding dust and humidity at the installation site.
- that the unit is not exposed to direct sunlight.
- the connection must be protected against direct access during operation.
- that there must be a strain relief of the cables.
- the installation site must be protected against vibrations.

### 2.1 Controls and Indicators

#### Front

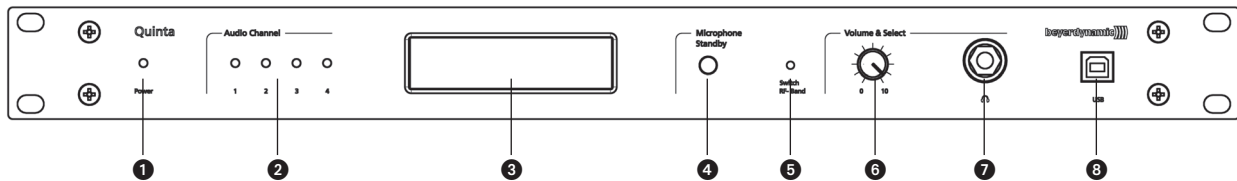

#### Rear

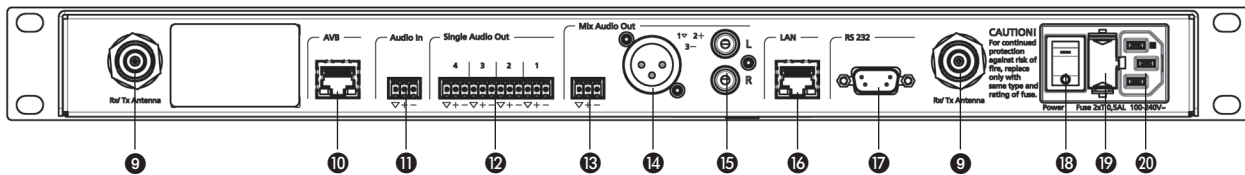

- |   |   |
|---|---|
| <ul style="list-style-type: none"> <li>❶ Power on LED</li> <li>❷ Audio channel LEDs 1 to 4 (white = channel vacant; red = channel occupied)</li> <li>❸ Display to indicate operating mode, channel, headphone volume</li> <li>❹ Standby button to turn off all microphone units centrally</li> <li>❺ Push-button for frequency band selection</li> <li>❻ Volume control for headphone / channel (The headphone volume is set by turning the control.<br/>By pressing and turning you can select and listen to the individual channels or a mix.<br/>When pressing more than 3 seconds you will access the main menu of the control unit.)</li> <li>❼ Headphone connection</li> <li>❽ USB connection</li> <li>❾ Antenna connections</li> </ul> | <ul style="list-style-type: none"> <li>❿ AVB (Audio Video Bridging) network connection for digital audio signals via CAT5 cables, RJ45</li> <li>⓫ Audio input (Audio IN) for the connection of external sound sources, 3-pin Phoenix terminal strip, balanced</li> <li>⓬ Audio output, individual channels, 4 x 3-pin Phoenix terminal strips, balanced</li> <li>⓭ Audio output Mix (Master), 3-pin Phoenix terminal strips, balanced</li> <li>⓮ Audio output Mix (Master), 3-pin XLR, balanced</li> <li>⓯ Audio output Mix (Master), RCA, unbalanced</li> <li>⓰ LAN connection for PC / network, RJ 45</li> <li>⓱ Connection for media control system / PC / network, RS 232</li> <li>Ⓜ On/Off switch</li> <li>Ⓝ Fuse</li> <li>Ⓞ Mains connection</li> </ul> |
|---|---|

## 2.2 Where to Place the Control Unit

- If you **do not** use remote antennae, place the **Quinta CU control unit** in the room where the meeting takes place. If you use **remote** antennae, place the **antennae** in the conference room.
- Avoid shadowing effect of the antennae, especially by metallic surfaces.
- A free line of sight between the Quinta MU microphone units and the antennae of the Quinta CU control unit is essential for the operation of the microphone units. Big obstacles in between can

possibly affect the radio transmission. In such specific installations the use of remote antennae can possibly achieve an improvement of the RF situation.

- If you want to install several Quint CU control units in a 19" rack, please make sure that there is a minimum distance of 1 U between the control units to avoid interferences, especially if you do not use remote antennae.

## 2.3 How to Connect the Antennae

### 2.3.1 Direct Connection

- Connect the antennae to the antenna connections **9**. Please note that for diversity operation both antennae have to be connected! A weighting circuit is used to make sure that the better antenna signal is received.
- For stand-alone operation we recommend using the supplied CA Q 11 angled rod antennae.

### 2.3.2 Remote Connection

- The Quinta CU control unit can also be operated with remote antennae. We recommend extremely low attenuation connecting cables which are 10 m [32.8 ft] or 20 m [65.6 ft] long. Please note that the antennae have to be installed remotely.

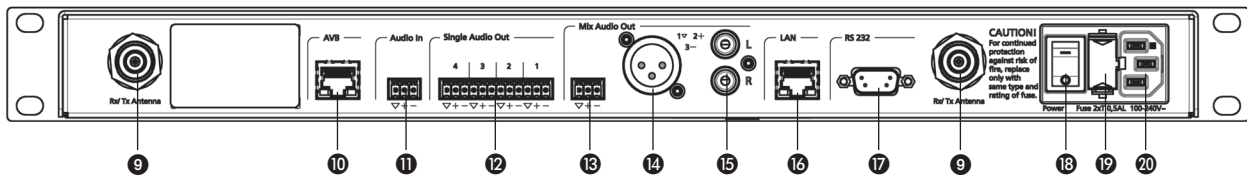

#### Important:

- There must be an **unobstructed path** between the **microphone units** and the **antennae**, i.e. **between the Quinta CU control unit** or the **remote antennae** and the **microphone units** there **must not be any obstacles**. With a free line of sight between the control unit and the microphone units and the rod antennae the **range is between 30 to 50 m [98.4 ft to 164 ft]**.

For optimum range the surface of the table is important, wood or plastic tables are ideal, but metal tables can cause interferences and reduce the range.

- Please make sure that with a free line of sight the **minimum distance** between the **antennae** and the **microphone units** is **not less than 1 m [3.2 ft]**.



### 2.4 Audio Connection

- If required, connect the Audio Mix 13, XLR 14 or Cinch 15 master output of the Quinta CU control unit to the input of a mixing console or amplifier.
- If you want to feed the audio signals into a network, connect the AVB connection \* 10 to the network by using a CAT5 cable. You can also connect other audio sources or devices with AVB connection, which are defined as “Talker” (e.g. microphone) or “Listener” (e.g. loudspeaker), as well as DSP devices for audio data processing.
- You can connect e.g. external loudspeakers to the individual channels of the audio output 12.
- Always route cables running to the unit where they will not be pinched or cut by heavy or sharp objects.

\*AVB is a uniform standard for Audio/Video networks for data communication with which the most different components can communicate with each other.

AVB is based on IEEE 802 Ethernet for the real-time streaming of audio and video contents via Ethernet.

AVB features a bandwidth reservation, a low jitter master clock, low latencies and a timing mechanism for the synchronisation. AVB supplies a sufficient raw data bandwidth to transmit up to 200 audio channels via one single Gigabit Ethernet port. Field tests showed that a part of this can be used for extended functions. In order to achieve this, an AVB network separates the AVB data traffic from the Standard Ethernet data traffic and manages streams accordingly. This means that an AVB network can be connected to a Standard Ethernet network to transfer data to and from the network. The performance of the streaming of media can only be guaranteed within a group of AVB capable devices.

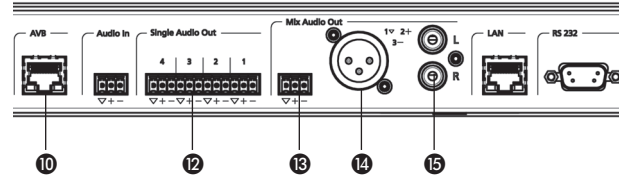

### 2.5 Power Supply

- Verify that the voltage rating of the unit matches that of the AC mains outlet you are to use. If you connect the unit to the wrong voltage, you may seriously damage it.
- Always route cables running to the unit where they will not be pinched or cut by heavy or sharp objects.
- Connect the Quinta CU control unit to the mains 20. The internal power supply unit of the control unit can automatically adjust between 100 and 240 V at 50 - 60 Hz.

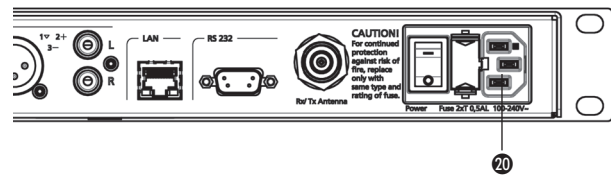

### 2.6 Connection of Media Control System and PC

- If you want to configure, control and monitor the system via the Quinta Conference software, connect the USB connection 8 or the LAN connection 16 or RS 232 17 (null modem cable required) with a media control system or PC. The default IP address of the Quinta CU control unit is: 192.168.1.55
- If the Quinta CU control unit is connected e.g. via a network with a WLAN Access Point, you can access the web server of the Quinta CU control unit e.g. with a smartphone.

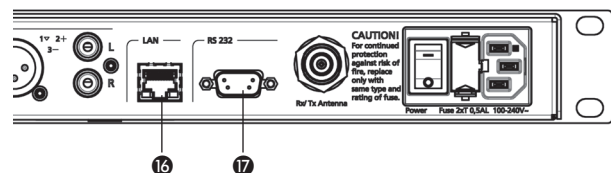
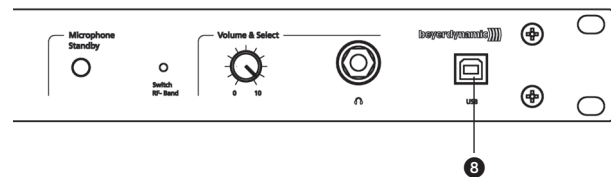

**Important:** Never access the Quinta CU control unit via the media control system and the Quinta Conference software simultaneously. In this case a correct function of the system cannot be guaranteed.

### 2.7 How to Switch the Control Unit On/Off

- Turn on the Quinta CU control unit with the On/Off switch ①. The Power on LED ① will illuminate.
- The channel LED 1 to 4 will illuminate white to indicate the availability. As soon as a microphone is activated, the channel LED ② will illuminate red to indicate that the channel is occupied.

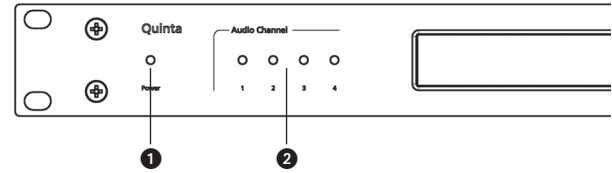
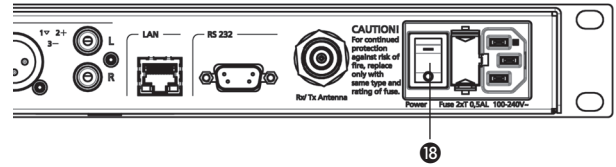

- At the factory the RF bands 2.4; 5.2 or 5.8 GHz\* will be activated (Automatic Mode). This means that the Quinta CU control unit will select a free frequency and if necessary it will select a different free frequency without any interferences. This operating mode is recommended for normal use. The free frequencies for the Quinta CU control unit can be deactivated via the Quinta Conference software. The microphone unit will automatically be adjusted to the frequency of the Quinta CU control unit.
- If required you can select a fixed frequency (Manual Mode). Use the tip of a pencil or a paper clip to press the countersunk push-button for RF band selection ⑤. The push-button ⑤ switches through all available frequencies one after another and back to the "Automatic Mode". The manual frequency selection can take up to 1.5 seconds and is immediately displayed. The microphone units are automatically adjusted to the selected frequency band.

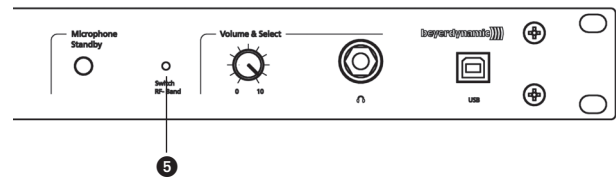

**\*Note:**

The availability of the RF bands 2.4; 5.2 or 5.8 GHz depends on the selected region.

### 2.8 Rack Mounting

- When mounting the Quinta CU control unit into a 19" rack housing leave 1 U for a ventilation panel above and below the control unit.
- Make sure that the mains connection, mains switch and all audio connections on the rear of the device are easily accessible.

## 2.9 Main Menu

Press the volume control **6** approx. 3 seconds until the Quinta CU control unit displays “Main Menu”.

By turning and pressing you can display and set different parameters in the main menu.

### 2.9.1 Master Volume

- Press the volume control **6** approx. 3 seconds until the Quinta CU control unit displays “Main Menu”.
- Turn the volume control **6** to the right or left until “Master Volume” is displayed.
- Press the volume control **6** to enter the submenu “Push to decrease level”.

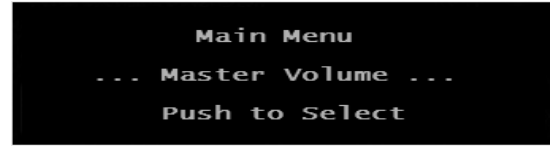

- Press the volume control **6**, if you want to reduce the volume.

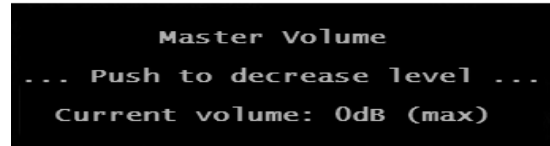

- If you want to increase the system volume, turn the volume control **6** clockwise to enter the submenu “Push to increase level”.
- Press the volume control **6** to increase the volume. The maximum setting is 0 dB.

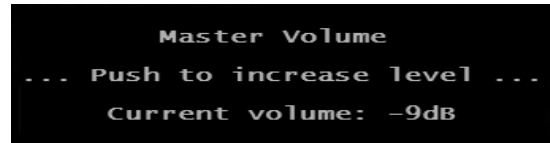

- After setting the parameter, turn the volume control **6** clockwise until the submenu “Master Volume” - “Exit” ist displayed. Press the volume control **6** to leave the menu item “Master Volume”.

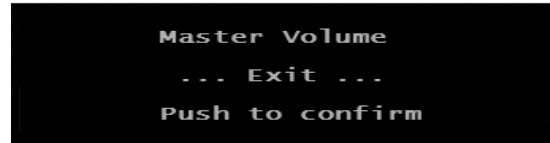

- The default screen is displayed.

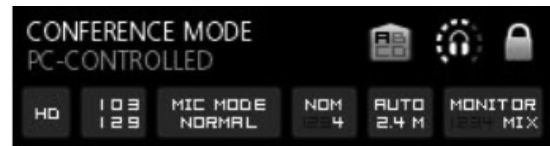

### 2.9.2 Room Combining

The “Room Combining” function is used when you want to operate or combine several Quinta systems in different rooms (A, B, C, D).

All microphone units and control units have been set to “A” at the factory. Refer to picture “Factory setting of control units and microphone units”. When you want to operate several systems in different rooms at the same time, you have to re-configure the systems; otherwise interference will occur. You can configure the systems for a maximum of four rooms.

When using the “Room Combining” function for the **first** time, please proceed as described in the following:

- Place the Quinta CU control units and the Quinta MU microphone units in the rooms A, B, C, D.

#### Room A

- As the control unit and the microphone units are configured to “A” there are no changes necessary for the control unit and microphone units in room A.

#### Room B to D

- The control unit and microphone units in the rooms B, C, D must be configured. The configuration of the control unit and the microphone units in room B is described in the following.

- Switch on the microphone units in room B only.
- Configure the microphone units in room B. Press the volume control **6** approx. 3 seconds until the Quinta CU control unit displays the main menu.
- Turn the volume control **6** to the right or left until “Room Combining” is displayed.

- Press the volume control **6** to enter the submenu.

- Turn the volume control **6** until “Mic. Unit Configuration” is displayed.

- Press the volume control **6** to enter the submenu “MU Configuration”. For the microphone units in room B turn the volume control **6** until “(B)” is displayed and press the volume control to select “(B)” (it is ticked).

- In order to transmit the configuration for room B to the microphone units in room B, turn the volume control **6** until “(Send2MU)” is displayed and press the volume control **6**. Below “(Send2MU)” the note “done” is displayed to show that the configuration has been transmitted to all microphone units in room B having a radio link to the control unit.

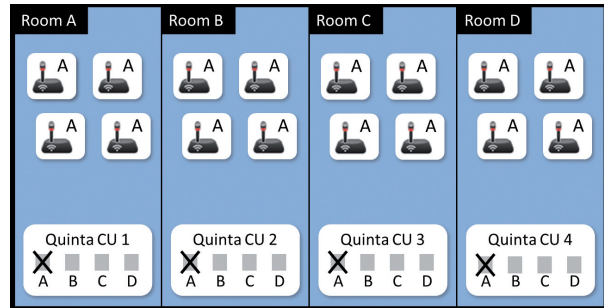

Factory setting of control units and microphone units

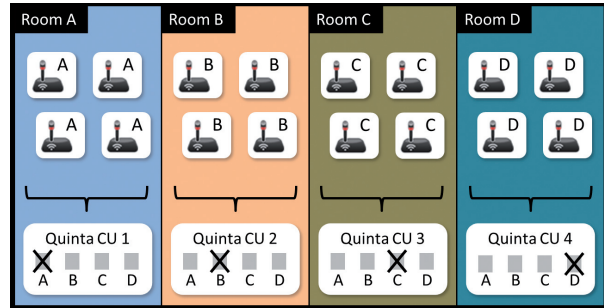

Configuration of control units and microphone units in four different rooms

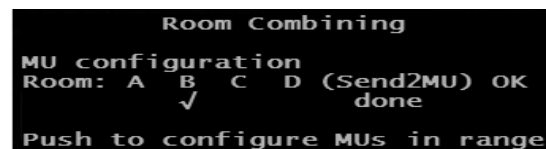
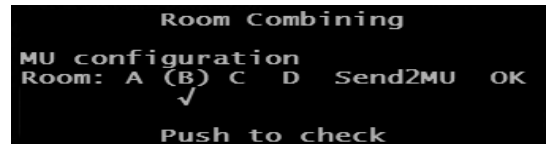
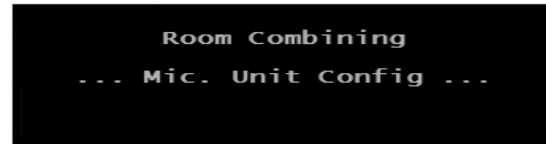
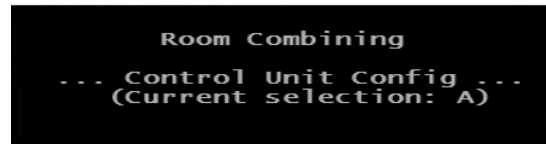
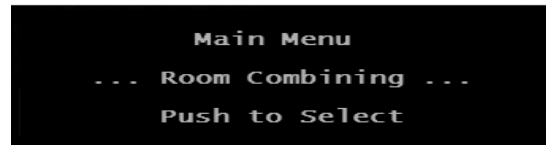

- In order to confirm with “OK” turn the volume control 6 clockwise until “(OK)” is displayed. Press the volume control to confirm and leave the menu.

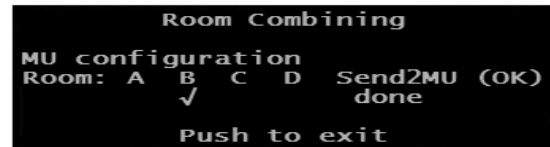

- The default screen still displays “A”.
- As the control unit is still set to “A” (factory setting), the microphone units will lose the radio link to the control unit. The microphone button of the microphone units will flash red.
- In order to configure the control unit to “B” press the volume control 6 approx. 3 seconds until the Quinta CU control unit displays the main menu.



- Turn the volume control 6 to the right or left until “Room Combining” is displayed.

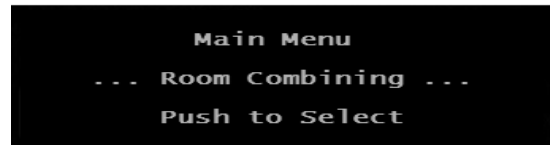

- Press the volume control 6 to enter the submenu.

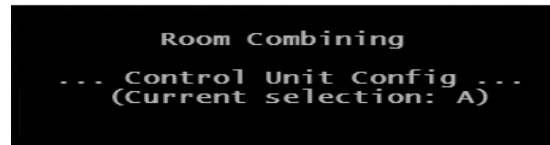

- Press the volume control 6 once again to enter the submenu for configuration of the control unit. For the control unit in room B turn the volume control until “(B)” is displayed and press the volume control to select “B” (it is ticked).

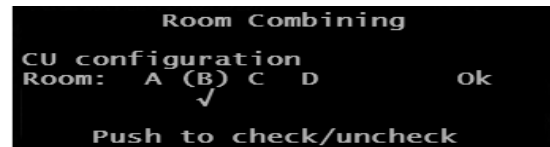

- In order to confirm with “OK” turn the volume control 6 clockwise until “(OK)” is displayed. Press the volume control to confirm and leave the menu.

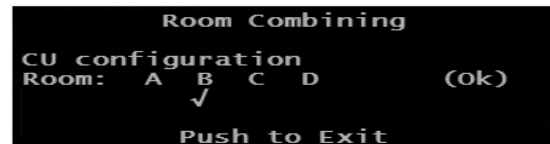

- The default screen displays “B”.
- The microphone units will link to the control unit again. The microphone button will illuminate white.
- Switch off the microphone units and control unit in room B.
- Continue with the configuration of the control units in room C and D as described for room B.

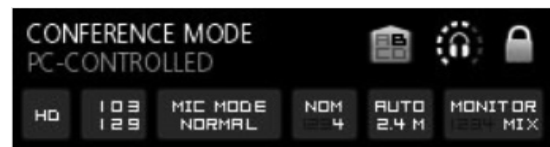

- Should you use the “Room Combining” function again, you do not need to set anything in the “MU Configuration” menu, but only in the “CU configuration” menu. Here you select the rooms you want to combine. The microphone units with the selected room designation will link to the control unit.

**Important:**

- The microphone units in the respective rooms must have a radio link to the control unit.
- The configuration for room A, B, C or D is stored in the appropriate microphone units.
- When you have only one Quinta system which you want to use in one room only, you can keep the factory setting of “A”.

**How to combine different rooms – example**

- In our example the rooms A, B, C are combined.  
In room D a separate system with control unit and microphone units will be operated.
- In order to avoid interference between the systems, you must turn off the control units in room A and C or deactivate the radio module of the control unit via the menu of the control unit or with the Quinta Conference Software via PC by removing all ticks under the “Room Combining” - “CU configuration” menu item.
- The microphone units which are configured for room A, B, C will now link to the control unit in room B.

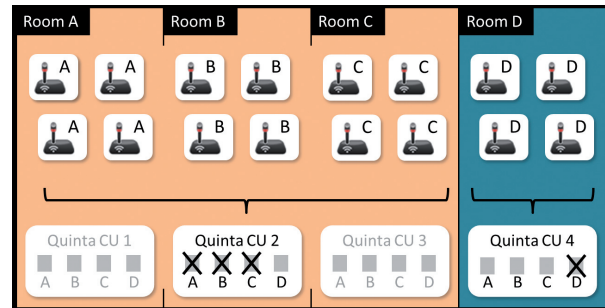

Configuration of control units and microphone units in the combined rooms A, B, C and in room D

- Press the volume control **6** approx. 3 seconds until the Quinta CU control unit displays “Main Menu”.
- Turn the volume control **6** to the right or left until “Room Combining” is displayed.

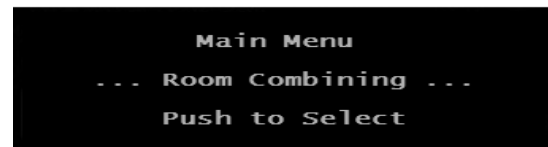

- Press the volume control **6** to enter the submenu.

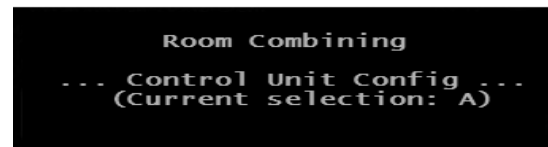

- Press the volume control **6** once again to enter the submenu for the configuration of the Quinta CU control unit. Turn the volume control **6** until “(A)” is displayed and press the volume control **6** to select “(A)” (a tick is displayed under the “A”). Turn the volume control **6** until “(B)” is displayed and press the volume control **6** to select “(B)” (a tick is displayed under the “B”). Turn the volume control **6** until “(C)” is displayed and press the volume control **6** to select “(C)” (a tick is displayed under the “C”).
- Do not activate room D, as this is a separate system in a separate room.
- In room A and C you must turn off the control units or deactivate the radio module of the control unit via the menu of the control unit or with the Quinta Conference Software via PC by removing all ticks under the “Room Combining” - “CU configuration” menu item.
- The microphone units which are configured for room A, B, C will now link to the control unit in room B.

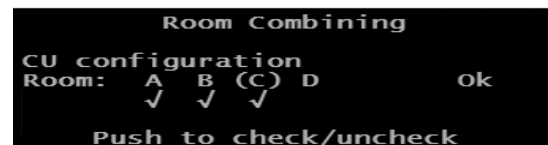

- In order to confirm with “OK” turn the volume control 6 clockwise until “(OK)” is displayed. Press the volume control 6 to confirm and leave the menu.
- The default screen is displayed.

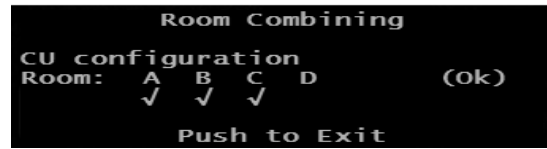

- When you now enter the “Room Combining” menu item, the line “Current selection: A, B, C” is displayed.

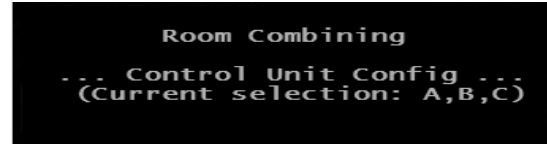

- The default screen also displays A, B, C.

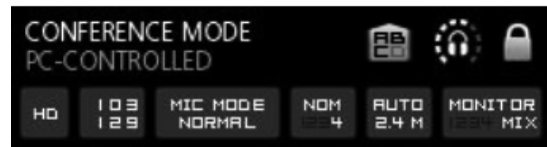

**How to deactivate the radio module of the control unit**

- If the radio module of the control unit is to be deactivated so that there is no radio link between microphone units and control unit, remove all ticks in the menu “Room Combining - CU Configuration”.

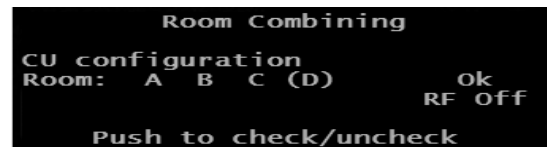

- When you enter the “Room Combining” menu item, the line “Current selection: RF off” is displayed.

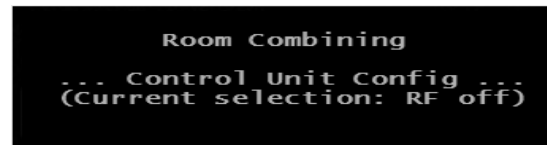

- The default screen also displays “RF off”.

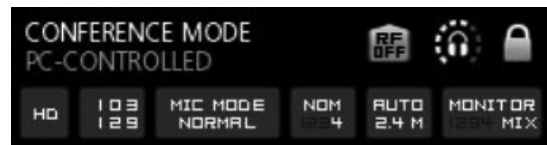

**2.9.3 Ethernet Info**

- Press the volume control 6 approx. 3 seconds until the Quinta CU control unit displays “Main Menu”.
- Turn the volume control 6 to the right or left until “Ethernet Info” is displayed.
- Press the volume control 6 to enter the submenu.
- In the display you can now read all information of the Ethernet connection.
- Press the volume control 6 to leave the menu.
- The default screen is displayed.

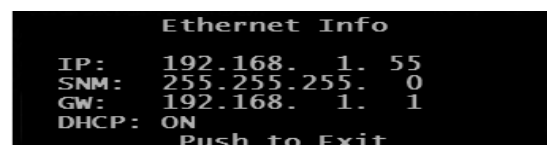
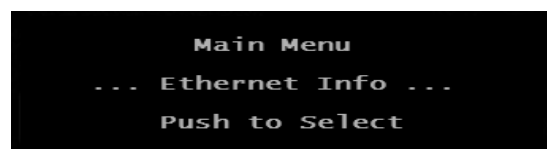

### 2.9.4 AVB Info

- Press the volume control **6** approx. 3 seconds until the Quinta CU control unit displays “Main Menu”.
- Turn the volume control **6** to the right or left until “AVB Info” is displayed.
- Press the volume control **6** to enter the submenu.
- In the display you can now read all information of the AVB connection.
- Press the volume control **6** to leave the menu.
- The default screen is displayed.

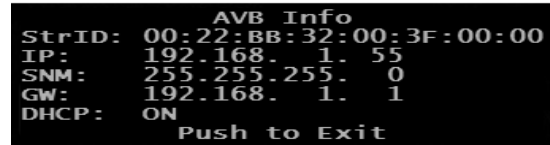
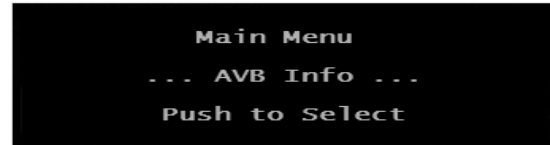

### 2.9.5 RF-Analyzer

- Press the volume control **6** approx. 3 seconds until the Quinta CU control unit displays “Main Menu”.
- Turn the volume control **6** to the right or left until “RF-Analyzer” is displayed.
- Press the volume control **6** to enter the submenu.
- The “RF Anlayzer” displays how much the frequency range is already used by other devices that use the same frequencies (e.g. other Quinta systems, WiFi, etc.) With “RF-Analyzer” you can find out which frequency band is most suitable.
- To interpret the displayed values correctly, a detailed knowledge about other wireless technologies is required. A WiFi network, for example, is only displayed with higher values when data traffic is actually used. It is not displayed of which type of wireless technology the devices are that show values. The bars are an indicator that indicate the current wireless energy / time on the specific frequencies.
- Press the volume control **6** to leave the menu.
- The default screen is displayed.

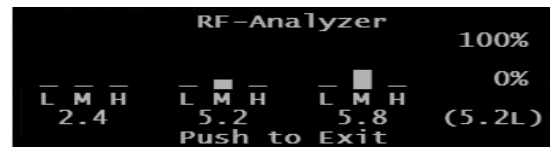
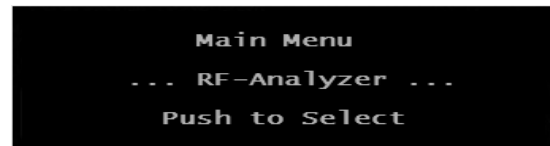

### 2.9.6 Firmware Versions

- Press the volume control **6** approx. 3 seconds until the Quinta CU control unit displays “Main Menu”.
- Turn the volume control **6** to the right or left until “Firmware Versions” is displayed.
- Press the volume control **6** to enter the submenu.
- The firmware versions of Core, DSP, AVB, Web Server and PnP are displayed.
- Press the volume control **6** to leave the menu.
- The default screen is displayed.

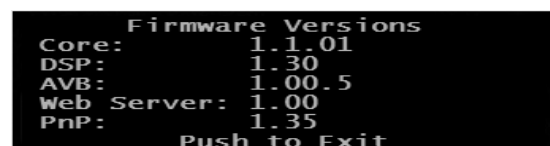
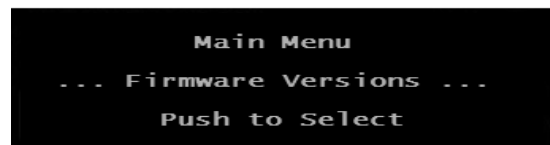



### 3. Quinta MU Microphone Units

For the Quinta conference system there are different microphone units available:

- Quinta MU 23 chairman microphone unit with three buttons (microphone, clear, function)
- Quinta MU 22 double delegate microphone unit with two microphone buttons
- Quinta MU 21 delegate microphone unit with one microphone button
- Quinta MU 33 chairman microphone unit with Revoluto technology, three buttons (microphone, clear, function) and two buttons for volume control of the headphone output
- Quinta MU 31 delegate microphone unit with Revoluto technology, one microphone button and two buttons for volume control of the headphone output

The Quinta MU 21/22/23 microphone units are provided with a locking XLR connection for removable gooseneck microphones of the

Classis GM 31x Q series, 3-colour backlit buttons, braille above the buttons, an integrated wideband loudspeaker with equalization and a headphone output with volume control.

The Quinta MU 31/33 microphone units are provided with the Revoluto technology for maximum freedom of movement and 3-colour backlit buttons, braille above the buttons, an integrated two-way loudspeaker with equalization and two buttons for volume control of the headphone output.

- Each microphone unit is programmed at the factory with an individual worldwide unique device ID so that the Quinta CU control unit can control the microphone units.
- Each microphone unit is addressed with this individual device ID in the transmission protocol via radio transmission.

The Quinta MU 21/22/23 microphone units are provided with a locking XLR connection for removable gooseneck microphones of the



**Important:**

- The charging contacts of the microphone units can cause damages, injuries or fire damages if they come into contact with conductive materials such as jewellery, keys or chains. This can lead to a closed circuit and heat up the material.

- If the microphone units are to be operated by an external power supply, you can use the CA 2459 mains charger adapter.
- **To align the gooseneck microphone of the Quinta MU 21/22/23 microphone units and to avoid twisting it too far and causing premature wear, the gooseneck must not be bent further than an angle of 90° at maximum.**

#### 3.1 Controls and Indicators

- ① Power on and operating control LED
- ② DC socket for charging the rechargeable batteries of the microphone unit or for DC operation
- ③ Charging contacts for charging in the CD 2 charger (Quinta MU 23/22/21) or CD3 (Quinta MU 33/31)
- ④ Headphone connection
- ⑤ Volume control for headphone connection

**Quinta MU 23/22/21  
Rear View**

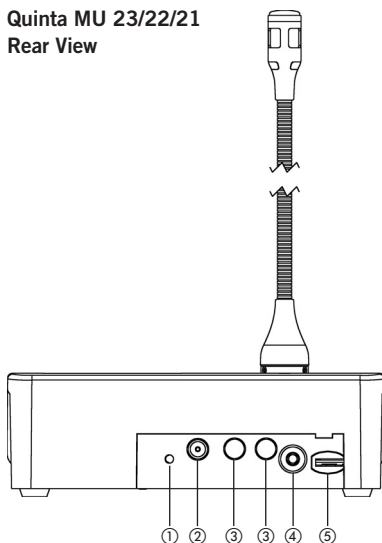

**Quinta MU 33/31  
Rear View**

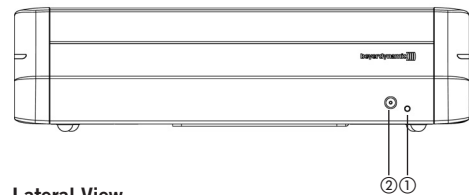

**Lateral View**

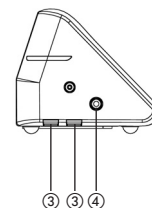

**Front View**

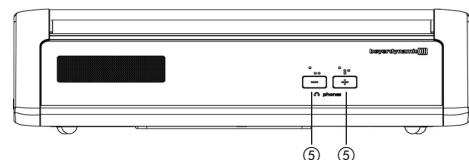

Quinta MU 23 Chairman Microphone Unit

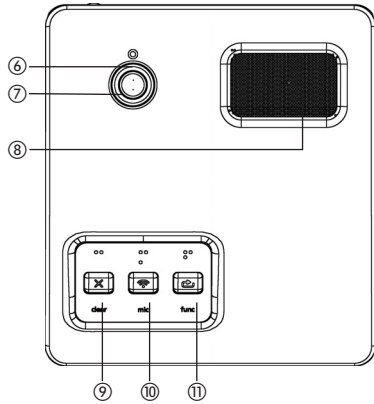

Quinta MU 23 V Chairman Microphone Unit

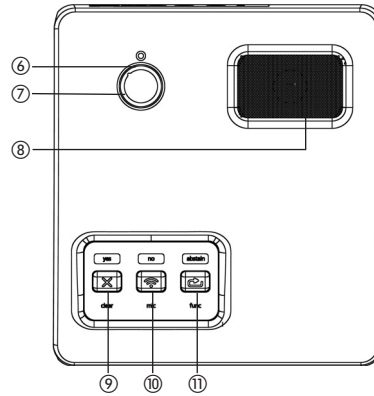

Quinta MU 22 Double Delegate Microphone Unit

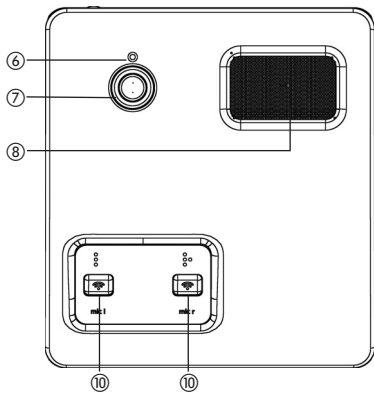

Quinta MU 21 Delegate Microphone Unit

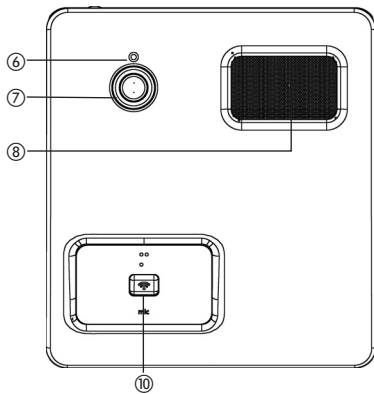

Quinta MU 21 V Delegate Microphone Unit

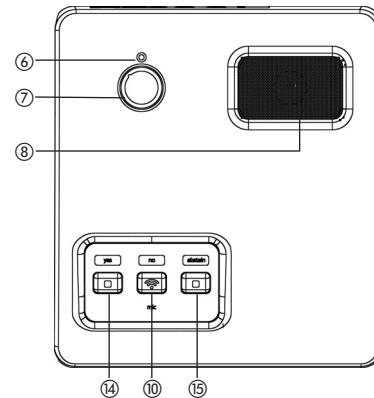

Bottom of Microphone Unit Quinta MU 23/22/21

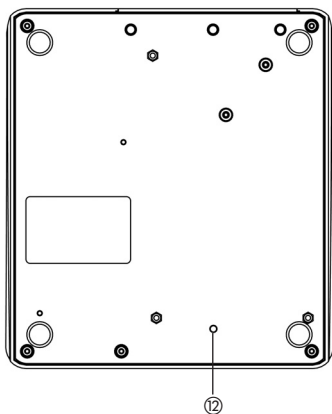

- ⑥ Opening for unlocking the gooseneck microphone
- ⑦ Connection for gooseneck microphone
- ⑧ Loudspeaker
- ⑨ “Clear” button to clear all delegate microphone units / **Attention:** Only with **Quinta MU 23 V** this button acts also as “yes” voting button
- ⑩ Microphone button / **Attention:** Only with **Quinta MU 23 V / MU 21 V** this button acts also as “no” voting button
- ⑪ Programmable function button / **Attention:** Only with **Quinta MU 23 V** this button acts also as “abstain” voting button
- ⑫ Reset button to restart the integrated microcontroller (refer also the item “Microphone unit cannot be switched off” in chapter 7. “Trouble Shooting”)
- ⑭ “yes” voting button with Quinta MU 21 V
- ⑮ “abstain” voting button with Quinta MU 21 V

**Quinta MU 33 Chairman Microphone Unit**

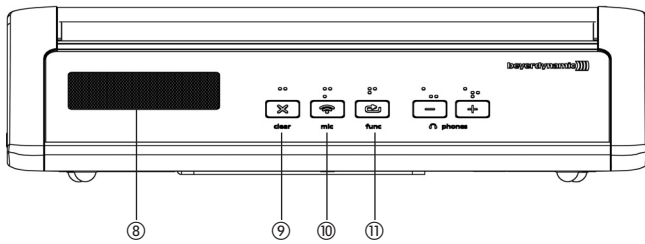

**Quinta MU 31 Delegate Microphone Unit**

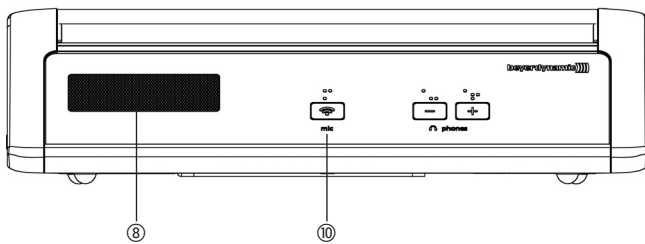

**Bottom of Microphone Unit Quinta MU 33/31**

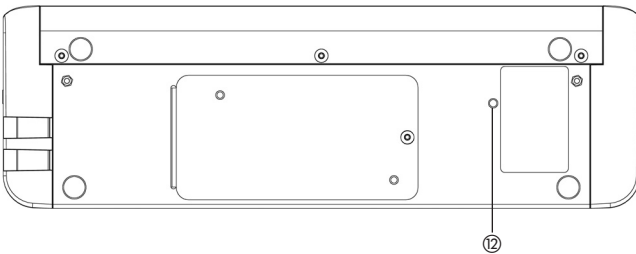

**Lateral View**

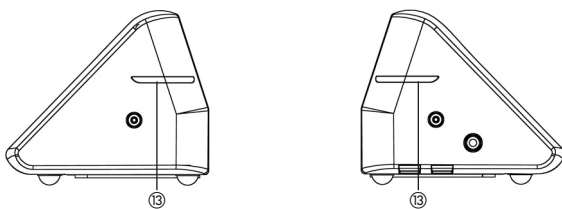

- ⑧ Loudspeaker
- ⑨ "Clear" button to clear all delegate microphone units
- ⑩ Microphone button
- ⑪ Programmable function button
- ⑫ Reset button to restart the integrated microcontroller (refer also the item "Microphone unit cannot be switched off" in chapter 7. "Trouble Shooting")
- ⑬ LED strips

### 3.2 How to Connect the Gooseneck Microphone to Quinta MU 21/22/23

The following gooseneck microphones with an LED are available to connect to the microphone unit.

- Classis GM 313 Q; 300 mm [11.81"] in length
  - Classis GM 314 Q; 400 mm [15.75"] in length
  - Classis GM 315 Q; 500 mm [19.69"] in length
  - Classis GM 316 Q; 600 mm [23.62"] in length
- Take the gooseneck microphone by the shaft, put it into the connection for gooseneck microphones ⑦ and press the shaft downwards until it locks in place.
  - If you want to remove the gooseneck microphone, press into the opening for unlocking the gooseneck microphone ⑥ with the supplied tool or a similar thin tool. Remove the gooseneck microphone by taking it by the shaft and pulling.

### 3.3 Switching On / Off

#### How to switch on and allocate the microphone units

- The microphone unit is switched on by pressing the microphone button ⑩ will light up for a moment and the operating control LED ① on the rear will illuminate green. When the connection to the Quinta CU control unit has been established, the buttons of the microphone unit will illuminate white.
- To activate the microphone or to allocate the microphone unit to a free channel of the Quinta CU control unit, press the microphone button ⑩ once again. Depending on the operating mode, the microphone button will illuminate green (normal operating mode) or red (request-to-speak mode).

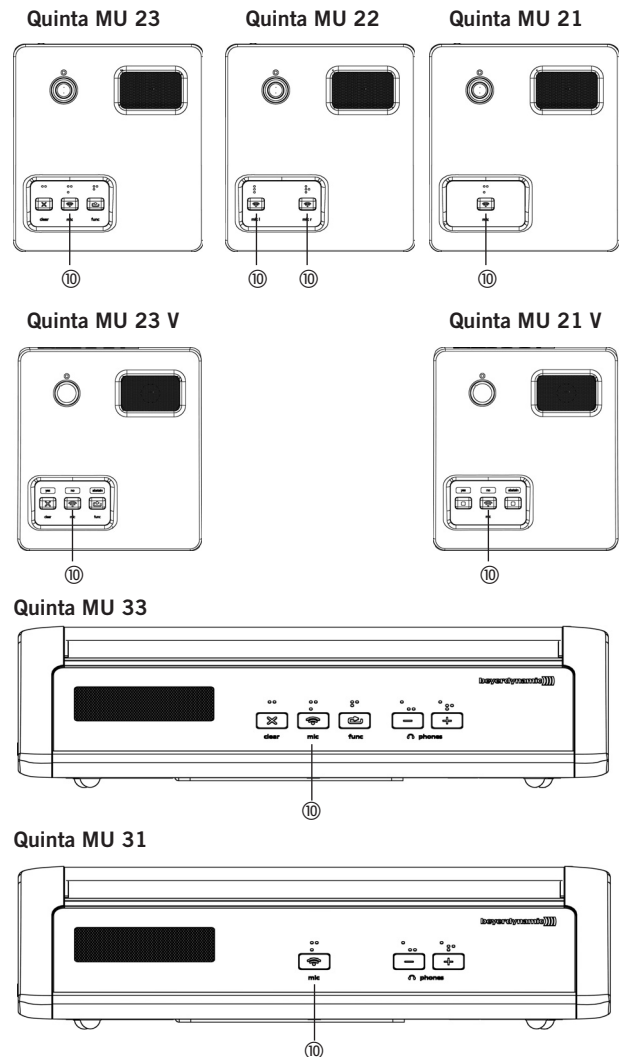

#### Switching off

- By pressing the microphone button ⑩ for more than 2 seconds the microphone unit is switched off.
- If you press the standby button ④ of the Quinta CU control unit for more than 3 seconds, you switch off all the active Quinta MU microphone units within the range of the Quinta CU control unit.
- Furthermore, the microphone units are switched off automatically, when they do not receive a signal from the Quinta CU control unit for more than 3 minutes.

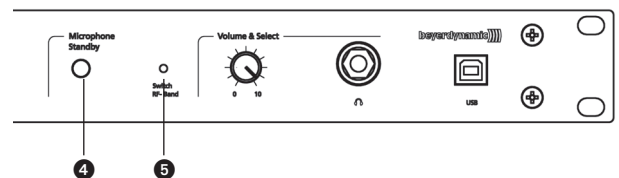



**Important:**

- With the Quinta Conference software you can deactivate the manual switching off of the microphone unit.
- If the microphone unit is out of range of the control unit or does not have the correct PIN code, the microphone button ⑩ will flash red. After approx. 3 minutes the microphone unit will switch off automatically.
- Should the system fail to operate, i.e. the microphone unit is switched on, but no sound is heard, check the audio settings with the Quinta Conference software. If RF problems occur the microphone button ⑩ will flash red. Should the system still fail to operate, please contact your beyerdynamic representative.

**Function Test**

You can test if the microphone units are operating:

- Connect a headphone to the Quinta CU control unit ⑦.
- Turn the control ⑥ to set the volume and press the control ⑥ several times until you have listened to all channels (i.e. 4 channels).

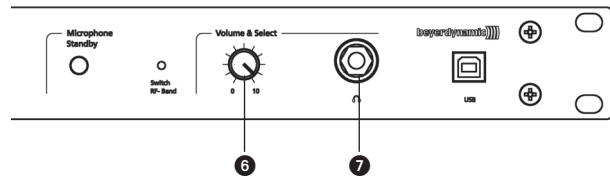

**3.4 Powering / Operating Time**

- The microphone units have an integrated rechargeable battery allowing a minimum operating time of 20 hours when fully charged.
- When the battery charge is too low for a satisfactory operation, the operating control LED ① on the rear of the microphone unit will flash. The remaining time of operation will be around 60 minutes.
- The charging state of the microphone units can be displayed with the Quinta Conference software on a PC connected to the Quinta CU control unit or via the integrated web server. Furthermore, it can be displayed on an external media control system connected to the Quinta CU control unit.

**Quinta MU 23/22/21  
Rear View**

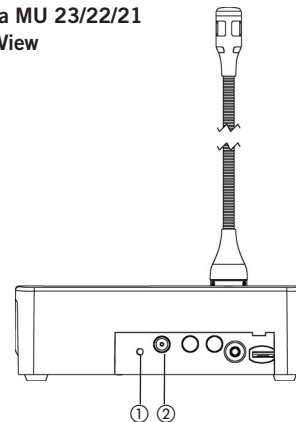

**3.5 Powering with CA 2459 Mains Power Adapter**

- The Quinta MU microphone units can also be powered via the external CA 2459 mains charger adapter, which is connected to the DC socket ② on the rear of the microphone unit.
- While the CA 2459 mains charger adapter is connected, the rechargeable battery of the microphone unit is charged. Refer also to chapter 6. “Battery Charging with External Mains Power Adapter”.

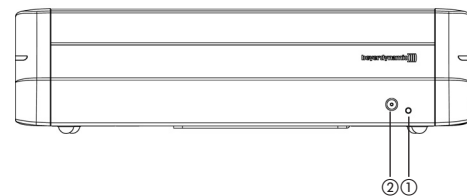

**Quinta MU 33/31 – Rear View**



### 3.6 Operating Modes

The different operating modes such as “Normal”, “Push-To-Talk” or “Voice Activation” are adjusted with the Quinta Conference software for all microphone units. The standard operating mode is “Normal”. Please refer also to the appropriate “Quinta Conference Software” or “Quinta Web Server” manual.

#### 3.6.1 Normal Operating Mode

- Press the microphone button  to switch on the microphone.
- The red LED of the gooseneck microphone will illuminate and the microphone button  will illuminate green: The microphone is ready to speak into it.
- Using the Quinta CU control unit, up to 4 participants (e.g. 3 delegates and 1 chairman) can speak simultaneously depending on the setting.



**Important:**  
If the number of open microphones is exceeded, a microphone can only be switched on manually when another microphone unit has been switched off.

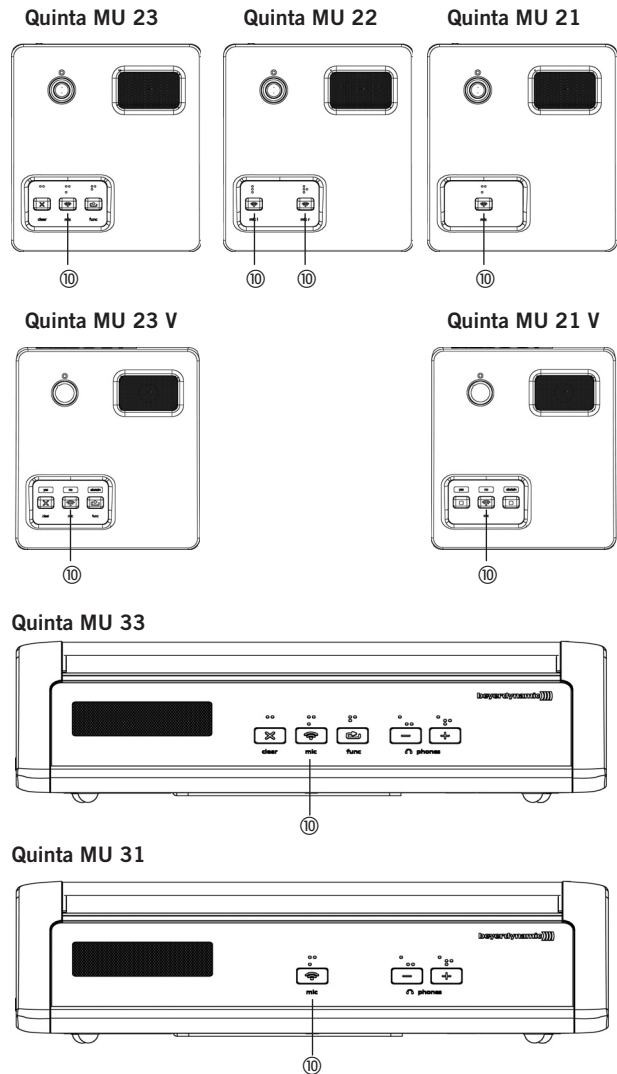

#### 3.6.2 FiFo Mode

- If the microphone units operate in the FiFo mode (first in - first out), the microphone unit that was switched on first, will be switched off, when another microphone unit is switched on and the number of open microphones (NOM) will be exceeded.

#### 3.6.3 Push-To-Talk Mode

- If the microphone units operate in the Push-To-Talk mode (PTT), the microphone button must be pressed as long as someone speaks into the microphone. This configuration is recommended for short interruptions during the meeting.

#### 3.6.4 Voice Activation Mode

- If the microphone units operate in the Voice Activation mode, the microphone units are switched on via voice control. That is the microphone unit is switched on as soon as someone speaks into the microphone. In this case it is not necessary to press the microphone button.



**Important:**  
The threshold and the hold time can be configured with the “Quinta Conference” software for all microphone units.

### 3.7 Maintenance of the Microphone Units

- For cleaning the Quinta MU microphone units when they are slightly dirty (finger prints, dust, jam or juice) use a soft, damp cloth, sponge or brush and mild liquid cleaning agent (e.g. washing-up liquid). Do not use any solvent containing cleaners.
- Make sure not to allow any water to enter the microphone capsule or housing.

- Clean the charging contacts with spirit or isopropyl alcohol from time to time. While cleaning avoid contact with the painted surface.
- Clean the pop shield of the gooseneck microphone for Quinta MU 21/22/23 with clear, warm water. Make sure that it is completely dry before you put it on the microphone again.

### 4. Programmable Functions of the Microphone Units with the Quinta Conference Software

The functions of the microphone units described in the following are only available, when they have been programmed with the Quinta Conference software before. Please refer to the “Quinta Conference Software” manual.

### 4.1 Security Code

By using the Quinta Conference software you can enter an alphanumeric code for the Quinta MU microphone units and the Quinta CU control unit within one system. This will increase the safety against unauthorised listening. Microphone units, which do not have this code are not recognised by the control unit and will be deactivated.

### 4.2 Programmable Function Button of the Chairman Microphone Unit

Depending on the configuration the following functions are possible with the function button ⑩: mute, clear or priority. The function button can be configured via the control unit with the Quinta Conference software.

1. **Normal**  
All active delegate microphone units will be cleared and the microphone of the chairman unit will be switched on. The delegates can switch on their microphones again, when the chairman switches off his microphone.
2. **Mute**  
All active delegate microphone units will be muted when the chairman is speaking and will be reactivated when the chairman switches off his microphone.
3. **Clear**  
All active delegate microphone units are cleared and can be switched on afterwards.
4. **How to Mute Audio IN ports**  
First push mutes the port, the next one enables it, third one mutes again etc.  
If the chairman presses the function button, the audio input of the Quinta CU control unit will be muted. The function button ⑩ illuminates red.

Quinta MU 23

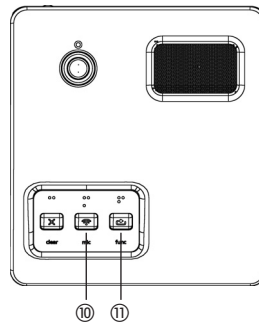

Quinta MU 23 V

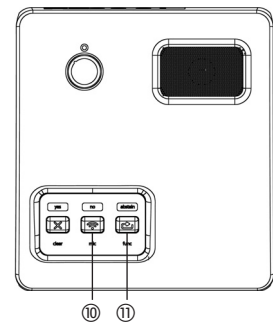

Quinta MU 33

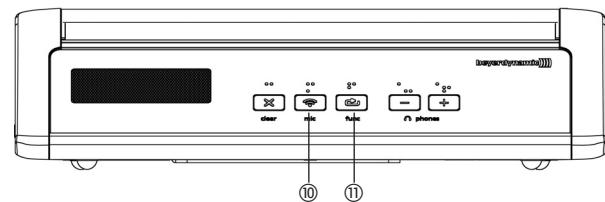

5. **How to Mute Audio IN ports** and clear all active delegate units  
 By pressing the function button a second time, mute is released. By pressing the function button a third time, the audio input is muted again and all active delegate units will be cleared etc.  
 The function button ⑩ illuminates red.
  
6. **How to Mute Audio OUT ports**  
 First push mutes the port, the next one enables it, third one mutes again etc.  
 If the chairman presses the function button of his/her microphone unit, the audio output of the Quinta CU control unit will be muted. The function button ⑩ illuminates red.
  
7. **“RS 232 Message” Function**  
 A command is sent via the RS 232 serial interface from the Quinta CU control unit and a programmed function is carried out via a media control system for instance (e.g. light control). At the same time a command is also sent for other functions via the RS 232 serial interface from the Quinta CU control unit.
  
8. **Command A/B**  
 Two different commands according to the duration of the push of the function button.  
 < 1 second = command “Short press string” is transmitted  
 > 1 second = command “Long press string” is transmitted  
 These commands can be set individually with the Quinta Conference software.

Quinta MU 23

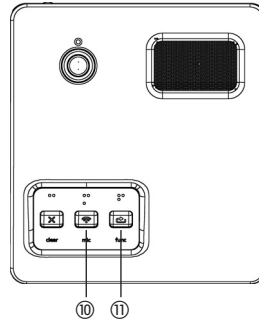

Quinta MU 23 V

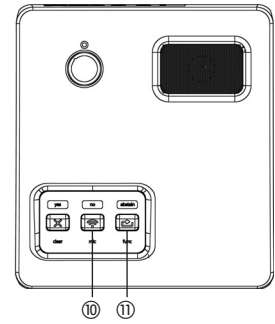

Quinta MU 33

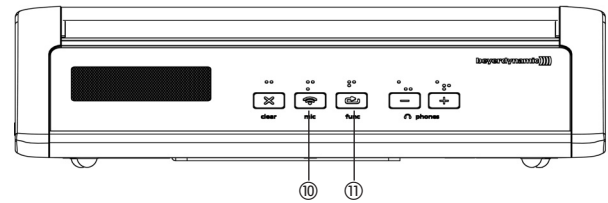



### 4.3 Request-to-Talk Mode

- This operating mode is only possible in conjunction with a PC using the Quinta Conference software or a media control system (AMX®, Crestron®, Cue etc.).
- The request-to-talk is registered in the system by pressing the microphone button ⑩ of the microphone unit.
- The allocation is made by the operator at the PC or touch screen of the media control system.
- The microphone button ⑩ is illuminated red to indicate the request-to-talk.
- If you press the microphone button ⑩ again, the request-to-talk is cleared. The backlit microphone button ⑩ will illuminate white.

Quinta MU 22 Double Delegate Microphone Unit

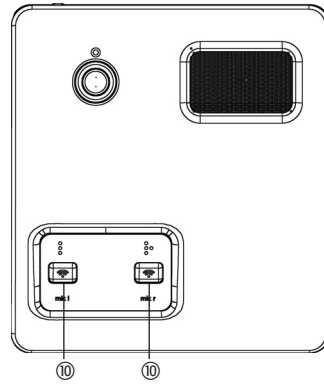

Quinta MU 21 Delegate Microphone Unit

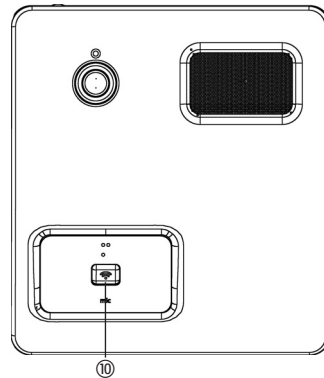

Quinta MU 21 V Delegate Microphone Unit

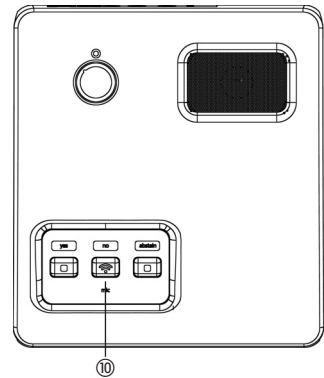

Quinta MU 31 Delegate Microphone Unit

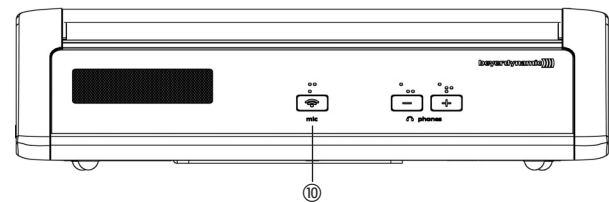

**5. Quinta CD 2 Charger in the Quinta CC 2 | CC 2 / 600 Case and Quinta CD 3 in the Quinta CC 3 Case**

Quinta CC 2 is a modular charging and transport case for the Quinta MU 23/22/21 microphone units. The basic version the Quinta CC 2 consists of a top cover (Quinta CT 2), a charger (Quinta CD 2) for 10 Quinta MU 23/22/21 microphone unit and a bottom with casters (Quinta CW 2). This version is suitable for Quinta MU 23/22/21 microphone units using the Classis GM 313 Q, GM 314 Q and GM 315 Q microphones.

For microphone units using the Classis GM 316 Q microphone the version Quinta CC 2 / 600 with a higher top cover (Quinta CT 2 / 600) will be available.

Quinta CC 3 is a modular charging and transport case for the Quinta MU 33/31 microphone units. The basic version the Quinta CC3 consists of a top cover (Quinta CT 2), a charger (Quinta CD 3) for 12 Quinta MU 33/31 microphone unit and a bottom with casters (Quinta CW 2).

- With the Quinta CD 2 charger integrated in the Quinta CC 2 or CC 2 / 600 case you can charge a maximum of 10 Quinta MU 23/22/21 microphone units with the Classis GM 313 Q, 314 Q, 315 Q or Classis GM 316 Q microphone. With the Quinta CD 3 charger integrated in the Quinta CC 3 case you can charge a maximum of 12 Quinta MU 33/31 microphone units. The charging state can be seen from the outside through a glass panel.
- The Quinta CC 2 or CC 3 charging and transport case can be extended with another Quinta CD 2 or CD 3 charger for 10 or 12 microphone units. Because of a possible instability more than two Quinta CD 2 or CD 3 chargers must not be piled up. Quinta CD 2 chargers that contain microphone units with the Classis GM 316 Q microphone cannot be piled up because of the microphone length.
- For the Quinta CC 2 or CC 2 / 600 or CC 3 charging and transport case there is an optional compartment available for storing the Quinta CU control unit and accessories such as cables and gooseneck microphones.

**5.1 Charging Process**

1. Connect the charger to AC power and switch it on. The switch will illuminate.
2. Put the switched-off microphone units into the charging compartments. If microphone units are switched on, they are switched off automatically. When the microphone units are used again, they must be switched on by hand.
3. The charging process is indicated by the LED of the gooseneck and can be seen from the outside through a glass panel.

- LED indicator when the batteries are recharged:
- a) Gooseneck LED or LED strips are flashing red. . . . . Battery is charged
  - b) Gooseneck LED or LED strips illuminates red permanently. . . . . Battery is completely full
  - c) Gooseneck LED or LED strips are flashing red rapidly . . . . . Error



**Note:**

- If an error has occurred, try to restart the charging process. If the LEDs are still flashing rapidly, please contact your beyerdynamic dealer.
- For a reliable charging of the rechargeable batteries and in order to avoid long-term damages the ambient temperature must not exceed +35 °C [95 °F] during charging.

- After some time the capacity of the rechargeable batteries is reduced technically. This will reduce the operating time.
- It is normal that the rechargeable batteries are heated up during the charging process.
- Clean the charging contacts with spirit or isopropyl alcohol from time to time. While cleaning avoid contact with the painted surface.

**5.2 Notes for Microphone Units and Rechargeable Batteries**

- To achieve a 100% battery capacity of the rechargeable batteries, all microphone units should have 2 complete charging cycles (charging and discharging) at least. Only after several charging and discharging cycles, the rechargeable batteries will achieve their full capacity.
- The Quinta MU microphone units are provided with high-performance nickel-metal hydrid (NiMH) batteries. These guarantee operating times of approx. 20 hours. It takes about 2.5 hours to charge them.
- The service life of the batteries largely depends on the manner in which they are looked after and on how well the user recharges them. To extend the service life of the batteries for as long as possible, the following charging cycle is recommended:
  - Do not keep the microphone units in the charging case when it is switched on.
  - Only put the microphone units in the charging case before a conference / application and fully charge them until the “fully charged” status is shown.
  - In particular, when the microphone units are inserted, the charging case should not be constantly switched on and off. For each charging cycle, there is an initial 5-minute charge to

check the battery status. If the case with the microphone units is switched on every day (for example, because the mains is switched off automatically or by a cleaner), the microphone units will be slowly but constantly overcharged and this will damage the batteries.

- The NiMH batteries used minimise the so-called “memory effect”, but their capacity is reduced when they are only partially discharged on a regular basis. For this reason, the microphone units should be fully discharged every three months until they switch off automatically. They can then be fully recharged. This procedure can, if necessary, be repeated a second time.
- If, despite this measure, the microphone unit does not operate for a sufficiently long period of time, the battery has reached the end of its service life and must be replaced. The typical service life of the battery is greatly dependent on whether or not the above points are observed. This is why batteries are not covered by warranties. If the above points are observed, a battery typically has a service life of at least two years or 500 complete charging cycles, depending on which occurs first.

**6. Battery Charging with External Mains Power Adapter**

- The Quinta MU microphone units can also be charged with the external CA 2459 mains power adapter, which is connected to the DC socket ②.
- The operating control LED ① will indicate the charging process:  
LED indicator when the batteries are recharged:  
a) LED is flashing red . . . . . Battery is charged  
b) LED illuminates red permanently . . . Battery is completely full  
c) LED is flashing red rapidly. . . . . Error



**Important:**

- After some time the capacity of the rechargeable batteries is reduced technically. This will reduce the operating time.
- It is normal that the rechargeable batteries are heated up during the charging process.
- When the battery is completely empty, the charging time is around 2.5 hours.
- If the microphone unit is switched on during the charging process, the LED ① will illuminate green.

**Quinta MU 23/22/21  
Rear View**

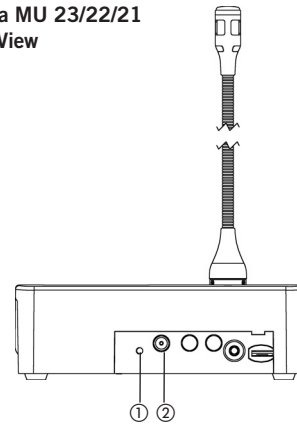

**Quinta MU 33/31 – Rear View**

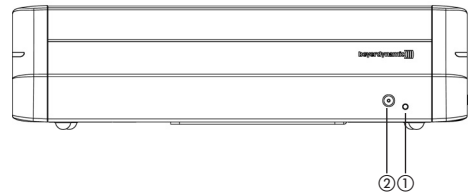

## 7. Quinta TH Handheld Transmitter

The Quinta TH handheld transmitter complements the Quinta conference system. The Quinta TH is provided with a button containing braille inscription to turn the transmitter or microphone on or off. By using the Quinta Conference Software the Quinta TH handheld transmitter can be configured as sub chairman or delegate. The Quinta TH is compatible to the 2.4, 5.2 and 5.8 GHz frequencies.

**Important:** Please note that for an optimal operation without dropout, especially in the 5 GHz range, a direct line-of-sight between the Quinta CU control unit and the Quinta TH handheld transmitter is necessary.

### 7.1 Controls and Indicators

- ① Thread to attach the microphone head
- ② Microphone button with braille inscription
- ③ Battery compartment cover
- ④ Antenna
- ⑤ Battery compartment
- ⑥ Battery indicator
- ⑦ Charging contacts

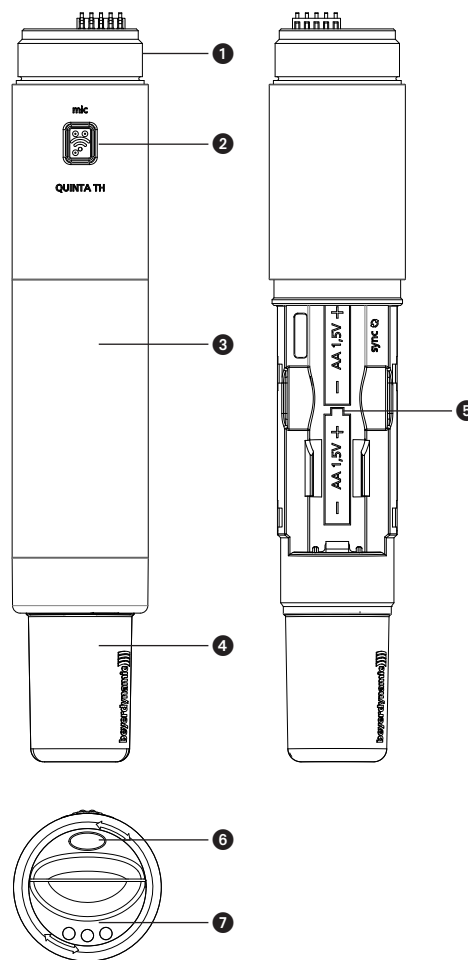

### 7.2 How to Attach the Microphone Head

For the Quinta TH handheld transmitter there are different condenser and dynamic microphone capsules available. The microphone head used is also displayed in the participant list of the Quinta Conference Software. Refer also to “Optional Accessories”.

- Put the requested microphone head onto the thread of the handheld transmitter and tighten it clockwise.
- If you want to change the microphone head, unscrew it from the transmitter by turning it anti-clockwise.
- Make sure that you switch off the handheld transmitter before changing the microphone head.

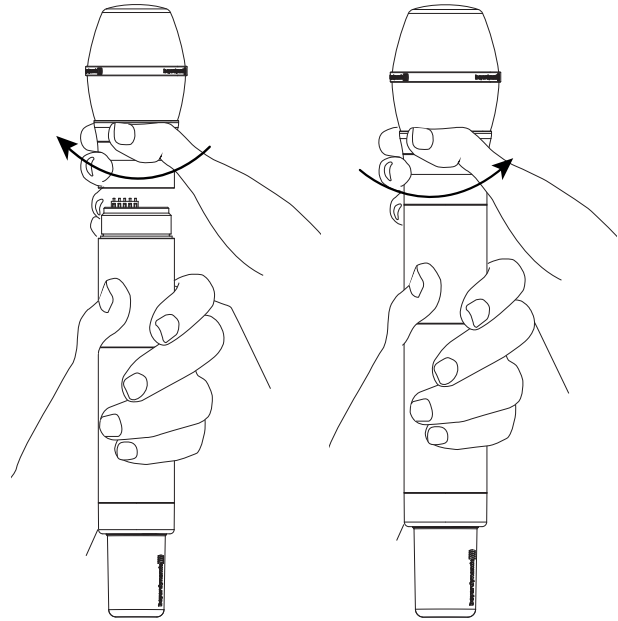

Tighten microphone head clockwise.

Remove microphone head by turning it anti-clockwise.

#### TG V50w

Dynamic microphone head with cardioid polar pattern. Very wide pick-up area, High gain before feedback.

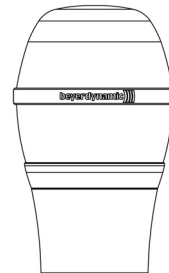

#### TG V56w

Condenser microphone head with cardioid polar pattern. Discreet treble boost. High gain before feedback. For conferences and announcements.



#### TG V96w

Condenser microphone head with cardioid polar pattern. For vocals. Uncoloured reproduction. Discreet treble boost for an open and unobtrusive sound. High gain before feedback.



### 7.3 How to Insert the Batteries

For operating the Quinta TH handheld transmitter you can use two NiMH or alkaline (AA LR 6 Mignon) batteries.

- Unscrew the cover of the battery compartment as indicated by the arrow.
- Slide the cover of the battery compartment downwards.
- Insert two NiMH rechargeable batteries or alkaline batteries (AA LR 6 Mignon) according to the symbols in the battery compartment.
- Slide the cover of the battery compartment upwards again and tighten it.
- When the battery indicator at the bottom of the transmitter starts to flash, the remaining operating time will be approx. 1 hour depending on the battery type used.
- From time to time you should clean the battery and charging contacts of the Quinta TH transmitter with a soft lint-free cloth moistened with white spirit or alcohol. Please remove the batteries from the battery compartment before cleaning.

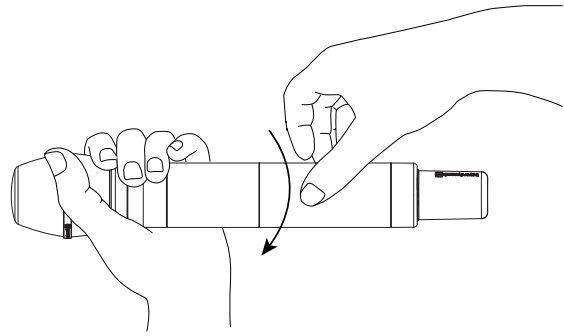

Unscrew cover of battery compartment and remove it.

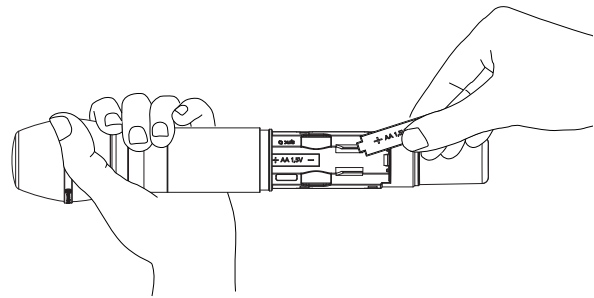

Insert batteries according to the +/- symbols into the battery compartment.

### 7.4 Switching On/Off

#### Switching on and allocating the transmitter

- The handheld transmitter is switched on by pressing the microphone button ②. When the connection to the Quinta CU control unit has been established, the microphone button ② will illuminate white to indicate the operating state.
- In order to activate the microphone or to allocate the microphone to a free channel of the Quinta CU control unit, press the microphone button ② briefly once again. Depending on the operating mode, the microphone button ② will illuminate green (normal operating mode) or red (request-to-speak mode).

#### Switching off

- By pressing the microphone button ② (approx. 3 seconds) the handheld transmitter is switched off.
- If you press the standby button of the control unit for more than 3 seconds, the handheld transmitter will be switched off.
- Furthermore, the handheld transmitter will be switched off automatically, when it does not receive a signal from the Quinta CU control unit for more than 3 minutes.

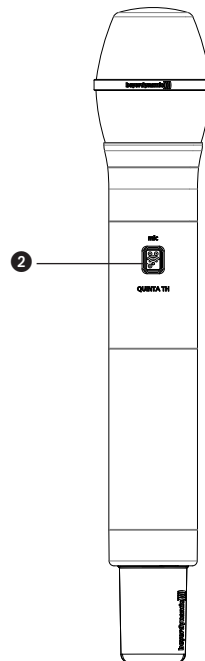

## 7.5 Operating Modes

### Normal

- Press the microphone button to switch on the handheld transmitter. The button will illuminate white to display the ready operating status.
- To activate the microphone, press the microphone button once again. The microphone button will illuminate green. The microphone is ready to speak into it.
- Using the Quinta CU control unit, up to 4 participants (e.g. 3 delegates and 1 chairman) can speak simultaneously depending on the setting.



#### Important:

**If the number of open microphones is exceeded, a microphone can only be switched on manually when another microphone has been switched off.**

- By pressing the microphone button for more than 3 seconds the handheld transmitter is switched off. The microphone button does not illuminate anymore.

### FiFo mode (First in – First out)

- If the microphones operate in the FiFo mode (first in - first out), the microphones that was switched on first, will be switched off, when another microphone is switched on and the number of open microphones (NOM) will be exceeded.

### Push-To-Talk mode

- If the microphones operate in the Push-To-Talk mode (PTT), the microphone button must be pressed as long as someone speaks into the microphone. This configuration is recommended for short interruptions during the meeting.

### Voice Activation mode

- If the microphones operate in the Voice Activation mode, the microphones are switched on via voice control. That is the microphone is switched on as soon as someone speaks into the microphone. In this case it is not necessary to press the microphone button.



#### Important:

**The threshold and the hold time can be configured with the “Quinta Conference Software” for all microphones.**

### Request-to-Speak mode

- This operating mode is only possible in conjunction with a PC using the Quinta Conference software or a media control system (AMX®, Crestron®, Cue etc.).
- The request-to-speak is registered in the system by pressing the microphone button of the microphone unit.
- The allocation is made by the operator at the PC or touch screen of the media control system.
- The microphone button is illuminated red to indicate the request-to-speak .
- If you press the microphone button again, the request-to-speak is cleared. The backlit microphone button will illuminate white.

### 7.6 Maintenance

- Protect the handheld transmitter from humidity, knocks and shock. Avoid dropping the transmitter at all times.
- For cleaning metal surfaces, use a soft cloth moistened with methylated spirits or alcohol.
- As soon as your microphone sounds dull, you should clean the integrated pop shield. Proceed as described in the following.
  - Unscrew the microphone grille anti-clockwise.
  - Pull out the foam pop shield, if necessary use tweezers and clean it under clear running water.
  - If necessary, use a mild washing-up liquid.
  - Dry it afterwards with a hairdryer or allow it to dry overnight.
  - Clean the microphone grille both inside and out with a slightly moistened cloth or a soft brush under clear running water and allow it to dry overnight.
  - The microphone grille **cannot** be cleaned in a dishwasher.
  - Place the dry pop shield inside the microphone grille and replace the microphone grille by screwing it on clockwise.

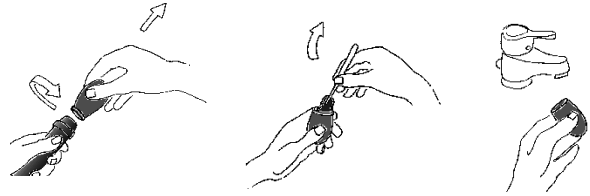

- The **TG V96w** is provided with a mesh pop shield.
- For cleaning turn the microphone grille anti-clockwise to unscrew.
- Turn the wire mesh pop shield anti-clockwise to unscrew.
- Clean the pop shield under clear running water.
- Allow the pop shield to dry overnight before you replace it.
- The wire mesh pop shield **cannot** be cleaned in a dishwasher.
- Clean the microphone grille inside and outside with a slightly moistened cloth or a soft brush under clear running water and allow it to dry overnight.
- The microphone grille **cannot** be cleaned in a dishwasher.

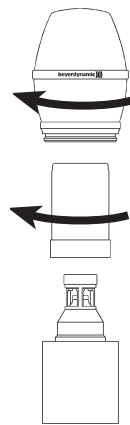

TG V96w



### 7.7 Charging

If the Quinta TH handheld transmitter is operated with NiMH batteries, you can recharge it with the WA-CD charger. The rechargeable batteries can remain inside the transmitter or be charged separately. For a detailed description on the operation, please refer to the separate manual for the “WA-CD” charger.

- Mount the appropriate power plug to the power adaptor.
- Connect the power adaptor to the charger and to the mains.
- The charger provides no separate on/off switch and will start up automatically.
- The charging lights of the battery compartments will illuminate white to indicate the ready operating status of the device.
- If required, connect the Ethernet port to a media control system.

- Put the Quinta TH handheld transmitter or the NiMH batteries into the charging compartments as indicated in the drawing. If the transmitter is turned on, it will be turned off automatically. Make sure to insert the NiMH batteries into the charging compartments as indicated by the +/- marks.

**Important:** Before charging please make sure that there are no **non-rechargeable** alkaline batteries in the transmitter. The simultaneous use of different batteries (alkaline and NiMH) in one transmitter is not suitable for operating the transmitter, furthermore these transmitters should not be charged, because transmitter and charger could be damaged. In this case the guarantee will be invalidated.

Each charging compartment is controlled separately. The appropriate indicators display the charging process.

- Indicator illuminates white. . . . The charging compartment is ready for operation.  
Insert the transmitter.
- Indicator is flashing green . . . . The batteries are being charged.
- Indicator illuminates green. . . . The batteries are fully charged.
- Indicator is flashing red . . . . . Error. The charging process is not started.
- All indicators are flashing rapidly red . . . . . Severe error. Do not use the charger!

**Note:**

- If an indicator is flashing red, remove the appropriate transmitter from the charging compartment and check if there are alkaline batteries inside the transmitter or if the NiMH have been inserted incorrectly. Should the flashing persist even when using NiMH batteries, please check if the batteries are already fully charged. If not, the batteries are defective and must be replaced.
- Should all the indicators flash red rapidly, no matter if there are transmitters in the charging compartments or not, there is a severe error. Disconnect the charger from the mains and check if there is a metallic object in the charging compartment. If yes, remove the object and connect the charger to the mains again. Should the indicators still flash rapidly, there is a defect, which the user cannot fix. In this case, please contact an authorised beyerdynamic dealer.

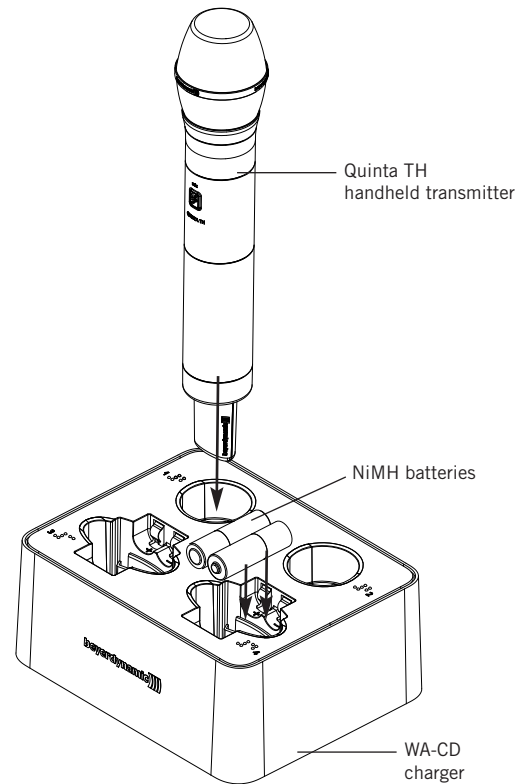

## 8. Trouble Shooting

If problems occur that you do not find listed below, reset the Quinta system to the standard configuration with the Quinta Conference software. Please refer also to the appropriate manual.

Problem	Possible Cause	Solution
Microphone button flashes red rapidly	<ul style="list-style-type: none"> <li>Control unit is not switched on</li> <li>Microphone unit is not within the range of the control unit</li> <li>Frequency bands have been configured incorrectly</li> <li>Microphone unit does not have the correct PIN code</li> </ul>	<ul style="list-style-type: none"> <li>Switch on the control unit</li> <li>Reduce the distance between control unit and microphone units</li> <li>Check the adjusted frequency bands with the Quinta Conference software</li> <li>Deactivate the PIN function in the Quinta Conference software. Make sure that all microphone units to be configured with the PIN code are within the range of the Quinta CU control unit. Enter the requested PIN code in the Quinta Conference software and select "Send to MUs". Activate the PIN function in the Quinta Conference software again. All microphone units that have received the new PIN code will communicate with the Quinta CU control unit. Other microphone units will not communicate (microphone button is flashing red).</li> </ul>
Operating control LED ① flashes	<ul style="list-style-type: none"> <li>Battery is almost empty</li> <li>Low battery warning to indicate that the battery is almost empty</li> </ul>	<ul style="list-style-type: none"> <li>Recharge the battery inside the microphone unit</li> </ul>
Microphone unit goes off	<ul style="list-style-type: none"> <li>Check if the battery is still full</li> <li>PIN code is activated</li> </ul>	<ul style="list-style-type: none"> <li>If the battery is empty, recharge it</li> <li>Deactivate PIN code</li> </ul>
Microphone cannot be activated	<ul style="list-style-type: none"> <li>All channels are occupied</li> <li>Check the number of open microphones (NOM) with the Quinta Conference Software or Quinta Web Server</li> <li>Microphone unit is not within the range of the control unit</li> <li>Interference caused by WLAN</li> <li>System operates in the PC controlled mode (Controller)</li> <li>All channels are reserved for chairmen</li> </ul>	<ul style="list-style-type: none"> <li>Switch off an activated microphone</li> <li>If possible increase the NOM with the Quinta Conference Software or the Quinta Web Server</li> <li>Reduce the distance between control unit and microphone units</li> <li>Use the standard settings mentioned in the Quinta Conference Software manual</li> <li>Check the settings of the frequency bands</li> <li>Select another frequency band with the Quinta Conference Software, the Quinta Web Server or the push-button for RF frequency band selection on the front of the Quinta CU control unit</li> <li>Set the system into the autonomous operating mode with the Quinta Conference Software or the Quinta Web Server</li> <li>Do not reserve all channels for chairmen, i.e. use less chairman units. Leave at least one channel free for delegate units.</li> </ul>
Microphone unit cannot be switched on	<ul style="list-style-type: none"> <li>Check the battery</li> </ul>	<ul style="list-style-type: none"> <li>If the battery is empty, recharge it</li> </ul>
Loudspeaker of the microphone unit does not work	<ul style="list-style-type: none"> <li>Check the volume setting with the Quinta Conference Software or Web Server</li> </ul>	<ul style="list-style-type: none"> <li>Increase the volume with the Quinta Conference Software or Quinta Web Server</li> </ul>

Problem	Possible Cause	Solution
Microphone unit cannot be switched off	<ul style="list-style-type: none"> <li>• “Manual Power Off” function is deactivated</li> <li>• Operating mode “Push-To-Talk” or “Voice activated” is active</li> <li>• Crash of the microcontroller inside the microphone unit</li> </ul>	<ul style="list-style-type: none"> <li>• Activate the “Manual Power Off” function with the Quinta Conference Software or Quinta Web Server</li> <li>• Deactivate the operating mode “Push-To-Talk” or “Voice activated” with the Quinta Conference Software or Quinta Web Server</li> <li>• Switch off the microphone units via the control unit by pressing the Clear/Standby button for more than 3 seconds</li> <li>• Switch off the control unit. The microphone units will go off after approx. 3 minutes.</li> <li>• Press the reset button on the bottom of the microphone unit</li> </ul>
Headphone output of the microphone unit does not work	<ul style="list-style-type: none"> <li>• Microphone unit is not switched on</li> <li>• Headphone or recorder is not connected properly</li> <li>• Check the volume setting with the Quinta Conference Software or Quinta Web Server</li> </ul>	<ul style="list-style-type: none"> <li>• Switch on the microphone unit</li> <li>• Connect the headphone or recorder properly</li> <li>• Increase the volume with the Quinta Conference Software or Quinta Web Server</li> </ul>
Feedback	<ul style="list-style-type: none"> <li>• Check the external loudspeakers</li> </ul>	<ul style="list-style-type: none"> <li>• Correct the volume and position of the loudspeakers</li> </ul>
Interferences, noise	<ul style="list-style-type: none"> <li>• Check the audio level</li> <li>• Microphone unit is not within the range of the control unit</li> <li>• Check the line of sight between microphone unit and antenna</li> </ul>	<ul style="list-style-type: none"> <li>• Reduce the input level of the control unit</li> <li>• Reduce the distance between control unit and microphone units</li> <li>• Remove obstacles between microphone units and antennae; do not place any objects in front of the antennae of the control unit</li> </ul>
Short drop-outs	<ul style="list-style-type: none"> <li>• Interferences caused by devices such as Wireless LAN</li> </ul>	<ul style="list-style-type: none"> <li>• Select another frequency band with the Quinta Conference Software, Quinta Web Server or via the push-button for RF frequency band selection on the front of the Quinta CU control unit. Refer also to chapter 7.1.</li> </ul>

## 8.1 Simultaneous Operation of the Quinta Conference System and other 2.4 GHz Devices (e.g. WLAN, Bluetooth)

### 8.1.1 Physical Laws

Due to many physical laws it is not possible to guarantee a simultaneous interference-free operation of different devices using the same frequency band. Radio devices operating in the same frequency band will always disturb each other (the function can be disturbed as well).

For the use of UHF wireless microphones it is known that 2 devices can never be operated on the same frequency. It is only possible to operate a certain number of compatible radio devices within a defined frequency band.

This applies also to the 2.4 GHz-ISM band (2400 MHz - 2484 MHz) or 5 GHz. Due to digital transmission techniques and various transmission standards it is possible, but not recommended, to operate certain devices simultaneously within the same frequency band.

### 8.1.2 Quinta and WLAN or WiFi

Like WLAN, the Quinta system uses the same bandwidth of approx. 22 MHz for each RF channel (Low, Mid, High). This results in three compatible RF channels which are theoretically:

- Compatible channel 1: 2400 MHz - 2428 MHz (theoretical mid frequency 2414 MHz)
- Compatible channel 2: 2428 MHz - 2456 MHz (theoretical mid frequency 2442 MHz)
- Compatible channel 3: 2456 MHz - 2484 MHz (theoretical mid frequency 2470 MHz)
- Compatible channel 4: +5.2 GHz - +5.8 GHz

The Quinta system uses RF channels (Low, Mid, High) compatible to each other. For WLAN the user has to configure compatible RF channels.

You can easily recognise that the individual WLAN channels overlap considerably due to their bandwidth. All neighbouring channels (e.g. channel 1 & 2 or channel 7 & 8) cannot be used simultaneously, because they would disturb each other. Furthermore, channel 12 and 13 are not approved for the use in the USA. In general, these channels are not used either. Within the remaining frequency bands only the WLAN channels 1, 6 and 11 can be used simultaneously.

For this reason the WLAN channels 1, 6 and 11 were selected for the RF channels Low, Mid and High used for the Quinta conference system. Due to this frequency compatibility the Quinta system is operated WLAN-friendly.

#### More tips for installation

- Keep a minimum distance of approx. 5 m between WLAN devices (e.g. Router, Repeater) and the transmitting and receiving antennae of the Quinta CU control unit.
- The distance between laptops with activated WLAN interface does not influence the audio transmission of the microphone units as long as there is no active data traffic.
- We recommend using different RF channels for WLAN or WiFi and Quinta channels. The distance between the WLAN and Quinta channels should be as large as possible.
- The channels of the Quinta conference system can be selected with the supplied Quinta Conference Software.

#### Frequencies Quinta / WLAN for example for 2.4 GHz

##### Quinta

Channel . . .	Centre frequency		
	2.4 GHz	5.2 GHz	5.8 GHz
Low . . . . .	2412 MHz . . . . .	5180 MHz . . . . .	5736 MHz
Mid . . . . .	2438 MHz . . . . .	5210 MHz . . . . .	5762 MHz
High . . . . .	2464 MHz . . . . .	5240 MHz . . . . .	5814 MHz

##### WLAN

Channel . . . . .	Centre frequency
1 . . . . .	2412
2 . . . . .	2417
3 . . . . .	2422
4 . . . . .	2427
5 . . . . .	2432
6 . . . . .	2437
7 . . . . .	2442
8 . . . . .	2447
9 . . . . .	2452
10 . . . . .	2457
11 . . . . .	2462
12 . . . . .	2467
13 . . . . .	2472
14 . . . . .	2484

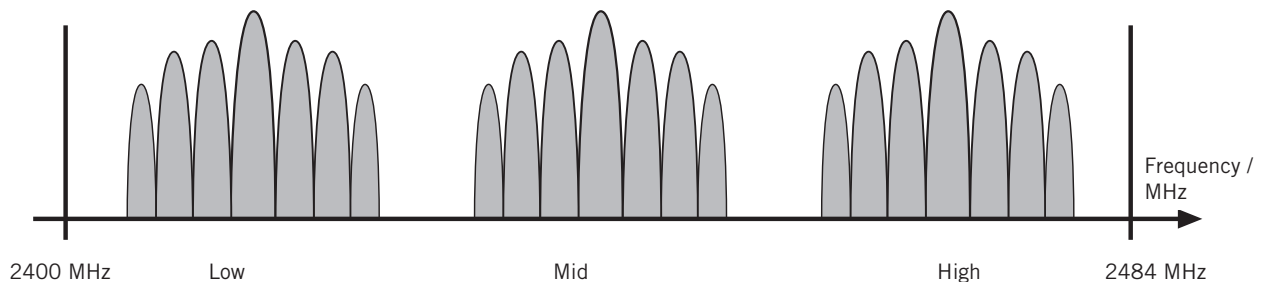

### 8.1.3 Quinta and Bluetooth

- Bluetooth devices make use of the whole 2.4 GHz range with changing carrier frequencies (frequency hopping).
- Interferences caused by Bluetooth devices (including microwave ovens) in normal operation can be excluded due to different measures inside the Quinta conference system and an advanced transmission protocol.
- It cannot be excluded, however, that an existing Bluetooth data traffic will be interfered by Quinta.

### 8.1.4 Example for Quinta, Media Control System and WLAN

**The 2.4 GHz technology is used for many applications in discussions and meetings.** In addition to a wireless discussion system other functions (light or volume control etc.) are operated via a wireless 2.4 GHz touch screen of a media control system. Furthermore, the participants of a meeting often have direct internet access via a WLAN access point.

The Quinta conference system and WLAN make use of compatible transmission standards. This should be considered when also using a media control system with a touch screen. State-of-the-art devices correspond to the WLAN standard.

1. Configure the Quinta conference system to the RF channel "Low". The Quinta system then makes use of the frequency range of 2401 to 2423 MHz. This frequency range must be reserved for Quinta exclusively.
2. Configure the touch screen of the media control system to the frequency range of 2426 to 2448 MHz. This corresponds to the WLAN channel 6. This frequency range must be reserved for the use of the touch screen exclusively.
3. Configure the WLAN access point to WLAN channel 11 making use of the frequency range 2451 to 2473 MHz. This frequency range must be reserved for the use by WLAN exclusively.
4. As an alternative you can operate Quinta in the 5.2 or 5.8 GHz band.

## 9. Components

Quinta CU	Control unit, DSSS transmission in 2.4 / 5.2 / 5.8 GHz ISM bands, 4 receive channels, 19" housing, 1 U, incl. 2 angled rod antennae, matt black, with high-resolution OLED display . . . . .	Order # 723.924
Quinta MU 23	Chairman microphone unit, removable Classis GM 31x Q gooseneck microphone (optional), DSSS transmission (Triple-RF-ISM-Band), incl. rechargeable battery, with loudspeaker and three buttons, soft touch paint, matt black . . . . .	Order # 723.932
Quinta MU 22	Double delegate microphone unit, removable Classis GM 31x Q gooseneck microphone (optional), DSSS transmission (Triple-RF-ISM-Band), incl. rechargeable battery, with loudspeaker and two microphone buttons, soft touch paint, matt black . . . . .	Order # 723.940
Quinta MU 21	Delegate microphone unit, removable Classis GM 31x Q gooseneck microphone (optional), DSSS transmission (Triple-RF-ISM-Band), incl. rechargeable battery, with loudspeaker and one microphone button, soft touch paint, matt black . . . . .	Order # 723.959
Quinta MU 33	Chairman microphone unit, Revoluto technology, DSSS transmission (Triple-RF-ISM-Band), incl. rechargeable battery, with loudspeaker and three buttons, soft touch paint, matt black . . . . .	Order # 725.102
Quinta MU 31	Delegate microphone unit, Revoluto technology, DSSS transmission (Triple-RF-ISM-Band), incl. rechargeable battery, with loudspeaker and one microphone button, soft touch paint, matt black . . . . .	Order # 725.110
Quinta CC 2	Charging case for 10 Quinta MU 23/22/21 microphone units with GM 313/314/315 Q, consisting of: Quinta CT 2 top cover, Quinta CD 2 charger, Quinta CW 2 bottom with casters . . . . .	Order # 723.967
Quinta CC 2/600	Charging case for 10 Quinta MU 23/22/21 microphone units with Classis GM 316 Q, consisting of: Quinta CT 2 / 600 top cover, Quinta CD 2 charger, Quinta CW 2 bottom with casters . . . . .	Order # 724.580
Quinta CC 3	Charging case for 12 Quinta MU 33/31 microphone units, consisting of: Quinta CT 2 top cover, Quinta CD 3 charger, Quinta CW 2 bottom with casters . . . . .	Order # 725.129
CA 2459	Mains power adapter with charging function and DC power supply for one Quinta MU microphone unit. . . . .	Order # 729.493
Quinta TH	Digital handheld transmitter with metal housing, silicone button with braille inscription, without microphone head, incl. 2 x AA NiMH batteries, MKV 11 microphone clamp and bag for transport . . . . .	Order # 729.329

## 10. Accessories

### Supplied Accessories

1 Power cable	
1 USB cable	
6 Phoenix terminal strips, 3-pin	
2 CA Q11 antennas	
1 Unlocking tool	
Quinta Conference Software for Control and Configuration . . . . .	Order # 723.991

### Optional

#### Quinta CU Control Unit

CA Q 13	Planar antenna, 2.4 - 5.8 GHz . . . . .	Order # 724.408
CA Q 14	Omnidirectional antenna for remote installation . . . . .	Order # 723.894
CA Q 30	Ecoflex system coaxial cable, sold per metre. . . . .	Order # 724.440
CA Q 31	Ecoflex system coaxial cable, 10 m [32.8 ft] . . . . .	Order # 724.416
CA Q 32	Ecoflex system coaxial cable, 20 m [65.6 ft] . . . . .	Order # 724.424

#### Gooseneck Microphones for the Quinta MU 23/22/21 Microphone Units

Classis GM 313 Q	Gooseneck microphone, condenser, cardioid, black, length 300 mm [11.81"], LED, 5-pin XLR connector, incl. wind shield. . . . .	Order # 724.203
Classis GM 314 Q	Gooseneck microphone, condenser, cardioid, black, length 400 mm [15.75"], LED, 5-pin XLR connector, incl. wind shield. . . . .	Order # 724.211
Classis GM 315 Q	Gooseneck microphone, condenser, cardioid, black, length 500 mm [19.69"], LED, 5-pin XLR connector, incl. wind shield. . . . .	Order # 724.238
Classis GM 316 Q	Gooseneck microphone, condenser, cardioid, black, length 600 mm [23.62"], LED, 5-pin XLR connector, incl. wind shield. . . . .	Order # 724.351

#### Quinta CC 2 | CC 2 / 600 Charging and Transport Case

Quinta CD 2	Charger for 10 Quinta MU 23/22/21 microphone units . . . . .	Order # 723.975
Quinta CM 2	19" compartment for Quinta CU control unit. . . . .	Order # 724.661
Quinta CT 2	Top cover . . . . .	Order # 724.556
Quinta CT 2/600	Top cover, when using the microphone units with the Classis GM 316 Q microphone . . . . .	Order # 724.580
Quinta CW 2	Bottom with casters . . . . .	Order # 724.564

#### Quinta CC 3 Charging and Transport Case

Quinta CD 3	Charger for 12 Quinta MU 33/31 microphone units. . . . .	Order # 725.137
Quinta CM 2	19" compartment for Quinta CU control unit. . . . .	Order # 724.661
Quinta CT 2	Top cover . . . . .	Order # 724.556
Quinta CW 2	Bottom with casters . . . . .	Order # 724.564

**Quinta TH Handheld Transmitter**

**Interchangeable Microphone Capsules**

TG V50w	Dynamic, cardioid, incl. storage bag . . . . .	Order # 711.438
TG V56w	Electret condenser, cardioid, incl. storage bag . . . . .	Order # 711.446
TG V96w	True condenser, cardioid, incl. storage bag . . . . .	Order # 711.470

**Charger**

WA-CD	Charger for TG 1000 beltpack transmitter and Quinta TH handheld transmitter with 4 charging compartments and control via Ethernet . . . . .	Order # 711.144
-------	---	-----------------

**11. Technical Specifications**

**General**

Frequency range . . . . .	2400 – 2483.5 MHz 5150 – 5250 MHz 5725 – 5875 MHz
Modulation . . . . .	DSSS (Direct Sequence Spread Spectrum) and QPSK/BPSK (Quadrature/Binary Phase Shift Keying) digital signal processing acc. to own standard
Max. number of audio streams . . . . .	4 useable channels per system
Signal-to-noise ratio . . . . .	80 dB typ., (unweighted signal-to-noise ratio)
Range between microphone units and control unit . . . . .	> 100 m [109.36 yds]
Power supply . . . . .	100 – 240 V AC 50/60 Hz
Approval . . . . .	world-wide

**AVB**

Transmission and reception of audio data . . . . .	acc. to IEC 61883-6
Format of the audio data . . . . .	AM824
Stream ID Quinta CU . . . . .	Bit 63 – 16 / MAC address Bit 15 – 0 / X

**Quinta MU 23/22/21 Microphone Units**

Transmitter power . . . . .	max. 20 dBm per channel and region (average, duty cycle ≤ 30%)*
Battery voltage . . . . .	8 NiMH cells, 2080 mAh
External DC operation . . . . .	15 V DC (±0.5 V), residual hum < 20 mV, 950 mA
Charging time with charger . . . . .	max. 2.5 hours when the battery is completely empty
with mains charger adapter . . . . .	max. 2.5 hours when the battery is completely empty
Loudspeaker . . . . .	Wide-band, integrated loudspeaker
Volume decrease when Mic On (“Ducking”) . . . . .	15 dB fixed setting
Headphone output . . . . .	Jack socket (3.5 mm, stereo)
Min. impedance . . . . .	16 Ω
Power supply . . . . .	9.6 V with integrated NiMH battery (8 cells)
Operating time depending on the type of the microphone unit . . . . .	approx. 20 hours in discussion mode, operating time also depends on the volume
Temperature range (at < 90% humidity) . . . . .	+10° – +40°C [+50 °F – +104 °F]
Storage temperature (at < 90% humidity) . . . . .	-20° – +55°C [-4 °F – +131 °F]
Dimensions (without microphone) . . . . .	Length 173 mm [6.8"] Width 157 mm [6.18"] Height 51 mm [2.01"]
Weight . . . . .	1.7 kg [3.74 lbs]

**Quinta MU 33/31 Microphone Units**

Transmitter power . . . . .	max. 20 dBm per channel (average, duty cycle ≤ 30%)*
Battery voltage . . . . .	8 NiMH cells, 2080 mAh
External DC operation . . . . .	15 V DC (±0.5 V), residual hum < 20 mV, 400 mA
Charging time with charger . . . . .	max. 2.5 hours when the battery is completely empty
with mains charger adapter . . . . .	max. 2.5 hours when the battery is completely empty
Microphone . . . . .	Microphone Array
Pick up pattern . . . . .	Corridor
T.H.D. . . . .	< 0.1%
Loudspeaker . . . . .	Integrated, two-way loudspeaker
Loudspeaker switch off at “Mic On” . . . . .	yes
Headphone output . . . . .	jack socket (3.5 mm, stereo)
Min. impedance . . . . .	16 Ω
Power supply . . . . .	9.6 V with integrated NiMH battery (8 cells)

Operating time depending on the type of the microphone unit . . . . .	approx. 20 hours in discussion mode; operating time depends on the volume
Temperature range (at < 90% humidity) . . . . .	+10° – +40°C [+50 °F – +104 °F]
Storage temperature (at < 90% humidity) . . . . .	20° – +55°C [-4 °F – +131 °F]
Dimensions . . . . .	Length 96 mm [3.8"] Width 300 mm [11.8"] Height 82 mm [3.2"]
Weight . . . . .	1.06 kg [2.33 lbs]

### Quinta TH Handheld Transmitter

Operating principle . . . . .	Digital triple band handheld transmitter
Frequency range . . . . .	2400 – 2483.5 MHz 5150 – 5250 MHz 5725 – 5875 MHz
Modulation . . . . .	DSSS (Direct Sequence Spread Spectrum) and QPSK/BPSK (Quadrature/ Binary Phase Shift Keying) digital signal processing acc. to own standards
Max. number of audio streams . . . . .	4 usable channels per system
Signal-to-noise ratio . . . . .	80 dB typ., (unweighted signal-to-noise ratio)
Range between handheld transmitter and control unit . . . . .	> 100 m [109.36 yds] with a direct line of sight (depending on the frequency band)
Power supply . . . . .	100 – 240 V AC 50/60 Hz
Approval . . . . .	world-wide
Transmitter power . . . . .	max. 20 dBm per channel and region (average, duty cycle ≤ 30%)*
Max. SPL . . . . .	107 dBU SPL @ 1% THD (with TG V56w)
Internal PGA . . . . .	+25 dB
Power supply . . . . .	2.4 V via 2x AA NiMH batteries 3 V via 2x AA alkaline batteries
Operating time . . . . .	approx. 10 hrs (depending on the battery type and frequency band)
Charging time . . . . .	max. 2.5 hours when the battery is completely empty
Temperature range (at < 90% humidity) . . . . .	+10° – +40°C [+50 °F – +104 °F]
Storage temperature (at < 90% humidity) . . . . .	-20° – +55°C [-4 °F – +131 °F]
Dimensions . . . . .	Length 197 mm [7.76"] / Ø 36 mm [1.42"] (without microphone head)
Weight . . . . .	161 g [5.68 ozs] (without batteries and microphone head)

### Quinta CU Control Unit

Frequency response . . . . .	70 Hz – 22 kHz (-3 dB)
Operation mode . . . . .	Diversity (receiver), separate for each channel
Antenna connection . . . . .	2 N-connectors (female)
Transmitting power . . . . .	max. 20 dBm per channel and region (average, duty cycle ≤ 30%)*
Connections	
Serial control port . . . . .	RS 232, USB
Ethernet port . . . . .	LAN, TCP/IP standard
Master output balanced . . . . .	1 x XLR, 1 x 3-pin Phoenix terminal strip, max. +6 dBU, level adjustable via software (range ±15 dB)
Master output unbalanced . . . . .	RCA, max. +2.2 dBU, level adjustable via software (range ±15 dB)
Audio outputs, single channels . . . . .	4 x 3-pin Phoenix terminal strip, max. +6 dBU, level adjustable via software (range 0 ... -50 dB)
Input balanced . . . . .	1 x 3-pin Phoenix terminal strip, max. +6 dBU, input adjustable via software (range 0 ... -50 dB)
Power supply . . . . .	100 – 240 V AC 50/60 Hz 70 – 150 mA
Fuse . . . . .	2 x AL 0.5 A (slow blow)
Power consumption . . . . .	10 VA
Temperature range . . . . .	+10° – +40 °C [+50 °F – +104 °F] (at < 90% humidity)
Indication . . . . .	4 channel LEDs (red/white) and Power LED (red/white)
Min. depth of Rack . . . . .	380 mm
Dimensions (W x H x D) . . . . .	19", 1HU (440 x 44 x 239 mm) [17.32" x 1.73" x 9.41"]
Weight . . . . .	3.2 kg [7.05 lbs]
AVB interface:	
Stream ID . . . . .	Bit 63 – 16 / MAC address Bit 15 – 0 / X
Number of channels . . . . .	4
Audio format . . . . .	IEC 61883-6/AM824 with 24-bit / 48 kHz
IP configuration . . . . .	DHCP



**Quinta CD 2 / CD 3 Charger**

Power supply . . . . .	100 - 240 V AC ~, 50 / 60 Hz
Fuse at the mains socket . . . . .	2 x 6.3 A (slow blow)
Power consumption . . . . .	max. 180 W
Max. ambient temperature when charging (< 90% atmospheric humidity) . . . . .	+10 °C – +35 °C [+50 °F – +95 °F]
Storage temperature. . . . .	-20 °C – +55 °C [-4 °F – +131 °F]
Charging unit . . . . .	10 microphone units parallel
Charging time . . . . .	max. 3.5 hours when the battery is completely empty
Dimensions (W x H x D) . . . . .	757 x 476 x 370 mm [29.8" x 18.74" x 14.57"]
Weight . . . . .	approx. 12 kg

**CA 2459 Mains Power Adapter**

Voltage . . . . .	15 V DC
Current carrying capacity . . . . .	1.6 A
Input voltage. . . . .	100 – 240 V AC 50/60 Hz
Connector . . . . .	Adapter for Europe, USA, UK, Australia

\*The transmitter power can differ from this value due to specific regulations in various countries.

## EC-DECLARATION OF CONFORMITY

**Application of  
Council directive:**

1999/5/EC  
R&TTE Directive

93/68/EEC  
Electromagnetic Compatibility

2006/95/EC  
Low Voltage Directive

**Standards to which  
Conformity is Declared:**

EMC	EN 301 489-1	V1.8.1
	EN 301 489-17	V2.1.1
Radio Spectrum	EN 300 328	V1.8.0
	EN 301 893	V1.5.1
	EN 300 440-1	V1.6.1
	EN 300 440-2	V1.4.1
Safety	EN 60 950-1	

**Manufacturer's Name:**

beyerdynamic GmbH & Co. KG

**Manufacturer's Address:**

Theresienstraße 8, 74072 Heilbronn, Germany

**Type of Equipment:**

Wireless Conference System  
**Quinta**

**Model Numbers:**

Quinta CU

I, the undersigned, as an employee of beyerdynamic, hereby declare that the equipment specified conforms to the above Directive and Standards.

Manufacturer's Signature:



Date:



1<sup>st</sup> June, 2012

Full Name:

Ulrich Roth

Position:

Director of R&D

 0682 

## EC-DECLARATION OF CONFORMITY

**Application of  
Council directive:**

1999/5/EC  
R&TTE Directive

93/68/EEC  
Electromagnetic Compatibility

2006/95/EC  
Low Voltage Directive

**Standards to which  
Conformity is Declared:**

EMC	EN 301 489-1	V1.8.1
	EN 301 489-17	V2.1.1
Radio Spectrum	EN 300 328	V1.8.0
	EN 301 893	V1.5.1
	EN 300 440-1	V1.6.1
	EN 300 440-2	V1.4.1
Safety	EN 60 950-1	

**Manufacturer's Name:**

beyerdynamic GmbH & Co. KG

**Manufacturer's Address:**

Theresienstraße 8, 74072 Heilbronn, Germany

**Type of Equipment:**

Wireless Conference System  
**Quinta**

**Model Numbers:**

Quinta MU 21, Quinta MU 22, Quinta MU 23  
Quinta MU 31, Quinta MU 33

I, the undersigned, as an employee of beyerdynamic, hereby declare that the equipment specified conforms to the above Directive and Standards.

Manufacturer's Signature:



Date:



1<sup>st</sup> July, 2013

Full Name:

Ulrich Roth

Position:

Director of R&D

 0682 

## EC-DECLARATION OF CONFORMITY

**Application of  
Council directive:**

1999/5/EC  
R&TTE Directive

93/68/EEC  
Electromagnetic Compatibility

2006/95/EC  
Low Voltage Directive

**Standards to which  
Conformity is Declared:**

EMC	EN 301 489-1	V1.8.1
	EN 301 489-17	V2.1.1
Radio Spectrum	EN 300 328	V1.8.0
	EN 301 893	V1.5.1
	EN 300 440-1	V1.6.1
	EN 300 440-2	V1.4.1
Safety	EN 60 950-1:2014	

**Manufacturer's Name:**

beyerdynamic GmbH & Co. KG

**Manufacturer's Address:**

Theresienstraße 8, 74072 Heilbronn, Germany

**Type of Equipment:**

Wireless Conference System

**Model Numbers:**

**Quinta TH**

I, the undersigned, as an employee of beyerdynamic, hereby declare that the equipment specified conforms to the above Directive and Standards.

Manufacturer's Signature:



Date:



1<sup>st</sup> May, 2015

Full Name:

Ulrich Roth

Position:

Director of R&D

 0682 

## FCC Regulation

FCC ID: OSDQUINTACU for Quinta CU  
 FCC ID: OSDQUINTAMU2X for Quinta MU 21  
 FCC ID: OSDQUINTAMU2X for Quinta MU 22  
 FCC ID: OSDQUINTAMU2X for Quinta MU 23  
 FCC ID: OSDQUINTAMU3X for Quinta MU 31  
 FCC ID: OSDQUINTAMU3X for Quinta MU 33  
 FCC ID: OSDQUINTATH for Quinta TH

Canada: IC: 3628A-QUINTACU for Quinta CU  
 Canada: IC: 3628A-QUINTAMU2X for Quinta MU 21  
 Canada: IC: 3628A-QUINTAMU2X for Quinta MU 22  
 Canada: IC: 3628A-QUINTAMU2X for Quinta MU 23  
 Canada: IC: 3628A-QUINTAMU3X for Quinta MU 31  
 Canada: IC: 3628A-QUINTAMU3X for Quinta MU 33  
 Canada: IC: 3628A-QUINTATH for Quinta TH

### Part 15.19 Statement

#### NOTICE:

This device complies with Part 15 of the FCC Rules [and with Industry Canada licence-exempt RSS standard(s)].

Operation is subject to the following two conditions:

- (1) this device may not cause harmful interference, and
- (2) this device must accept any interference received, including interference that may cause undesired operation.

Le présent appareil est conforme aux CNR d'Industrie Canada applicables aux appareils radio exempts de licence. L'exploitation est autorisée aux deux conditions suivantes:

- (1) l'appareil ne doit pas produire de brouillage, et
- (2) l'utilisateur de l'appareil doit accepter tout brouillage radioélectrique subi, même si le brouillage est susceptible d'en compromettre le fonctionnement.

### Part 15.21 Statement

#### NOTICE:

Changes or modifications made to this equipment not expressly approved by beyerdynamic GmbH & Co. KG may void the FCC authorization to operate this equipment.

### Part 15.105 Statement

**NOTE:** This equipment has been tested and found to comply with the limits for a Class B digital device, pursuant to Part 15 of the FCC Rules. These limits are designed to provide reasonable protection against harmful interference in a residential installation. This equipment generates, uses and can radiate radio frequency energy and, if not installed and used in accordance with the instructions, may cause harmful interference to radio communications. However, there is no guarantee that interference will not occur in a particular installation. If this equipment does cause harmful interference to radio or television reception, which can be determined by turning the equipment off and on, the user is encouraged to try to correct the interference by one or more of the following measures:

- Reorient or relocate the receiving antenna.
- Increase the separation between the equipment and receiver.
- Connect the equipment into an outlet on a circuit different from that to which the receiver is connected.
- Consult the dealer or an experienced radio/TV technician for help.

### RF Exposure Statement

#### Radiofrequency radiation exposure Information:

This equipment complies with FCC radiation exposure limits set forth for an uncontrolled environment.

This equipment should be installed and operated with minimum distance of 20 cm between the radiator and your body.

This transmitter must not be co-located or operating in conjunction with any other antenna or transmitter.

### Special instructions for Japan:

Operation of these devices in the 5.8GHz range is illegal in Japan.

The CA Q 13 and CA Q 14 antenna may only be operated with at least 10m cable between antenna and control unit.

This device is granted pursuant to the Japanese Radio Law (電波法) and the Japanese Telecommunications Business Law (電気通信事業法)

- 本製品は、電波法および電気通信事業法に基づき許可されています。
- This device should not be modified (otherwise the granted designation number will become invalid) (refer to attached Instruction File Japan (R&T) 2012)).

beyerdynamic GmbH & Co. KG  
Theresienstr. 8 | 74072 Heilbronn – Germany  
Tel. +49 (0) 7131 / 617 - 0 | Fax +49 (0) 7131 / 617 - 204  
info@beyerdynamic.de | www.beyerdynamic.com

For further distributors worldwide, please go to [www.beyerdynamic.com](http://www.beyerdynamic.com)

