

## TEST REPORT

Test report no.: 1-3469/11-01-13-D



### Testing laboratory

**CETECOM ICT Services GmbH**  
 Untertuerkheimer Strasse 6 – 10  
 66117 Saarbruecken / Germany  
 Phone: + 49 681 5 98 - 0  
 Fax: + 49 681 5 98 - 9075  
 Internet: <http://www.cetecom.com>  
 e-mail: [ict@cetecom.com](mailto:ict@cetecom.com)

#### Accredited Testing Laboratory:

The testing laboratory (area of testing) is accredited according to DIN EN ISO/IEC 17025 (2005) by the Deutsche Akkreditierungsstelle GmbH (DAkkS). The accreditation is valid for the scope of testing procedures as stated in the accreditation certificate with the registration number: D-PL-12076-01-01  
 Area of Testing: Radio/Satellite Communications

### Applicant

**beyerdynamic GmbH & Co. KG**  
 Theresienstraße 8  
 74072 Heilbronn / GERMANY  
 Phone: +49 7131 617-0  
 Fax: +49 7131 617-215  
 Contact: Ulrich Roth  
 e-mail: [roth@beyerdynamic.de](mailto:roth@beyerdynamic.de)  
 Phone: +49 7131 617-155

### Manufacturer

**beyerdynamic GmbH & Co. KG**  
 Theresienstraße 8  
 74072 Heilbronn / GERMANY

### Test standard/s

47 CFR Part 15 Title 47 of the Code of Federal Regulations; Chapter I  
 Part 15 - Radio frequency devices

RSS - 210 Issue 8 Spectrum Management and Telecommunications - Radio Standards Specification  
 Low-power Licence-exempt Radiocommunication Devices (All Frequency Bands):  
 Category I Equipment

For further applied test standards please refer to section 3 of this test report.

### Test Item

**Kind of test item:** Wireless Conference System  
**Model name:** Quinta CU  
**FCC ID:** OSDQUINTACU  
**IC:** 3628A-QUINTACU  
**Frequency:** ISM band 5150 MHz to 5250 MHz  
 5180 MHz; 5210 MHz; 5240 MHz  
**Technology tested:** Proprietary OFDM  
**Antenna:** Two external N-connectors / Dedicated antennas  
 (Rod antenna, Planar antenna, Omnidirectional antenna)  
**Power Supply:** 110 V AC by AC / DC power supply  
**Temperature Range:** +10°C to +50 °C



This test report is electronically signed and valid without handwriting signature. For verification of the electronic signatures, the public keys can be requested at the testing laboratory.

### Test report authorised:

[Signature box]

Stefan Bös  
 Senior Testing Manager

### Test performed:

[Signature box]

Jakob Reschke  
 Project Manager

## 1 Table of contents

1	Table of contents .....	2
2	General information .....	3
2.1	Notes and disclaimer .....	3
2.2	Application details.....	3
3	Test standard/s .....	3
4	Test environment.....	4
5	Test item .....	4
6	Test laboratories sub-contracted .....	4
7	Summary of measurement results .....	5
8	RF measurements .....	6
8.1	Description of test setup .....	6
8.1.1	Radiated measurements.....	6
8.1.2	Conducted measurements.....	7
8.2	Additional comments .....	7
8.3	RSP100 test report cover sheet / performance test data .....	8
9	Measurement results.....	9
9.1	Gain.....	9
9.2	Duty cycle.....	13
9.3	Maximum output power conducted and radiated .....	14
9.4	Power spectral density .....	23
9.5	Spectrum bandwidth – 26 dB bandwidth .....	27
9.6	Occupied bandwidth – 20 dB bandwidth .....	31
9.7	Peak excursion measurements.....	32
9.8	Band edge compliance radiated .....	37
9.9	TX spurious emissions radiated .....	41
9.10	RX spurious emissions radiated .....	107
9.11	TX spurious emissions radiated < 30 MHz.....	111
9.12	TX spurious emissions conducted < 30 MHz.....	113
10	Test equipment and ancillaries used for tests.....	115
11	Observations .....	116
Annex A	Photographs of the test setup .....	117
Annex B	External photographs of the EUT.....	122
Annex C	Internal photographs of the EUT .....	125
Annex D	Antennas & Cable .....	132
Annex E	Safety exposure levels (MPE calculation).....	136
Annex F	Document history .....	138
Annex G	Further information.....	138
Annex H	Accreditation Certificate .....	139

## 2 General information

### 2.1 Notes and disclaimer

The test results of this test report relate exclusively to the test item specified in this test report. CETECOM ICT Services GmbH does not assume responsibility for any conclusions and generalizations drawn from the test results with regard to other specimens or samples of the type of the equipment represented by the test item.

The test report may only be reproduced or published in full. Reproduction or publication of extracts from the report requires the prior written approval of CETECOM ICT Services GmbH.

The testing service provided by CETECOM ICT Services GmbH has been rendered under the current "General Terms and Conditions for CETECOM ICT Services GmbH".

CETECOM ICT Services GmbH will not be liable for any loss or damage resulting from false, inaccurate, inappropriate or incomplete product information provided by the customer.

Under no circumstances does the CETECOM ICT Services GmbH test report include any endorsement or warranty regarding the functionality, quality or performance of any other product or service provided.

Under no circumstances does the CETECOM ICT Services GmbH test report include or imply any product or service warranties from CETECOM ICT Services GmbH, including, without limitation, any implied warranties of merchantability, fitness for purpose, or non-infringement, all of which are expressly disclaimed by CETECOM ICT Services GmbH.

All rights and remedies regarding vendor's products and services for which CETECOM ICT Services GmbH has prepared this test report shall be provided by the party offering such products or services and not by CETECOM ICT Services GmbH.

In no case this test report can be considered as a Letter of Approval.

This test report is electronically signed and valid without handwritten signature. For verification of the electrical signatures, the public keys can be requested at the testing laboratory.

### 2.2 Application details

Date of receipt of order:	2011-10-12
Date of receipt of test item:	2012-02-21
Start of test:	2012-02-21
End of test:	2012-04-24
Person(s) present during the test:	-/-

## 3 Test standard/s

Test standard	Date	Test standard description
47 CFR Part 15	2010-10	Title 47 of the Code of Federal Regulations; Chapter I Part 15 - Radio frequency devices
RSS - 210 Issue 8	2010-12	Spectrum Management and Telecommunications - Radio Standards Specification Low-power Licence-exempt Radiocommunication Devices (All Frequency Bands): Category I Equipment

#### 4 Test environment

Temperature:	$T_{nom}$	+22 °C during room temperature tests
	$T_{max}$	+50 °C during high temperature tests
	$T_{min}$	+10 °C during low temperature tests
Relative humidity content:		43 %
Barometric pressure:		not relevant for this kind of testing
Power supply:	$V_{nom}$	110 V AC by AC / DC power supply
	$V_{max}$	121 V
	$V_{min}$	99 V

#### 5 Test item

Kind of test item	:	Wireless Conference System
Type identification	:	Quinta CU
S/N serial number	:	00102
HW hardware status	:	Rev. 2
SW software status	:	PNP: V015 MAINAPP: V121
Frequency band [MHz]	:	ISM band 5150 MHz to 5250 MHz 5180 MHz; 5210 MHz; 5240 MHz
Type of radio transmission	:	OFDM
Use of frequency spectrum	:	
Channel access method	:	FDMA
Type of modulation	:	BPSK, QPSK, 16-QAM, 64-QAM
Number of channels	:	3 (test software)
Antenna	:	Two external N-connectors Dedicated antennas (Rod antenna, Planar antenna, Omni directional antenna)
Power supply	:	110 V AC by AC / DC power supply
Temperature range	:	+10°C to +50 °C

#### 6 Test laboratories sub-contracted

None

## 7 Summary of measurement results

- No deviations from the technical specifications were ascertained
- There were deviations from the technical specifications ascertained

TC Identifier	Description	Verdict	Date	Remark
RF-Testing	CFR Part 15 RSS 210, Issue 8, Annex 8	Passed	2012-11-12	-/-

Test specification clause	Test case	Temperature conditions	Power source voltages	Pass	Fail	NA	NP	Results (max.)
U-NII Part 15	Duty cycle	Nominal	Nominal	<input type="checkbox"/>	<input type="checkbox"/>	<input type="checkbox"/>	<input type="checkbox"/>	No pass / fail criteria!
§15.407(a)(1) RSS-210	Maximum output power	Nominal	Nominal	<input checked="" type="checkbox"/>	<input type="checkbox"/>	<input type="checkbox"/>	<input type="checkbox"/>	complies
§15.247(e) RSS 210	Power spectral density	Nominal	Nominal	<input checked="" type="checkbox"/>	<input type="checkbox"/>	<input type="checkbox"/>	<input type="checkbox"/>	complies
§15.247(a)(2) RSS 210	Spectrum bandwidth 26dB bandwidth	Nominal	Nominal	<input checked="" type="checkbox"/>	<input type="checkbox"/>	<input type="checkbox"/>	<input type="checkbox"/>	complies
§15.247(d) RSS-210	Band edge compliance conducted	Nominal	Nominal	<input checked="" type="checkbox"/>	<input type="checkbox"/>	<input type="checkbox"/>	<input type="checkbox"/>	complies
§15.205 RSS-210	Band edge compliance radiated	Nominal	Nominal	<input checked="" type="checkbox"/>	<input type="checkbox"/>	<input type="checkbox"/>	<input type="checkbox"/>	complies
§15.247(d) RSS-210	TX spurious emissions conducted	Nominal	Nominal	<input checked="" type="checkbox"/>	<input type="checkbox"/>	<input type="checkbox"/>	<input type="checkbox"/>	complies
§15.247(d) RSS-210	TX spurious emissions radiated	Nominal	Nominal	<input checked="" type="checkbox"/>	<input type="checkbox"/>	<input type="checkbox"/>	<input type="checkbox"/>	complies
§15.109 RSS-Gen.	RX spurious emissions radiated	Nominal	Nominal	<input checked="" type="checkbox"/>	<input type="checkbox"/>	<input type="checkbox"/>	<input type="checkbox"/>	complies
§15.209(a) RSS-Gen	TX spurious emissions radiated < 30 MHz	Nominal	Nominal	<input checked="" type="checkbox"/>	<input type="checkbox"/>	<input type="checkbox"/>	<input type="checkbox"/>	complies
§15.107(a)	Conducted emissions < 30 MHz	Nominal	Nominal	<input checked="" type="checkbox"/>	<input type="checkbox"/>	<input type="checkbox"/>	<input type="checkbox"/>	complies

**Note:** NA = Not Applicable; NP = Not Performed

## 8 RF measurements

### 8.1 Description of test setup

#### 8.1.1 Radiated measurements

The radiated measurements are performed in vertical and horizontal plane in the frequency range from 9 kHz to 25 GHz in semi-anechoic chambers. The EUT is positioned on a non-conductive support with a height of 0.80 m above a conductive ground plane that covers the whole chamber. The receiving antennas are confirmed with specifications ANSI C63.2-1996 clause 15 and ANSI C63.4-2009 clause 4.1.5. These antennas can be moved over the height range between 1.0 m and 4.0 m in order to search for maximum field strength emitted from EUT. The measurement distances between EUT and receiving antennas are indicated in the test setups for the various frequency ranges. For each measurement, the EUT is rotated in all three axes until the maximum field strength is received. The wanted and unwanted emissions are received by spectrum analysers where the detector modes and resolution bandwidths over various frequency ranges are set according to requirement ANSI C63-4-2009 clause 4.2.

Antennas are confirmed with ANSI C63.2-1996 item 15.

Semi anechoic chamber

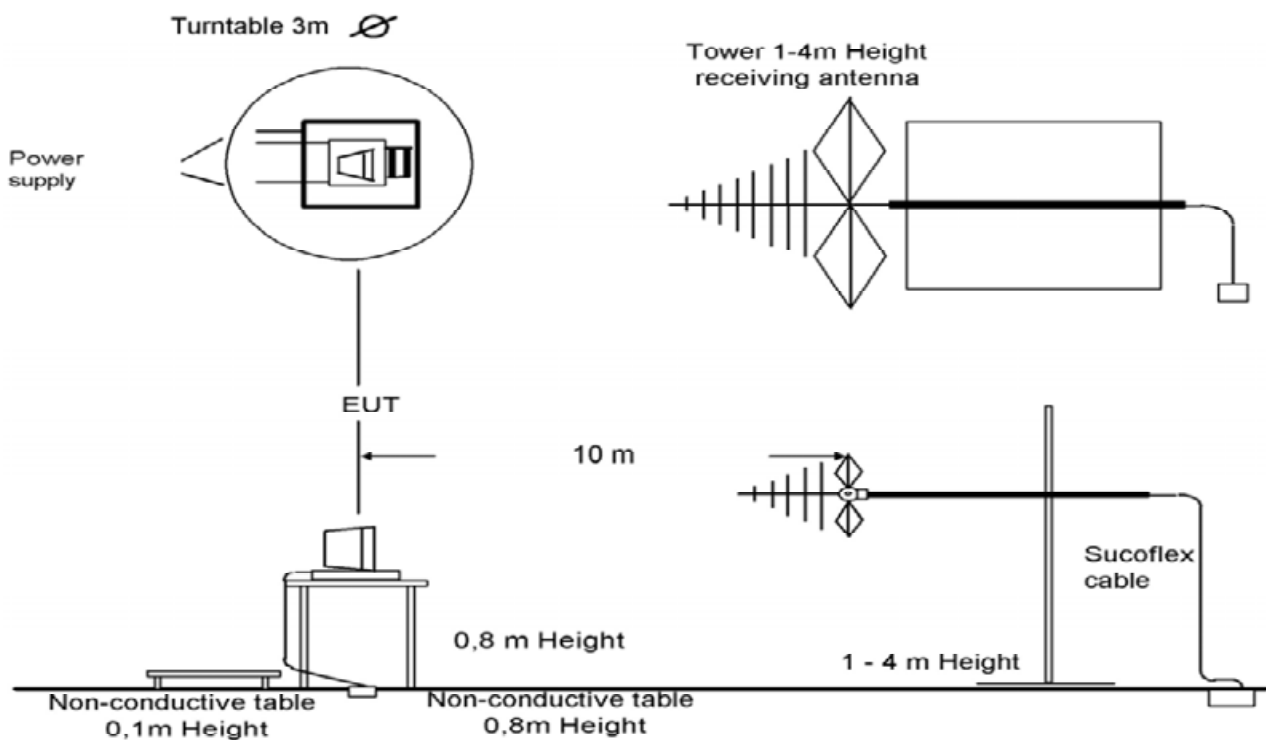

Picture 1: Diagram radiated measurements

9 kHz - 30 MHz:	active loop antenna
30 MHz – 1 GHz:	tri-log antenna
> 1 GHz:	horn antenna

The EUT is powered by an external power supply with nominal voltage

### 8.1.2 Conducted measurements

The EUT's RF signal is coupled out by the antenna connector which is supplied by the manufacturer. The signal is first 10dB attenuated before it is power divided (~6dB loss per branch). One of the signal paths is connected to the communication base Station (CMU200 or other), the other one is connected to the spectrum analyzer. The specific losses for both signal paths are first checked within a calibration. The measurement readings on the signalling unit/spectrum analyzer are corrected by the specific test set-up loss. The attenuator, power divider, signalling unit and the spectrum analyzer are impedance matched on 50 Ohm.

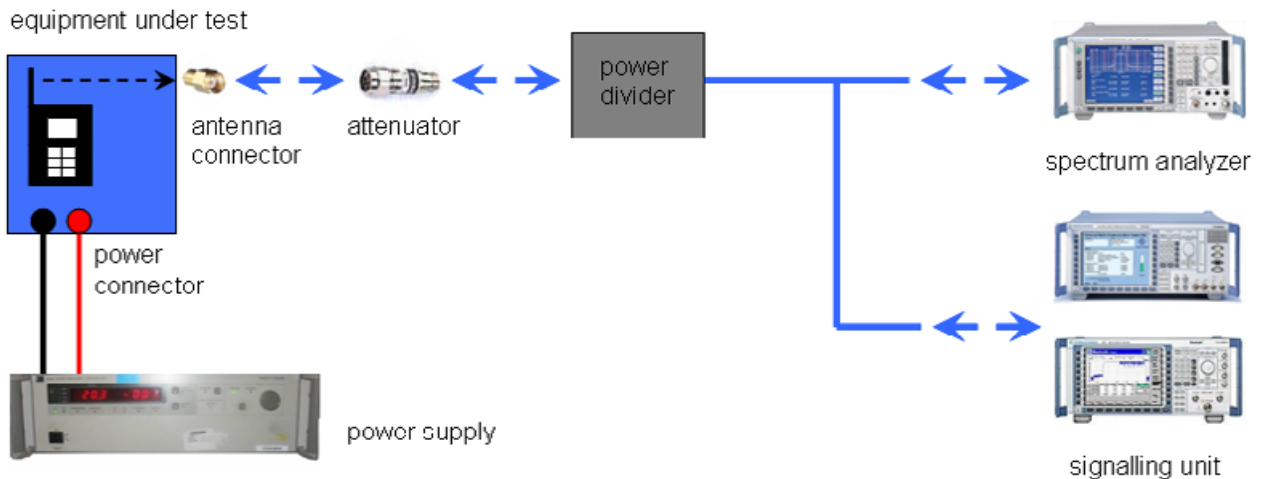

Picture 2: Diagram conducted measurements

### 8.2 Additional comments

- Involved employees: Jakob Reschke, Marco Bertolino, Stefan Bös, Christoph Schneider
- Reference documents: None
- Special test descriptions: None
- Configuration descriptions: EUT has three different antenna types.  
All radiated measurements were performed with all three antenna types.  
The output power settings of the EUT was always the same: 360/6
- Test mode:  No test mode available.  
 Special software is used.  
EUT is transmitting pseudo random data by itself

### 8.3 RSP100 test report cover sheet / performance test data

Test report number	:	1-3469/11-01-13-D
Equipment model number	:	Quinta CU
Certification number	:	3628A-QUINTACU
Manufacturer (complete address)	:	beyerdynamic GmbH & Co. KG Theresienstraße 8 74072 Heilbronn / GERMANY
Tested to radio standards specification no.	:	RSS 210, Issue 8
Open area test site IC No.	:	IC 3462C-1
Frequency range	:	lowest channel: 5180 MHz; highest channel 5240 MHz
RF-power [mW] (max.)	:	cond.: 11.07 mW (Rod antenna A) EIRP: 30.20 mW (Rod antenna A)  cond.: 10.07 mW (Rod antenna B) EIRP: 25.70 mW (Rod antenna B)  cond.: 11.07 mW (Planar antenna A) EIRP: 45.50 mW (Planar antenna A)  cond.: 10.07 mW (Planar antenna B) EIRP: 46.56 mW (Planar antenna B)  cond.: 11.07 mW (Omnidirectional antenna A) EIRP: 3.10 mW (Omnidirectional antenna A)  cond.: 10.07 mW (Omnidirectional antenna B) EIRP: 3.60 mW (Omnidirectional antenna B)
Occupied bandwidth (99%-BW) [MHz]	:	15.07 MHz
Type of modulation	:	DSSS
Emission designator (TRC-43)	:	15M1G7D
Antenna information	:	Two external N-connectors / Dedicated antennas (Rod antenna, Planar antenna, Omni directional antenna)
Transmitter spurious (worst case) [dB $\mu$ V/m @ 3m]:		46.91 dB $\mu$ V/m @ 12.4 GHz (noise floor)
Receiver spurious (worst case) [dB $\mu$ V/m @ 3m]	:	46.13 dB $\mu$ V/m @ 11.9 GHz (noise floor)

#### ATTESTATION:

#### DECLARATION OF COMPLIANCE:

I attest that the testing was performed or supervised by me; that the test measurements were made in accordance with the above-mentioned Industry Canada standard(s); and that the equipment identified in this application has been subjected to all the applicable test conditions specified in the Industry Canada standards and all of the requirements of the standard have been met.

#### Laboratory manager:

2012-11-12  
Date

Jakob Reschke  
Name



Signature



## 9 Measurement results

### 9.1 Gain

#### Description:

Measurement of the maximum output power conducted and radiated

#### Measurement:

Measurement parameter	
Detector:	Peak
Sweep time:	Auto
Resolution bandwidth:	30 MHz
Video bandwidth:	20 MHz
Span:	50 MHz
Trace-Mode:	Max Hold

#### Limits:

Antenna Gain
Maximum 6 dBi

**Result rod antenna A:**

Modulation Channel	Gain		
	Lowest	Middle	Highest
	3.40	4.95	4.98
Measurement uncertainty	± 3 dB		

**Result: Passed****Result rod antenna B:**

Modulation Channel	Gain		
	Lowest	Middle	Highest
	4.17	4.62	2.90
Measurement uncertainty	± 3 dB		

**Result: Passed**

**Result planar antenna A, 10m cable:**

Modulation Channel	Gain		
	Lowest	Middle	Highest
	6.14	6.22	6.73
Measurement uncertainty	± 3 dB		

**Result: Passed****Result planar antenna B, 10m cable:**

Modulation Channel	Gain		
	Lowest	Middle	Highest
	6.79	6.46	6.01
Measurement uncertainty	± 3 dB		

**Result: Passed****Result planar antenna A, 20m cable:**

Modulation Channel	Gain		
	Lowest	Middle	Highest
	3.53	2.90	3.68
Measurement uncertainty	± 3 dB		

**Result: Passed****Result planar antenna B, 20m cable:**

Modulation Channel	Gain		
	Lowest	Middle	Highest
	4.62	3.98	4.64
Measurement uncertainty	± 3 dB		

**Result: Passed**

**Result omnidirectional antenna A, 10m cable:**

Modulation Channel	Gain		
	Lowest	Middle	Highest
	-5.71	-4.94	-6.34
Measurement uncertainty	± 3 dB		

**Result: Passed****Result omnidirectional antenna B, 10m cable:**

Modulation Channel	Gain		
	Lowest	Middle	Highest
	-4.33	-4.50	-5.25
Measurement uncertainty	± 3 dB		

**Result: Passed****Result omnidirectional antenna A, 20m cable:**

Modulation Channel	Gain		
	Lowest	Middle	Highest
	-7.23	-6.33	-7.06
Measurement uncertainty	± 3 dB		

**Result: Passed****Result omnidirectional antenna B, 20m cable:**

Modulation Channel	Gain		
	Lowest	Middle	Highest
	-4.97	-5.44	-5.79
Measurement uncertainty	± 3 dB		

**Result: Passed**

## 9.2 Duty cycle

### Measurement:

Measurement parameter	
Detector:	Peak
Sweep time:	Auto
Resolution bandwidth:	50 MHz
Video bandwidth:	30 MHz
Span:	Zero
Trace-Mode:	Video trigger / View

Plot 1: duty cycle of the transmitter

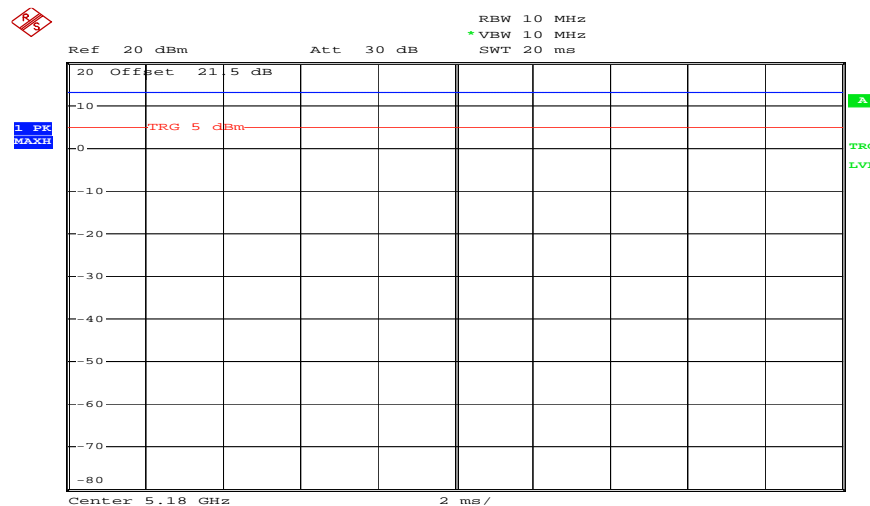

Date: 20.APR.2012 08:12:39

**Result:** 100% duty cycle

### 9.3 Maximum output power conducted and radiated

**Description:**

Measurement of the maximum output power conducted and radiated

**Measurement:** Method SA-1 alternative (for devices with 100 % duty cycle only)

Measurement parameter	
Detector:	RMS
Sweep time:	Auto
Resolution bandwidth:	1 MHz
Video bandwidth:	≥ 3 MHz
Span:	> EBW
Trace-Mode:	Max hold
Analyzer function	Band power / channel power Interval > 26 dB EBW

**Limits:**

Radiated output power	Conducted output power
23 dBm (calculated with 50mW and 6dBi antenna gain)	The lesser one of 50mW or 4 dBm + 10 log Bandwidth (where Bandwidth is the 26dB Bandwidth)

**Result:****Rod antenna A**

Modulation Channel	Maximum output power conducted [dBm]		
	Lowest	Middle	Highest
	10.44	9.85	9.67
Measurement uncertainty	± 1 dB		

Modulation Channel	Maximum output power radiated - EIRP [dBm]		
	Lowest	Middle	Highest
	13.84	14.80	14.65
Measurement uncertainty	± 3 dB		

**Result: Passed****Rod antenna B**

Modulation Channel	Maximum output power conducted [dBm]		
	Lowest	Middle	Highest
	9.89	9.48	10.03
Measurement uncertainty	± 1 dB		

Modulation Channel	Maximum output power radiated - EIRP [dBm]		
	Lowest	Middle	Highest
	14.06	14.10	12.93
Measurement uncertainty	± 3 dB		

**Result: Passed**

**Planar antenna A with 10 m cable**

Modulation Channel	Maximum output power conducted [dBm]		
	Lowest	Middle	Highest
	10.44	9.85	9.67
Measurement uncertainty	± 1 dB		

Modulation Channel	Maximum output power radiated - EIRP [dBm]		
	Lowest	Middle	Highest
	16.58	16.07	15.40
Measurement uncertainty	± 3 dB		

**Result: Passed****Planar antenna B with 10 m cable**

Modulation Channel	Maximum output power conducted [dBm]		
	Lowest	Middle	Highest
	9.89	9.48	10.03
Measurement uncertainty	± 1 dB		

Modulation Channel	Maximum output power radiated - EIRP [dBm]		
	Lowest	Middle	Highest
	16.68	15.94	16.04
Measurement uncertainty	± 3 dB		

**Result: Passed**



**Planar antenna A with 20 m cable**

Modulation Channel	Maximum output power conducted [dBm]		
	Lowest	Middle	Highest
	10.44	9.85	9.67
Measurement uncertainty	± 1 dB		

Modulation Channel	Maximum output power radiated - EIRP [dBm]		
	Lowest	Middle	Highest
	13.97	12.75	13.35
Measurement uncertainty	± 3 dB		

**Result: Passed****Planar antenna B with 20 m cable**

Modulation Channel	Maximum output power conducted [dBm]		
	Lowest	Middle	Highest
	9.89	9.48	10.03
Measurement uncertainty	± 1 dB		

Modulation Channel	Maximum output power radiated - EIRP [dBm]		
	Lowest	Middle	Highest
	14.48	13.46	14.67
Measurement uncertainty	± 3 dB		

**Result: Passed**

**Omnidirectional antenna A with 10 m cable**

Modulation Channel	Maximum output power conducted [dBm]		
	Lowest	Middle	Highest
	10.44	9.85	9.67
Measurement uncertainty	± 1 dB		

Modulation Channel	Maximum output power radiated - EIRP [dBm]		
	Lowest	Middle	Highest
	4.73	4.91	3.33
Measurement uncertainty	± 3 dB		

**Result: Passed****Omnidirectional antenna B with 10 m cable**

Modulation Channel	Maximum output power conducted [dBm]		
	Lowest	Middle	Highest
	9.89	9.48	10.03
Measurement uncertainty	± 1 dB		

Modulation Channel	Maximum output power radiated - EIRP [dBm]		
	Lowest	Middle	Highest
	5.56	4.98	4.78
Measurement uncertainty	± 3 dB		

**Result: Passed**

**Omnidirectional antenna A with 20 m cable**

Modulation Channel	Maximum output power conducted [dBm]		
	Lowest	Middle	Highest
	10.44	9.85	9.67
Measurement uncertainty	± 1 dB		

Modulation Channel	Maximum output power radiated - EIRP [dBm]		
	Lowest	Middle	Highest
	3.21	3.52	2.61
Measurement uncertainty	± 3 dB		

**Result: Passed****Omnidirectional antenna B with 20 m cable**

Modulation Channel	Maximum output power conducted [dBm]		
	Lowest	Middle	Highest
	9.89	9.48	10.03
Measurement uncertainty	± 1 dB		

Modulation Channel	Maximum output power radiated - EIRP [dBm]		
	Lowest	Middle	Highest
	4.92	4.04	4.24
Measurement uncertainty	± 3 dB		

**Result: Passed**

**Plots antenna A:**

**Plot 1: lowest channel**

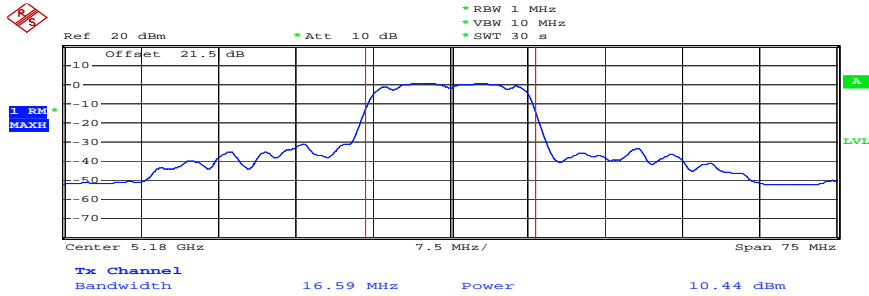

Date: 19.APR.2012 13:41:07

**Plot 2: middle channel**

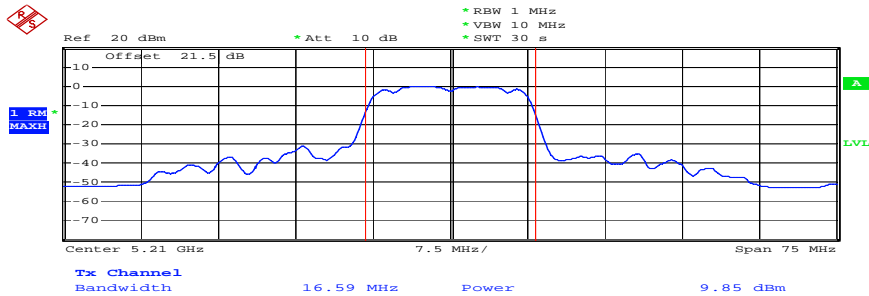

Date: 19.APR.2012 13:43:02

**Plot 3: highest channel**

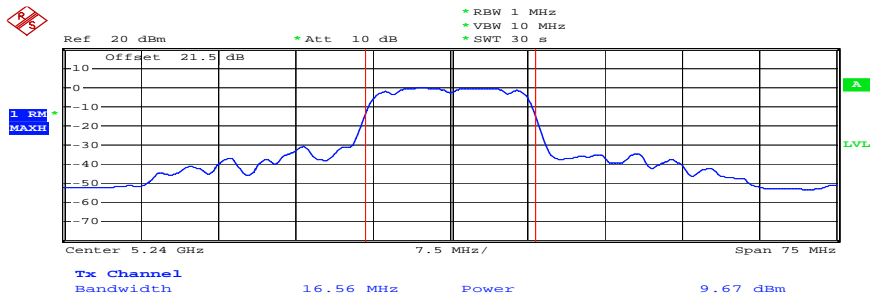

Date: 19.APR.2012 13:45:21

**Plots antenna B:**

**Plot 1: lowest channel**

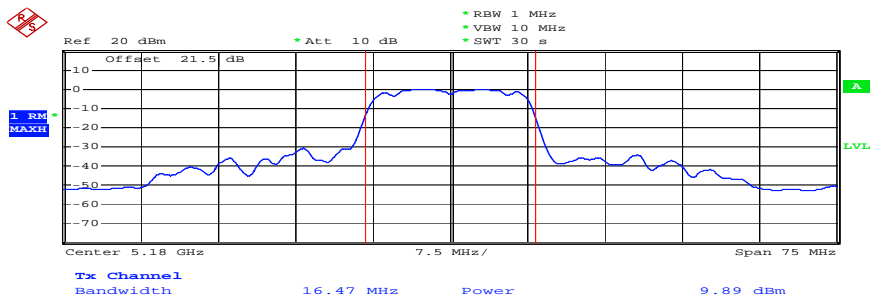

Date: 19.APR.2012 13:47:57

**Plot 2: middle channel**

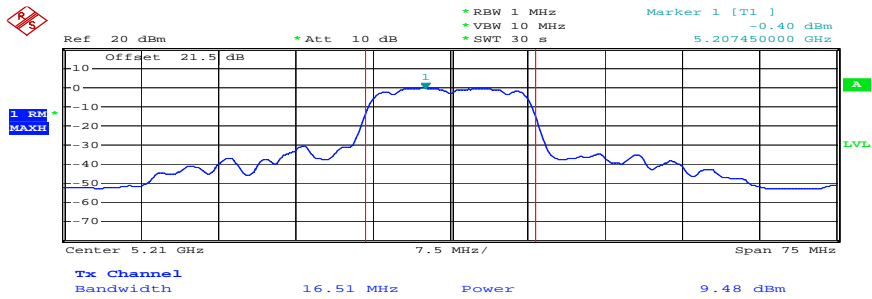

Date: 19.APR.2012 13:51:16

**Plot 3: highest channel**

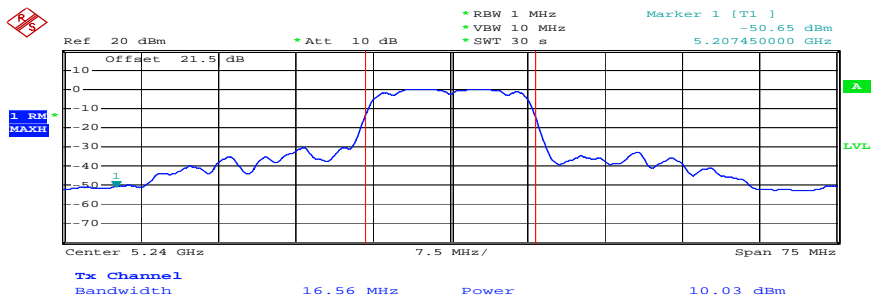

Date: 19.APR.2012 13:53:57

## 9.4 Power spectral density

### Description:

Measurement of the power spectral density of a digital modulated system. The measurement is repeated at the lowest, middle and highest channel.

**Measurement:** Method SA-1 alternative (for devices with 100 % duty cycle only)

Measurement parameter	
Detector:	RMS
Sweep time:	Auto
Resolution bandwidth:	1 MHz
Video bandwidth:	≥ 3 MHz
Span:	> EBW
Trace-Mode:	Max hold

### Limits:

Power Spectral Density
The transmitter power spectral density conducted from the transmitter to the antenna shall not be greater than 4 dBm in any 1 MHz band

### Results: antenna A

Modulation Channel	Power Spectral density [dBm/MHz]		
	Lowest	Middle	Highest
	0.28	-0.27	-0.77
Measurement uncertainty	± 1.5 dB		

**Result: Passed**

### Results: antenna B

Modulation Channel	Power Spectral density [dBm/MHz]		
	Lowest	Middle	Highest
	0.05	-0.55	-0.24
Measurement uncertainty	± 1.5 dB		

**Result: Passed**

**Plots antenna A:**

**Plot 1: lowest channel**

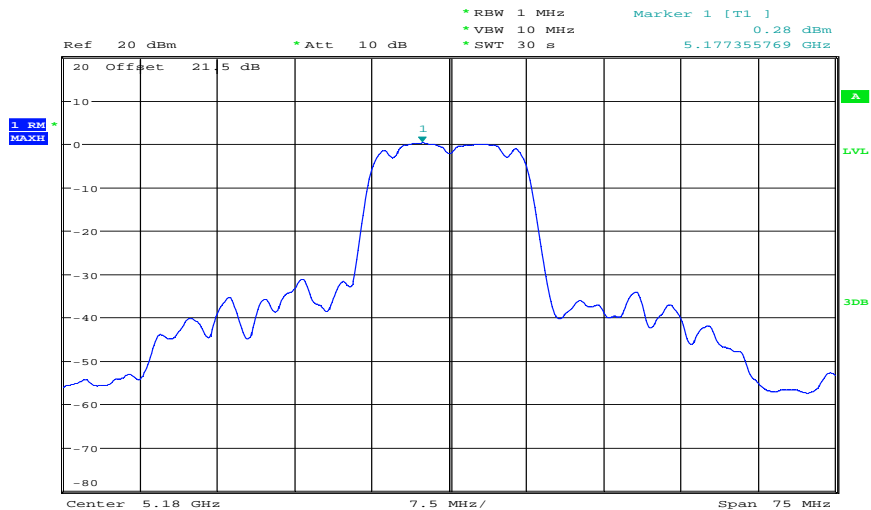

Date: 19.APR.2012 11:39:21

**Plot 2: middle channel**

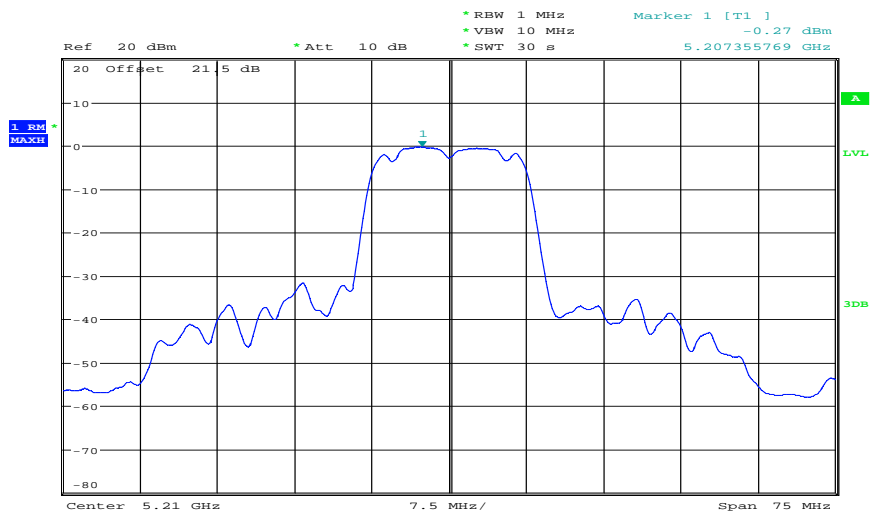

Date: 19.APR.2012 11:40:17



**Plot 3: highest channel**

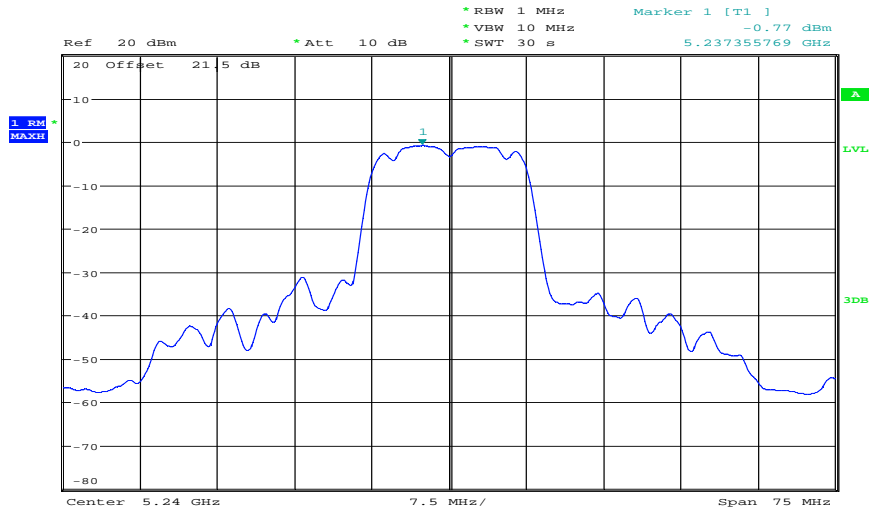

Date: 19.APR.2012 11:41:07

**Plots antenna B:**

**Plot 1: lowest channel**

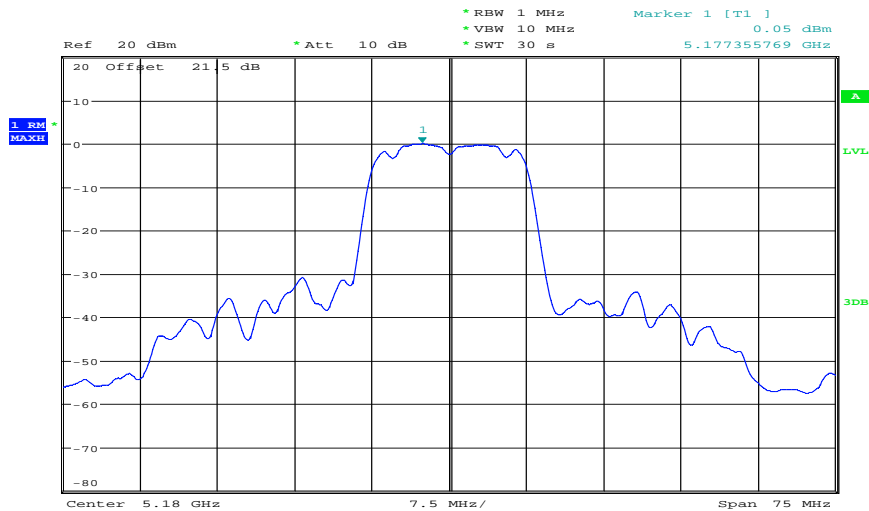

Date: 19.APR.2012 11:42:37

Plot 2: middle channel

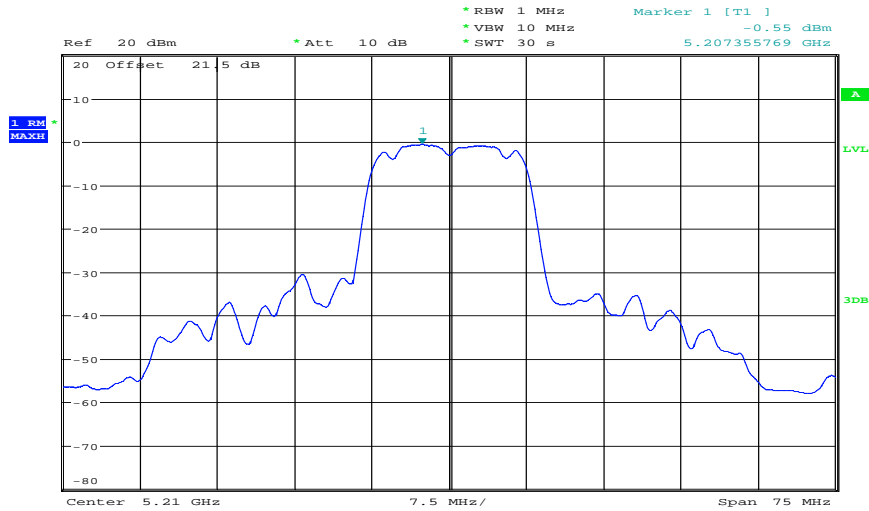

Date: 19.APR.2012 11:43:37

Plot 3: highest channel

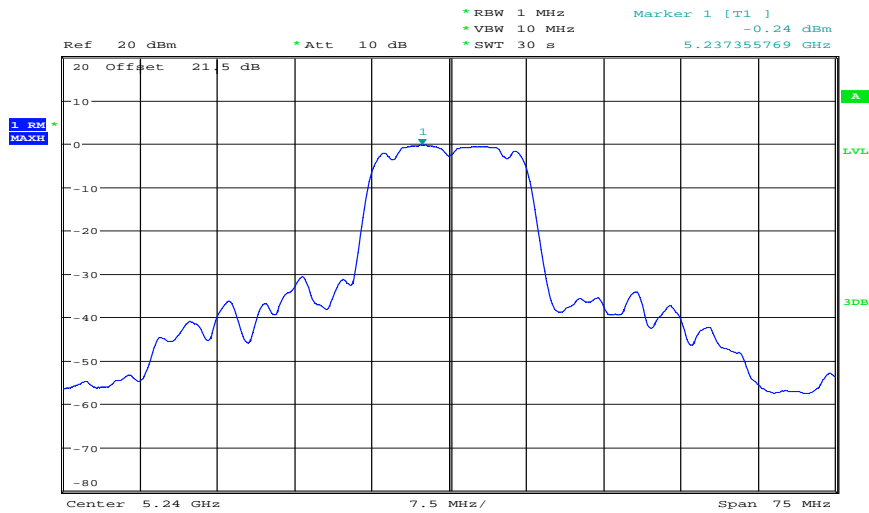

Date: 19.APR.2012 11:44:27

## 9.5 Spectrum bandwidth – 26 dB bandwidth

### Description:

Measurement of the 26 dB bandwidth of the modulated signal.

### Measurement:

Measurement parameter	
Detector:	Peak
Sweep time:	Auto
Resolution bandwidth:	1% EBW
Video bandwidth:	≥ EBW
Span:	Full signal
Trace-Mode:	Max hold

### Limits:

Spectrum Bandwidth – 26 dB Bandwidth
-/-

### Results:

#### Antenna A:

Modulation Channel	26 dB BANDWIDTH [MHz]		
	Lowest	Middle	Highest
	16.59	16.59	16.56
Measurement uncertainty	± 100 kHz		

**Result: Passed**

#### Antenna B:

Modulation Channel	26 dB BANDWIDTH [MHz]		
	Lowest	Middle	Highest
	16.47	16.51	16.56
Measurement uncertainty	± 100 kHz		

**Result: Passed**

**Plots antenna A:**

**Plot 1: lowest channel**

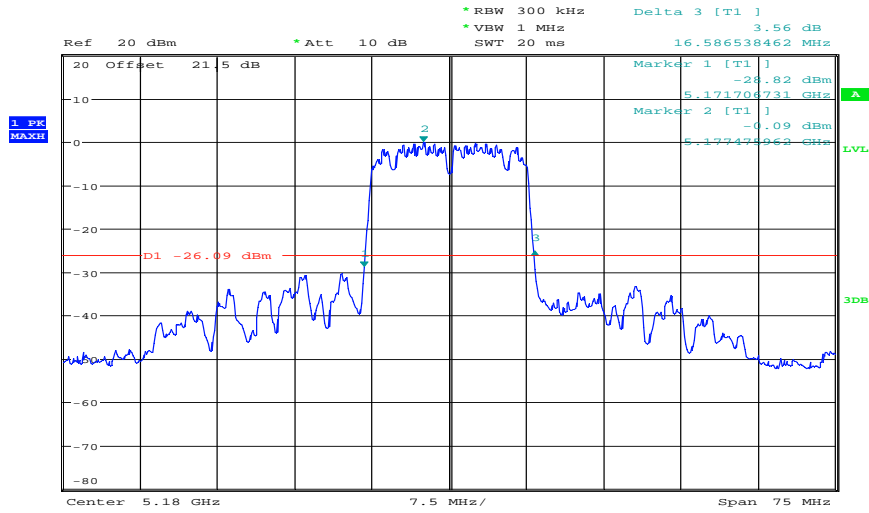

Date: 19.APR.2012 12:42:18

**Plot 2: middle channel**

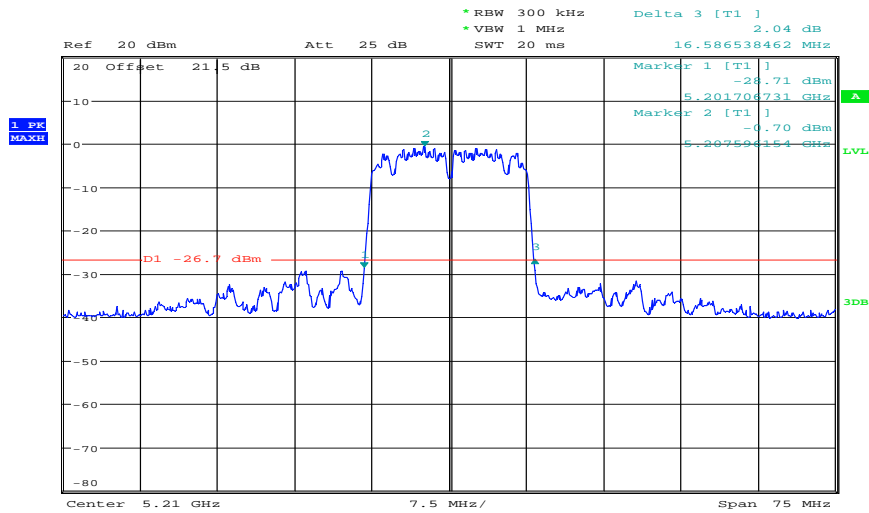

Date: 19.APR.2012 13:22:15

**Plot 3: highest channel**

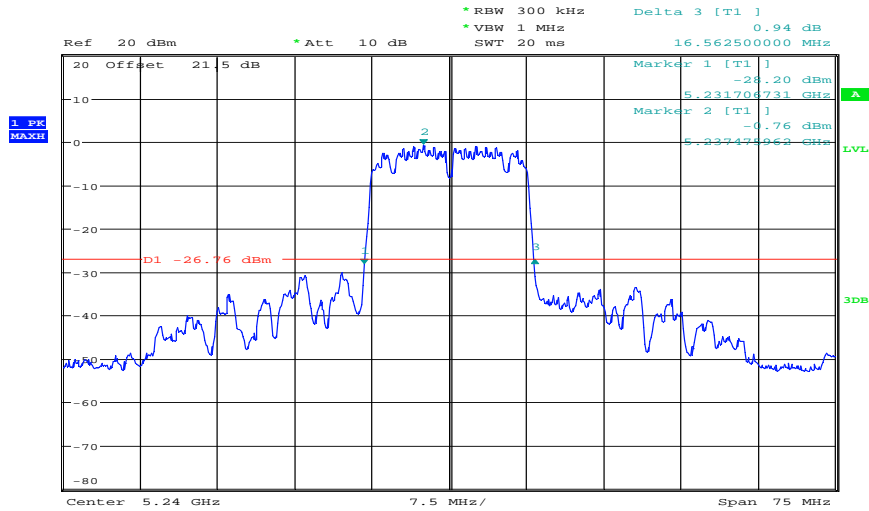

Date: 19.APR.2012 12:44:44

**Plots antenna B:**

**Plot 1: lowest channel**

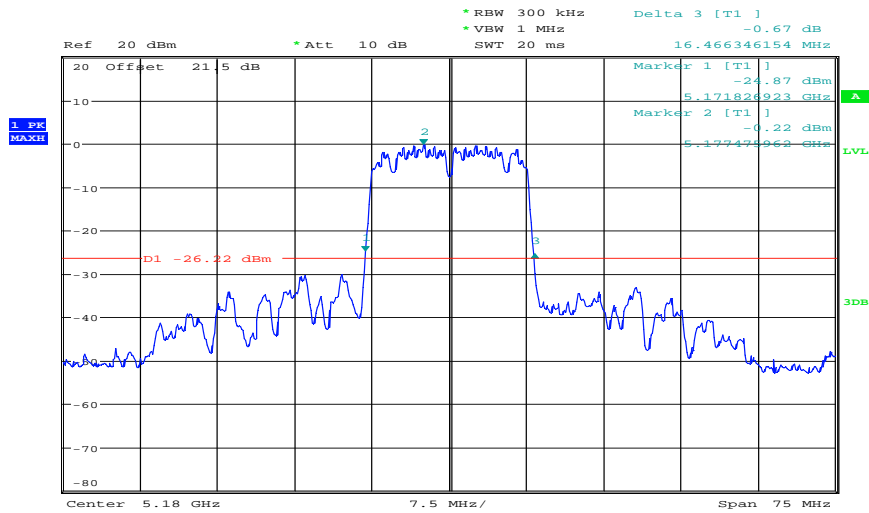

Date: 19.APR.2012 12:46:28

Plot 2: middle channel

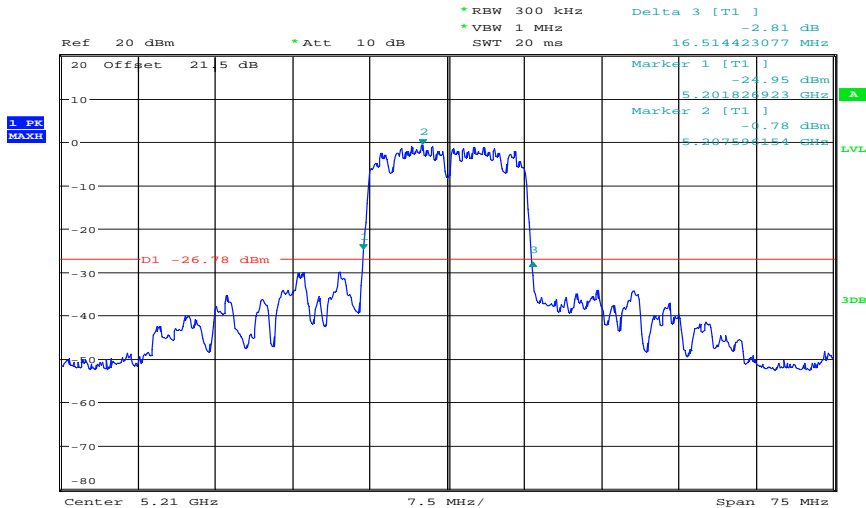

Date: 19.APR.2012 12:47:44

Plot 3: highest channel

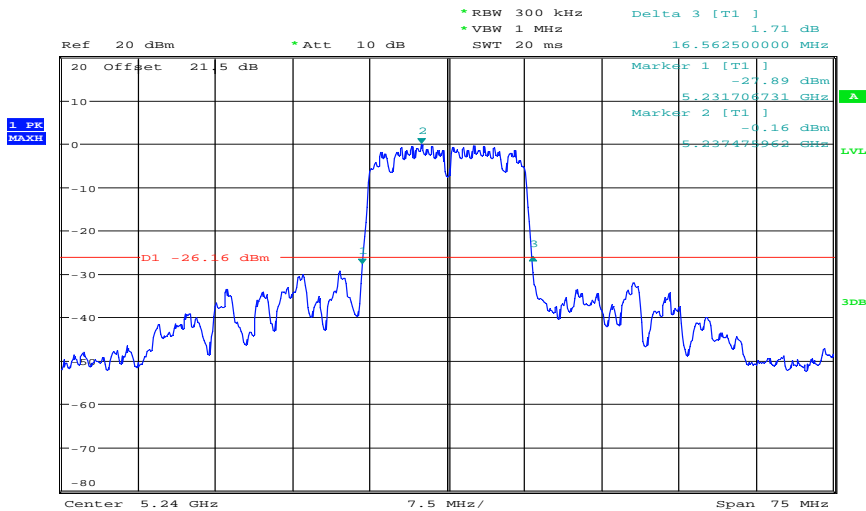

Date: 19.APR.2012 12:48:43

## 9.6 Occupied bandwidth – 20 dB bandwidth

Measurement parameter:

Measurement parameter	
Detector:	Peak
Sweep time:	Auto
Resolution bandwidth:	10 kHz
Video bandwidth:	10 kHz
Span:	Depends on Modulation
Trace-Mode:	Max Hold

Results (normal Voltage):

	<i>lowest channel</i>	<i>mid channel</i>	<i>highest channel</i>
Occupied Bandwidth [MHz] 99 % power	15.07	15.07	15.07

## 9.7 Peak excursion measurements

**Description:**

Peak to average value.

**Measurement:**

Measurement parameter	
Detector:	Peak
Sweep time:	Auto
Resolution bandwidth:	1 RBW
Video bandwidth:	≥ 3 MHz
Span:	Full signal
Trace-Mode:	Max hold

**Limits:**

Peak excursion value
Does not exceed 13 dB.

**Results:**

Antenna A:

Modulation Channel	Peak excursion value		
	Lowest	Middle	Highest
Peak	4.07	3.44	2.80
Average	0.28	-0.27	-0.77
Delta value	3.79	3.71	3.57
Measurement uncertainty	± 0.5 dB		

**Result: Passed**



**Results:**

Antenna B:

Modulation Channel	Peak excursion value		
	Lowest	Middle	Highest
Peak	3.90	3.32	3.39
Average	0.05	-0.55	-0.24
Delta value	3.85	3.88	3.63
Measurement uncertainty	± 0.5 dB		

**Result: Passed**

**Plots antenna A:**

**Plot 1: lowest channel**

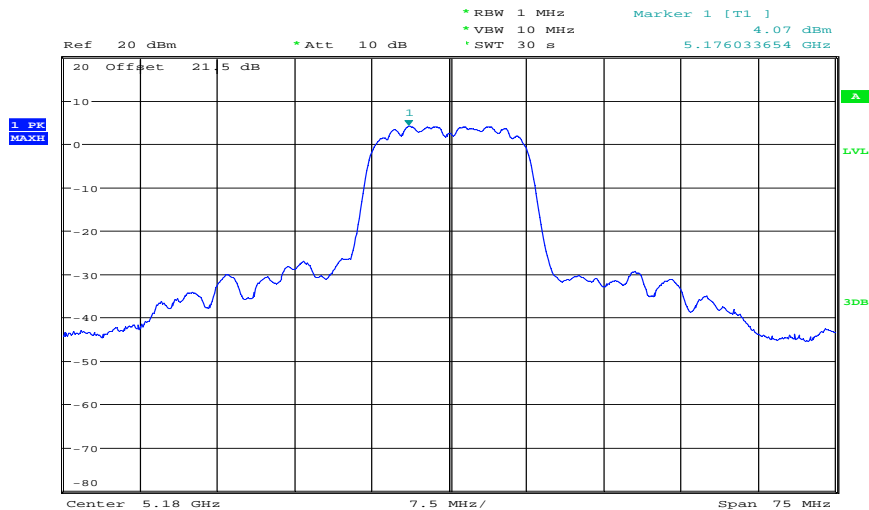

Date: 19.APR.2012 11:30:54

**Plot 2: middle channel**

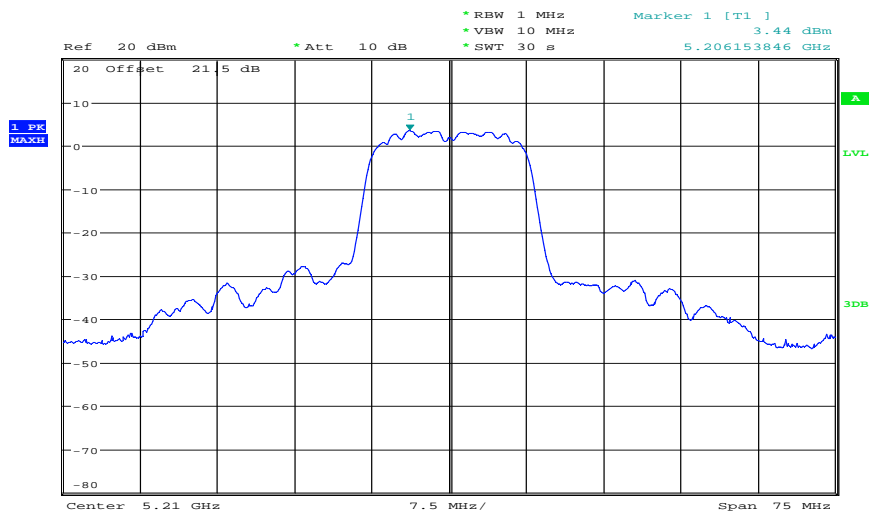

Date: 19.APR.2012 11:32:41

**Plot 3: highest channel**

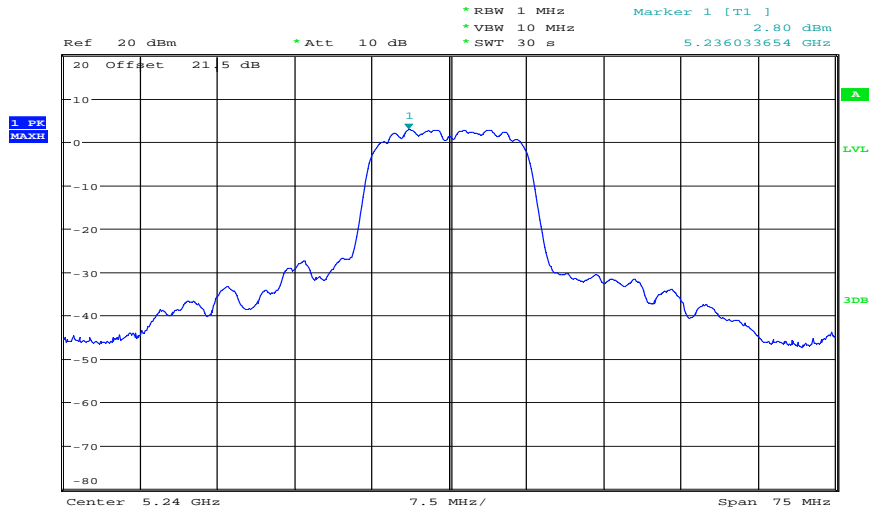

Date: 19.APR.2012 11:33:41

**Plots antenna B:**

**Plot 1: lowest channel**

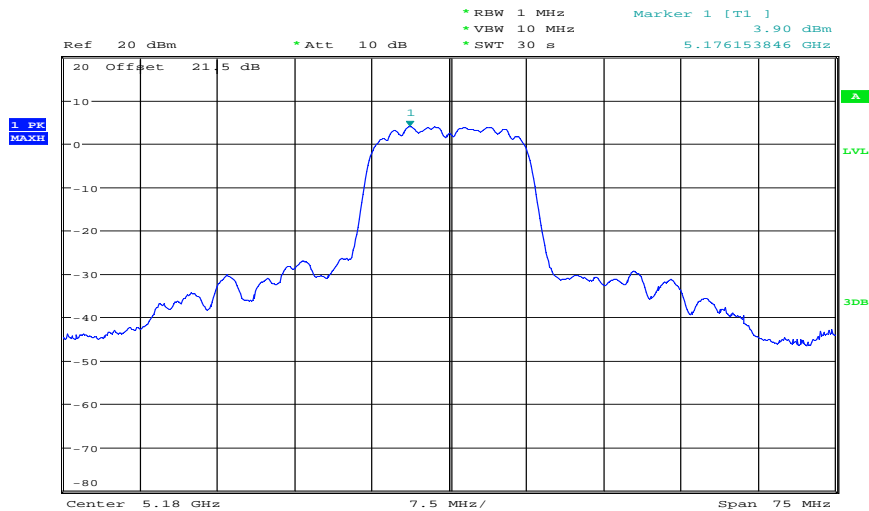

Date: 19.APR.2012 11:35:28

Plot 2: middle channel

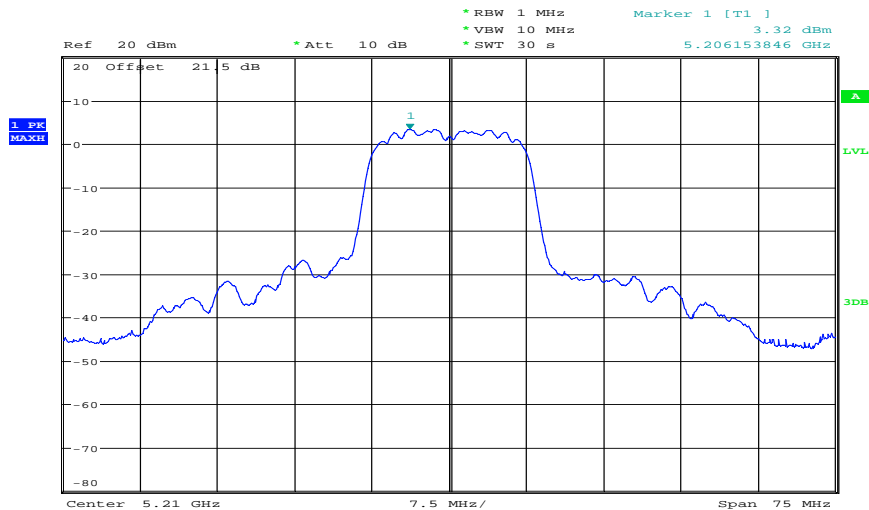

Date: 19.APR.2012 11:36:29

Plot 3: highest channel

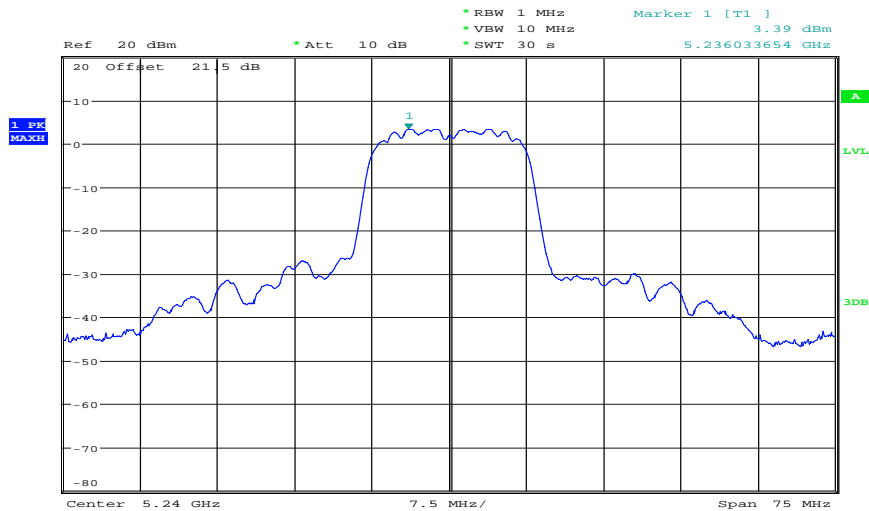

Date: 19.APR.2012 11:37:32

## 9.8 Band edge compliance radiated

### Description:

Measurement of the radiated band edge compliance. The EUT is turned in the position that results in the maximum level at the band edge. Then a sweep over the corresponding restricted band is performed. The EUT is set to the lowest channel for the lower restricted band and to the highest channel for the upper restricted band. Measurement distance is 3m.

### Measurement:

Measurement parameter	
Detector:	Peak / RMS
Sweep time:	Auto
Resolution bandwidth:	1 MHz
Video bandwidth:	10 Hz / 3 MHz
Span:	5150 MHz $\pm$ 100 MHz
Trace-Mode:	Max Hold

### Limits:

Band Edge Compliance Radiated
In any 100 kHz bandwidth outside the frequency band in which the spread spectrum or digitally modulated intentional radiator is operating, the radio frequency power that is produced by the intentional radiator shall be at least 20 dB below that in the 100 kHz bandwidth within the band that contains the highest level of the desired power, based on either an RF conducted or a radiated measurement. Attenuation below the general limits specified in Section 15.209(a) is not required. In addition, radiated emissions which fall in the restricted bands, as defined in Section 15.205(a), must also comply with the radiated emission limits specified in Section 15.209(a) (see Section 5.205(c)).
54 dB $\mu$ V/m AVG

### Result:

Szenario	Band Edge Compliance Radiated [dB $\mu$ V/m]
Lower Band Edge	< 54 dB $\mu$ V/m (see plots 1/3)
Measurement uncertainty	$\pm$ 3 dB

**Result: Passed**

**Plots: Rod antenna A**

**Plot 1:** lower band edge, vertical and horizontal polarization

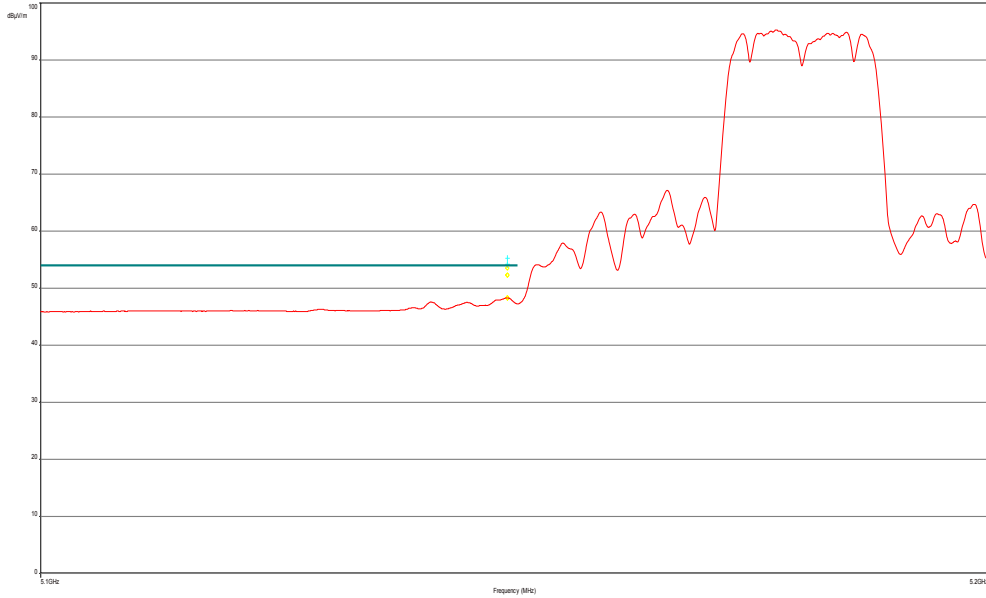

**Plots: Rod antenna B**

**Plot 1:** lower band edge, vertical and horizontal polarization

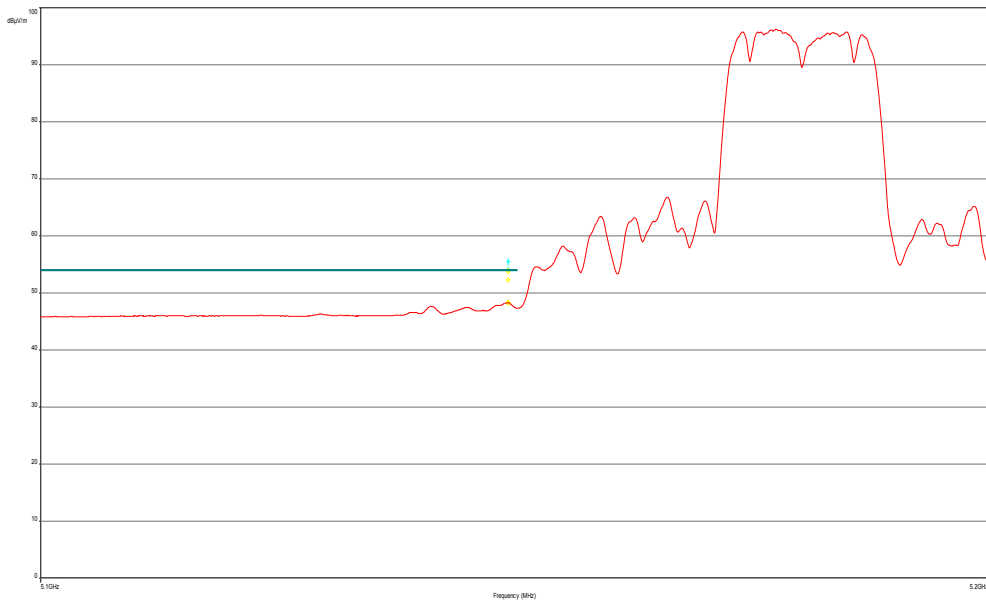

**Plots: Planar antenna A with 10 m cable**

**Plot 1:** lower band edge, vertical and horizontal polarization

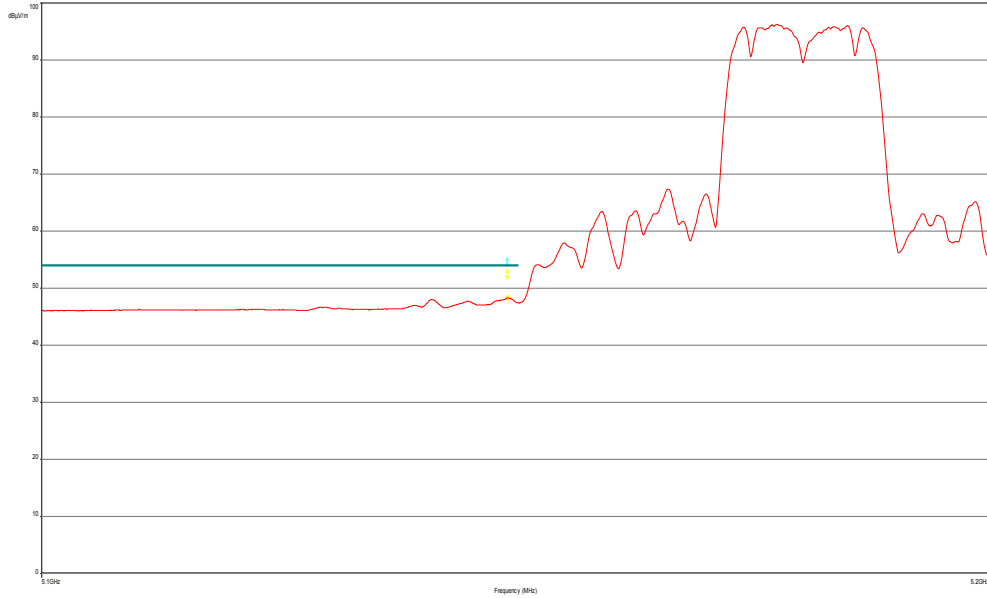

**Plots: Planar antenna B with 10 m cable**

**Plot 1:** lower band edge, vertical and horizontal polarization

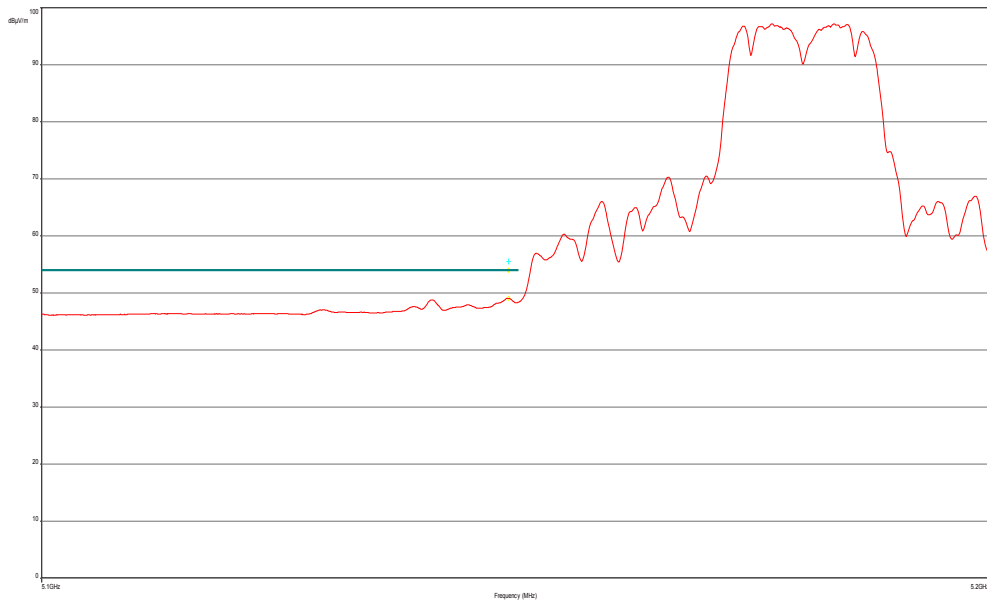

**Plots: Omnidirectional antenna A with 10 m cable**

**Plot 1:** lower band edge, vertical and horizontal polarization

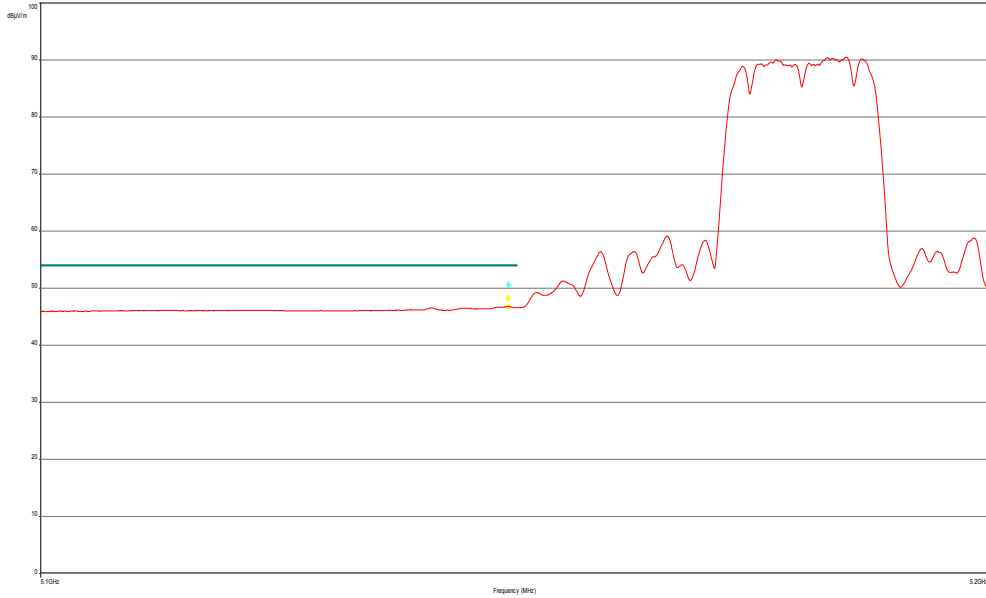

**Plots: Omnidirectional antenna B with 10 m cable**

**Plot 1:** lower band edge, vertical and horizontal polarization

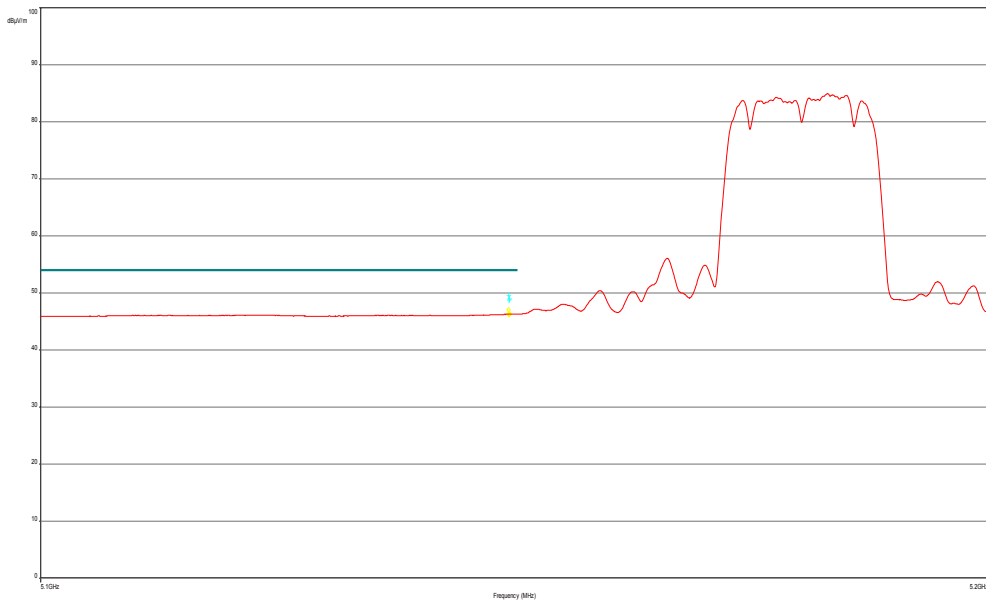



## 9.9 TX spurious emissions radiated

### Description:

Measurement of the radiated spurious emissions in transmit mode. The measurement is performed at lowest, middle and highest channel.

### Measurement:

Measurement parameter	
Detector:	Quasi Peak below 1 GHz (alternative Peak) Peak above 1 GHz / RMS
Sweep time:	Auto
Resolution bandwidth:	F < 1 GHz: 100 kHz F > 1 GHz: 1 MHz
Video bandwidth:	F < 1 GHz: 100 kHz F > 1 GHz: ≥ 3 MHz / 10 Hz
Span:	30 MHz to 25 GHz
Trace-Mode:	Max Hold / Average with 100 counts + 20 log (1 / X) for duty cycle lower than 100 %

### Limits:

TX Spurious Emissions Radiated		
§15.209		
Frequency (MHz)	Field Strength (dBµV/m)	Measurement distance
30 - 88	30.0	10
88 - 216	33.5	10
216 - 960	36.0	10
Above 960	54.0	3
§15.407		
Outside the restricted bands!	-27 dBm / MHz	

**Results: Rod antenna A**

TX Spurious Emissions Radiated [dB $\mu$ V/m] / dBm								
Lowest			Middle			Highest		
F [MHz]	Detector	Level [dB $\mu$ V/m]	F [MHz]	Detector	Level [dB $\mu$ V/m]	F [MHz]	Detector	Level [dB $\mu$ V/m]
No critical peaks found			No critical peaks found			No critical peaks found		
Measurement uncertainty			± 3 dB					

**Results: Rod antenna B**

TX Spurious Emissions Radiated [dB $\mu$ V/m] / dBm								
Lowest			Middle			Highest		
F [MHz]	Detector	Level [dB $\mu$ V/m]	F [MHz]	Detector	Level [dB $\mu$ V/m]	F [MHz]	Detector	Level [dB $\mu$ V/m]
No critical peaks found			No critical peaks found			No critical peaks found		
Measurement uncertainty			± 3 dB					

**Results: Planar antenna A with 10 m cable**

TX Spurious Emissions Radiated [dB $\mu$ V/m] / dBm								
Lowest			Middle			Highest		
F [MHz]	Detector	Level [dB $\mu$ V/m]	F [MHz]	Detector	Level [dB $\mu$ V/m]	F [MHz]	Detector	Level [dB $\mu$ V/m]
No critical peaks found			No critical peaks found			No critical peaks found		
Measurement uncertainty			± 3 dB					

**Results: Planar antenna B with 10 m cable**

TX Spurious Emissions Radiated [dB $\mu$ V/m] / dBm								
Lowest			Middle			Highest		
F [MHz]	Detector	Level [dB $\mu$ V/m]	F [MHz]	Detector	Level [dB $\mu$ V/m]	F [MHz]	Detector	Level [dB $\mu$ V/m]
No critical peaks found			No critical peaks found			No critical peaks found		
Measurement uncertainty			± 3 dB					

**Results: Planar antenna A with 20 m cable**

TX Spurious Emissions Radiated [dB $\mu$ V/m] / dBm								
Lowest			Middle			Highest		
F [MHz]	Detector	Level [dB $\mu$ V/m]	F [MHz]	Detector	Level [dB $\mu$ V/m]	F [MHz]	Detector	Level [dB $\mu$ V/m]
No critical peaks found			No critical peaks found			No critical peaks found		
Measurement uncertainty			$\pm 3$ dB					

**Results: Planar antenna B with 20 m cable**

TX Spurious Emissions Radiated [dB $\mu$ V/m] / dBm								
Lowest			Middle			Highest		
F [MHz]	Detector	Level [dB $\mu$ V/m]	F [MHz]	Detector	Level [dB $\mu$ V/m]	F [MHz]	Detector	Level [dB $\mu$ V/m]
No critical peaks found			No critical peaks found			No critical peaks found		
Measurement uncertainty			$\pm 3$ dB					

**Results: Omnidirectional antenna A with 10 m cable**

TX Spurious Emissions Radiated [dB $\mu$ V/m] / dBm								
Lowest			Middle			Highest		
F [MHz]	Detector	Level [dB $\mu$ V/m]	F [MHz]	Detector	Level [dB $\mu$ V/m]	F [MHz]	Detector	Level [dB $\mu$ V/m]
No critical peaks found			No critical peaks found			No critical peaks found		
Measurement uncertainty			$\pm 3$ dB					

**Results: Omnidirectional antenna B with 10 m cable**

TX Spurious Emissions Radiated [dB $\mu$ V/m] / dBm								
Lowest			Middle			Highest		
F [MHz]	Detector	Level [dB $\mu$ V/m]	F [MHz]	Detector	Level [dB $\mu$ V/m]	F [MHz]	Detector	Level [dB $\mu$ V/m]
No critical peaks found			No critical peaks found			No critical peaks found		
Measurement uncertainty			$\pm 3$ dB					

**Results: Omnidirectional antenna A with 20 m cable**

TX Spurious Emissions Radiated [dB $\mu$ V/m] / dBm								
Lowest			Middle			Highest		
F [MHz]	Detector	Level [dB $\mu$ V/m]	F [MHz]	Detector	Level [dB $\mu$ V/m]	F [MHz]	Detector	Level [dB $\mu$ V/m]
No critical peaks found			No critical peaks found			No critical peaks found		
Measurement uncertainty			± 3 dB					

**Results: Omnidirectional antenna B with 20 m cable**

TX Spurious Emissions Radiated [dB $\mu$ V/m] / dBm								
Lowest			Middle			Highest		
F [MHz]	Detector	Level [dB $\mu$ V/m]	F [MHz]	Detector	Level [dB $\mu$ V/m]	F [MHz]	Detector	Level [dB $\mu$ V/m]
No critical peaks found			No critical peaks found			No critical peaks found		
Measurement uncertainty			± 3 dB					

**Result: Passed.**

**Plots: Rod antenna A**

**Plot 1: Lowest channel, 30 MHz to 1 GHz, vertical & horizontal polarization**

**Common Information**

EUT: Quinta CU  
 Serial Number: 00101  
 Test Description: FCC part 15 class B @ 10 m  
 Operating Conditions: ANT A, tx@5180MHz  
 Operator Name: Hennemann  
 Comment: AC: 115 V / 60 Hz; ETH-cable S/FTP

**Scan Setup: STAN\_Fin [EMI radiated]**

Hardware Setup: Electric Field (NOS)  
 Receiver: [ESCI 3]  
 Level Unit: dBµV/m  
**Subrange**                      **Step Size**                      **Detectors**                      **IF BW**                      **Meas. Time**                      **Preamp**  
 30 MHz - 2 GHz                      60 kHz                      QPK                      120 kHz                      1 s                      20 dB

FCC\_10m(B)\_5

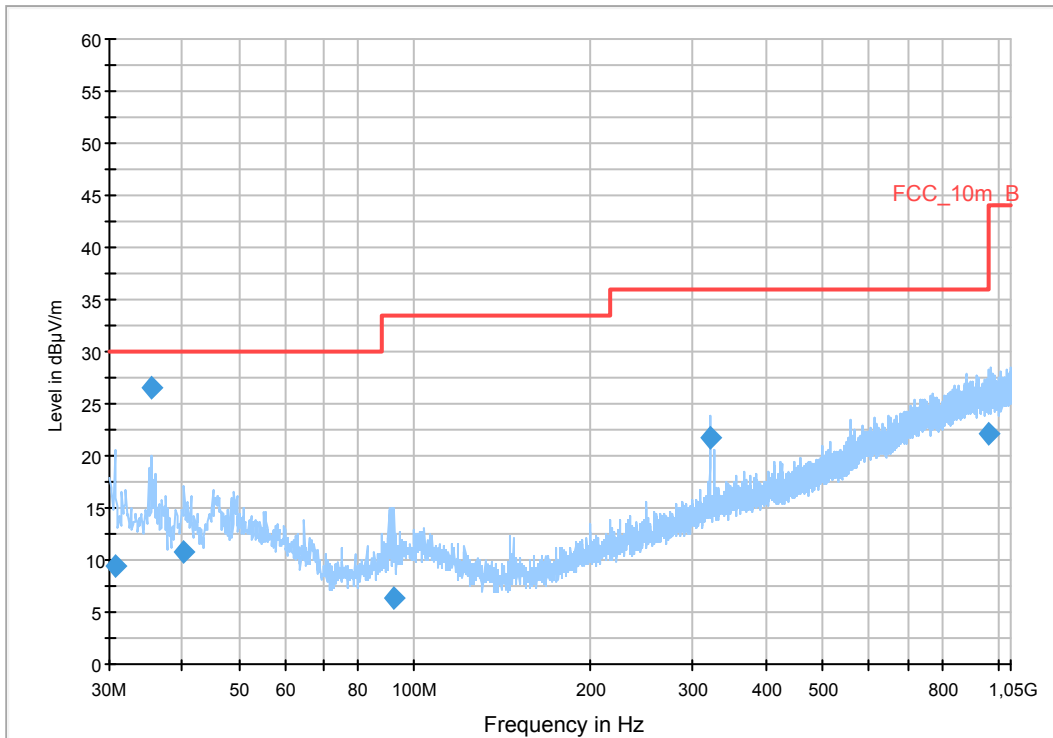

**Final Result 1**

Frequency (MHz)	QuasiPeak (dBµV/m)	Meas. Time (ms)	Bandwidth (kHz)	Height (cm)	Polarization	Azimuth (deg)	Corr. (dB)	Margin (dB)	Limit (dBµV/m)	Comment
30.600000	9.4	1000.0	120.000	115.0	H	214.0	12.6	20.6	30.0	
35.400000	26.6	1000.0	120.000	194.0	V	258.0	13.1	3.4	30.0	
40.320000	10.8	1000.0	120.000	114.0	H	214.0	13.4	19.2	30.0	
92.400000	6.4	1000.0	120.000	270.0	H	214.0	10.9	27.1	33.5	
320.040000	21.7	1000.0	120.000	98.0	V	281.0	15.2	14.3	36.0	
959.280000	22.0	1000.0	120.000	98.0	H	258.0	25.4	14.0	36.0	

Plot 2: Lowest channel, 1 GHz to 12.75 GHz, vertical polarization

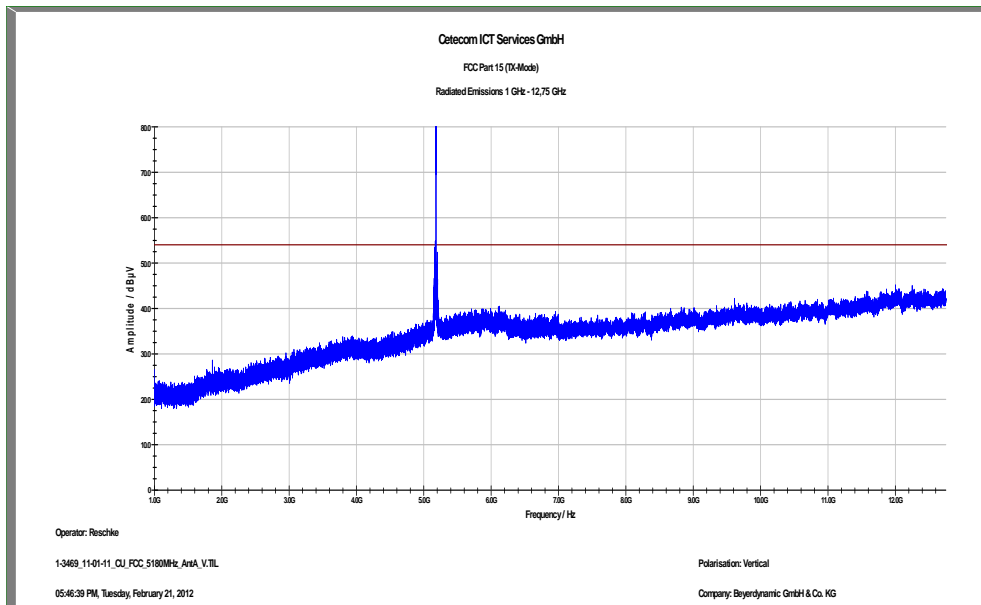

Plot 3: Lowest channel, 1 GHz to 12.75 GHz, horizontal polarization

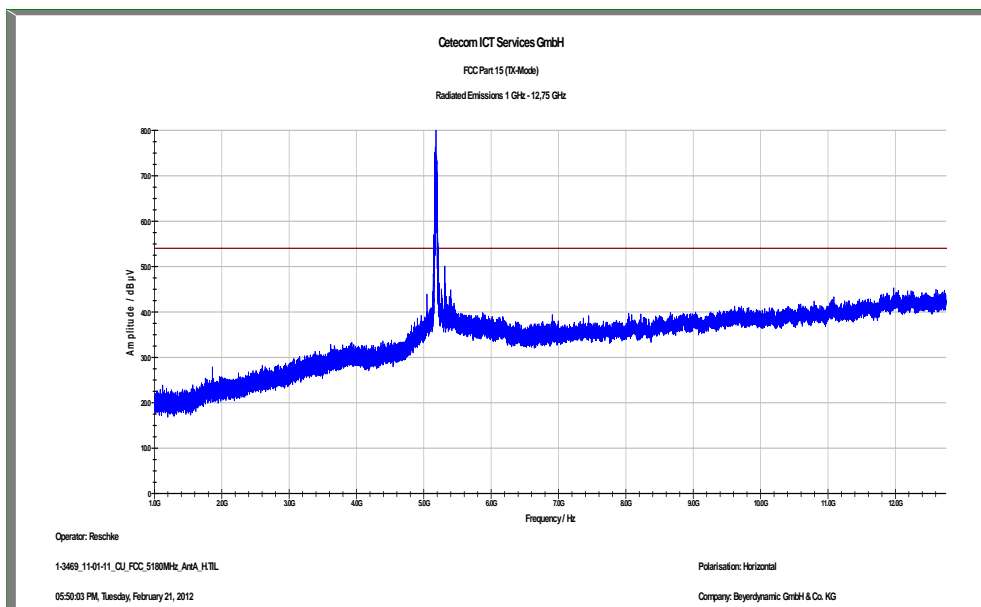



Plot 4: Lowest channel, 12 GHz to 18 GHz (vertical / horizontal – max hold – also valid for 20m)

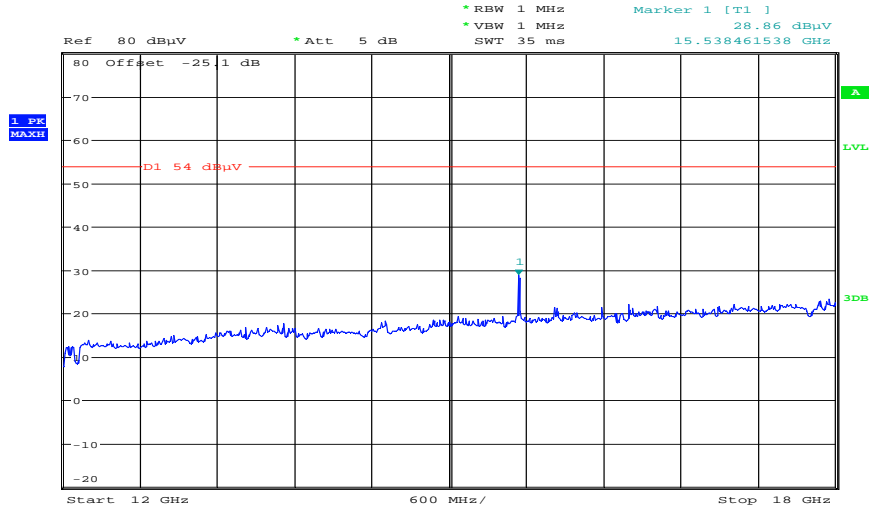

Date: 12.MAR.2012 12:57:09

Plot 5: Lowest channel, 18 GHz to 25 GHz (vertical / horizontal – max hold – also valid for 20m)

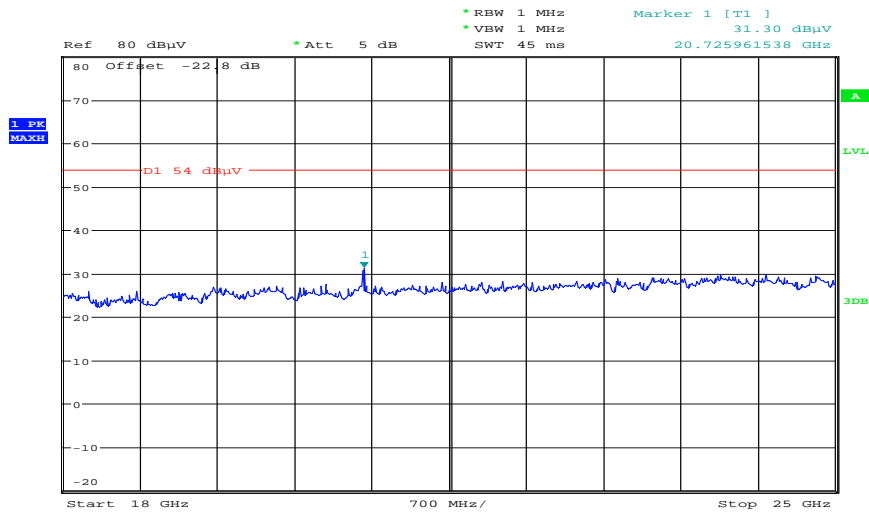

Date: 12.MAR.2012 10:07:28

Plot 6: Lowest channel, 25 GHz to 40 GHz (vertical / horizontal – max hold – also valid for 20m)

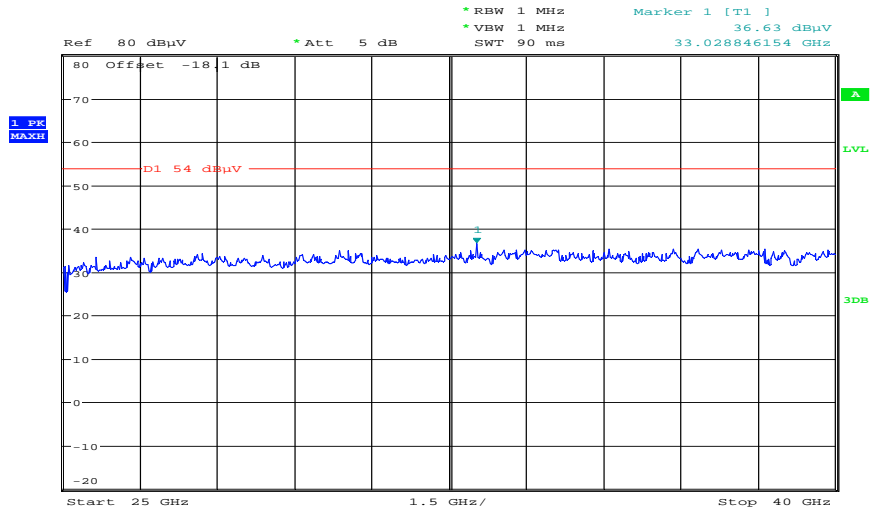

Date: 12.MAR.2012 10:50:49

**Plot 7: Middle channel, 30 MHz to 1 GHz, vertical & horizontal polarization**

**Common Information**

EUT: Quinta CU  
 Serial Number: 00101  
 Test Description: FCC part 15 class B @ 10 m  
 Operating Conditions: ANT A, tx@5210MHz  
 Operator Name: Hennemann  
 Comment: AC: 115 V / 60 Hz; ETH-cable S/FTP

**Scan Setup: STAN\_Fin [EMI radiated]**

Hardware Setup: Electric Field (NOS)  
 Receiver: [ESCI 3]  
 Level Unit: dBµV/m  
**Subrange**                      **Step Size**                      **Detectors**                      **IF BW**                      **Meas. Time**                      **Preamp**  
 30 MHz - 2 GHz                      60 kHz                      QPK                      120 kHz                      1 s                      20 dB

FCC\_10m(B)\_3

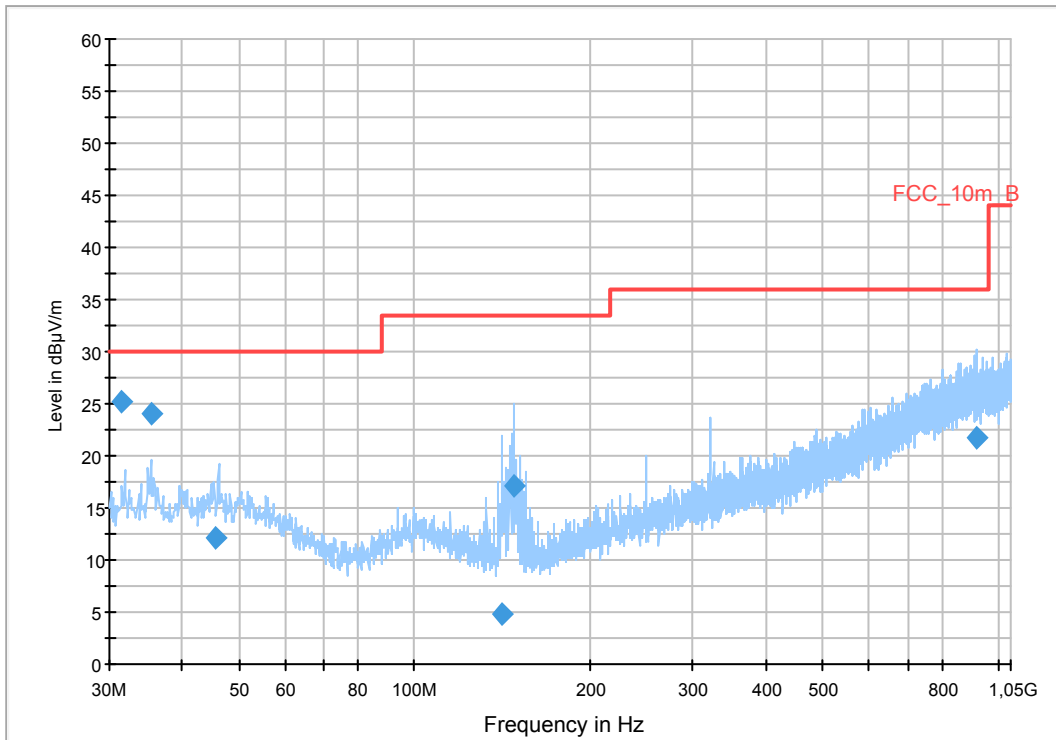

**Final Result 1**

Frequency (MHz)	QuasiPeak (dBµV/m)	Meas. Time (ms)	Bandwidth (kHz)	Height (cm)	Polarization	Azimuth (deg)	Corr. (dB)	Margin (dB)	Limit (dBµV/m)	Comment
31.420650	25.2	1000.0	120.000	155.0	V	184.0	12.7	4.8	30.0	
35.397450	24.0	1000.0	120.000	114.0	V	284.0	13.1	6.0	30.0	
45.772650	12.0	1000.0	120.000	170.0	V	274.0	13.3	18.0	30.0	
141.310800	4.7	1000.0	120.000	170.0	V	284.0	8.7	28.8	33.5	
148.115100	17.0	1000.0	120.000	170.0	V	285.0	8.9	16.5	33.5	
920.463600	21.8	1000.0	120.000	134.0	H	78.0	25.3	14.2	36.0	

Plot 8: Middle channel, 1 GHz to 12.75 GHz, vertical polarization

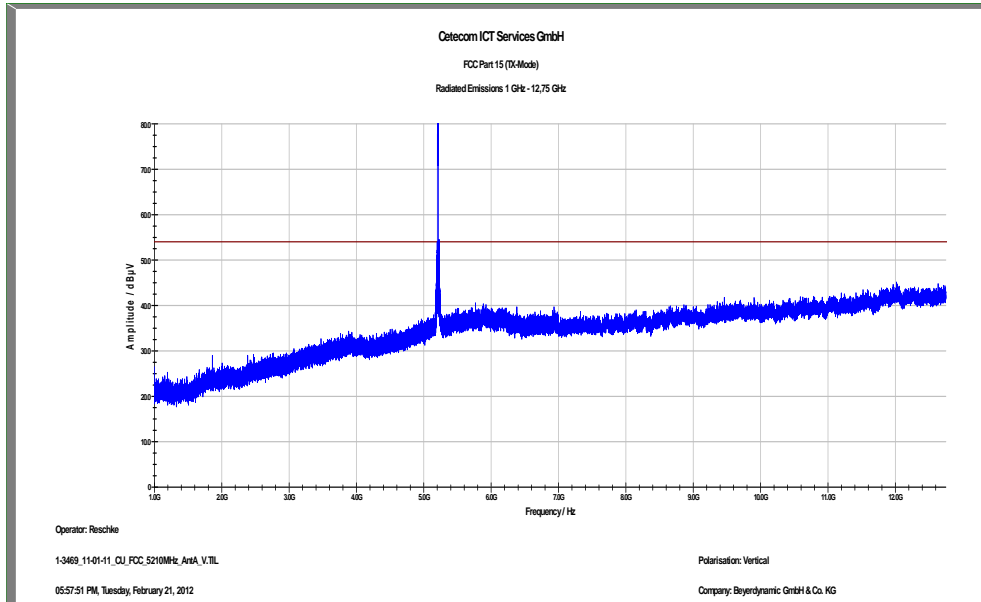

Plot 9: Middle channel, 1 GHz to 12.75 GHz, horizontal polarization

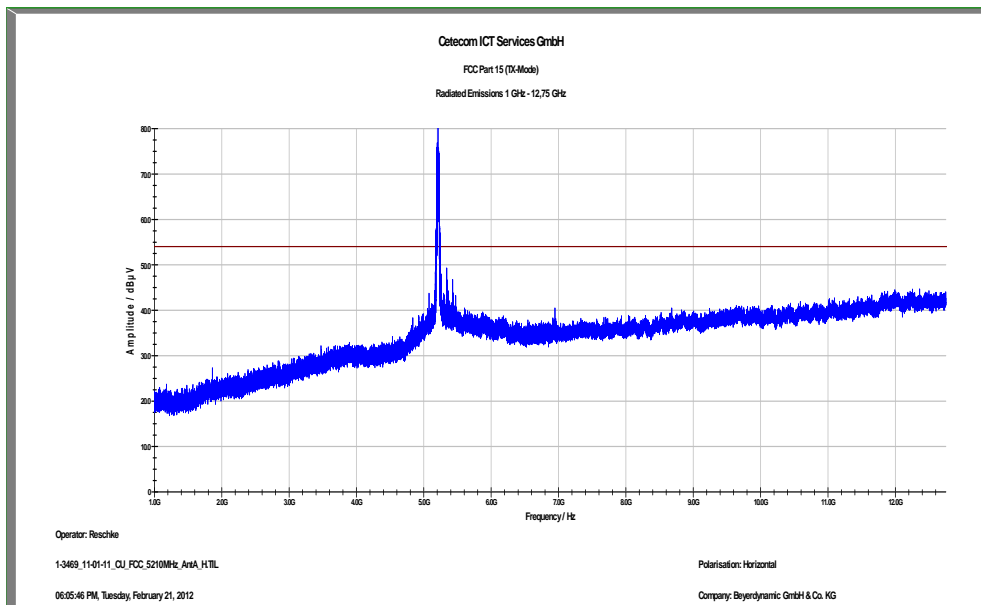

Plot 10: Middle channel, 12 GHz to 18 GHz (vertical / horizontal – max hold – also valid for 20m)

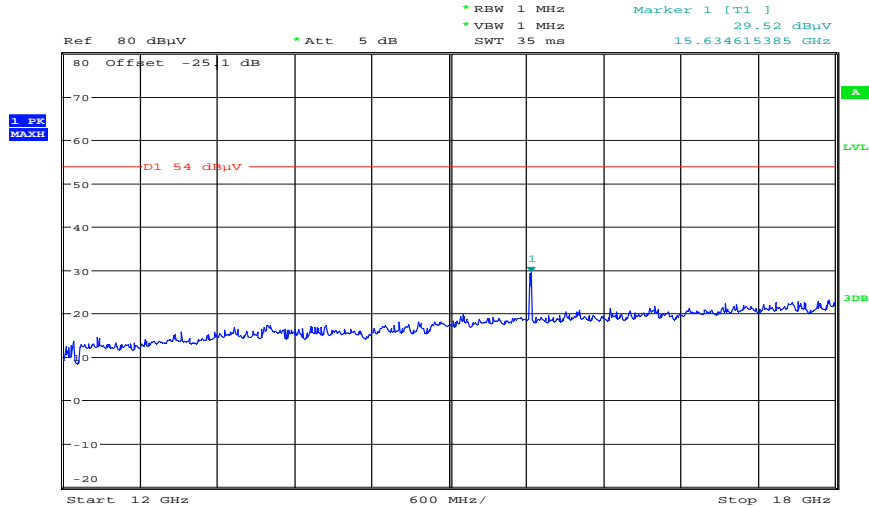

Date: 12.MAR.2012 12:57:58

Plot 11: Middle channel, 18 GHz to 25 GHz (vertical / horizontal – max hold – also valid for 20m)

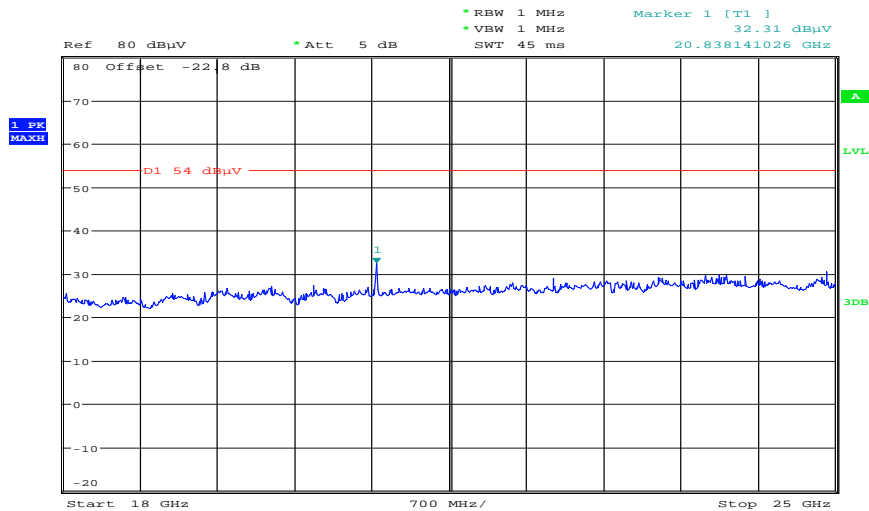

Date: 12.MAR.2012 10:08:00

Plot 12: Middle channel, 25 GHz to 40 GHz (vertical / horizontal – max hold – also valid for 20m)

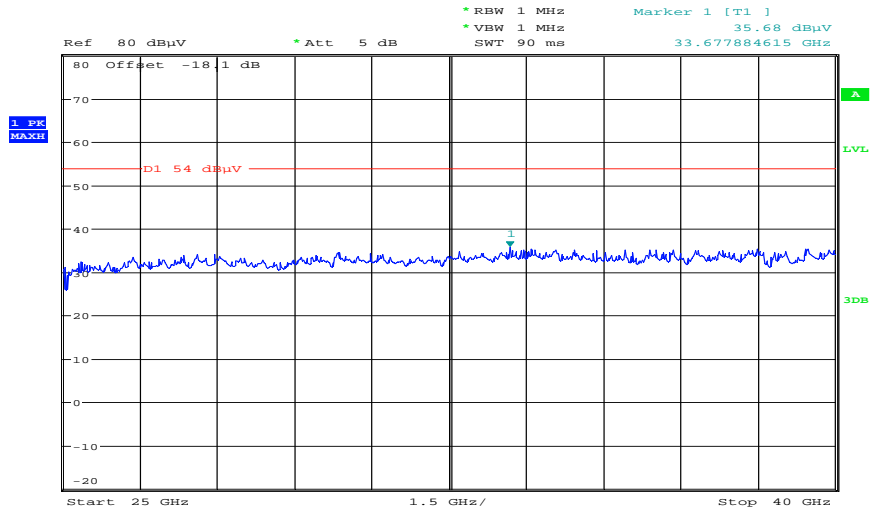

Date: 12.MAR.2012 10:51:31

**Plot 13: Highest channel, 30 MHz to 1 GHz, vertical & horizontal polarization**

**Common Information**

EUT: Quinta CU  
 Serial Number: 00101  
 Test Description: FCC part 15 class B @ 10 m  
 Operating Conditions: ANT A, tx@5240MHz  
 Operator Name: Hennemann  
 Comment: AC: 115 V / 60 Hz; ETH-cable S/FTP

**Scan Setup: STAN\_Fin [EMI radiated]**

Hardware Setup: Electric Field (NOS)  
 Receiver: [ESCI 3]  
 Level Unit: dBµV/m  
**Subrange**                      **Step Size**                      **Detectors**                      **IF BW**                      **Meas. Time**                      **Preamp**  
 30 MHz - 2 GHz                      60 kHz                      QPK                      120 kHz                      1 s                      20 dB

FCC\_10m(B)\_3

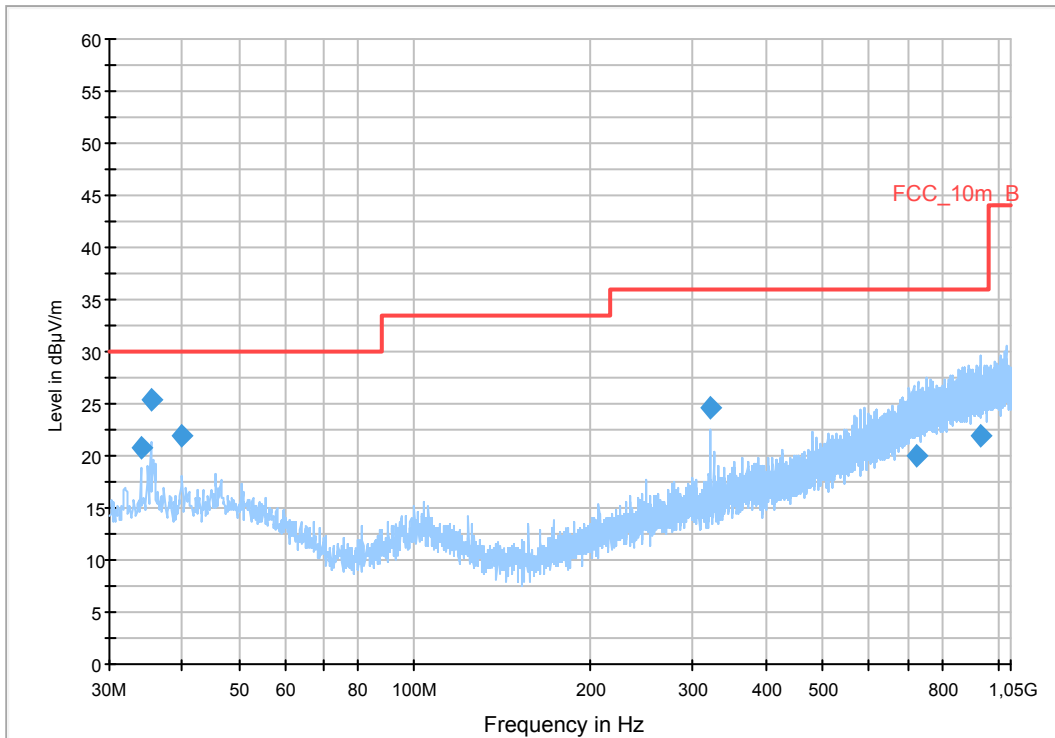

**Final Result 1**

Frequency (MHz)	QuasiPeak (dBµV/m)	Meas. Time (ms)	Bandwidth (kHz)	Height (cm)	Polarization	Azimuth (deg)	Corr. (dB)	Margin (dB)	Limit (dBµV/m)	Comment
34.003950	20.7	1000.0	120.000	170.0	V	196.0	12.9	9.3	30.0	
35.376300	25.3	1000.0	120.000	170.0	V	90.0	13.1	4.7	30.0	
40.014000	21.9	1000.0	120.000	98.0	V	102.0	13.4	8.1	30.0	
319.981050	24.6	1000.0	120.000	98.0	V	260.0	15.2	11.4	36.0	
727.068150	19.9	1000.0	120.000	98.0	H	102.0	23.1	16.1	36.0	
935.960550	21.9	1000.0	120.000	170.0	H	76.0	25.3	14.1	36.0	

Plot 14: Highest channel, 1 GHz to 12.75 GHz, vertical polarization

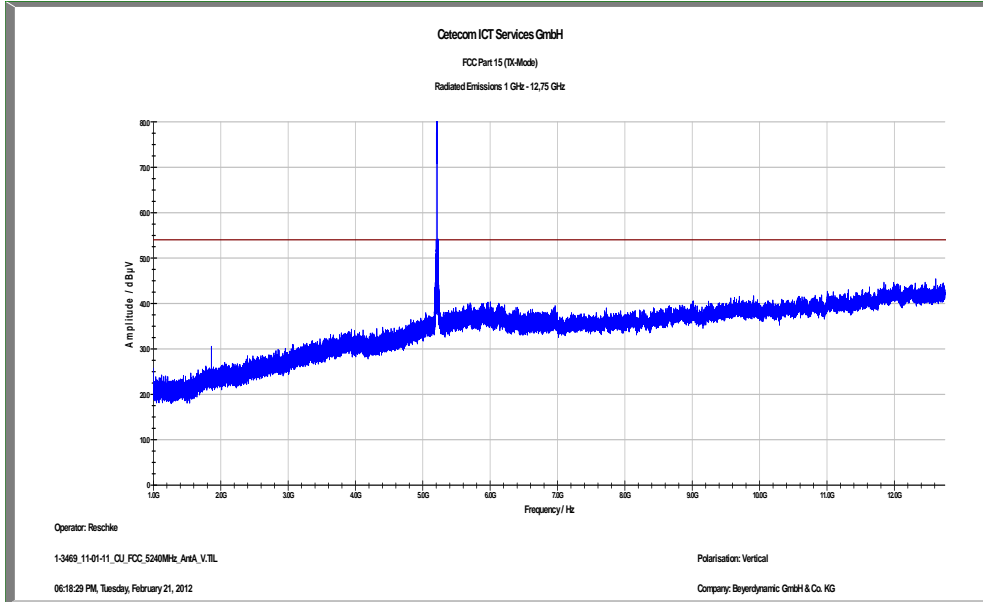

Plot 15: Highest channel, 1 GHz to 12.75 GHz, horizontal polarization

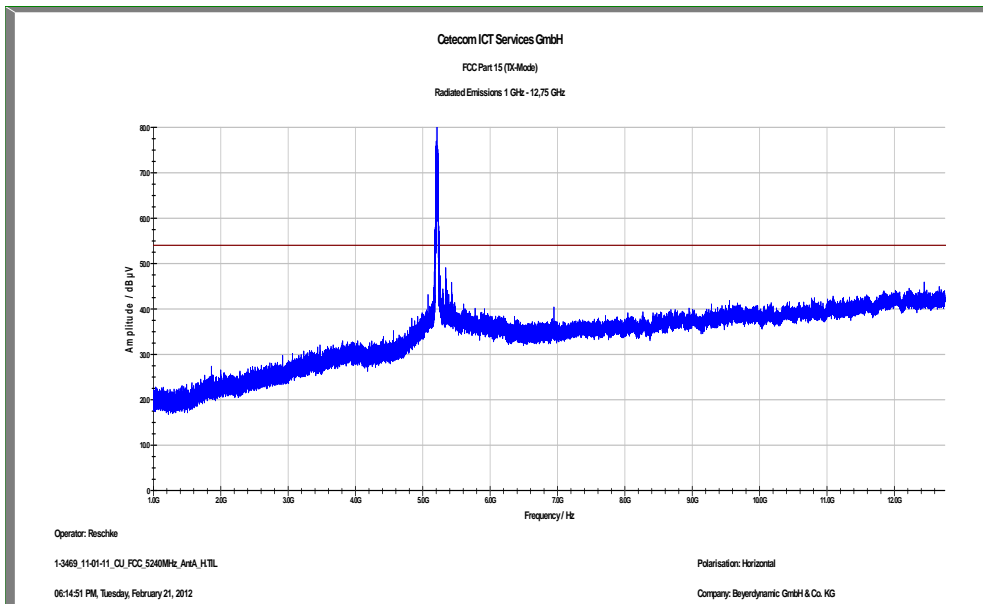



Plot 16: Highest channel, 12 GHz to 18 GHz (vertical / horizontal – max hold – also valid for 20m)

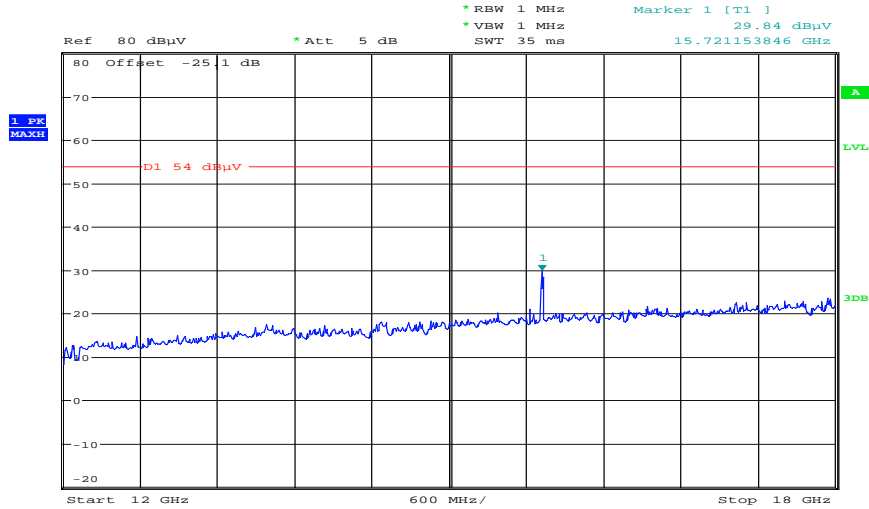

Date: 12.MAR.2012 12:58:46

Plot 17: Highest channel, 18 GHz to 25 GHz (vertical / horizontal – max hold – also valid for 20m)

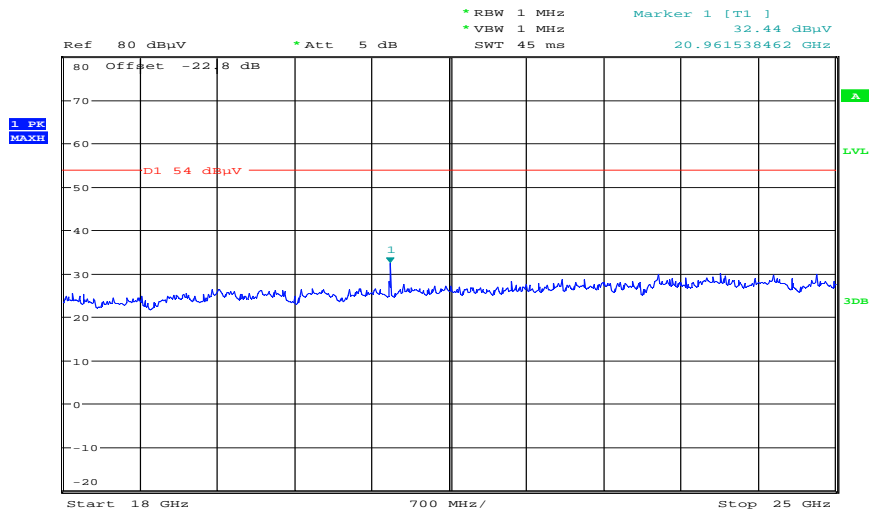

Date: 12.MAR.2012 10:08:31

Plot 18: Highest channel, 25 GHz to 40 GHz (vertical / horizontal – max hold – also valid for 20m)

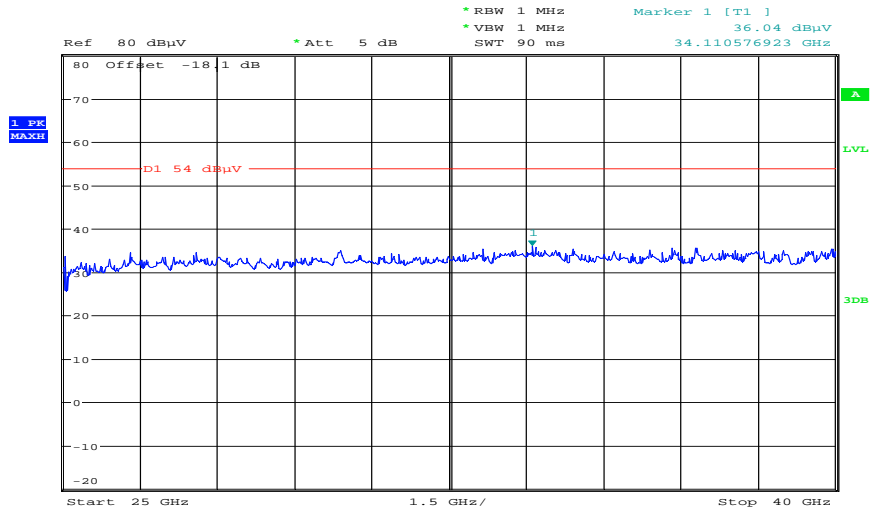

Date: 12.MAR.2012 10:52:04

**Plots: Rod antenna B**

**Plot 1: Lowest channel, 30 MHz to 1 GHz, vertical & horizontal polarization**

**Common Information**

EUT: Quinta CU  
 Serial Number: 00101  
 Test Description: FCC part 15 class B @ 10 m  
 Operating Conditions: ANT B, tx@5180MHz  
 Operator Name: Hennemann  
 Comment: AC: 115 V / 60 Hz; ETH-cable S/FTP

**Scan Setup: STAN\_Fin [EMI radiated]**

Hardware Setup: Electric Field (NOS)  
 Receiver: [ESCI 3]  
 Level Unit: dBµV/m  
**Subrange**                      **Step Size**                      **Detectors**                      **IF BW**                      **Meas. Time**                      **Preamp**  
 30 MHz - 2 GHz                      60 kHz                      QPK                      120 kHz                      1 s                      20 dB

FCC\_10m(B)\_3

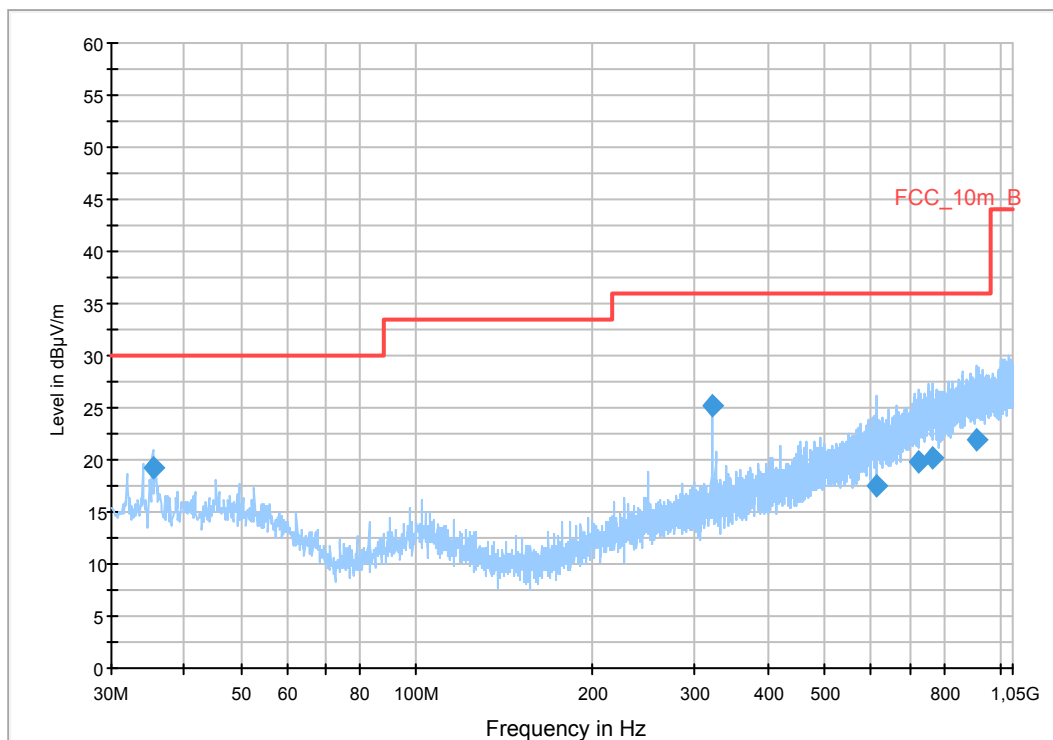

**Final Result 1**

Frequency (MHz)	QuasiPeak (dBµV/m)	Meas. Time (ms)	Bandwidth (kHz)	Height (cm)	Polarization	Azimuth (deg)	Corr. (dB)	Margin (dB)	Limit (dBµV/m)	Comment
35.383200	19.3	1000.0	120.000	98.0	V	283.0	13.1	10.7	30.0	
319.998000	25.2	1000.0	120.000	105.0	V	260.0	15.2	10.8	36.0	
615.256500	17.5	1000.0	120.000	105.0	V	283.0	20.9	18.5	36.0	
725.262900	19.7	1000.0	120.000	145.0	V	91.0	23.1	16.3	36.0	
765.738300	20.3	1000.0	120.000	170.0	H	-7.0	23.7	15.7	36.0	
913.982700	21.9	1000.0	120.000	170.0	H	94.0	25.2	14.1	36.0	

Plot 2: Lowest channel, 1 GHz to 12.75 GHz, vertical polarization

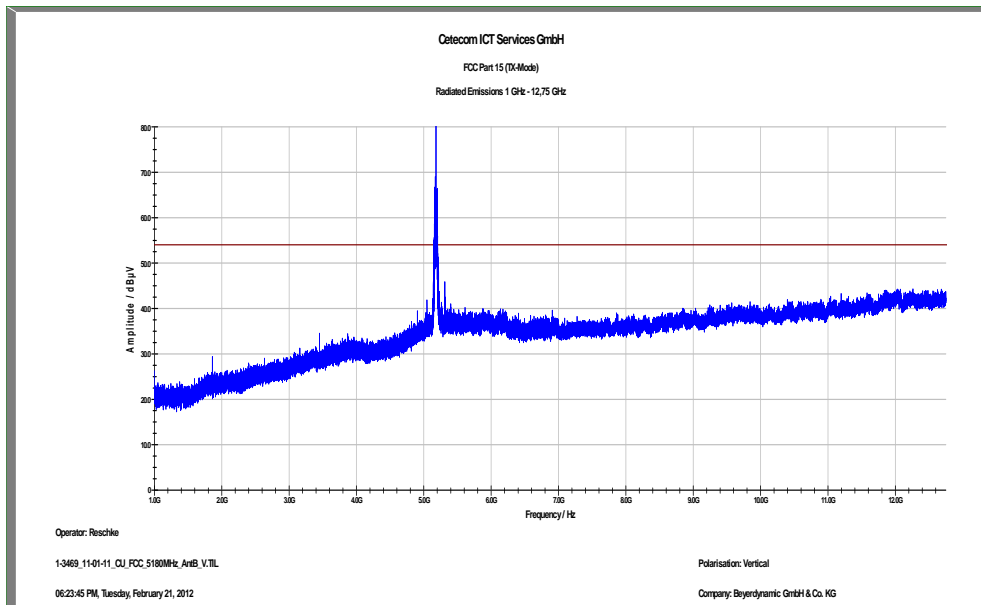

Plot 3: Lowest channel, 1 GHz to 12.75 GHz, horizontal polarization

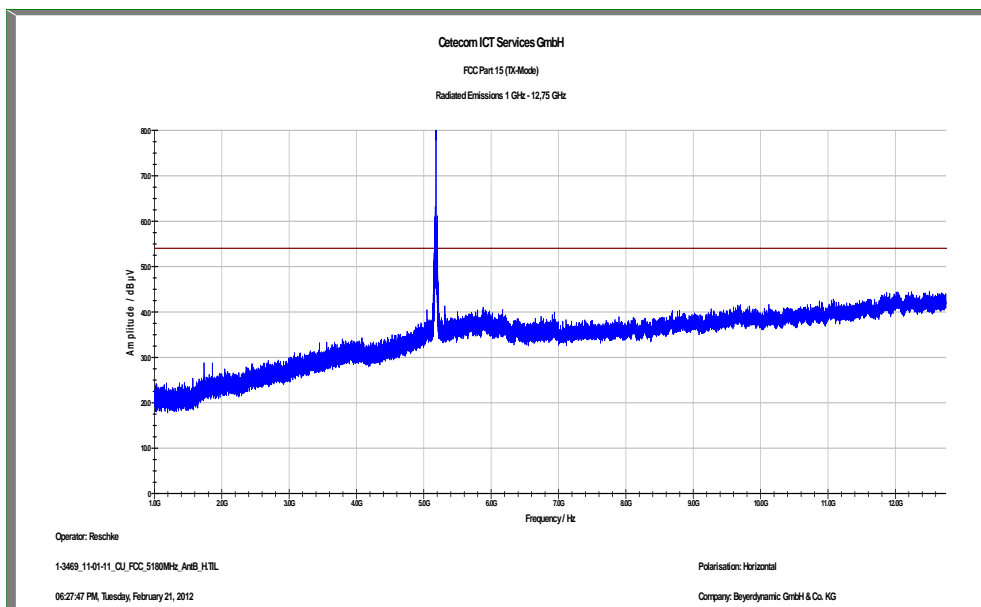

Plot 4: Lowest channel, 12 GHz to 18 GHz (vertical / horizontal – max hold – also valid for 20m)

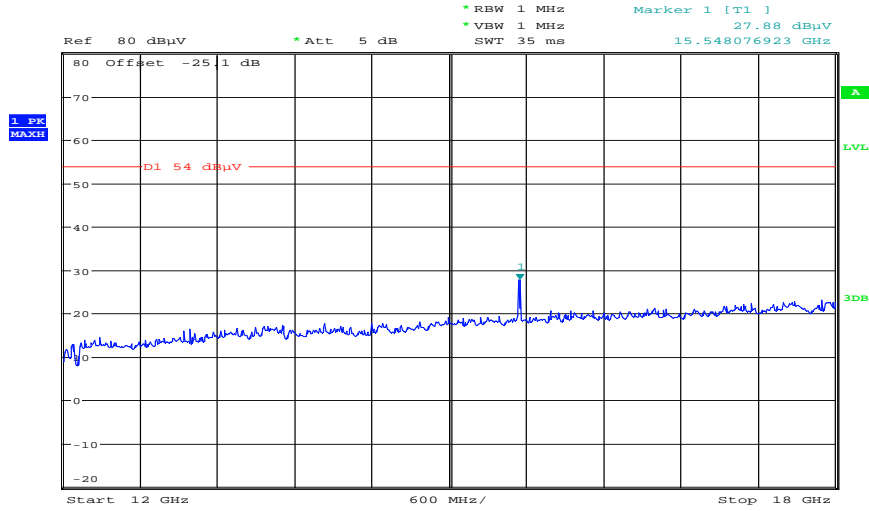

Date: 12.MAR.2012 12:59:48

Plot 5: Lowest channel, 18 GHz to 25 GHz (vertical / horizontal – max hold – also valid for 20m)

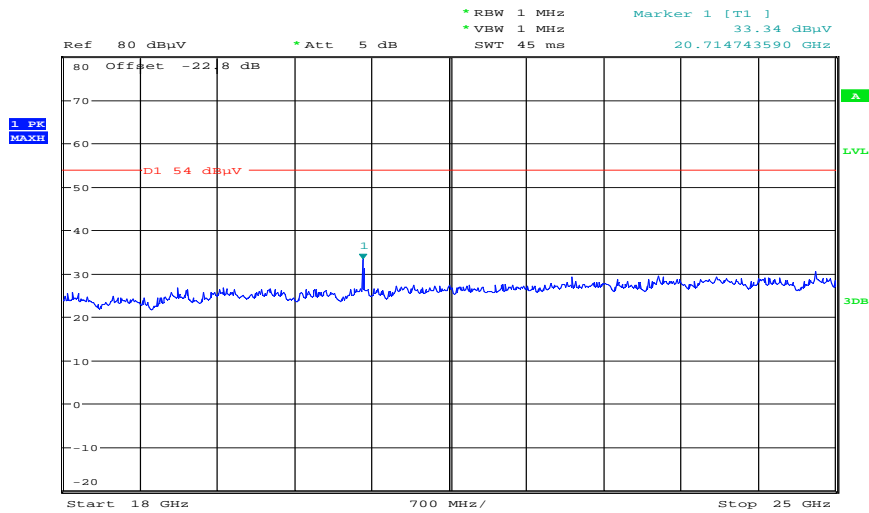

Date: 12.MAR.2012 10:09:14

Plot 6: Lowest channel, 25 GHz to 40 GHz (vertical / horizontal – max hold – also valid for 20m)

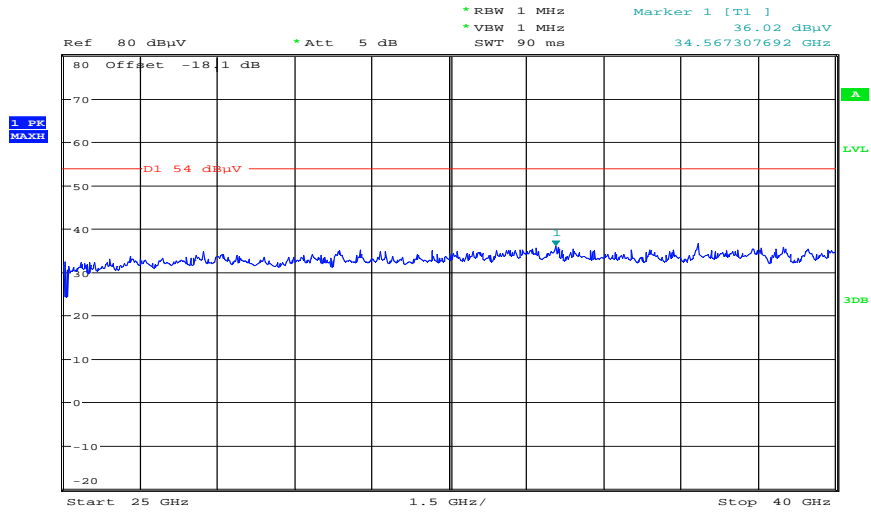

Date: 12.MAR.2012 10:48:30

**Plot 7: Middle channel, 30 MHz to 1 GHz, vertical & horizontal polarization**

**Common Information**

EUT: Quinta CU  
 Serial Number: 00101  
 Test Description: FCC part 15 class B @ 10 m  
 Operating Conditions: ANT B, tx@5210MHz  
 Operator Name: Hennemann  
 Comment: AC: 115 V / 60 Hz; ETH-cable S/FTP

**Scan Setup: STAN\_Fin [EMI radiated]**

Hardware Setup: Electric Field (NOS)  
 Receiver: [ESCI 3]  
 Level Unit: dBµV/m  
**Subrange**                      **Step Size**                      **Detectors**                      **IF BW**                      **Meas. Time**                      **Preamp**  
 30 MHz - 2 GHz                      60 kHz                      QPK                      120 kHz                      1 s                      20 dB

FCC\_10m(B)\_3

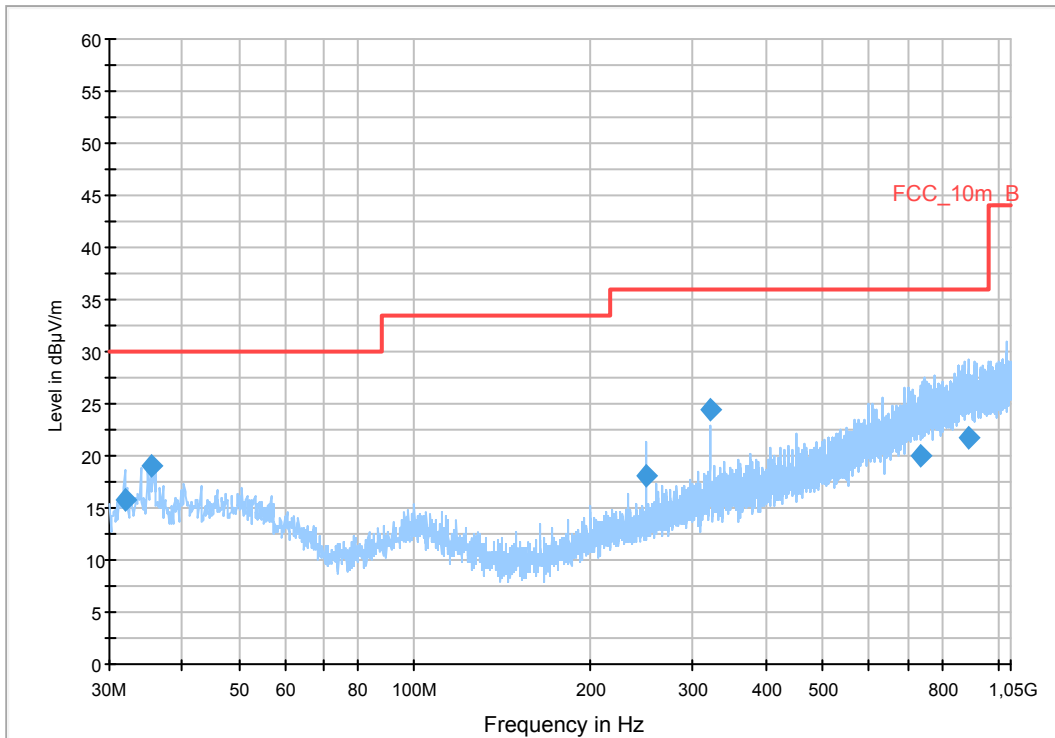

**Final Result 1**

Frequency (MHz)	QuasiPeak (dBµV/m)	Meas. Time (ms)	Bandwidth (kHz)	Height (cm)	Polarization	Azimuth (deg)	Corr. (dB)	Margin (dB)	Limit (dBµV/m)	Comment
31.970250	15.7	1000.0	120.000	98.0	V	283.0	12.7	14.3	30.0	
35.392500	19.0	1000.0	120.000	98.0	V	284.0	13.1	11.0	30.0	
249.996150	18.0	1000.0	120.000	98.0	V	-6.0	13.3	18.0	36.0	
319.975650	24.3	1000.0	120.000	98.0	V	196.0	15.2	11.7	36.0	
734.249700	20.1	1000.0	120.000	170.0	H	94.0	23.3	15.9	36.0	
886.466850	21.8	1000.0	120.000	106.0	V	180.0	25.0	14.2	36.0	

Plot 8: Middle channel, 1 GHz to 12.75 GHz, vertical polarization

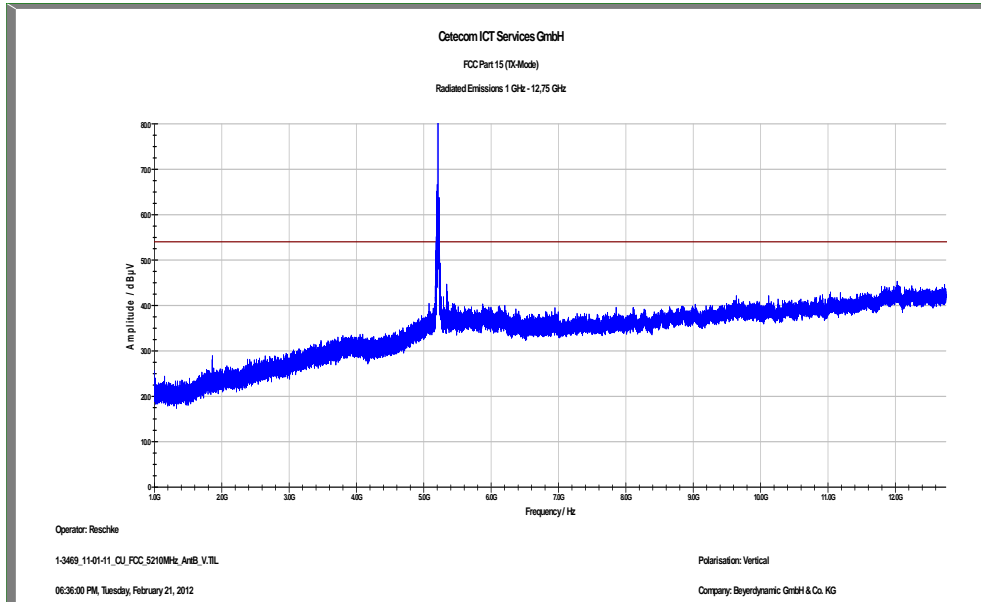

Plot 9: Middle channel, 1 GHz to 12.75 GHz, horizontal polarization

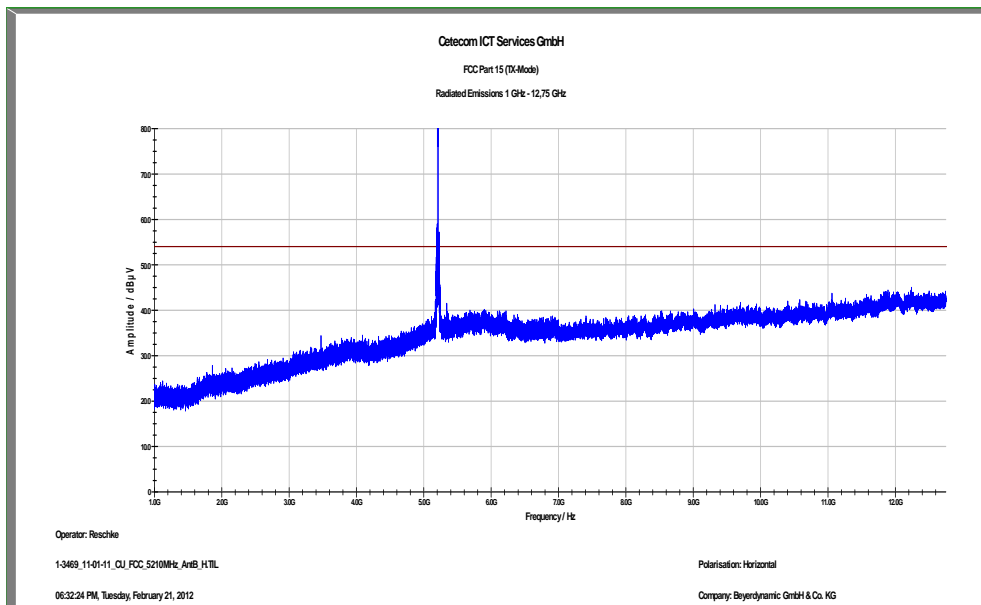



Plot 10: Middle channel, 12 GHz to 18 GHz (vertical / horizontal – max hold – also valid for 20m)

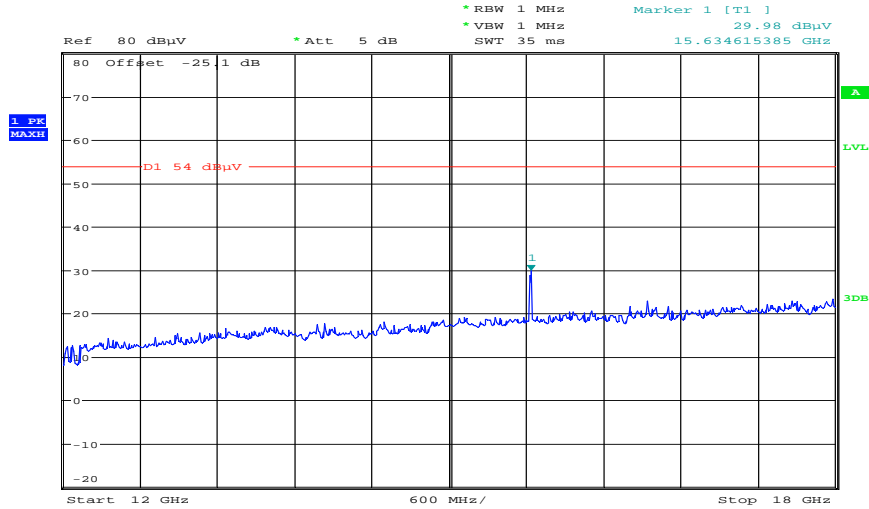

Date: 12.MAR.2012 13:00:25

Plot 11: Middle channel, 18 GHz to 25 GHz (vertical / horizontal – max hold – also valid for 20m)

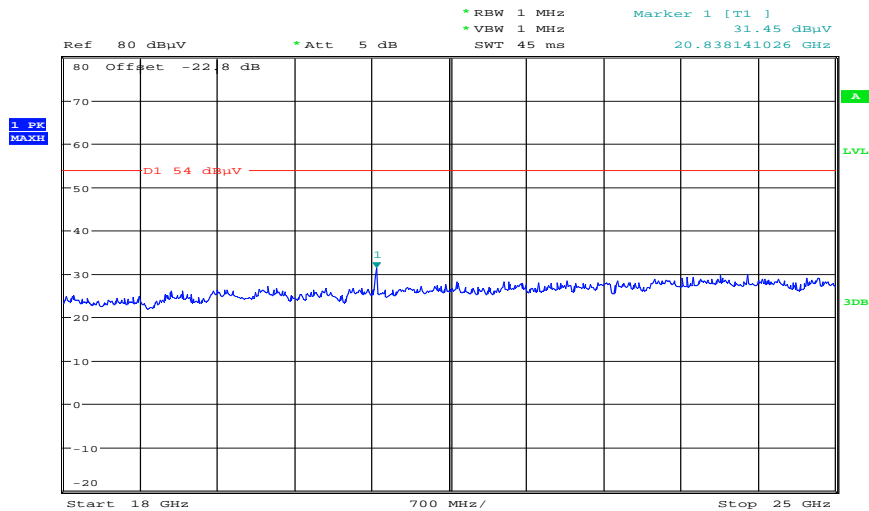

Date: 12.MAR.2012 10:09:52

Plot 12: Middle channel, 25 GHz to 40 GHz (vertical / horizontal – max hold – also valid for 20m)

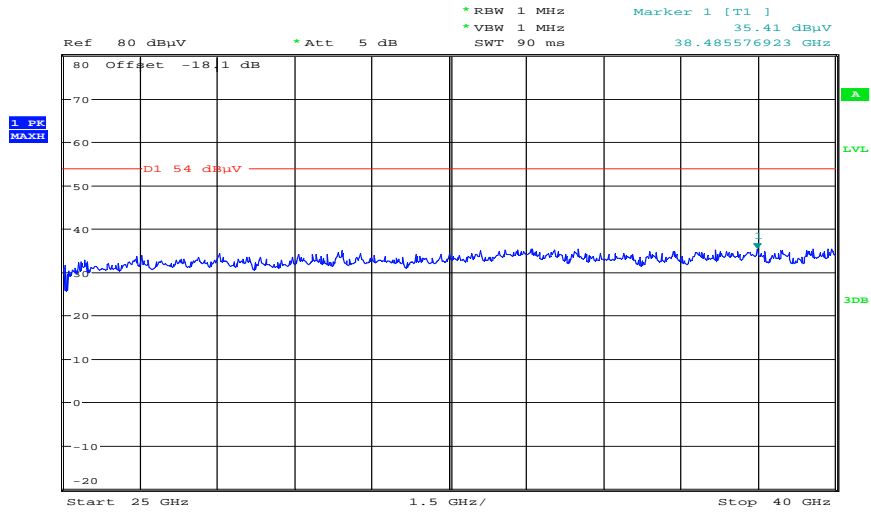

Date: 12.MAR.2012 10:49:05

**Plot 13: Highest channel, 30 MHz to 1 GHz, vertical & horizontal polarization**

**Common Information**

EUT: Quinta CU  
 Serial Number: 00101  
 Test Description: FCC part 15 class B @ 10 m  
 Operating Conditions: ANT B, tx@5240MHz  
 Operator Name: Hennemann  
 Comment: AC: 115 V / 60 Hz; ETH-cable S/FTP

**Scan Setup: STAN\_Fin [EMI radiated]**

Hardware Setup: Electric Field (NOS)  
 Receiver: [ESCI 3]  
 Level Unit: dBµV/m  
**Subrange**                      **Step Size**                      **Detectors**                      **IF BW**                      **Meas. Time**                      **Preamp**  
 30 MHz - 2 GHz                      60 kHz                      QPK                      120 kHz                      1 s                      20 dB

FCC\_10m(B)\_3

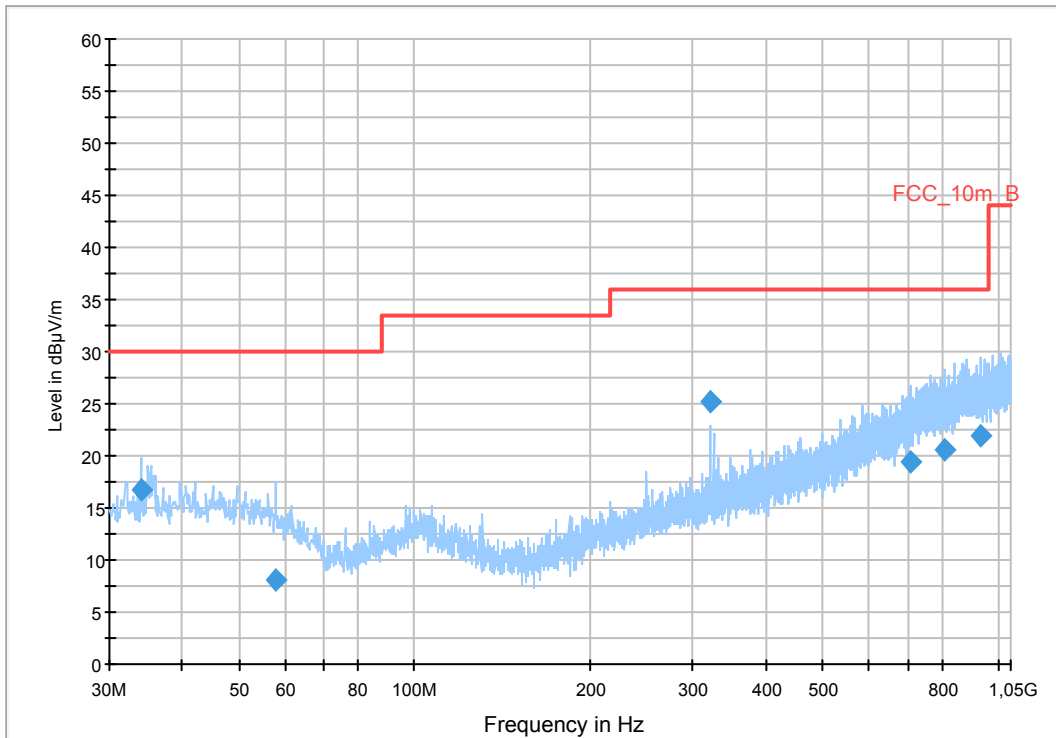

**Final Result 1**

Frequency (MHz)	QuasiPeak (dBµV/m)	Meas. Time (ms)	Bandwidth (kHz)	Height (cm)	Polarization	Azimuth (deg)	Corr. (dB)	Margin (dB)	Limit (dBµV/m)	Comment
34.008150	16.7	1000.0	120.000	163.0	V	92.0	12.9	13.3	30.0	
57.749100	8.1	1000.0	120.000	170.0	V	106.0	12.2	21.9	30.0	
319.985100	25.3	1000.0	120.000	98.0	V	260.0	15.2	10.7	36.0	
705.503550	19.4	1000.0	120.000	170.0	H	8.0	22.6	16.6	36.0	
812.053200	20.5	1000.0	120.000	170.0	V	86.0	24.0	15.5	36.0	
936.203400	21.9	1000.0	120.000	98.0	V	106.0	25.3	14.1	36.0	

Plot 14: Highest channel, 1 GHz to 12.75 GHz, vertical polarization

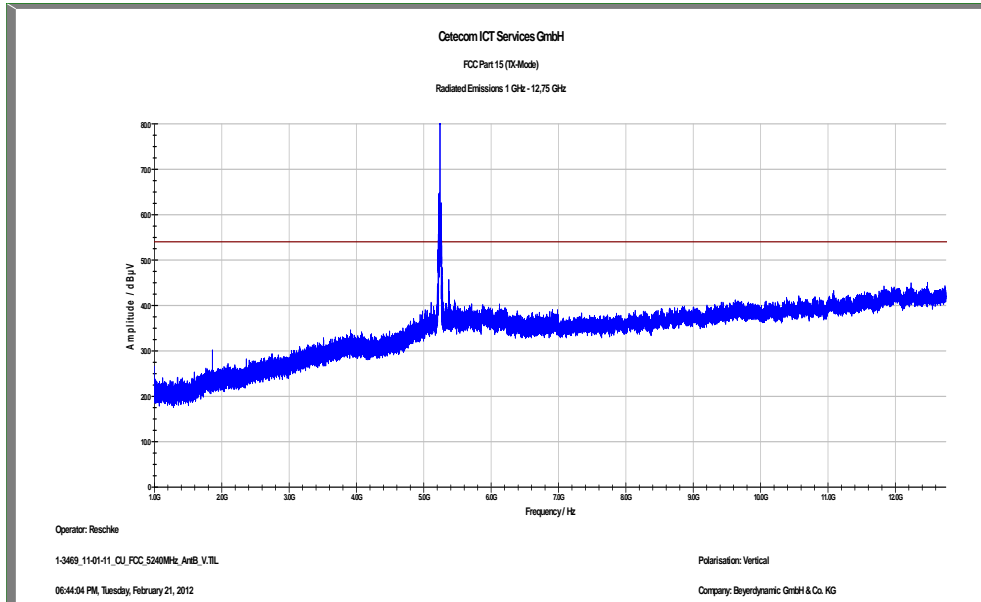

Plot 15: Highest channel, 1 GHz to 12.75 GHz, horizontal polarization

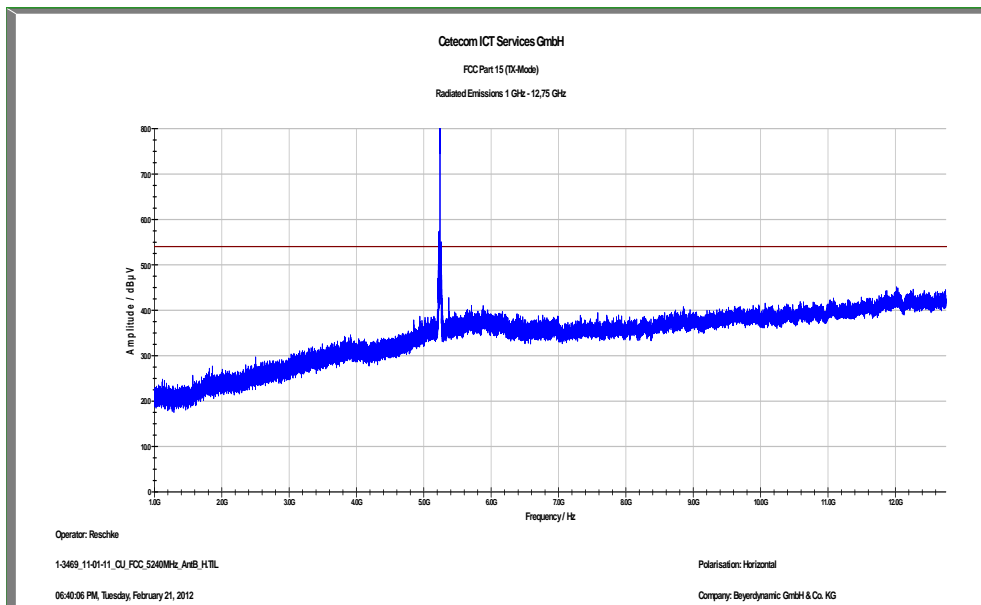

Plot 16: Highest channel, 12 GHz to 18 GHz (vertical / horizontal – max hold – also valid for 20m)

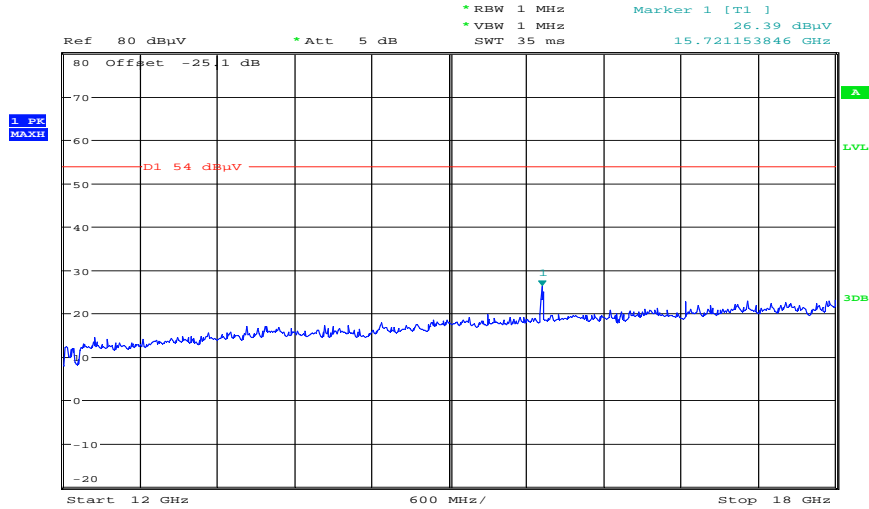

Date: 12.MAR.2012 13:01:19

Plot 17: Highest channel, 18 GHz to 25 GHz (vertical / horizontal – max hold – also valid for 20m)

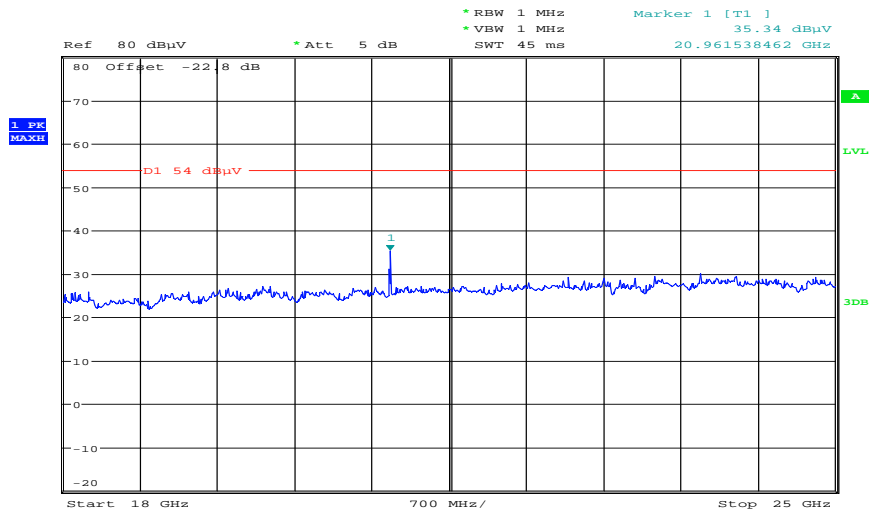

Date: 12.MAR.2012 10:10:57

Plot 18: Highest channel, 25 GHz to 40 GHz (vertical / horizontal – max hold – also valid for 20m)

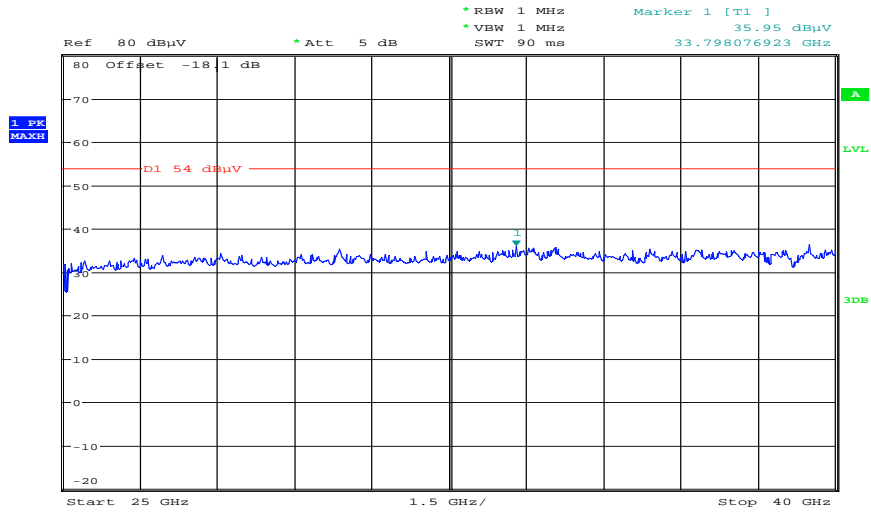

Date: 12.MAR.2012 10:50:02

**Plots: Planar antenna A with 10 m cable**

**Plot 1: Lowest channel, 30 MHz to 1 GHz, vertical & horizontal polarization**

**Common Information**

EUT: Quinta CU  
 Serial Number: 00101  
 Test Description: FCC part 15 class B @ 10 m  
 Operating Conditions: Ant A tx@5180MHz  
 Operator Name: Wolsdorfer  
 Comment: AC: 115 V / 60 Hz; ETH-cable S/FTP; 2x SPA2456 antenna + 10m cable

**Scan Setup: STAN\_Fin [EMI radiated]**

Hardware Setup: Electric Field (NOS)  
 Receiver: [ESCI 3]  
 Level Unit: dBµV/m

**Subrange**                      **Step Size**                      **Detectors**                      **IF BW**                      **Meas. Time**                      **Preamp**  
 30 MHz - 2 GHz                      60 kHz                      QPK                      120 kHz                      1 s                      20 dB

FCC\_10m(B)\_5

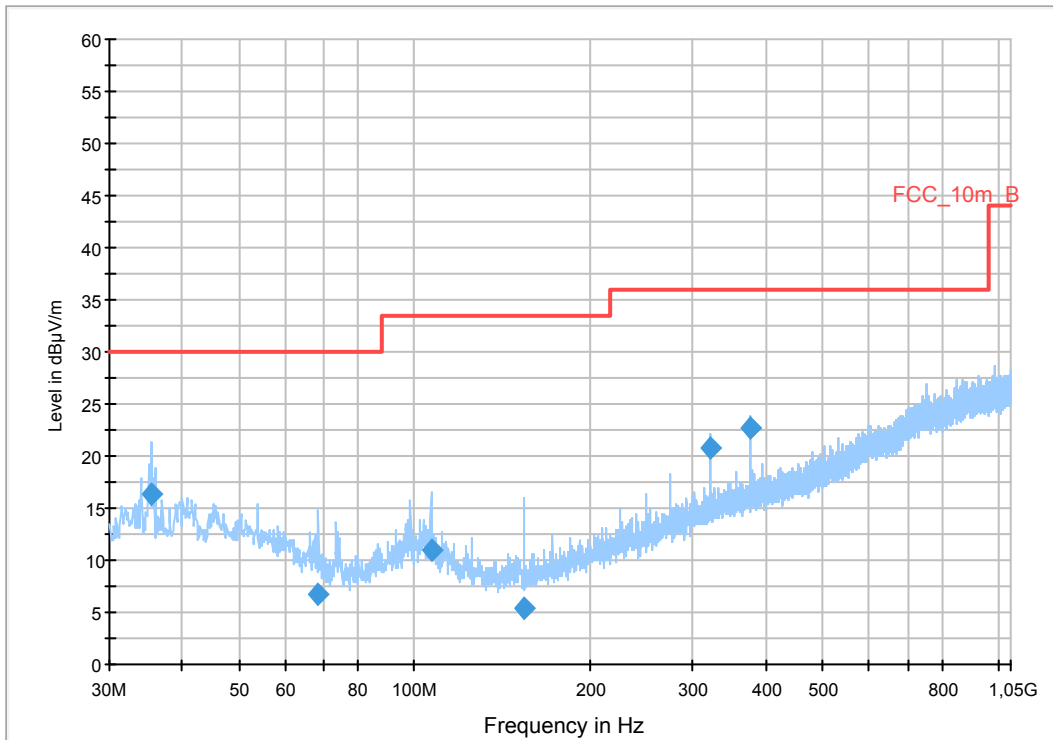

**Final Result 1**

Frequency (MHz)	QuasiPeak (dBµV/m)	Meas. Time (ms)	Bandwidth (kHz)	Height (cm)	Polarization	Azimuth (deg)	Corr. (dB)	Margin (dB)	Limit (dBµV/m)	Comment
35.400000	16.3	1000.0	120.000	270.0	V	-2.0	13.1	13.7	30.0	
68.400000	6.7	1000.0	120.000	105.0	V	90.0	9.6	23.3	30.0	
106.680000	11.0	1000.0	120.000	168.0	V	207.0	11.3	22.5	33.5	
153.720000	5.3	1000.0	120.000	112.0	V	129.0	9.0	28.2	33.5	
320.040000	20.7	1000.0	120.000	98.0	V	322.0	15.2	15.3	36.0	
375.000000	22.8	1000.0	120.000	105.0	V	99.0	16.5	13.2	36.0	

Plot 2: Lowest channel, 1 GHz to 12.75 GHz, vertical and horizontal polarization

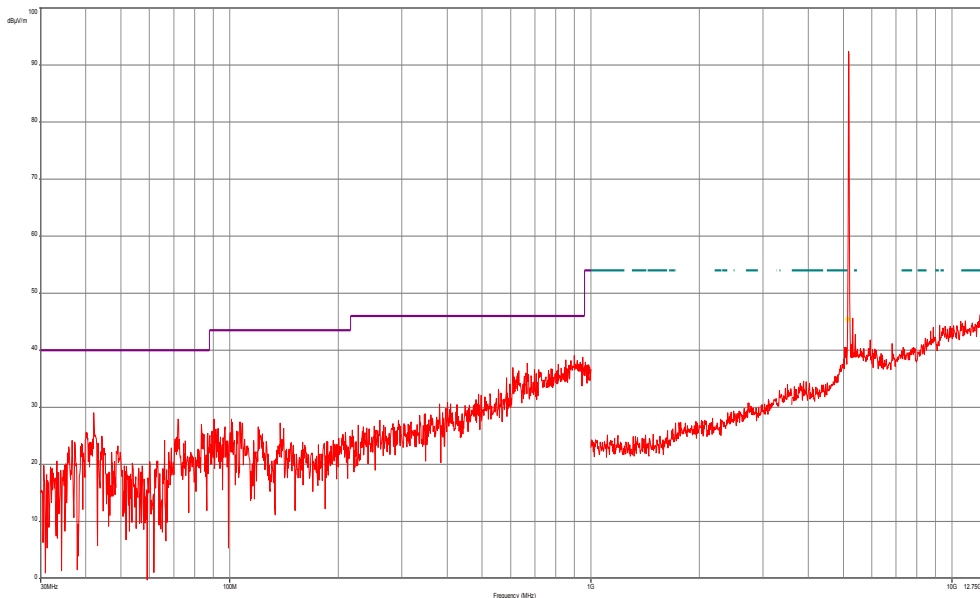

Plot 3: Lowest channel, 12 GHz to 18 GHz (vertical / horizontal – max hold – also valid for 20m)

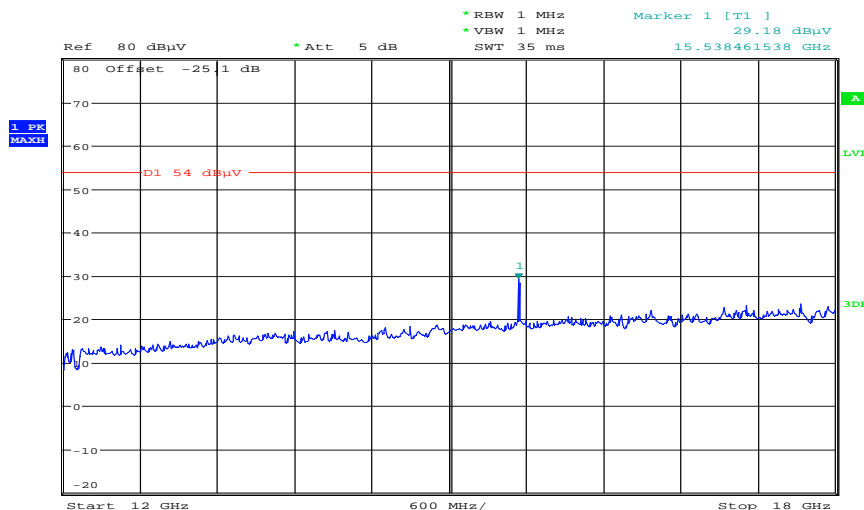

Date: 12.MAR.2012 11:26:55



Plot 4: Lowest channel, 18 GHz to 25 GHz (vertical / horizontal – max hold – also valid for 20m)

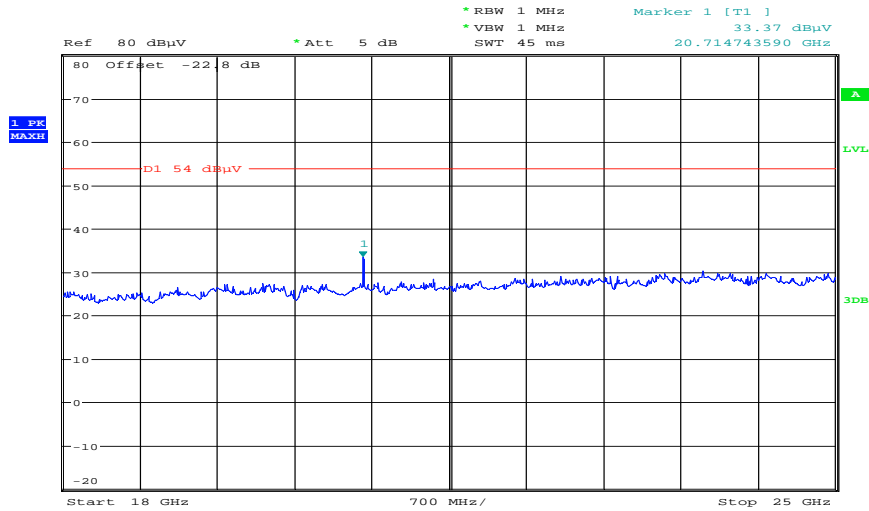

Date: 12.MAR.2012 10:20:09

Plot 5: Lowest channel, 25 GHz to 40 GHz (vertical / horizontal – max hold – also valid for 20m)

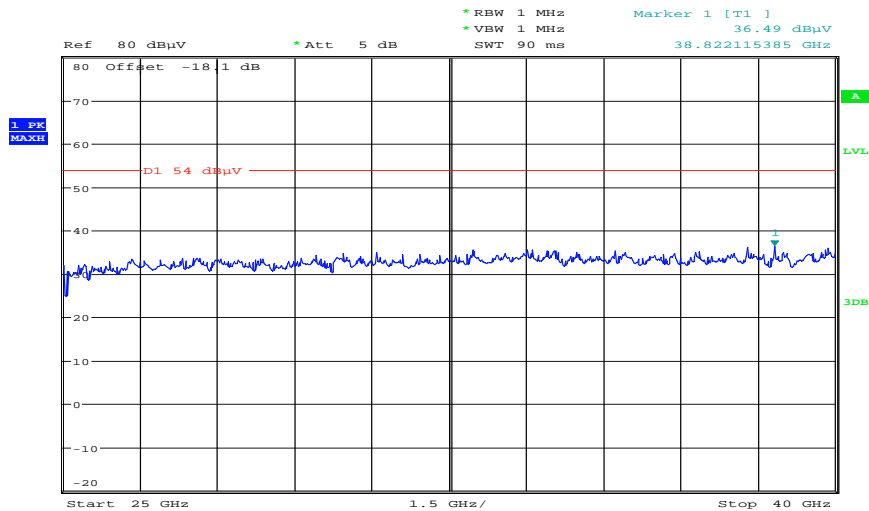

Date: 12.MAR.2012 11:07:04

**Plot 6: Middle channel, 30 MHz to 1 GHz, vertical & horizontal polarization**

**Common Information**

EUT: Quinta CU  
 Serial Number: 00101  
 Test Description: FCC part 15 class B @ 10 m  
 Operating Conditions: Ant A tx@5210MHz  
 Operator Name: Wolsdorfer  
 Comment: AC: 115 V / 60 Hz; ETH-cable S/FTP; 2x SPA2456 antenna + 10m cable

**Scan Setup: STAN\_Fin [EMI radiated]**

Hardware Setup: Electric Field (NOS)  
 Receiver: [ESCI 3]  
 Level Unit: dBµV/m

**Subrange**                      **Step Size**                      **Detectors**                      **IF BW**                      **Meas. Time**                      **Preamp**  
 30 MHz - 2 GHz                      60 kHz                      QPK                      120 kHz                      1 s                      20 dB

FCC\_10m(B)\_5

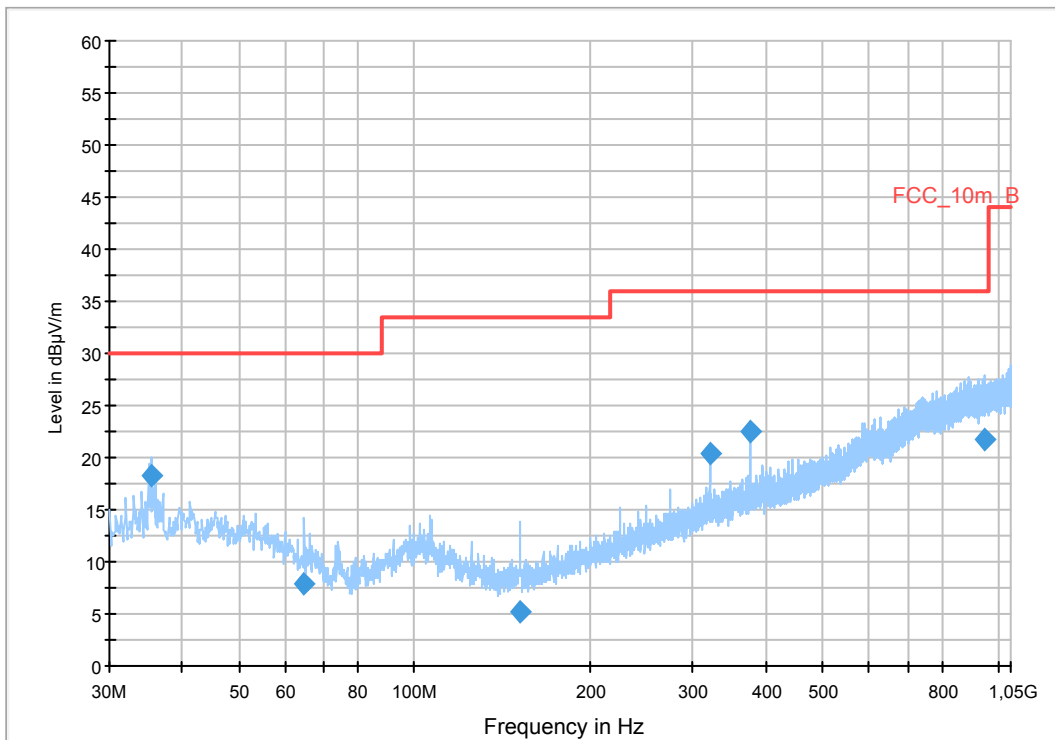

**Final Result 1**

Frequency (MHz)	QuasiPeak (dBµV/m)	Meas. Time (ms)	Bandwidth (kHz)	Height (cm)	Polarization	Azimuth (deg)	Corr. (dB)	Margin (dB)	Limit (dBµV/m)	Comment
35.400000	18.3	1000.0	120.000	112.0	V	253.0	13.1	11.7	30.0	
64.800000	7.8	1000.0	120.000	98.0	V	-2.0	10.5	22.2	30.0	
151.920000	5.2	1000.0	120.000	270.0	V	131.0	9.0	28.3	33.5	
320.040000	20.3	1000.0	120.000	98.0	V	296.0	15.2	15.7	36.0	
375.000000	22.5	1000.0	120.000	98.0	V	100.0	16.5	13.5	36.0	
944.880000	21.8	1000.0	120.000	270.0	H	317.0	25.3	14.2	36.0	

Plot 7: Middle channel, 1 GHz to 12.75 GHz, vertical polarization

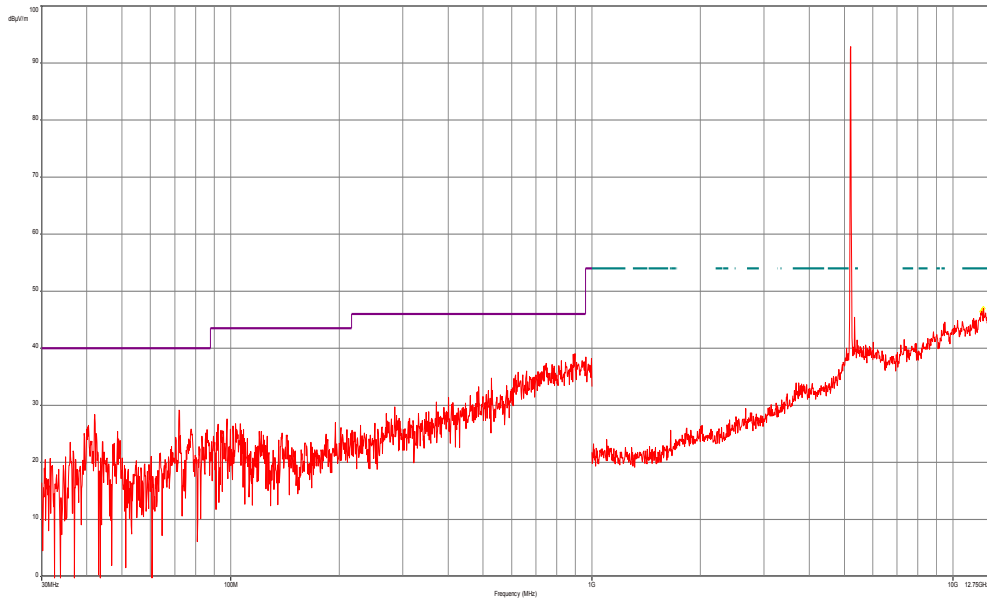

Plot 8: Middle channel, 12 GHz to 18 GHz (vertical / horizontal – max hold – also valid for 20m)

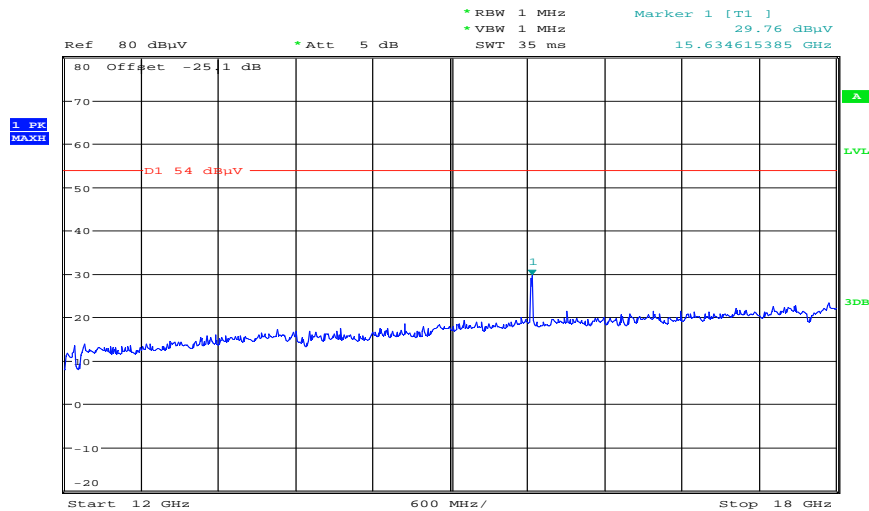

Date: 12.MAR.2012 11:27:28

Plot 9: Middle channel, 18 GHz to 25 GHz (vertical / horizontal – max hold – also valid for 20m)

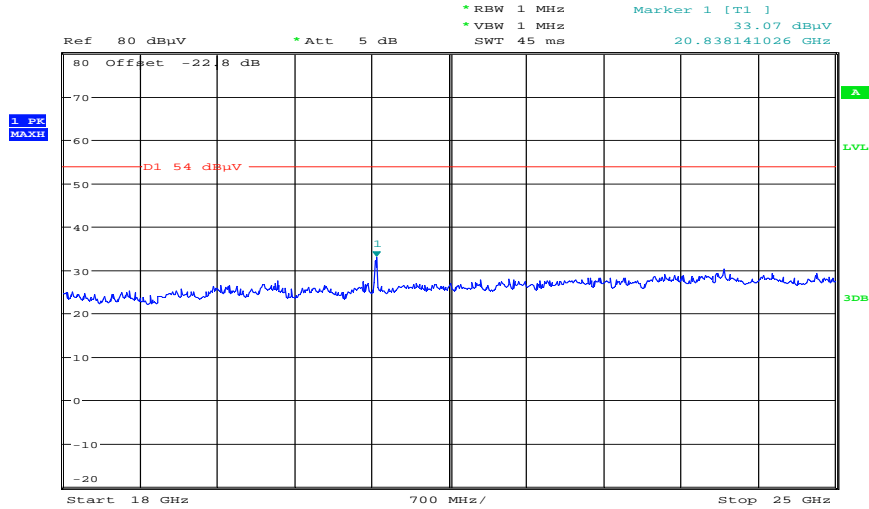

Date: 12.MAR.2012 10:20:47

Plot 10: Middle channel, 25 GHz to 40 GHz (vertical / horizontal – max hold – also valid for 20m)

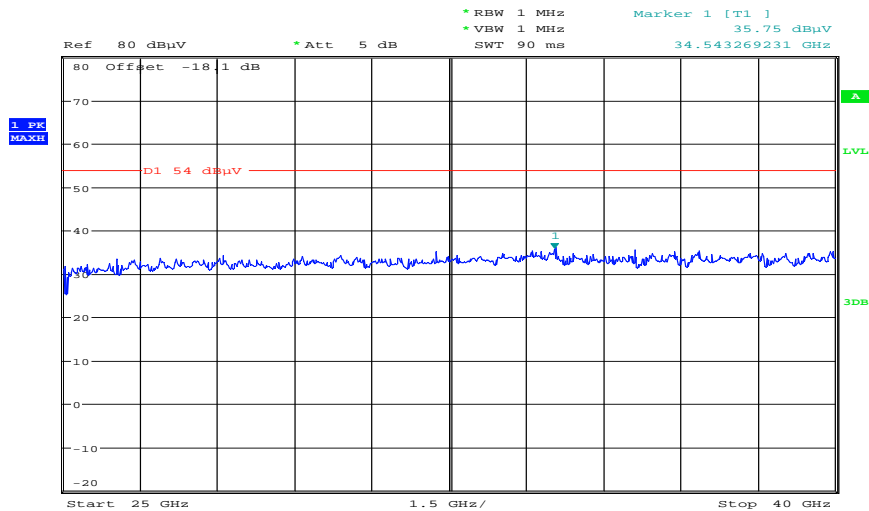

Date: 12.MAR.2012 11:07:36

**Plot 11: Highest channel, 30 MHz to 1 GHz, vertical & horizontal polarization**

**Common Information**

EUT: Quinta CU  
 Serial Number: 00101  
 Test Description: FCC part 15 class B @ 10 m  
 Operating Conditions: Ant A tx@5240MHz  
 Operator Name: Wolsdorfer  
 Comment: AC: 115 V / 60 Hz; ETH-cable S/FTP; 2x SPA2456 antenna + 10m cable

**Scan Setup: STAN\_Fin [EMI radiated]**

Hardware Setup: Electric Field (NOS)  
 Receiver: [ESCI 3]  
 Level Unit: dBµV/m

**Subrange**                      **Step Size**                      **Detectors**                      **IF BW**                      **Meas. Time**                      **Preamp**  
 30 MHz - 2 GHz                      60 kHz                      QPK                      120 kHz                      1 s                      20 dB

FCC\_10m(B)\_5

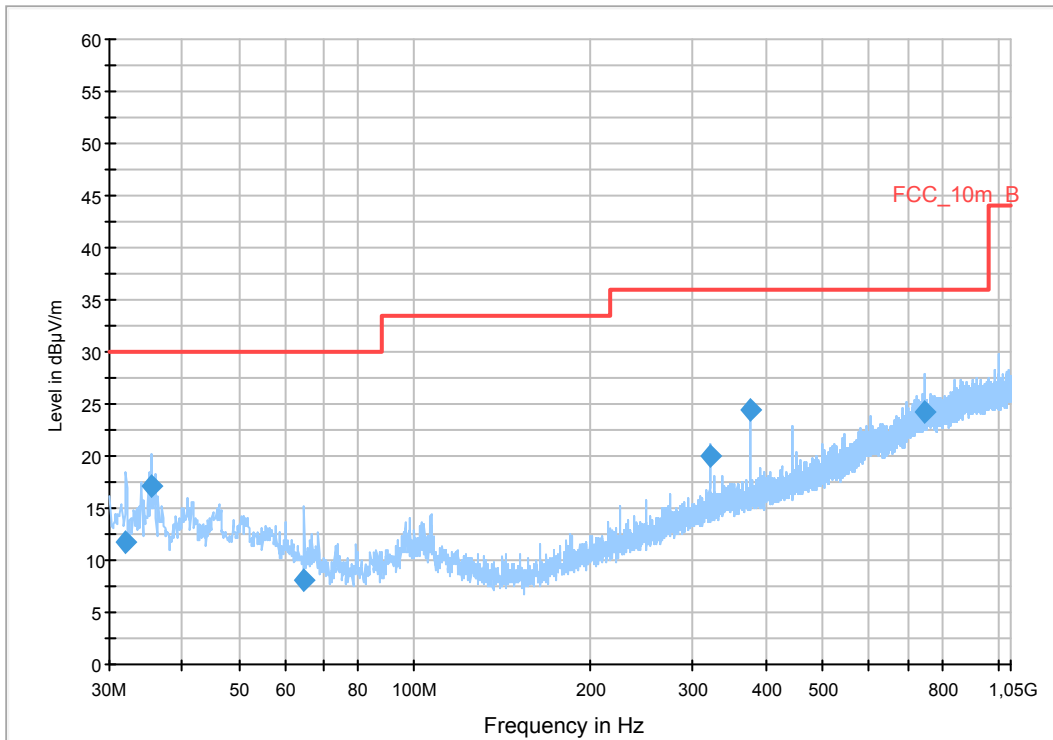

**Final Result 1**

Frequency (MHz)	QuasiPeak (dBµV/m)	Meas. Time (ms)	Bandwidth (kHz)	Height (cm)	Polarization	Azimuth (deg)	Corr. (dB)	Margin (dB)	Limit (dBµV/m)	Comment
32.040000	11.7	1000.0	120.000	227.0	V	270.0	12.7	18.3	30.0	
35.400000	17.1	1000.0	120.000	220.0	V	223.0	13.1	12.9	30.0	
64.800000	8.1	1000.0	120.000	135.0	V	107.0	10.5	21.9	30.0	
320.040000	20.1	1000.0	120.000	98.0	V	297.0	15.2	15.9	36.0	
375.000000	24.4	1000.0	120.000	98.0	V	107.0	16.5	11.6	36.0	
750.000000	24.2	1000.0	120.000	121.0	H	331.0	23.7	11.8	36.0	

Plot 12: Highest channel, 1 GHz to 12.75 GHz, vertical and horizontal polarization

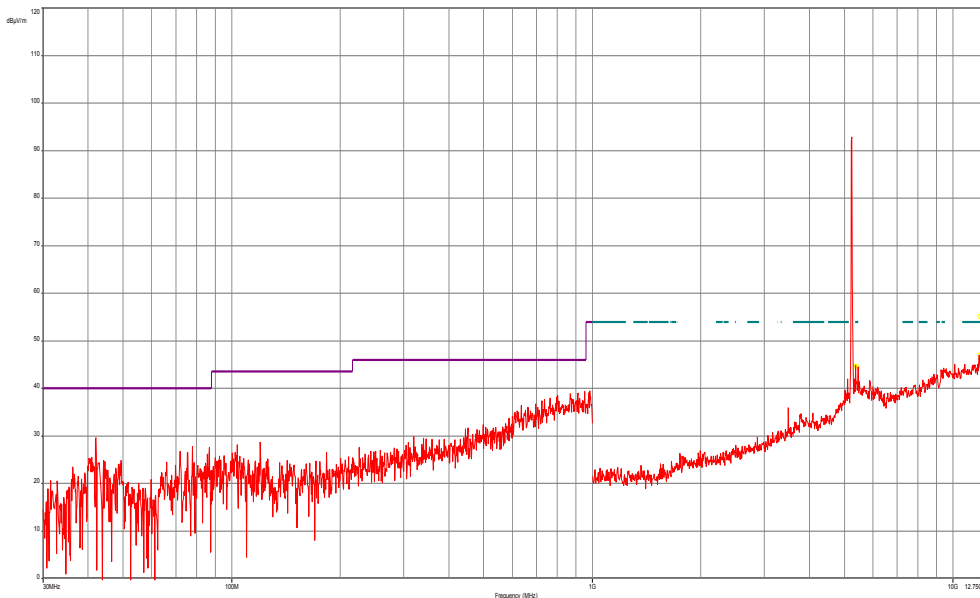

Plot 13: Highest channel, 12 GHz to 18 GHz (vertical / horizontal – max hold – also valid for 20m)

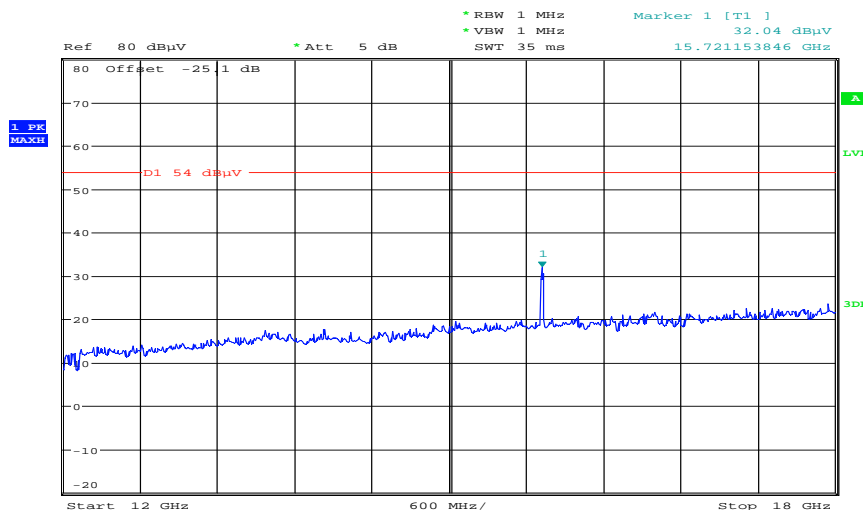

Date: 12.MAR.2012 11:28:01

Plot 14: Highest channel, 18 GHz to 25 GHz (vertical / horizontal – max hold – also valid for 20m)

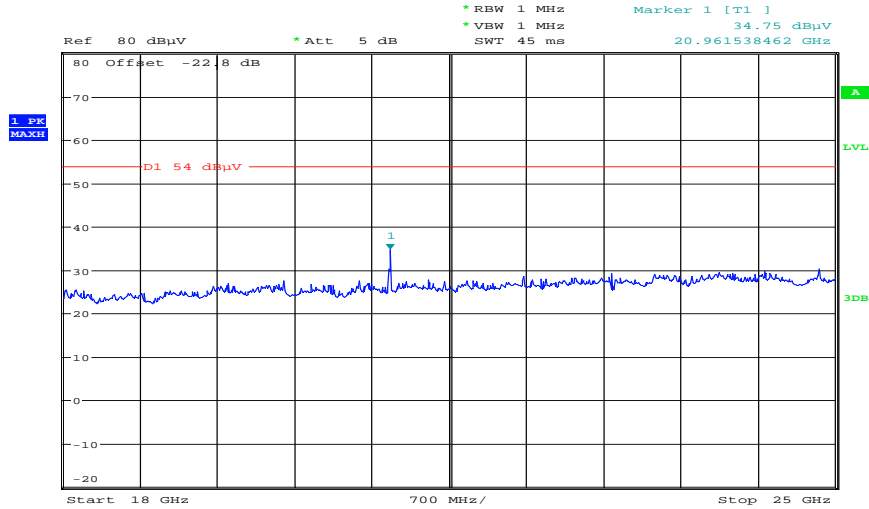

Date: 12.MAR.2012 10:21:36

Plot 15: Highest channel, 25 GHz to 40 GHz (vertical / horizontal – max hold – also valid for 20m)

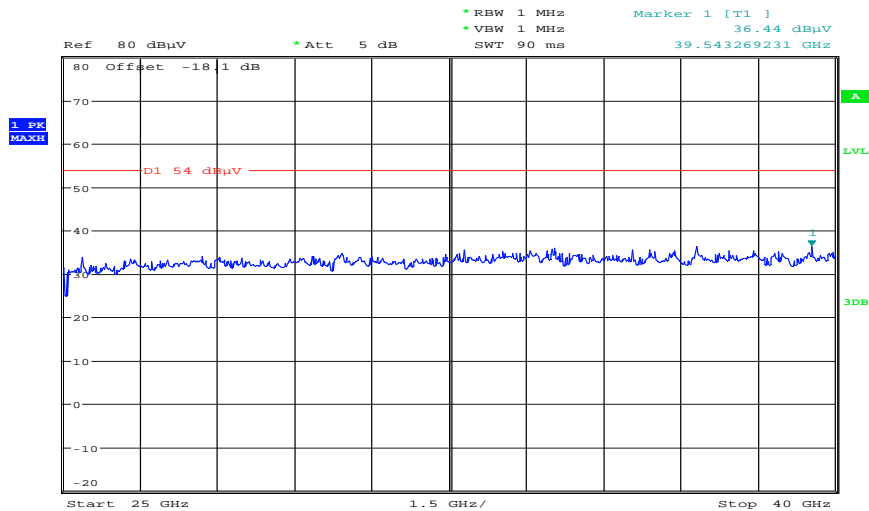

Date: 12.MAR.2012 11:08:17

**Plots: Planar antenna B with 10 m cable**

**Plot 1: Lowest channel, 30 MHz to 1 GHz, vertical & horizontal polarization**

**Common Information**

EUT: Quinta CU  
 Serial Number: 00101  
 Test Description: FCC part 15 class B @ 10 m  
 Operating Conditions: Ant B tx@5180MHz  
 Operator Name: Wolsdorfer  
 Comment: AC: 115 V / 60 Hz; ETH-cable S/FTP; 2x SPA2456 antenna + 10m cable

**Scan Setup: STAN\_Fin [EMI radiated]**

Hardware Setup: Electric Field (NOS)  
 Receiver: [ESCI 3]  
 Level Unit: dBµV/m

Subrange	Step Size	Detectors	IF BW	Meas. Time	Preamp
30 MHz - 2 GHz	60 kHz	QPK	120 kHz	1 s	20 dB

FCC\_10m(B)\_5

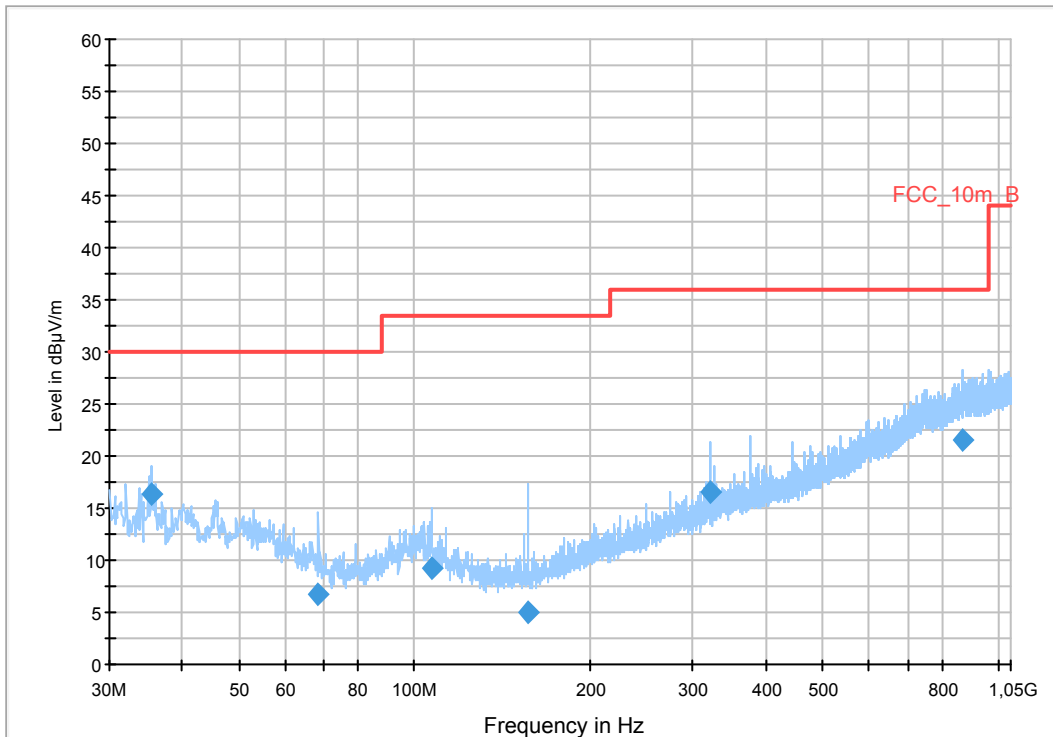

**Final Result 1**

Frequency (MHz)	QuasiPeak (dBµV/m)	Meas. Time (ms)	Bandwidth (kHz)	Height (cm)	Polarization	Azimuth (deg)	Corr. (dB)	Margin (dB)	Limit (dBµV/m)	Comment
35.400000	16.4	1000.0	120.000	271.0	V	258.0	13.1	13.6	30.0	
68.400000	6.7	1000.0	120.000	112.0	V	234.0	9.6	23.3	30.0	
107.040000	9.3	1000.0	120.000	271.0	V	308.0	11.3	24.2	33.5	
156.600000	5.0	1000.0	120.000	253.0	V	154.0	9.1	28.5	33.5	
319.920000	16.5	1000.0	120.000	98.0	V	299.0	15.2	19.5	36.0	
871.680000	21.6	1000.0	120.000	271.0	V	308.0	24.8	14.4	36.0	



Plot 2: Lowest channel, 1 GHz to 12.75 GHz, vertical and horizontal polarization

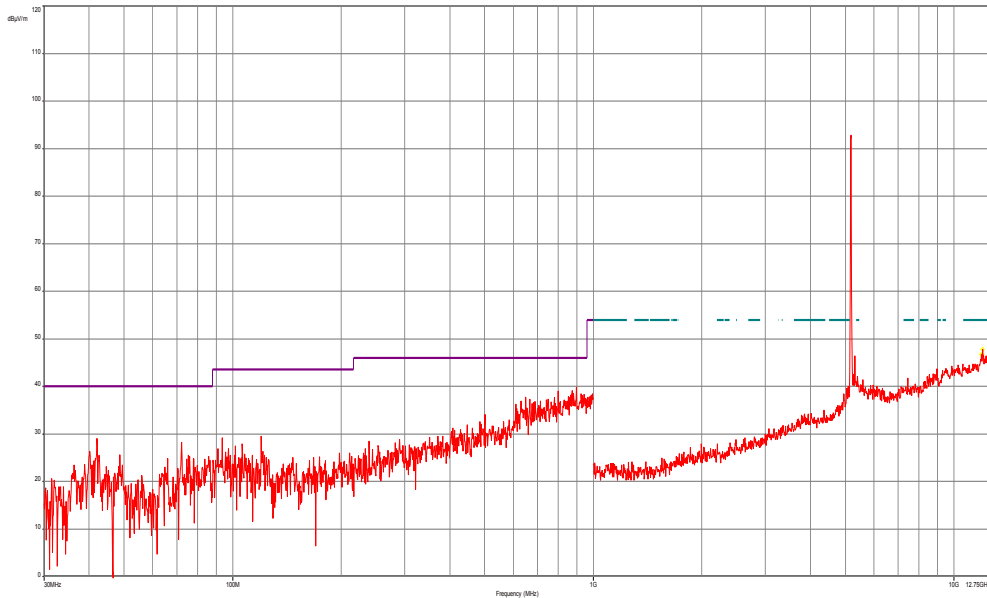

Plot 3: Lowest channel, 12 GHz to 18 GHz (vertical / horizontal – max hold – also valid for 20m)

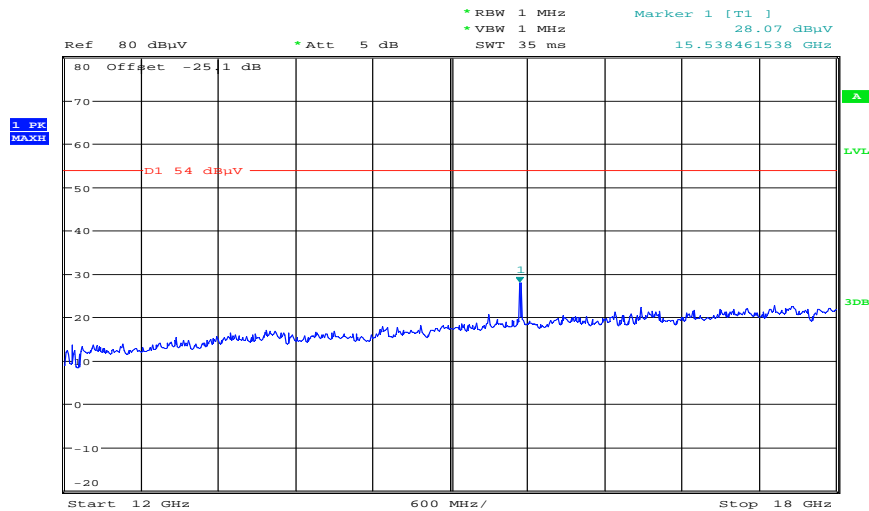

Date: 12.MAR.2012 11:28:44

Plot 4: Lowest channel, 18 GHz to 25 GHz (vertical / horizontal – max hold – also valid for 20m)

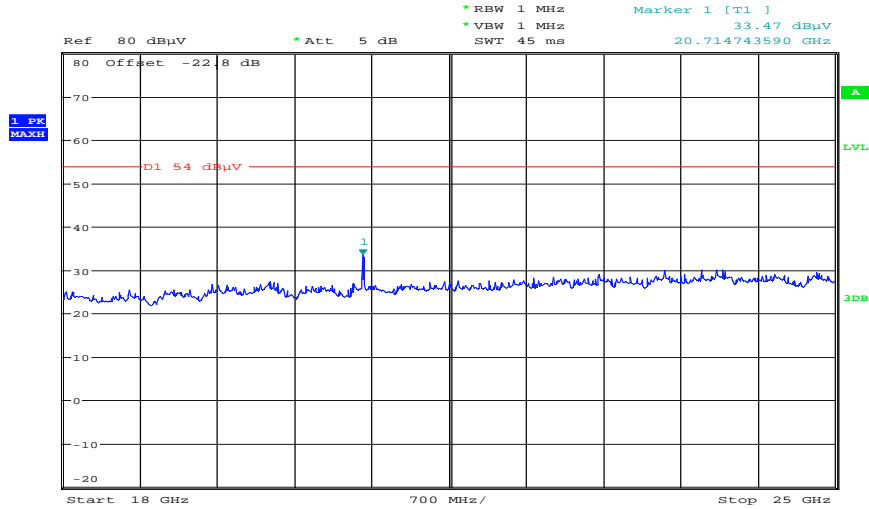

Date: 12.MAR.2012 10:22:27

Plot 5: Lowest channel, 25 GHz to 40 GHz (vertical / horizontal – max hold – also valid for 20m)

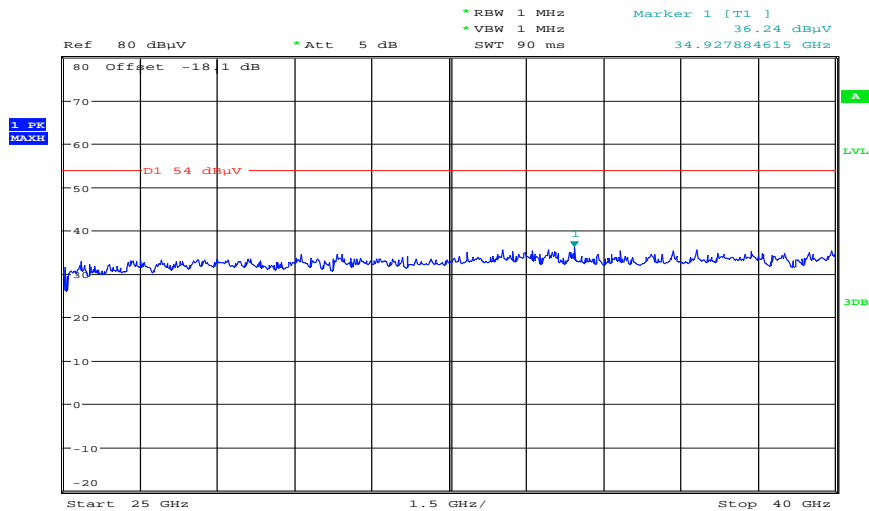

Date: 12.MAR.2012 11:09:13

**Plot 6: Middle channel, 30 MHz to 1 GHz, vertical & horizontal polarization**

**Common Information**

EUT: Quinta CU  
 Serial Number: 00101  
 Test Description: FCC part 15 class B @ 10 m  
 Operating Conditions: Ant B tx@5210MHz  
 Operator Name: Wolsdorfer  
 Comment: AC: 115 V / 60 Hz; ETH-cable S/FTP; 2x SPA2456 antenna + 10m cable

**Scan Setup: STAN\_Fin [EMI radiated]**

Hardware Setup: Electric Field (NOS)  
 Receiver: [ESCI 3]  
 Level Unit: dBµV/m

Subrange	Step Size	Detectors	IF BW	Meas. Time	Preamp
30 MHz - 2 GHz	60 kHz	QPK	120 kHz	1 s	20 dB

FCC\_10m(B)\_5

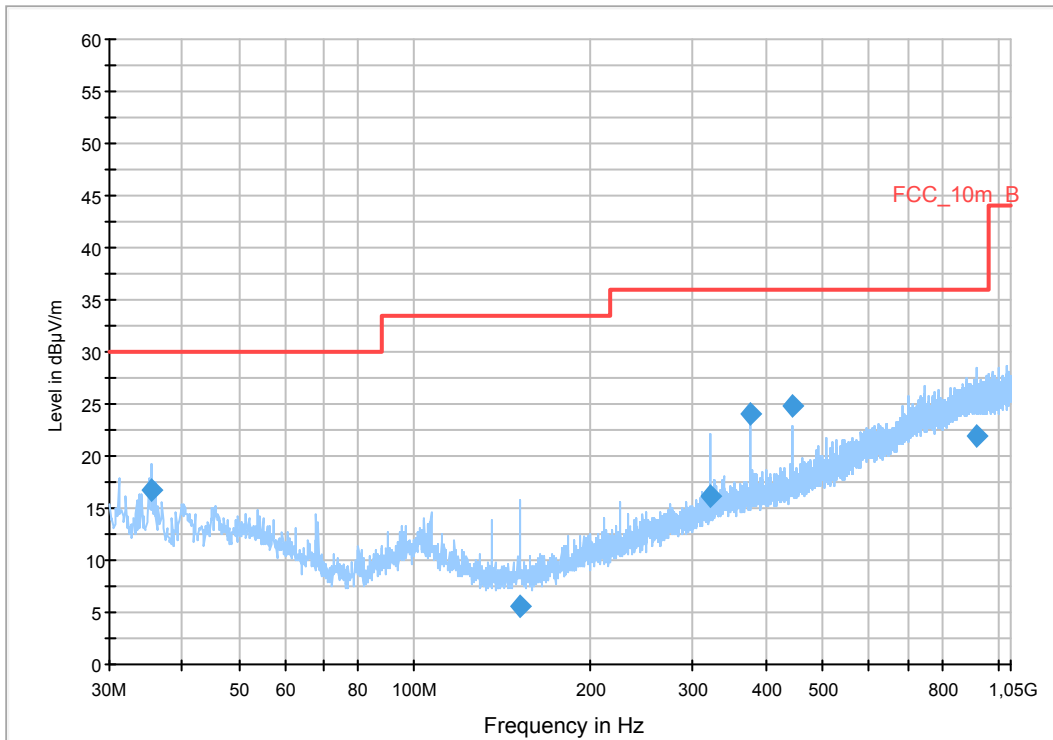

**Final Result 1**

Frequency (MHz)	QuasiPeak (dBµV/m)	Meas. Time (ms)	Bandwidth (kHz)	Height (cm)	Polarization	Azimuth (deg)	Corr. (dB)	Margin (dB)	Limit (dBµV/m)	Comment
35.400000	16.7	1000.0	120.000	264.0	V	261.0	13.1	13.3	30.0	
151.200000	5.5	1000.0	120.000	270.0	V	329.0	9.0	28.0	33.5	
319.920000	16.1	1000.0	120.000	98.0	V	337.0	15.2	19.9	36.0	
375.000000	24.0	1000.0	120.000	105.0	V	94.0	16.5	12.0	36.0	
442.320000	24.9	1000.0	120.000	270.0	H	47.0	17.5	11.1	36.0	
918.720000	21.8	1000.0	120.000	270.0	V	102.0	25.3	14.2	36.0	

Plot 7: Middle channel, 1 GHz to 12.75 GHz, vertical and horizontal polarization

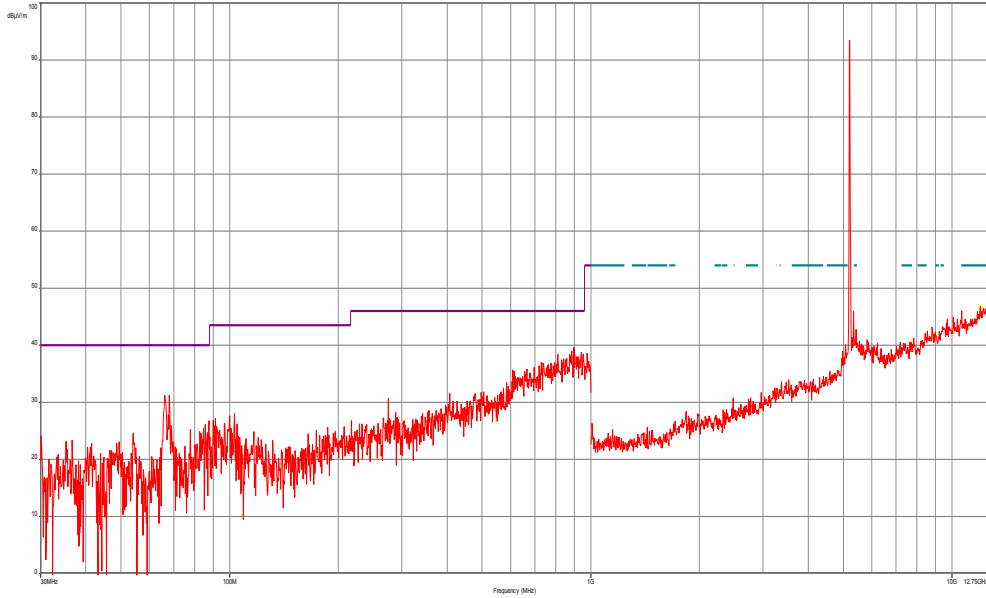

Plot 6: Middle channel, 12 GHz to 18 GHz (vertical / horizontal – max hold – also valid for 20m)

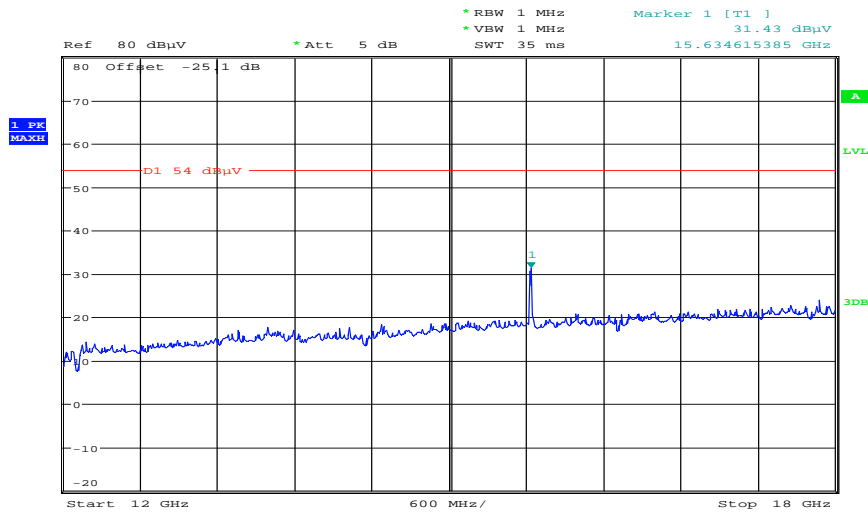

Date: 12.MAR.2012 11:29:20

Plot 9: Middle channel, 18 GHz to 25 GHz (vertical / horizontal – max hold – also valid for 20m)

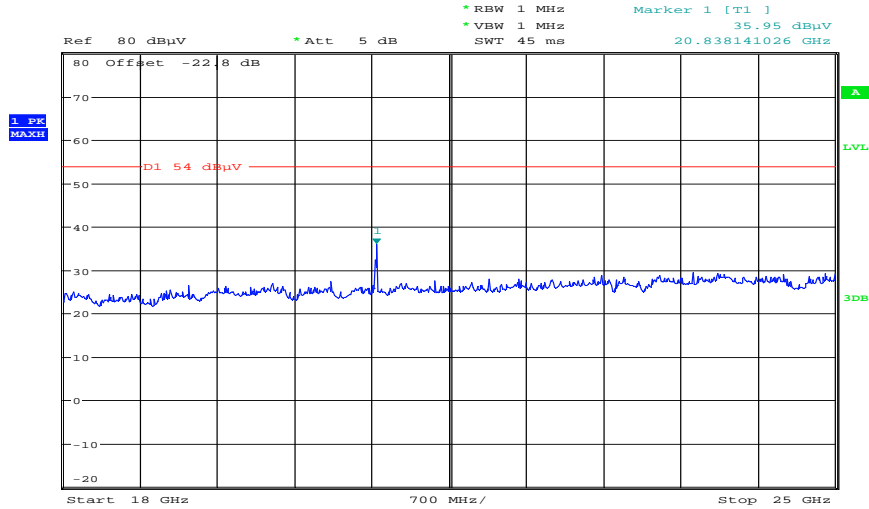

Date: 12.MAR.2012 10:22:53

Plot 10: Middle channel, 25 GHz to 40 GHz (vertical / horizontal – max hold – also valid for 20m)

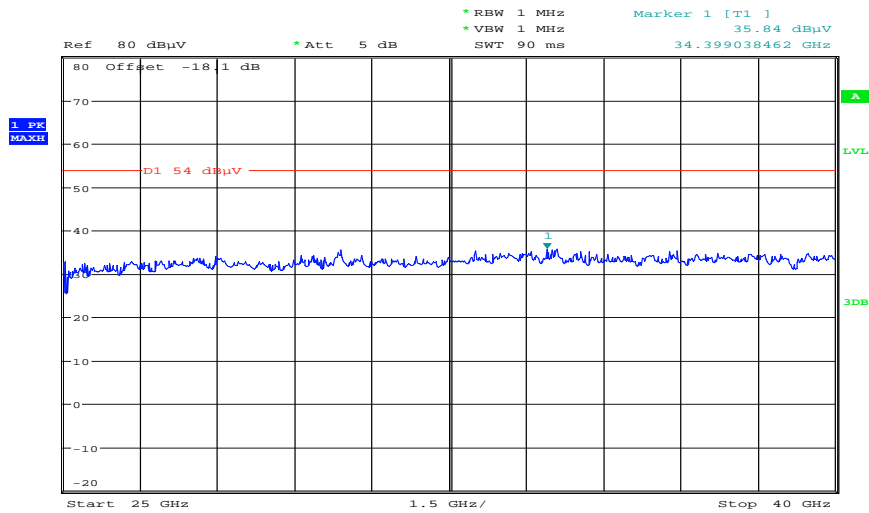

Date: 12.MAR.2012 11:09:45

**Plot 11: Highest channel, 30 MHz to 1 GHz, vertical & horizontal polarization**

**Common Information**

EUT: Quinta CU  
 Serial Number: 00101  
 Test Description: FCC part 15 class B @ 10 m  
 Operating Conditions: Ant B tx@5240MHz  
 Operator Name: Wolsdorfer  
 Comment: AC: 115 V / 60 Hz; ETH-cable S/FTP; 2x SPA2456 antenna + 10m cable

**Scan Setup: STAN\_Fin [EMI radiated]**

Hardware Setup: Electric Field (NOS)  
 Receiver: [ESCI 3]  
 Level Unit: dBµV/m

**Subrange**                      **Step Size**                      **Detectors**                      **IF BW**                      **Meas. Time**                      **Preamp**  
 30 MHz - 2 GHz                      60 kHz                      QPK                      120 kHz                      1 s                      20 dB

FCC\_10m(B)\_5

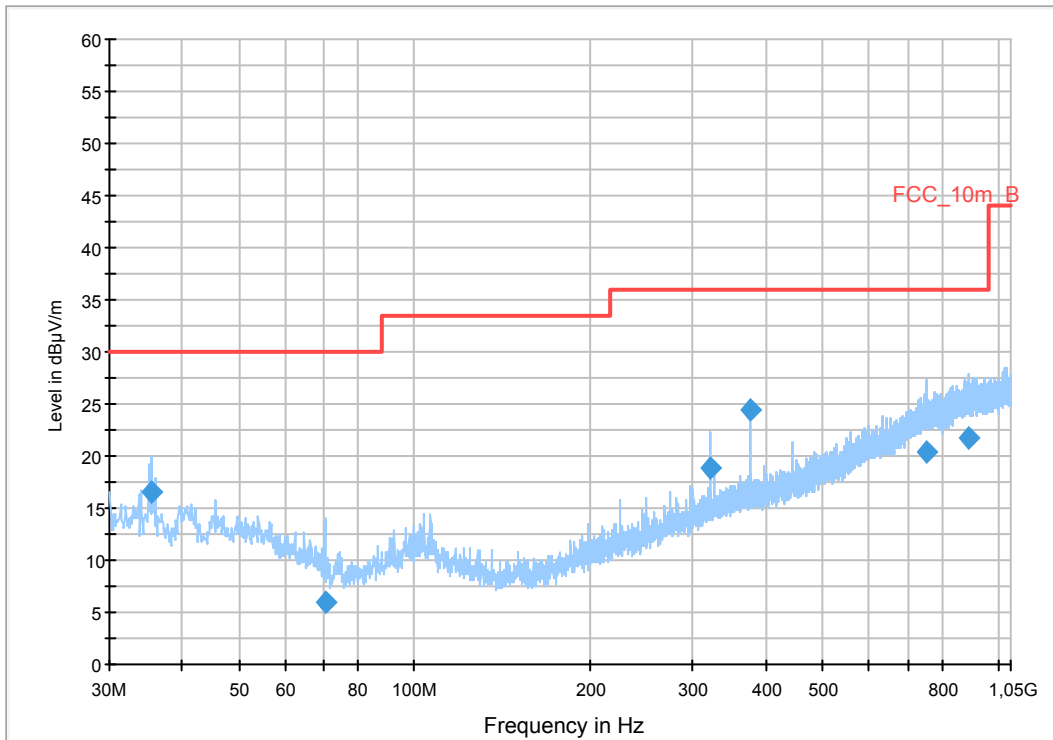

**Final Result 1**

Frequency (MHz)	QuasiPeak (dBµV/m)	Meas. Time (ms)	Bandwidth (kHz)	Height (cm)	Polarization	Azimuth (deg)	Corr. (dB)	Margin (dB)	Limit (dBµV/m)	Comment
35.400000	16.6	1000.0	120.000	261.0	V	352.0	13.1	13.4	30.0	
70.200000	6.0	1000.0	120.000	270.0	V	333.0	9.3	24.0	30.0	
320.040000	18.8	1000.0	120.000	113.0	V	200.0	15.2	17.2	36.0	
375.000000	24.4	1000.0	120.000	98.0	V	99.0	16.5	11.6	36.0	
754.440000	20.4	1000.0	120.000	258.0	V	68.0	23.7	15.6	36.0	
891.240000	21.8	1000.0	120.000	270.0	H	352.0	25.1	14.2	36.0	

Plot 12: Highest channel, 1 GHz to 12.75 GHz, vertical polarization

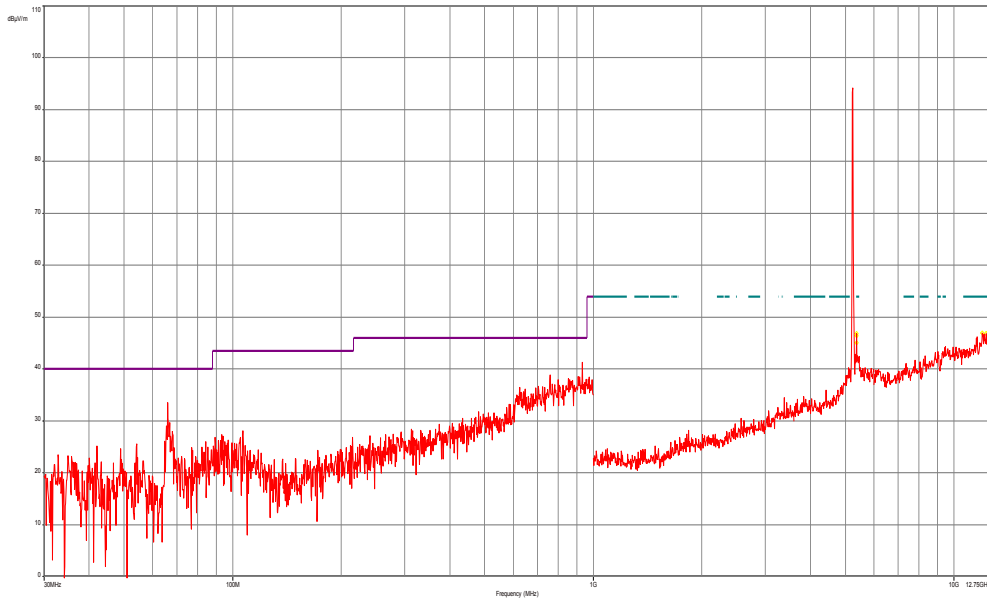

Plot 13: Highest channel, 12 GHz to 18 GHz (vertical / horizontal – max hold – also valid for 20m)

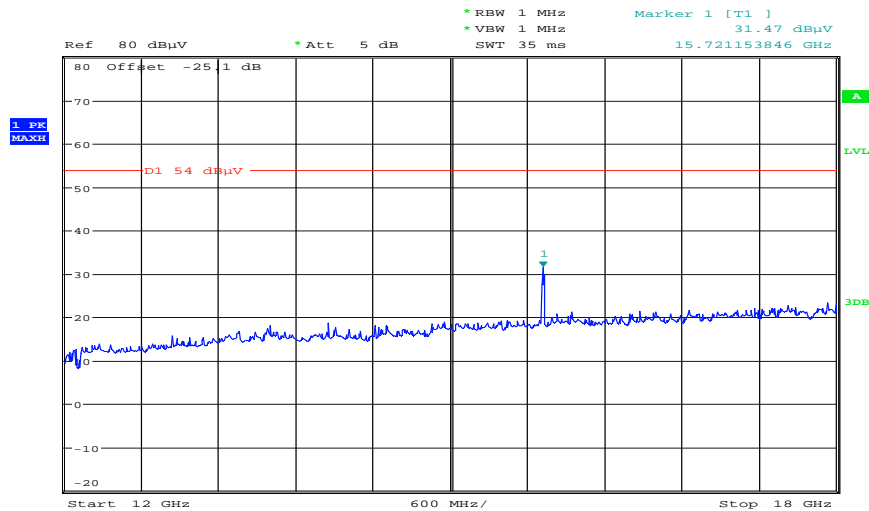

Date: 12.MAR.2012 11:29:59

Plot 14: Highest channel, 18 GHz to 25 GHz (vertical / horizontal – max hold – also valid for 20m)

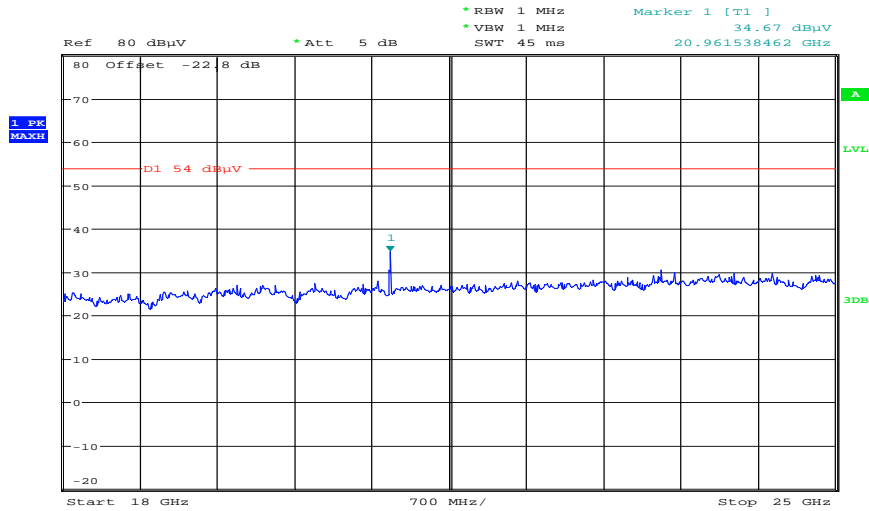

Date: 12.MAR.2012 10:23:36

Plot 15: Highest channel, 25 GHz to 40 GHz (vertical / horizontal – max hold – also valid for 20m)

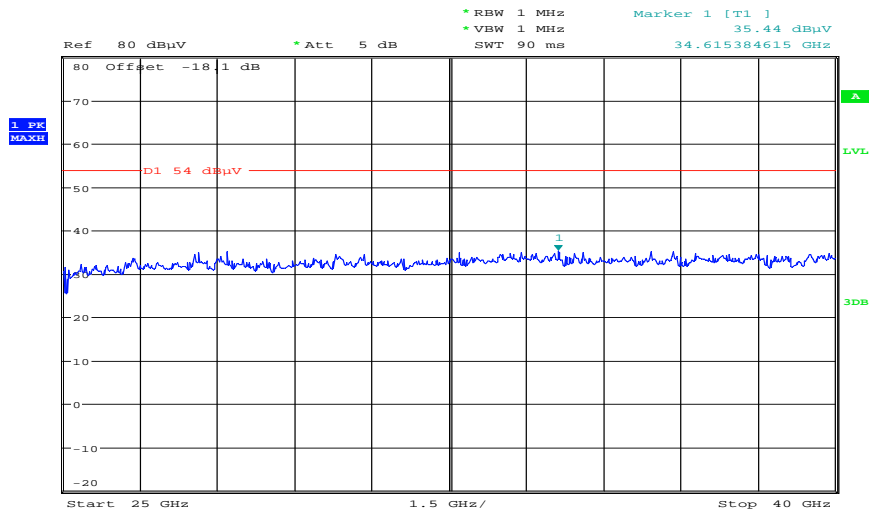

Date: 12.MAR.2012 11:10:14



**Plots: Omnidirectional antenna A with 10 m cable**

**Plot 1: Lowest channel, 30 MHz to 1 GHz, vertical & horizontal polarization**

**Common Information**

EUT: Quinta CU  
 Serial Number: 00101  
 Test Description: FCC part 15 class B @ 10 m  
 Operating Conditions: Ant A tx@5180MHz  
 Operator Name: Wolsdorfer  
 Comment: AC: 115 V / 60 Hz; ETH-cable S/FTP; 2x SWA2459+10m cable

**Scan Setup: STAN\_Fin [EMI radiated]**

Hardware Setup: Electric Field (NOS)  
 Receiver: [ESCI 3]  
 Level Unit: dBµV/m

Subrange	Step Size	Detectors	IF BW	Meas. Time	Preamp
30 MHz - 2 GHz	60 kHz	QPK	120 kHz	1 s	20 dB

FCC\_10m(B)\_5

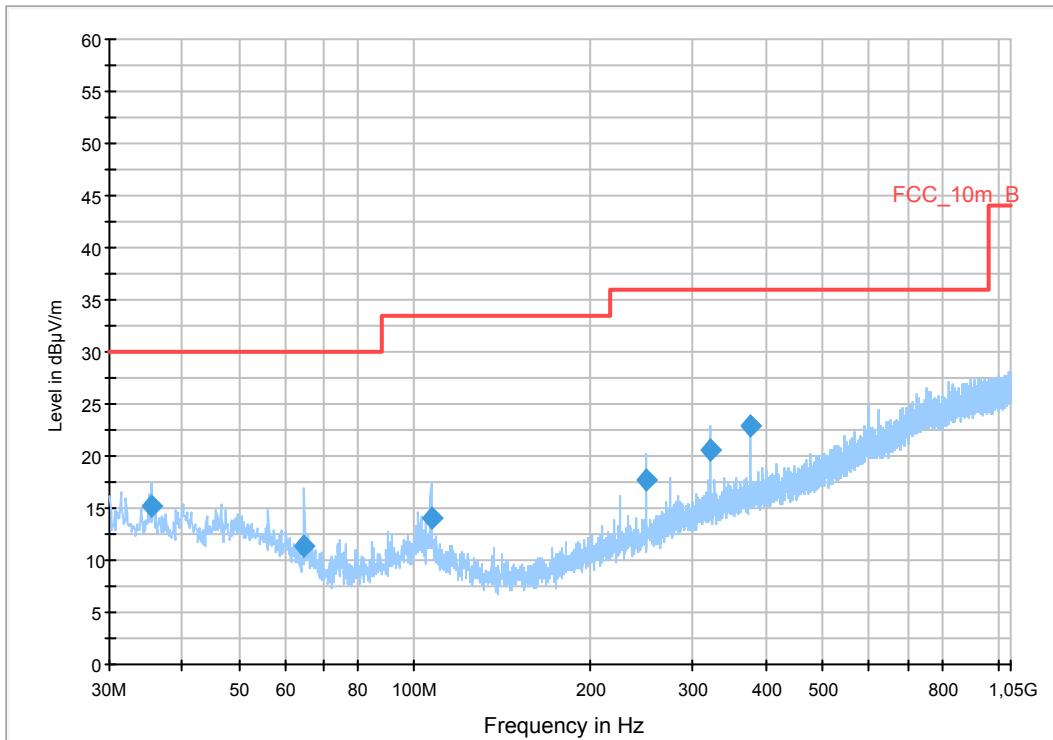

**Final Result 1**

Frequency (MHz)	QuasiPeak (dBµV/m)	Meas. Time (ms)	Bandwidth (kHz)	Height (cm)	Polarization	Azimuth (deg)	Corr. (dB)	Margin (dB)	Limit (dBµV/m)	Comment
35.400000	15.2	1000.0	120.000	209.0	V	348.0	13.1	14.8	30.0	
64.800000	11.3	1000.0	120.000	242.0	V	112.0	10.5	18.7	30.0	
106.680000	14.0	1000.0	120.000	195.0	V	348.0	11.3	19.5	33.5	
249.960000	17.7	1000.0	120.000	98.0	V	170.0	13.3	18.3	36.0	
320.040000	20.5	1000.0	120.000	98.0	V	348.0	15.2	15.5	36.0	
375.000000	22.9	1000.0	120.000	120.0	V	54.0	16.5	13.1	36.0	

Plot 2: Lowest channel, 1 GHz to 12.75 GHz, vertical and horizontal polarization

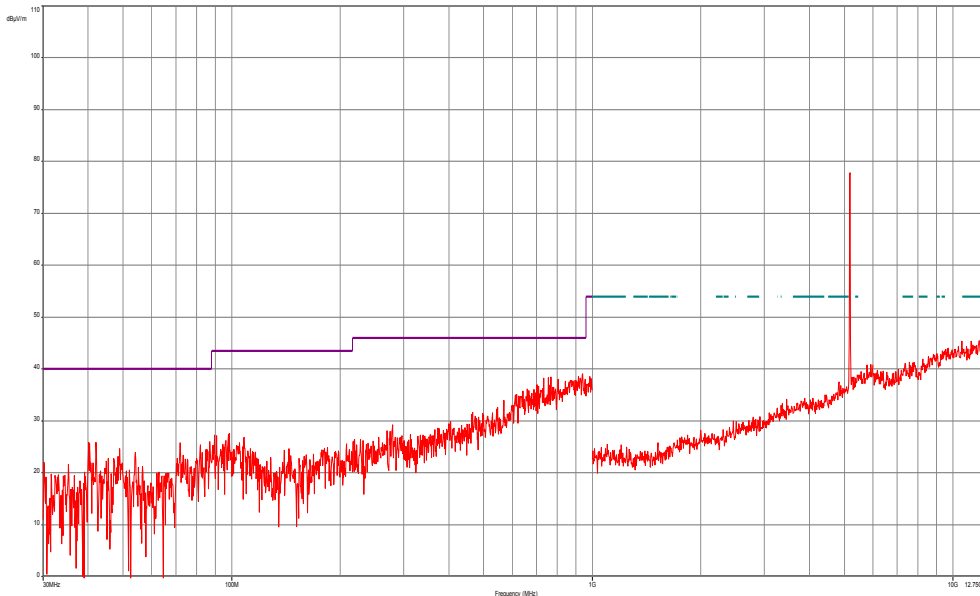

Plot 3: Lowest channel, 12 GHz to 18 GHz (vertical / horizontal – max hold – also valid for 20m)

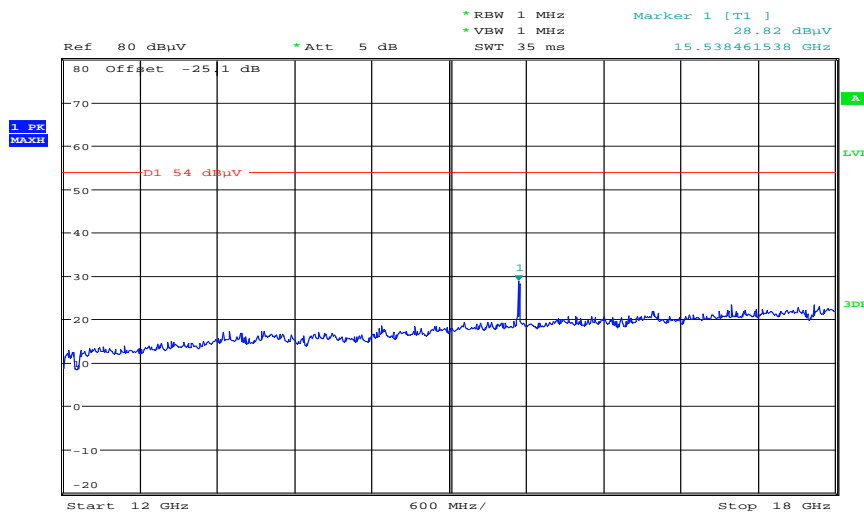

Date: 12.MAR.2012 11:40:55

Plot 4: Lowest channel, 18 GHz to 25 GHz (vertical / horizontal – max hold – also valid for 20m)

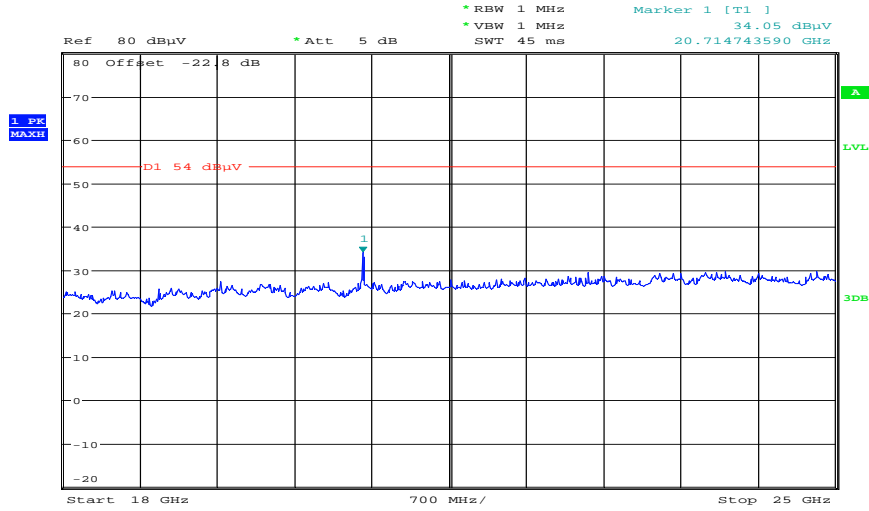

Date: 12.MAR.2012 10:13:23

Plot 5: Lowest channel, 25 GHz to 40 GHz (vertical / horizontal – max hold – also valid for 20m)

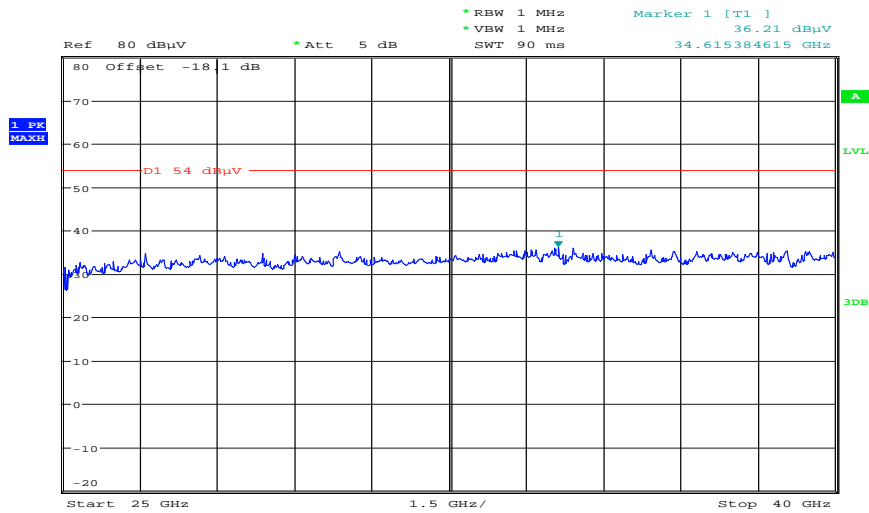

Date: 12.MAR.2012 10:53:55

**Plot 6: Middle channel, 30 MHz to 1 GHz, vertical & horizontal polarization**

**Common Information**

EUT: Quinta CU  
 Serial Number: 00101  
 Test Description: FCC part 15 class B @ 10 m  
 Operating Conditions: Ant A tx@5210MHz  
 Operator Name: Wolsdorfer  
 Comment: AC: 115 V / 60 Hz; ETH-cable S/FTP; 2x SWA2459+10m cable

**Scan Setup: STAN\_Fin [EMI radiated]**

Hardware Setup: Electric Field (NOS)  
 Receiver: [ESCI 3]  
 Level Unit: dBµV/m

Subrange	Step Size	Detectors	IF BW	Meas. Time	Preamp
30 MHz - 2 GHz	60 kHz	QPK	120 kHz	1 s	20 dB

FCC\_10m(B)\_5

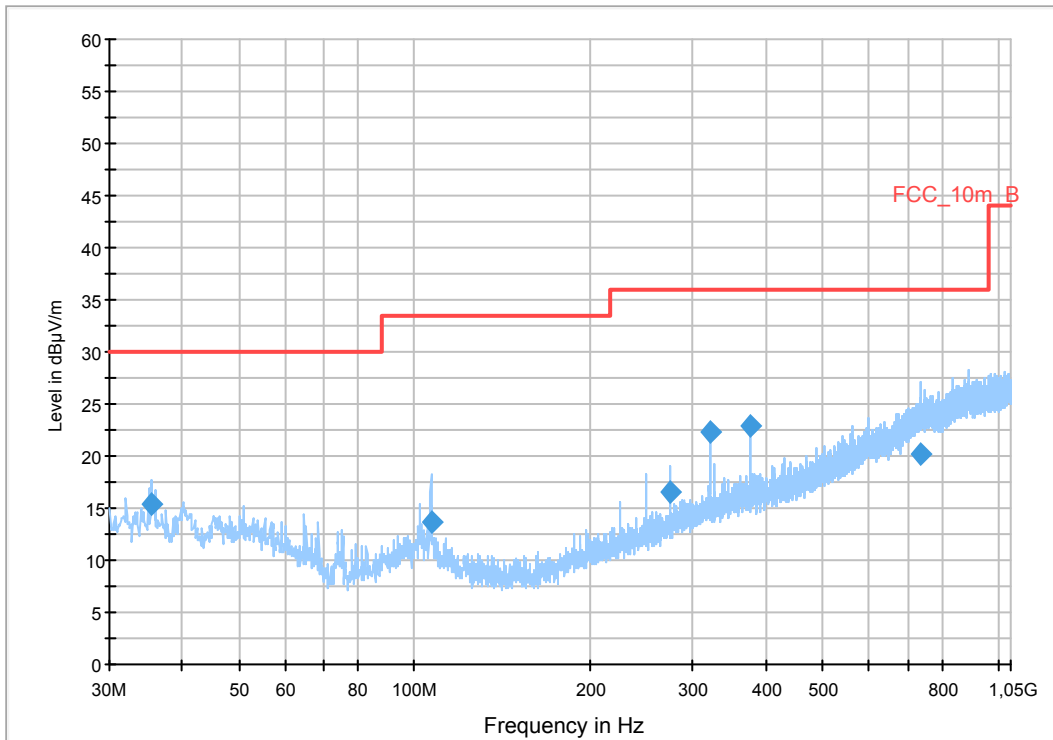

**Final Result 1**

Frequency (MHz)	QuasiPeak (dBµV/m)	Meas. Time (ms)	Bandwidth (kHz)	Height (cm)	Polarization	Azimuth (deg)	Corr. (dB)	Margin (dB)	Limit (dBµV/m)	Comment
35.400000	15.5	1000.0	120.000	124.0	V	98.0	13.1	14.5	30.0	
106.680000	13.6	1000.0	120.000	165.0	V	145.0	11.3	19.9	33.5	
275.040000	16.5	1000.0	120.000	98.0	V	49.0	13.9	19.5	36.0	
320.040000	22.3	1000.0	120.000	98.0	V	320.0	15.2	13.7	36.0	
375.000000	22.9	1000.0	120.000	98.0	V	57.0	16.5	13.1	36.0	
735.120000	20.1	1000.0	120.000	188.0	V	190.0	23.3	15.9	36.0	

Plot 7: Middle channel, 1 GHz to 12.75 GHz, vertical and horizontal polarization

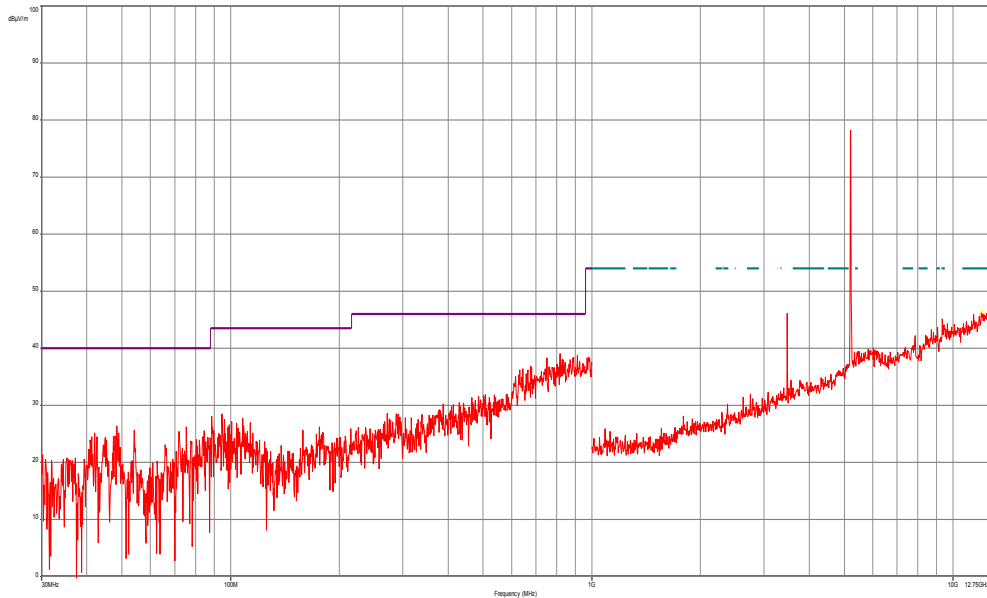

Plot 8: Middle channel, 12 GHz to 18 GHz (vertical / horizontal – max hold – also valid for 20m)

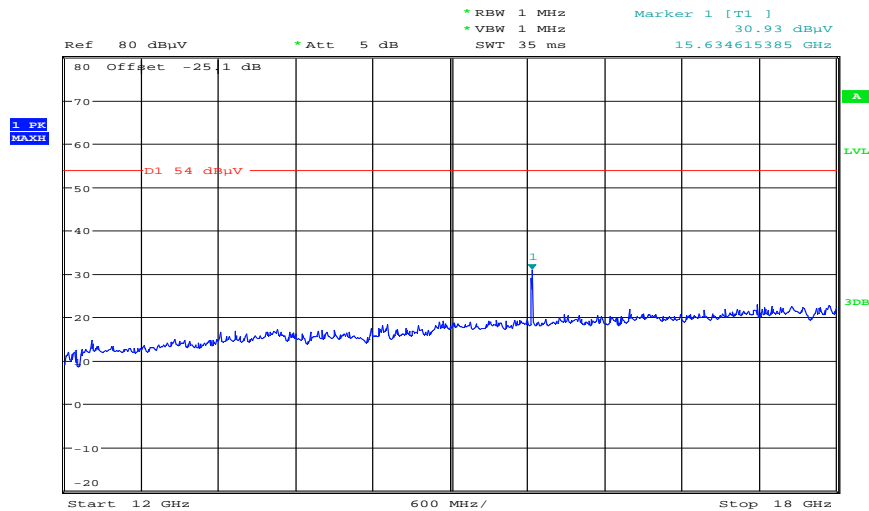

Date: 12.MAR.2012 11:41:49

Plot 9: Middle channel, 18 GHz to 25 GHz (vertical / horizontal – max hold – also valid for 20m)

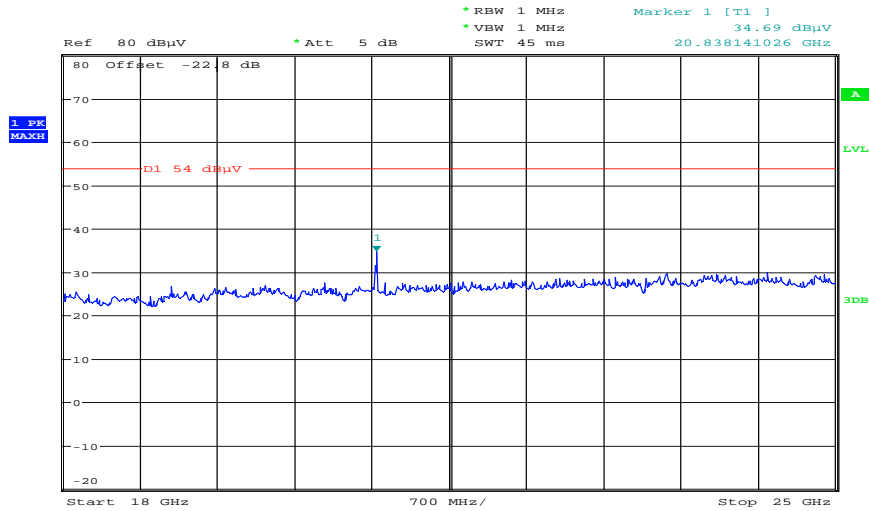

Date: 12.MAR.2012 10:14:05

Plot 10: Middle channel, 25 GHz to 40 GHz (vertical / horizontal – max hold – also valid for 20m)

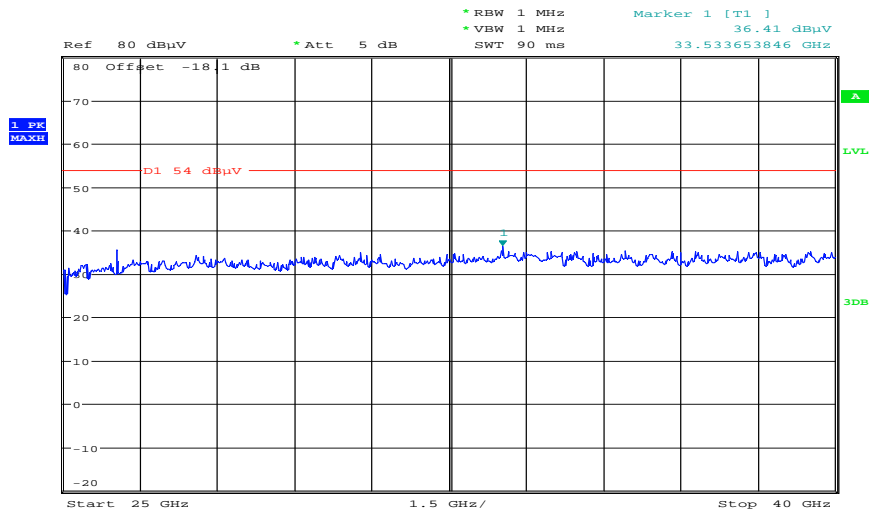

Date: 12.MAR.2012 10:54:26

**Plot 11: Highest channel, 30 MHz to 1 GHz, vertical & horizontal polarization**

**Common Information**

EUT: Quinta CU  
 Serial Number: 00101  
 Test Description: FCC part 15 class B @ 10 m  
 Operating Conditions: Ant A tx@5240MHz  
 Operator Name: Wolsdorfer  
 Comment: AC: 115 V / 60 Hz; ETH-cable S/FTP; 2x SWA2459+10m cable

**Scan Setup: STAN\_Fin [EMI radiated]**

Hardware Setup: Electric Field (NOS)  
 Receiver: [ESCI 3]  
 Level Unit: dBµV/m

Subrange	Step Size	Detectors	IF BW	Meas. Time	Preamp
30 MHz - 2 GHz	60 kHz	QPK	120 kHz	1 s	20 dB

FCC\_10m(B)\_5

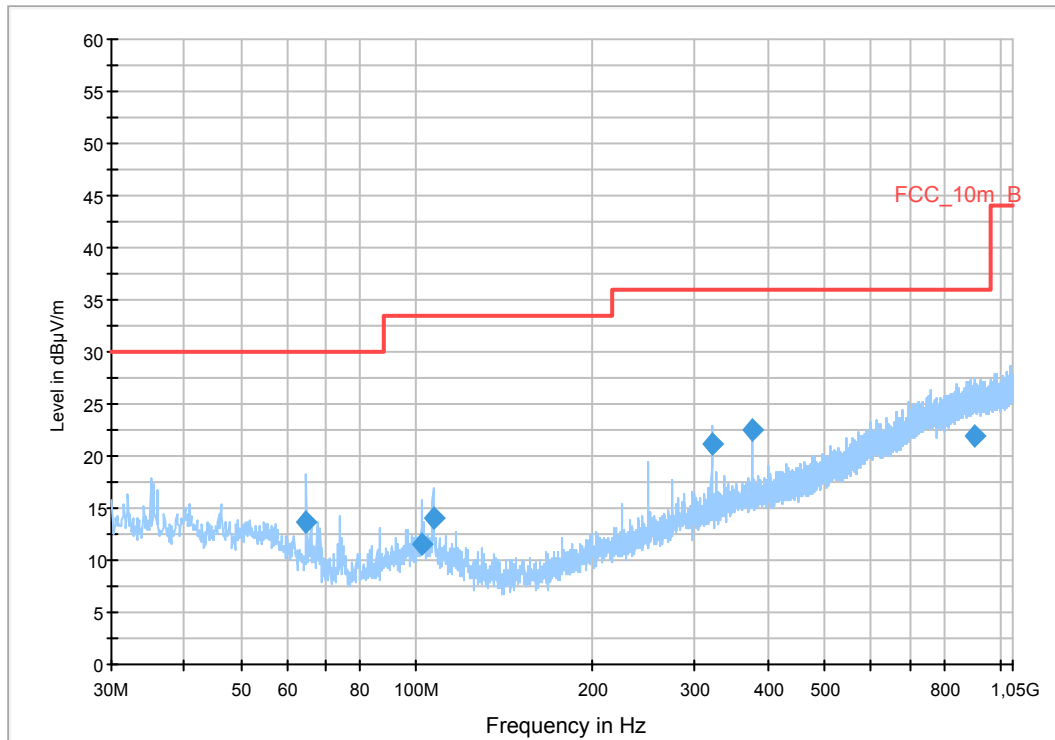

**Final Result 1**

Frequency (MHz)	QuasiPeak (dBµV/m)	Meas. Time (ms)	Bandwidth (kHz)	Height (cm)	Polarization	Azimuth (deg)	Corr. (dB)	Margin (dB)	Limit (dBµV/m)	Comment
64.800000	13.7	1000.0	120.000	186.0	V	50.0	10.5	16.3	30.0	
101.880000	11.6	1000.0	120.000	216.0	V	206.0	11.7	21.9	33.5	
106.680000	14.0	1000.0	120.000	154.0	V	149.0	11.3	19.5	33.5	
320.040000	21.1	1000.0	120.000	98.0	V	303.0	15.2	14.9	36.0	
375.000000	22.6	1000.0	120.000	98.0	V	36.0	16.5	13.4	36.0	
900.480000	21.8	1000.0	120.000	271.0	V	138.0	25.2	14.2	36.0	

Plot 12: Highest channel, 1 GHz to 12.75 GHz, vertical and horizontal polarization

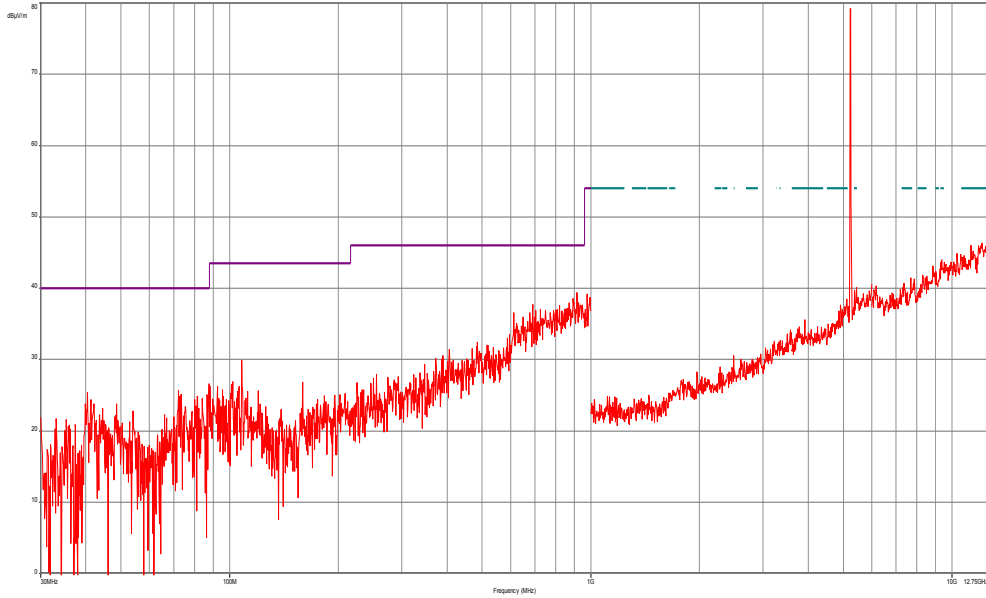

Plot 13: Highest channel, 12 GHz to 18 GHz (vertical / horizontal – max hold – also valid for 20m)

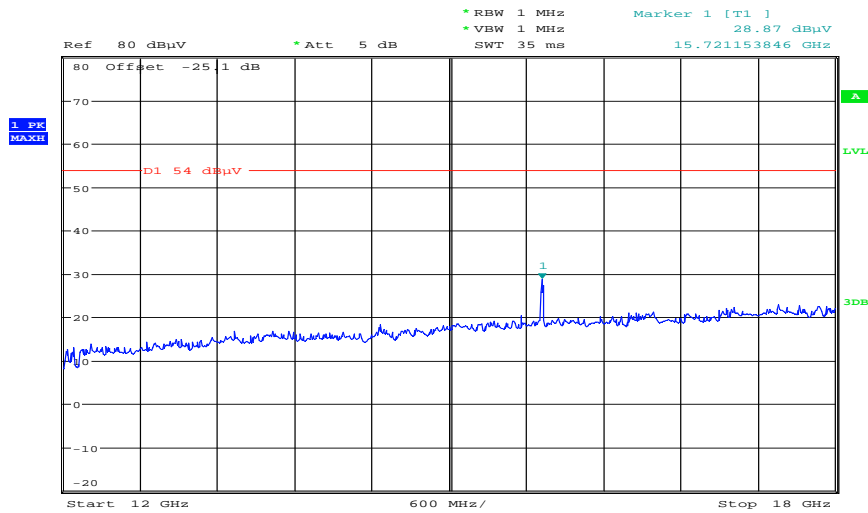

Date: 12.MAR.2012 11:42:23



Plot 14: Highest channel, 18 GHz to 25 GHz (vertical / horizontal – max hold – also valid for 20m)

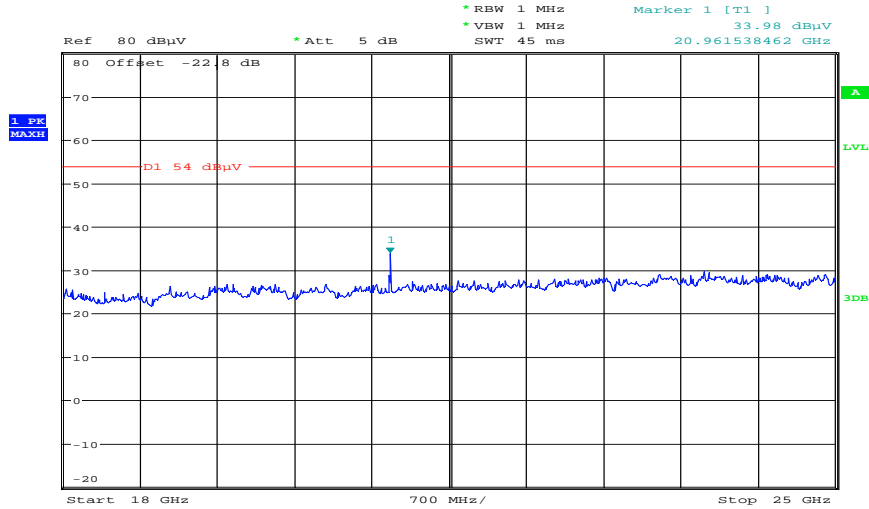

Date: 12.MAR.2012 10:15:02

Plot 15: Highest channel, 25 GHz to 40 GHz (vertical / horizontal – max hold – also valid for 20m)

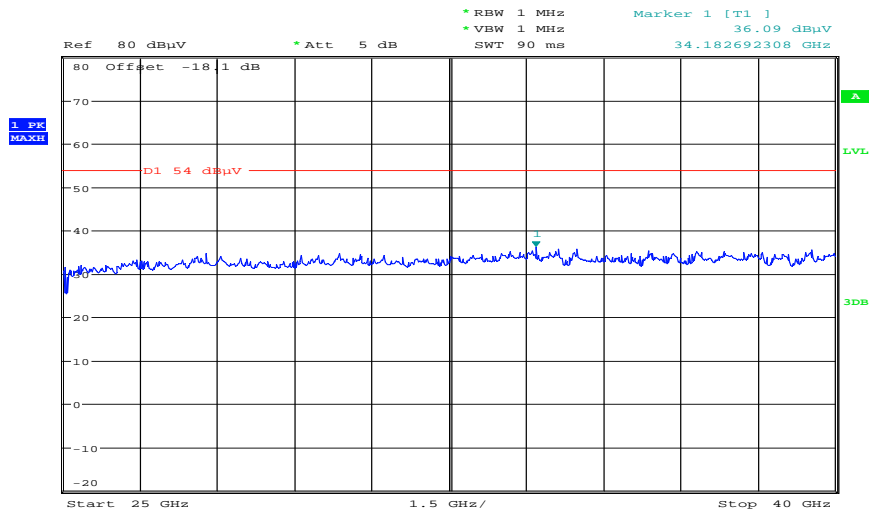

Date: 12.MAR.2012 10:55:12

**Plots: Omnidirectional antenna B with 10 m cable**

**Plot 1: Lowest channel, 30 MHz to 1 GHz, vertical & horizontal polarization**

**Common Information**

EUT: Quinta CU  
 Serial Number: 00101  
 Test Description: FCC part 15 class B @ 10 m  
 Operating Conditions: Ant B tx@5180MHz  
 Operator Name: Wolsdorfer  
 Comment: AC: 115 V / 60 Hz; ETH-cable S/FTP; 2x SWA2459+10m cable

**Scan Setup: STAN\_Fin [EMI radiated]**

Hardware Setup: Electric Field (NOS)  
 Receiver: [ESCI 3]  
 Level Unit: dBµV/m

**Subrange**                      **Step Size**                      **Detectors**                      **IF BW**                      **Meas. Time**                      **Preamp**  
 30 MHz - 2 GHz                      60 kHz                      QPK                      120 kHz                      1 s                      20 dB

FCC\_10m(B)\_5

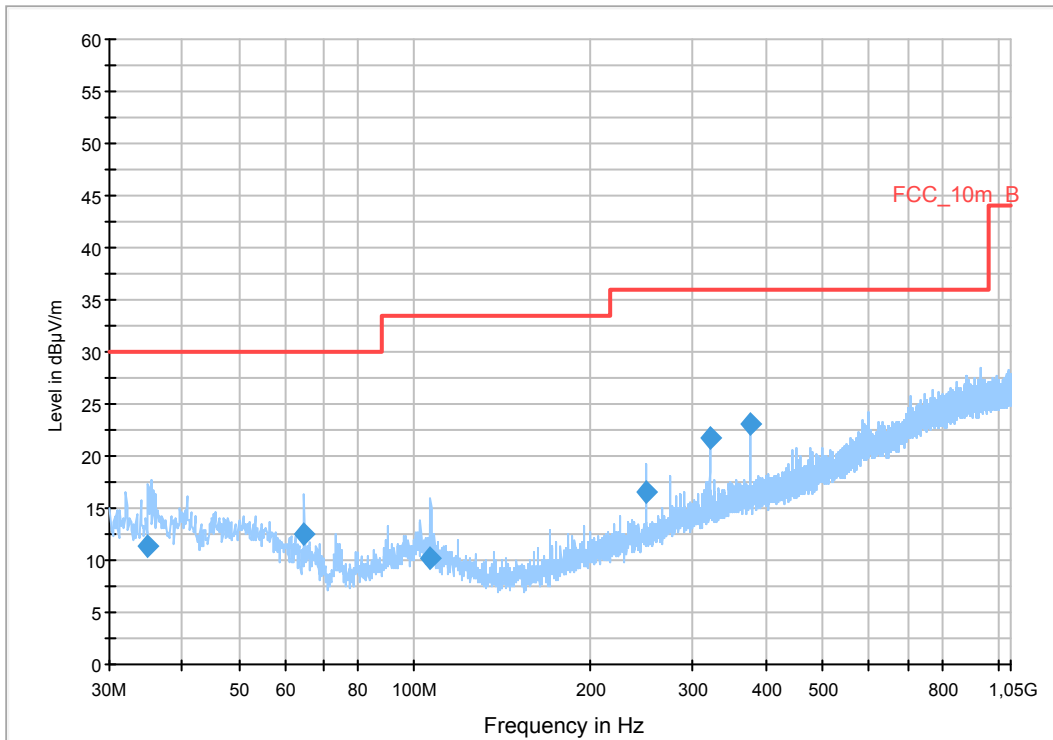

**Final Result 1**

Frequency (MHz)	QuasiPeak (dBµV/m)	Meas. Time (ms)	Bandwidth (kHz)	Height (cm)	Polarization	Azimuth (deg)	Corr. (dB)	Margin (dB)	Limit (dBµV/m)	Comment
34.920000	11.3	1000.0	120.000	272.0	V	303.0	13.0	18.7	30.0	
64.800000	12.6	1000.0	120.000	272.0	V	49.0	10.5	17.4	30.0	
106.560000	10.2	1000.0	120.000	145.0	V	26.0	11.3	23.3	33.5	
249.960000	16.6	1000.0	120.000	98.0	V	173.0	13.3	19.4	36.0	
320.040000	21.7	1000.0	120.000	98.0	V	329.0	15.2	14.3	36.0	
375.000000	23.1	1000.0	120.000	98.0	V	49.0	16.5	12.9	36.0	

Plot 2: Lowest channel, 1 GHz to 12.75 GHz, vertical and horizontal polarization

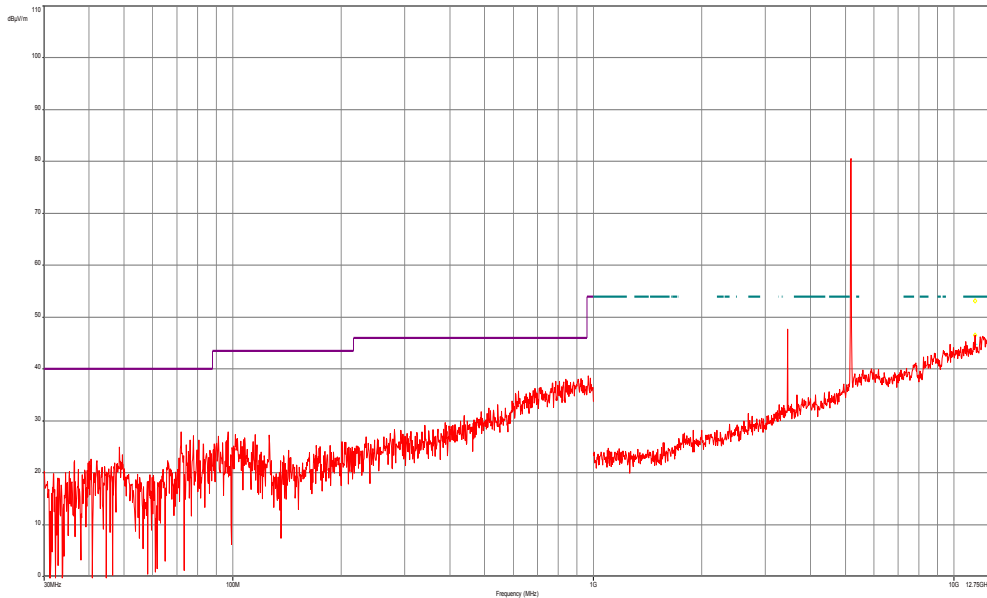

Plot 3: Lowest channel, 12 GHz to 18 GHz (vertical / horizontal – max hold – also valid for 20m)

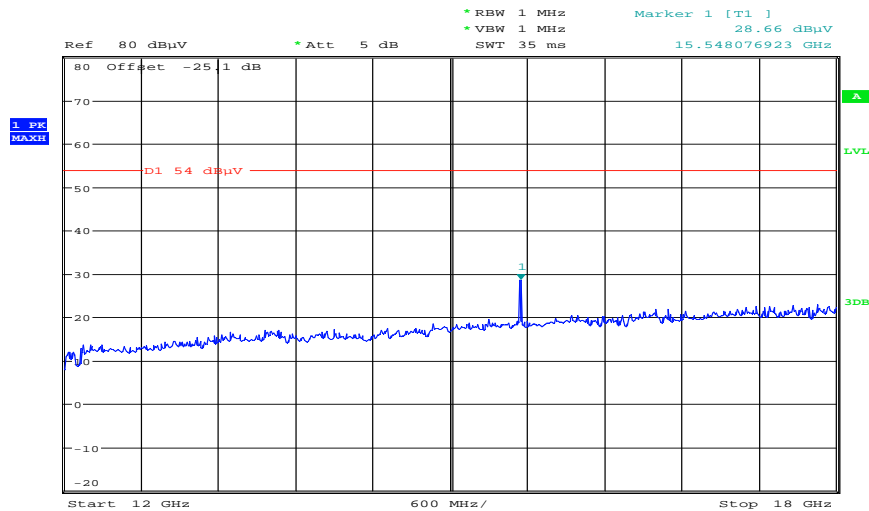

Date: 12.MAR.2012 11:43:11

Plot 4: Lowest channel, 18 GHz to 25 GHz (vertical / horizontal – max hold – also valid for 20m)

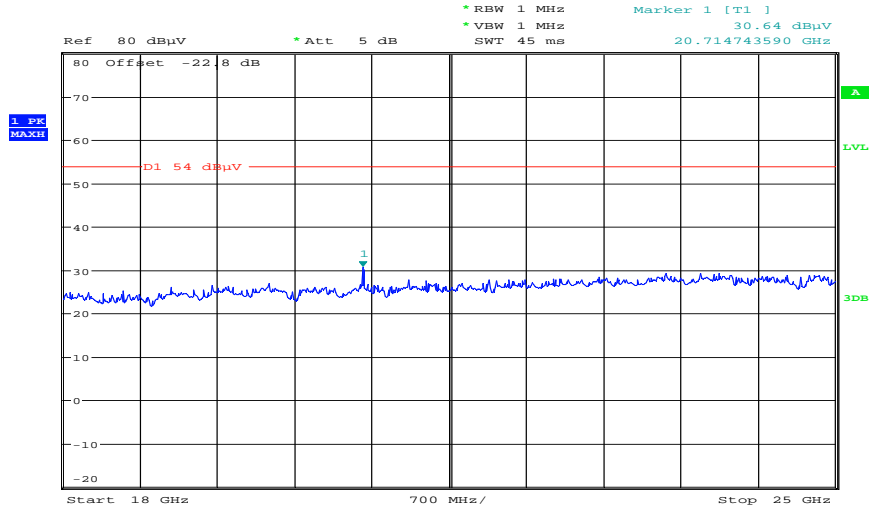

Date: 12.MAR.2012 10:16:03

Plot 5: Lowest channel, 25 GHz to 40 GHz (vertical / horizontal – max hold – also valid for 20m)

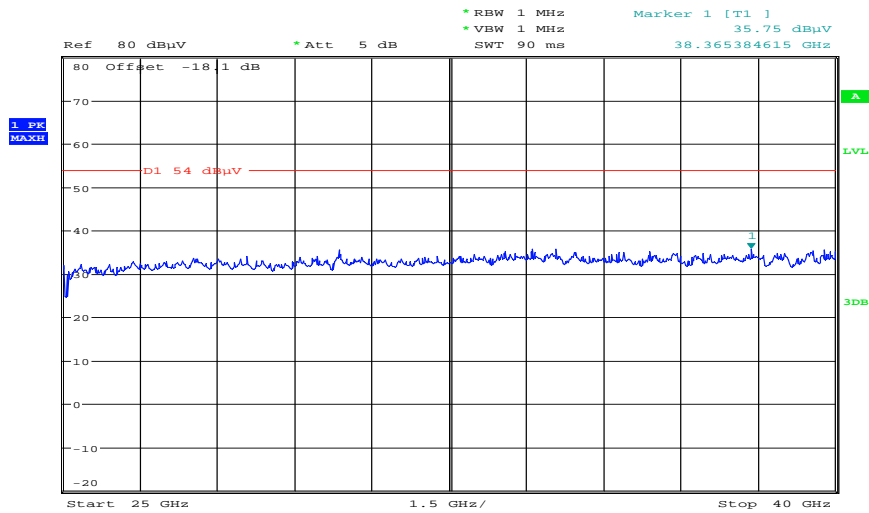

Date: 12.MAR.2012 10:55:43

**Plot 6: Middle channel, 30 MHz to 1 GHz, vertical & horizontal polarization**

**Common Information**

EUT: Quinta CU  
 Serial Number: 00101  
 Test Description: FCC part 15 class B @ 10 m  
 Operating Conditions: Ant B tx@5210MHz  
 Operator Name: Wolsdorfer  
 Comment: AC: 115 V / 60 Hz; ETH-cable S/FTP; 2x SWA2459+10m cable

**Scan Setup: STAN\_Fin [EMI radiated]**

Hardware Setup: Electric Field (NOS)  
 Receiver: [ESCI 3]  
 Level Unit: dBµV/m

Subrange	Step Size	Detectors	IF BW	Meas. Time	Preamp
30 MHz - 2 GHz	60 kHz	QPK	120 kHz	1 s	20 dB

FCC\_10m(B)\_5

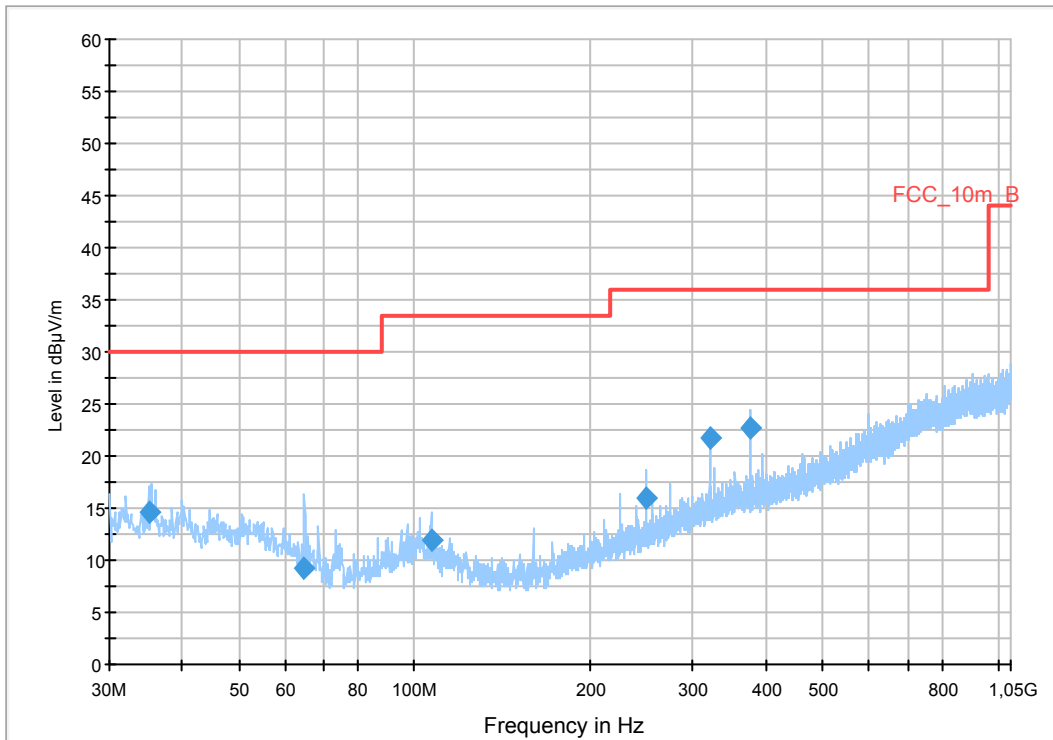

**Final Result 1**

Frequency (MHz)	QuasiPeak (dBµV/m)	Meas. Time (ms)	Bandwidth (kHz)	Height (cm)	Polarization	Azimuth (deg)	Corr. (dB)	Margin (dB)	Limit (dBµV/m)	Comment
35.040000	14.6	1000.0	120.000	128.0	V	80.0	13.0	15.4	30.0	
64.800000	9.3	1000.0	120.000	270.0	V	317.0	10.5	20.7	30.0	
106.680000	11.9	1000.0	120.000	120.0	V	72.0	11.3	21.6	33.5	
249.960000	15.9	1000.0	120.000	165.0	V	156.0	13.3	20.1	36.0	
320.040000	21.7	1000.0	120.000	98.0	V	328.0	15.2	14.3	36.0	
375.000000	22.7	1000.0	120.000	120.0	V	49.0	16.5	13.3	36.0	

Plot 7: Middle channel, 1 GHz to 12.75 GHz, vertical and horizontal polarization

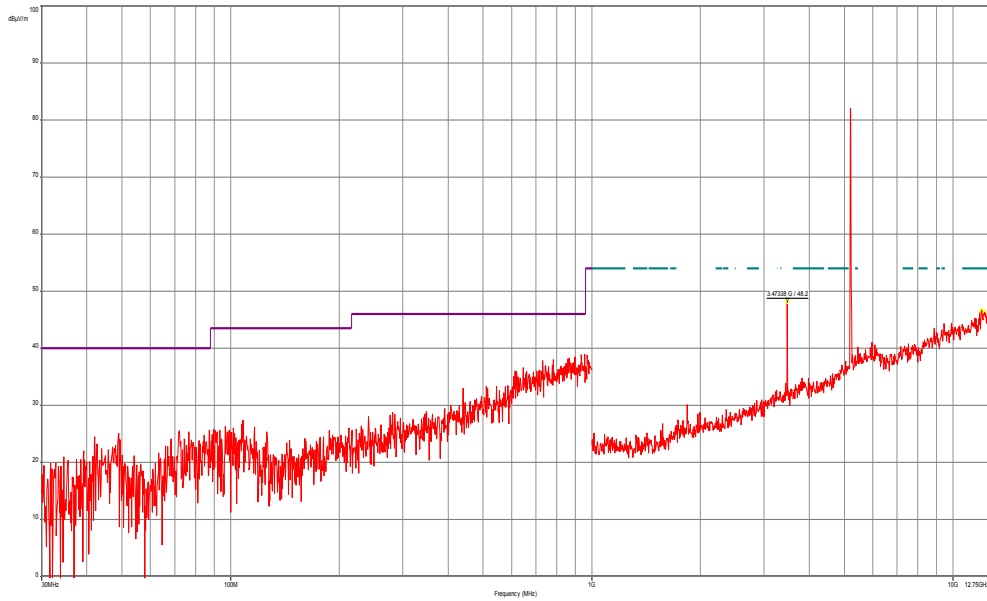

Plot 8: Middle channel, 12 GHz to 18 GHz (vertical / horizontal – max hold – also valid for 20m)

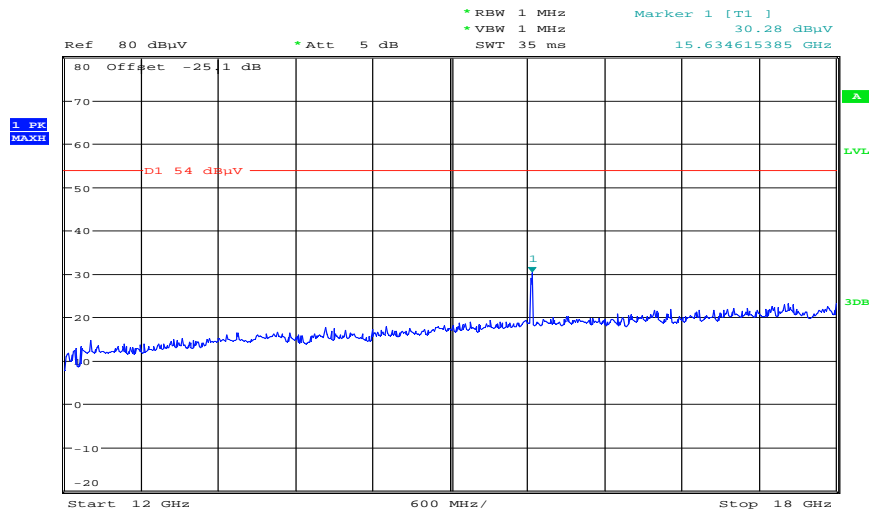

Date: 12.MAR.2012 11:43:43

Plot 9: Middle channel, 18 GHz to 25 GHz (vertical / horizontal – max hold – also valid for 20m)

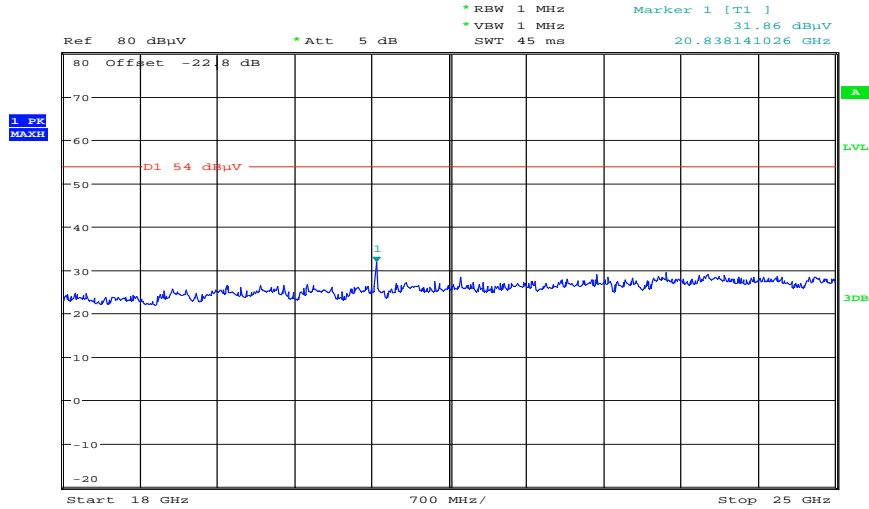

Date: 12.MAR.2012 10:16:32

Plot 10: Middle channel, 25 GHz to 40 GHz (vertical / horizontal – max hold – also valid for 20m)

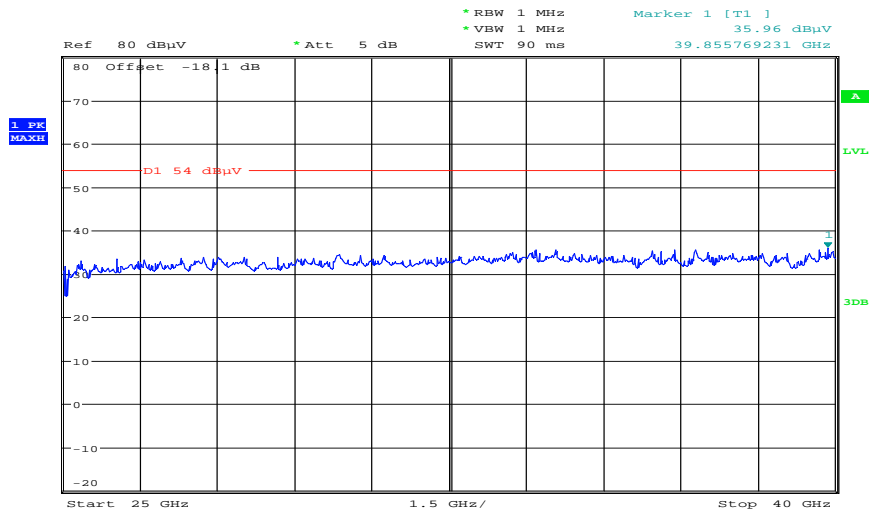

Date: 12.MAR.2012 10:56:11

**Plot 11: Highest channel, 30 MHz to 1 GHz, vertical & horizontal polarization**

**Common Information**

EUT: Quinta CU  
 Serial Number: 00101  
 Test Description: FCC part 15 class B @ 10 m  
 Operating Conditions: Ant B tx@5240MHz  
 Operator Name: Wolsdorfer  
 Comment: AC: 115 V / 60 Hz; ETH-cable S/FTP; 2x SWA2459 antenna + 10m cable

**Scan Setup: STAN\_Fin [EMI radiated]**

Hardware Setup: Electric Field (NOS)  
 Receiver: [ESCI 3]  
 Level Unit: dBµV/m

**Subrange**                      **Step Size**                      **Detectors**                      **IF BW**                      **Meas. Time**                      **Preamp**  
 30 MHz - 2 GHz                      60 kHz                      QPK                      120 kHz                      1 s                      20 dB

FCC\_10m(B)\_5

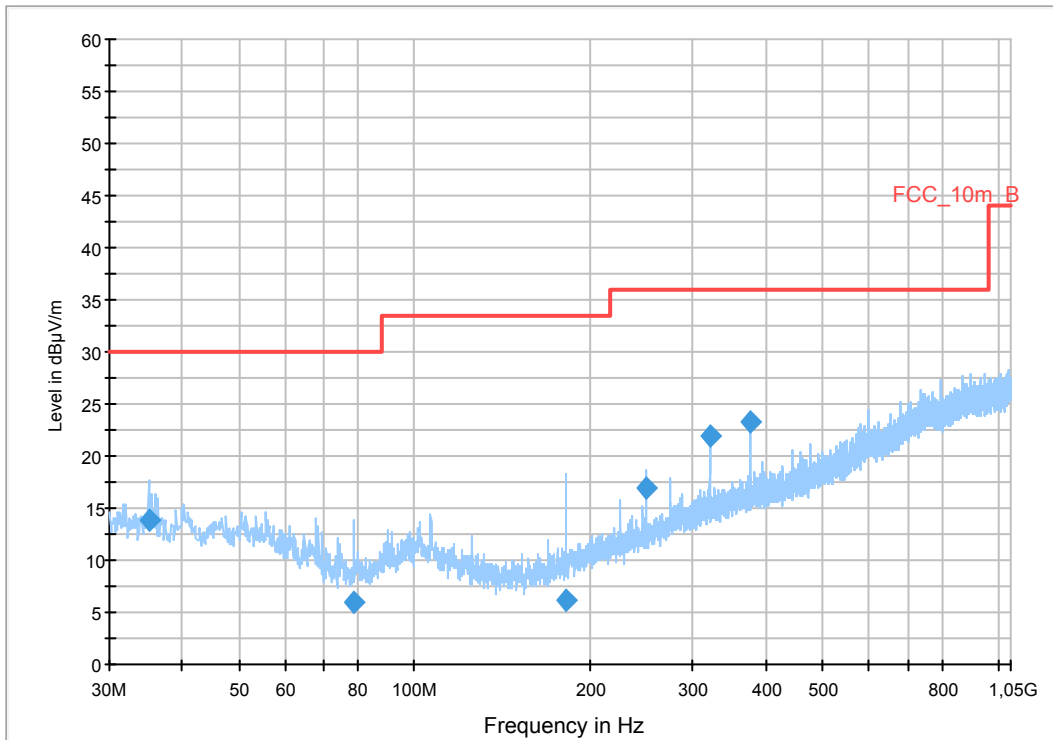

**Final Result 1**

Frequency (MHz)	QuasiPeak (dBµV/m)	Meas. Time (ms)	Bandwidth (kHz)	Height (cm)	Polarization	Azimuth (deg)	Corr. (dB)	Margin (dB)	Limit (dBµV/m)	Comment
35.040000	13.9	1000.0	120.000	185.0	V	149.0	13.0	16.1	30.0	
78.480000	5.9	1000.0	120.000	270.0	V	320.0	9.1	24.1	30.0	
182.280000	6.2	1000.0	120.000	270.0	V	55.0	10.6	27.3	33.5	
249.960000	16.9	1000.0	120.000	145.0	V	176.0	13.3	19.1	36.0	
320.040000	22.0	1000.0	120.000	98.0	V	310.0	15.2	14.0	36.0	
375.000000	23.3	1000.0	120.000	98.0	V	47.0	16.5	12.7	36.0	



Plot 12: Highest channel, 1 GHz to 12.75 GHz, vertical and horizontal polarization

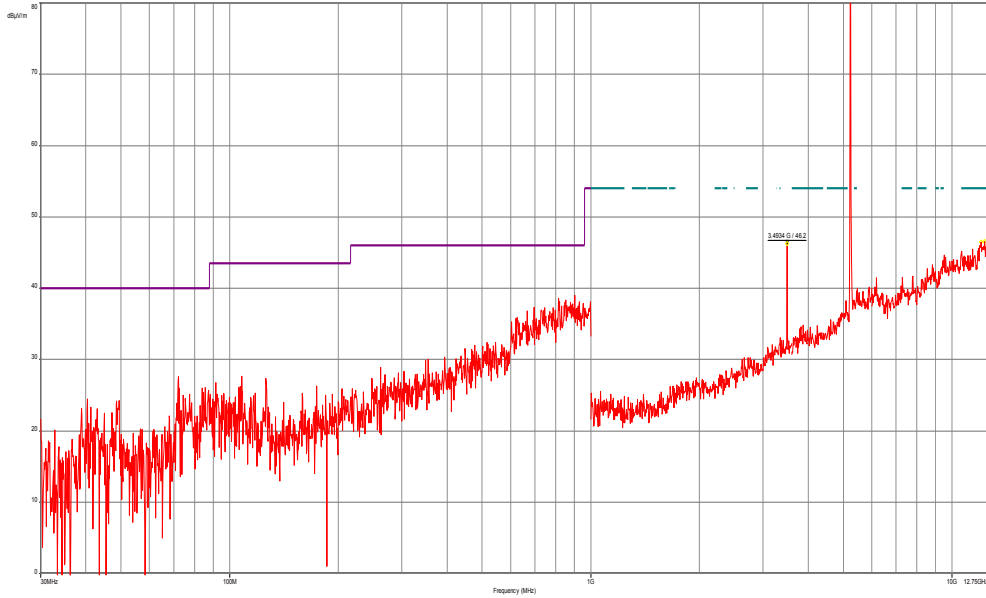

Plot 13: Highest channel, 12 GHz to 18 GHz (vertical / horizontal – max hold – also valid for 20m)

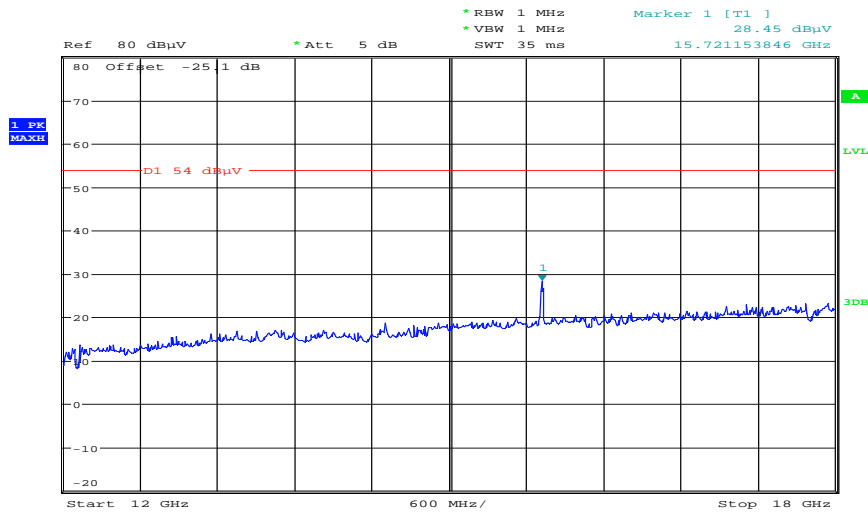

Date: 12.MAR.2012 11:44:27

Plot 14: Highest channel, 18 GHz to 25 GHz (vertical / horizontal – max hold – also valid for 20m)

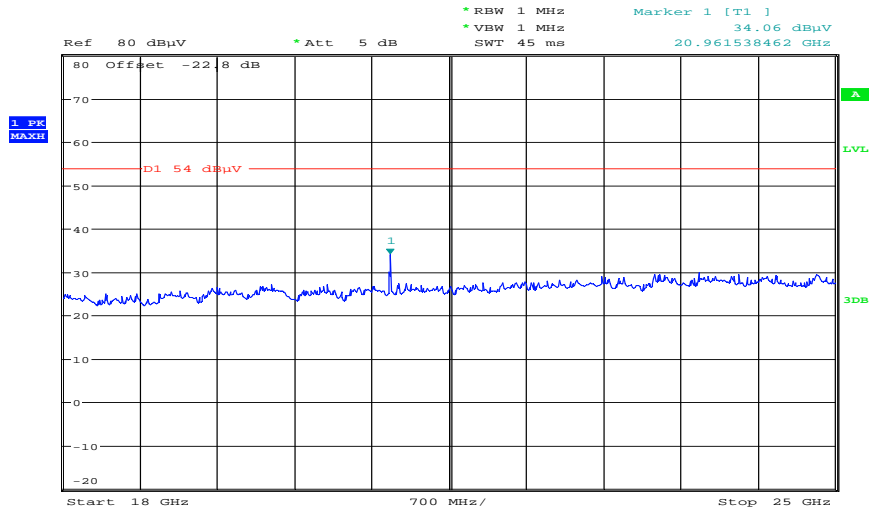

Date: 12.MAR.2012 10:17:15

Plot 15: Highest channel, 25 GHz to 40 GHz (vertical / horizontal – max hold – also valid for 20m)

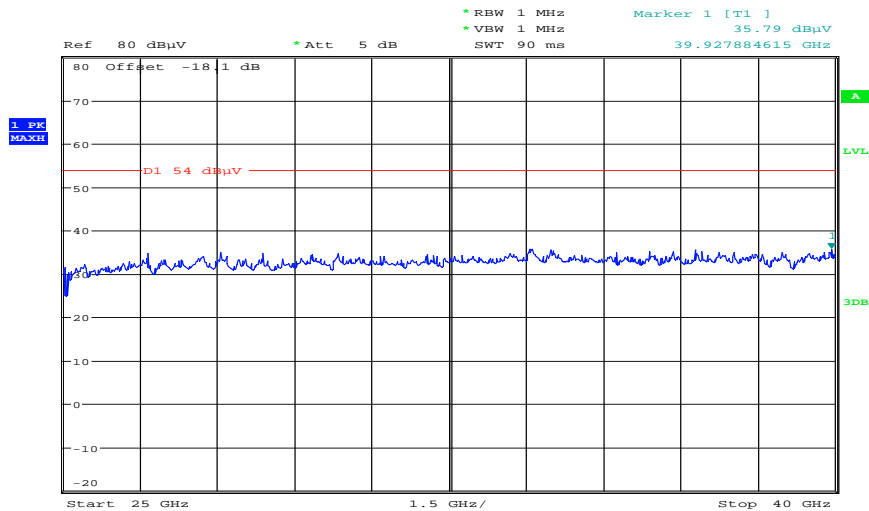

Date: 12.MAR.2012 10:56:47

## 9.10 RX spurious emissions radiated

### Description:

Measurement of the radiated spurious emissions in idle/receive mode.

### Measurement:

Measurement parameter	
Detector:	Quasi Peak below 1 GHz (alternative Peak)  Peak above 1 GHz / RMS
Sweep time:	Auto
Resolution bandwidth:	F < 1 GHz: 100 kHz F > 1 GHz: 1 MHz
Video bandwidth:	F < 1 GHz: 100 kHz F > 1 GHz: ≥ 3 MHz /10 Hz
Span:	30 MHz to 25 GHz
Trace-Mode:	Max Hold / Average with 100 counts + 20 log (1 / X) for duty cycle lower than 100 %

### Limits:

RX Spurious Emissions Radiated		
Frequency (MHz)	Field Strength (dB $\mu$ V/m)	Measurement distance
30 - 88	30.0	10
88 – 216	33.5	10
216 – 960	36.0	10
Above 960	54.0	3

### Results:

RX Spurious Emissions Radiated [dB $\mu$ V/m]		
F [MHz]	Detector	Level [dB $\mu$ V/m]
No critical peaks found		
Measurement uncertainty	± 3 dB	

**Result: Passed.**

**Plots: RX / Idle – mode**

**Plot 1:** 30 MHz to 1 GHz, vertical & horizontal polarization

**Common Information**

EUT: Quinta CU  
 Serial Number: 00101  
 Test Description: FCC part 15 class B @ 10 m  
 Operating Conditions: RX  
 Operator Name: Wolsdorfer  
 Comment: AC: 115 V / 60 Hz; ETH-cable S/FTP; 2x SPA2456 antenna + 10m cable

**Scan Setup: STAN\_Fin [EMI radiated]**

Hardware Setup: Electric Field (NOS)  
 Receiver: [ESCI 3]  
 Level Unit: dBµV/m

**Subrange**                      **Step Size**                      **Detectors**                      **IF BW**                      **Meas. Time**                      **Preamp**  
 30 MHz - 2 GHz                      60 kHz                      QPK                      120 kHz                      1 s                      20 dB

FCC\_10m(B)\_5

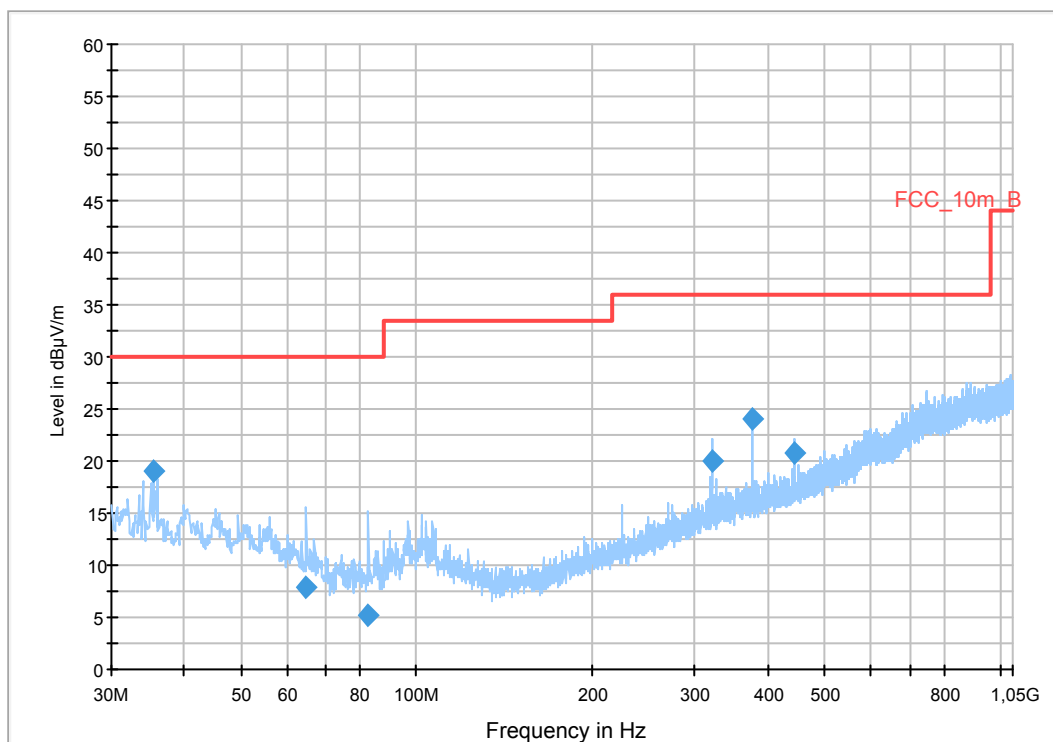

**Final Result 1**

Frequency (MHz)	QuasiPeak (dBµV/m)	Meas. Time (ms)	Bandwidth (kHz)	Height (cm)	Polarization	Azimuth (deg)	Corr. (dB)	Margin (dB)	Limit (dBµV/m)	Comment
35.400000	19.0	1000.0	120.000	98.0	V	272.0	13.1	11.0	30.0	
64.800000	8.0	1000.0	120.000	153.0	V	312.0	10.5	22.0	30.0	
82.800000	5.2	1000.0	120.000	270.0	V	125.0	9.5	24.8	30.0	
320.040000	20.1	1000.0	120.000	98.0	V	328.0	15.2	15.9	36.0	
375.000000	24.1	1000.0	120.000	98.0	V	103.0	16.5	11.9	36.0	
442.320000	20.8	1000.0	120.000	270.0	H	262.0	17.5	15.2	36.0	

Plot 2: 1 GHz to 12.75 GHz, vertical polarization

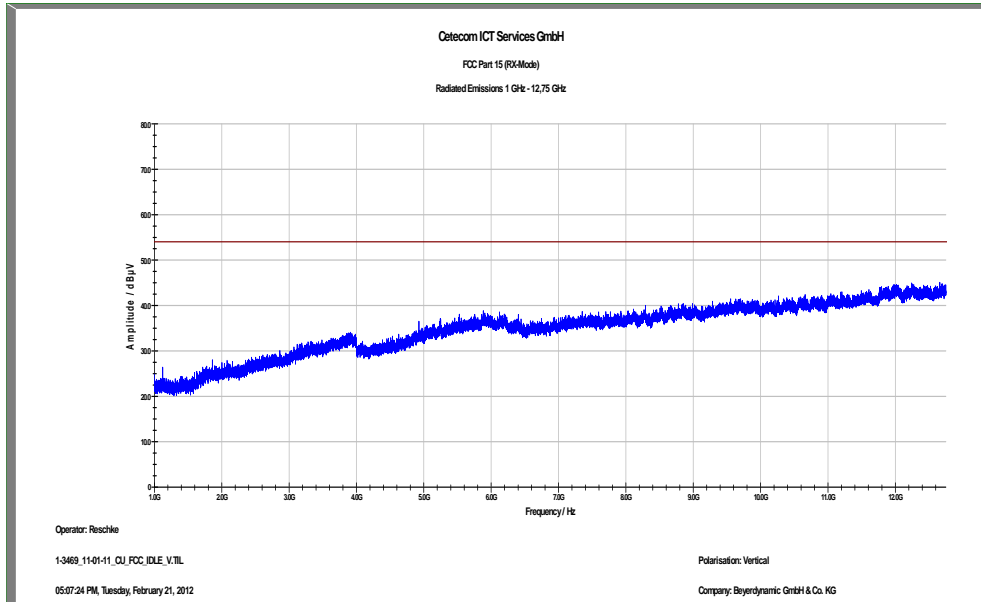

Plot 3: 1 GHz to 12.75 GHz, horizontal polarization

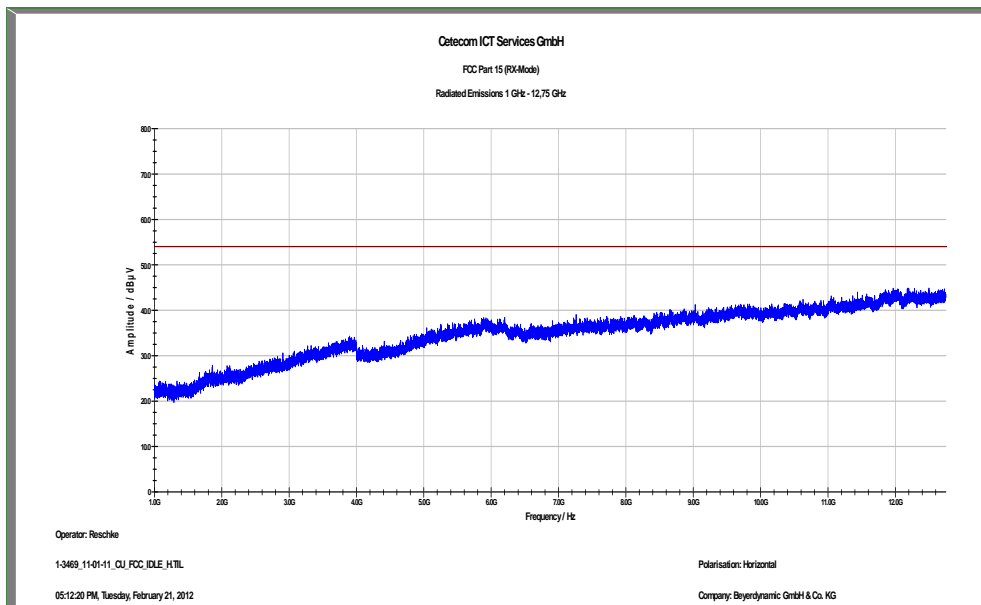

Plot 4: 12 GHz to 26 GHz, vertical & horizontal polarization

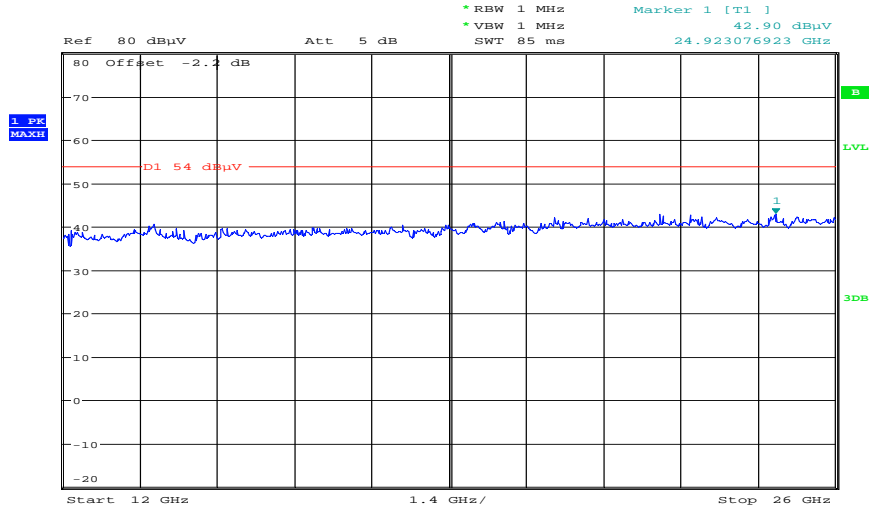

Date: 26.APR.2012 08:23:31

Plot 5: 26 GHz to 40 GHz, vertical & horizontal polarization

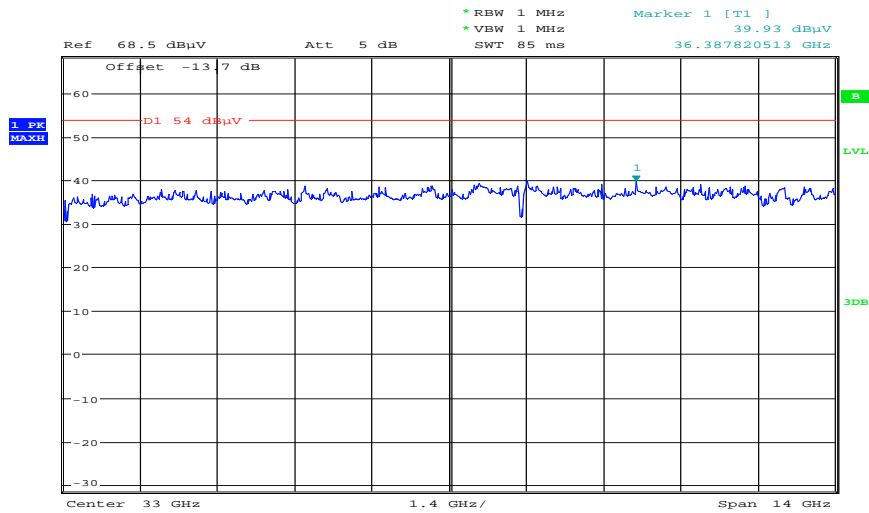

Date: 26.APR.2012 08:33:03

### 9.11 TX spurious emissions radiated < 30 MHz

**Description:**

Measurement of the radiated spurious emissions in transmit mode below 30 MHz. The EUT is set to channel 39. This measurement is representative for all channels and modes. If critical peaks are found channel 00 and channel 78 will be measured too. The limits are recalculated to a measurement distance of 3 m with 40 dB/decade according CFR Part 2.

**Measurement:**

Measurement parameter	
Detector:	Peak / Quasi Peak
Sweep time:	Auto
Video bandwidth:	F < 150 kHz: 200 Hz F > 150 kHz: 9 kHz
Resolution bandwidth:	F < 150 kHz: 1 kHz F > 150 kHz: 100 kHz
Span:	9 kHz to 30 MHz
Trace-Mode:	Max Hold

**Limits:**

TX Spurious Emissions Radiated < 30 MHz		
Frequency (MHz)	Field Strength (dBµV/m)	Measurement distance
0.009 – 0.490	2400/F(kHz)	300
0.490 – 1.705	24000/F(kHz)	30
1.705 – 30.0	30	30

**Results:**

TX Spurious Emissions Radiated < 30 MHz [dBµV/m]		
F [MHz]	Detector	Level [dBµV/m]
No critical peaks found		
Measurement uncertainty	± 3 dB	

**Result: Passed**

**Plots:**

**Plot 1:** 9 kHz to 30 MHz (Antenna A / B - valid for all channels)

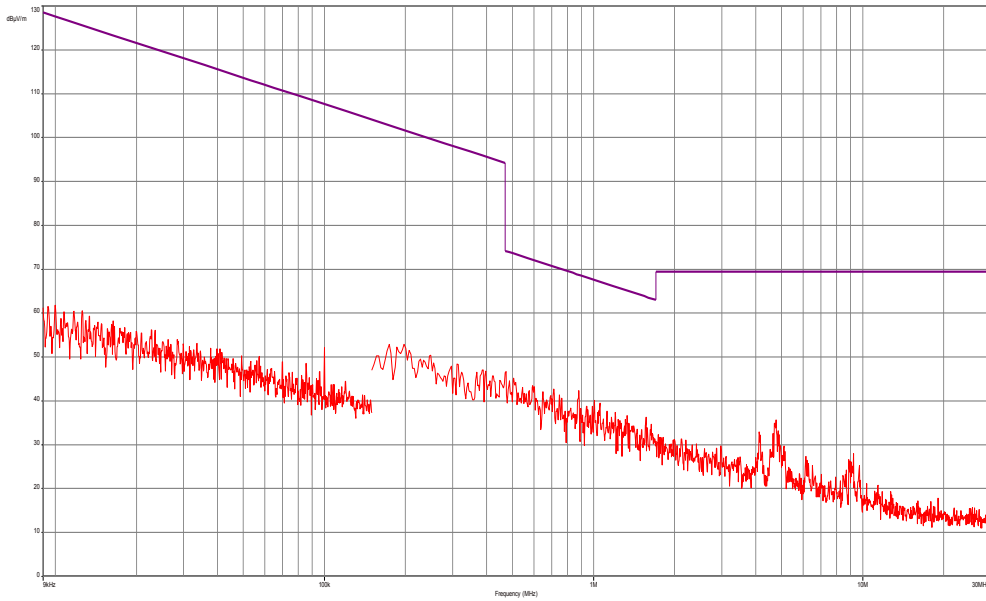

**Plot 2:** 9 kHz to 30 MHz (RX mode)

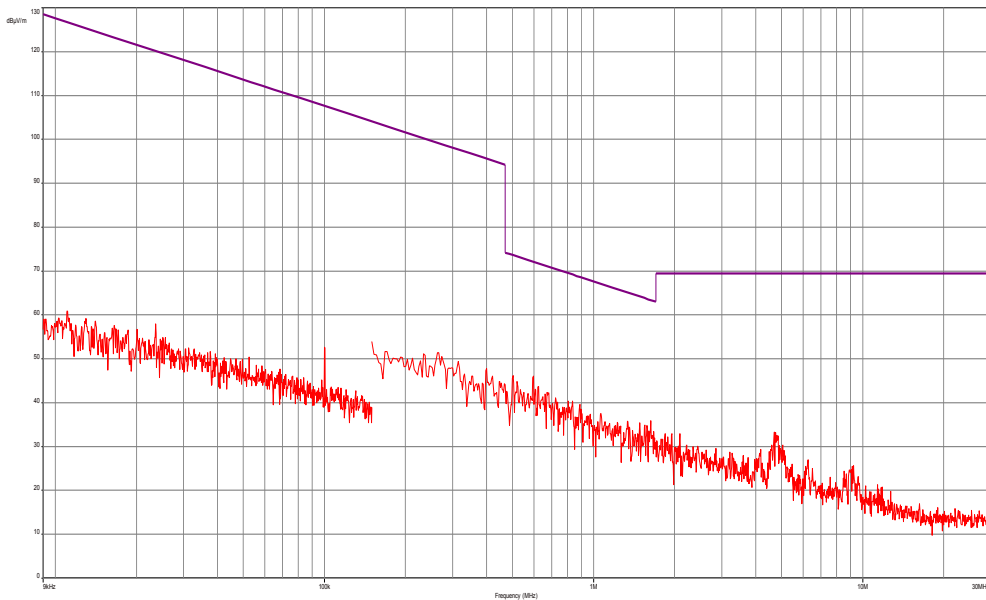

Note: Antenna A & B show the same behaviour.



## 9.12 TX spurious emissions conducted < 30 MHz

### Description:

Measurement of the conducted spurious emissions in transmit mode below 30 MHz. The EUT is set to channel 39. If critical peaks are found channel 00 and channel 78 will be measured too. Both power lines, phase and neutral line, are measured. Found peaks are remeasured with average and quasi peak detection to show compliance to the limits.

### Measurement:

Measurement parameter	
Detector:	Peak - Quasi Peak / Average
Sweep time:	Auto
Video bandwidth:	F < 150 kHz: 200 Hz F > 150 kHz: 9 kHz
Resolution bandwidth:	F < 150 kHz: 1 kHz F > 150 kHz: 100 kHz
Span:	9 kHz to 30 MHz
Trace-Mode:	Max Hold

### Limits:

TX Spurious Emissions Conducted < 30 MHz		
Frequency (MHz)	Quasi-Peak (dB $\mu$ V/m)	Average (dB $\mu$ V/m)
0.15 – 0.5	66 to 56*	56 to 46*
0.5 – 5	56	46
5 – 30.0	60	50

\*Decreases with the logarithm of the frequency

### Results:

TX Spurious Emissions Conducted < 30 MHz [dB $\mu$ V/m]		
F [MHz]	Detector	Level [dB $\mu$ V/m]
No critical peaks found		
Measurement uncertainty	± 3 dB	

**Result: Passed.**

**Plots:**

**Plot 1:** 9 kHz to 30 MHz / phase and neutral Line, TX mode

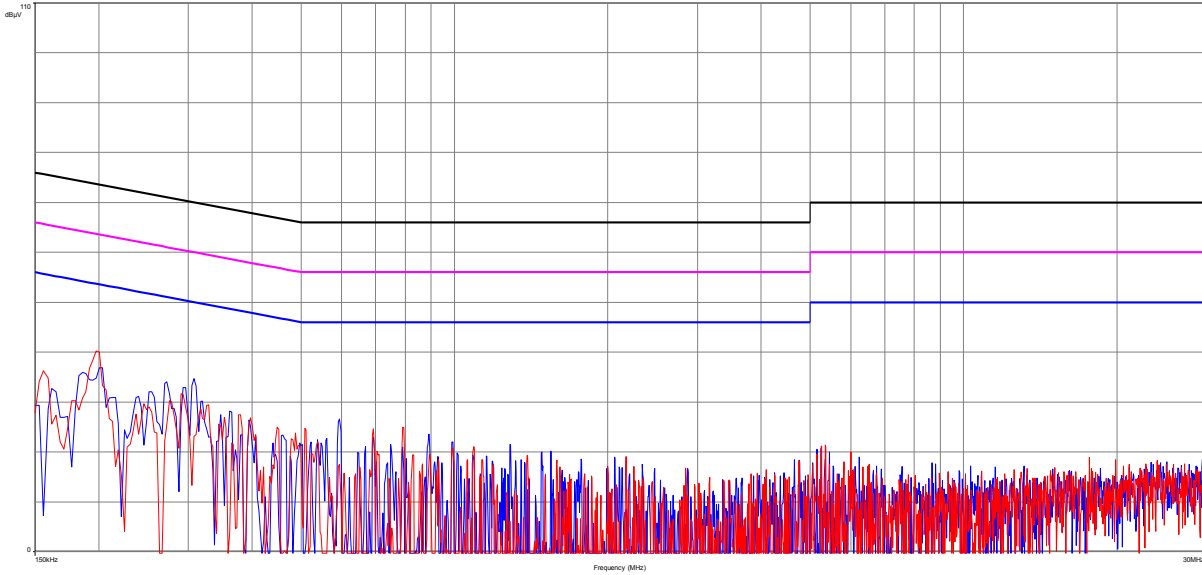

**Plot 2:** 9 kHz to 30 MHz / phase and neutral Line, RX mode

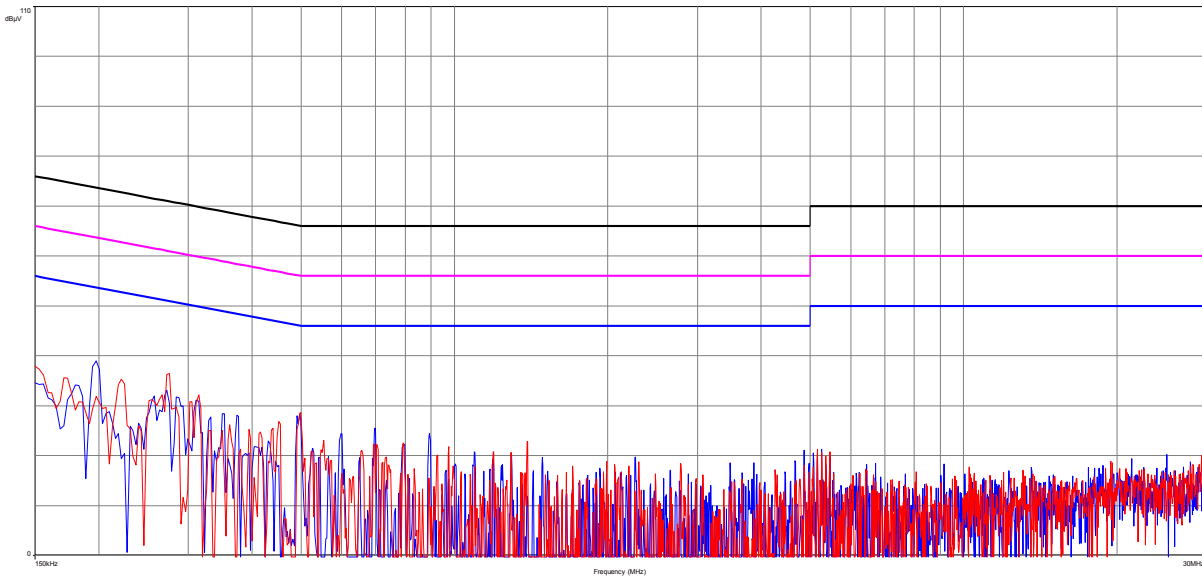

## 10 Test equipment and ancillaries used for tests

Typically, the calibrations of the test apparatus are commissioned to and performed by an accredited calibration laboratory. The calibration intervals are determined in accordance with the DIN EN ISO/IEC 17025. In addition to the external calibrations, the laboratory executes comparison measurements with other calibrated test systems or effective verifications. Weekly chamber inspections and range calibrations are performed. Where possible, rf-generating and signalling equipment as well as measuring receivers and analyzers are connected to an external high-precision 10 MHz reference (GPS-based or rubidium frequency standard).

In order to simplify the identification of the equipment used at some special tests, some items of test equipment and ancillaries can be provided with an identifier or number in the equipment list below (Labor/Item).

No.	Lab / Item	Equipment	Type	Manufact.	Serial No.	INV. No Cetecom	Kind of Calibration	Last Calibration	Next Calibration
1	45	Switch-Unit	3488A	HP Meßtechnik	2719A14505	300000368	g		
2	50	DC power supply, 60Vdc, 50A, 1200 W	6032A	HP Meßtechnik	2920A04466	300000580	ne		
3	n. a.	software	SPS_PHE 1.4f	Spitzberger & Spieß	B5981; 5D1081; B5979	300000210	ne		
4	n. a.	EMI Test Receiver	ESCI 1166.5950.03	R&S	100083	300003312	k	05.01.2011	05.01.2013
5	n. a.	Analyzer-Reference-System (Harmonics and Flicker)	ARS 16/1	SPS	A3509 07/0 0205	300003314	k	14.07.2011	14.07.2013
6	n. a.	Amplifier	JS42-00502650-28-5A	MITEQ	1084532	300003379	ev		
7	n. a.	Antenna Tower	Model 2175	ETS-LINDGREN	64762	300003745	izw		
8	n. a.	Positioning Controller	Model 2090	ETS-LINDGREN	64672	300003746	izw		
9	n. a.	Turntable Interface-Box	Model 105637	ETS-LINDGREN	44583	300003747	izw		
10	n. a.	TRILOG Broadband Test-Antenna 30 MHz - 3 GHz	VULB9163	Schwarzbeck	295	300003787	k	01.04.2010	01.04.2013
11	n. a.	Spectrum-Analyzer	FSU26	R&S	200809	300003874	k	10.01.2011	10.01.2013
12	n. a.	Isolating Transformer	RT5A	Grundig	8041	300001626	g		
13	n. a.	DC power supply, 60Vdc, 50A, 1200 W	6032A	HP Meßtechnik	2818A03450	300001040	Ve	12.01.2012	12.01.2015
14	n. a.	Coaxial Attenuator 30dB/500W	8325	Bird	1530	300001595	ev		
15	n. a.	Double-Ridged Waveguide Horn Antenna 1-18.0GHz	3115	EMCO	8812-3088	300001032	vIKI!	11.05.2011	11.05.2013
16	n. a.	Active Loop Antenna	6502	EMCO	2210	300001015	ne		
17	n. a.	Anechoic chamber	FAC 3/5m	MWB / TDK	87400/02	300000996		23.03.2009	
18	Spec.A. 2_2e	System rack for EMI measurement solution	85900	HP I.V.	*	300000222	ne		
19	9	Artificial Mains 9 kHz to 30 MHz	ESH3-Z5	R&S	828576/020	300001210	Ve	06.01.2012	06.01.2014
20	n. a.	Relais Matrix	3488A	HP Meßtechnik	2719A15013	300001156	ne		
21	n. a.	Relais Matrix	PSU	R&S	890167/024	300001168	ne		
22	n. a.	Isolating Transformer	RT5A	Grundig	9242	300001263	ne		
23	n. a.	Three-Way Power Splitter,	11850C	HP Meßtechnik		300000997	ne		

		50 Ohm							
24	n. a.	Switch / Control Unit	3488A	HP	2605e08770	300001443	ne		
25	n. a.	Amplifier	js42-00502650-28-5a	Parzich GMBH	928979	300003143	ne		
26	n. a.	Band Reject filter	WRCG1855/1910-1835/1925-40/8SS	Wainwright	7	300003350	ev		
27	n. a.	Band Reject filter	WRCG2400/2483-2375/2505-50/10SS	Wainwright	11	300003351	ev		
28	n. a.	TILE-Software Emission	Quantum Change, Modell TILE-ICS/FULL	EMCO	none	300003451	ne		
29	n. a.	Highpass Filter	WHKX2.9/18G-12SS	Wainwright	1	300003492	ev		
30	n. a.	Highpass Filter	WHK1.1/15G-10SS	Wainwright	3	300003255	ev		
31	n. a.	Highpass Filter	WHKX7.0/18G-8SS	Wainwright	18	300003789	ne		
32	n. a.	PSA Spectrum Analyzer 3 Hz - 26.5 GHz	E4440A	Agilent Technologies	MY48250080	300003812	k	08.09.2010	08.09.2012
33	n. a.	MXG Microwave Analog Signal Generator	N5183A	Agilent Technologies	MY47420220	300003813	k	13.09.2010	13.09.2012
34	n. a.	RF Filter Section 9kHz - 1GHz	N9039A	Agilent Technologies	MY48260003	300003825	vIKI!	08.09.2010	08.09.2012
35	n. a.	TRIOLOG Broadband Test-Antenna 30 MHz - 3 GHz	VULB9163	Schwarzbeck	371	300003854	vIKI!	14.10.2011	14.10.2014
36	11b	Microwave System Amplifier, 0.5-26.5 GHz	83017A	HP Meßtechnik	00419	300002268	ev	10.03.2011	
37	A026	Std. Gain Horn Antenna 12.4 to 18.0 GHz	639	Narda		300000787	ne		
38	A029	Std. Gain Horn Antenna 18.0 to 26.5 GHz	638	Narda		300002442	ne		
39	n. a.	Spectrum Analyzer 20 Hz - 50 GHz	FSU50	R&S	200012	300003443	ve	01.07.2010	01.07.2012
40	n. a.	Signal Analyzer 20Hz-26,5GHz-150 to + 30 DBM	FSiQ26	R&S	835111/0004	300002678	Ve	04.11.2010	04.11.2012

**Agenda:** Kind of Calibration

k	calibration / calibrated	EK	limited calibration
ne	not required (k, ev, izw, zw not required)	zw	cyclical maintenance (external cyclical maintenance)
ev	periodic self verification	izw	internal cyclical maintenance
Ve	long-term stability recognized	g	blocked for accredited testing
vIkI!	Attention: extended calibration interval	*	next calibration ordered / currently in progress
NK!	Attention: not calibrated		

**11 Observations**

No observations exceeding those reported with the single test cases have been made.

**Annex A Photographs of the test setup**

Photo documentation

Photo 1:

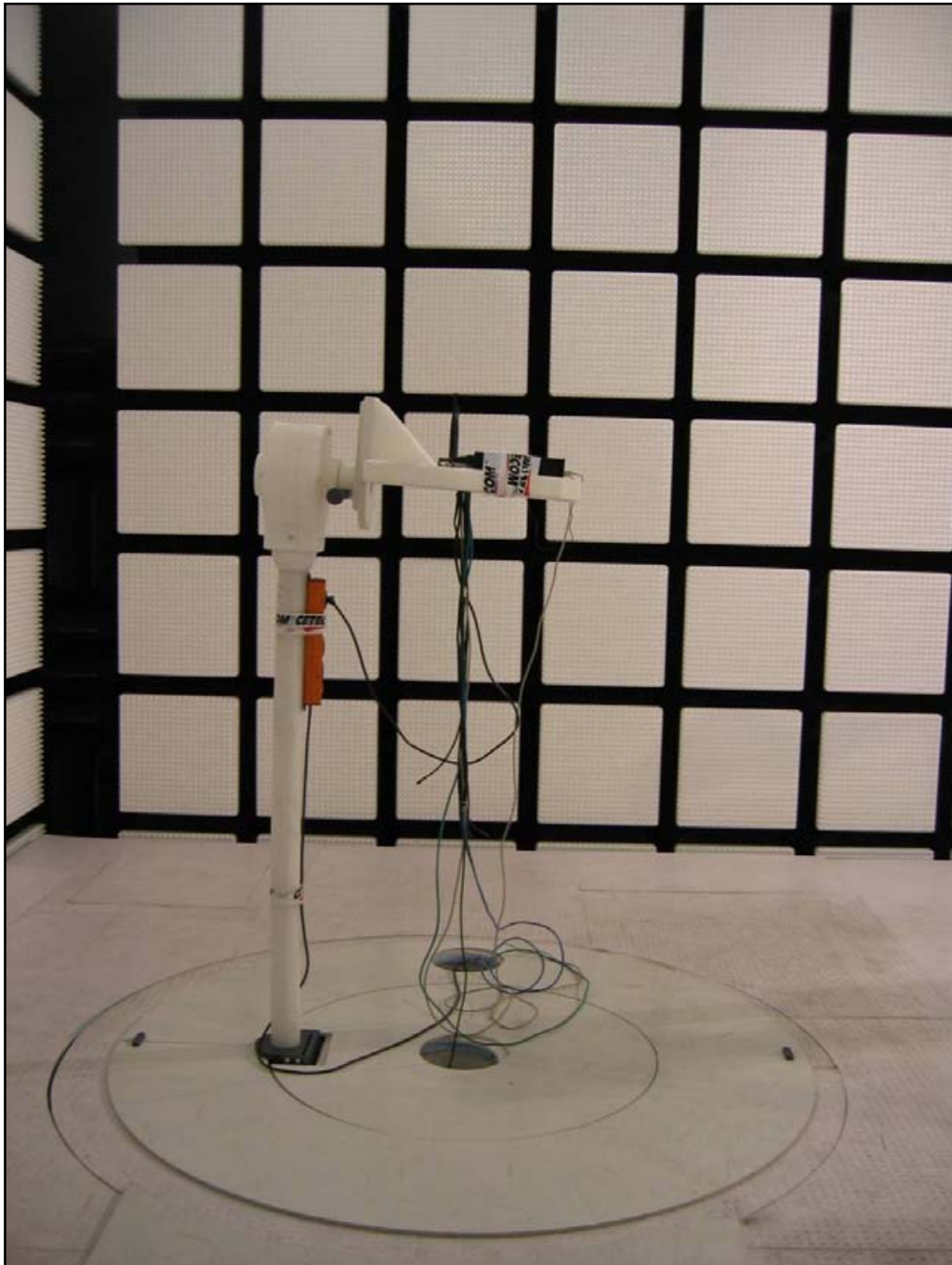

Photo 2:

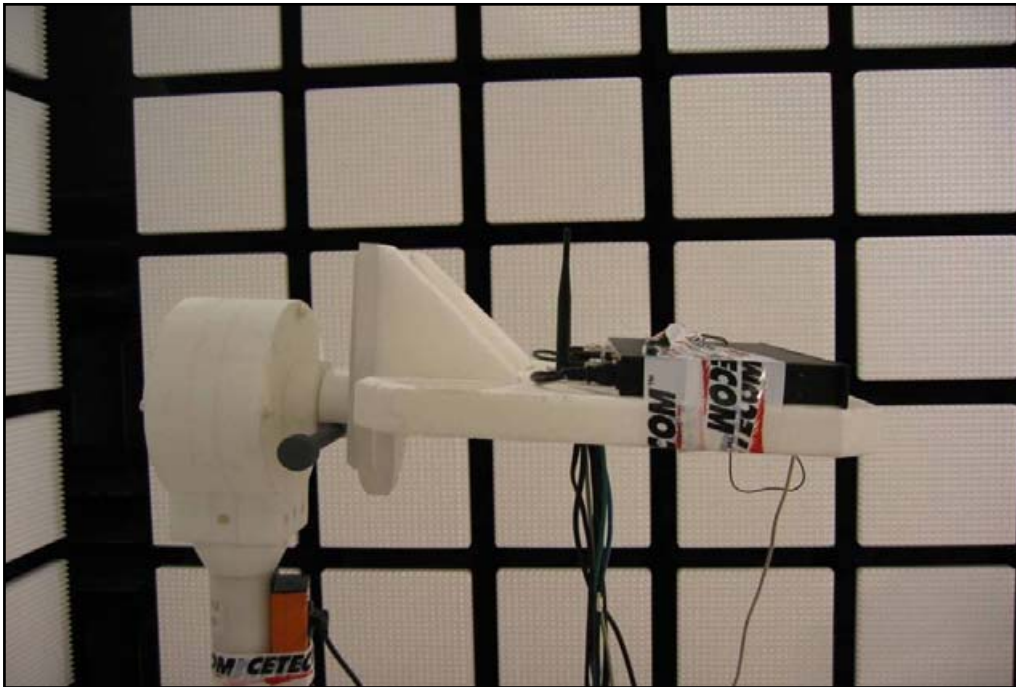

Photo 3:



Photo 4:

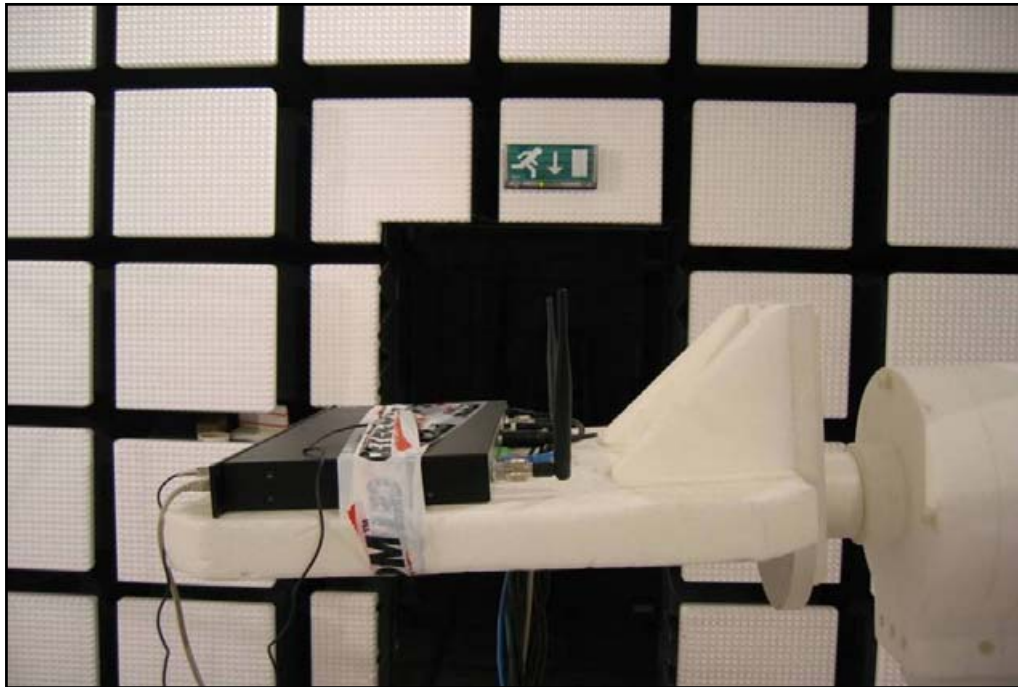

Photo 5:



Photo 6:

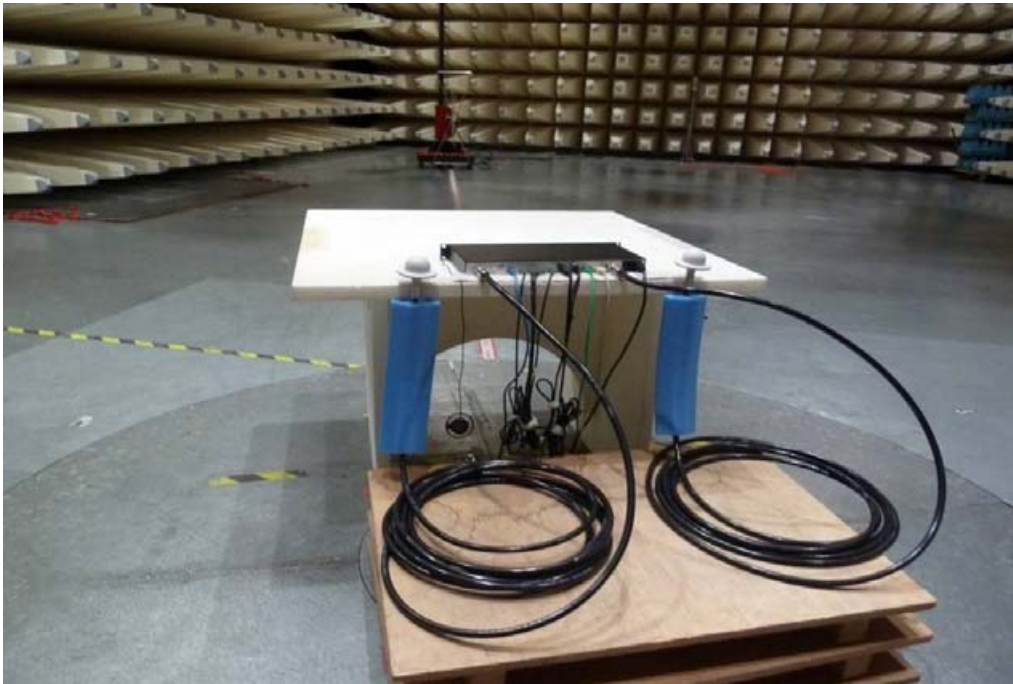

Photo 7:





Photo 8:

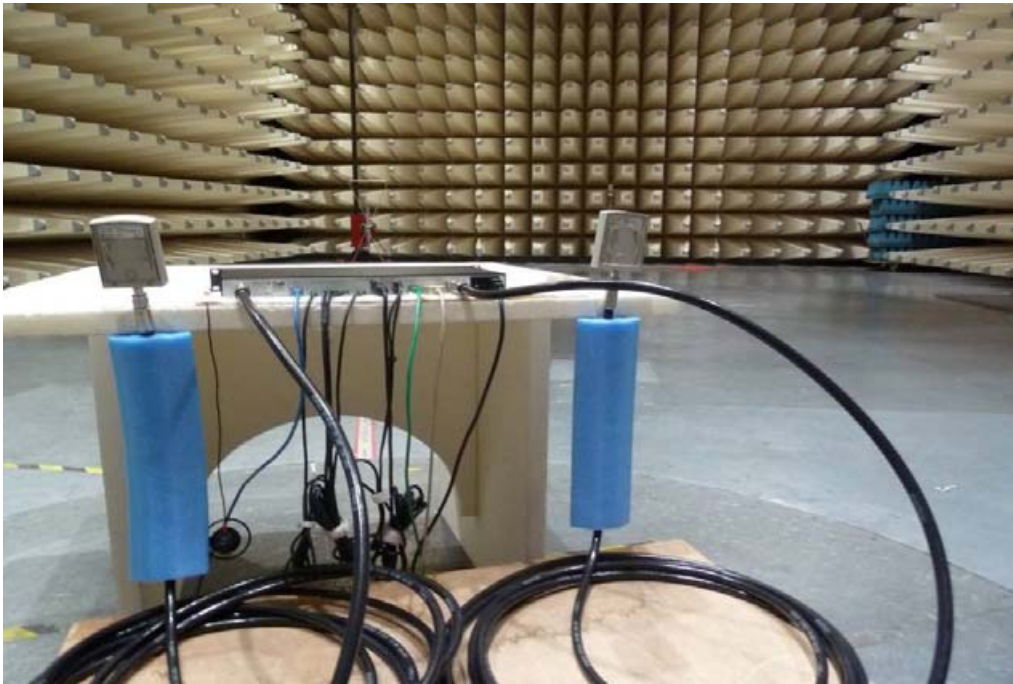
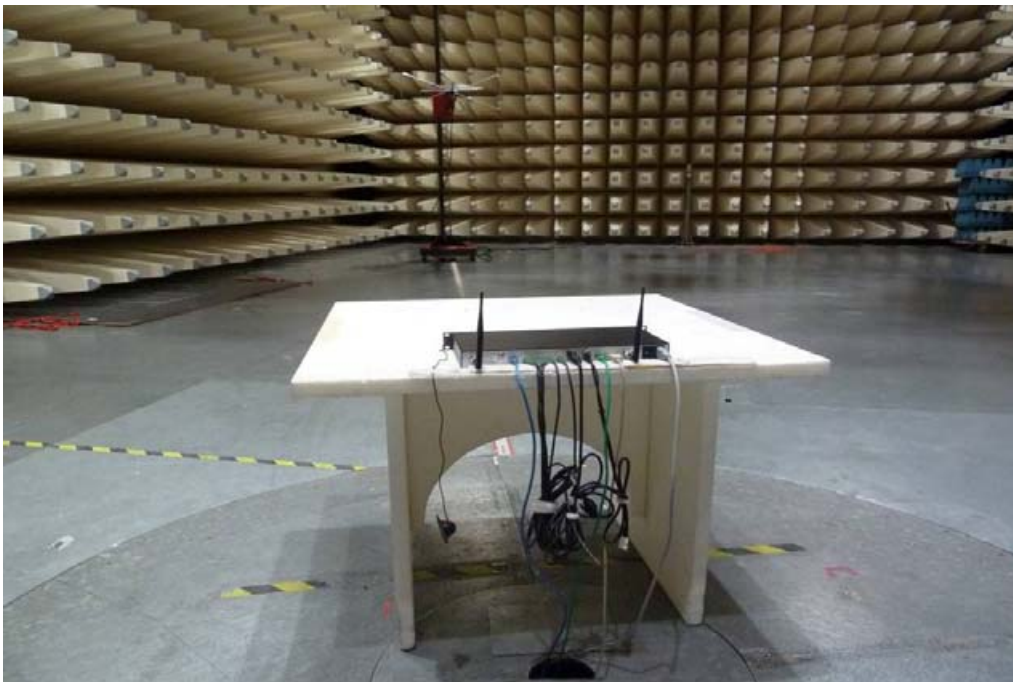

Photo 9:



**Annex B External photographs of the EUT**

Photo documentation

Photo 10:



Photo 11:



Photo 12:



Photo 13:



Photo 14:



**Annex C Internal photographs of the EUT**

Photo documentation

Photo 15:



Photo 16:

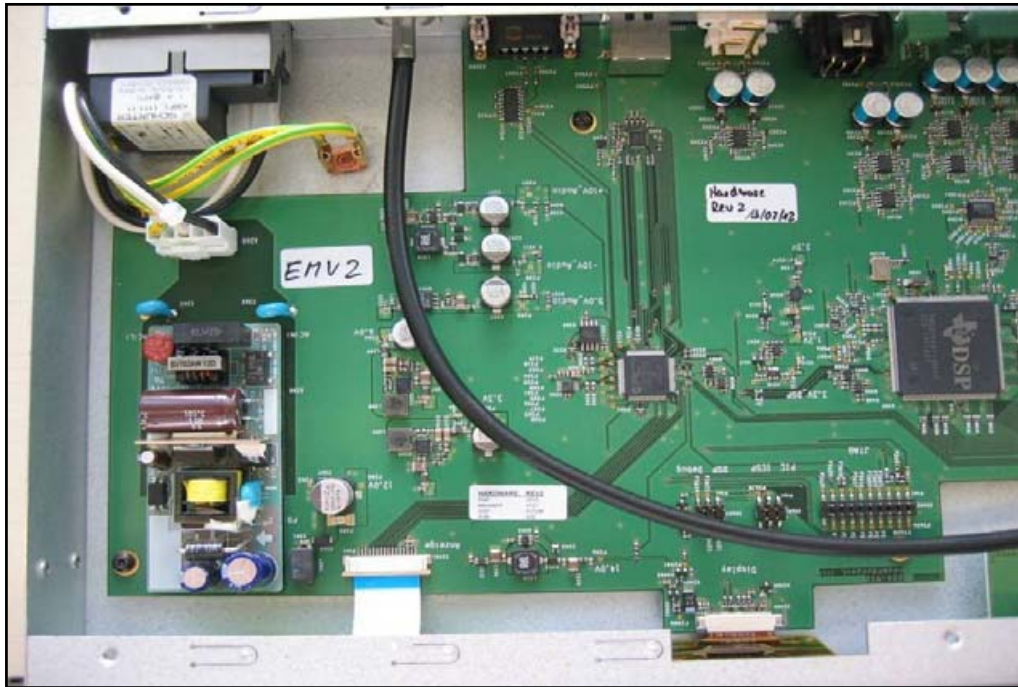

Photo 17:



Photo 18:

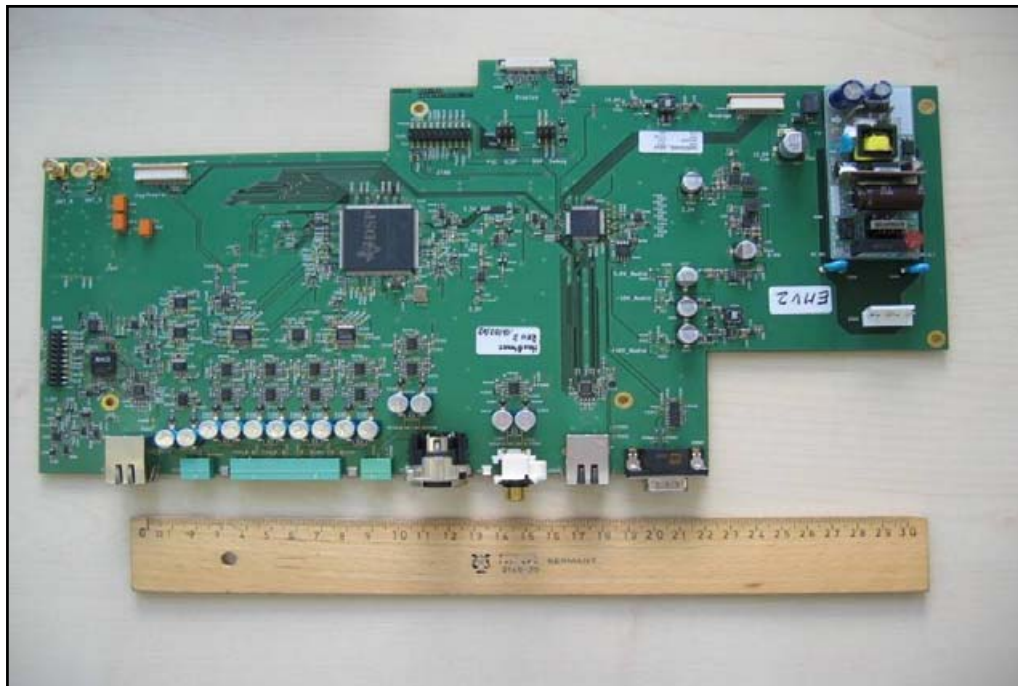

Photo 19:

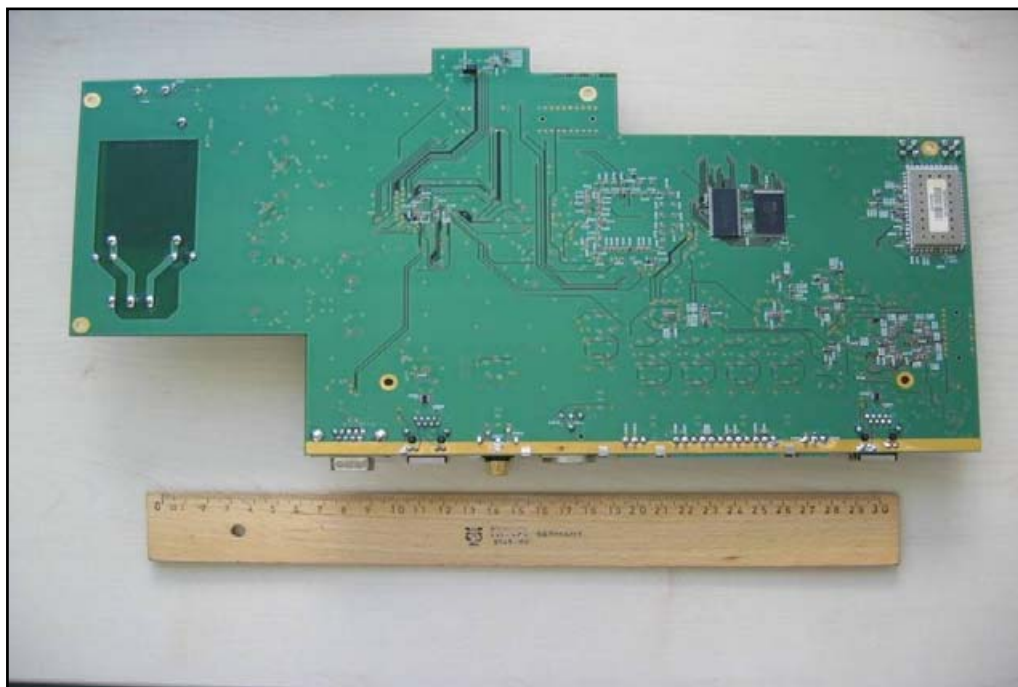

Photo 20:

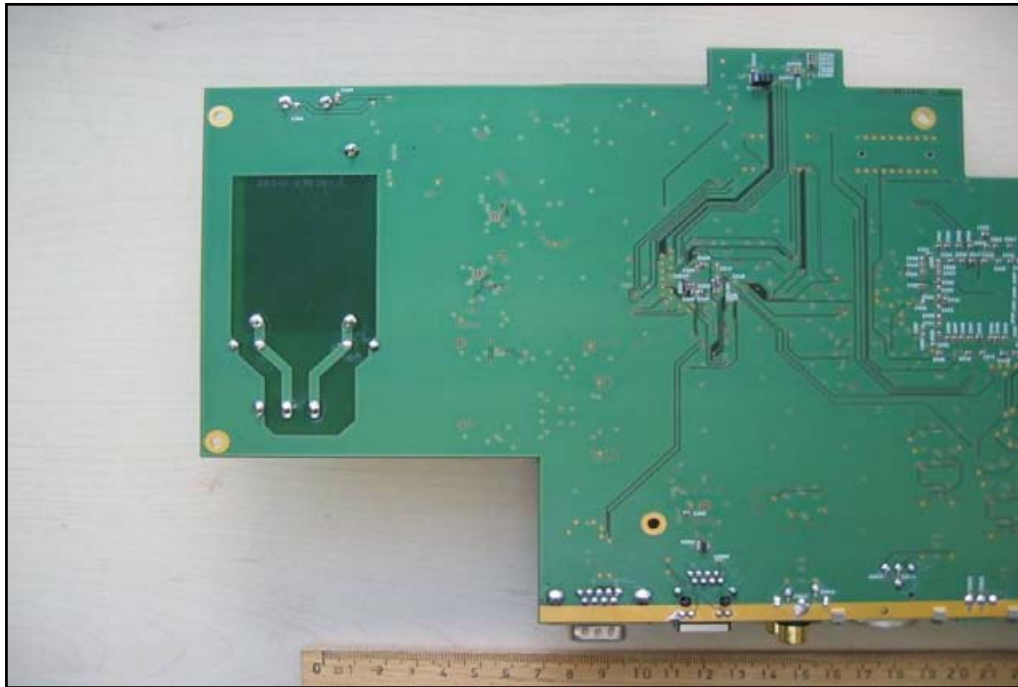

Photo 21:

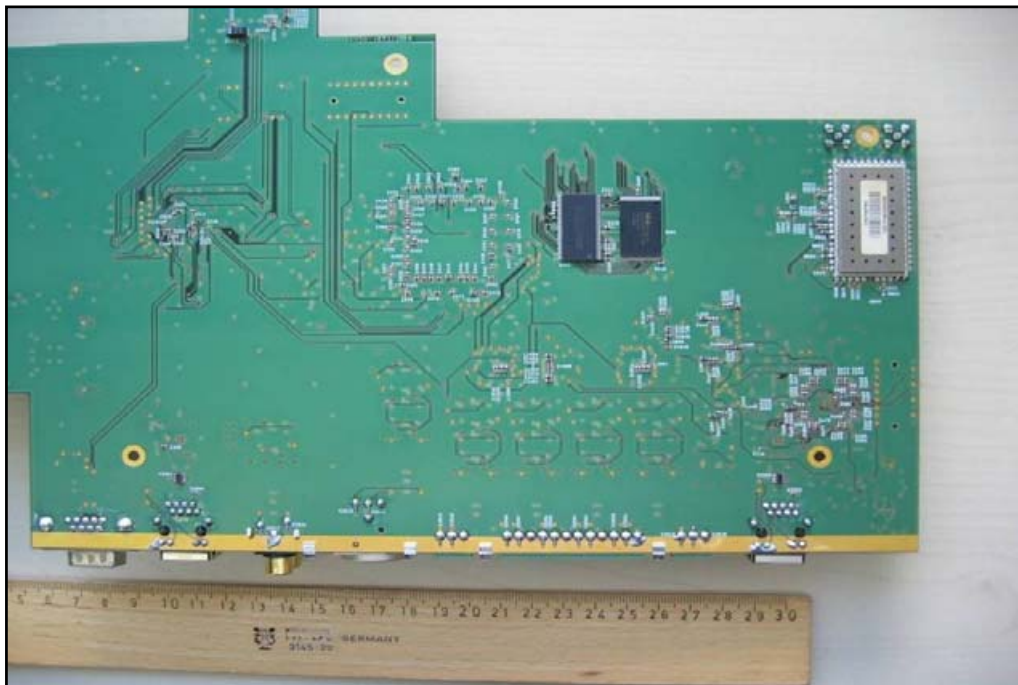



Photo 22:

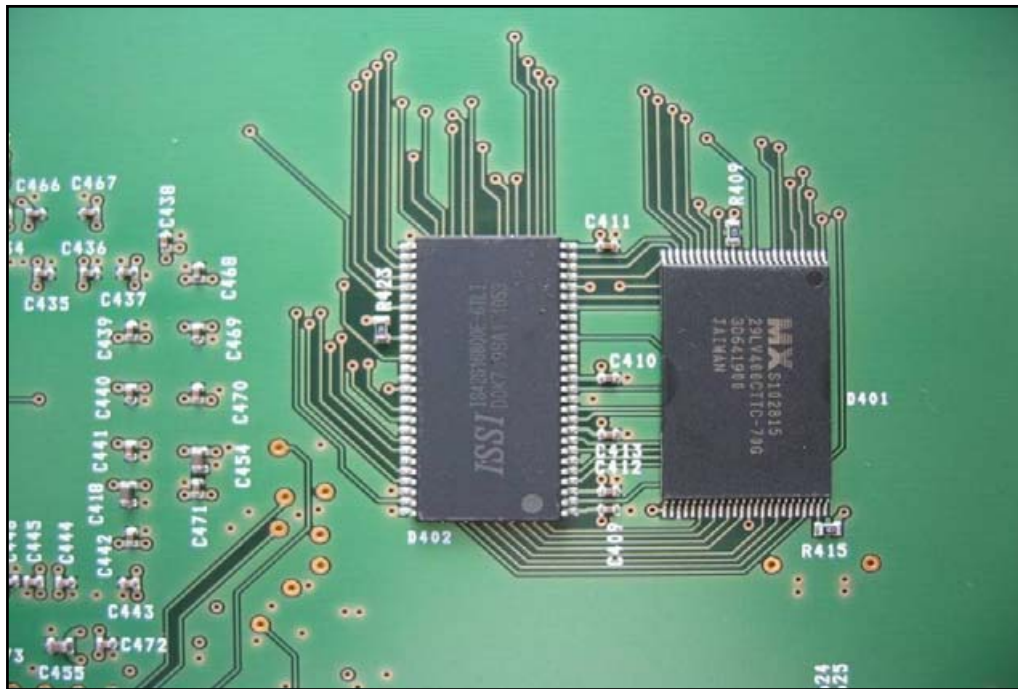

Photo 23:



Photo 24:

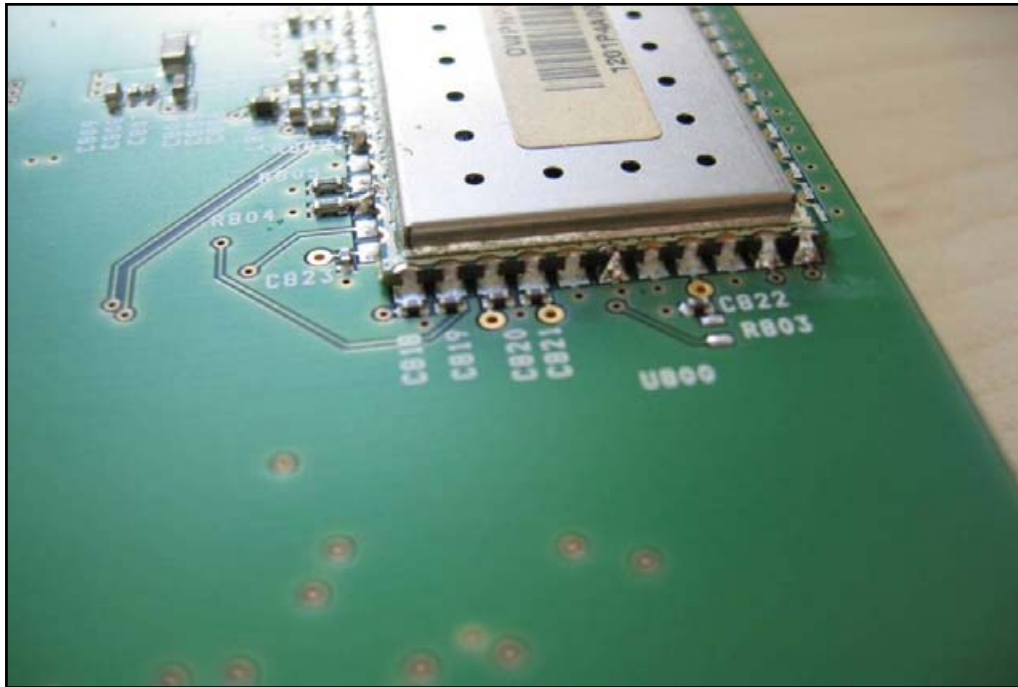

Photo 25:

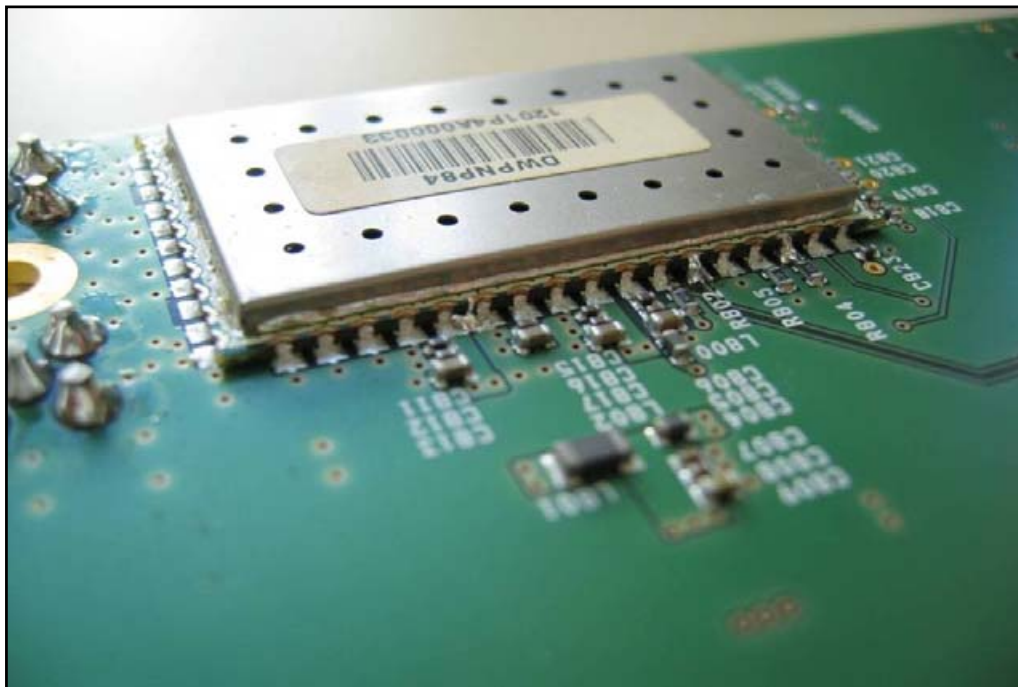

Photo 26:

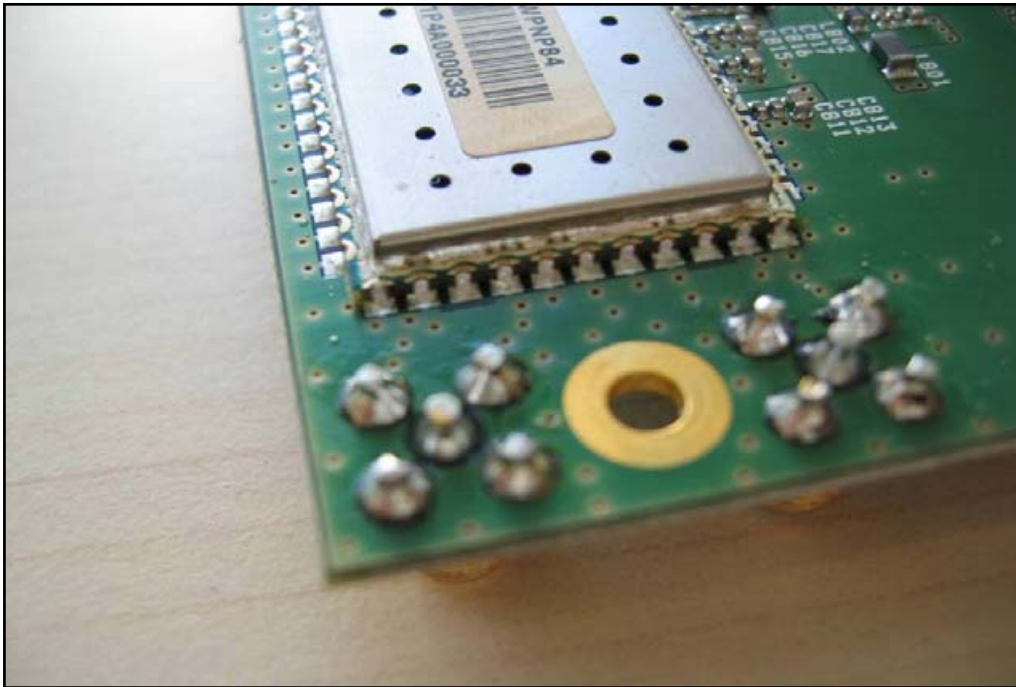

Photo 27:



**Annex D Antennas & Cable**

Photo documentation

Photo 28: Rod antenna (CA Q11)



Photo 29: Planar antenna (CA Q13)



Photo 30: Planar antenna (CA Q13)



Photo 31: Omnidirectional antenna (CA Q14)



Photo 32: Omnidirectional antenna (CA Q14)



Photo 33: 10m cable (Ecoflex 15Plus) (CA Q31)



## Annex E Safety exposure levels (MPE calculation)

### Prediction of MPE limit at a given distance:

Equation from page 18 of OET Bulletin 65, Edition 97-01

$$S = PG / 4\pi R^2$$

where: S = Power density  
 P = Power input to the antenna  
 G = Antenna gain  
 R = Distance to the center of radiation of the antenna

The table below is excerpted from Table 1B of 47 CFR 1.1310 titled "Limits for Maximum Permissible Exposure (MPE), Limits for General Population/Uncontrolled Exposure"

Frequency Range (MHz)	Power Density (mW/cm <sup>2</sup> )	Averaging Time (minutes)
300 -1500	f/1500	30
1500 - 100000	1.0	30

where f = Frequency (MHz)

### **Prediction: (with Rod antenna A)**

P Max power input to the antenna: 10.44 dBm  
 P Max power input to the antenna: 11.07 mW  
 R Distance: 20 cm  
 G Maximum antenna gain: 4.98 dBi  
 G Maximum antenna gain: 3.15 numeric  
 S MPE limit for uncontrolled exposure: 1 mW/cm<sup>2</sup>

Calculated Power density: **0.007 mW/cm<sup>2</sup>**  
**0.069 W/m<sup>2</sup>**

### **Prediction: (with Rod antenna B)**

P Max power input to the antenna: 10.03 dBm  
 P Max power input to the antenna: 10.07 mW  
 R Distance: 20 cm  
 G Maximum antenna gain: 4.62 dBi  
 G Maximum antenna gain: 2.90 numeric  
 S MPE limit for uncontrolled exposure: 1 mW/cm<sup>2</sup>

Calculated Power density: **0.006 mW/cm<sup>2</sup>**  
**0.058 W/m<sup>2</sup>**



**Prediction: (with Planar antenna A)**

P	Max power input to the antenna:	10.44 dBm
P	Max power input to the antenna:	11.07 mW
R	Distance:	20 cm
G	Maximum antenna gain:	6.73 dBi
G	Maximum antenna gain:	4.71 numeric
S	MPE limit for uncontrolled exposure:	1 mW/cm <sup>2</sup>

Calculated Power density: **0.010 mW/cm<sup>2</sup>**  
**0.104 W/m<sup>2</sup>**

**Prediction: (with Planar antenna B)**

P	Max power input to the antenna:	10.03 dBm
P	Max power input to the antenna:	10.07 mW
R	Distance:	20 cm
G	Maximum antenna gain:	6.79 dBi
G	Maximum antenna gain:	4.77 numeric
S	MPE limit for uncontrolled exposure:	1 mW/cm <sup>2</sup>

Calculated Power density: **0.010 mW/cm<sup>2</sup>**  
**0.096 W/m<sup>2</sup>**

**Prediction: (with Omnidirectional antenna A)**

P	Max power input to the antenna:	10.44 dBm
P	Max power input to the antenna:	11.07 mW
R	Distance:	20 cm
G	Maximum antenna gain:	-4.94 dBi
G	Maximum antenna gain:	0.32 numeric
S	MPE limit for uncontrolled exposure:	1 mW/cm <sup>2</sup>

Calculated Power density: **0.001 mW/cm<sup>2</sup>**  
**0.007 W/m<sup>2</sup>**

**Prediction: (with Omnidirectional antenna B)**

P	Max power input to the antenna:	10.03 dBm
P	Max power input to the antenna:	10.07 mW
R	Distance:	20 cm
G	Maximum antenna gain:	-4.33 dBi
G	Maximum antenna gain:	0.37 numeric
S	MPE limit for uncontrolled exposure:	1 mW/cm <sup>2</sup>

Calculated Power density: **0.001 mW/cm<sup>2</sup>**  
**0.007 W/m<sup>2</sup>**

**This prediction demonstrates the following:**

The power density levels at a distance of 20 cm are below the maximum levels allowed by FCC regulations

## Annex F Document history

Version	Applied changes	Date of release
1.0	Initial release	2012-04-30
-A	Typo corrected	2012-08-16
-B	Model name changed from Quinta to Quinta CU	2012-09-11
-C	Additional information & type corrected	2012-11-06
-C	MPE-calculation added	2012-11-12

## Annex G Further information

### Glossary

AVG	-	Average
DUT	-	Device under test
EMC	-	Electromagnetic Compatibility
EN	-	European Standard
EUT	-	Equipment under test
ETSI	-	European Telecommunications Standard Institute
FCC	-	Federal Communication Commission
FCC ID	-	Company Identifier at FCC
HW	-	Hardware
IC	-	Industry Canada
Inv. No.	-	Inventory number
N/A	-	Not applicable
PP	-	Positive peak
QP	-	Quasi peak
S/N	-	Serial number
SW	-	Software

**Annex H Accreditation Certificate**



Front side of certificate



Back side of certificate

**Note:**

The current certificate including annex is published on our website (see link below) or may be received from CETECOM ICT Services on request.

[http://www.cetecom.com/fileadmin/de/CETECOM\\_D\\_Saarbruecken/accreditations\\_Jan\\_2010/DAKKS\\_Akkredi\\_Urk\\_EN17025-En\\_incl\\_Annex.pdf](http://www.cetecom.com/fileadmin/de/CETECOM_D_Saarbruecken/accreditations_Jan_2010/DAKKS_Akkredi_Urk_EN17025-En_incl_Annex.pdf)