

TEST REPORT

Test report no.: 1-3469/11-01-15-B



Testing laboratory

CETECOM ICT Services GmbH
 Untertuerkheimer Strasse 6 – 10
 66117 Saarbruecken / Germany
 Phone: + 49 681 5 98 - 0
 Fax: + 49 681 5 98 - 9075
 Internet: <http://www.cetecom.com>
 e-mail: ict@cetecom.com

Accredited Testing Laboratory:

The testing laboratory (area of testing) is accredited according to DIN EN ISO/IEC 17025 (2005) by the Deutsche Akkreditierungsstelle GmbH (DAkkS). The accreditation is valid for the scope of testing procedures as stated in the accreditation certificate with the registration number: D-PL-12076-01-01. Area of Testing: Radio/Satellite Communications

Applicant

beyerdynamic GmbH & Co. KG
 Theresienstraße 8
 74072 Heilbronn / GERMANY
 Phone: +49 7131 617-0
 Fax: +49 7131 617-215
 Contact: Ulrich Roth
 e-mail: roth@beyerdynamic.de
 Phone: +49 7131 617-155

Manufacturer

beyerdynamic GmbH & Co. KG
 Theresienstraße 8
 74072 Heilbronn / GERMANY

Test standard/s

47 CFR Part 15 Title 47 of the Code of Federal Regulations; Chapter I
 Part 15 - Radio frequency devices

RSS - 210 Issue 8 Spectrum Management and Telecommunications - Radio Standards Specification
 Low-power Licence-exempt Radiocommunication Devices (All Frequency Bands):
 Category I Equipment

For further applied test standards please refer to section 3 of this test report.

Test Item

Kind of test item: Wireless Conference System
Model name: Quinta CU
FCC ID: OSDQUINTACU
IC: 3628A-QUINTACU
Frequency: ISM band 5725 MHz to 5850 MHz
 5736 MHz, 5762 MHz, 5814 MHz
Technology tested: Proprietary DSSS
Antenna: Two external N-connectors / Dedicated antennas
 (Rod antenna, Planar antenna, Omnidirectional antenna)
Power Supply: 110 V AC by AC / DC power supply
Temperature Range: +10°C to +50 °C



This test report is electronically signed and valid without handwriting signature. For verification of the electronic signatures, the public keys can be requested at the testing laboratory.

Test report authorised:



Stefan BöS
 Senior Testing Manager

Test performed:



p. o.
 Jakob Reschke
 Project Manager

1 Table of contents

1	Table of contents	2
2	General information	3
2.1	Notes and disclaimer	3
2.2	Application details.....	3
3	Test standard/s	3
4	Test environment.....	4
5	Test item.....	4
6	Test laboratories sub-contracted	4
7	Summary of measurement results	5
8	RF measurements	6
8.1	Description of test setup	6
8.1.1	Radiated measurements.....	6
8.1.2	Conducted measurements.....	7
8.2	Additional comments	7
8.3	RSP100 test report cover sheet / performance test data	8
9	Measurement results.....	9
9.1	Antenna gain.....	9
9.2	Maximum output power	15
9.3	Power spectral density	19
9.4	Spectrum bandwidth – 6 dB bandwidth	24
9.5	Spectrum bandwidth – 20 dB bandwidth	29
9.6	TX spurious emissions conducted.....	34
9.7	TX spurious emissions radiated	48
9.8	RX spurious emissions radiated.....	111
9.9	TX spurious emissions radiated < 30 MHz	115
9.10	TX spurious emissions conducted < 30 MHz.....	118
10	Test equipment and ancillaries used for tests.....	120
11	Observations	121
Annex A	Photographs of the test setup.....	122
Annex B	External photographs of the EUT.....	127
Annex C	Internal photographs of the EUT	130
Annex D	Antennas & Cable	137
Annex E	Document history	141
Annex F	Further information.....	141
Annex G	Accreditation Certificate	142

2 General information

2.1 Notes and disclaimer

The test results of this test report relate exclusively to the test item specified in this test report. CETECOM ICT Services GmbH does not assume responsibility for any conclusions and generalizations drawn from the test results with regard to other specimens or samples of the type of the equipment represented by the test item.

The test report may only be reproduced or published in full. Reproduction or publication of extracts from the report requires the prior written approval of CETECOM ICT Services GmbH.

The testing service provided by CETECOM ICT Services GmbH has been rendered under the current "General Terms and Conditions for CETECOM ICT Services GmbH".

CETECOM ICT Services GmbH will not be liable for any loss or damage resulting from false, inaccurate, inappropriate or incomplete product information provided by the customer.

Under no circumstances does the CETECOM ICT Services GmbH test report include any endorsement or warranty regarding the functionality, quality or performance of any other product or service provided.

Under no circumstances does the CETECOM ICT Services GmbH test report include or imply any product or service warranties from CETECOM ICT Services GmbH, including, without limitation, any implied warranties of merchantability, fitness for purpose, or non-infringement, all of which are expressly disclaimed by CETECOM ICT Services GmbH.

All rights and remedies regarding vendor's products and services for which CETECOM ICT Services GmbH has prepared this test report shall be provided by the party offering such products or services and not by CETECOM ICT Services GmbH.

In no case this test report can be considered as a Letter of Approval.

This test report is electronically signed and valid without handwritten signature. For verification of the electronic signatures, the public keys can be requested at the testing laboratory.

2.2 Application details

Date of receipt of order:	2011-10-12
Date of receipt of test item:	2012-02-21
Start of test:	2012-02-21
End of test:	2012-09-20
Person(s) present during the test:	-/-

3 Test standard/s

Test standard	Date	Test standard description
47 CFR Part 15	2010-10	Title 47 of the Code of Federal Regulations; Chapter I Part 15 - Radio frequency devices
RSS - 210 Issue 8	2010-12	Spectrum Management and Telecommunications - Radio Standards Specification Low-power Licence-exempt Radiocommunication Devices (All Frequency Bands): Category I Equipment

4 Test environment

Temperature:	T_{nom}	+22 °C during room temperature tests
	T_{max}	+50 °C during high temperature tests
	T_{min}	+10 °C during low temperature tests
Relative humidity content:		43 %
Barometric pressure:		not relevant for this kind of testing
Power supply:	V_{nom}	110 V AC by AC / DC power supply
	V_{max}	121 V
	V_{min}	99 V

5 Test item

Kind of test item	:	Wireless Conference System
Type identification	:	Quinta CU
S/N serial number	:	00102
HW hardware status	:	Rev. 2
SW software status	:	PNP: V015 MAINAPP: V121
Frequency band [MHz]	:	ISM band 5725 MHz to 5850 MHz 5736 MHz; 5762 MHz, 5814 MHz
Type of radio transmission	:	Proprietary DSSS
Use of frequency spectrum	:	
Type of modulation	:	BPSK, QPSK (DSSS)
Number of channels	:	3 (test software)
Antenna	:	Two external N-connectors / Dedicated antennas (Rod antenna, Planar antenna, Omni directional antenna)
Power supply	:	110 V AC by AC / DC power supply
Temperature range	:	+10°C to +50 °C

6 Test laboratories sub-contracted

None

7 Summary of measurement results

- No deviations from the technical specifications were ascertained
- There were deviations from the technical specifications ascertained

TC Identifier	Description	Verdict	Date	Remark
RF-Testing	CFR Part 15 RSS 210, Issue 8, Annex 8	Passed	2012-11-06	-/-

Test specification clause	Test case	Temperature conditions	Power source voltages	Mode	Pass	Fail	NA	NP	Remark
§15.247(b)(4) RSS 210 / A8.4(2)	Antenna gain	Nominal	Nominal	DSSS	<input checked="" type="checkbox"/>	<input type="checkbox"/>	<input type="checkbox"/>	<input type="checkbox"/>	complies
§15.247(e) RSS 210 / A8.2(b)	Power spectral density	Nominal	Nominal	DSSS	<input checked="" type="checkbox"/>	<input type="checkbox"/>	<input type="checkbox"/>	<input type="checkbox"/>	complies
§15.247 RSS 210 / A8.2(a)	Spectrum bandwidth (6dB bandwidth)	Nominal	Nominal	DSSS	<input checked="" type="checkbox"/>	<input type="checkbox"/>	<input type="checkbox"/>	<input type="checkbox"/>	complies
§15.247 RSS 210 / A8.2(a)	Spectrum bandwidth (20dB bandwidth)	Nominal	Nominal	DSSS	<input checked="" type="checkbox"/>	<input type="checkbox"/>	<input type="checkbox"/>	<input type="checkbox"/>	complies
§15.247(b)(3) RSS-210 / A8.4(4)	Maximum output power	Nominal	Nominal	DSSS	<input checked="" type="checkbox"/>	<input type="checkbox"/>	<input type="checkbox"/>	<input type="checkbox"/>	complies
§15.247(d) RSS-210 / A8.5	TX spurious emissions conducted	Nominal	Nominal	DSSS	<input checked="" type="checkbox"/>	<input type="checkbox"/>	<input type="checkbox"/>	<input type="checkbox"/>	complies
§15.247(d) RSS-210 / A8.5	TX spurious emissions radiated	Nominal	Nominal	DSSS	<input checked="" type="checkbox"/>	<input type="checkbox"/>	<input type="checkbox"/>	<input type="checkbox"/>	complies
§15.109 RSS-Gen.	RX spurious emissions radiated	Nominal	Nominal	-/-	<input checked="" type="checkbox"/>	<input type="checkbox"/>	<input type="checkbox"/>	<input type="checkbox"/>	complies
§15.209(a) RSS-Gen	TX spurious emissions radiated < 30 MHz	Nominal	Nominal	DSSS	<input checked="" type="checkbox"/>	<input type="checkbox"/>	<input type="checkbox"/>	<input type="checkbox"/>	complies
§15.107(a)	Conducted emissions < 30 MHz	Nominal	Nominal	DSSS	<input checked="" type="checkbox"/>	<input type="checkbox"/>	<input type="checkbox"/>	<input type="checkbox"/>	complies

Note: NA = Not Applicable; NP = Not Performed

8 RF measurements

8.1 Description of test setup

8.1.1 Radiated measurements

The radiated measurements are performed in vertical and horizontal plane in the frequency range from 9 kHz to 25 GHz in semi-anechoic chambers. The EUT is positioned on a non-conductive support with a height of 0.80 m above a conductive ground plane that covers the whole chamber. The receiving antennas are confirmed with specifications ANSI C63.2-1996 clause 15 and ANSI C63.4-2009 clause 4.1.5. These antennas can be moved over the height range between 1.0 m and 4.0 m in order to search for maximum field strength emitted from EUT. The measurement distances between EUT and receiving antennas are indicated in the test setups for the various frequency ranges. For each measurement, the EUT is rotated in all three axes until the maximum field strength is received. The wanted and unwanted emissions are received by spectrum analysers where the detector modes and resolution bandwidths over various frequency ranges are set according to requirement ANSI C63-4-2009 clause 4.2.

Antennas are confirmed with ANSI C63.2-1996 item 15.

Semi anechoic chamber

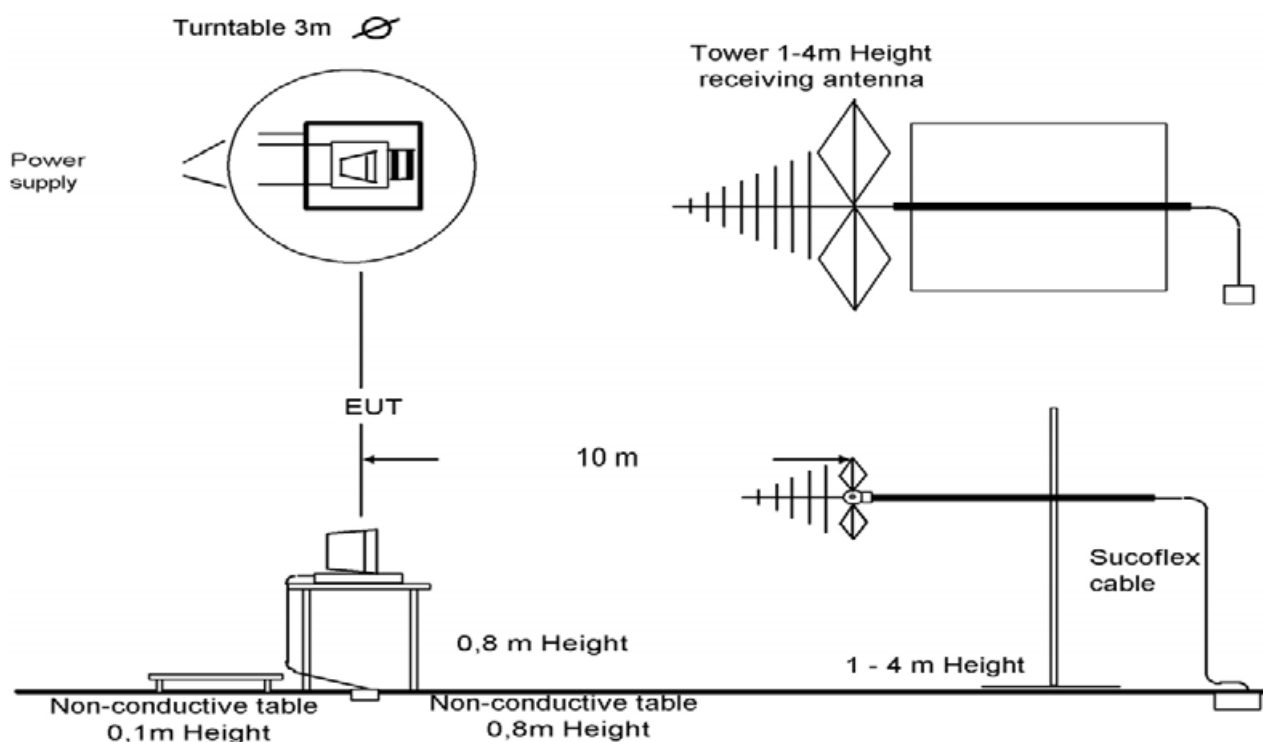

Picture 1: Diagram radiated measurements

9 kHz - 30 MHz:	active loop antenna
30 MHz – 1 GHz:	tri-log antenna
> 1 GHz:	horn antenna

The EUT is powered by an external power supply with nominal voltage. The signalling is performed from outside the chamber with a signalling unit (CMU200 or other) by air link using signalling antenna.

8.1.2 Conducted measurements

The EUT's RF signal is coupled out by the antenna connector which is supplied by the manufacturer. The signal is first 10dB attenuated before it is power divided (~6dB loss per branch). One of the signal paths is connected to the communication base Station (CMU200 or other), the other one is connected to the spectrum analyzer. The specific losses for both signal paths are first checked within a calibration. The measurement readings on the signalling unit/spectrum analyzer are corrected by the specific test set-up loss. The attenuator, power divider, signalling unit and the spectrum analyzer are impedance matched on 50 Ohm.

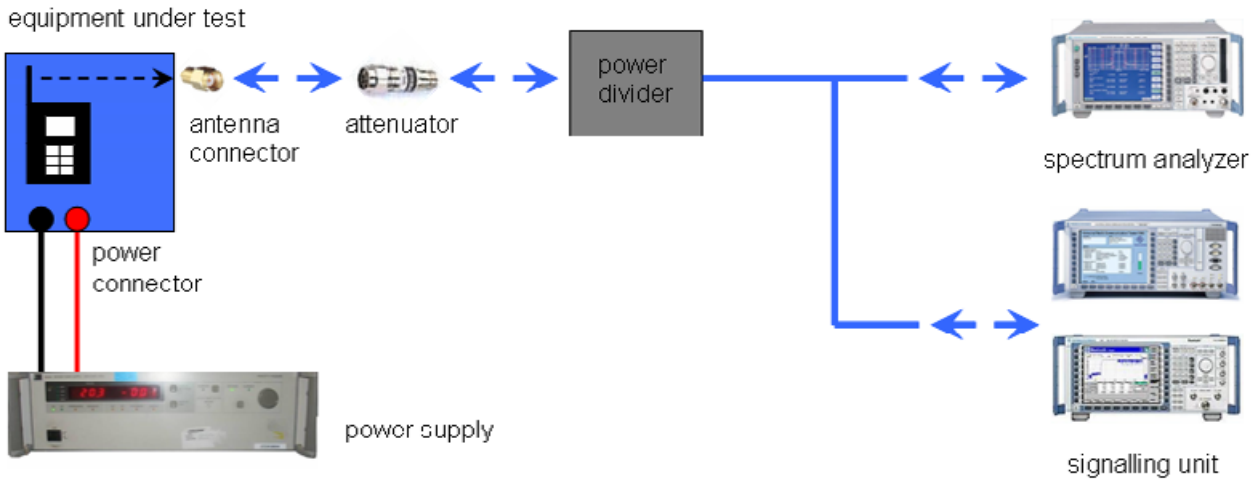

Picture 2: Diagram conducted measurements

8.2 Additional comments

Reference documents: None

Special test descriptions: None

Configuration descriptions: EUT has three different antenna types. All radiated measurements were performed with all three antenna types. The polar antenna and the omnidirectional antenna were conducted using 10m cable. This assured the maximum radiated output power. The output power settings of the EUT are always the same: 850/3E

Test mode: No test mode available.
 Special software is used.
 EUT is transmitting pseudo random data by itself

8.3 RSP100 test report cover sheet / performance test data

Test report number	:	1-3469/11-01-15-B
Equipment model number	:	Quinta CU
Certification number	:	3628A-QUINTACU
Manufacturer (complete address)	:	beyerdynamic GmbH & Co. KG Theresienstraße 8 74072 Heilbronn / GERMANY
Tested to radio standards specification no.	:	RSS 210, Issue 8
Open area test site IC No.	:	IC 3462C-1
Frequency range	:	Lowest channel 5736 MHz, highest channel 5814 MHz
RF-power [W] (max.)	:	cond.: 112.98 mW (Rod antenna A) EIRP: 323.95 mW (Rod antenna A) cond.: 102.33 mW (Rod antenna B) EIRP: 123.88 mW (Rod antenna B) cond.: 112.98 mW (Planar antenna A) EIRP: 521.19 mW (Planar antenna A) cond.: 102.33 mW (Planar antenna B) EIRP: 475.34 mW (Planar antenna B) cond.: 112.98 mW (Omnidirectional antenna A) EIRP: 45.39 mW (Omnidirectional antenna A) cond.: 102.33 mW (Omnidirectional antenna B) EIRP: 38.02 mW (Omnidirectional antenna B)
Occupied bandwidth (99%-BW) [kHz]	:	Antenna port A: DSSS: 21.04 MHz Antenna port B: DSSS: 18.74 MHz
Type of modulation	:	DSSS
Emission designator (TRC-43)	:	antenna port A: 21M0G7D antenna port B: 18M7G7D
Antenna information	:	Two external N-connectors / Dedicated antennas (Rod antenna, Planar antenna, Omni directional antenna)
Transmitter spurious (worst case) [dB μ V/m @ 3m]:		51.7 @ 3850 MHz
Receiver spurious (worst case) [dB μ V/m @ 3m]:		47.96 @ 12696 MHz (noise floor)

ATTESTATION:

DECLARATION OF COMPLIANCE:

I attest that the testing was performed or supervised by me; that the test measurements were made in accordance with the above-mentioned Industry Canada standard(s); and that the equipment identified in this application has been subjected to all the applicable test conditions specified in the Industry Canada standards and all of the requirements of the standard have been met.

Laboratory manager:

2012-11-06

Date

Jakob Reschke

Name



Signature

9 Measurement results

9.1 Antenna gain

Measurement:

The antenna gain of the complete system is calculated by the difference of radiated power in EIRP and the conducted power of the module.

Measurement parameters:

Measurement parameter	
Detector:	Peak
Sweep time:	Auto
Video bandwidth:	10 MHz
Resolution bandwidth:	3MHz
Trace-Mode:	Max hold

Limits:

FCC	IC
CFR Part 15.247 (b)(4)	RSS 210, Issue 8, A 8.4(2)
Antenna Gain	
6 dBi	

Results: Rod antenna A

T _{nom}	V _{nom}	lowest channel 5736 MHz	middle channel 5762 MHz	highest channel 5814 MHz
Conducted power [dBm] Measured with DSSS modulation		16.07	16.68	17.08
Radiated power [dBm] Measured with DSSS modulation		21.14	19.99	20.20
Gain [dBi] Calculated		5.07	3.31	3.12
Measurement uncertainty			± 1.5 dB (cond.) / ± 3 dB (rad.)	

Results: Rod antenna B

T _{nom}	V _{nom}	lowest channel 5736 MHz	middle channel 5762 MHz	highest channel 5814 MHz
Conducted power [dBm] Measured with DSSS modulation		16.62	17.11	16.93
Radiated power [dBm] Measured with DSSS modulation		18.90	18.30	17.20
Gain [dBi] Calculated		2.28	1.19	0.27
Measurement uncertainty			± 1.5 dB (cond.) / ± 3 dB (rad.)	

Result: Passed

Results: Planar antenna A, 10m cable

T _{nom}	V _{nom}	lowest channel 5736 MHz	middle channel 5762 MHz	highest channel 5814 MHz
Conducted power [dBm] Measured with DSSS modulation		16.07	16.68	17.08
Radiated power [dBm] Measured with DSSS modulation		23.21	23.77	23.50
System gain* [dBi] Calculated		7.14	7.09	6.42
Measurement uncertainty			± 1.5 dB (cond.) / ± 3 dB (rad.)	

*) System gain = antenna gain - cable loss

Results: Planar antenna B, 10m cable

T _{nom}	V _{nom}	lowest channel 5736 MHz	middle channel 5762 MHz	highest channel 5814 MHz
Conducted power [dBm] Measured with DSSS modulation		16.62	17.11	16.93
Radiated power [dBm] Measured with DSSS modulation		23.67	23.90	23.60
System gain* [dBi] Calculated		7.05	6.79	6.67
Measurement uncertainty			± 1.5 dB (cond.) / ± 3 dB (rad.)	

*) System gain = antenna gain - cable loss

Result: Passed

Results: Planar antenna A, 20m cable

T _{nom}	V _{nom}	lowest channel 5736 MHz	middle channel 5762 MHz	highest channel 5814 MHz
Conducted power [dBm] Measured with DSSS modulation		16.07	16.68	17.08
Radiated power [dBm] Measured with DSSS modulation		19.65	18.58	18.43
System gain* [dBi] Calculated		3.58	1.90	1.35
Measurement uncertainty			± 1.5 dB (cond.) / ± 3 dB (rad.)	

*) System gain = antenna gain - cable loss - adapter loss

Results: Planar antenna B, 20m cable

T _{nom}	V _{nom}	lowest channel 5736 MHz	middle channel 5762 MHz	highest channel 5814 MHz
Conducted power [dBm] Measured with DSSS modulation		16.62	17.11	16.93
Radiated power [dBm] Measured with DSSS modulation		19.70	19.41	19.50
System gain* [dBi] Calculated		3.08	2.30	2.57
Measurement uncertainty			± 1.5 dB (cond.) / ± 3 dB (rad.)	

*) System gain = antenna gain - cable loss - adapter loss

Result: **Passed**

Results: Omnidirectional antenna A, 10m cable

T _{nom}	V _{nom}	lowest channel 5736 MHz	middle channel 5762 MHz	highest channel 5814 MHz
Conducted power [dBm] Measured with DSSS modulation		16.07	16.68	17.08
Radiated power [dBm] Measured with DSSS modulation		12.61	11.61	11.90
System gain* [dBi] Calculated		-3.46	-5.07	-5.18
Measurement uncertainty			± 1.5 dB (cond.) / ± 3 dB (rad.)	

*) System gain = antenna gain - cable loss

Results: Omnidirectional antenna B, 10m cable

T _{nom}	V _{nom}	lowest channel 5736 MHz	middle channel 5762 MHz	highest channel 5814 MHz
Conducted power [dBm] Measured with DSSS modulation		16.62	17.11	16.93
Radiated power [dBm] Measured with DSSS modulation		12.91	12.76	12.63
System gain* [dBi] Calculated		-3.71	-4.35	-4.30
Measurement uncertainty			± 1.5 dB (cond.) / ± 3 dB (rad.)	

*) System gain = antenna gain - cable loss

Result: Passed

Results: Omnidirectional antenna A, 20m cable

T _{nom}	V _{nom}	lowest channel 5736 MHz	middle channel 5762 MHz	highest channel 5814 MHz
Conducted power [dBm] Measured with DSSS modulation		16.07	16.68	17.08
Radiated power [dBm] Measured with DSSS modulation		8.22	8.90	9.33
System gain* [dBi] Calculated		-7.85	-7.78	-7.75
Measurement uncertainty			± 1.5 dB (cond.) / ± 3 dB (rad.)	

*) System gain = antenna gain - cable loss - adapter loss

Results: Omnidirectional antenna B, 20m cable

T _{nom}	V _{nom}	lowest channel 5736 MHz	middle channel 5762 MHz	highest channel 5814 MHz
Conducted power [dBm] Measured with DSSS modulation		16.62	17.11	16.93
Radiated power [dBm] Measured with DSSS modulation		10.39	10.94	10.14
System gain* [dBi] Calculated		-6.23	-6.17	-6.79
Measurement uncertainty			± 1.5 dB (cond.) / ± 3 dB (rad.)	

*) System gain = antenna gain - cable loss - adapter loss

Result: Passed

9.2 Maximum output power

Description:

Measurement of the maximum output power conducted and radiated. The measurements are performed using the data rate producing the highest conducted output power. The determination of these data rates was performed at the beginning of the tests.

Measurement:

Measurement parameter	
Detector:	Peak
Sweep time:	Auto
Video bandwidth:	30 MHz
Resolution bandwidth:	50 MHz
Span:	30 MHz
Trace-Mode:	Max Hold

Limits:

FCC	IC
CFR Part 15.247 (b)(3)	RSS 210, Issue 8, A 8.4(4)
Maximum Output Power	
Conducted: 1.0 W – Antenna Gain max. 6 dBi	

Results: Rod antenna A

DSSS Frequency	Maximum Output Power [dBm]		
	5736 MHz	5762 MHz	5814 MHz
Peak Output Power Conducted	20.03	20.12	20.53
Output Power Radiated – EIRP*)	25.10	23.31	23.65
Measurement uncertainty	± 1.5 dB (cond.) / ± 3 dB (rad.)		

*) calculated with Antenna gain

Results: Rod antenna B

DSSS Frequency	Maximum Output Power [dBm]		
	5736 MHz	5762 MHz	5814 MHz
Peak Output Power Conducted	18.65	19.52	20.10
Output Power Radiated – EIRP*)	20.93	20.71	20.37
Measurement uncertainty	± 1.5 dB (cond.) / ± 3 dB (rad.)		

*) calculated with Antenna gain

Results: Planar antenna A with 10 m cable

DSSS Frequency	Maximum Output Power [dBm]		
	5736 MHz	5762 MHz	5814 MHz
Peak Output Power Conducted	20.03	20.12	20.53
Output Power Radiated – EIRP*)	27.17	27.09	26.95
Measurement uncertainty	± 1.5 dB (cond.) / ± 3 dB (rad.)		

*) calculated with Antenna gain

Results: Planar antenna B with 10 m cable

DSSS Frequency	Maximum Output Power [dBm]		
	5736 MHz	5762 MHz	5814 MHz
Peak Output Power Conducted	18.65	19.52	20.10
Output Power Radiated – EIRP*)	25.7	26.31	26.77
Measurement uncertainty	± 1.5 dB (cond.) / ± 3 dB (rad.)		

*) calculated with Antenna gain

Results: Planar antenna A with 20 m cable

DSSS Frequency	Maximum Output Power [dBm]		
	5736 MHz	5762 MHz	5814 MHz
Peak Output Power Conducted	20.03	20.12	20.53
Output Power Radiated – EIRP*)	23.61	22.02	21.88
Measurement uncertainty	± 1.5 dB (cond.) / ± 3 dB (rad.)		

*) calculated with Antenna gain

Results: Planar antenna B with 20 m cable

DSSS Frequency	Maximum Output Power [dBm]		
	5736 MHz	5762 MHz	5814 MHz
Peak Output Power Conducted	18.65	19.52	20.10
Output Power Radiated – EIRP*)	21.73	21.82	22.67
Measurement uncertainty	± 1.5 dB (cond.) / ± 3 dB (rad.)		

*) calculated with Antenna gain

Results: Omnidirectional antenna A with 10 m cable

DSSS Frequency	Maximum Output Power [dBm]		
	5736 MHz	5762 MHz	5814 MHz
Peak Output Power Conducted	20.03	20.12	20.53
Output Power Radiated – EIRP*)	16.57	15.05	15.35
Measurement uncertainty	± 1.5 dB (cond.) / ± 3 dB (rad.)		

*) calculated with Antenna gain

Results: Omnidirectional antenna B with 10 m cable

DSSS Frequency	Maximum Output Power [dBm]		
	5736 MHz	5762 MHz	5814 MHz
Peak Output Power Conducted	18.65	19.52	20.10
Output Power Radiated – EIRP*)	14.94	15.17	15.80
Measurement uncertainty	± 1.5 dB (cond.) / ± 3 dB (rad.)		

*) calculated with Antenna gain

Results: Omnidirectional antenna A with 20 m cable

DSSS Frequency	Maximum Output Power [dBm]		
	5736 MHz	5762 MHz	5814 MHz
Peak Output Power Conducted	20.03	20.12	20.53
Output Power Radiated – EIRP*)	12.18	12.34	12.78
Measurement uncertainty	± 1.5 dB (cond.) / ± 3 dB (rad.)		

*) calculated with Antenna gain

Results: Omnidirectional antenna B with 20 m cable

DSSS Frequency	Maximum Output Power [dBm]		
	5736 MHz	5762 MHz	5814 MHz
Peak Output Power Conducted	18.65	19.52	20.10
Output Power Radiated – EIRP*)	12.42	13.35	13.31
Measurement uncertainty	± 1.5 dB (cond.) / ± 3 dB (rad.)		

*) calculated with Antenna gain

Result: Passed

9.3 Power spectral density

Description:

Measurement of the power spectral density of a digital modulated system. The measurement is repeated for both modulations at the lowest, middle and highest channel.

Measurement:

Measurement parameter	
Detector:	Peak
Sweep time:	Auto
Video bandwidth:	300 kHz
Resolution bandwidth:	100 kHz
Span:	10 MHz
Trace-Mode:	Max Hold

Limits:

FCC	IC
CFR Part 15.247 (e)	RSS 210, Issue 8, A 8.2(b)
Power Spectral Density	
The transmitter power spectral density conducted from the transmitter to the antenna shall not be greater than 8 dBm in any 3 kHz band during any time interval of continuous transmission or over 1.0 second if the transmission exceeds 1.0-second duration.	

Results: Antenna A

Modulation	Power Spectral density [dBm/3kHz]		
	5736 MHz	5762 MHz	5814 MHz
Frequency			
DSSS	2.04	2.08	2.46
Measurement uncertainty	± 1.5 dB		

Results: Antenna B

Modulation	Power Spectral density [dBm/3kHz]		
	5736 MHz	5762 MHz	5814 MHz
Frequency			
DSSS	1.55	1.58	1.74
Measurement uncertainty	± 1.5 dB		

Result: Passed

Plots: Antenna A

Plot 1: TX mode, lowest channel

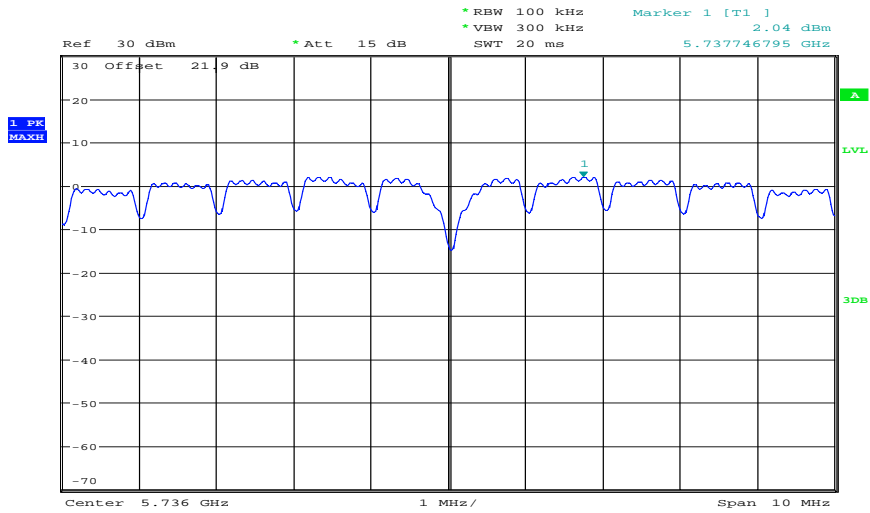

Date: 9.MAR.2012 08:57:02

Plot 2: TX mode, middle channel

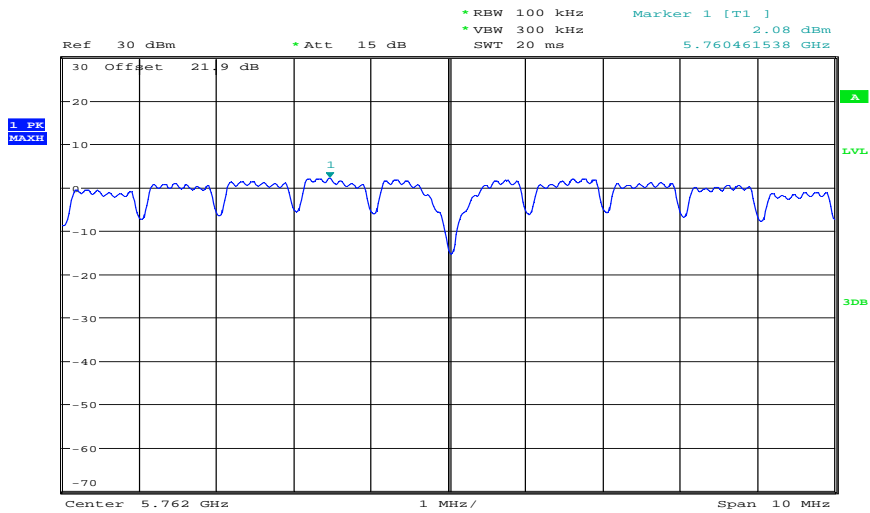

Date: 9.MAR.2012 08:57:43

Plot 3: TX mode, highest channel

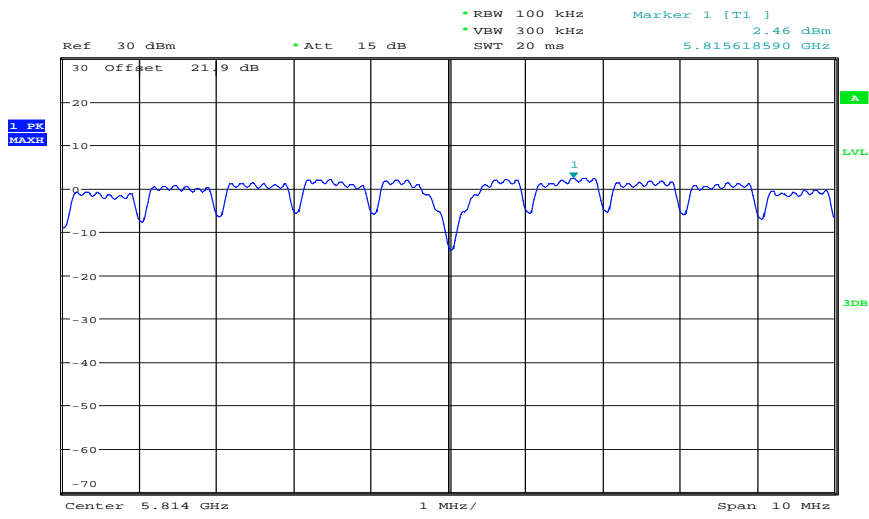

Date: 9.MAR.2012 08:58:39

Plots: Antenna B

Plot 1: TX mode, lowest channel

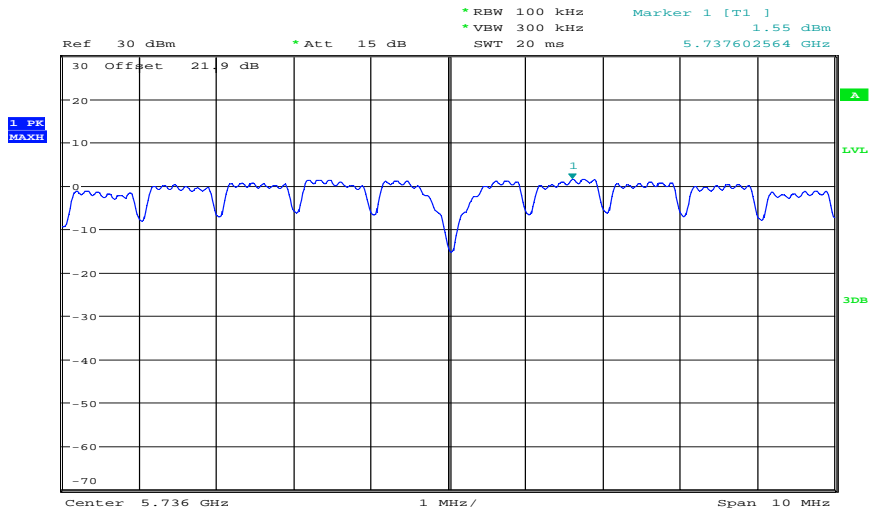

Date: 9.MAR.2012 09:00:24

Plot 2: TX mode, middle channel

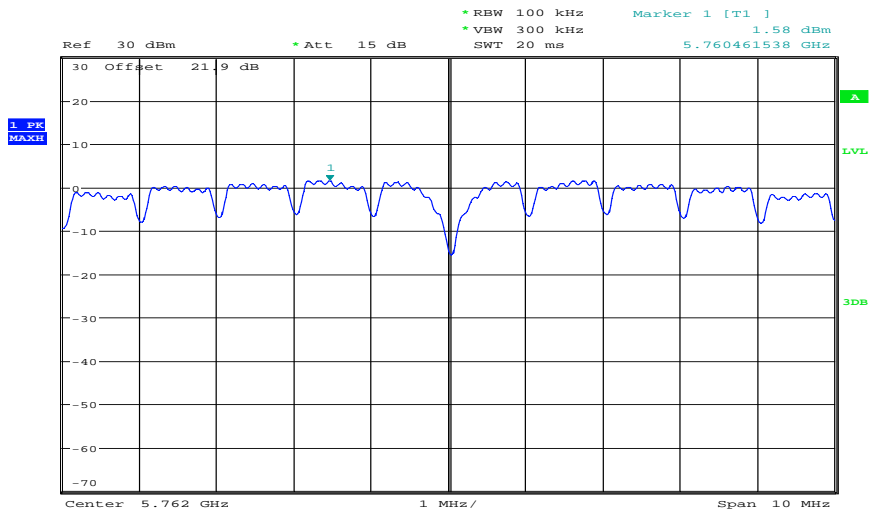

Date: 9.MAR.2012 09:01:02

Plot 3: TX mode, highest channel

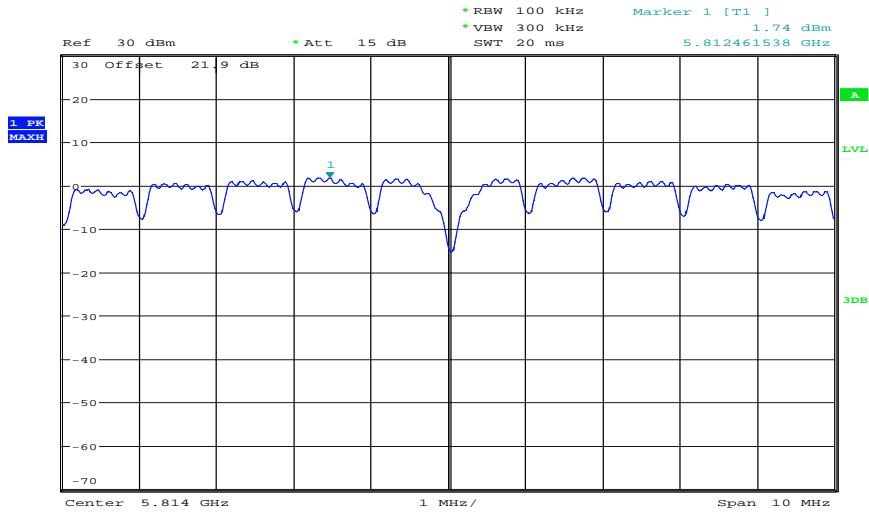

Date: 9.MAR.2012 09:01:38

9.4 Spectrum bandwidth – 6 dB bandwidth

Description:

Measurement of the 6 dB bandwidth of the modulated signal.

Measurement:

Measurement parameter	
Detector:	Peak
Sweep time:	Auto
Video bandwidth:	1 MHz
Resolution bandwidth:	300 kHz
Span:	See plots
Trace-Mode:	Max Hold

Limits:

FCC	IC
CFR Part 15.247 (a)(2)	RSS 210, Issue 8, A 8.2(a)
Spectrum Bandwidth– 6 dB Bandwidth	
The minimum 6 dB bandwidth shall be at least 500 kHz.	

Results: Antenna A

Modulation	6 dB BANDWIDTH [MHz]		
	5736 MHz	5762 MHz	5814 MHz
Frequency	5736 MHz	5762 MHz	5814 MHz
DSSS	7.92	7.92	7.92
Measurement uncertainty	± 100 kHz		

Results: Antenna B

Modulation	6 dB BANDWIDTH [MHz]		
	5736 MHz	5762 MHz	5814 MHz
Frequency	5736 MHz	5762 MHz	5814 MHz
DSSS	7.92	7.82	7.82
Measurement uncertainty	± 100 kHz		

Result: Passed

Plots: Antenna A

Plot 1: TX mode, lowest channel, 6 dB bandwidth

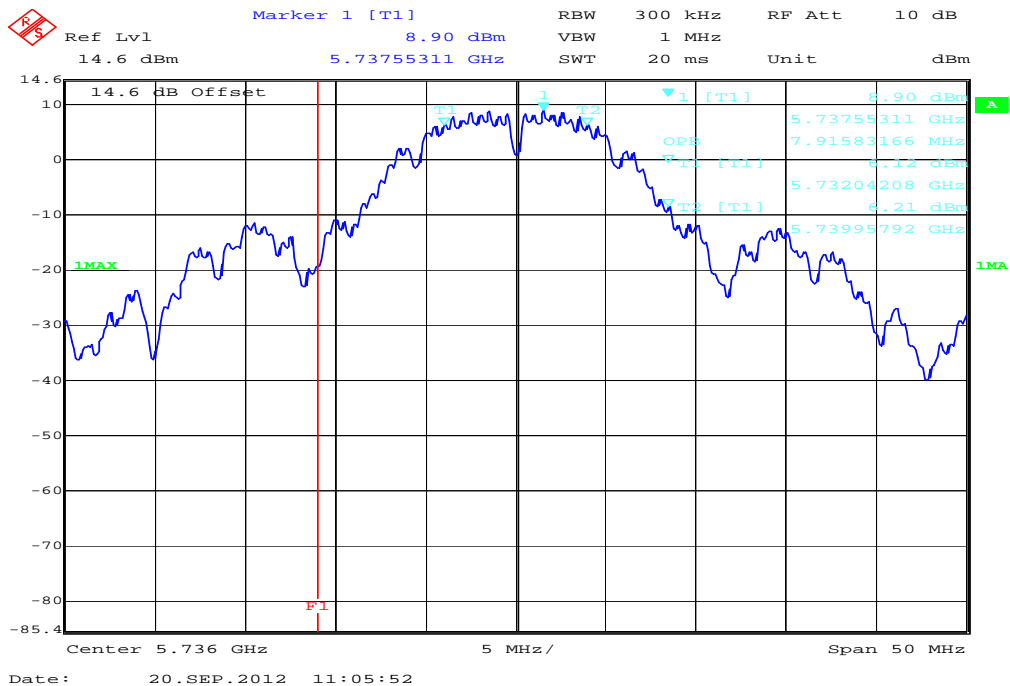

Plot 2: TX mode, middle channel, 6 dB bandwidth

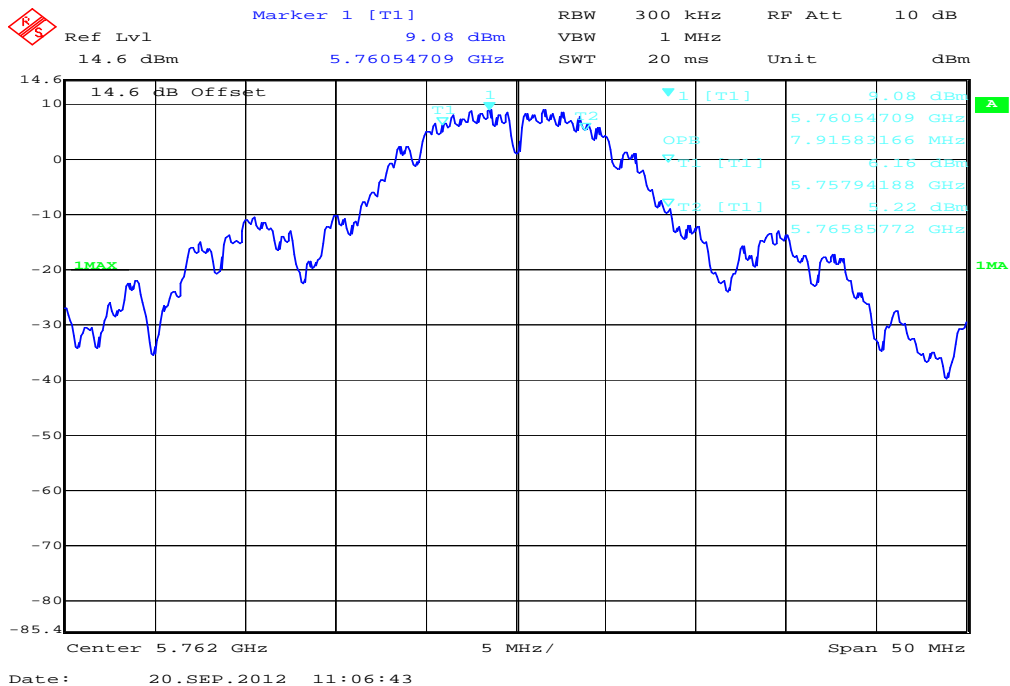

Plots: Antenna B

Plot 1: TX mode, lowest channel, 6 dB bandwidth

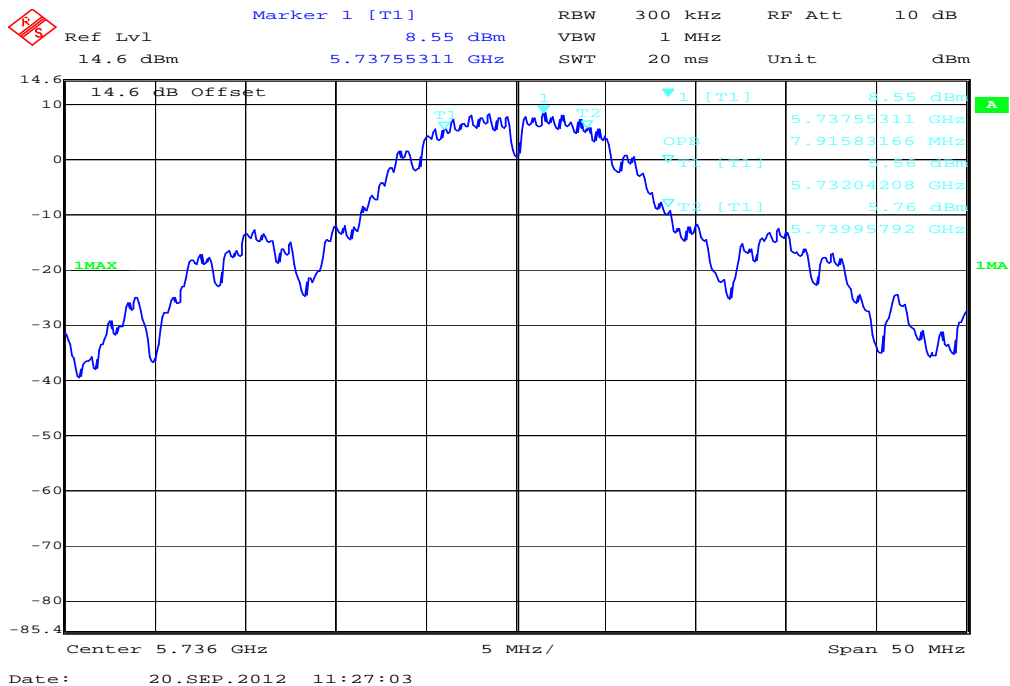

Plot 2: TX mode, middle channel, 6 dB bandwidth

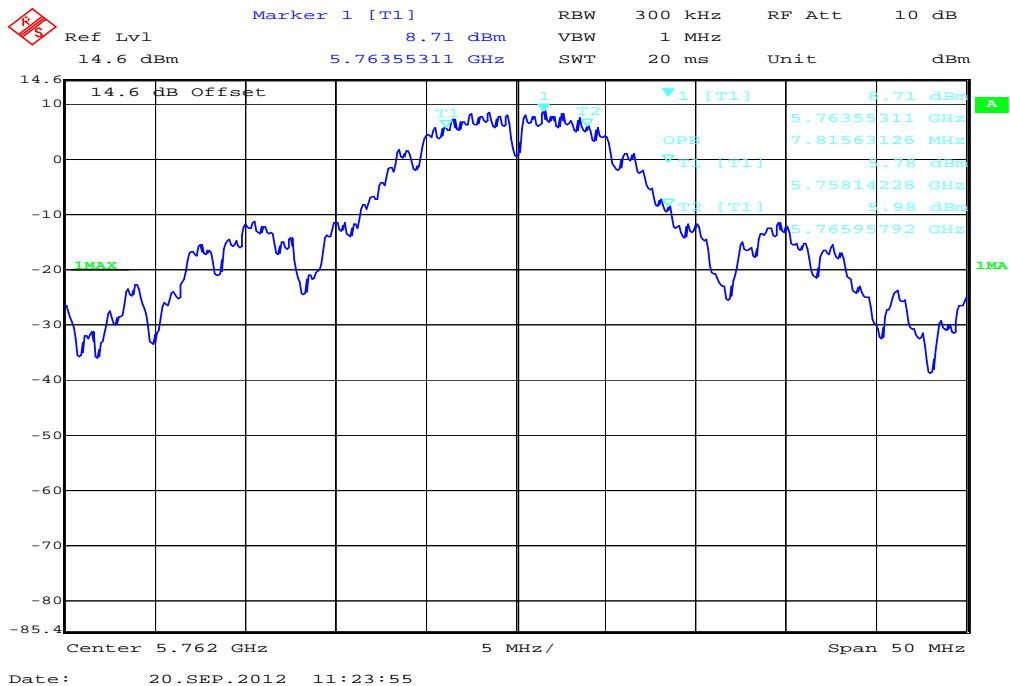

Plot 3: TX mode, highest channel, 6 dB bandwidth

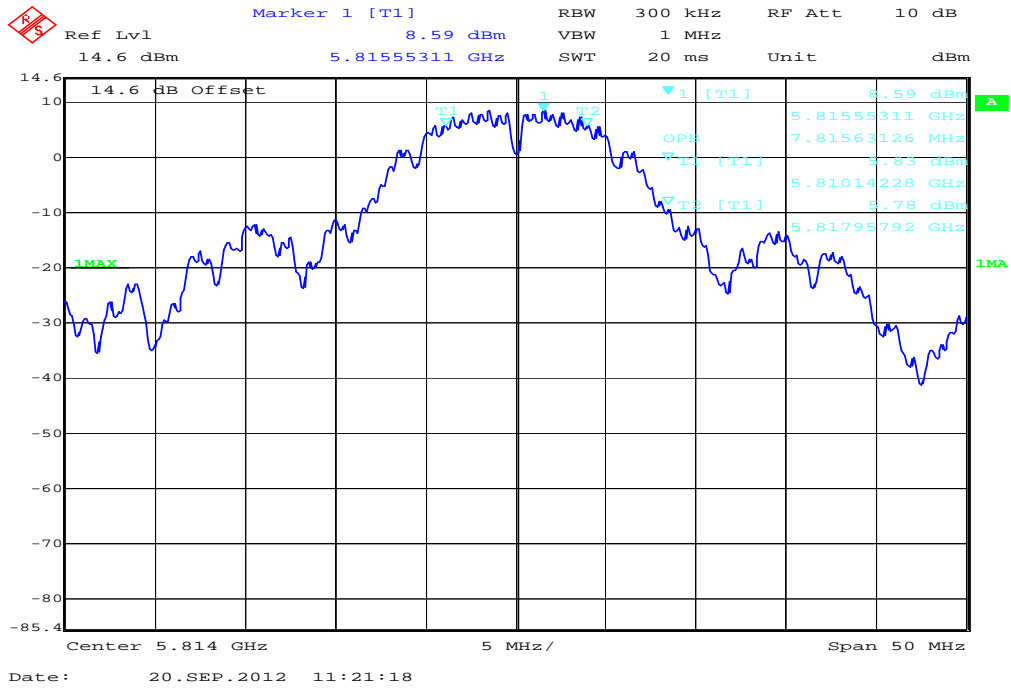

9.5 Spectrum bandwidth – 20 dB bandwidth

Description:

Measurement of the 20 dB bandwidth of the modulated signal.

Measurement:

Measurement parameter	
Detector:	Peak
Sweep time:	Auto
Video bandwidth:	1 MHz
Resolution bandwidth:	100 kHz
Span:	See plots
Trace-Mode:	Max Hold

Limits:

FCC	IC
CFR Part 15.247 (a)(2)	RSS 210, Issue 8, A 8.2(a)
Spectrum Bandwidth – 20 dB Bandwidth	

Results: Antenna A

Modulation	20 dB BANDWIDTH [MHz]		
	5736 MHz	5762 MHz	5814 MHz
Frequency	5736 MHz	5762 MHz	5814 MHz
DSSS	18.74	19.24	21.04
Measurement uncertainty	± 100 kHz		

Results: Antenna B

Modulation	20 dB BANDWIDTH [MHz]		
	5736 MHz	5762 MHz	5814 MHz
Frequency	5736 MHz	5762 MHz	5814 MHz
DSSS	18.44	18.74	18.24
Measurement uncertainty	± 100 kHz		

Result: Passed

Plots: Antenna A

Plot 1: TX mode, lowest channel, 20 dB bandwidth

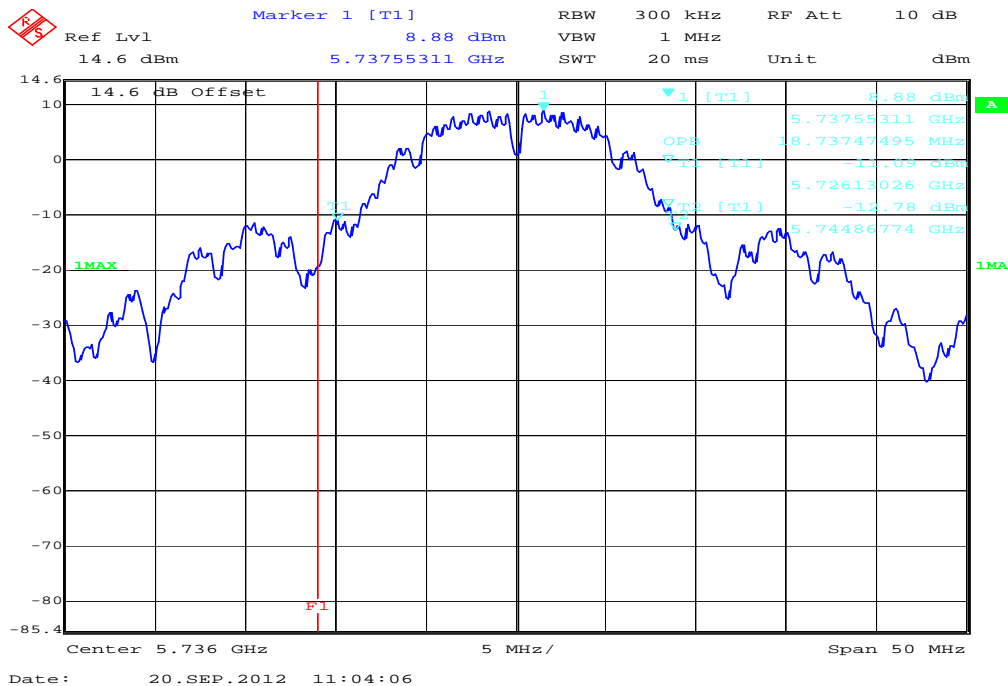

Plot 2: TX mode, middle channel, 20 dB bandwidth

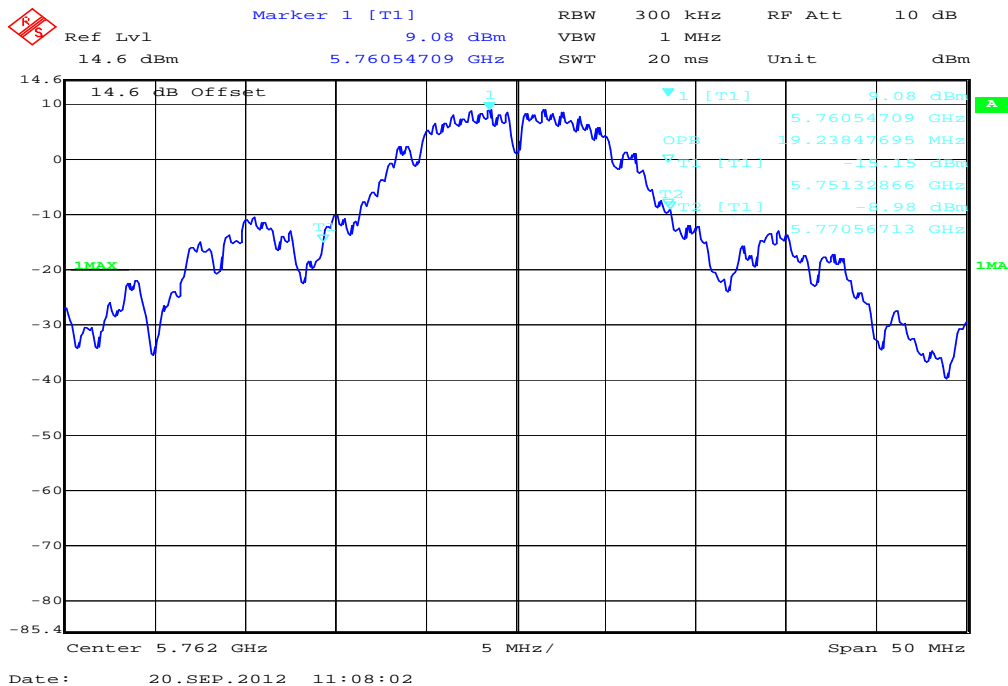

Plot 3: TX mode, highest channel, 20 dB bandwidth

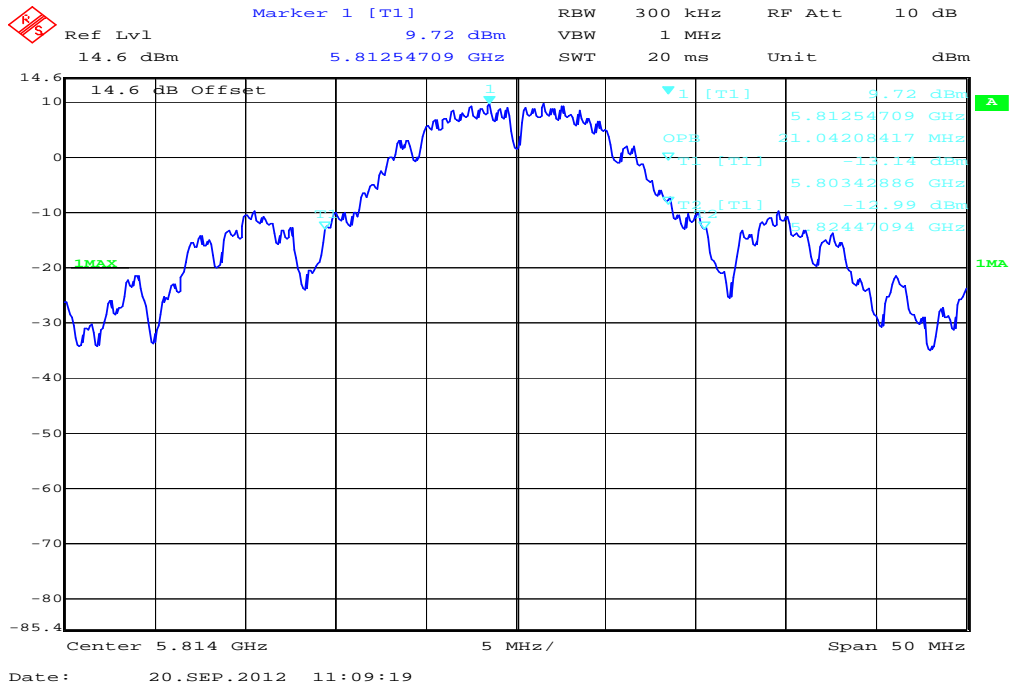

Plots: Antenna B

Plot 1: TX mode, lowest channel, 20 dB bandwidth

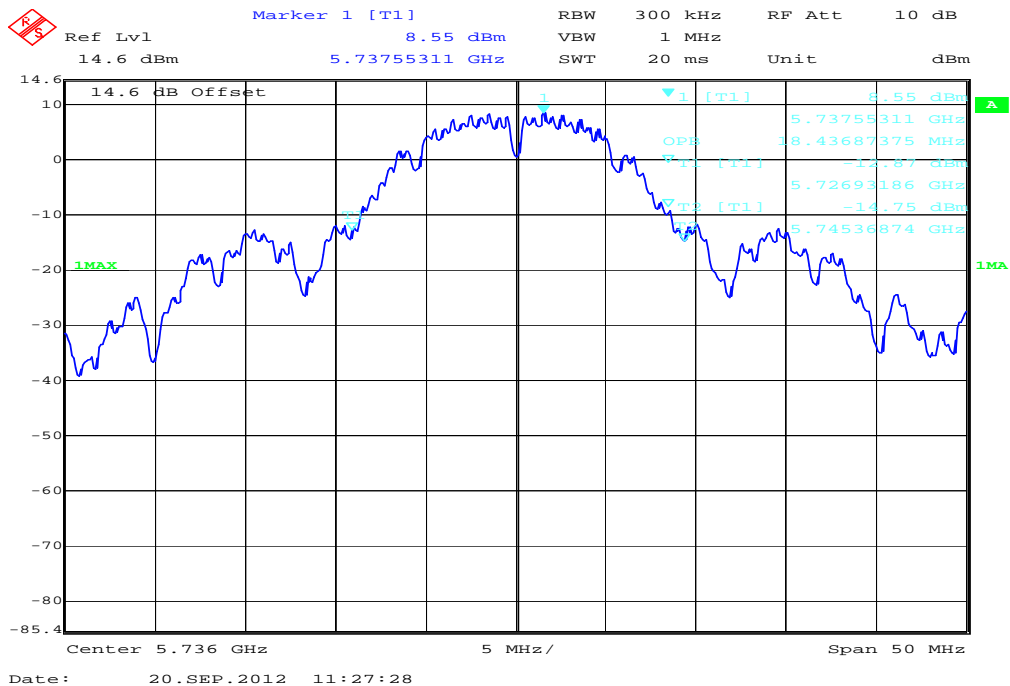

Plot 2: TX mode, middle channel, 20 dB bandwidth

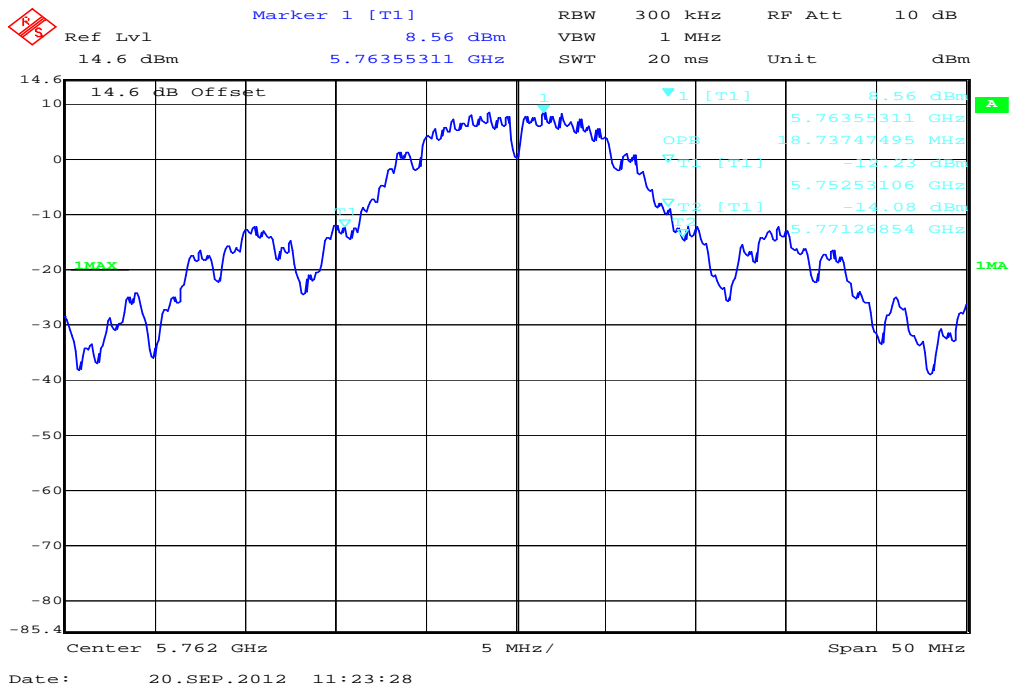

Plot 3: TX mode, highest channel, 20 dB bandwidth

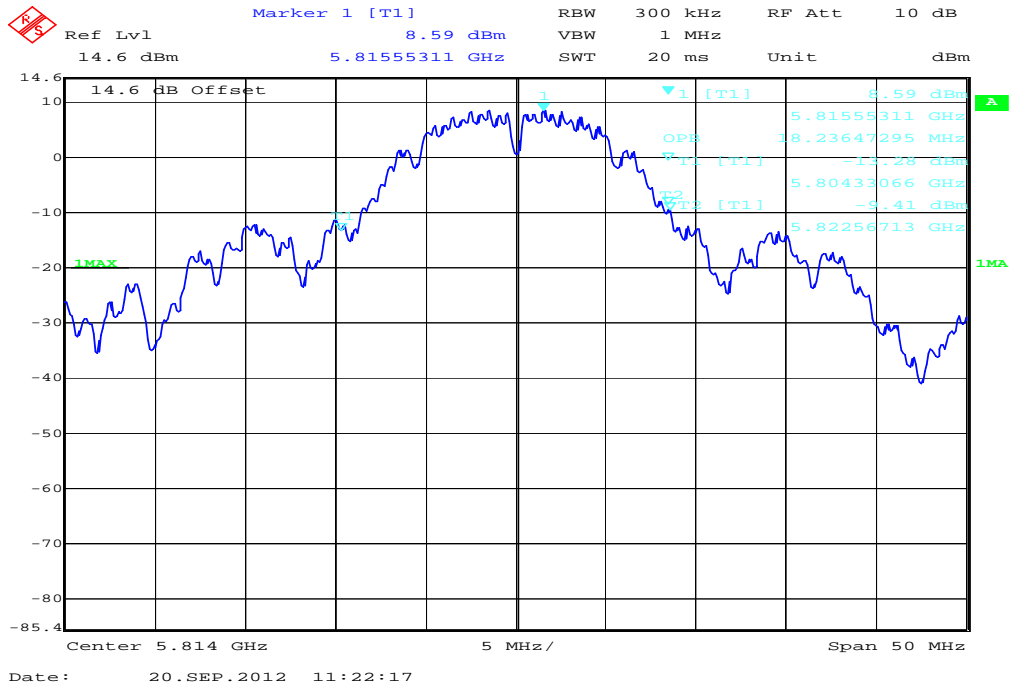

9.6 TX spurious emissions conducted

Description:

Measurement of the conducted spurious emissions in transmit mode.

Measurement:

Measurement parameter	
Detector:	Peak
Sweep time:	Auto
Video bandwidth:	F < 1 GHz: 100 kHz F > 1 GHz: 100 kHz
Resolution bandwidth:	F < 1 GHz: 100 kHz F > 1 GHz: 100 kHz
Span:	9 kHz to 25 GHz
Trace-Mode:	Max Hold

Limits:

FCC	IC
CFR Part 15.247(d)	RSS 210, Issue 8, A 8.5
TX Spurious Emissions Conducted	
<p>In any 100 kHz bandwidth outside the frequency band in which the spread spectrum or digitally modulated intentional radiator is operating, the radio frequency power that is produced by the intentional radiator shall be at least 20 dB below that in the 100 kHz bandwidth within the band that contains the highest level of the desired power, based on either an RF conducted or a radiated measurement. Attenuation below the general limits specified in Section 15.209(a) is not required</p>	

Results: Antenna A

TX Spurious Emissions Conducted					
DSSS - mode					
f [MHz]		amplitude of emission [dBm]	limit max. allowed emission power	actual attenuation below frequency of operation [dB]	results
5736		2.63	30 dBm		Operating frequency
No critical peaks detected. All detected emissions are more than 6 dB below the limit!			-20 dBc		complies
5762		2.50	30 dBm		Operating frequency
No critical peaks detected. All detected emissions are more than 6 dB below the limit!			-20 dBc		complies
5814		2.69	30 dBm		Operating frequency
No critical peaks detected. All detected emissions are more than 6 dB below the limit!			-20 dBc		complies
Measurement uncertainty		± 3 dB			

Results: Antenna B

TX Spurious Emissions Conducted					
DSSS - mode					
f [MHz]		amplitude of emission [dBm]	limit max. allowed emission power	actual attenuation below frequency of operation [dB]	results
5736		2.11	30 dBm		Operating frequency
No critical peaks detected. All detected emissions are more than 6 dB below the limit!			-20 dBc		complies
5762		1.92	30 dBm		Operating frequency
No critical peaks detected. All detected emissions are more than 6 dB below the limit!			-20 dBc		complies
5814		2.21	30 dBm		Operating frequency
No critical peaks detected. All detected emissions are more than 6 dB below the limit!			-20 dBc		complies
Measurement uncertainty		± 3 dB			

Result: Passed

Plots: Antenna A

Plot 1: TX mode, lowest channel, 0 Hz to 1 GHz

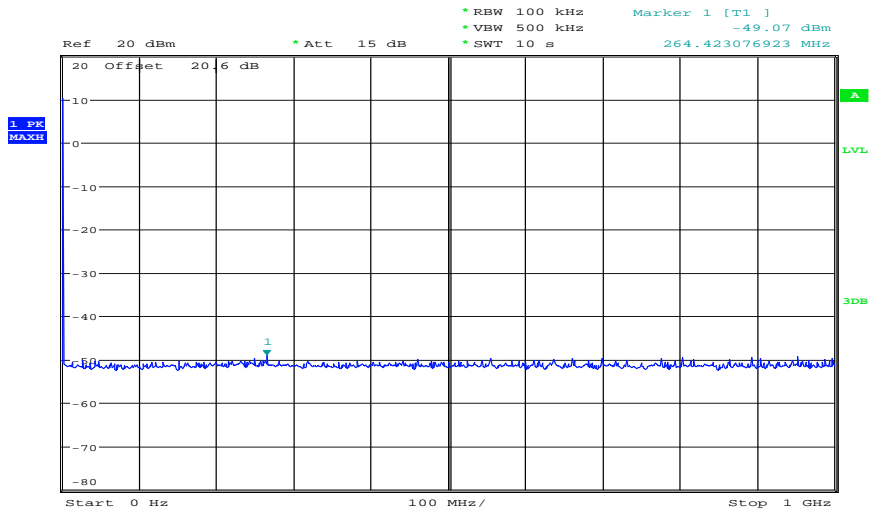

Date: 9.MAR.2012 09:11:43

The peak at the beginning of the plot is the LO from the SA.

Plot 2: TX mode, lowest channel, 1 GHz to 12 GHz

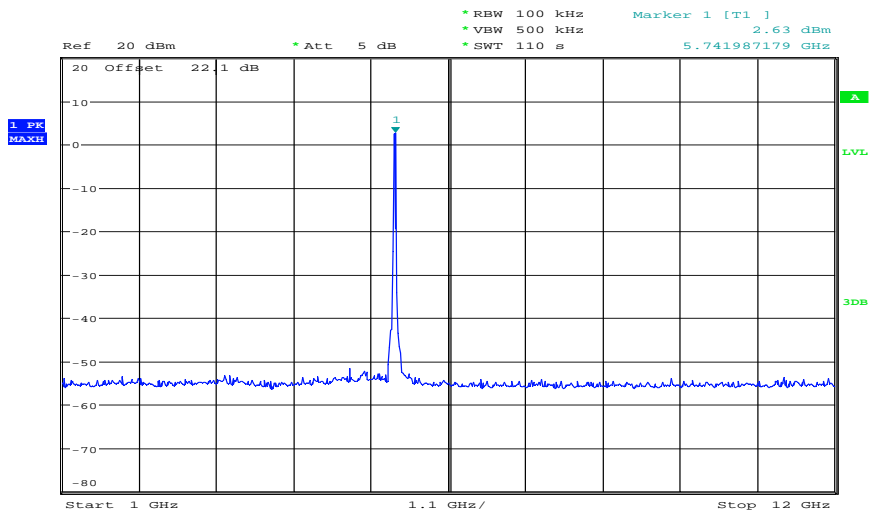

Date: 9.MAR.2012 09:16:10

Plot 3: TX mode, lowest channel, 12 GHz to 25 GHz

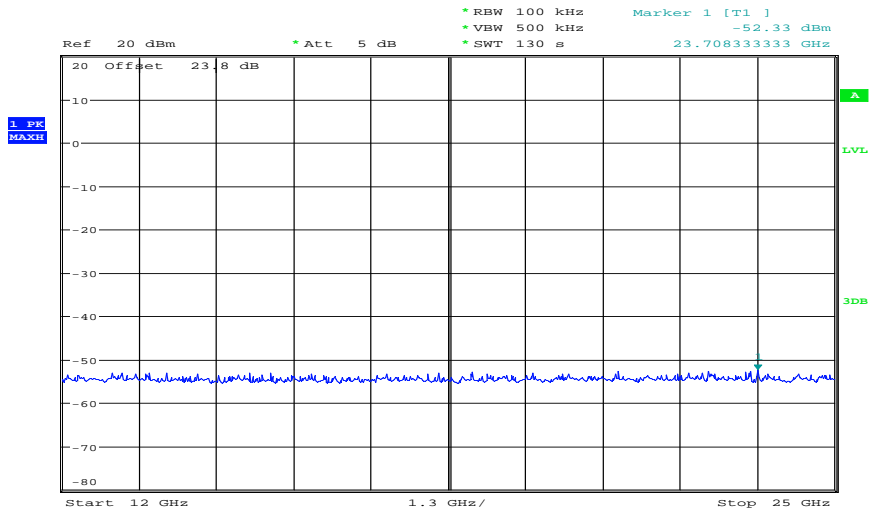

Date: 9.MAR.2012 09:43:09

Plot 4: TX mode, lowest channel, 25 GHz to 40 GHz

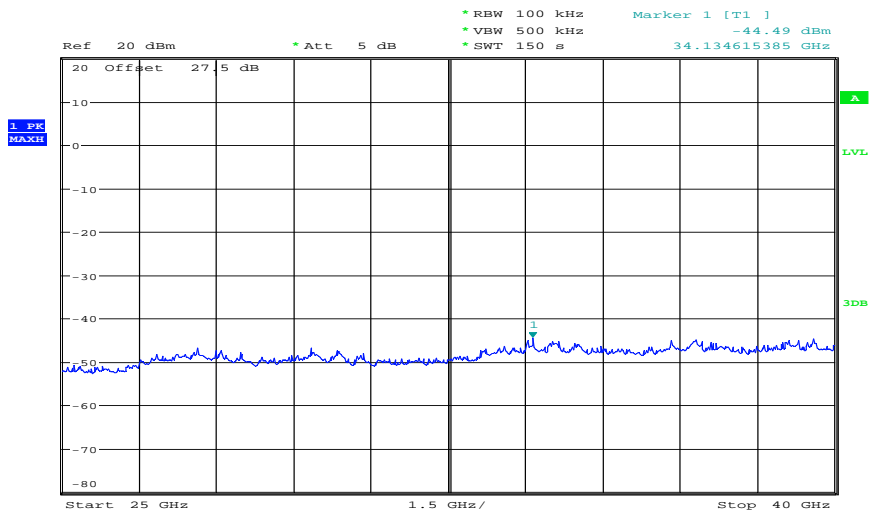

Date: 9.MAR.2012 10:11:49

Plot 5: TX mode, middle channel, 0 Hz to 1 GHz

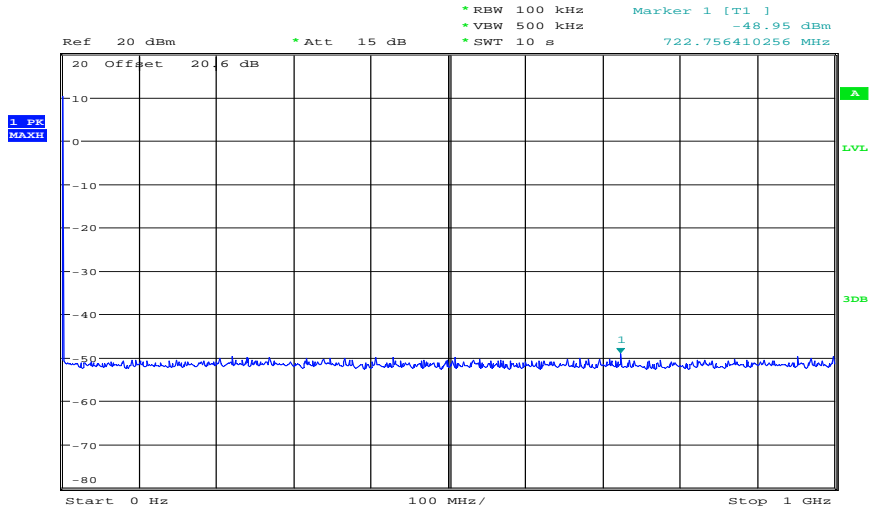

Date: 9.MAR.2012 09:12:37

The peak at the beginning of the plot is the LO from the SA.

Plot 6: TX mode, middle channel, 1 GHz to 12 GHz

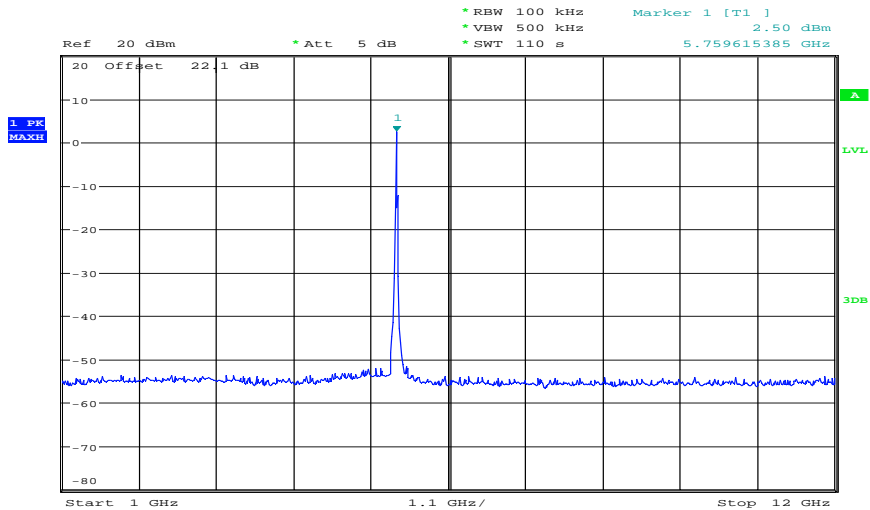

Date: 9.MAR.2012 09:18:34

Plot 7: TX mode, middle channel, 12 GHz to 25 GHz

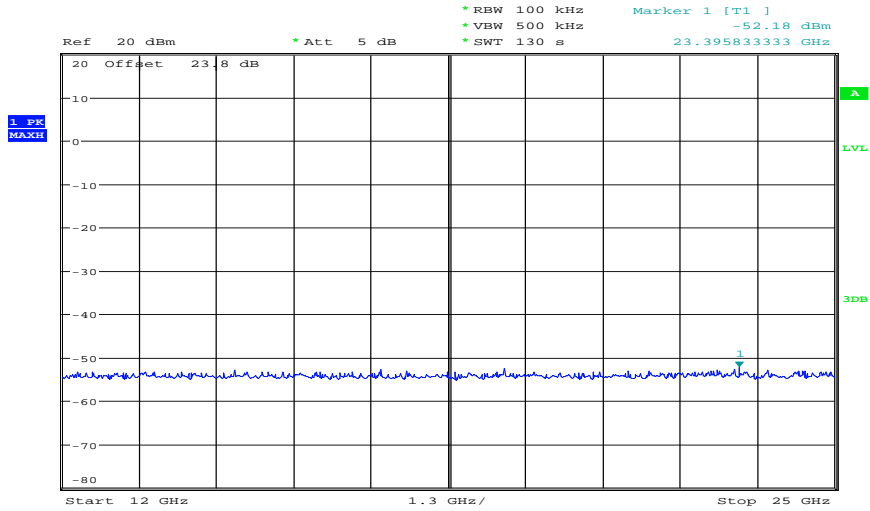

Plot 8: TX mode, middle channel, 25 GHz to 40 GHz

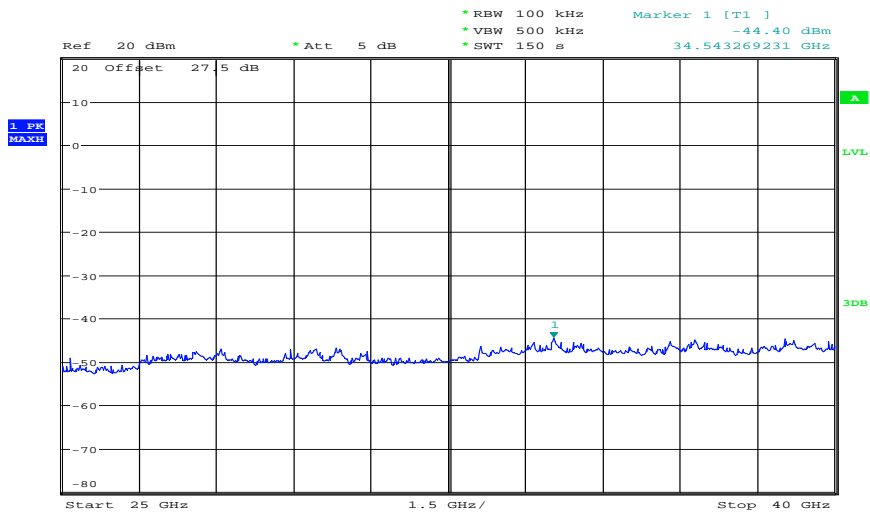

Plot 9: TX mode, highest channel, 0 Hz to 1 GHz

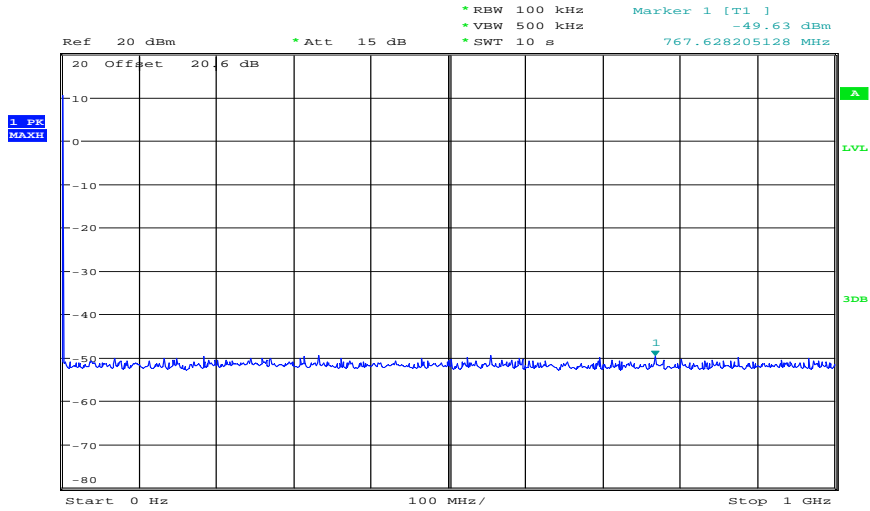

Date: 9.MAR.2012 09:13:18

The peak at the beginning of the plot is the LO from the SA.

Plot 10: TX mode, highest channel, 1 GHz to 12 GHz

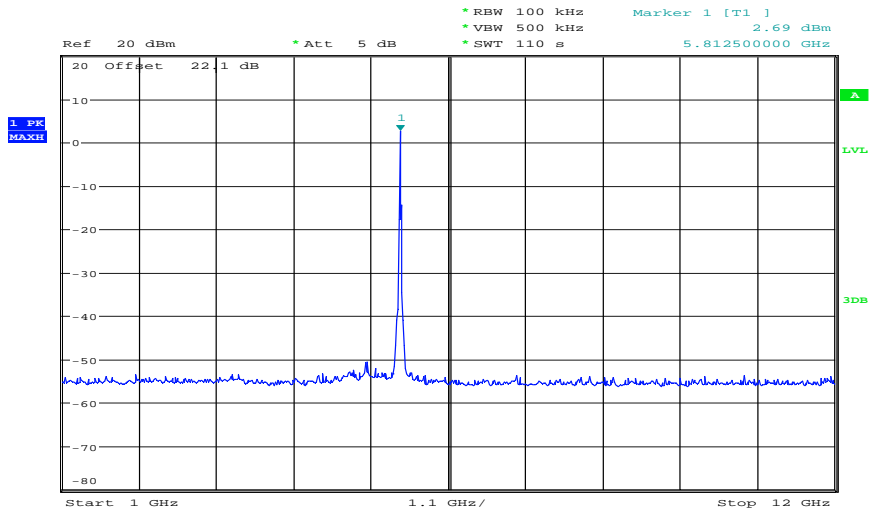

Date: 9.MAR.2012 09:20:51

Plot 11: TX mode, highest channel, 12 GHz to 25 GHz

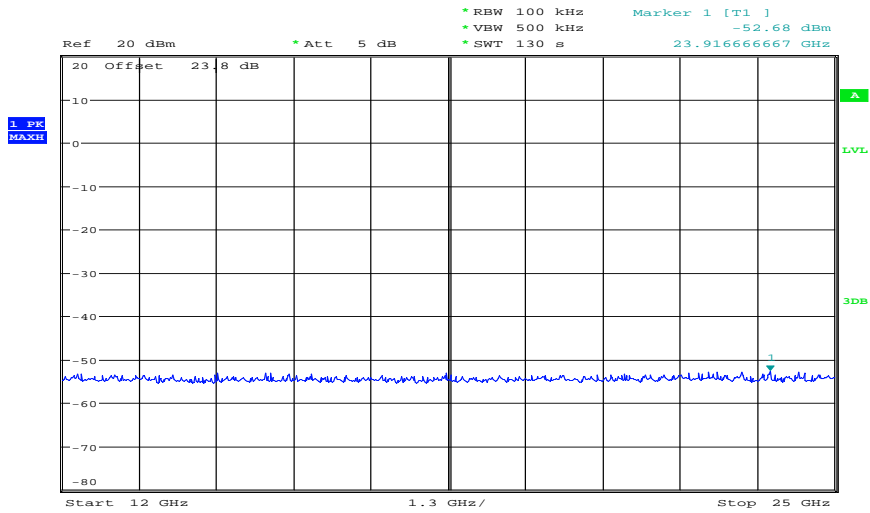

Date: 9.MAR.2012 09:51:02

Plot 12: TX mode, highest channel, 25 GHz to 40 GHz

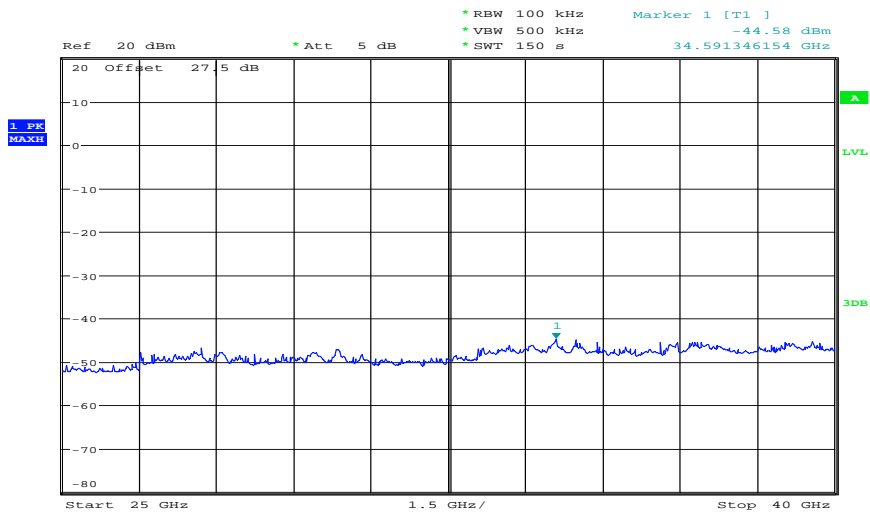

Date: 9.MAR.2012 09:54:51

Plots: Antenna B

Plot 1: TX mode, lowest channel, 0 Hz to 1 GHz

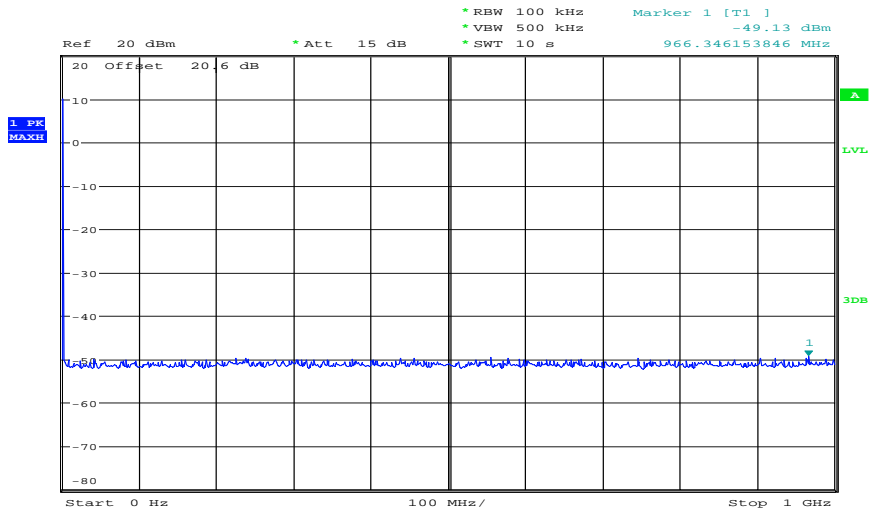

Date: 9.MAR.2012 09:07:21

The peak at the beginning of the plot is the LO from the SA.

Plot 2: TX mode, lowest channel, 1 GHz to 12 GHz

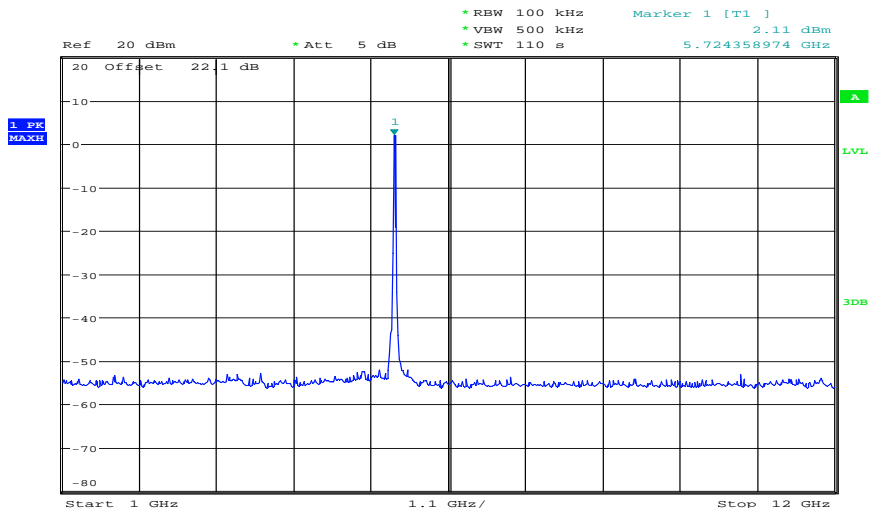

Date: 9.MAR.2012 09:23:31

Plot 3: TX mode, lowest channel, 12 GHz to 25 GHz

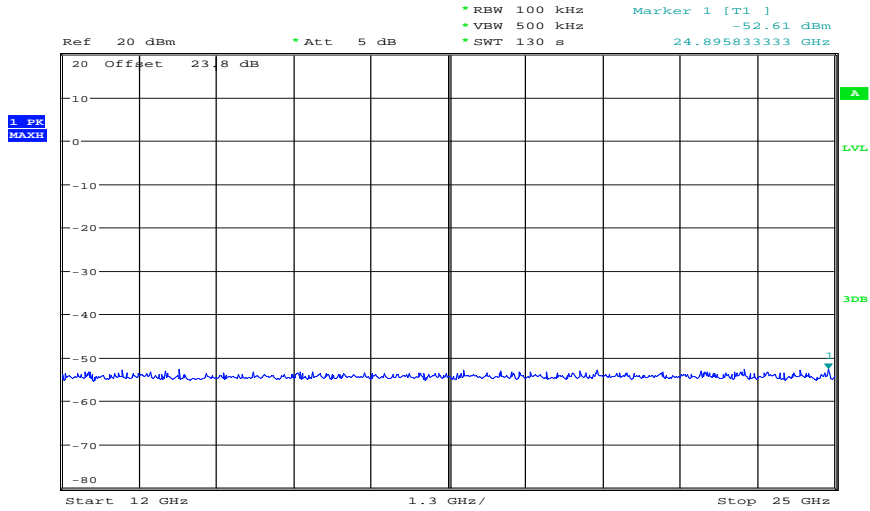

Date: 9.MAR.2012 09:34:33

Plot 4: TX mode, lowest channel, 25 GHz to 40 GHz

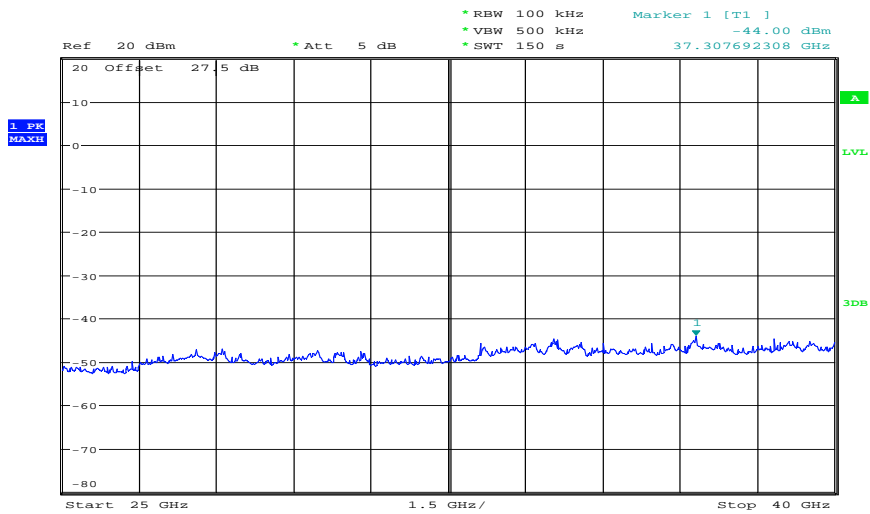

Date: 9.MAR.2012 10:02:00

Plot 5: TX mode, middle channel, 0 Hz to 1 GHz

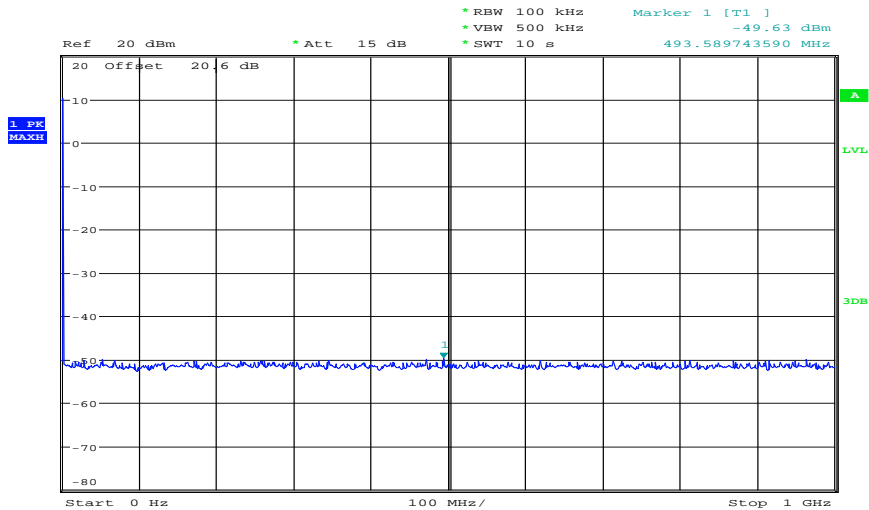

Date: 9.MAR.2012 09:08:30

The peak at the beginning of the plot is the LO from the SA.

Plot 6: TX mode, middle channel, 1 GHz to 12 GHz

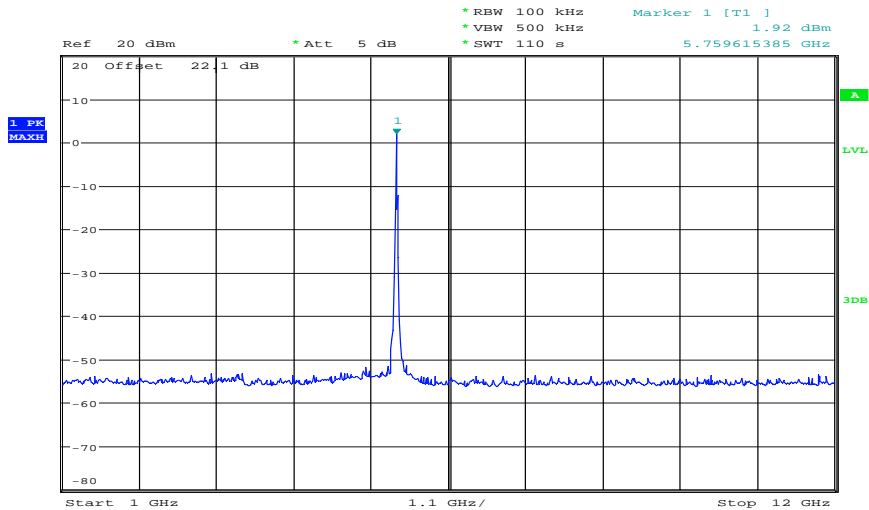

Date: 9.MAR.2012 09:25:39

Plot 7: TX mode, middle channel, 12 GHz to 25 GHz

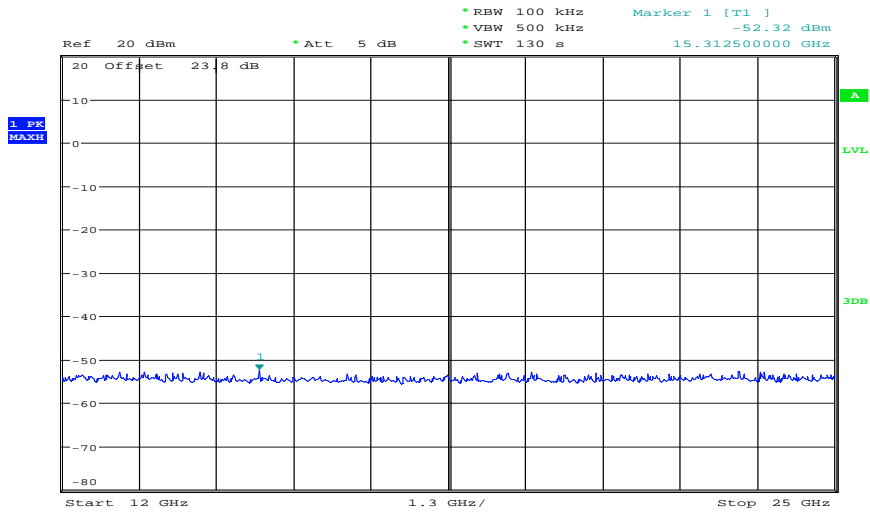

Date: 9.MAR.2012 09:37:19

Plot 8: TX mode, middle channel, 25 GHz to 40 GHz

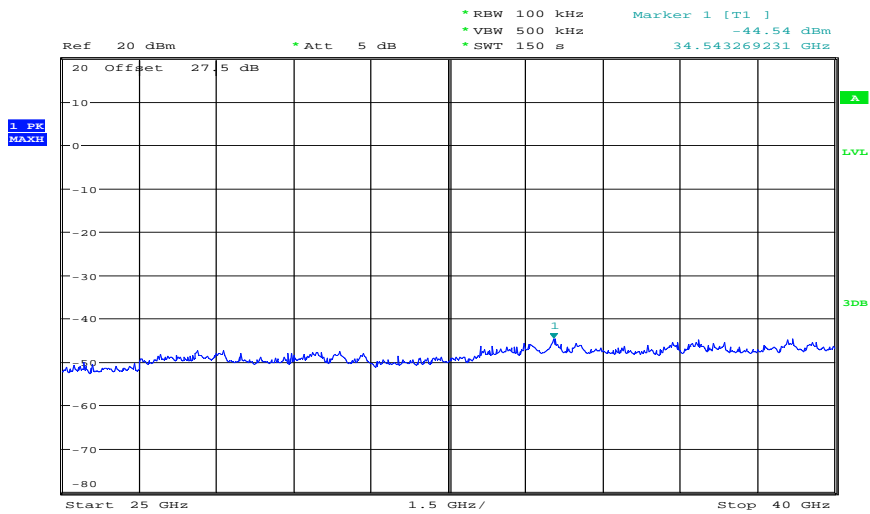

Date: 9.MAR.2012 10:05:02

Plot 9: TX mode, highest channel, 0 Hz to 1 GHz

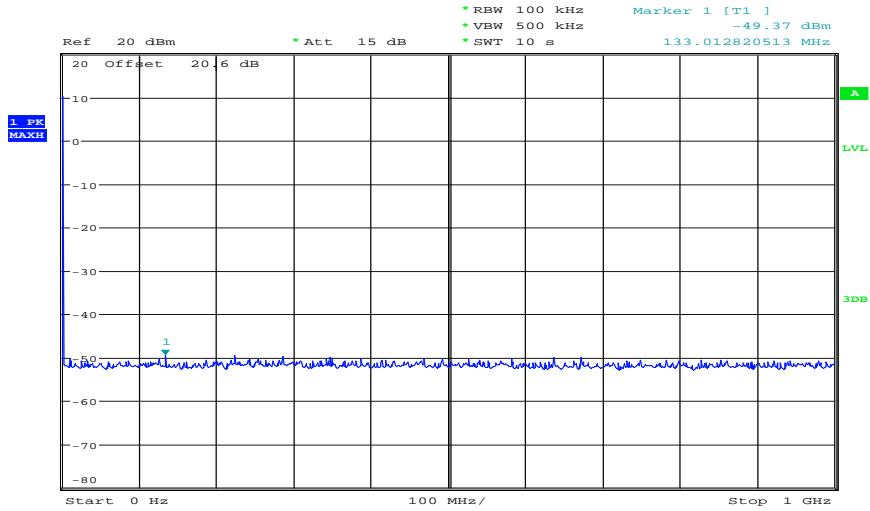

Date: 9.MAR.2012 09:09:12

The peak at the beginning of the plot is the LO from the SA.

Plot 10: TX mode, highest channel, 1 GHz to 12 GHz

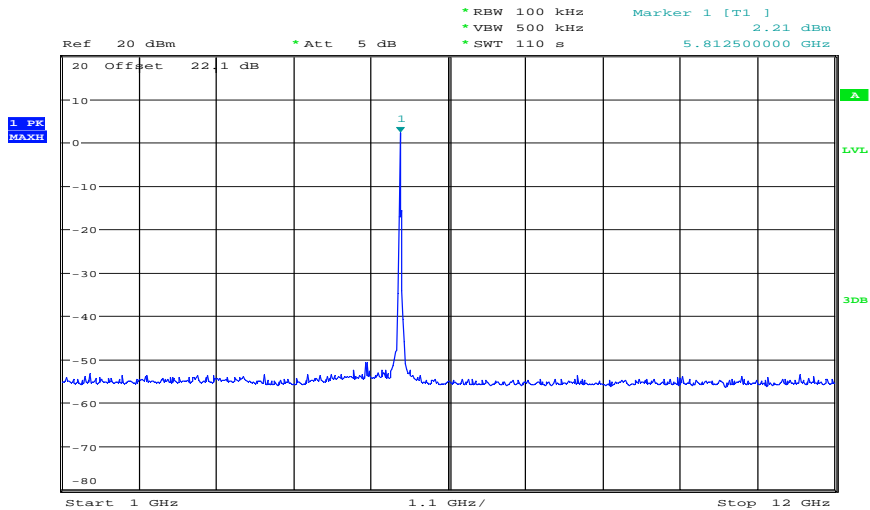

Date: 9.MAR.2012 09:27:46

Plot 11: TX mode, highest channel, 12 GHz to 25 GHz

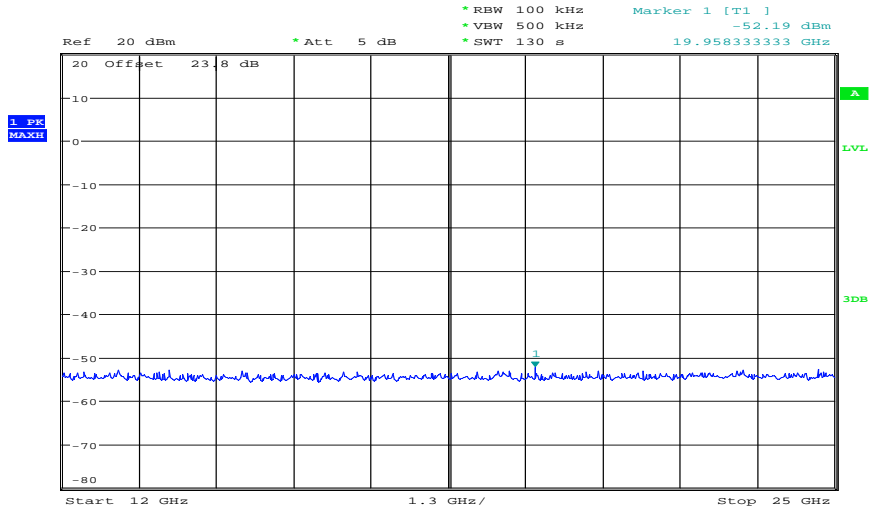

Date: 9.MAR.2012 09:39:50

Plot 12: TX mode, highest channel, 25 GHz to 40 GHz

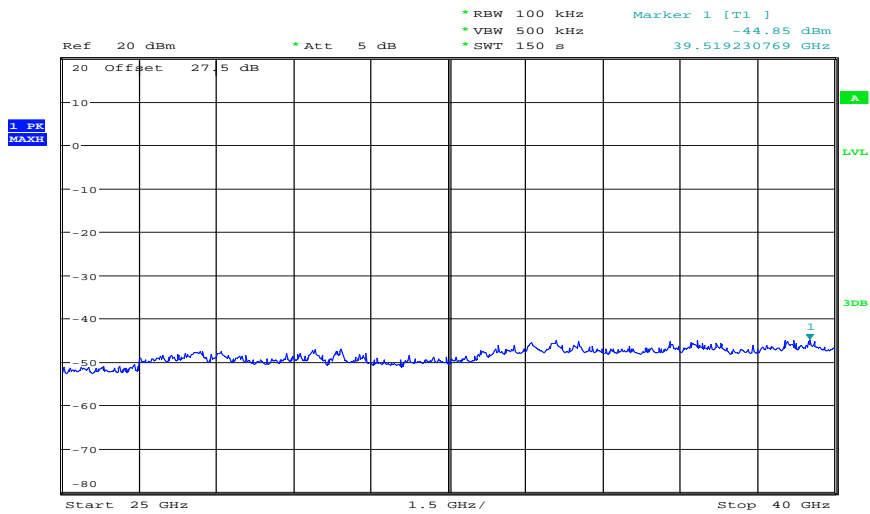

Date: 9.MAR.2012 10:08:19

9.7 TX spurious emissions radiated

Description:

Measurement of the radiated spurious emissions in transmit mode.

Measurement:

Measurement parameter	
Detector:	Peak / Quasi Peak
Sweep time:	Auto
Video bandwidth:	Sweep: 100 kHz Remeasurement: 10 Hz
Resolution bandwidth:	F < 1 GHz: 100 kHz F > 1 GHz: 1 MHz
Span:	30 MHz to 26 GHz
Trace-Mode:	Max Hold
Measured Modulation	<input checked="" type="checkbox"/> DSSS

Limits:

FCC		IC	
CFR Part 15.247(d)		RSS 210, Issue 8, A 8.5	
TX Spurious Emissions Radiated			
<p>In any 100 kHz bandwidth outside the frequency band in which the spread spectrum or digitally modulated intentional radiator is operating, the radio frequency power that is produced by the intentional radiator shall be at least 20 dB below that in the 100 kHz bandwidth within the band that contains the highest level of the desired power, based on either an RF conducted or a radiated measurement. Attenuation below the general limits specified in Section 15.209(a) is not required. In addition, radiated emissions which fall in the restricted bands, as defined in §15.205(a), must also comply with the radiated emission limits specified in §15.209(a) (see §15.205(c)).</p>			
§15.209			
Frequency (MHz)	Field Strength (dBµV/m)	Measurement distance	
30 - 88	30.0	10	
88 – 216	33.5	10	
216 – 960	36.0	10	
Above 960	54.0	3	

Results: Rod antenna A

TX Spurious Emissions Radiated [dBµV/m]								
DSSS – mode								
5736 MHz			5762 MHz			5814 MHz		
F [MHz]	Detector	Level [dBµV/m]	F [MHz]	Detector	Level [dBµV/m]	F [MHz]	Detector	Level [dBµV/m]
3824	Peak	51.30	3850	Peak	51.70	3875	Peak	48.16
Measurement uncertainty			± 3 dB					

Result: Passed

Results: Rod antenna B

TX Spurious Emissions Radiated [dBµV/m]								
DSSS – mode								
5736 MHz			5762 MHz			5814 MHz		
F [MHz]	Detector	Level [dBµV/m]	F [MHz]	Detector	Level [dBµV/m]	F [MHz]	Detector	Level [dBµV/m]
3824	Peak	50.20	3850	Peak	50.00	3876	Peak	48.29
Measurement uncertainty			± 3 dB					

Result: Passed

Results: Planar antenna A

TX Spurious Emissions Radiated [dBµV/m]								
DSSS – mode								
5736 MHz			5762 MHz			5814 MHz		
F [MHz]	Detector	Level [dBµV/m]	F [MHz]	Detector	Level [dBµV/m]	F [MHz]	Detector	Level [dBµV/m]
Measurement uncertainty			± 3 dB					

Result: Passed

Results: Planar antenna B

TX Spurious Emissions Radiated [dBµV/m]								
DSSS – mode								
5736 MHz			5762 MHz			5814 MHz		
F [MHz]	Detector	Level [dBµV/m]	F [MHz]	Detector	Level [dBµV/m]	F [MHz]	Detector	Level [dBµV/m]
Measurement uncertainty			± 3 dB					

Result: Passed

Results: Omnidirectional antenna A

TX Spurious Emissions Radiated [dBµV/m]								
DSSS – mode								
5736 MHz			5762 MHz			5814 MHz		
F [MHz]	Detector	Level [dBµV/m]	F [MHz]	Detector	Level [dBµV/m]	F [MHz]	Detector	Level [dBµV/m]
Measurement uncertainty			± 3 dB					

Result: Passed

Results: Omnidirectional antenna B

TX Spurious Emissions Radiated [dBµV/m]								
DSSS – mode								
5736 MHz			5762 MHz			5814 MHz		
F [MHz]	Detector	Level [dBµV/m]	F [MHz]	Detector	Level [dBµV/m]	F [MHz]	Detector	Level [dBµV/m]
Measurement uncertainty			± 3 dB					

Result: Passed

Plots: Rod antenna A

Plot 1: Lowest channel, 30 MHz to 1 GHz, vertical & horizontal polarization

Common Information

EUT: Quinta CU
 Serial Number: 00101
 Test Description: FCC part 15 class B @ 10 m
 Operating Conditions: ANT A, tx@5736MHz
 Operator Name: Hennemann
 Comment: AC: 115 V / 60 Hz; ETH-cable S/FTP

Scan Setup: STAN_Fin [EMI radiated]

Hardware Setup: Electric Field (NOS)
 Receiver: [ESCI 3]
 Level Unit: dBµV/m
Subrange **Step Size** **Detectors** **IF BW** **Meas. Time** **Preamp**
 30 MHz - 2 GHz 60 kHz QPK 120 kHz 1 s 20 dB

FCC_10m(B)_3

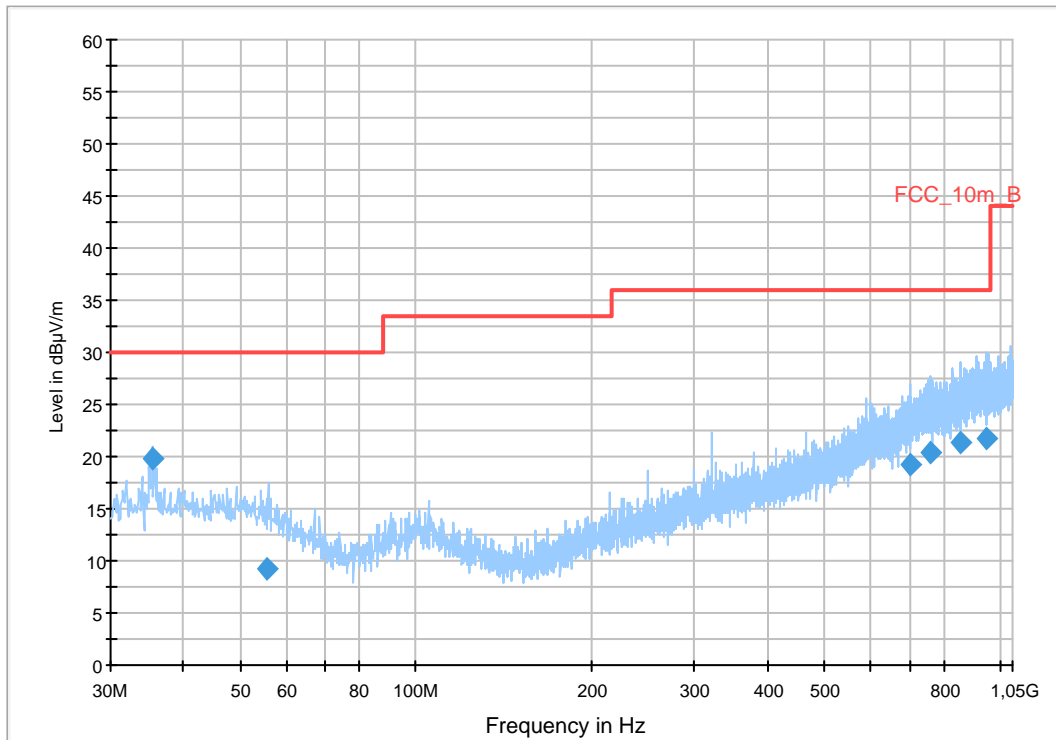

Final Result 1

Frequency (MHz)	QuasiPeak (dBµV/m)	Meas. Time (ms)	Bandwidth (kHz)	Height (cm)	Polarization	Azimuth (deg)	Corr. (dB)	Margin (dB)	Limit (dBµV/m)	Comment
35.368350	19.7	1000.0	120.000	112.0	V	8.0	13.1	10.3	30.0	
55.447200	9.1	1000.0	120.000	170.0	V	183.0	12.8	20.9	30.0	
703.183050	19.3	1000.0	120.000	98.0	H	8.0	22.6	16.7	36.0	
761.253600	20.3	1000.0	120.000	124.0	H	185.0	23.7	15.7	36.0	
853.907250	21.3	1000.0	120.000	170.0	H	283.0	24.6	14.7	36.0	
944.296650	21.8	1000.0	120.000	113.0	V	185.0	25.3	14.2	36.0	

Plot 2: Lowest channel, 1 GHz to 12.75 GHz, vertical polarization

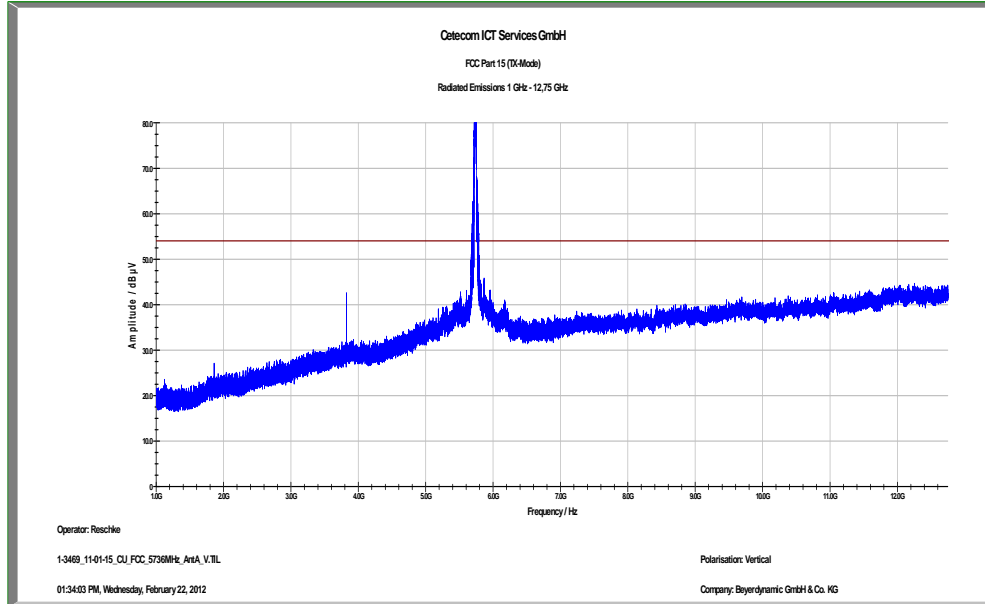

Plot 3: Lowest channel, 1 GHz to 12.75 GHz, horizontal polarization

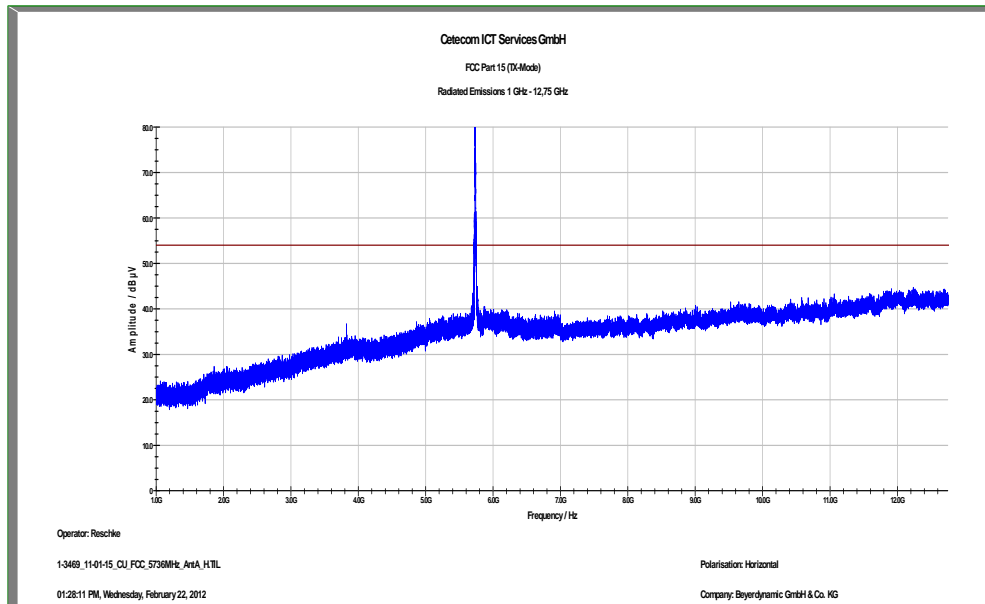

Plot 4: Lowest channel, 12.75 GHz to 18 GHz, vertical & horizontal polarization

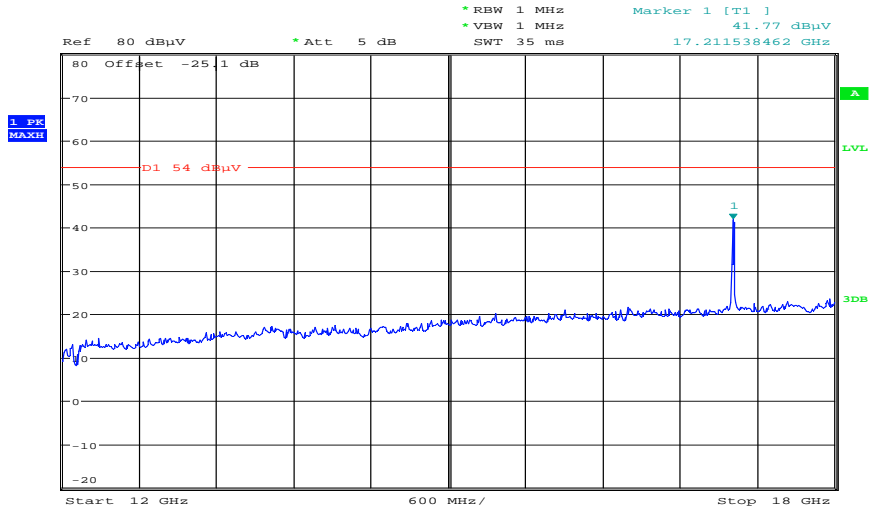

Date: 12.MAR.2012 13:06:55

Plot 5: Lowest channel, 18 GHz to 25 GHz, vertical & horizontal polarization

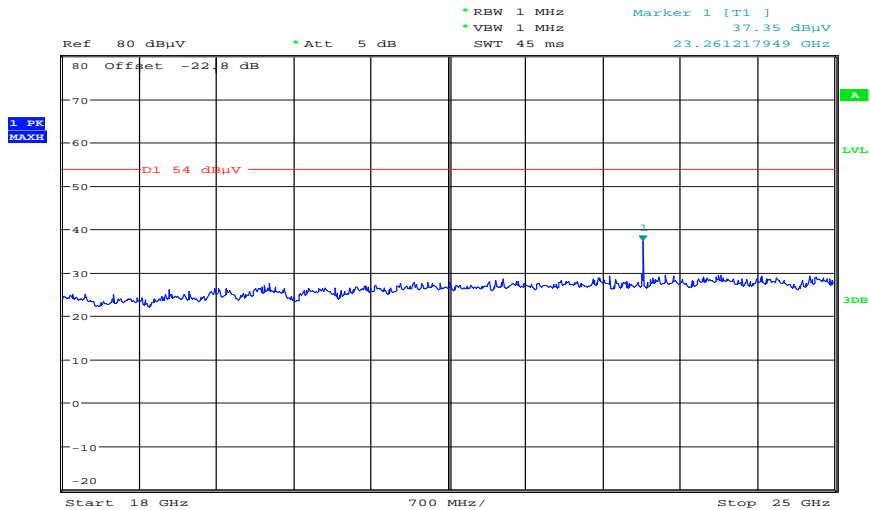

Date: 12.MAR.2012 10:35:55

Plot 6: Lowest channel, 25 GHz to 40 GHz, vertical & horizontal polarization

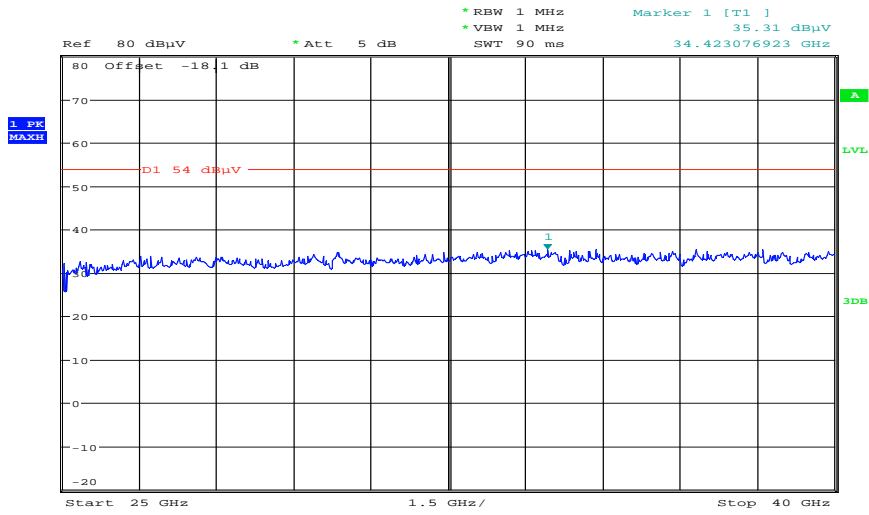

Date: 12.MAR.2012 10:46:05

Plot 7: Middle channel, 30 MHz to 1 GHz, vertical & horizontal polarization

Common Information

EUT: Quinta CU
 Serial Number: 00101
 Test Description: FCC part 15 class B @ 10 m
 Operating Conditions: ANT A, tx@5762MHz
 Operator Name: Hennemann
 Comment: AC: 115 V / 60 Hz; ETH-cable S/FTP

Scan Setup: STAN_Fin [EMI radiated]

Hardware Setup: Electric Field (NOS)
 Receiver: [ESCI 3]
 Level Unit: dBµV/m

Subrange	Step Size	Detectors	IF BW	Meas. Time	Preamp
30 MHz - 2 GHz	60 kHz	QPK	120 kHz	1 s	20 dB

FCC_10m(B)_3

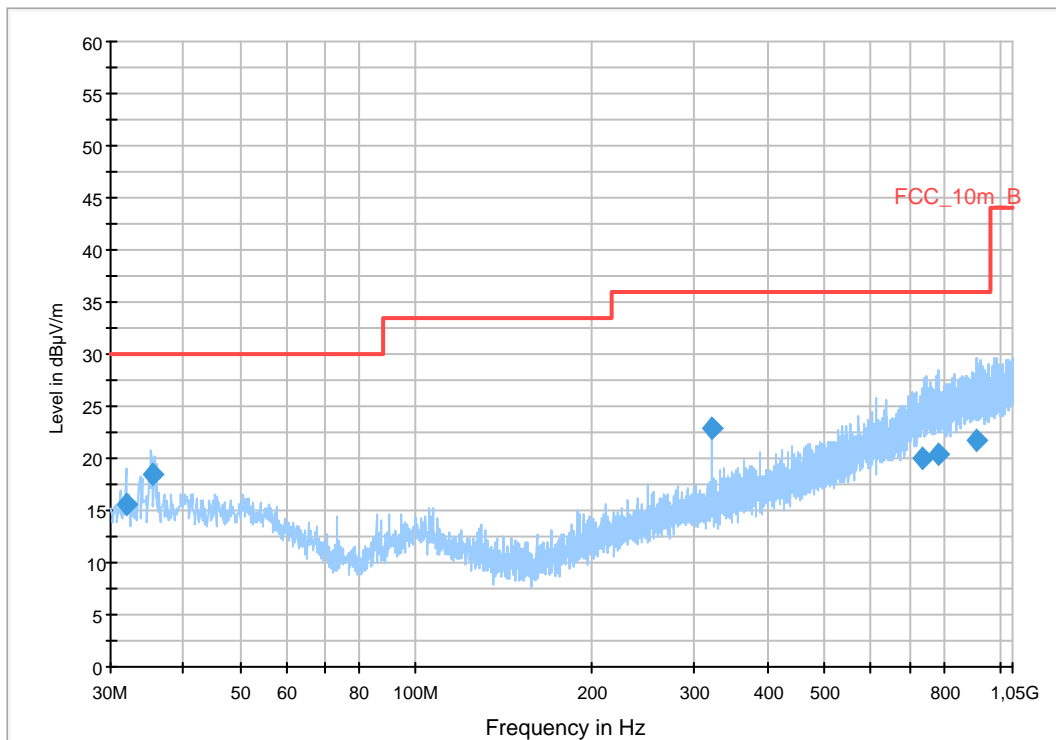

Final Result 1

Frequency (MHz)	QuasiPeak (dBµV/m)	Meas. Time (ms)	Bandwidth (kHz)	Height (cm)	Polarization	Azimuth (deg)	Corr. (dB)	Margin (dB)	Limit (dBµV/m)	Comment
31.967250	15.5	1000.0	120.000	98.0	V	106.0	12.7	14.5	30.0	
35.360850	18.5	1000.0	120.000	170.0	V	184.0	13.1	11.5	30.0	
320.035800	22.8	1000.0	120.000	98.0	V	260.0	15.2	13.2	36.0	
733.333650	20.0	1000.0	120.000	164.0	H	283.0	23.3	16.0	36.0	
782.158950	20.3	1000.0	120.000	164.0	V	8.0	23.7	15.7	36.0	
914.107350	21.8	1000.0	120.000	170.0	H	273.0	25.2	14.2	36.0	

Plot 8: Middle channel, 1 GHz to 12.75 GHz, vertical polarization

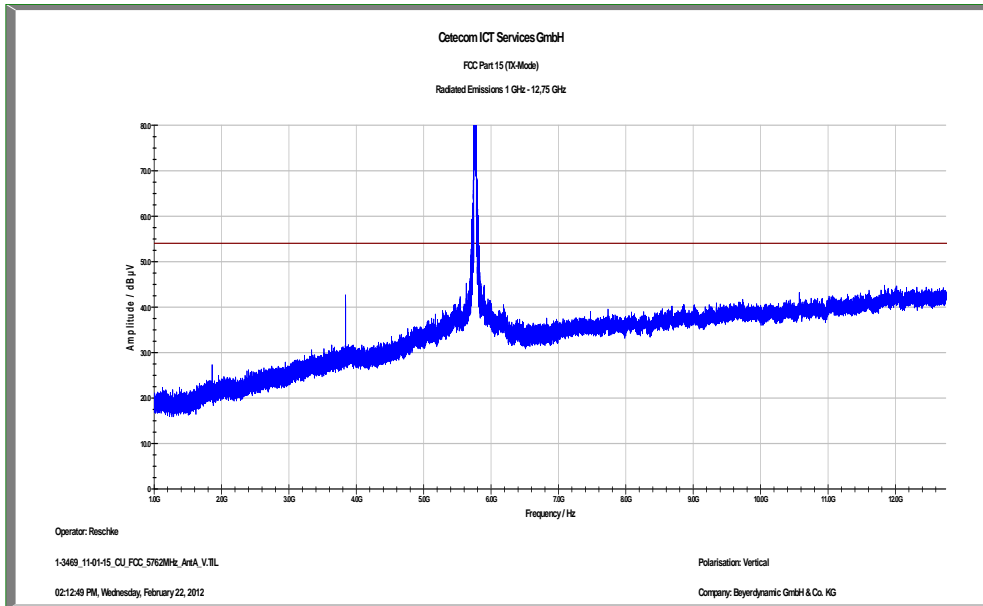

Plot 9: Middle channel, 1 GHz to 12.75 GHz, horizontal polarization

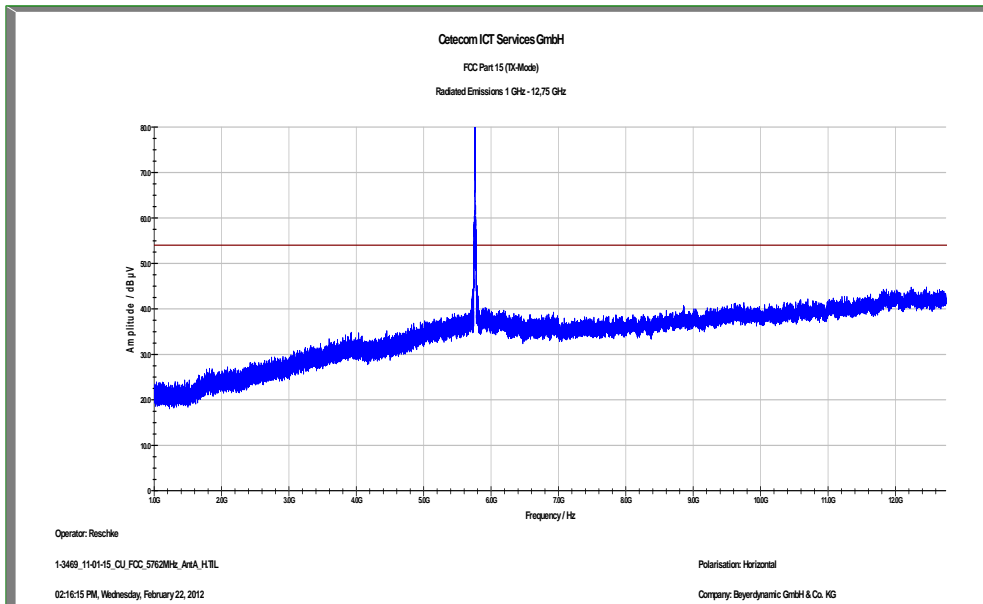

Plot 10: Middle channel, 12.75 GHz to 18 GHz, vertical & horizontal polarization

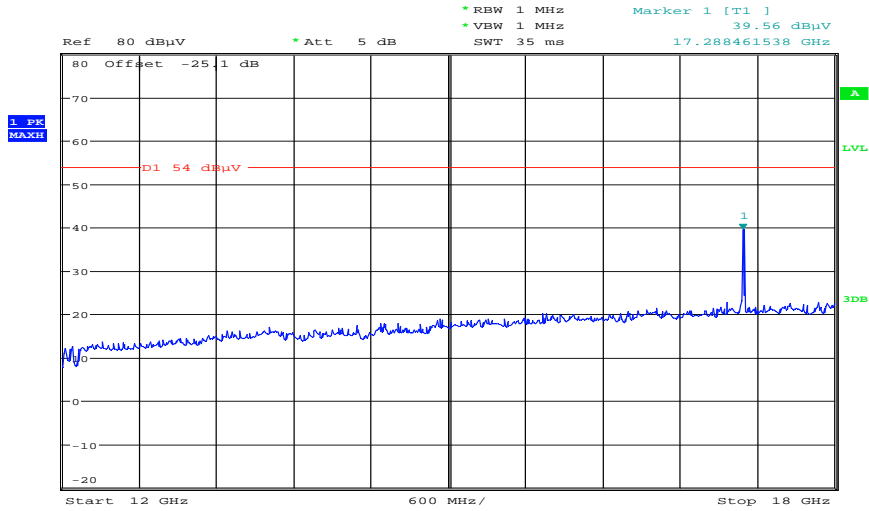

Date: 12.MAR.2012 13:07:30

Plot 11: Middle channel, 18 GHz to 25 GHz, vertical & horizontal polarization

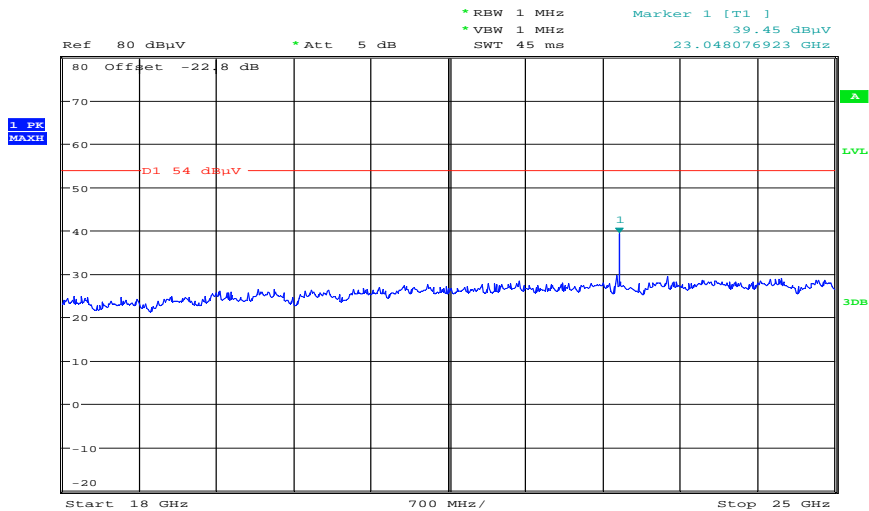

Date: 12.MAR.2012 10:36:29

Plot 12: Middle channel, 25 GHz to 40 GHz, vertical & horizontal polarization

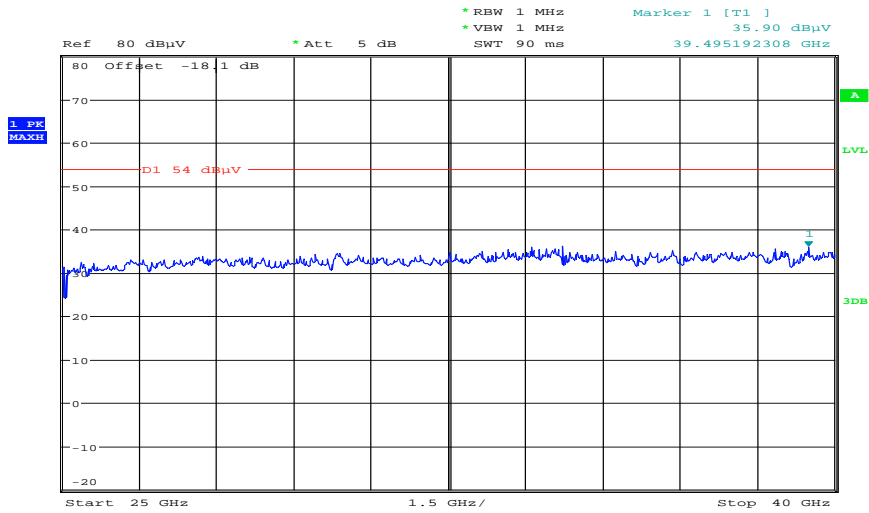

Date: 12.MAR.2012 10:46:45

Plot 13: Highest channel, 30 MHz to 1 GHz, vertical & horizontal polarization

Common Information

EUT: Quinta CU
 Serial Number: 00101
 Test Description: FCC part 15 class B @ 10 m
 Operating Conditions: ANT A, tx@5814MHz
 Operator Name: Hennemann
 Comment: AC: 115 V / 60 Hz; ETH-cable S/FTP

Scan Setup: STAN_Fin [EMI radiated]

Hardware Setup: Electric Field (NOS)
 Receiver: [ESCI 3]
 Level Unit: dBµV/m

Subrange	Step Size	Detectors	IF BW	Meas. Time	Preamp
30 MHz - 2 GHz	60 kHz	QPK	120 kHz	1 s	20 dB

FCC_10m(B)_3

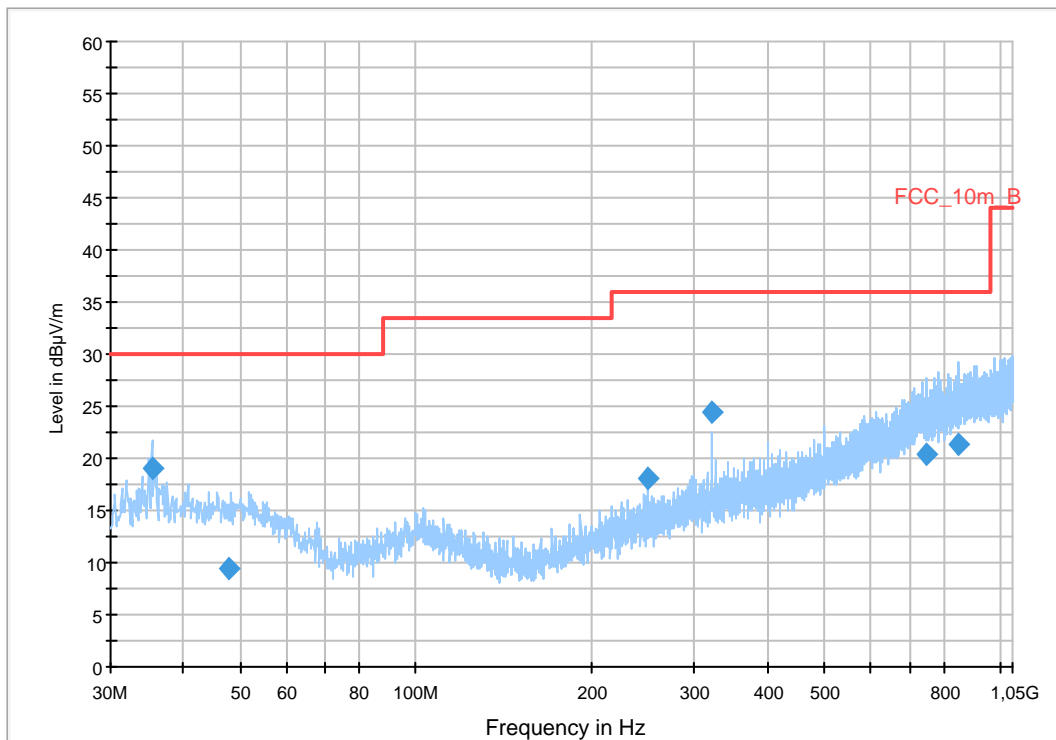

Final Result 1

Frequency (MHz)	QuasiPeak (dBµV/m)	Meas. Time (ms)	Bandwidth (kHz)	Height (cm)	Polarization	Azimuth (deg)	Corr. (dB)	Margin (dB)	Limit (dBµV/m)	Comment
35.369250	19.0	1000.0	120.000	161.0	V	8.0	13.1	11.0	30.0	
47.788200	9.4	1000.0	120.000	126.0	V	283.0	13.3	20.6	30.0	
250.004100	18.1	1000.0	120.000	98.0	V	8.0	13.3	17.9	36.0	
319.987200	24.4	1000.0	120.000	98.0	V	196.0	15.2	11.6	36.0	
748.822200	20.3	1000.0	120.000	106.0	H	260.0	23.6	15.7	36.0	
851.135100	21.3	1000.0	120.000	170.0	V	260.0	24.6	14.7	36.0	

Plot 14: Highest channel, 1 GHz to 12.75 GHz, vertical polarization

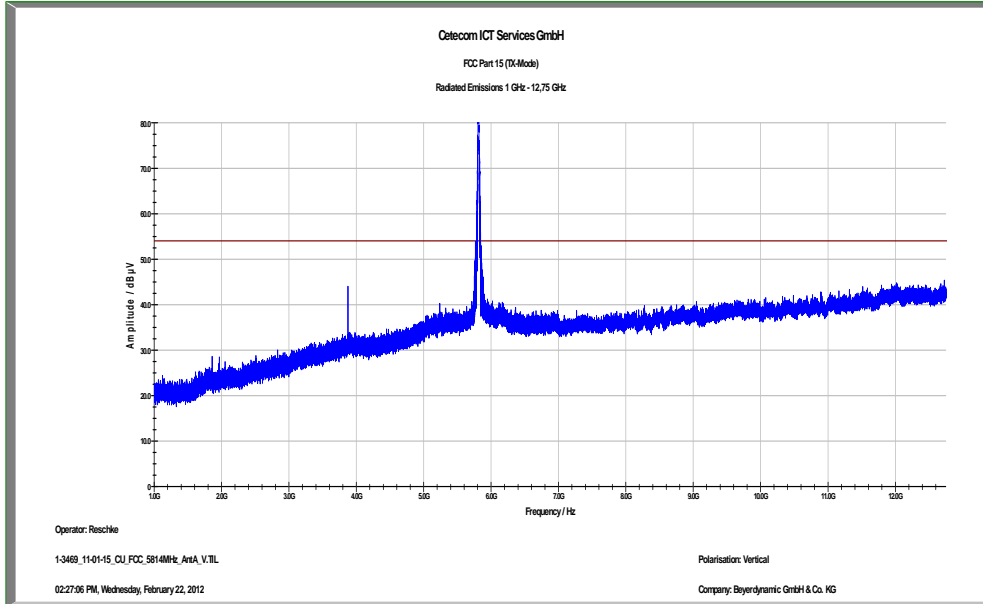

Plot 15: Highest channel, 1 GHz to 12.75 GHz, horizontal polarization

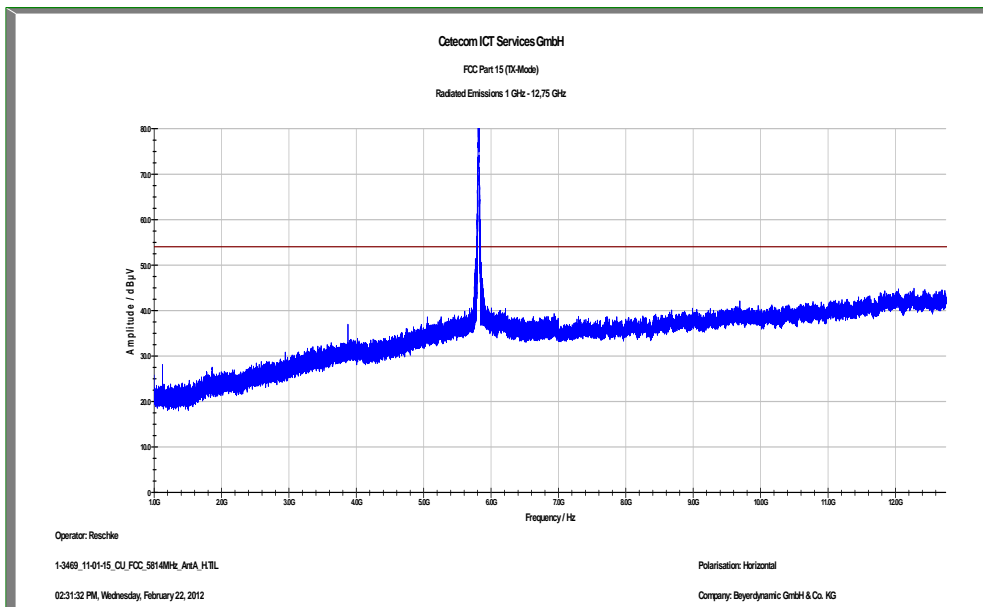

Plot 16: Highest channel, 12.75 GHz to 18 GHz, vertical & horizontal polarization

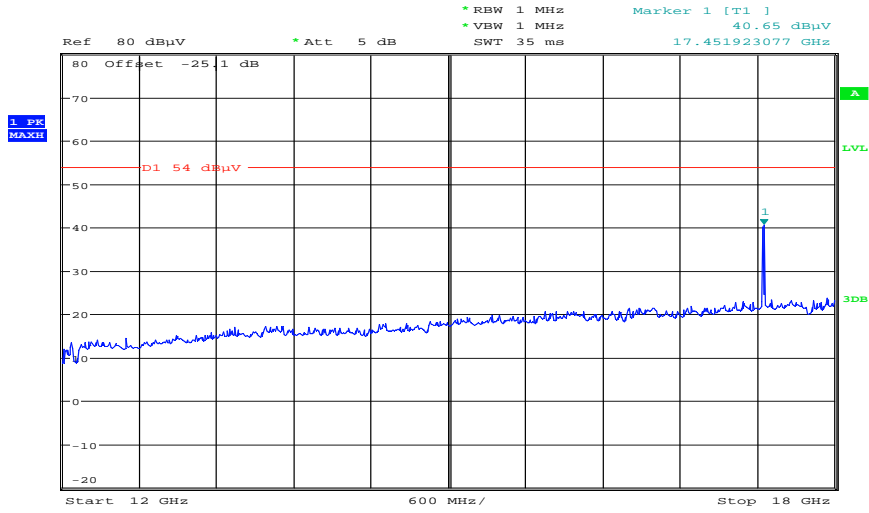

Date: 12.MAR.2012 13:09:21

Plot 17: Highest channel, 18 GHz to 25 GHz, vertical & horizontal polarization

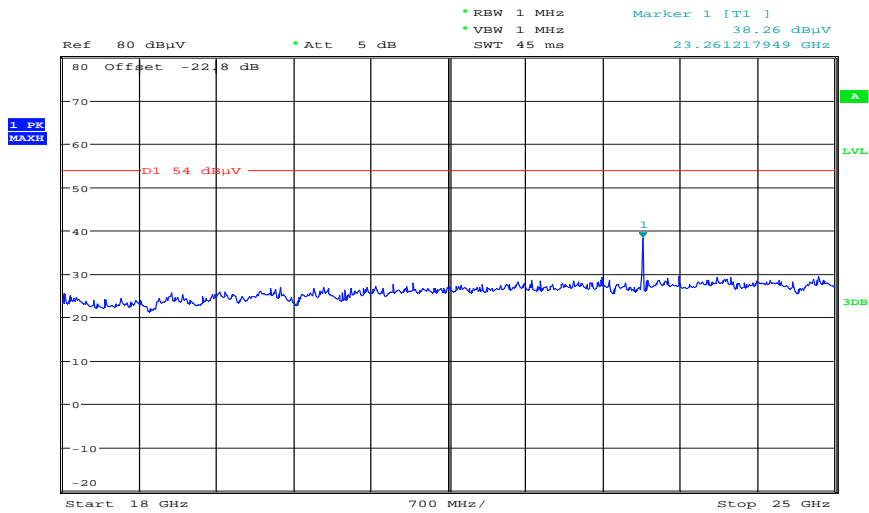

Date: 12.MAR.2012 10:37:10

Plot 18: Highest channel, 25 GHz to 40 GHz, vertical & horizontal polarization

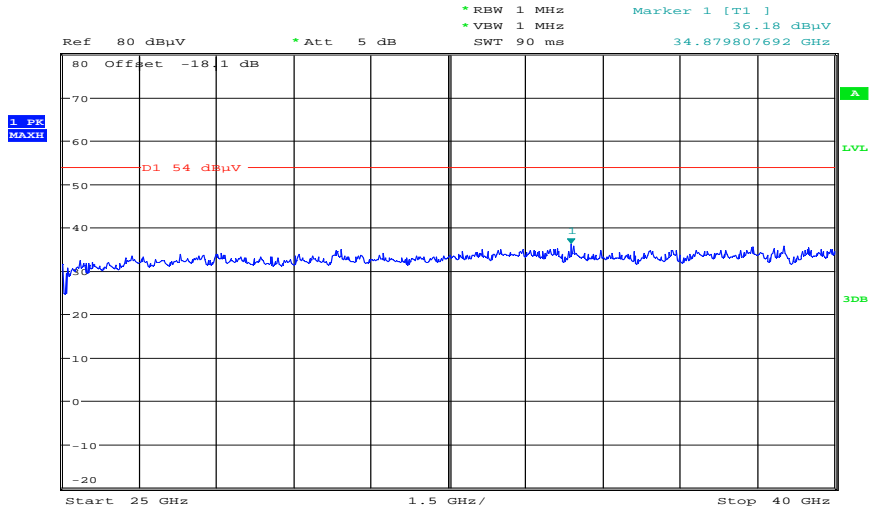

Date: 12.MAR.2012 10:47:24

Plots: Rod antenna B

Plot 1: Lowest channel, 30 MHz to 1 GHz, vertical & horizontal polarization

Common Information

EUT: Quinta CU
 Serial Number: 00101
 Test Description: FCC part 15 class B @ 10 m
 Operating Conditions: ANT B, tx@5736MHz
 Operator Name: Hennemann
 Comment: AC: 115 V / 60 Hz; ETH-cable S/FTP

Scan Setup: STAN_Fin [EMI radiated]

Hardware Setup: Electric Field (NOS)
 Receiver: [ESCI 3]
 Level Unit: dBµV/m
Subrange **Step Size** **Detectors** **IF BW** **Meas. Time** **Preamp**
 30 MHz - 2 GHz 60 kHz QPK 120 kHz 1 s 20 dB

FCC_10m(B)_3

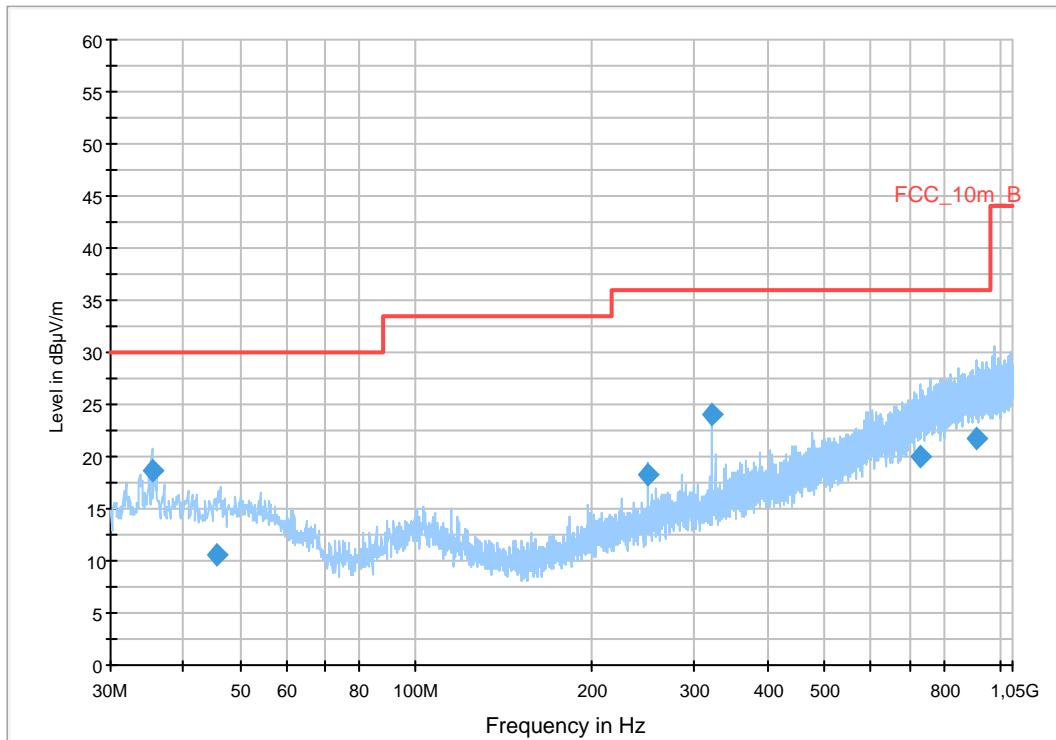

Final Result 1

Frequency (MHz)	QuasiPeak (dBµV/m)	Meas. Time (ms)	Bandwidth (kHz)	Height (cm)	Polarization	Azimuth (deg)	Corr. (dB)	Margin (dB)	Limit (dBµV/m)	Comment
35.361450	18.7	1000.0	120.000	135.0	V	196.0	13.1	11.3	30.0	
45.747000	10.6	1000.0	120.000	170.0	V	8.0	13.3	19.4	30.0	
249.997350	18.3	1000.0	120.000	98.0	V	8.0	13.3	17.7	36.0	
319.993050	24.1	1000.0	120.000	98.0	V	258.0	15.2	11.9	36.0	
732.477150	20.0	1000.0	120.000	170.0	H	196.0	23.3	16.0	36.0	
910.845300	21.7	1000.0	120.000	124.0	H	196.0	25.2	14.3	36.0	

Plot 2: Lowest channel, 1 GHz to 12.75 GHz, vertical polarization

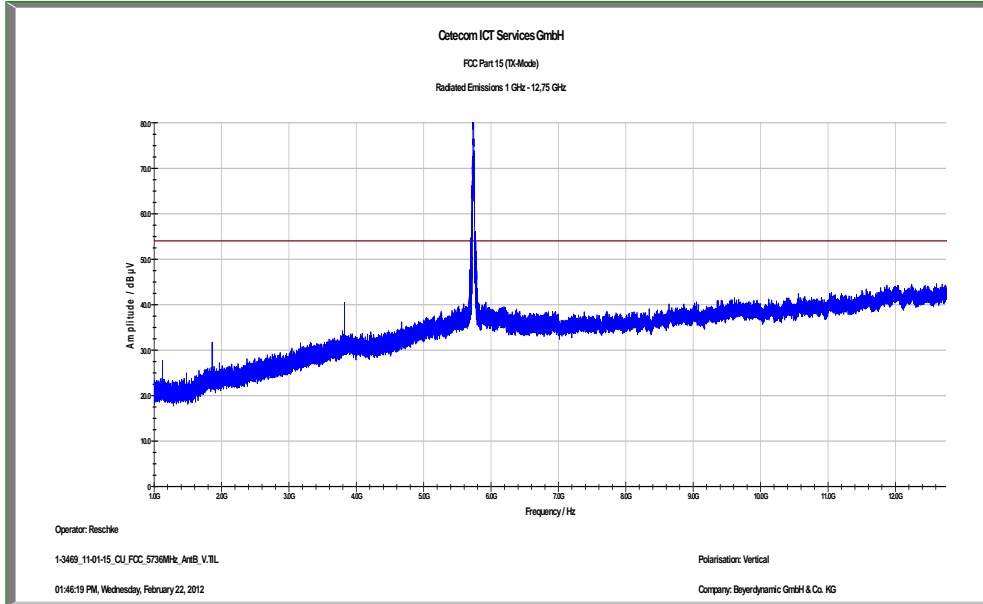

Plot 3: Lowest channel, 1 GHz to 12.75 GHz, horizontal polarization

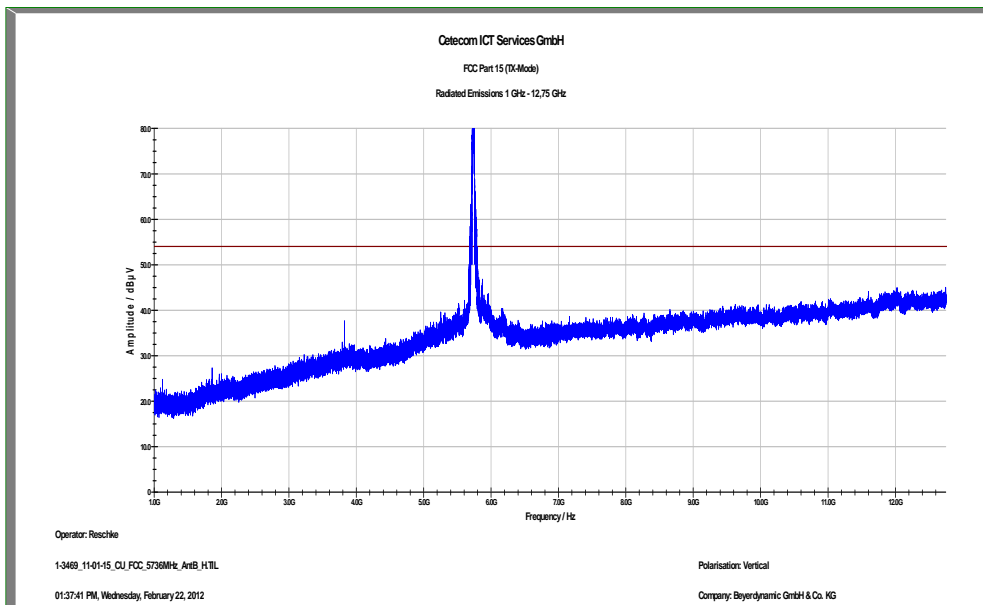

Plot 4: Lowest channel, 12.75 GHz to 18 GHz, vertical & horizontal polarization

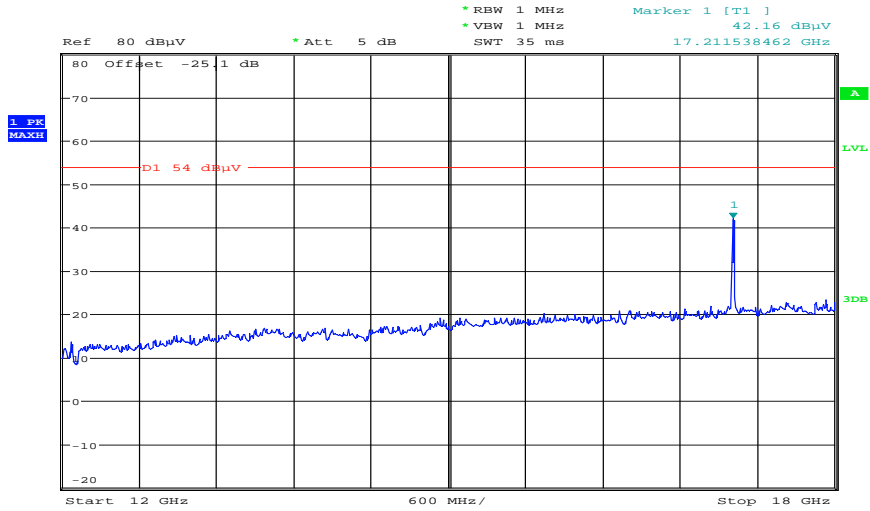

Date: 12.MAR.2012 13:09:59

Plot 5: Lowest channel, 18 GHz to 25 GHz, vertical & horizontal polarization

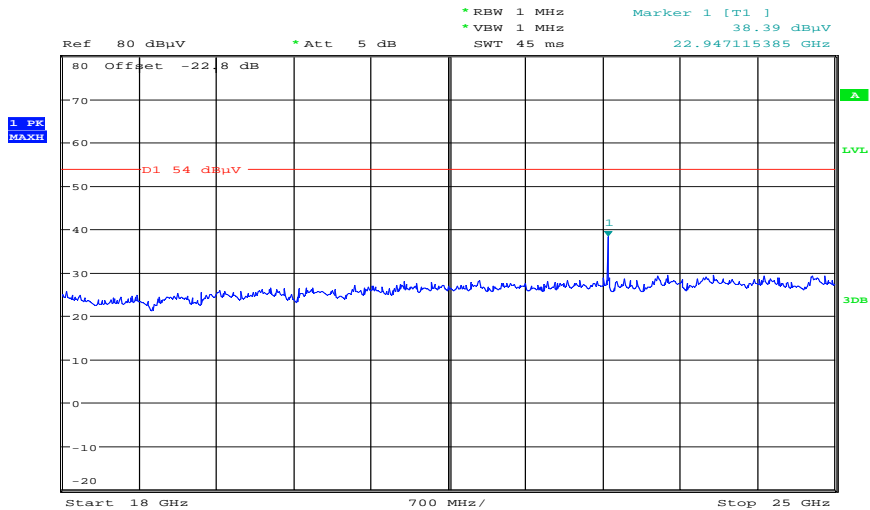

Date: 12.MAR.2012 10:38:26

Plot 6: Lowest channel, 25 GHz to 40 GHz, vertical & horizontal polarization

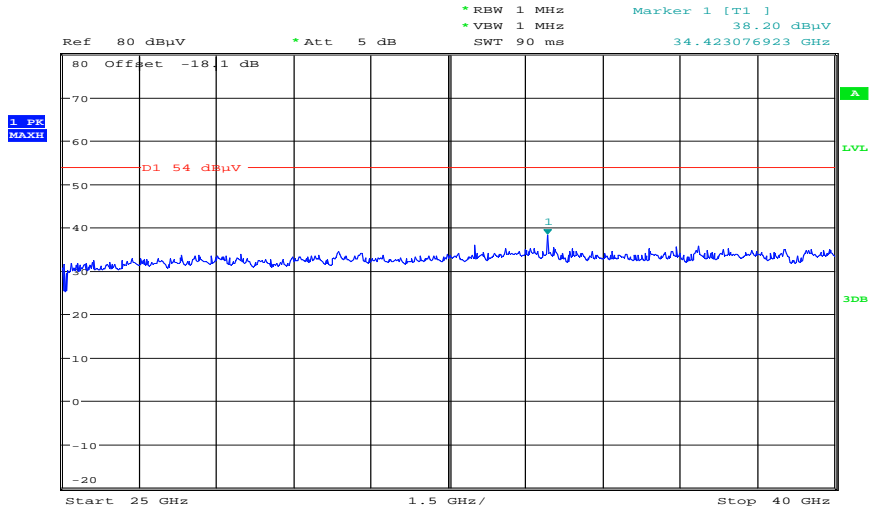

Date: 12.MAR.2012 10:45:25

Plot 7: Middle channel, 30 MHz to 1 GHz, vertical & horizontal polarization

Common Information

EUT: Quinta CU
 Serial Number: 00101
 Test Description: FCC part 15 class B @ 10 m
 Operating Conditions: ANT B, tx@5762MHz
 Operator Name: Hennemann
 Comment: AC: 115 V / 60 Hz; ETH-cable S/FTP

Scan Setup: STAN_Fin [EMI radiated]

Hardware Setup: Electric Field (NOS)
 Receiver: [ESCI 3]
 Level Unit: dBµV/m

Subrange	Step Size	Detectors	IF BW	Meas. Time	Preamp
30 MHz - 2 GHz	60 kHz	QPK	120 kHz	1 s	20 dB

FCC_10m(B)_3

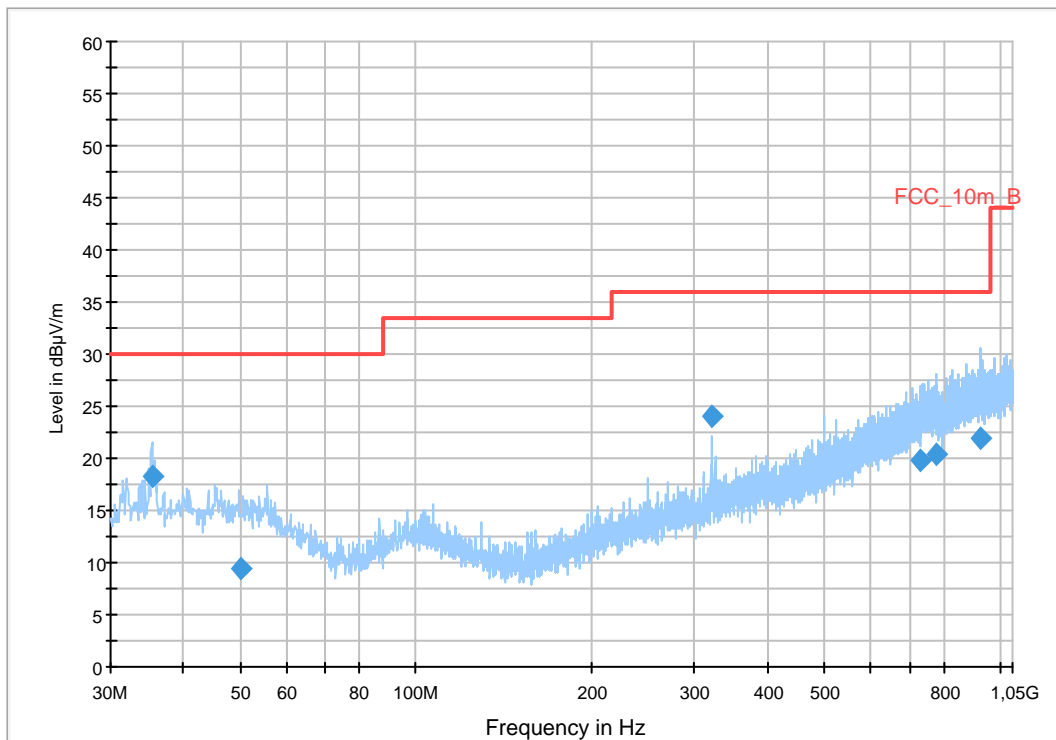

Final Result 1

Frequency (MHz)	QuasiPeak (dBµV/m)	Meas. Time (ms)	Bandwidth (kHz)	Height (cm)	Polarization	Azimuth (deg)	Corr. (dB)	Margin (dB)	Limit (dBµV/m)	Comment
35.366700	18.2	1000.0	120.000	170.0	V	102.0	13.1	11.8	30.0	
49.948650	9.5	1000.0	120.000	135.0	H	102.0	13.4	20.5	30.0	
320.005950	24.0	1000.0	120.000	98.0	V	259.0	15.2	12.0	36.0	
730.830450	19.9	1000.0	120.000	170.0	H	267.0	23.2	16.1	36.0	
779.732550	20.3	1000.0	120.000	164.0	H	76.0	23.7	15.7	36.0	
924.143850	21.8	1000.0	120.000	170.0	V	259.0	25.3	14.2	36.0	

Plot 8: Middle channel, 1 GHz to 12.75 GHz, vertical polarization

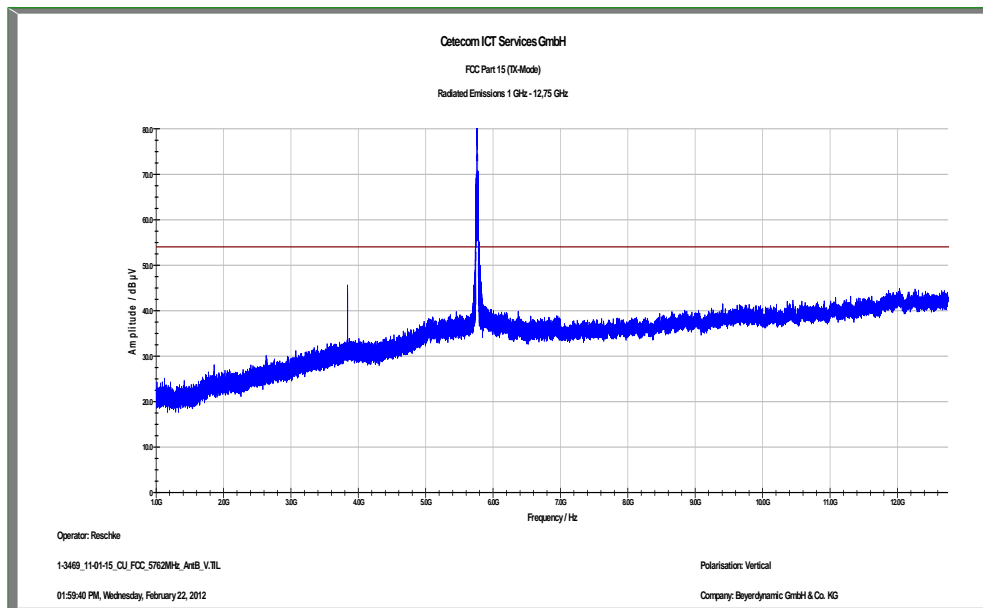

Plot 9: Middle channel, 1 GHz to 12.75 GHz, horizontal polarization

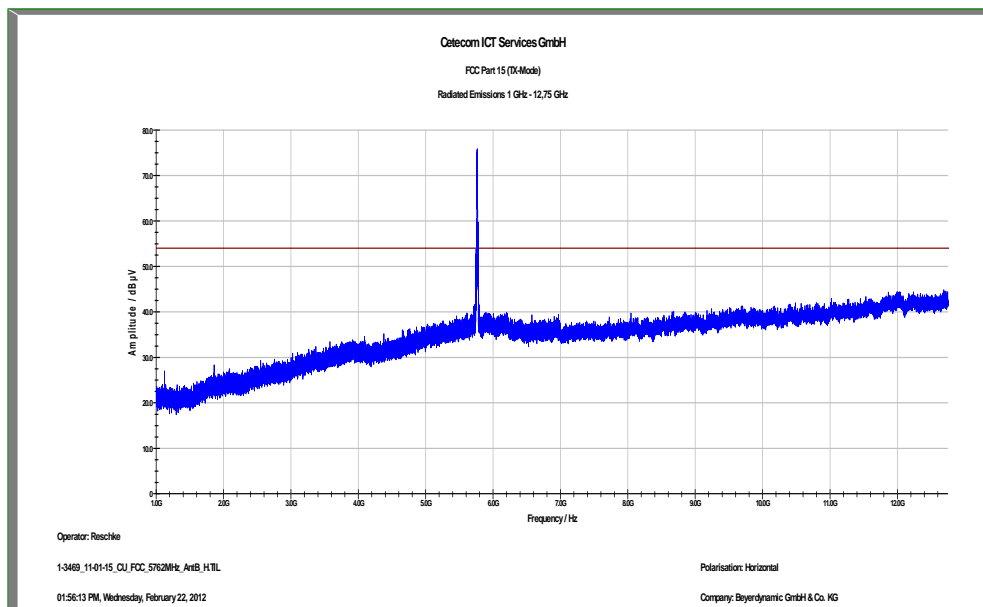

Plot 10: Middle channel, 12.75 GHz to 18 GHz, vertical & horizontal polarization

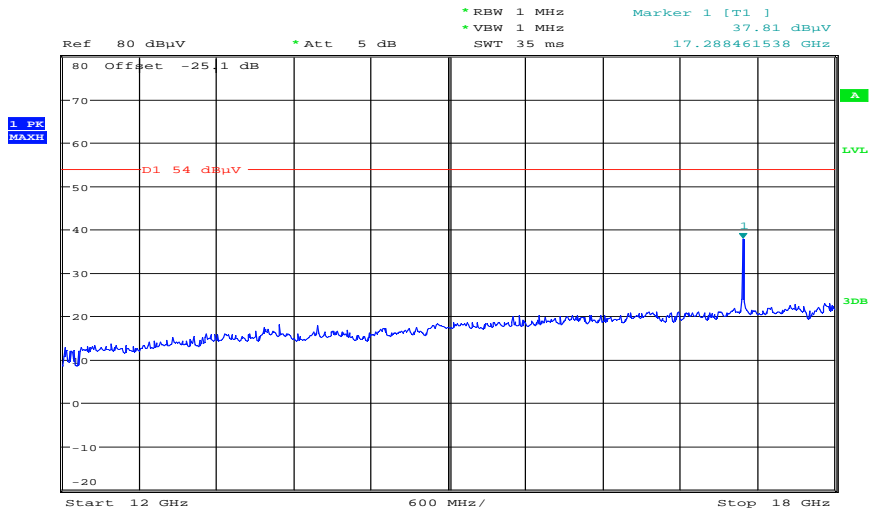

Date: 12.MAR.2012 13:10:52

Plot 11: Middle channel, 18 GHz to 25 GHz, vertical & horizontal polarization

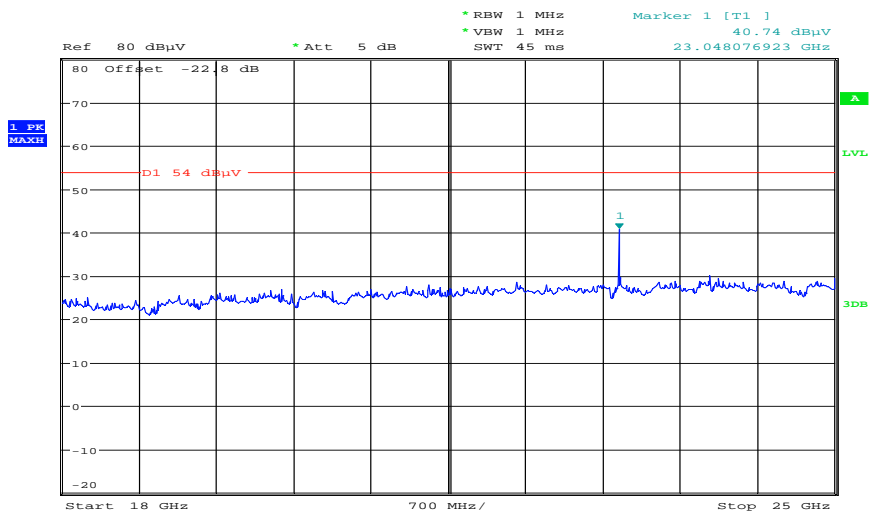

Date: 12.MAR.2012 10:38:57

Plot 12: Middle channel, 25 GHz to 40 GHz, vertical & horizontal polarization

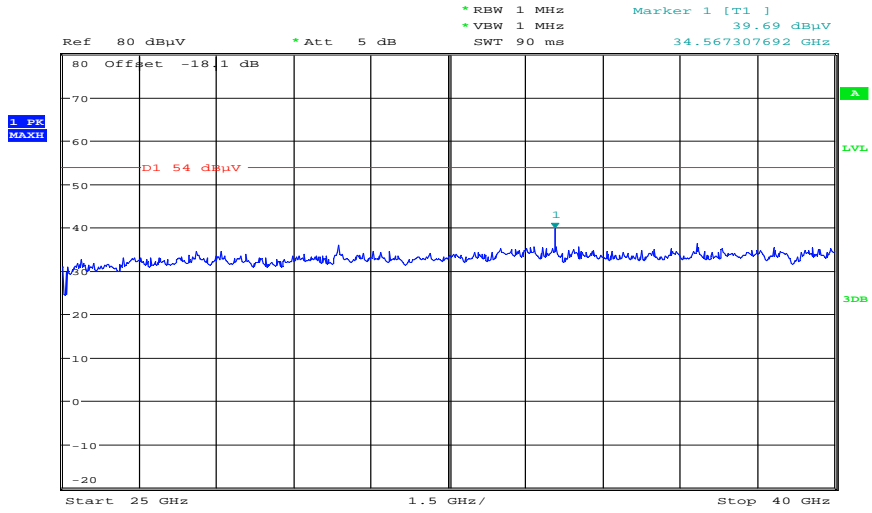

Date: 12.MAR.2012 10:44:51

Plot 13: Highest channel, 30 MHz to 1 GHz, vertical & horizontal polarization

Common Information

EUT: Quinta CU
 Serial Number: 00101
 Test Description: FCC part 15 class B @ 10 m
 Operating Conditions: ANT B, tx@5814MHz
 Operator Name: Hennemann
 Comment: AC: 115 V / 60 Hz; ETH-cable S/FTP

Scan Setup: STAN_Fin [EMI radiated]

Hardware Setup: Electric Field (NOS)
 Receiver: [ESCI 3]
 Level Unit: dBµV/m

Subrange	Step Size	Detectors	IF BW	Meas. Time	Preamp
30 MHz - 2 GHz	60 kHz	QPK	120 kHz	1 s	20 dB

FCC_10m(B)_3

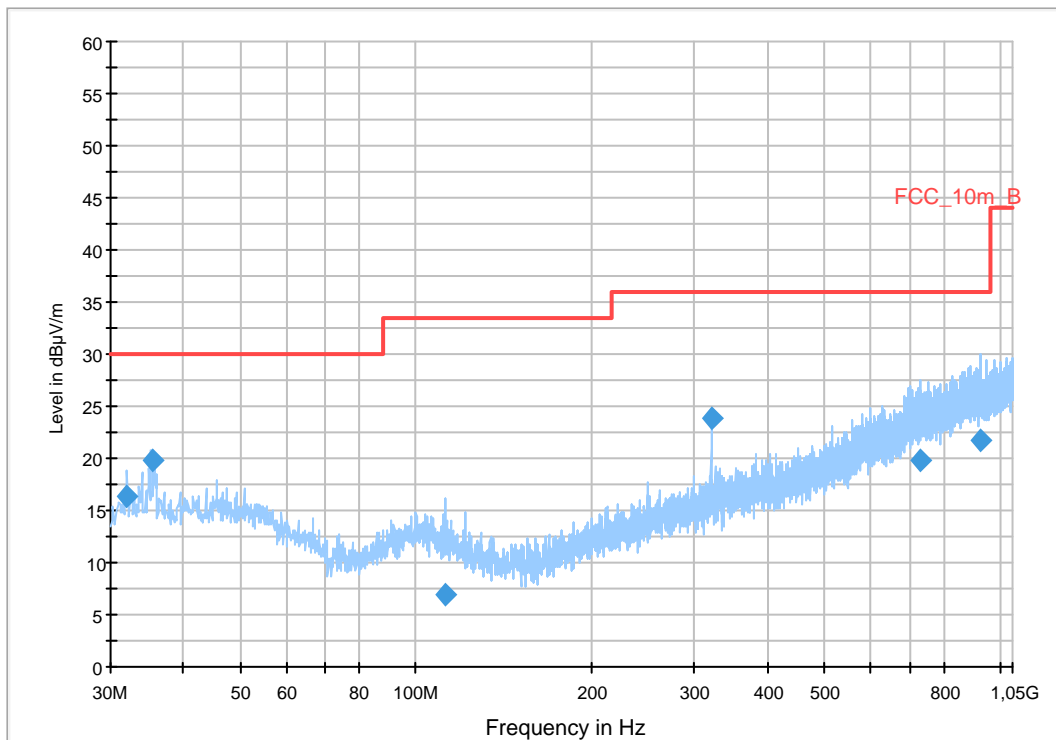

Final Result 1

Frequency (MHz)	QuasiPeak (dBµV/m)	Meas. Time (ms)	Bandwidth (kHz)	Height (cm)	Polarization	Azimuth (deg)	Corr. (dB)	Margin (dB)	Limit (dBµV/m)	Comment
32.018700	16.3	1000.0	120.000	126.0	V	196.0	12.7	13.7	30.0	
35.359650	19.9	1000.0	120.000	104.0	V	8.0	13.1	10.1	30.0	
112.525800	7.0	1000.0	120.000	170.0	V	106.0	10.8	26.5	33.5	
319.988250	23.8	1000.0	120.000	98.0	V	264.0	15.2	12.2	36.0	
729.966000	19.9	1000.0	120.000	134.0	H	8.0	23.2	16.1	36.0	
926.689800	21.8	1000.0	120.000	98.0	H	269.0	25.3	14.2	36.0	

Plot 14: Highest channel, 1 GHz to 12.75 GHz, vertical polarization

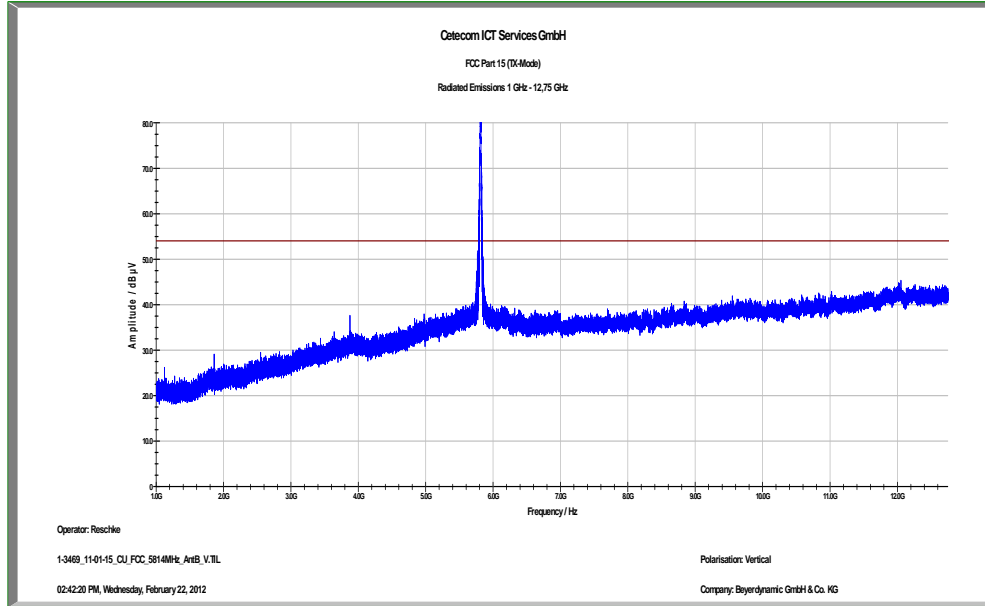

Plot 15: Highest channel, 1 GHz to 12.75 GHz, horizontal polarization

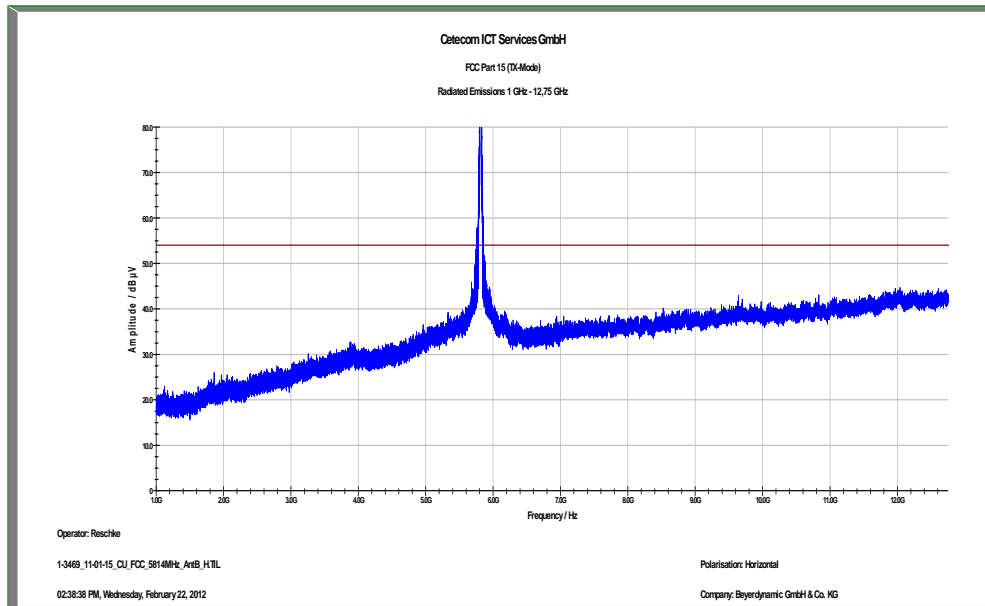

Plot 16: Highest channel, 12.75 GHz to 18 GHz, vertical & horizontal polarization

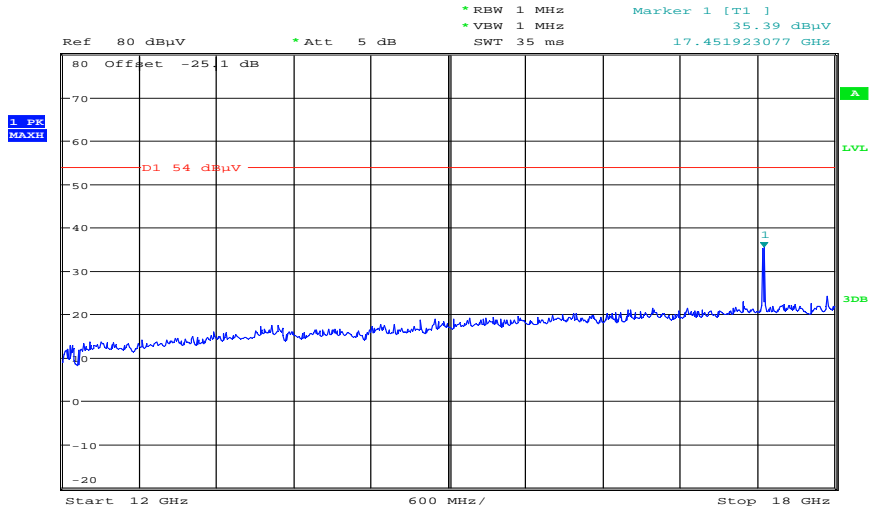

Date: 12.MAR.2012 13:11:34

Plot 17: Highest channel, 18 GHz to 25 GHz, vertical & horizontal polarization

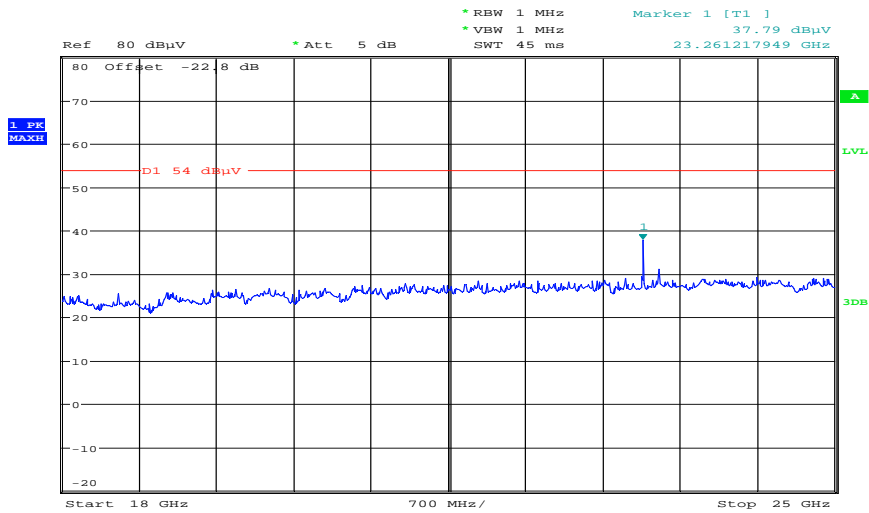

Date: 12.MAR.2012 10:39:34

Plot 18: Highest channel, 25 GHz to 40 GHz, vertical & horizontal polarization

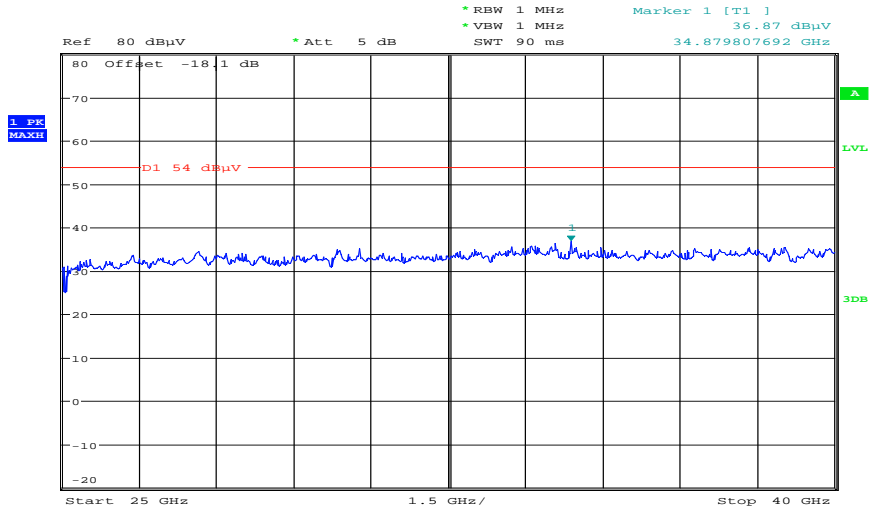

Date: 12.MAR.2012 10:44:12

Plots: Planar antenna A with 10 m cable

Plot 1: Lowest channel, 30 MHz to 1 GHz, vertical & horizontal polarization, also valid for 20m

Common Information

EUT: Quinta CU
 Serial Number: 00101
 Test Description: FCC part 15 class B @ 10 m
 Operating Conditions: Ant A tx@5736MHz
 Operator Name: Wolsdorfer
 Comment: AC: 115 V / 60 Hz; ETH-cable S/FTP; 2x SPA2456 antenna + 10m cable

Scan Setup: STAN_Fin [EMI radiated]

Hardware Setup: Electric Field (NOS)
 Receiver: [ESCI 3]
 Level Unit: dBµV/m

Subrange 30 MHz - 2 GHz **Step Size** 60 kHz **Detectors** QPK **IF BW** 120 kHz **Meas. Time** 1 s **Preamp** 20 dB

FCC_10m(B)_5

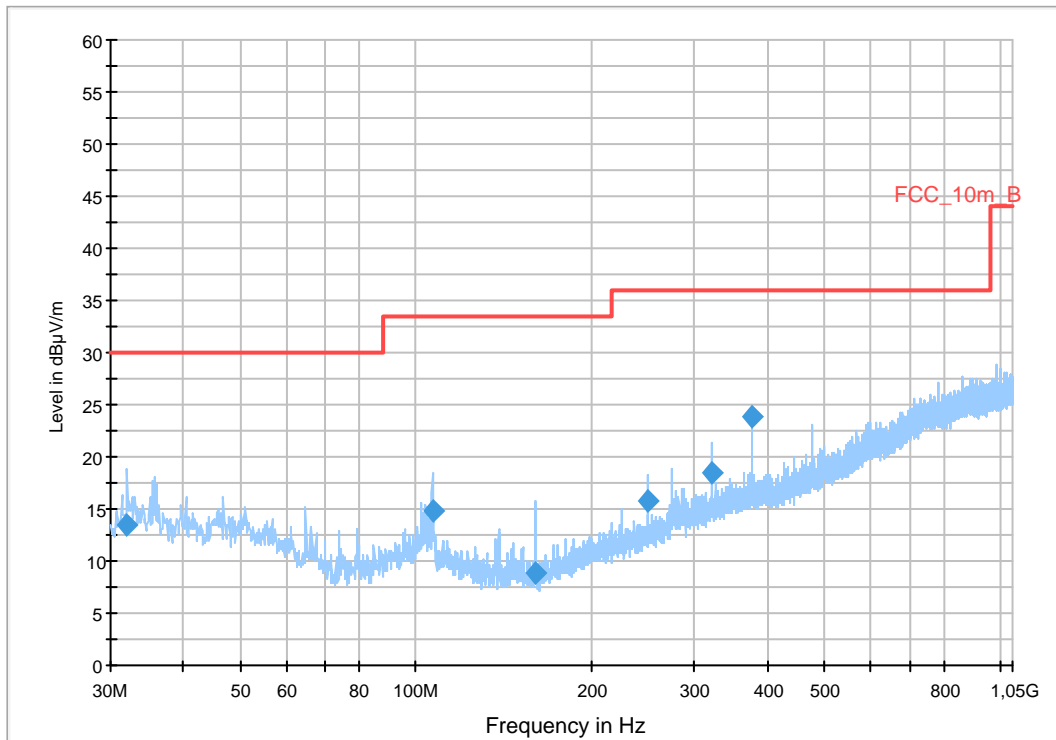

Final Result 1

Frequency (MHz)	QuasiPeak (dBµV/m)	Meas. Time (ms)	Bandwidth (kHz)	Height (cm)	Polarization	Azimuth (deg)	Corr. (dB)	Margin (dB)	Limit (dBµV/m)	Comment
32.040000	13.6	1000.0	120.000	193.0	V	46.0	12.7	16.4	30.0	
106.680000	14.8	1000.0	120.000	166.0	V	55.0	11.3	18.7	33.5	
159.960000	8.8	1000.0	120.000	124.0	V	328.0	9.2	24.7	33.5	
249.960000	15.8	1000.0	120.000	98.0	V	191.0	13.3	20.2	36.0	
320.040000	18.4	1000.0	120.000	105.0	V	320.0	15.2	17.6	36.0	
375.000000	23.9	1000.0	120.000	120.0	V	46.0	16.5	12.1	36.0	

Plot 2: Lowest channel, 1GHz to 12.75 GHz, vertical and horizontal polarization, also valid for 20m

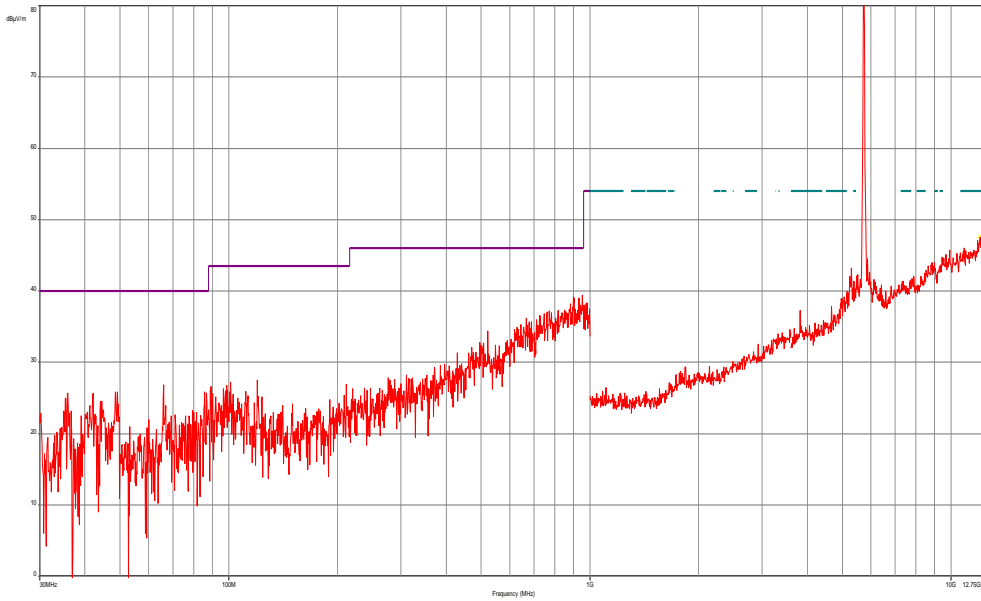

Plot 3: Lowest channel, 12 GHz to 18 GHz (vertical / horizontal – max hold – also valid for 20m)

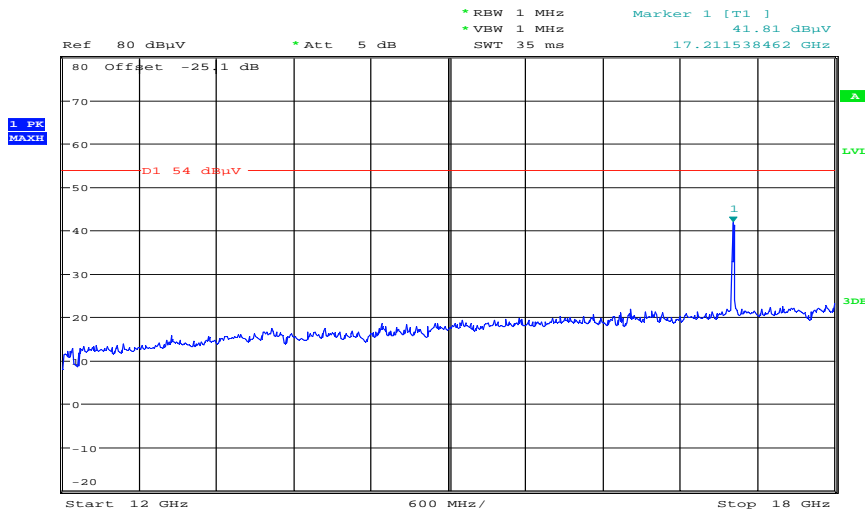

Date: 12.MAR.2012 11:31:02

Plot 4: Lowest channel, 18 GHz to 25 GHz (vertical / horizontal – max hold – also valid for 20m)

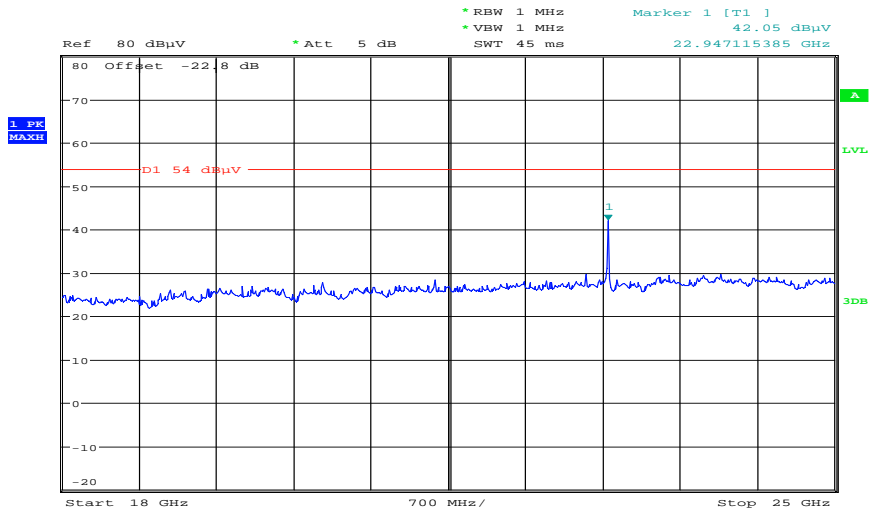

Date: 12.MAR.2012 10:24:46

Plot 5: Lowest channel, 25 GHz to 40 GHz (vertical / horizontal – max hold – also valid for 20m)

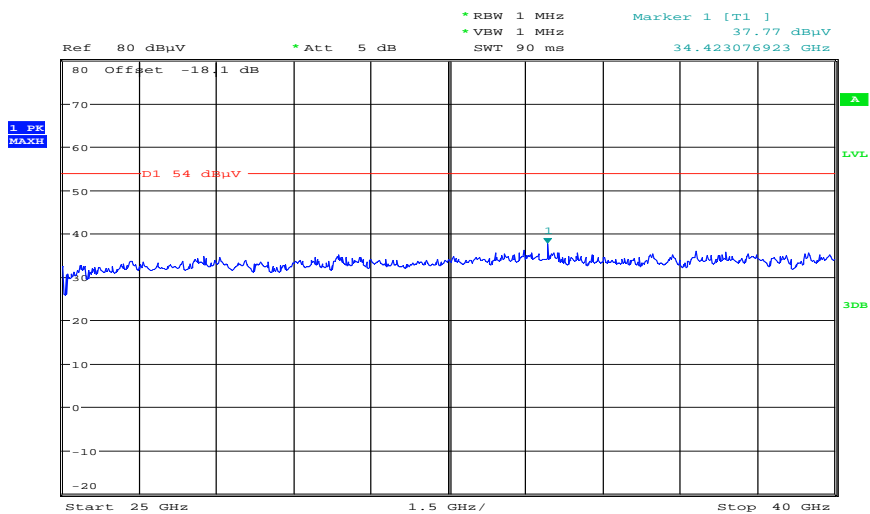

Date: 12.MAR.2012 11:02:56

Plot 6: Middle channel, 30 MHz to 1 GHz, vertical & horizontal polarization, also valid for 20m

Common Information

EUT: Quinta CU
 Serial Number: 00101
 Test Description: FCC part 15 class B @ 10 m
 Operating Conditions: Ant A tx@5762MHz
 Operator Name: Wolsdorfer
 Comment: AC: 115 V / 60 Hz; ETH-cable S/FTP; 2x SPA2456 antenna + 10m cable

Scan Setup: STAN_Fin [EMI radiated]

Hardware Setup: Electric Field (NOS)
 Receiver: [ESCI 3]
 Level Unit: dBµV/m

Subrange **Step Size** **Detectors** **IF BW** **Meas. Time** **Preamp**
 30 MHz - 2 GHz 60 kHz QPK 120 kHz 1 s 20 dB

FCC_10m(B)_5

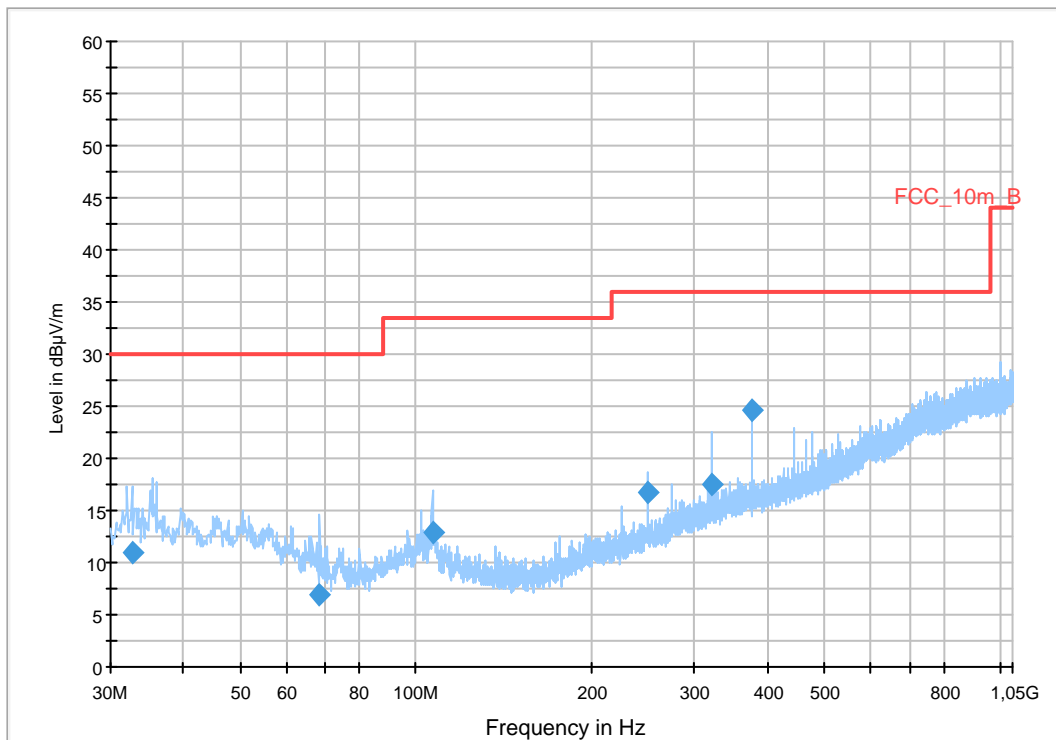

Final Result 1

Frequency (MHz)	QuasiPeak (dBµV/m)	Meas. Time (ms)	Bandwidth (kHz)	Height (cm)	Polarization	Azimuth (deg)	Corr. (dB)	Margin (dB)	Limit (dBµV/m)	Comment
32.640000	10.9	1000.0	120.000	258.0	V	333.0	12.8	19.1	30.0	
68.400000	6.9	1000.0	120.000	207.0	V	302.0	9.6	23.1	30.0	
106.680000	12.8	1000.0	120.000	98.0	V	165.0	11.3	20.7	33.5	
249.960000	16.8	1000.0	120.000	98.0	V	174.0	13.3	19.2	36.0	
319.920000	17.6	1000.0	120.000	105.0	V	192.0	15.2	18.4	36.0	
375.000000	24.7	1000.0	120.000	98.0	V	57.0	16.5	11.3	36.0	

Plot 7: Middle channel, 30MHz to 12.75 GHz, vertical and horizontal polarization, also valid for 20m

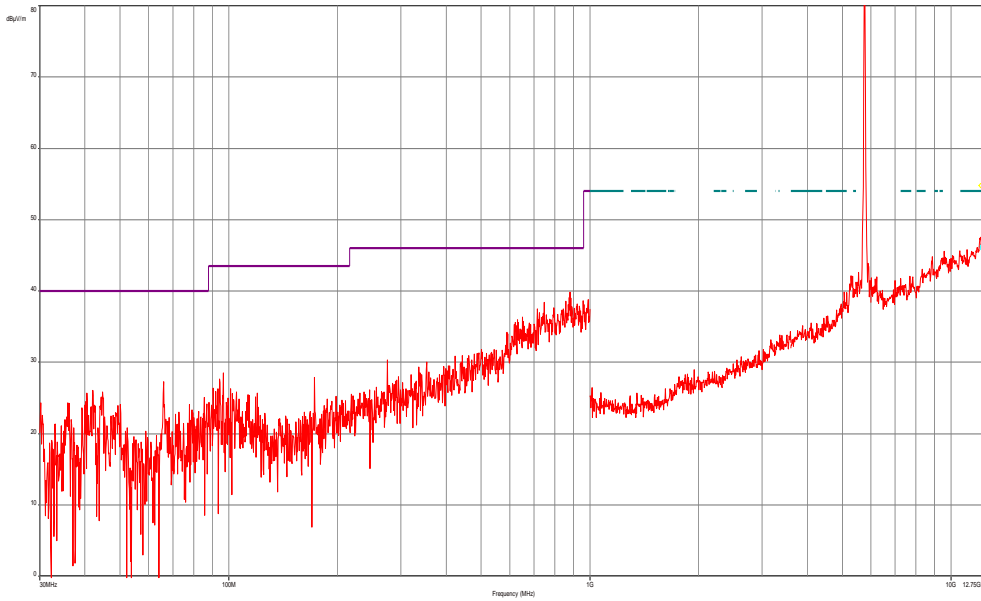

Plot 8: Middle channel, 12 GHz to 18 GHz (vertical / horizontal – max hold – also valid for 20m)

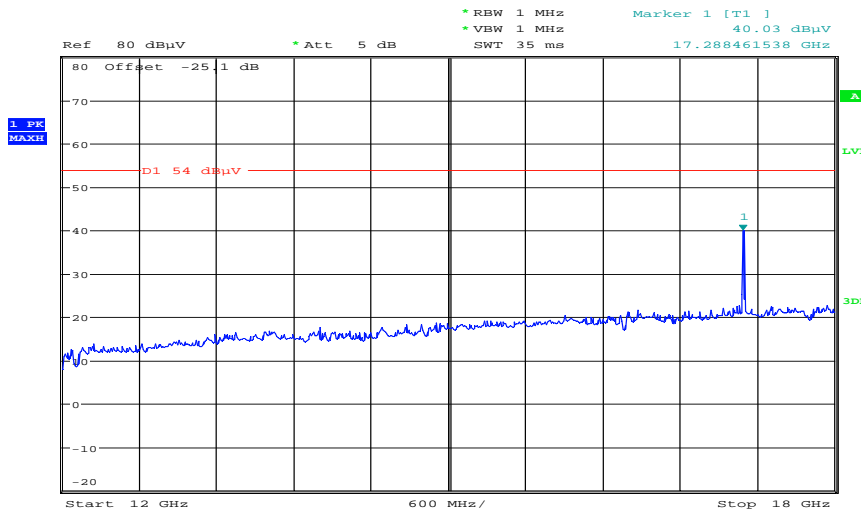

Date: 12.MAR.2012 11:31:43

Plot 9: Middle channel, 18 GHz to 25 GHz (vertical / horizontal – max hold – also valid for 20m)

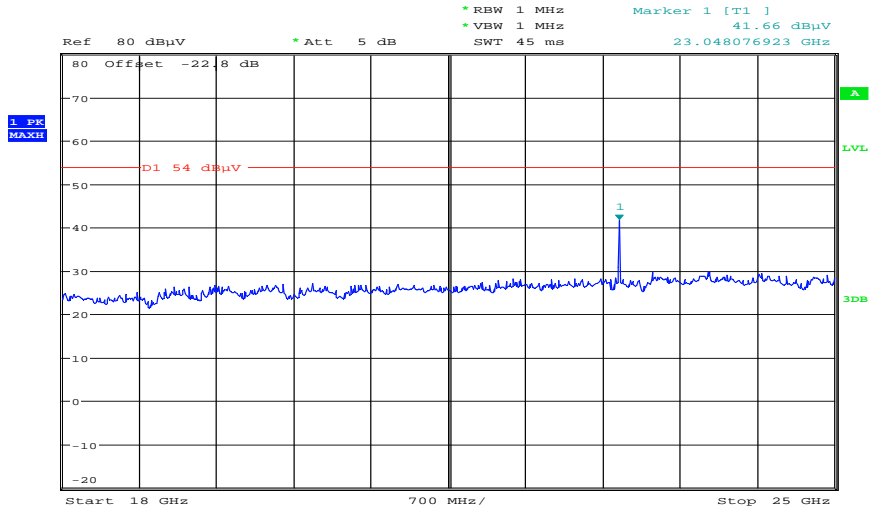

Date: 12.MAR.2012 10:25:24

Plot 10: Middle channel, 25 GHz to 40 GHz (vertical / horizontal – max hold – also valid for 20m)

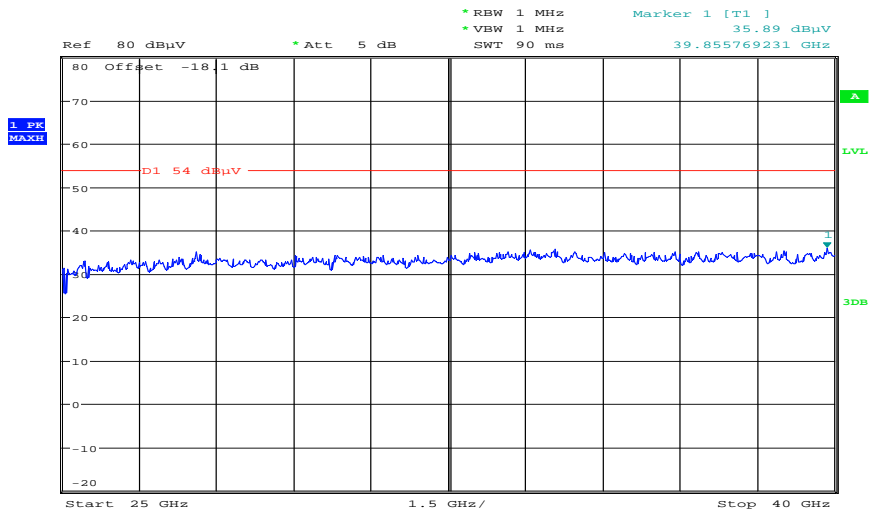

Date: 12.MAR.2012 11:04:24

Plot 11: Highest channel, 30 MHz to 1 GHz, vertical & horizontal polarization, also valid for 20m

Common Information

EUT: Quinta CU
 Serial Number: 00101
 Test Description: FCC part 15 class B @ 10 m
 Operating Conditions: Ant A tx@5814MHz
 Operator Name: Wolsdorfer
 Comment: AC: 115 V / 60 Hz; ETH-cable S/FTP; 2x SPA2456 antenna + 10m cable

Scan Setup: STAN_Fin [EMI radiated]

Hardware Setup: Electric Field (NOS)
 Receiver: [ESCI 3]
 Level Unit: dBµV/m

Subrange **Step Size** **Detectors** **IF BW** **Meas. Time** **Preamp**
 30 MHz - 2 GHz 60 kHz QPK 120 kHz 1 s 20 dB

FCC_10m(B)_5

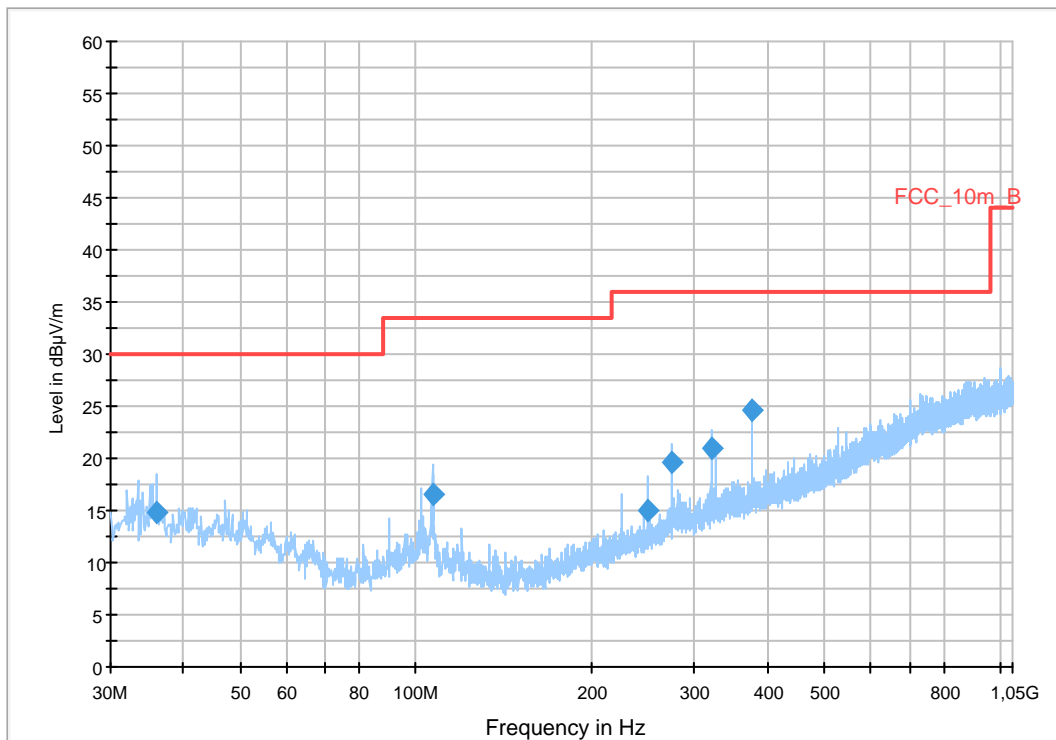

Final Result 1

Frequency (MHz)	QuasiPeak (dBµV/m)	Meas. Time (ms)	Bandwidth (kHz)	Height (cm)	Polarization	Azimuth (deg)	Corr. (dB)	Margin (dB)	Limit (dBµV/m)	Comment
36.000000	14.8	1000.0	120.000	112.0	V	311.0	13.1	15.2	30.0	
106.680000	16.6	1000.0	120.000	146.0	V	-2.0	11.3	16.9	33.5	
249.960000	15.0	1000.0	120.000	98.0	V	-2.0	13.3	21.0	36.0	
275.040000	19.6	1000.0	120.000	98.0	V	201.0	13.9	16.4	36.0	
320.040000	20.9	1000.0	120.000	98.0	V	266.0	15.2	15.1	36.0	
375.000000	24.6	1000.0	120.000	98.0	V	85.0	16.5	11.4	36.0	

Plot 12: Highest channel, 1GHz to 12.75 GHz, vertical and horizontal polarization, also valid for 20m

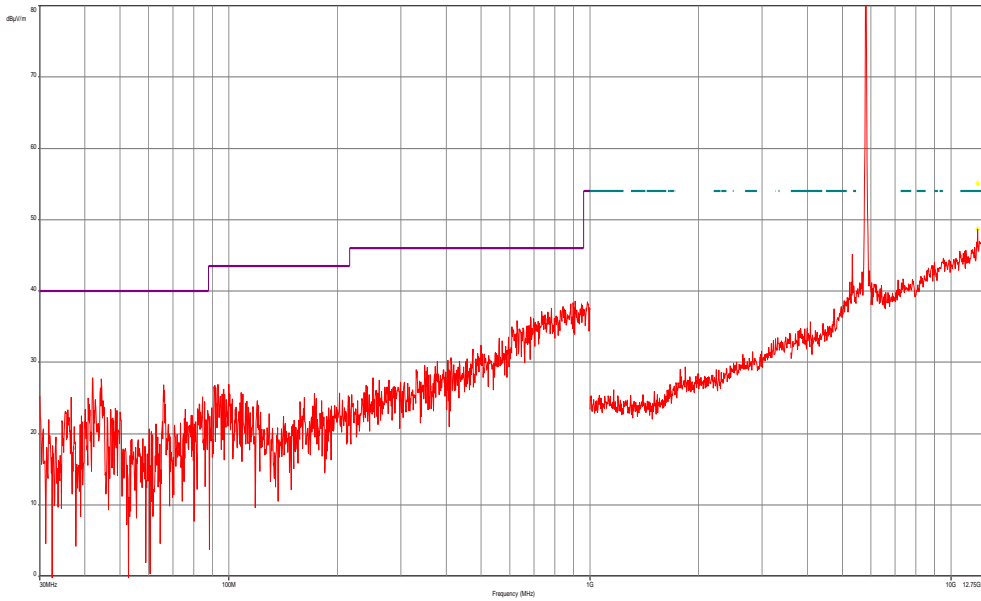

Plot 13: Highest channel, 12 GHz to 18 GHz (vertical / horizontal – max hold – also valid for 20m)

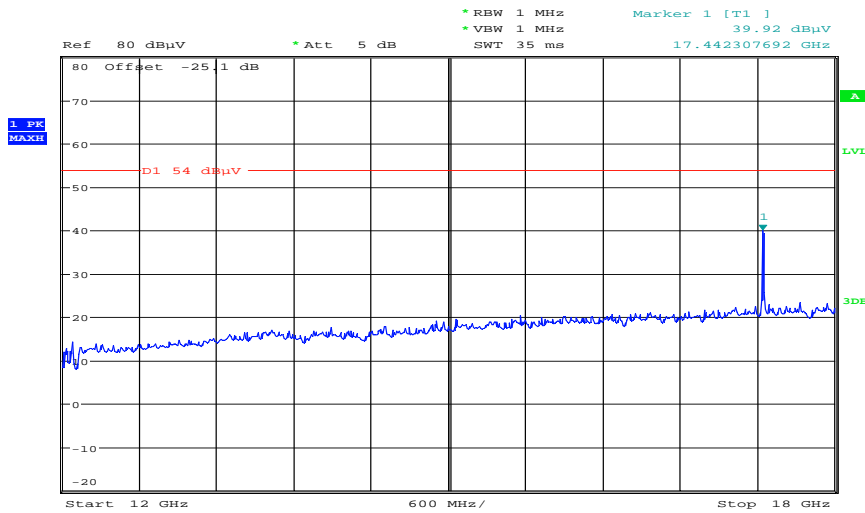

Date: 12.MAR.2012 11:32:31

Plots: Planar antenna B with 10 m cable

Plot 1: Lowest channel, 30 MHz to 1 GHz, vertical & horizontal polarization, also valid for 20m

Common Information

EUT: Quinta CU
 Serial Number: 00101
 Test Description: FCC part 15 class B @ 10 m
 Operating Conditions: Ant B tx@5736MHz
 Operator Name: Wolsdorfer
 Comment: AC: 115 V / 60 Hz; ETH-cable S/FTP; 2x SPA2456 antenna + 10m cable

Scan Setup: STAN_Fin [EMI radiated]

Hardware Setup: Electric Field (NOS)
 Receiver: [ESCI 3]
 Level Unit: dBµV/m

Subrange 30 MHz - 2 GHz **Step Size** 60 kHz **Detectors** QPK **IF BW** 120 kHz **Meas. Time** 1 s **Preamp** 20 dB

FCC_10m(B)_5

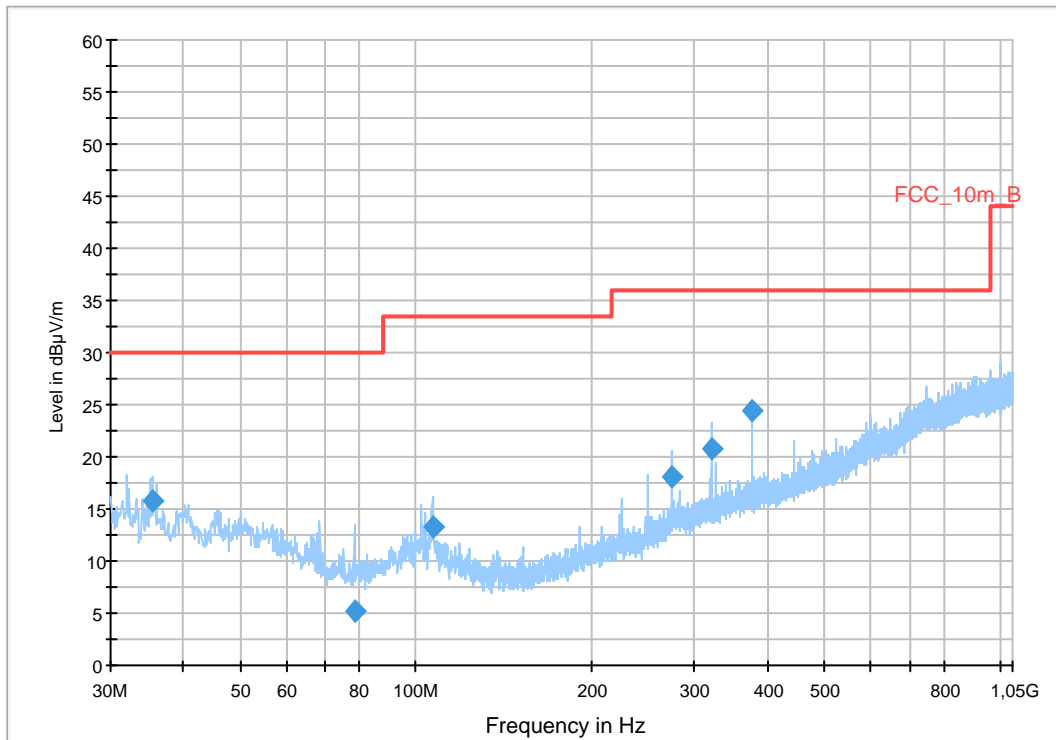

Final Result 1

Frequency (MHz)	QuasiPeak (dBµV/m)	Meas. Time (ms)	Bandwidth (kHz)	Height (cm)	Polarization	Azimuth (deg)	Corr. (dB)	Margin (dB)	Limit (dBµV/m)	Comment
35.400000	15.8	1000.0	120.000	123.0	V	36.0	13.1	14.2	30.0	
78.360000	5.2	1000.0	120.000	112.0	V	321.0	9.1	24.8	30.0	
106.680000	13.3	1000.0	120.000	176.0	V	77.0	11.3	20.2	33.5	
275.040000	18.1	1000.0	120.000	105.0	V	18.0	13.9	17.9	36.0	
320.040000	20.8	1000.0	120.000	114.0	V	289.0	15.2	15.2	36.0	
375.000000	24.5	1000.0	120.000	98.0	V	36.0	16.5	11.5	36.0	

Plot 2: Lowest channel, 1GHz to 12.75 GHz, vertical and horizontal polarization, also valid for 20m

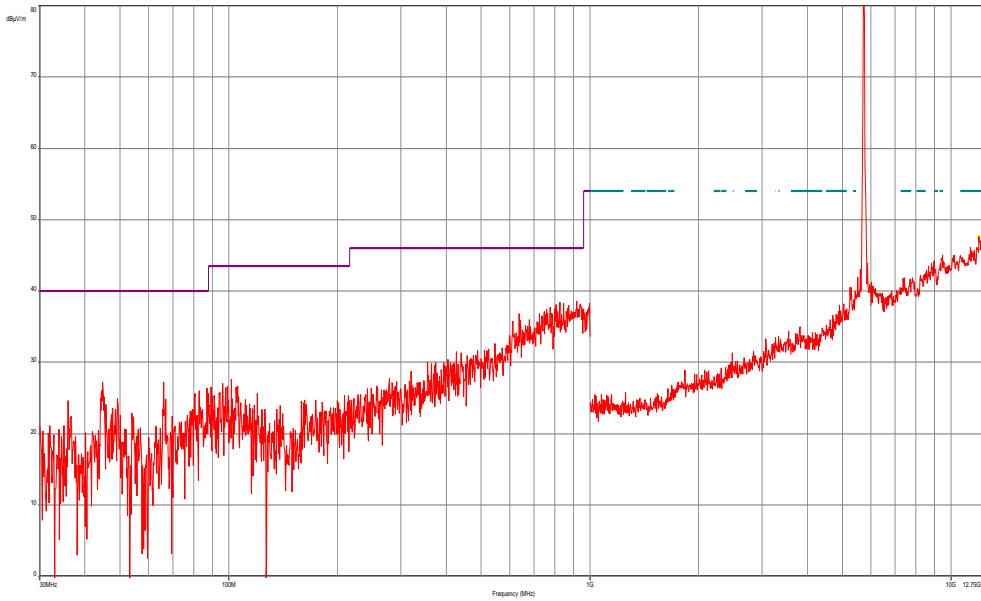

Plot 3: Lowest channel, 12 GHz to 18 GHz (vertical / horizontal – max hold – also valid for 20m)

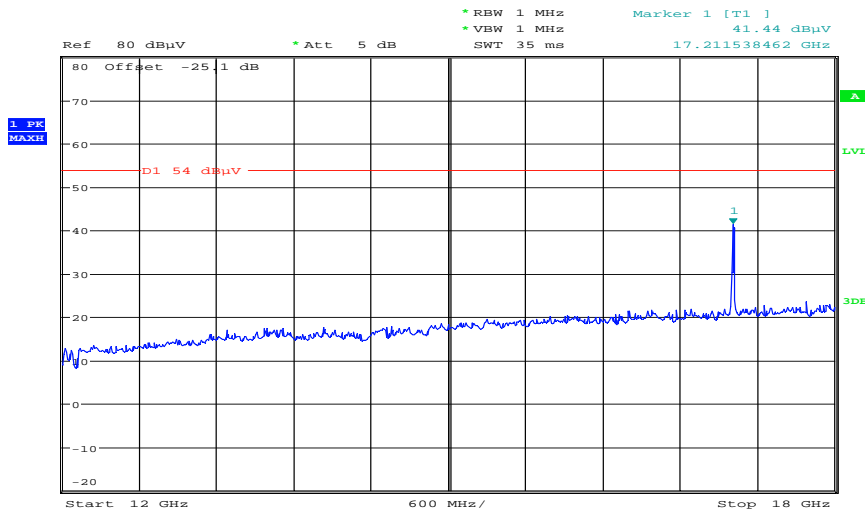

Date: 12.MAR.2012 11:33:33

Plot 4: Lowest channel, 18 GHz to 25 GHz (vertical / horizontal – max hold – also valid for 20m)

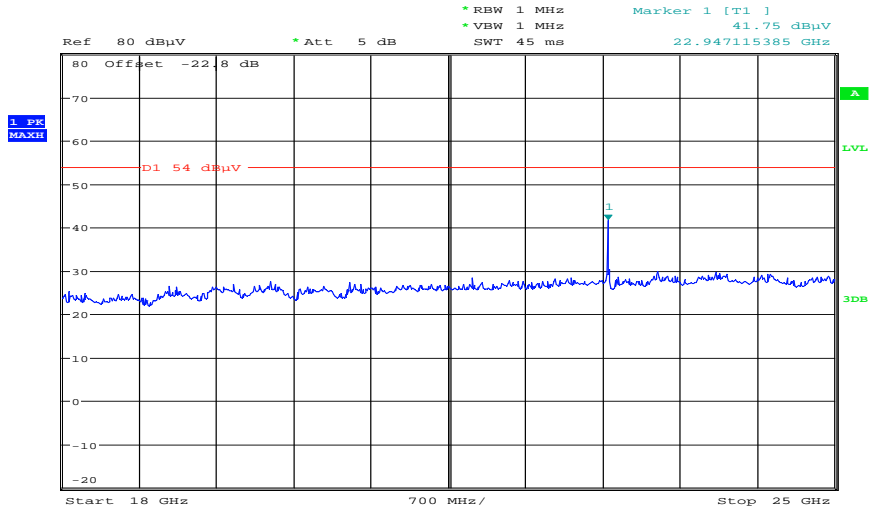

Date: 12.MAR.2012 10:26:45

Plot 5: Lowest channel, 25 GHz to 40 GHz (vertical / horizontal – max hold – also valid for 20m)

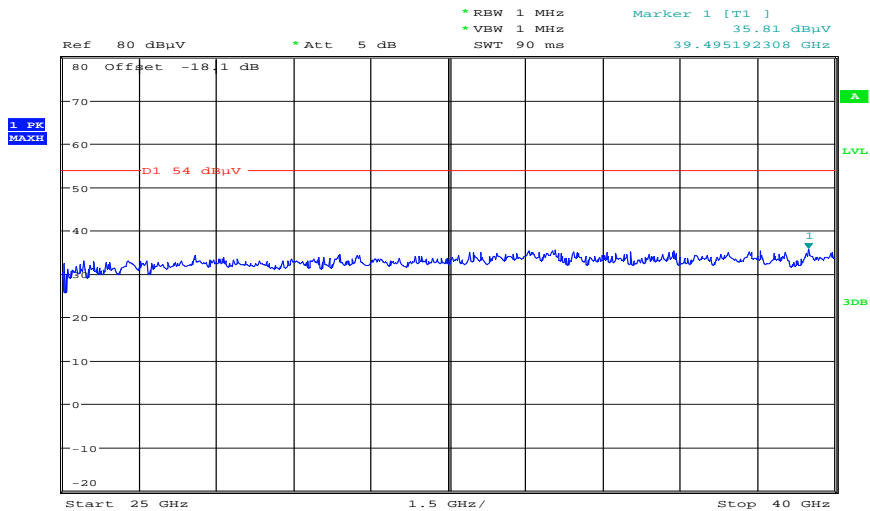

Date: 12.MAR.2012 11:05:34

Plot 6: Middle channel, 30 MHz to 1 GHz, vertical & horizontal polarization, also valid for 20m

Common Information

EUT: Quinta CU
 Serial Number: 00101
 Test Description: FCC part 15 class B @ 10 m
 Operating Conditions: Ant B tx@5762MHz
 Operator Name: Wolsdorfer
 Comment: AC: 115 V / 60 Hz; ETH-cable S/FTP; 2x SPA2456 antenna + 10m cable

Scan Setup: STAN_Fin [EMI radiated]

Hardware Setup: Electric Field (NOS)
 Receiver: [ESCI 3]
 Level Unit: dBµV/m

Subrange **Step Size** **Detectors** **IF BW** **Meas. Time** **Preamp**
 30 MHz - 2 GHz 60 kHz QPK 120 kHz 1 s 20 dB

FCC_10m(B)_5

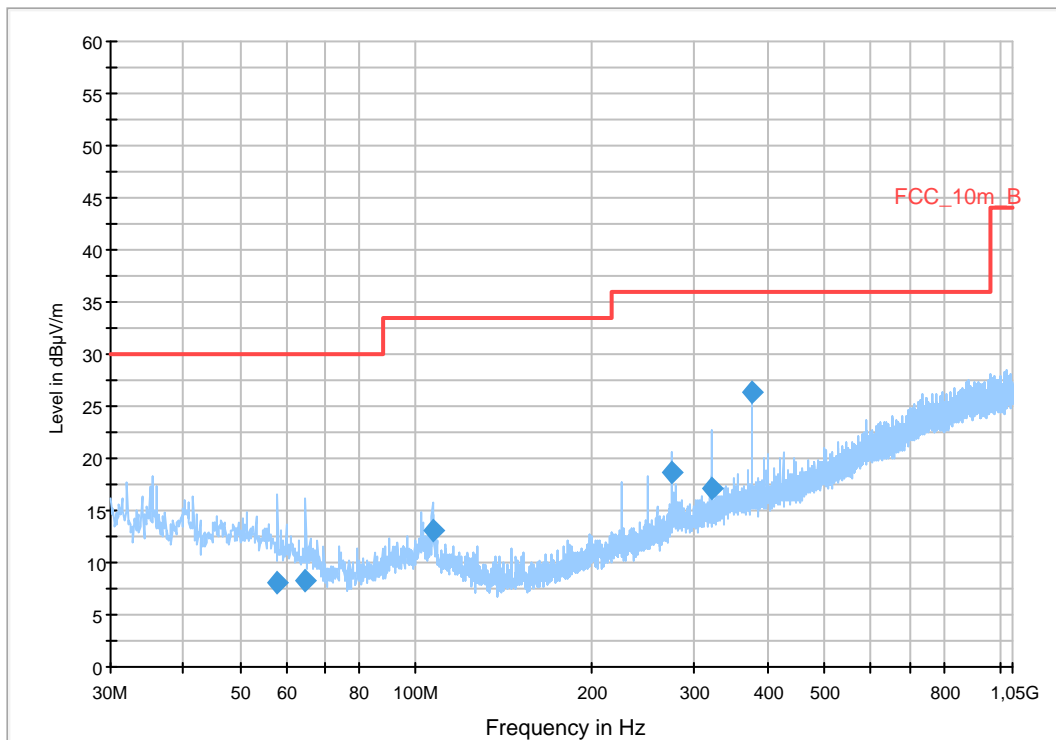

Final Result 1

Frequency (MHz)	QuasiPeak (dBµV/m)	Meas. Time (ms)	Bandwidth (kHz)	Height (cm)	Polarization	Azimuth (deg)	Corr. (dB)	Margin (dB)	Limit (dBµV/m)	Comment
57.960000	8.2	1000.0	120.000	146.0	V	168.0	12.1	21.8	30.0	
64.800000	8.3	1000.0	120.000	147.0	V	38.0	10.5	21.7	30.0	
106.680000	13.0	1000.0	120.000	188.0	V	168.0	11.3	20.5	33.5	
275.040000	18.7	1000.0	120.000	155.0	V	48.0	13.9	17.3	36.0	
319.920000	17.0	1000.0	120.000	98.0	V	253.0	15.2	19.0	36.0	
375.000000	26.4	1000.0	120.000	98.0	V	48.0	16.5	9.6	36.0	

Plot 7: Middle channel, 1GHz to 12.75 GHz, vertical and horizontal polarization, also valid for 20m

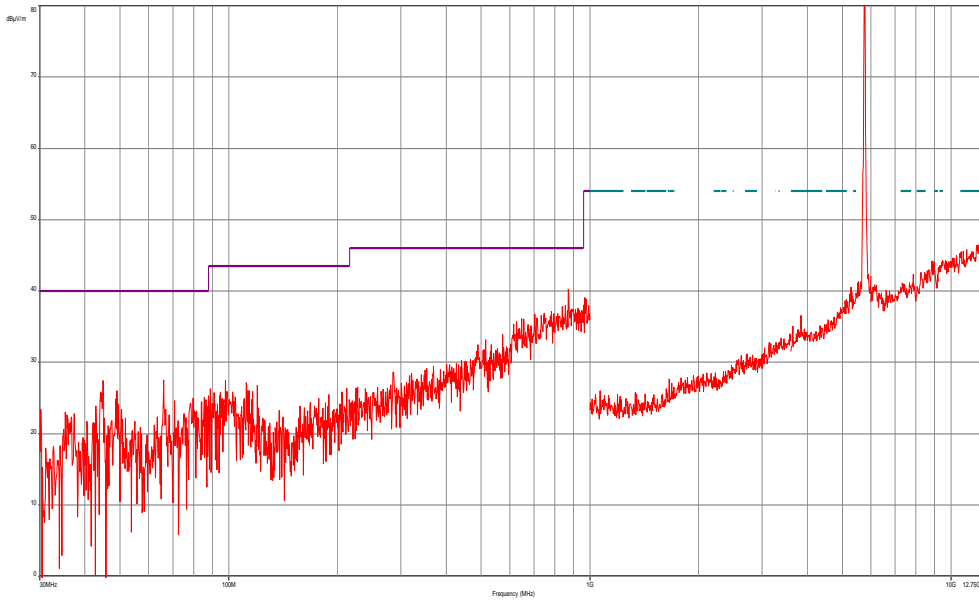

Plot 8: Middle channel, 12 GHz to 18 GHz (vertical / horizontal – max hold – also valid for 20m)

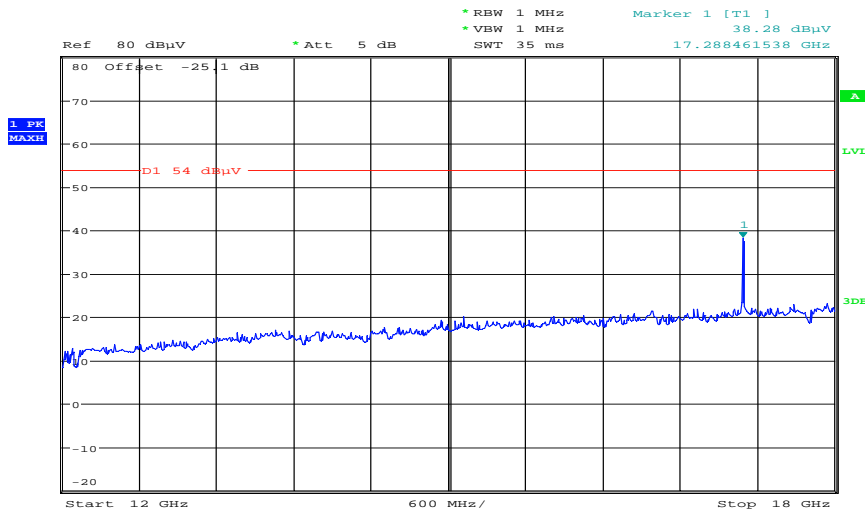

Date: 12.MAR.2012 11:34:52

Plot 9: Middle channel, 18 GHz to 25 GHz (vertical / horizontal – max hold – also valid for 20m)

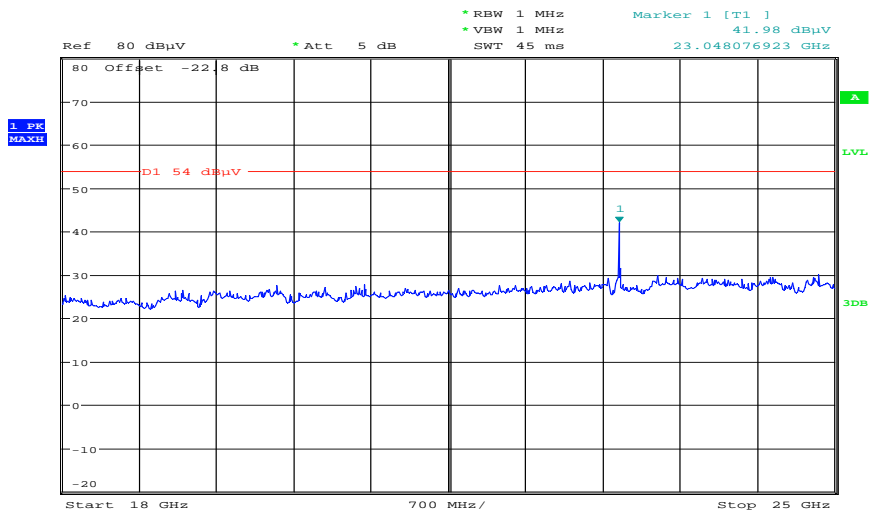

Date: 12.MAR.2012 10:27:20

Plot 10: Middle channel, 25 GHz to 40 GHz (vertical / horizontal – max hold – also valid for 20m)

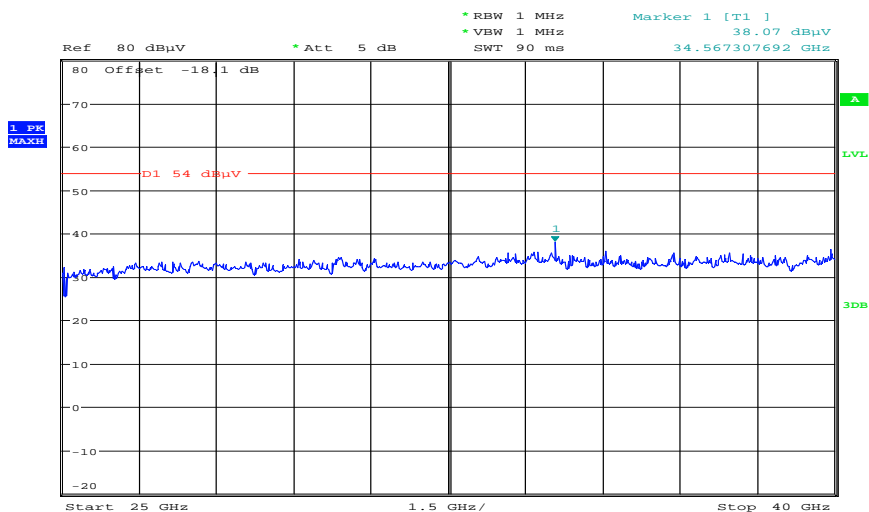

Date: 12.MAR.2012 11:06:03

Plot 11: Highest channel, 30 MHz to 1 GHz, vertical & horizontal polarization, also valid for 20m

Common Information

EUT: Quinta CU
 Serial Number: 00101
 Test Description: FCC part 15 class B @ 10 m
 Operating Conditions: Ant B tx@5814MHz
 Operator Name: Wolsdorfer
 Comment: AC: 115 V / 60 Hz; ETH-cable S/FTP; 2x SPA2456 antenna + 10m cable

Scan Setup: STAN_Fin [EMI radiated]

Hardware Setup: Electric Field (NOS)
 Receiver: [ESCI 3]
 Level Unit: dBµV/m

Subrange **Step Size** **Detectors** **IF BW** **Meas. Time** **Preamp**
 30 MHz - 2 GHz 60 kHz QPK 120 kHz 1 s 20 dB

FCC_10m(B)_5

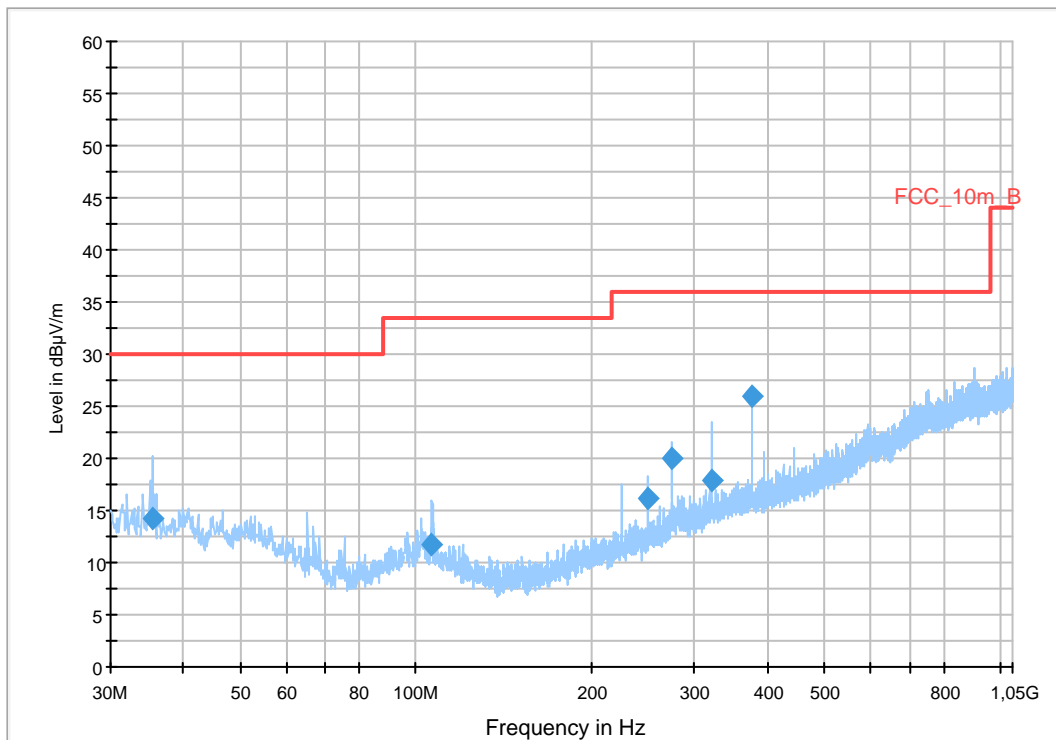

Final Result 1

Frequency (MHz)	QuasiPeak (dBµV/m)	Meas. Time (ms)	Bandwidth (kHz)	Height (cm)	Polarization	Azimuth (deg)	Corr. (dB)	Margin (dB)	Limit (dBµV/m)	Comment
35.400000	14.3	1000.0	120.000	270.0	V	108.0	13.1	15.7	30.0	
106.560000	11.7	1000.0	120.000	145.0	V	174.0	11.3	21.8	33.5	
249.960000	16.1	1000.0	120.000	120.0	V	164.0	13.3	19.9	36.0	
275.040000	20.0	1000.0	120.000	98.0	V	205.0	13.9	16.0	36.0	
319.920000	17.8	1000.0	120.000	98.0	V	280.0	15.2	18.2	36.0	
375.000000	26.0	1000.0	120.000	98.0	V	54.0	16.5	10.0	36.0	

Plot 12: Highest channel, 1GHz to 12.75 GHz, vertical and horizontal polarization, also valid for 20m

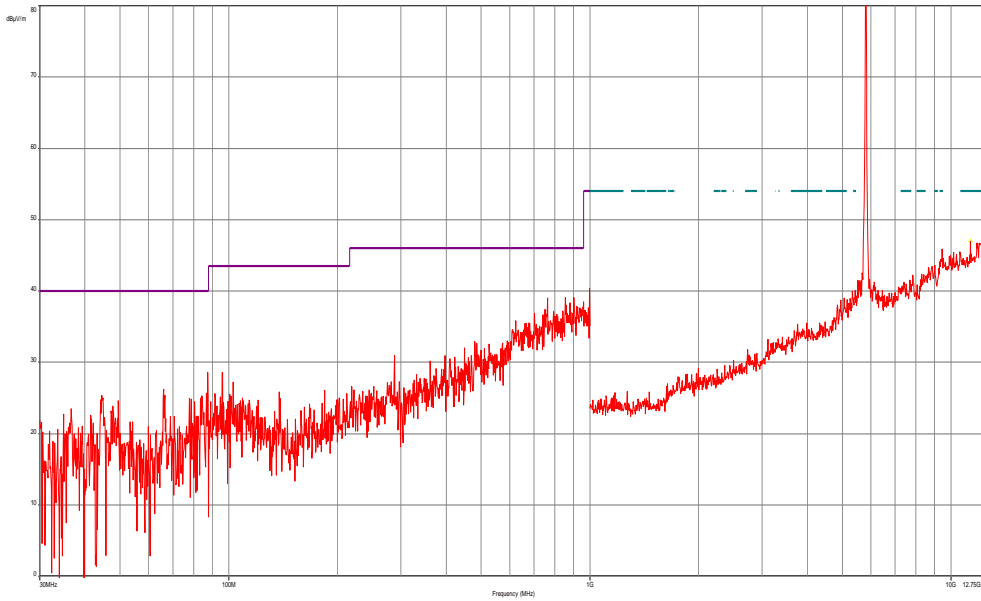

Plot 13: Highest channel, 12 GHz to 18 GHz (vertical / horizontal – max hold – also valid for 20m)

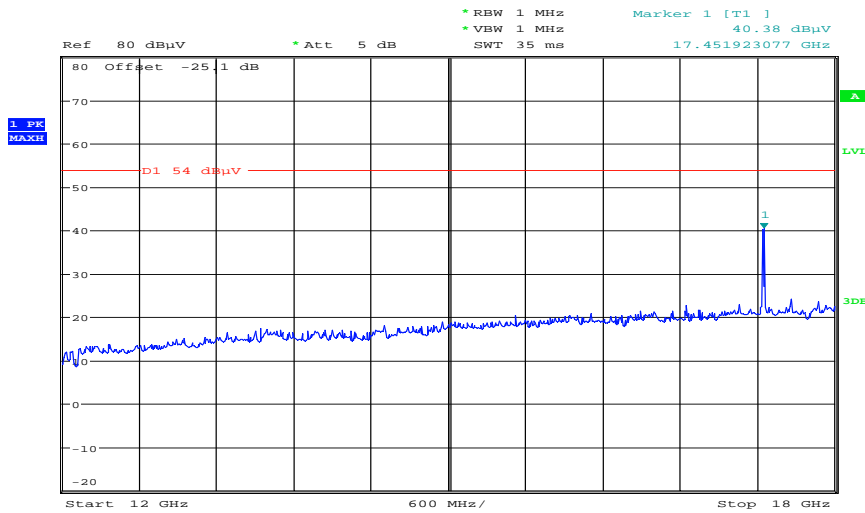

Date: 12.MAR.2012 11:35:39

Plot 14: Highest channel, 18 GHz to 25 GHz (vertical / horizontal – max hold – also valid for 20m)

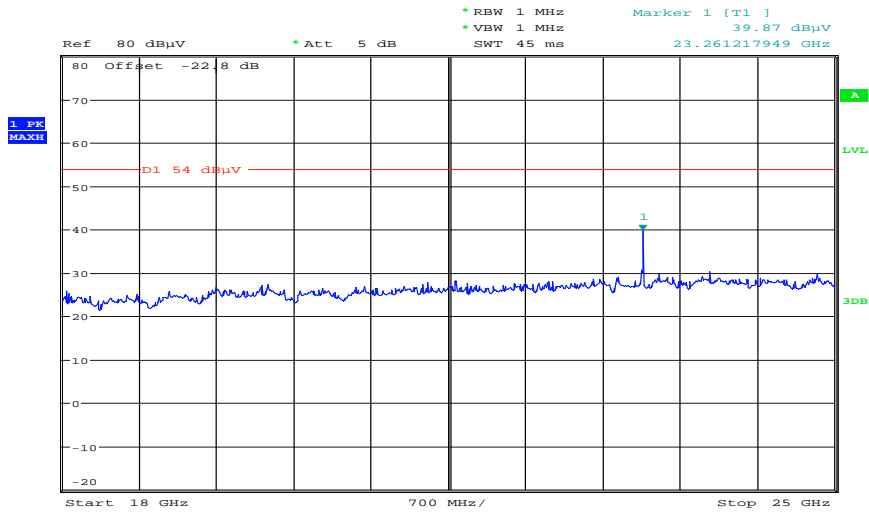

Date: 12.MAR.2012 10:28:00

Plot 15: Highest channel, 25 GHz to 40 GHz (vertical / horizontal – max hold – also valid for 20m)

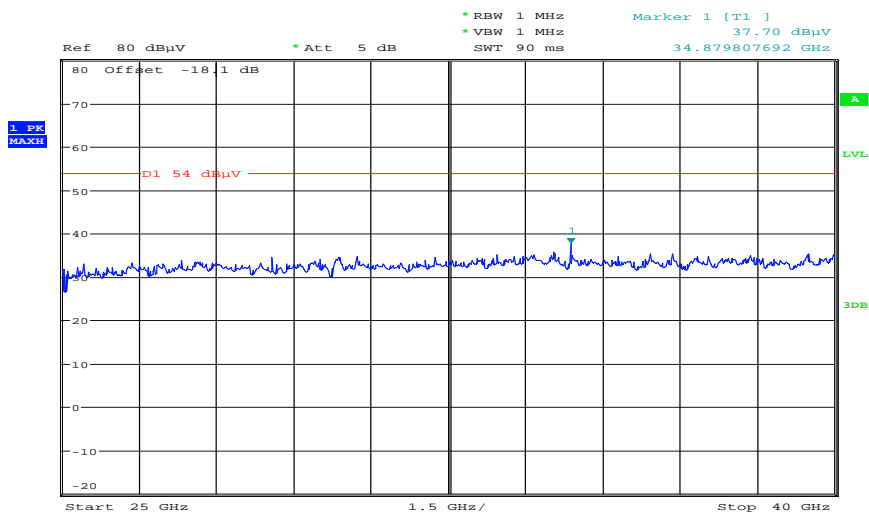

Date: 12.MAR.2012 11:06:28

Plots: Omnidirectional antenna A with 10 m cable

Plot 1: Lowest channel, 30 MHz to 1 GHz, vertical & horizontal polarization, also valid for 20m

Common Information

EUT: Quinta CU
 Serial Number: 00101
 Test Description: FCC part 15 class B @ 10 m
 Operating Conditions: Ant A tx@5736MHz
 Operator Name: Wolsdorfer
 Comment: AC: 115 V / 60 Hz; ETH-cable S/FTP; 2x SWA2459+10m cable

Scan Setup: STAN_Fin [EMI radiated]

Hardware Setup: Electric Field (NOS)
 Receiver: [ESCI 3]
 Level Unit: dBµV/m
Subrange **Step Size** **Detectors** **IF BW** **Meas. Time** **Preamp**
 30 MHz - 2 GHz 60 kHz QPK 120 kHz 1 s 20 dB

FCC_10m(B)_5

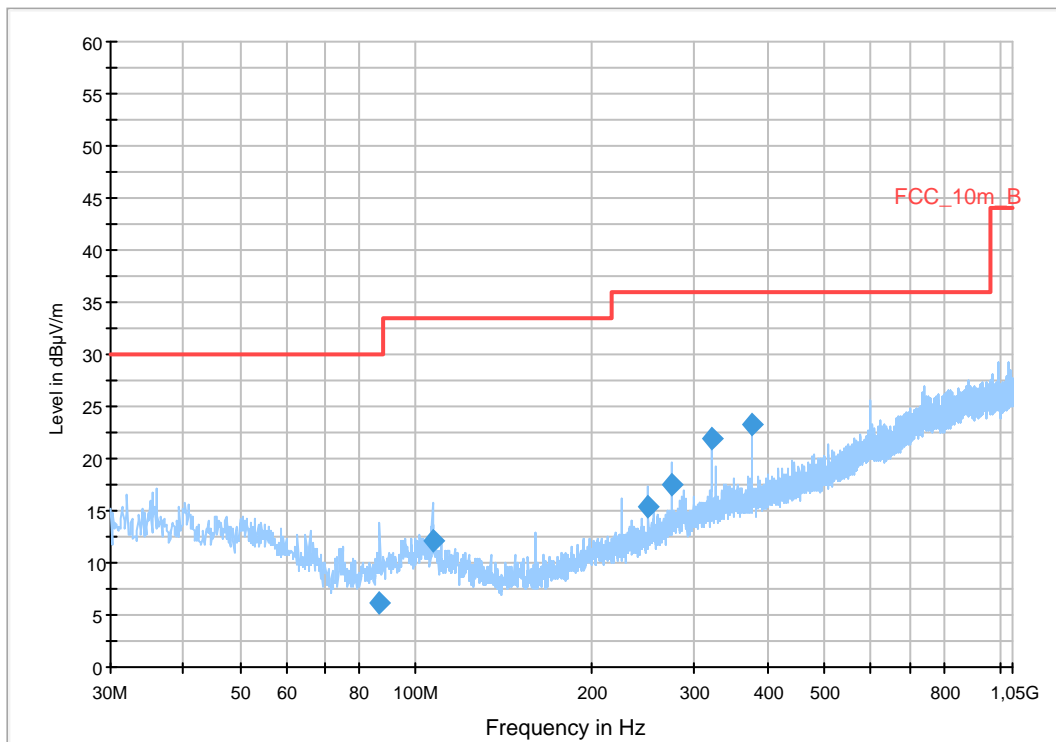

Final Result 1

Frequency (MHz)	QuasiPeak (dBµV/m)	Meas. Time (ms)	Bandwidth (kHz)	Height (cm)	Polarization	Azimuth (deg)	Corr. (dB)	Margin (dB)	Limit (dBµV/m)	Comment
86.760000	6.2	1000.0	120.000	273.0	V	311.0	10.1	23.8	30.0	
106.680000	12.1	1000.0	120.000	132.0	V	80.0	11.3	21.4	33.5	
249.960000	15.3	1000.0	120.000	98.0	V	9.0	13.3	20.7	36.0	
275.040000	17.6	1000.0	120.000	171.0	V	39.0	13.9	18.4	36.0	
320.040000	22.0	1000.0	120.000	105.0	V	302.0	15.2	14.0	36.0	
375.000000	23.2	1000.0	120.000	98.0	V	49.0	16.5	12.8	36.0	

Plot 2: Lowest channel, 1GHz to 12.75 GHz, vertical and horizontal polarization, also valid for 20m

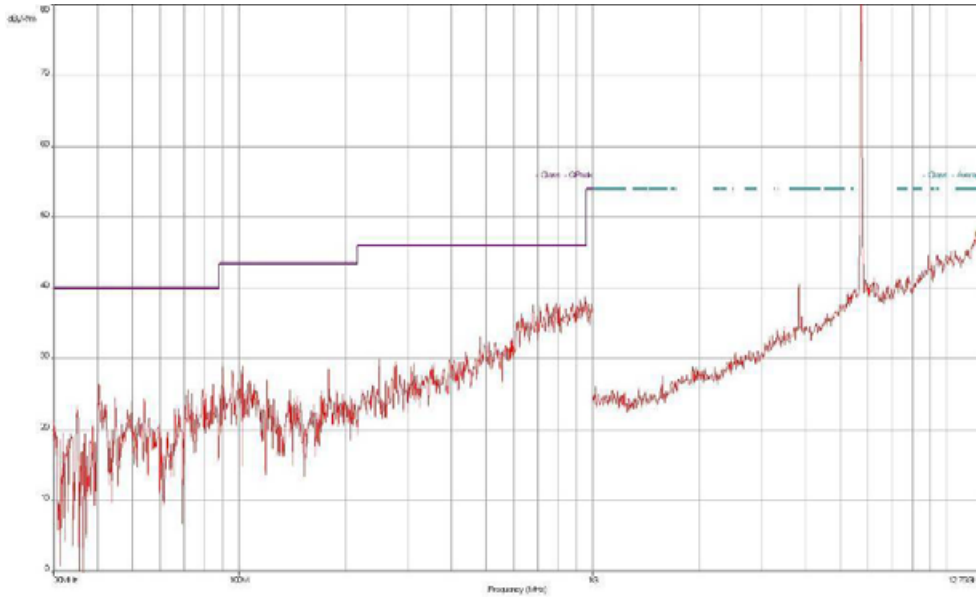

Plot 3: Lowest channel, 12 GHz to 18 GHz (vertical / horizontal – max hold – also valid for 20m)

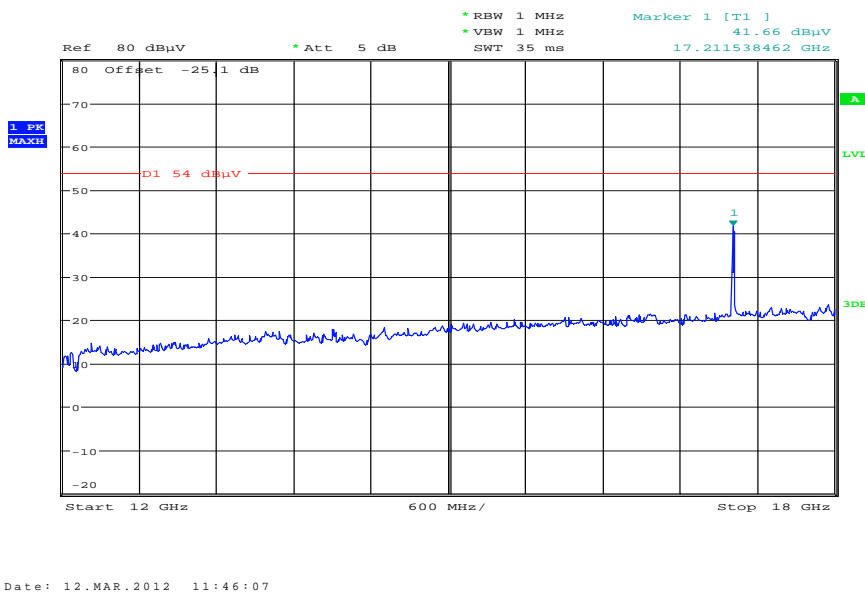

Plot 4: Lowest channel, 18 GHz to 25 GHz (vertical / horizontal – max hold – also valid for 20m)

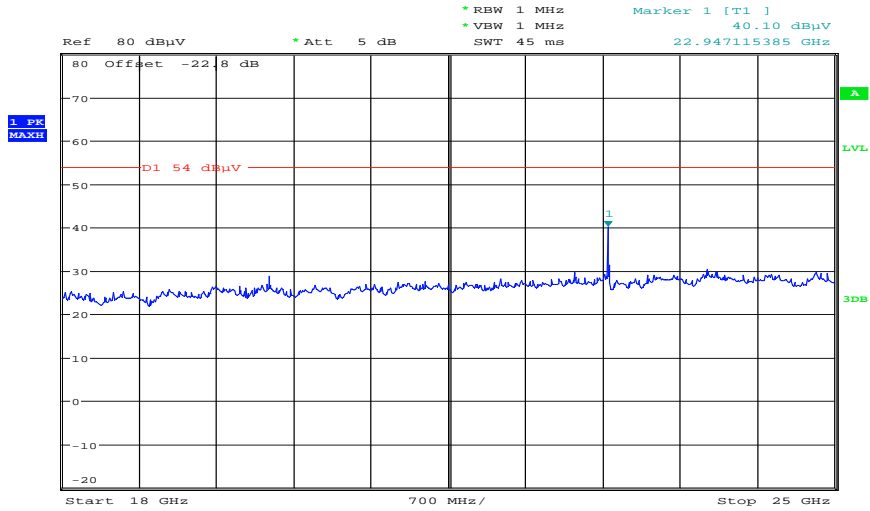

Date: 12.MAR.2012 10:30:09

Plot 5: Lowest channel, 25 GHz to 40 GHz (vertical / horizontal – max hold – also valid for 20m)

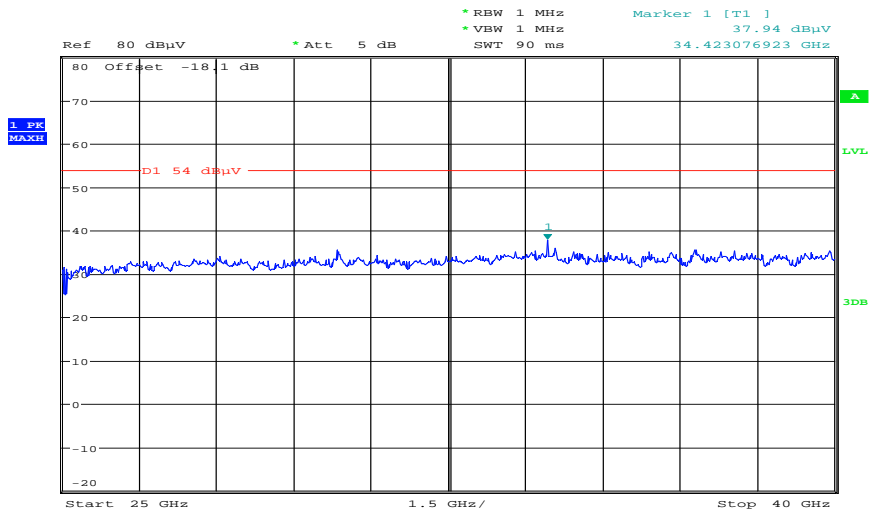

Date: 12.MAR.2012 10:59:34

Plot 6: Middle channel, 30 MHz to 1 GHz, vertical & horizontal polarization, also valid for 20m

Common Information

EUT: Quinta CU
 Serial Number: 00101
 Test Description: FCC part 15 class B @ 10 m
 Operating Conditions: Ant A tx@5762MHz
 Operator Name: Wolsdorfer
 Comment: AC: 115 V / 60 Hz; ETH-cable S/FTP; 2x SWA2459+10m cable

Scan Setup: STAN_Fin [EMI radiated]

Hardware Setup: Electric Field (NOS)
 Receiver: [ESCI 3]
 Level Unit: dBµV/m

Subrange	Step Size	Detectors	IF BW	Meas. Time	Preamp
30 MHz - 2 GHz	60 kHz	QPK	120 kHz	1 s	20 dB

FCC_10m(B)_5

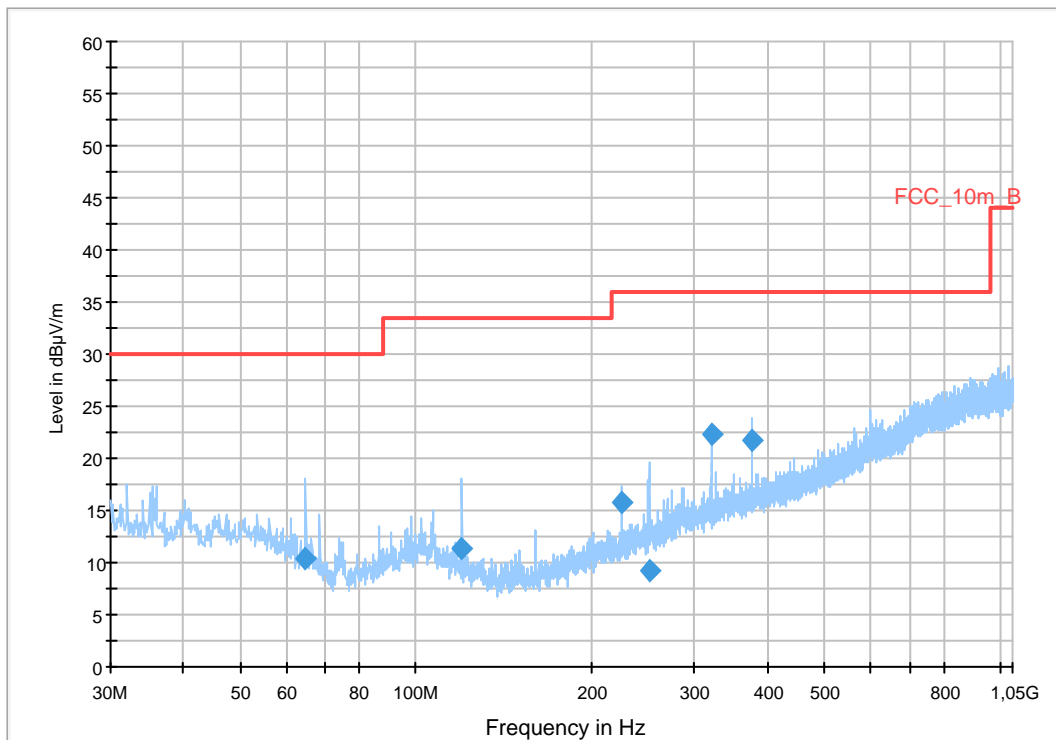

Final Result 1

Frequency (MHz)	QuasiPeak (dBµV/m)	Meas. Time (ms)	Bandwidth (kHz)	Height (cm)	Polarization	Azimuth (deg)	Corr. (dB)	Margin (dB)	Limit (dBµV/m)	Comment
64.800000	10.4	1000.0	120.000	186.0	V	89.0	10.5	19.6	30.0	
120.000000	11.4	1000.0	120.000	218.0	V	148.0	10.2	22.1	33.5	
225.000000	15.8	1000.0	120.000	98.0	V	11.0	12.5	20.2	36.0	
250.320000	9.1	1000.0	120.000	98.0	V	-2.0	13.3	26.9	36.0	
320.040000	22.4	1000.0	120.000	105.0	V	311.0	15.2	13.6	36.0	
375.000000	21.7	1000.0	120.000	98.0	V	184.0	16.5	14.3	36.0	

Plot 7: Middle channel, 1GHz to 12.75 GHz, vertical and horizontal polarization, also valid for 20m

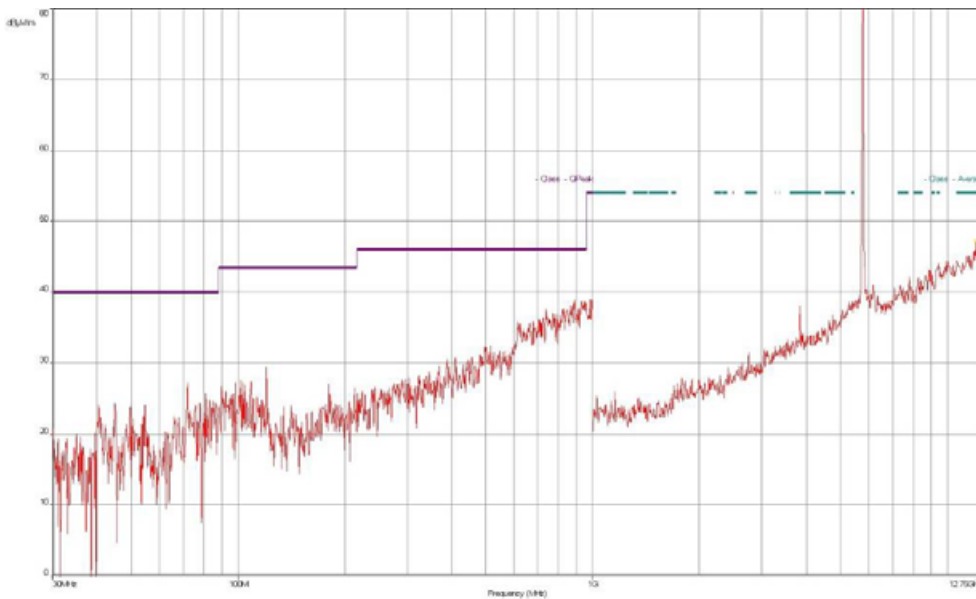

Plot 8: Middle channel, 12 GHz to 18 GHz (vertical / horizontal – max hold – also valid for 20m)

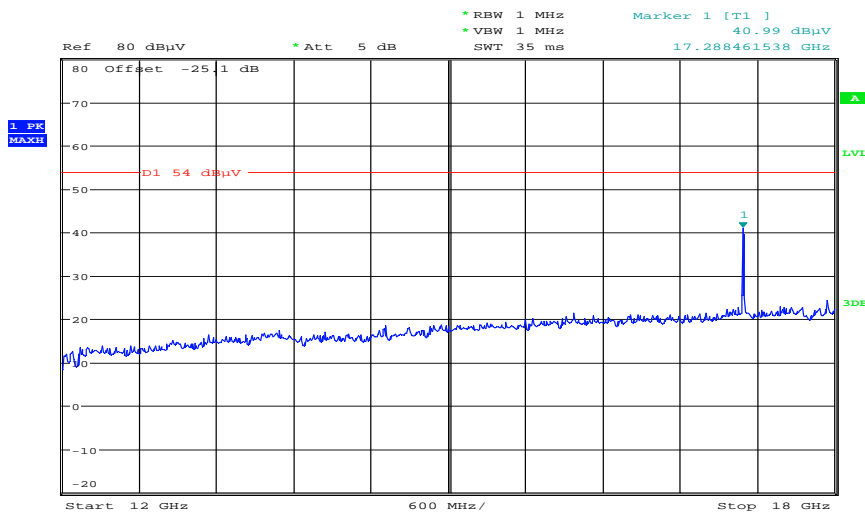

Date: 12.MAR.2012 11:47:02

Plot 9: Middle channel, 18 GHz to 25 GHz (vertical / horizontal – max hold – also valid for 20m)

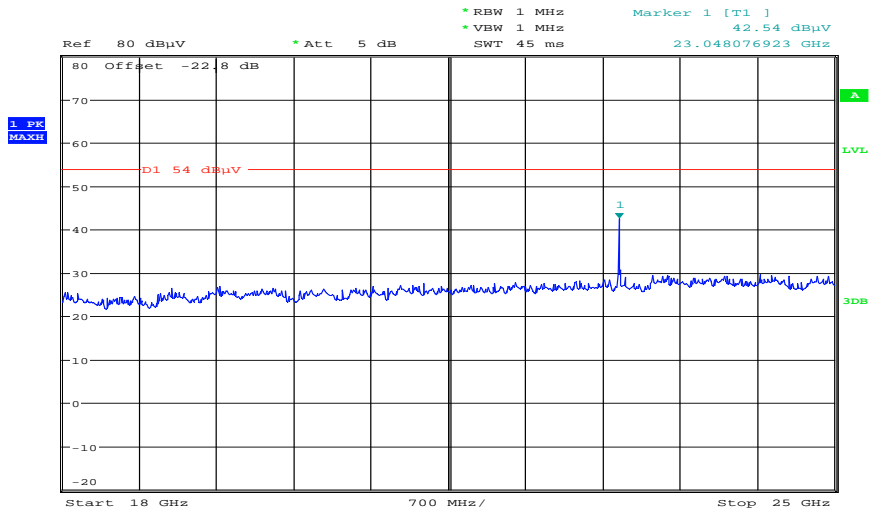

Date: 12.MAR.2012 10:30:53

Plot 10: Middle channel, 25 GHz to 40 GHz (vertical / horizontal – max hold – also valid for 20m)

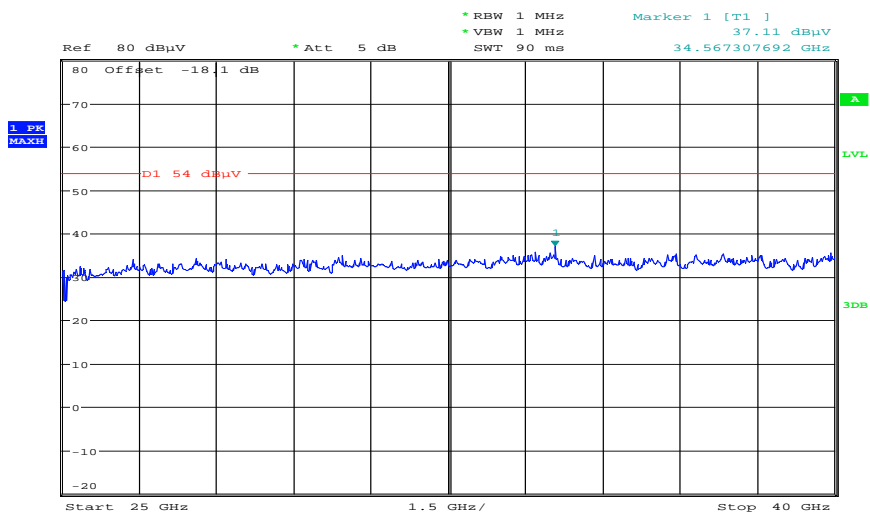

Date: 12.MAR.2012 11:00:06

Plot 11: Highest channel, 30 MHz to 1 GHz, vertical & horizontal polarization, also valid for 20m

Common Information

EUT: Quinta CU
 Serial Number: 00101
 Test Description: FCC part 15 B class B
 Operating Conditions: ANT A, tx@5814MHz
 Operator Name: Hennemann
 Comment: AC: 115 V / 60 Hz; ETH-cable S/FTP; 2x SWA2459+10m cable

Scan Setup: STAN_Fin [EMI radiated]

Hardware Setup: Electric Field (NOS)
 Receiver: [ESCI 3]
 Level Unit: dBµV/m
Subrange **Step Size** **Detectors** **IF BW** **Meas. Time** **Preamp**
 30 MHz - 2 GHz 60 kHz QPK 120 kHz 1 s 20 dB

FCC_10m(B)_3

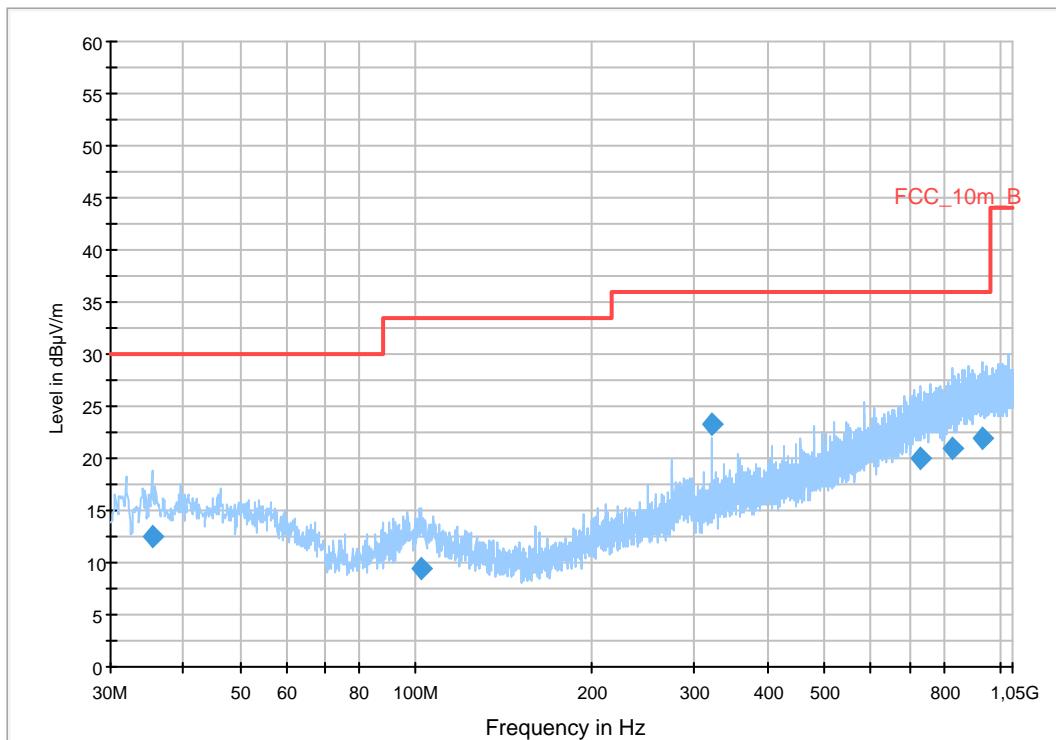

Final Result 1

Frequency (MHz)	QuasiPeak (dBµV/m)	Meas. Time (ms)	Bandwidth (kHz)	Height (cm)	Polarization	Azimuth (deg)	Corr. (dB)	Margin (dB)	Limit (dBµV/m)	Comment
35.356650	12.5	1000.0	120.000	105.0	V	196.0	13.1	17.5	30.0	
101.994750	9.4	1000.0	120.000	170.0	V	171.0	11.7	24.1	33.5	
319.969650	23.3	1000.0	120.000	98.0	V	273.0	15.2	12.7	36.0	
732.031200	20.1	1000.0	120.000	170.0	H	8.0	23.2	16.0	36.0	
828.885450	20.9	1000.0	120.000	170.0	H	173.0	24.2	15.1	36.0	
930.453300	21.9	1000.0	120.000	170.0	V	-7.0	25.3	14.1	36.0	

Plot 12: Highest channel, 1 GHz to 12.75 GHz, vertical and horizontal polarization, also valid for 20m

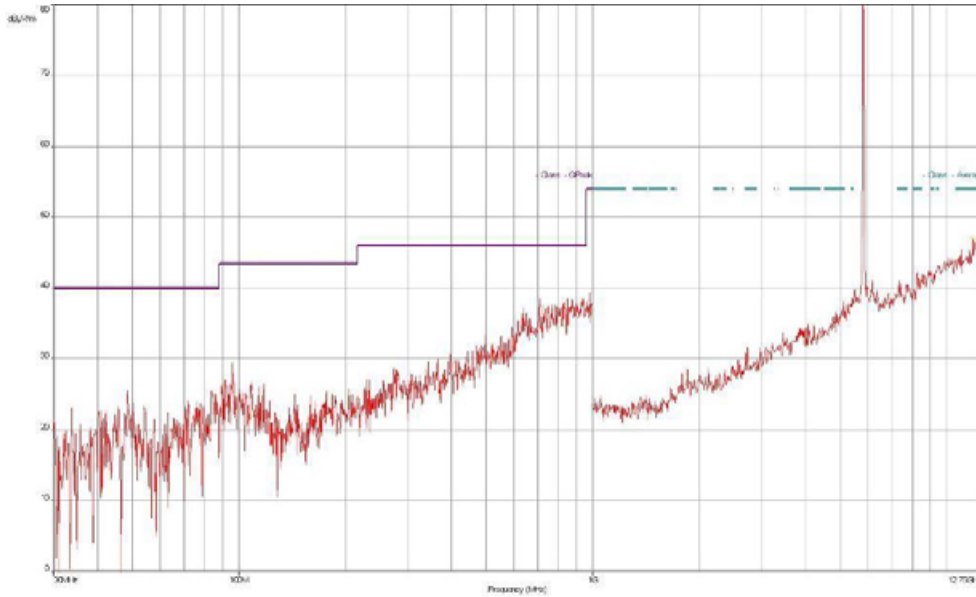

Plot 13: Highest channel, 12 GHz to 18 GHz (vertical / horizontal – max hold – also valid for 20m)

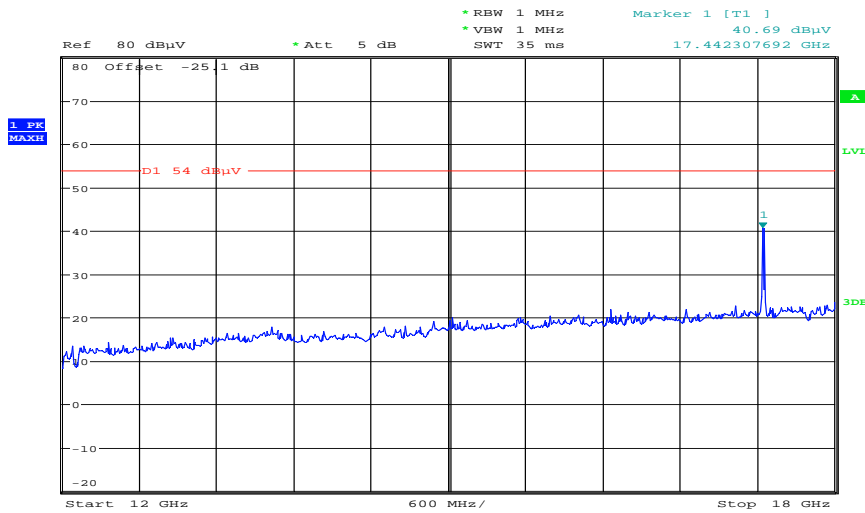

Date: 12.MAR.2012 11:47:43

Plot 14: Highest channel, 18 GHz to 25 GHz (vertical / horizontal – max hold – also valid for 20m)

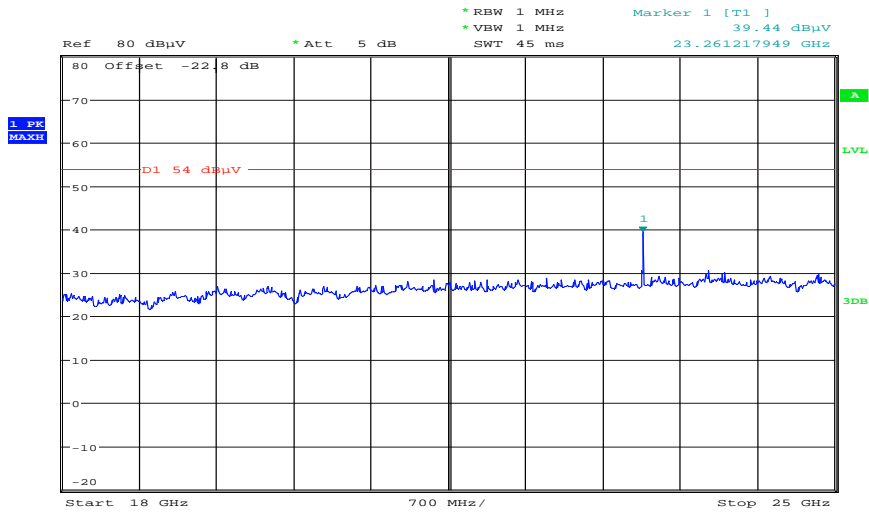

Date: 12.MAR.2012 10:31:48

Plot 15: Highest channel, 25 GHz to 40 GHz (vertical / horizontal – max hold – also valid for 20m)

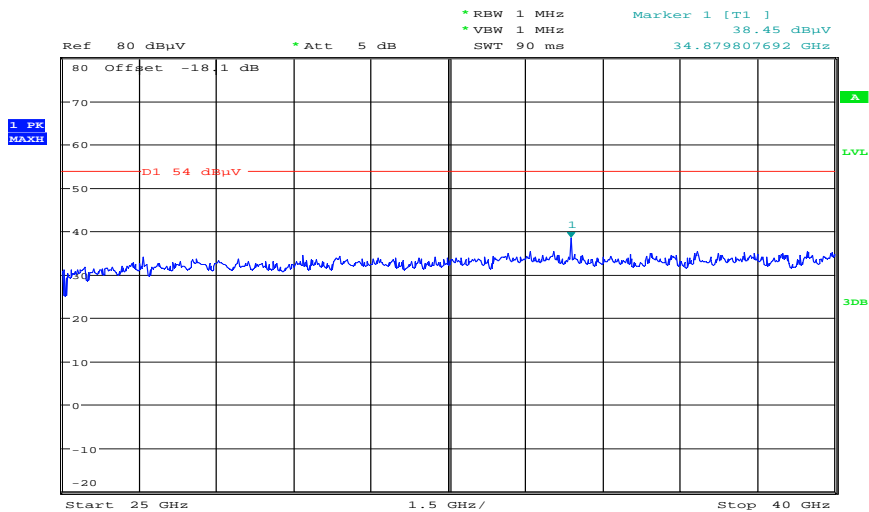

Date: 12.MAR.2012 11:00:42

Plots: Omnidirectional antenna B with 10 m cable

Plot 1: Lowest channel, 30 MHz to 1 GHz, vertical & horizontal polarization, also valid for 20m

Common Information

EUT: Quinta CU
 Serial Number: 00101
 Test Description: FCC part 15 B class B
 Operating Conditions: ANT B, tx@5736MHz
 Operator Name: Hennemann
 Comment: AC: 115 V / 60 Hz; ETH-cable S/FTP; 2x SWA2459+10m cable

Scan Setup: STAN_Fin [EMI radiated]

Hardware Setup: Electric Field (NOS)
 Receiver: [ESCI 3]
 Level Unit: dBµV/m
Subrange **Step Size** **Detectors** **IF BW** **Meas. Time** **Preamp**
 30 MHz - 2 GHz 60 kHz QPK 120 kHz 1 s 20 dB

FCC_10m(B)_3

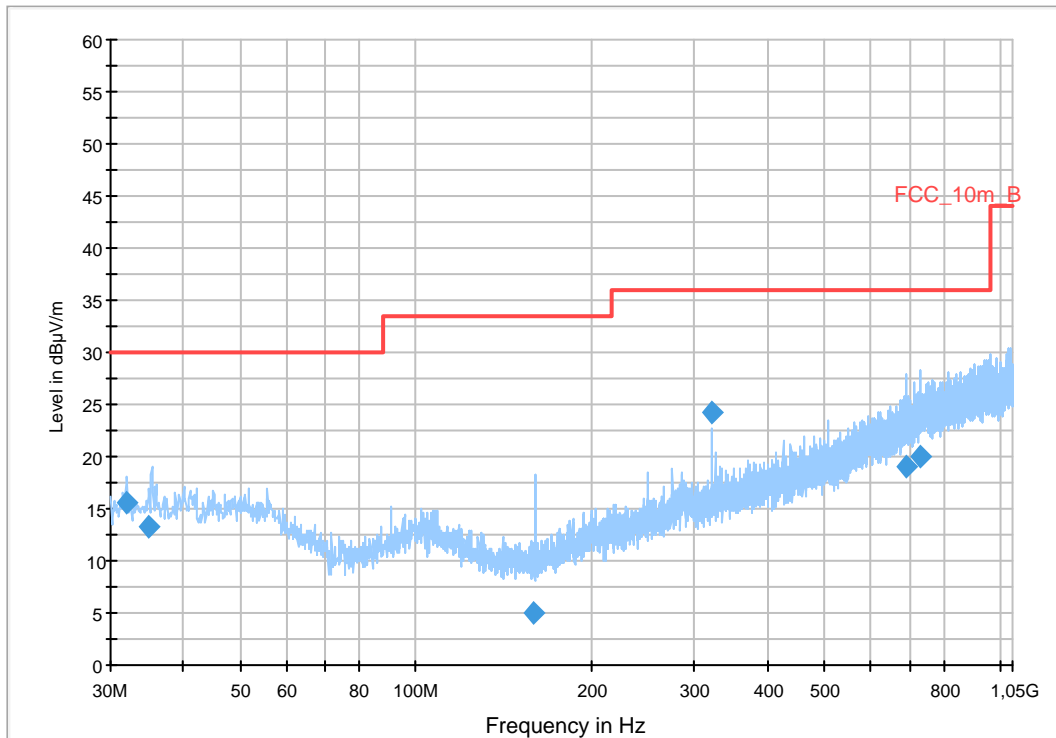

Final Result 1

Frequency (MHz)	QuasiPeak (dBµV/m)	Meas. Time (ms)	Bandwidth (kHz)	Height (cm)	Polarization	Azimuth (deg)	Corr. (dB)	Margin (dB)	Limit (dBµV/m)	Comment
31.964700	15.6	1000.0	120.000	98.0	V	91.0	12.7	14.4	30.0	
34.959750	13.3	1000.0	120.000	170.0	V	283.0	13.0	16.7	30.0	
159.512400	5.0	1000.0	120.000	170.0	V	82.0	9.2	28.5	33.5	
319.992600	24.2	1000.0	120.000	98.0	V	273.0	15.2	11.8	36.0	
692.791800	19.1	1000.0	120.000	170.0	H	8.0	22.3	16.9	36.0	
728.431350	20.0	1000.0	120.000	142.0	V	185.0	23.2	16.0	36.0	

Plot 2: Lowest channel, 1 GHz to 12.75 GHz, vertical and horizontal polarization, also valid for 20m

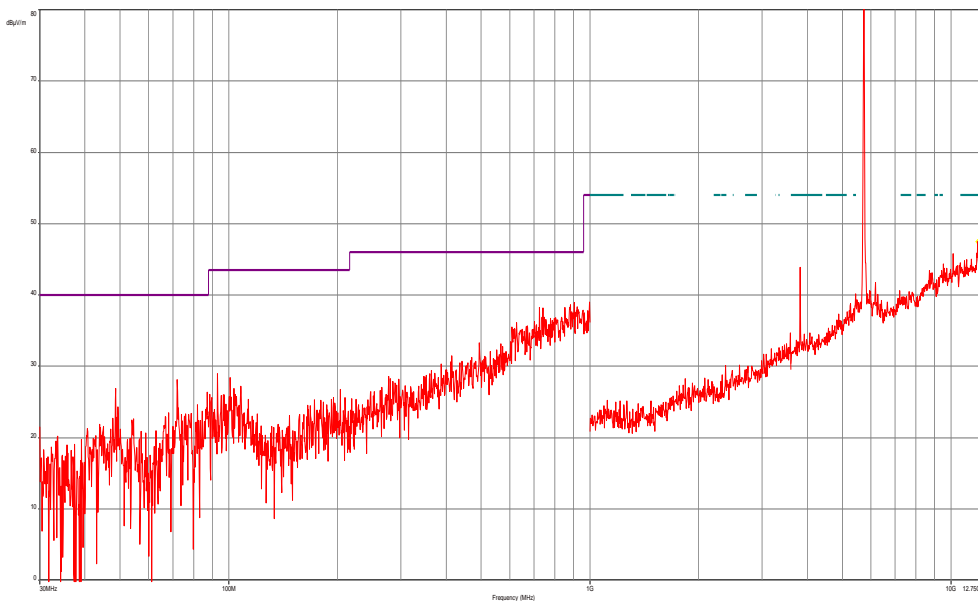

Plot 3: Lowest channel, 12 GHz to 18 GHz (vertical / horizontal – max hold – also valid for 20m)

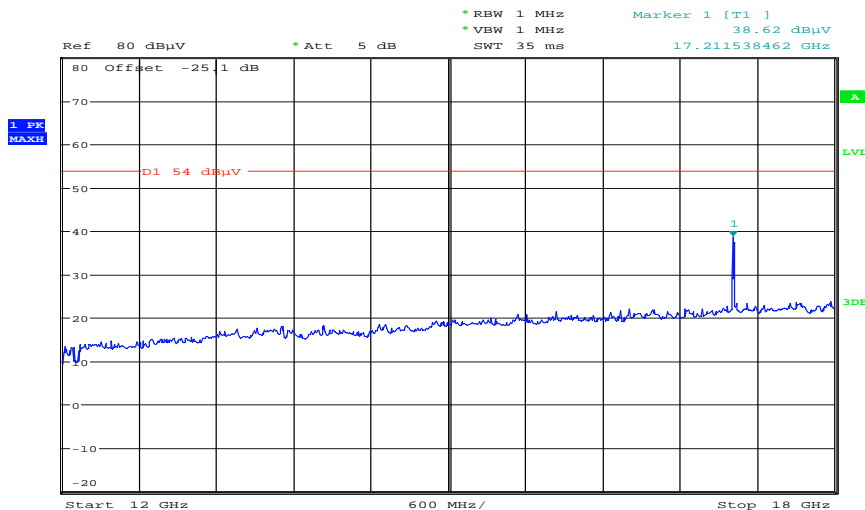

Date: 12.MAR.2012 11:56:51

Plot 4: Lowest channel, 18 GHz to 25 GHz (vertical / horizontal – max hold – also valid for 20m)

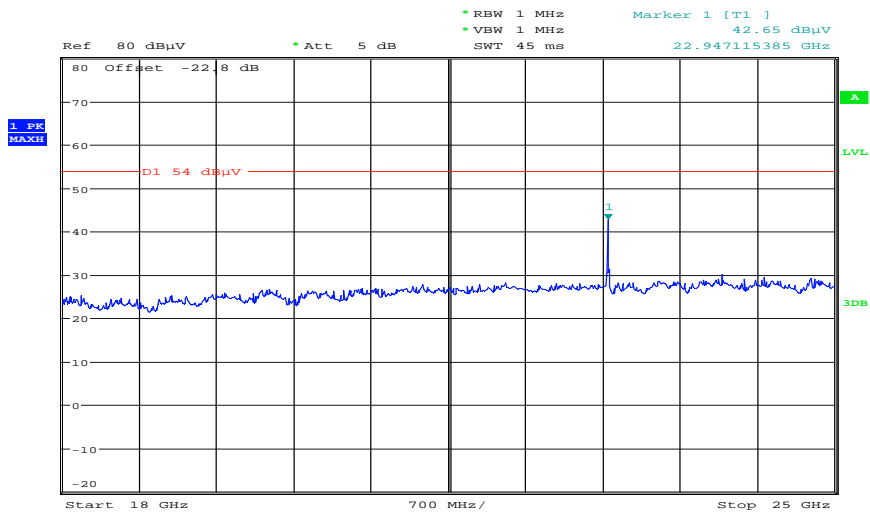

Date: 12.MAR.2012 10:32:33

Plot 5: Lowest channel, 25 GHz to 40 GHz (vertical / horizontal – max hold – also valid for 20m)

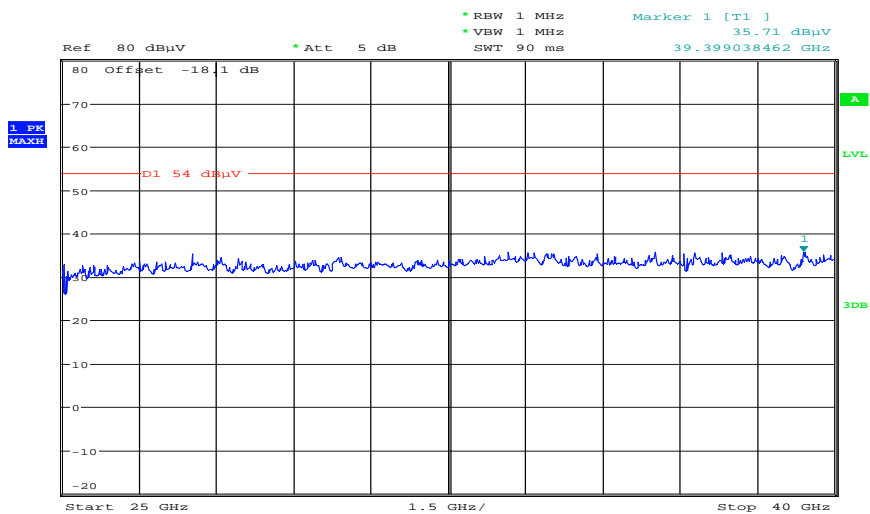

Date: 12.MAR.2012 10:57:41

Plot 6: Middle channel, 30 MHz to 1 GHz, vertical & horizontal polarization, also valid for 20m

Common Information

EUT: Quinta CU
 Serial Number: 00101
 Test Description: FCC part 15 B class B
 Operating Conditions: ANT B, tx@5762MHz
 Operator Name: Hennemann
 Comment: AC: 115 V / 60 Hz; ETH-cable S/FTP; 2x SWA2459+10m cable

Scan Setup: STAN_Fin [EMI radiated]

Hardware Setup: Electric Field (NOS)
 Receiver: [ESCI 3]
 Level Unit: dBµV/m

Subrange	Step Size	Detectors	IF BW	Meas. Time	Preamp
30 MHz - 2 GHz	60 kHz	QPK	120 kHz	1 s	20 dB

FCC_10m(B)_3

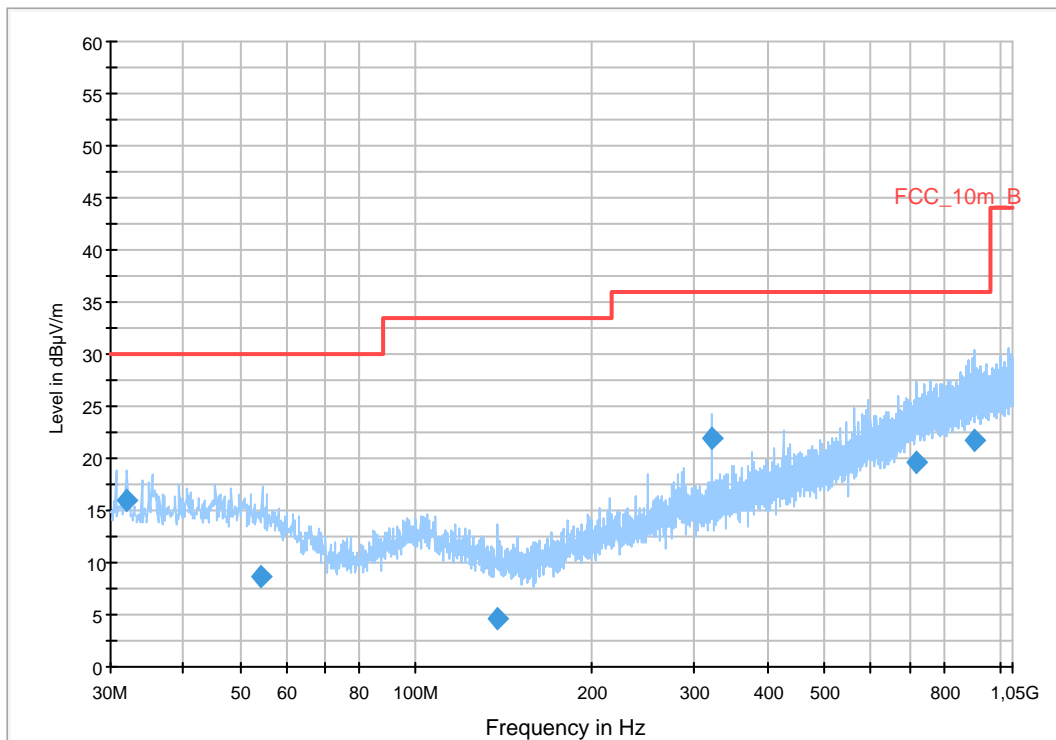

Final Result 1

Frequency (MHz)	QuasiPeak (dBµV/m)	Meas. Time (ms)	Bandwidth (kHz)	Height (cm)	Polarization	Azimuth (deg)	Corr. (dB)	Margin (dB)	Limit (dBµV/m)	Comment
31.995150	15.9	1000.0	120.000	115.0	V	187.0	12.7	14.1	30.0	
54.073350	8.6	1000.0	120.000	98.0	V	196.0	13.0	21.4	30.0	
137.471100	4.7	1000.0	120.000	106.0	H	-6.0	8.8	28.8	33.5	
319.949550	22.0	1000.0	120.000	98.0	V	270.0	15.2	14.0	36.0	
720.309000	19.7	1000.0	120.000	124.0	V	266.0	23.0	16.3	36.0	
905.801700	21.8	1000.0	120.000	170.0	V	196.0	25.2	14.2	36.0	

Plot 7: Middle channel, 1 GHz to 12.75 GHz, vertical and horizontal polarization, also valid for 20m

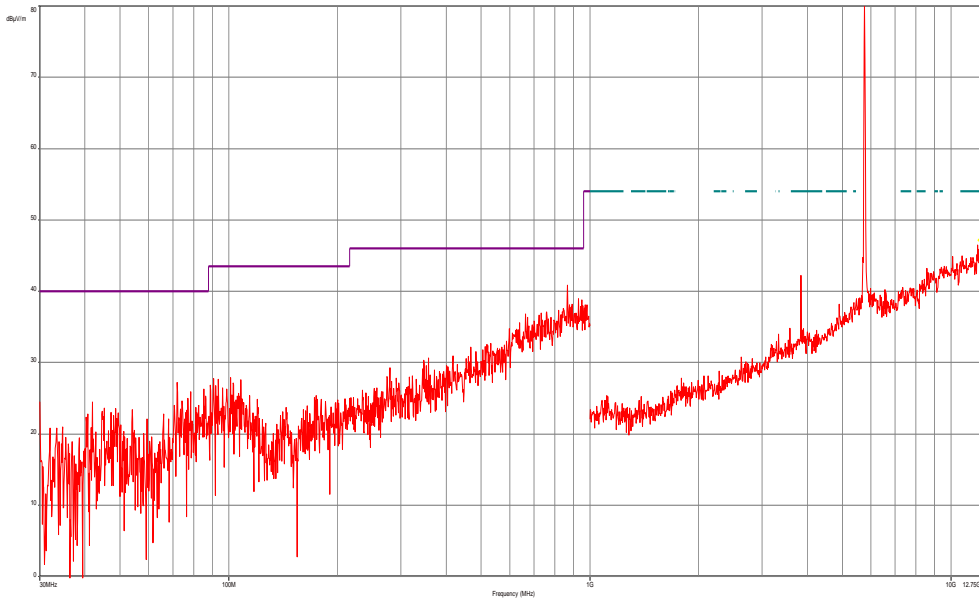

Plot 8: Middle channel, 12 GHz to 18 GHz (vertical / horizontal – max hold – also valid for 20m)

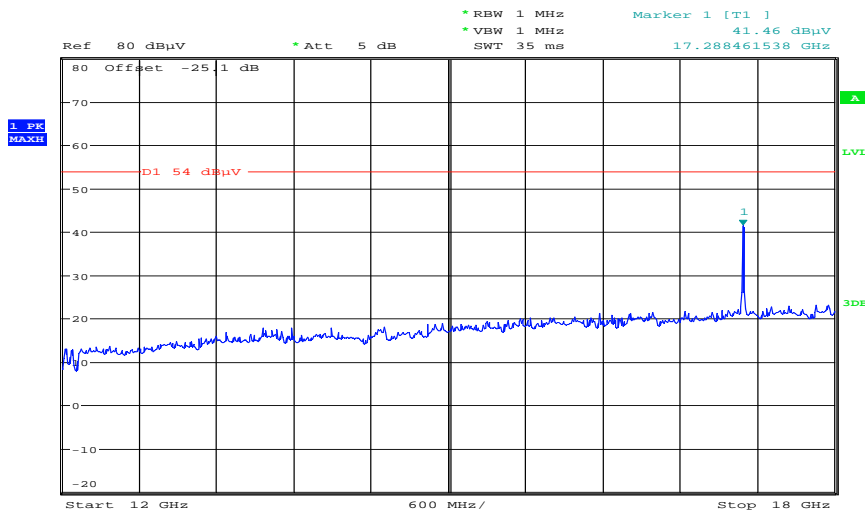

Date: 12.MAR.2012 11:57:42

Plot 9: Middle channel, 18 GHz to 25 GHz (vertical / horizontal – max hold – also valid for 20m)

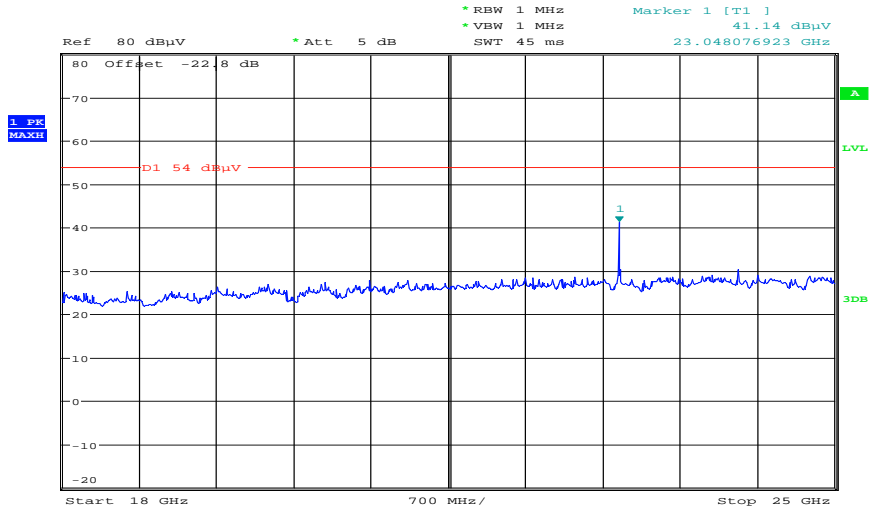

Date: 12.MAR.2012 10:33:09

Plot 10: Middle channel, 25 GHz to 40 GHz (vertical / horizontal – max hold – also valid for 20m)

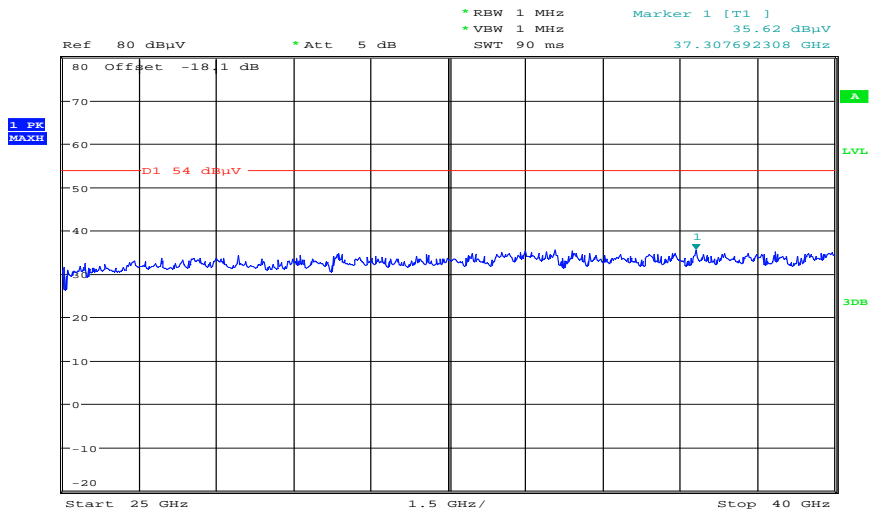

Date: 12.MAR.2012 10:58:14

Plot 11: Highest channel, 30 MHz to 1 GHz, vertical & horizontal polarization, also valid for 20m

Common Information

EUT: Quinta CU
 Serial Number: 00101
 Test Description: FCC part 15 B class B
 Operating Conditions: ANT B, tx@5814MHz
 Operator Name: Hennemann
 Comment: AC: 115 V / 60 Hz; ETH-cable S/FTP; 2x SWA2459+10m cable

Scan Setup: STAN_Fin [EMI radiated]

Hardware Setup: Electric Field (NOS)
 Receiver: [ESCI 3]
 Level Unit: dBµV/m

Subrange	Step Size	Detectors	IF BW	Meas. Time	Preamp
30 MHz - 2 GHz	60 kHz	QPK	120 kHz	1 s	20 dB

FCC_10m(B)_3

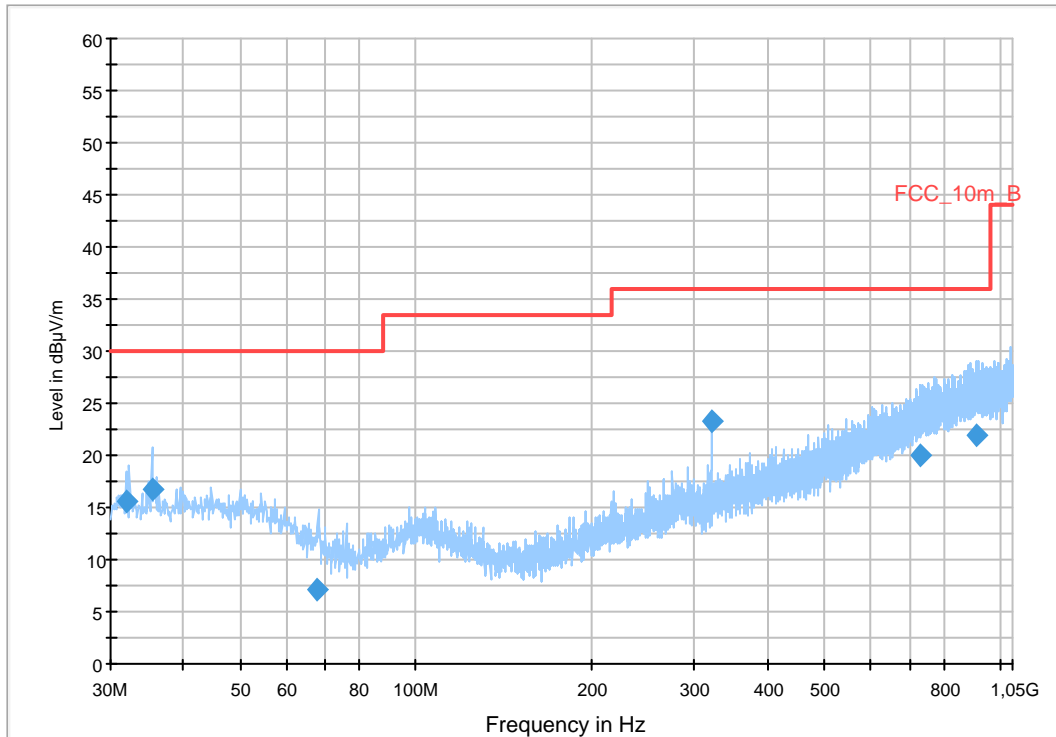

Final Result 1

Frequency (MHz)	QuasiPeak (dBµV/m)	Meas. Time (ms)	Bandwidth (kHz)	Height (cm)	Polarization	Azimuth (deg)	Corr. (dB)	Margin (dB)	Limit (dBµV/m)	Comment
32.020050	15.6	1000.0	120.000	124.0	V	106.0	12.7	14.4	30.0	
35.368950	16.8	1000.0	120.000	156.0	V	8.0	13.1	13.2	30.0	
67.662450	7.2	1000.0	120.000	124.0	V	196.0	9.8	22.8	30.0	
319.981200	23.4	1000.0	120.000	106.0	V	285.0	15.2	12.6	36.0	
731.469150	20.0	1000.0	120.000	174.0	V	182.0	23.2	16.0	36.0	
913.767150	21.9	1000.0	120.000	174.0	V	284.0	25.2	14.1	36.0	

Plot 12: Highest channel, 1 GHz to 12.75 GHz, vertical and horizontal polarization, also valid for 20m

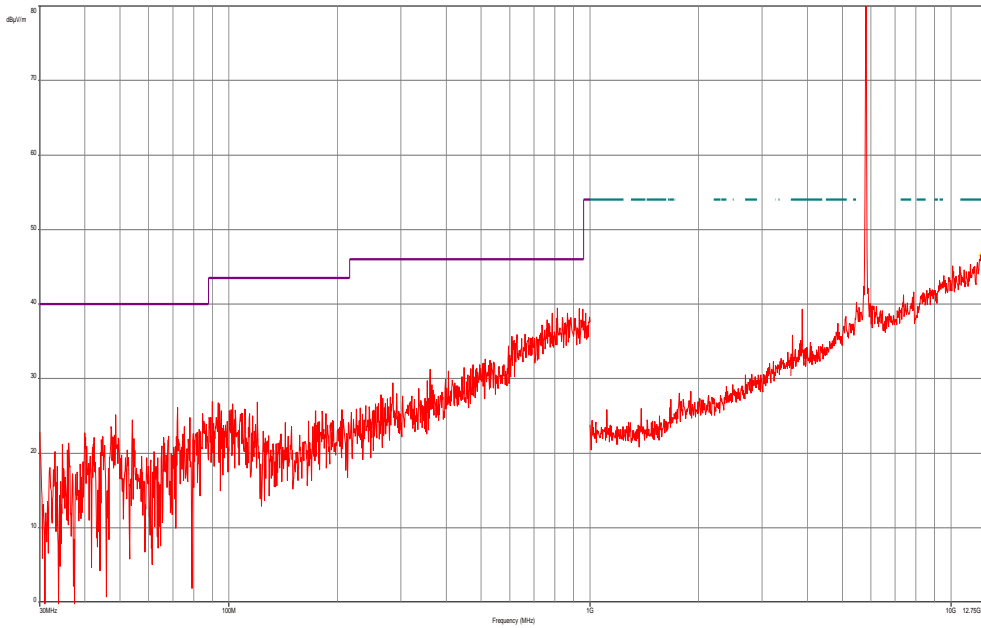

Plot 13: Highest channel, 12 GHz to 18 GHz (vertical / horizontal – max hold – also valid for 20m)

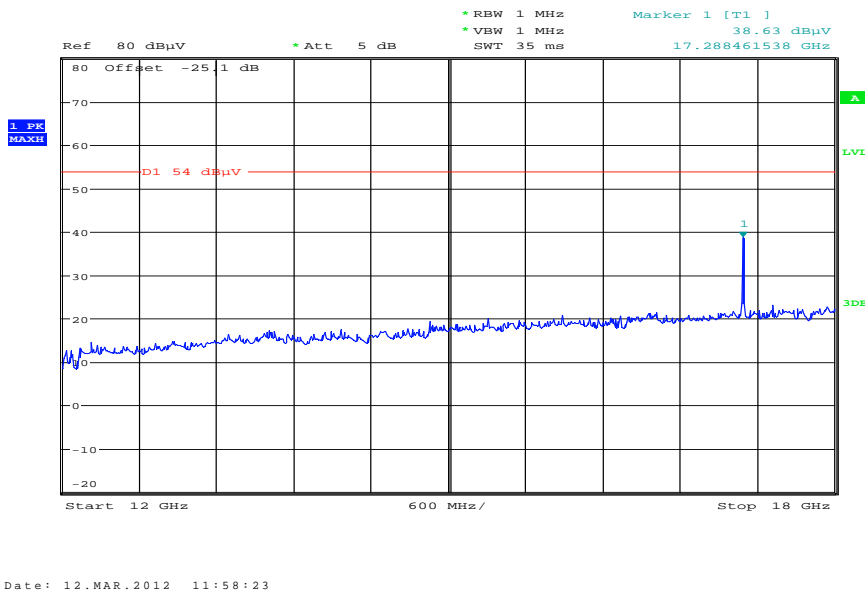

9.8 RX spurious emissions radiated

Description:

Measurement of the radiated spurious emissions in idle/receive mode. The results are valid for both antennas.

Measurement:

Measurement parameter	
Detector:	Peak / Quasi Peak
Sweep time:	Auto
Video bandwidth:	Sweep: 100 kHz Remeasurement: 10 Hz
Resolution bandwidth:	F < 1 GHz: 100 kHz F > 1 GHz: 1 MHz
Span:	30 MHz to 26 GHz
Trace-Mode:	Max Hold

Limits:

FCC		IC	
CFR Part 15.109		RSS Gen, Issue 2, 4.10	
RX Spurious Emissions Radiated			
Frequency (MHz)	Field Strength (dBµV/m)	Measurement distance	
30 - 88	30.0	10	
88 – 216	33.5	10	
216 – 960	36.0	10	
Above 960	54.0	3	

Results:

RX Spurious Emissions Radiated [dBµV/m]		
F [MHz]	Detector	Level [dBµV/m]
No critical peaks detected		
Measurement uncertainty	± 3 dB	

Result: Passed

Plots: RX / Idle – mode

Plot 1: 30 MHz to 1 GHz, vertical & horizontal polarization

Common Information

EUT: Quinta CU
 Serial Number: 00101
 Test Description: FCC part 15 class B @ 10 m
 Operating Conditions: RX mode 5,8GHz band
 Operator Name: Wolsdorfer
 Comment: AC: 115 V / 60 Hz; ETH-cable S/FTP; 2x SPA2456 antenna + 10m cable

Scan Setup: STAN_Fin [EMI radiated]

Hardware Setup: Electric Field (NOS)
 Receiver: [ESCI 3]
 Level Unit: dBµV/m

Subrange	Step Size	Detectors	IF BW	Meas. Time	Preamp
30 MHz - 2 GHz	60 kHz	QPK	120 kHz	1 s	20 dB

FCC_10m(B)_5

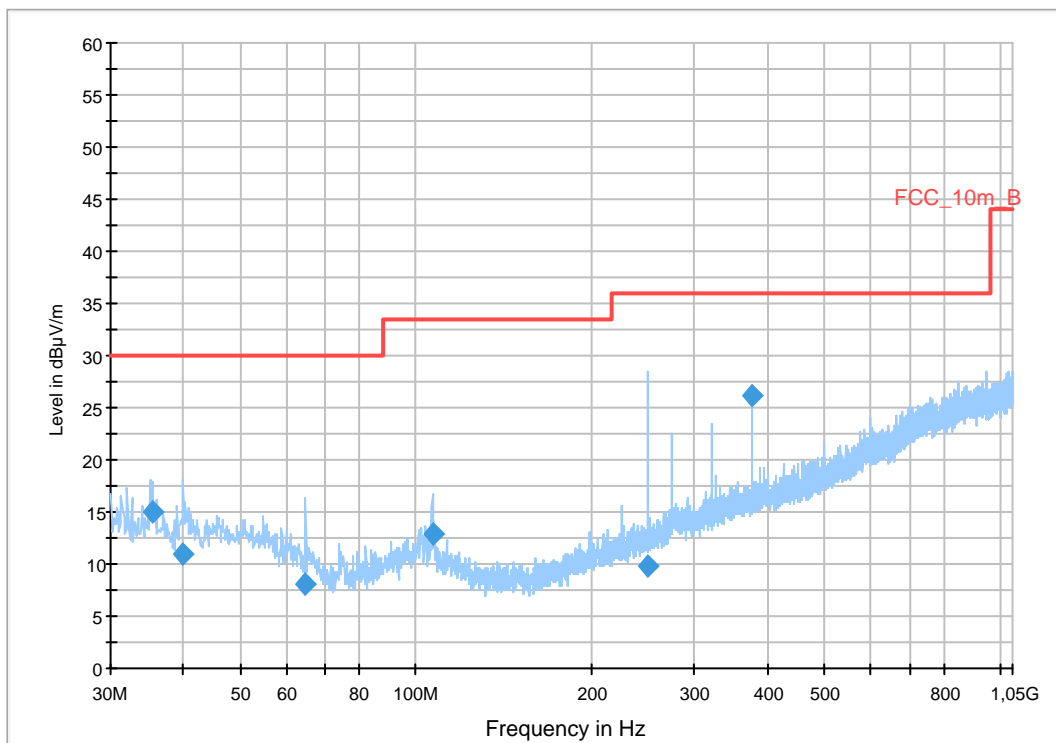

Final Result 1

Frequency (MHz)	QuasiPeak (dBµV/m)	Meas. Time (ms)	Bandwidth (kHz)	Height (cm)	Polarization	Azimuth (deg)	Corr. (dB)	Margin (dB)	Limit (dBµV/m)	Comment
35.400000	15.0	1000.0	120.000	146.0	V	265.0	13.1	15.0	30.0	
39.960000	10.9	1000.0	120.000	186.0	V	295.0	13.4	19.1	30.0	
64.800000	8.2	1000.0	120.000	249.0	V	142.0	10.5	21.8	30.0	
106.680000	13.0	1000.0	120.000	134.0	V	129.0	11.3	20.5	33.5	
250.080000	9.8	1000.0	120.000	98.0	V	-2.0	13.3	26.2	36.0	
375.000000	26.1	1000.0	120.000	105.0	V	48.0	16.5	9.9	36.0	

Plot 2: 1 GHz to 12.75 GHz, vertical polarization

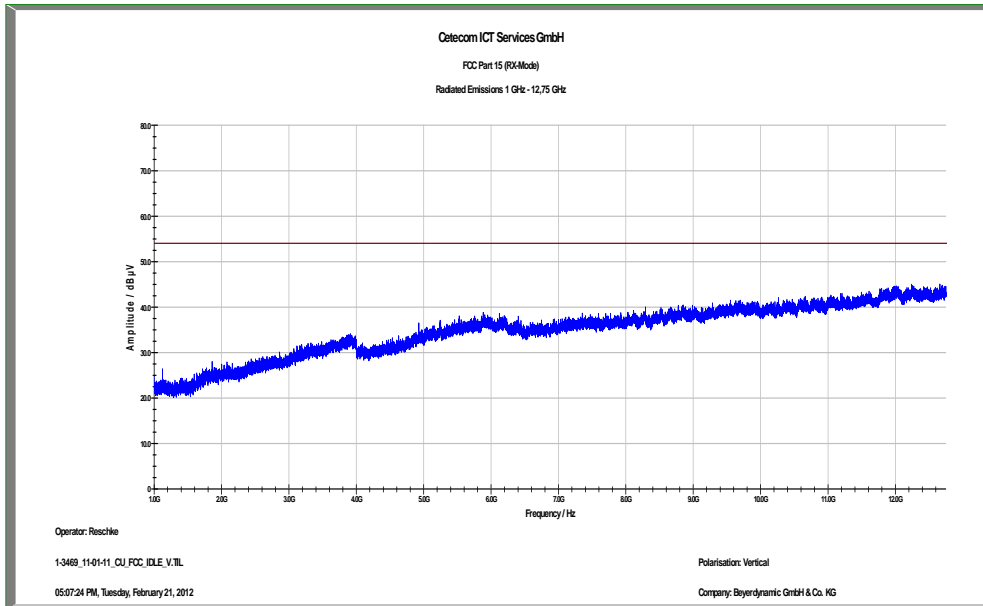

Plot 3: 1 GHz to 12.75 GHz, horizontal polarization

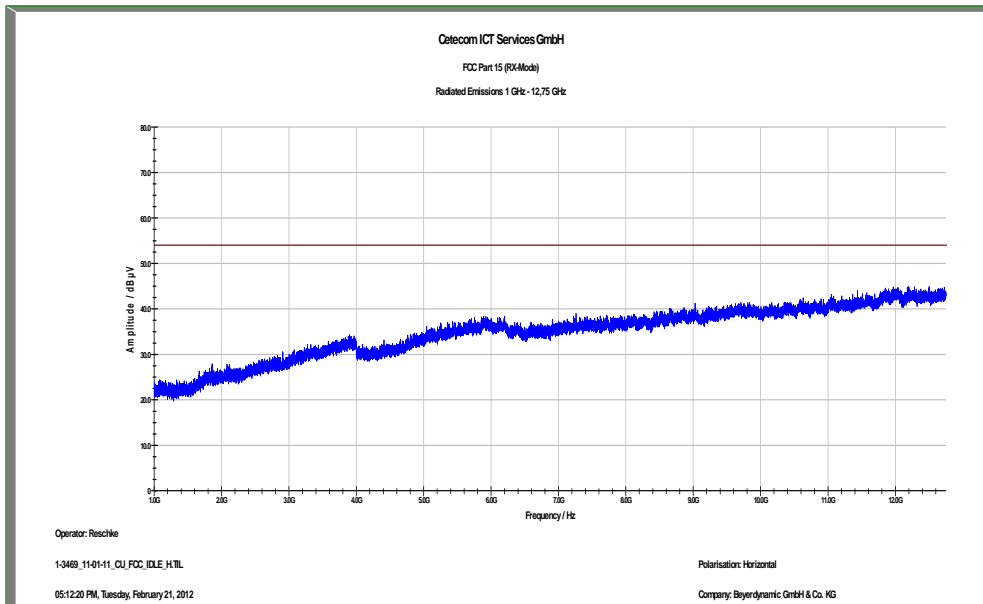

9.9 TX spurious emissions radiated < 30 MHz

Description:

Measurement of the radiated spurious emissions in transmit mode below 30 MHz. The EUT is set to channel 6. This measurement is representative for all channels and modes. If critical peaks are found channel 1 and channel 11 will be measured too. The measurement is performed with the data rate producing the highest output power. The limits are recalculated to a measurement distance of 3 m with 40 dB/decade according CFR Part 2.

Measurement:

Measurement parameter	
Detector:	Peak / Quasi Peak
Sweep time:	Auto
Video bandwidth:	F < 150 kHz: 200 Hz F > 150 kHz: 9 kHz
Resolution bandwidth:	F < 150 kHz: 1 kHz F > 150 kHz: 100 kHz
Span:	9 kHz to 30 MHz
Trace-Mode:	Max Hold

Limits:

FCC		IC	
CFR Part 15.209(a)		RSS –Gen	
TX Spurious Emissions Radiated < 30 MHz			
Frequency (MHz)	Field Strength (dBµV/m)	Measurement distance	
0.009 – 0.490	2400/F(kHz)	300	
0.490 – 1.705	24000/F(kHz)	30	
1.705 – 30.0	30	30	

Results:

TX Spurious Emissions Radiated < 30 MHz [dBµV/m]		
F [MHz]	Detector	Level [dBµV/m]
No critical peaks found		
Measurement uncertainty	± 3 dB	

Result: Passed

Plots: Rod antenna (valid for antenna A and antenna B)

Plot 1: 9 kHz to 30 MHz (valid for all channels)

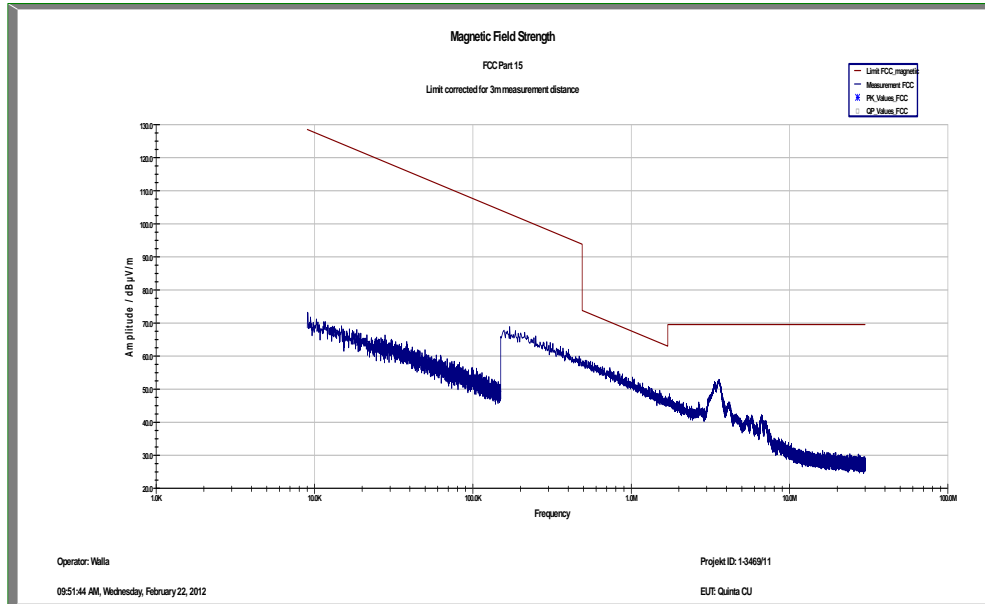

Plots: Planar antenna (valid for antenna A and antenna B)

Plot 2: Middle channel, (valid for all channels)

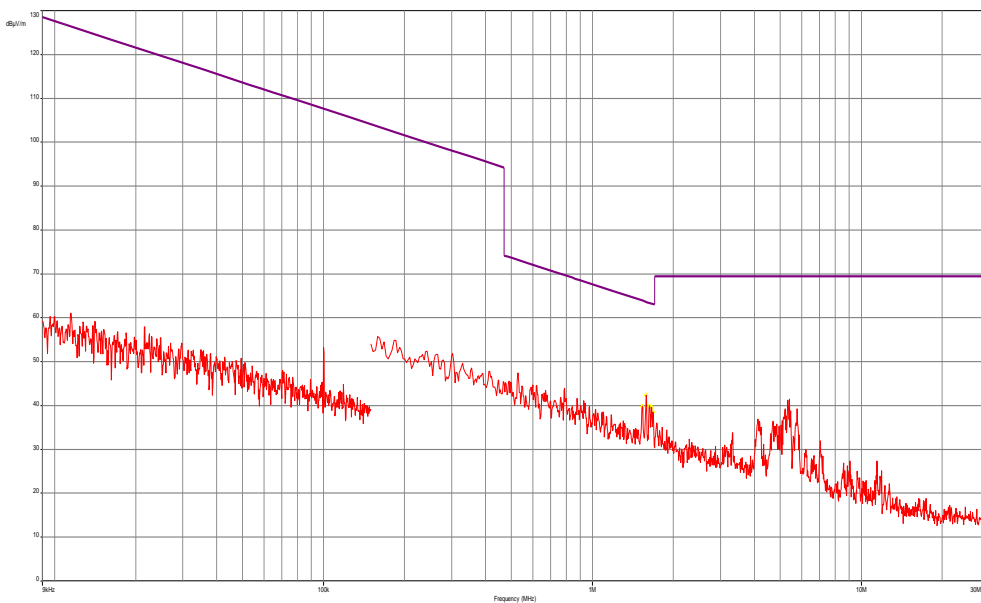

Plots: Omnidirectional antenna (valid for antenna A and antenna B)

Plot 3: Highest channel, (valid for all channels)

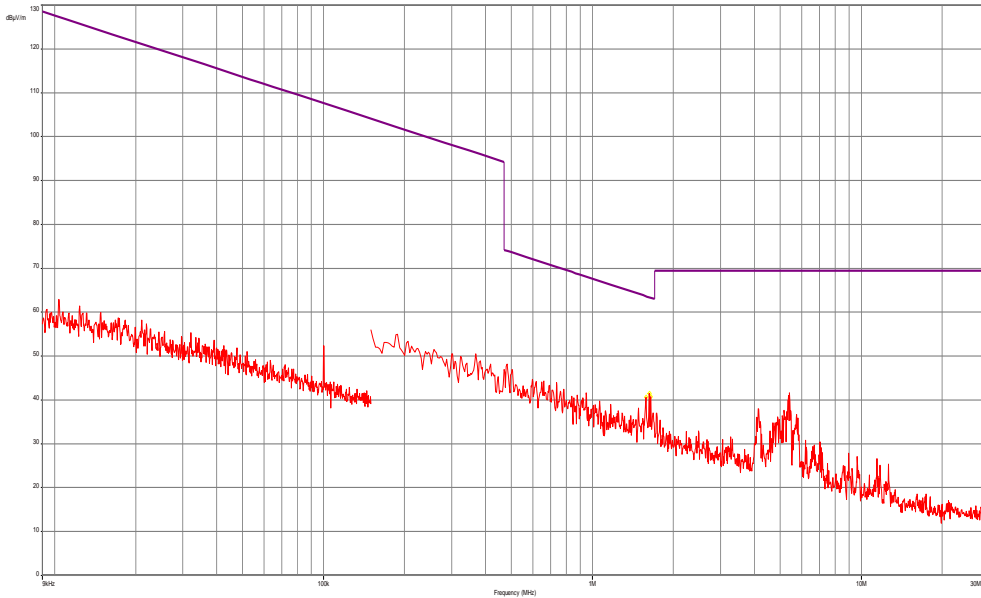

Plots: RX / Idle – mode (valid for antenna A and antenna B)

Plot 1: 9 kHz to 30 MHz

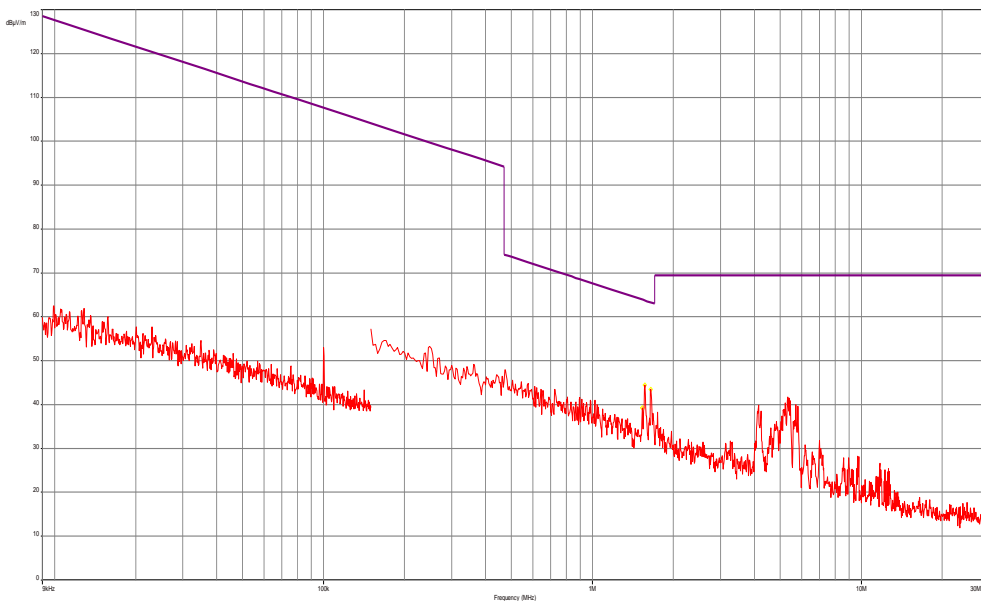

9.10 TX spurious emissions conducted < 30 MHz

Description:

Measurement of the conducted spurious emissions in transmit mode below 30 MHz. The EUT is set to channel 6. This measurement is repeated for DSSS and DSSS modulation. If critical peaks are found channel 1 and channel 11 will be measured too. The measurement is performed with the data rate producing the highest output power. Both power lines, phase and neutral line, are measured. Found peaks are remeasured with average and quasi peak detection to show compliance to the limits.

Measurement:

Measurement parameter	
Detector:	Peak - Quasi Peak / Average
Sweep time:	Auto
Video bandwidth:	F < 150 kHz: 200 Hz F > 150 kHz: 9 kHz
Resolution bandwidth:	F < 150 kHz: 1 kHz F > 150 kHz: 100 kHz
Span:	9 kHz to 30 MHz
Trace-Mode:	Max Hold

Limits:

FCC		IC	
CFR Part 15.107(a)		ICES-003, Issue 4	
TX Spurious Emissions Conducted < 30 MHz			
Frequency (MHz)	Quasi-Peak (dBµV/m)	Average (dBµV/m)	
0.15 – 0.5	66 to 56*	56 to 46*	
0.5 – 5	56	46	
5 – 30.0	60	50	

*Decreases with the logarithm of the frequency

Results:

TX Spurious Emissions Conducted < 30 MHz [dBµV/m]		
F [MHz]	Detector	Level [dBµV/m]
No critical peaks detected		
Measurement uncertainty	± 3 dB	

Result: Passed

Plots:

Plot 1: 9 kHz to 30 MHz / phase and neutral Line, TX mode

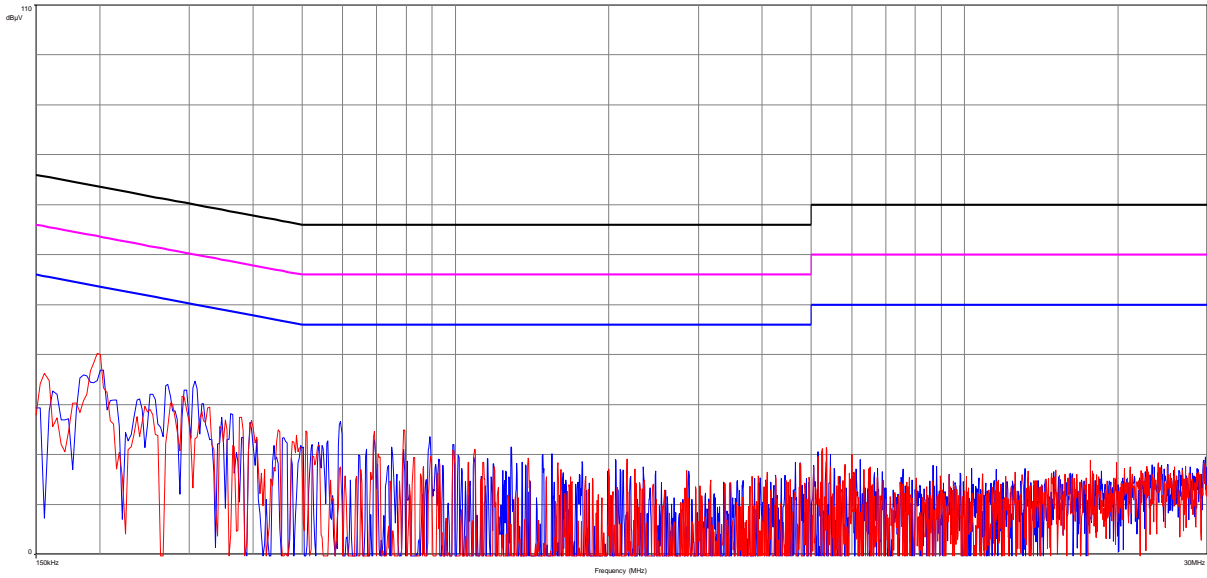

Plot 3: 9 kHz to 30 MHz / phase and neutral Line, RX mode

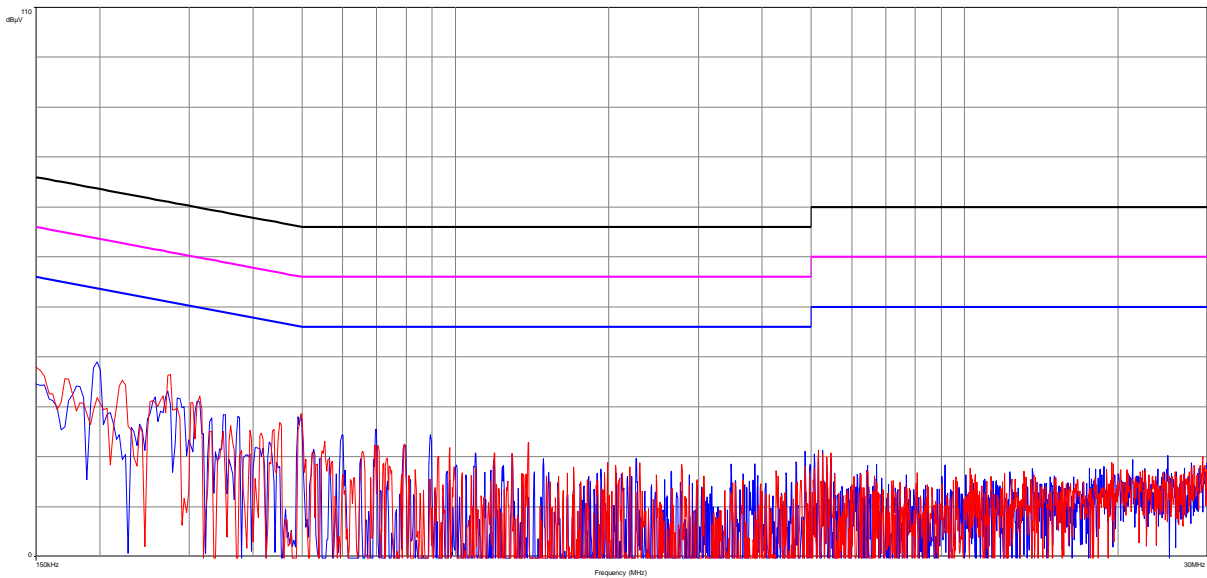

10 Test equipment and ancillaries used for tests

Typically, the calibrations of the test apparatus are commissioned to and performed by an accredited calibration laboratory. The calibration intervals are determined in accordance with the DIN EN ISO/IEC 17025. In addition to the external calibrations, the laboratory executes comparison measurements with other calibrated test systems or effective verifications. Weekly chamber inspections and range calibrations are performed. Where possible, rf-generating and signalling equipment as well as measuring receivers and analyzers are connected to an external high-precision 10 MHz reference (GPS-based or rubidium frequency standard).

In order to simplify the identification of the equipment used at some special tests, some items of test equipment and ancillaries can be provided with an identifier or number in the equipment list below (Labor/Item).

No.	Lab / Item	Equipment	Type	Manufact.	Serial No.	INV. No Cetecom	Kind of Calibration	Last Calibration	Next Calibration
1	45	Switch-Unit	3488A	HP Meßtechnik	2719A14505	300000368	g		
2	50	DC power supply, 60Vdc, 50A, 1200 W	6032A	HP Meßtechnik	2920A04466	300000580	ne		
3	n. a.	software	SPS_PHE 1.4f	Spitzberger & Spieß	B5981; 5D1081; B5979	300000210	ne		
4	n. a.	EMI Test Receiver	ESCI 1166.5950.03	R&S	100083	300003312	k	05.01.2011	05.01.2013
5	n. a.	Analyzer-Reference-System (Harmonics and Flicker)	ARS 16/1	SPS	A3509 07/0 0205	300003314	k	14.07.2011	14.07.2013
6	n. a.	Amplifier	JS42-00502650-28-5A	MITEQ	1084532	300003379	ev		
7	n. a.	Antenna Tower	Model 2175	ETS-LINDGREN	64762	300003745	izw		
8	n. a.	Positioning Controller	Model 2090	ETS-LINDGREN	64672	300003746	izw		
9	n. a.	Turntable Interface-Box	Model 105637	ETS-LINDGREN	44583	300003747	izw		
10	n. a.	TRILOG Broadband Test-Antenna 30 MHz - 3 GHz	VULB9163	Schwarzbeck	295	300003787	k	01.04.2010	01.04.2013
11	n. a.	Spectrum-Analyzer	FSU26	R&S	200809	300003874	k	10.01.2011	10.01.2013
12	n. a.	Isolating Transformer	RT5A	Grundig	8041	300001626	g		
13	n. a.	DC power supply, 60Vdc, 50A, 1200 W	6032A	HP Meßtechnik	2818A03450	300001040	Ve	12.01.2012	12.01.2015
14	n. a.	Coaxial Attenuator 30dB/500W	8325	Bird	1530	300001595	ev		
15	n. a.	Double-Ridged Waveguide Horn Antenna 1-18.0GHz	3115	EMCO	8812-3088	300001032	vIKI!	11.05.2011	11.05.2013
16	n. a.	Active Loop Antenna	6502	EMCO	2210	300001015	ne		
17	n. a.	Anechoic chamber	FAC 3/5m	MWB / TDK	87400/02	300000996		23.03.2009	
18	Spec.A. 2_2e	System rack for EMI measurement solution	85900	HP I.V.	*	300000222	ne		
19	9	Artificial Mains 9 kHz to 30 MHz	ESH3-Z5	R&S	828576/020	300001210	Ve	06.01.2012	06.01.2014
20	n. a.	Relais Matrix	3488A	HP Meßtechnik	2719A15013	300001156	ne		
21	n. a.	Relais Matrix	PSU	R&S	890167/024	300001168	ne		
22	n. a.	Isolating Transformer	RT5A	Grundig	9242	300001263	ne		
23	n. a.	Three-Way Power Splitter,	11850C	HP Meßtechnik		300000997	ne		

		50 Ohm							
24	n. a.	Switch / Control Unit	3488A	HP	2605e08770	300001443	ne		
25	n. a.	Amplifier	js42-00502650-28-5a	Parzich GMBH	928979	300003143	ne		
26	n. a.	Band Reject filter	WRCG1855/1910-1835/1925-40/8SS	Wainwright	7	300003350	ev		
27	n. a.	Band Reject filter	WRCG2400/2483-2375/2505-50/10SS	Wainwright	11	300003351	ev		
28	n. a.	TILE-Software Emission	Quantum Change, Modell TILE-ICS/FULL	EMCO	none	300003451	ne		
29	n. a.	Highpass Filter	WHKX2.9/18G-12SS	Wainwright	1	300003492	ev		
30	n. a.	Highpass Filter	WHK1.1/15G-10SS	Wainwright	3	300003255	ev		
31	n. a.	Highpass Filter	WHKX7.0/18G-8SS	Wainwright	18	300003789	ne		
32	n. a.	PSA Spectrum Analyzer 3 Hz - 26.5 GHz	E4440A	Agilent Technologies	MY48250080	300003812	k	08.09.2010	08.09.2012
33	n. a.	MXG Microwave Analog Signal Generator	N5183A	Agilent Technologies	MY47420220	300003813	k	13.09.2010	13.09.2012
34	n. a.	RF Filter Section 9kHz - 1GHz	N9039A	Agilent Technologies	MY48260003	300003825	vKI!	08.09.2010	08.09.2012
35	n. a.	TRIOLOG Broadband Test-Antenna 30 MHz - 3 GHz	VULB9163	Schwarzbeck	371	300003854	vKI!	14.10.2011	14.10.2014
36	11b	Microwave System Amplifier, 0.5-26.5 GHz	83017A	HP Meßtechnik	00419	300002268	ev	10.03.2011	
37	A026	Std. Gain Horn Antenna 12.4 to 18.0 GHz	639	Narda		300000787	ne		
38	A029	Std. Gain Horn Antenna 18.0 to 26.5 GHz	638	Narda		300002442	ne		
39	n. a.	Spectrum Analyzer 20 Hz - 50 GHz	FSU50	R&S	200012	300003443	ve	01.07.2010	01.07.2012
40	n. a.	Signal Analyzer 20Hz-26,5GHz-150 to + 30 DBM	FSIQ26	R&S	835111/0004	300002678	Ve	04.11.2010	04.11.2012

Agenda: Kind of Calibration

- | | | | |
|------|--|-----|--|
| k | calibration / calibrated | EK | limited calibration |
| ne | not required (k, ev, izw, zw not required) | zw | cyclical maintenance (external cyclical maintenance) |
| ev | periodic self verification | izw | internal cyclical maintenance |
| Ve | long-term stability recognized | g | blocked for accredited testing |
| vki! | Attention: extended calibration interval | *) | next calibration ordered / currently in progress |
| NK! | Attention: not calibrated | | |

11 Observations

No observations exceeding those reported with the single test cases have been made.

Annex A Photographs of the test setup

Photo documentation

Photo 1:

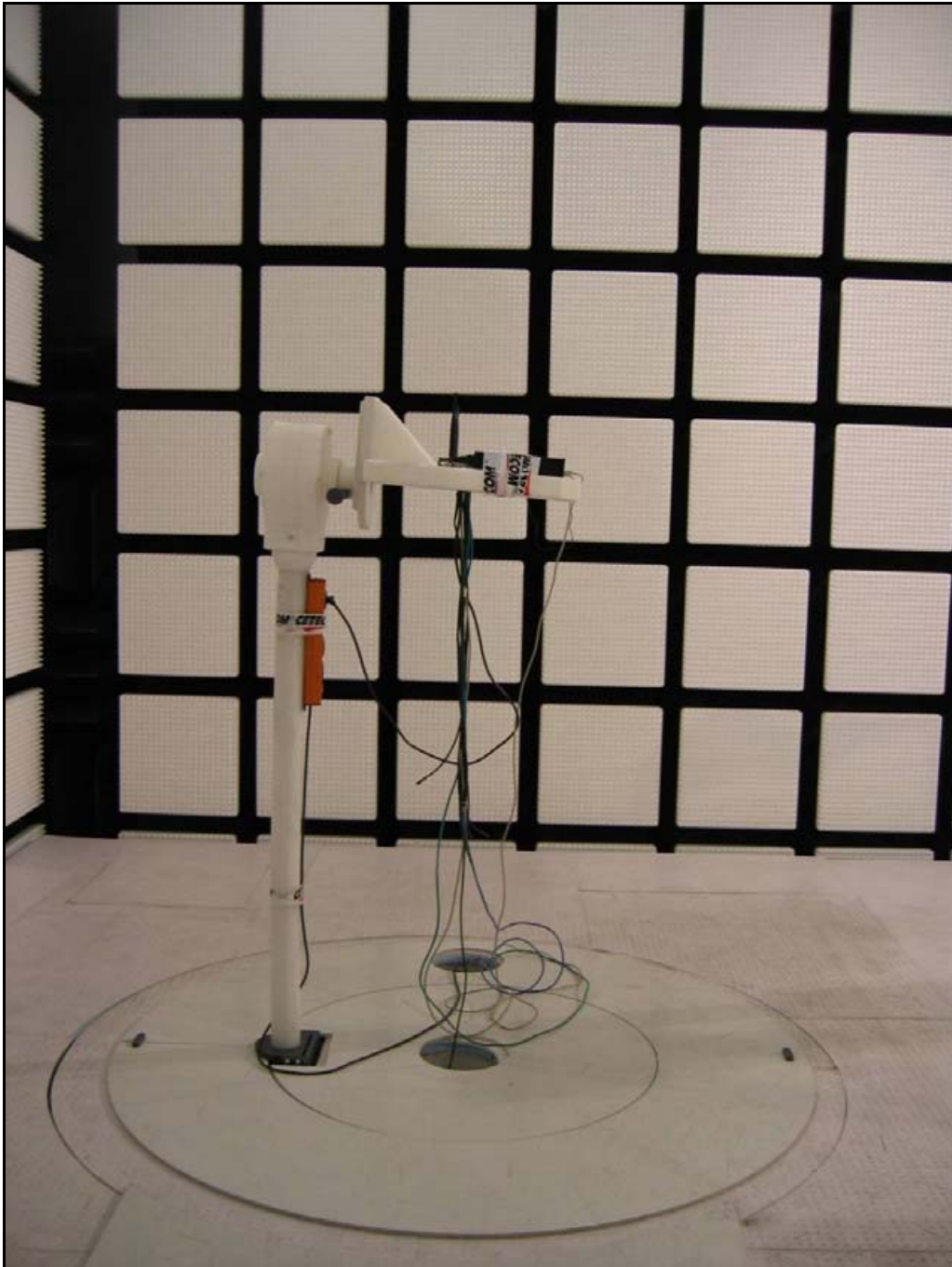

Photo 2:

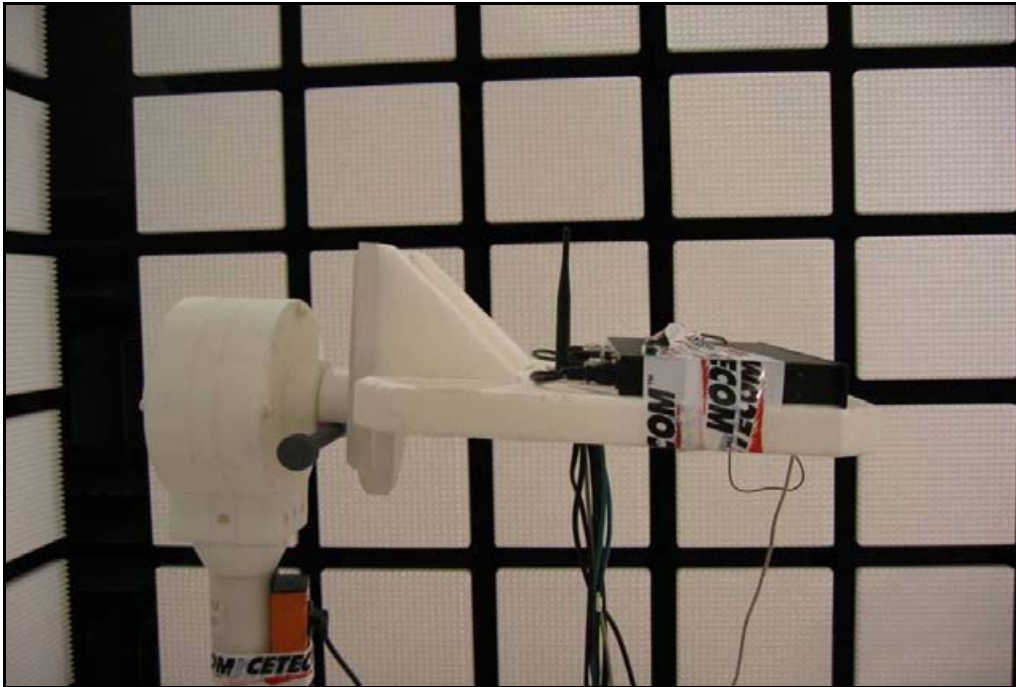

Photo 3:



Photo 4:

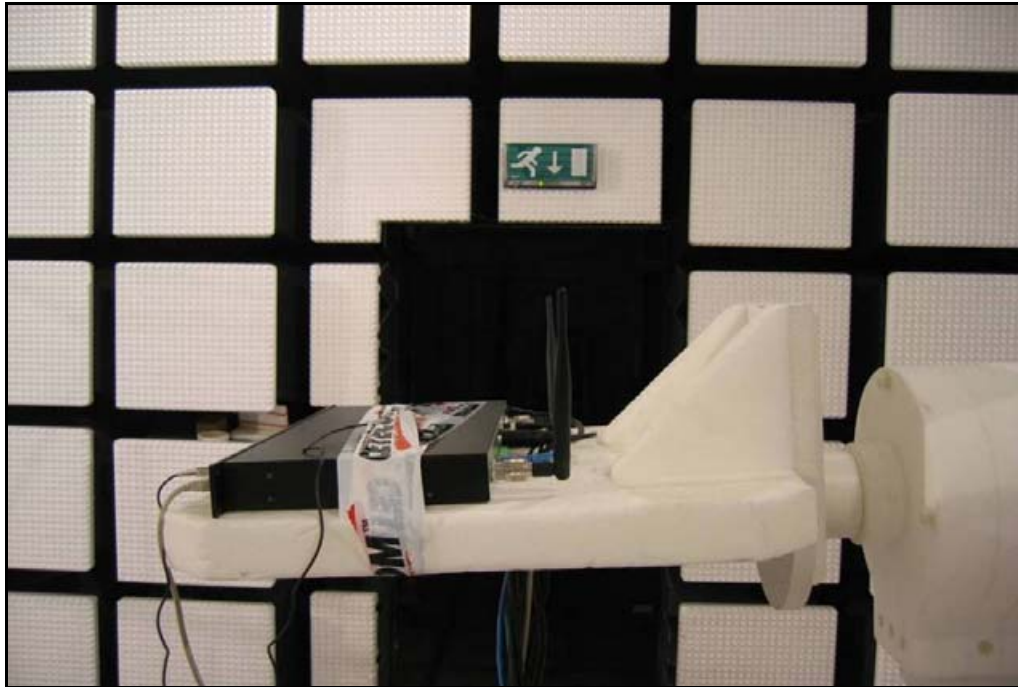

Photo 5:



Photo 6:

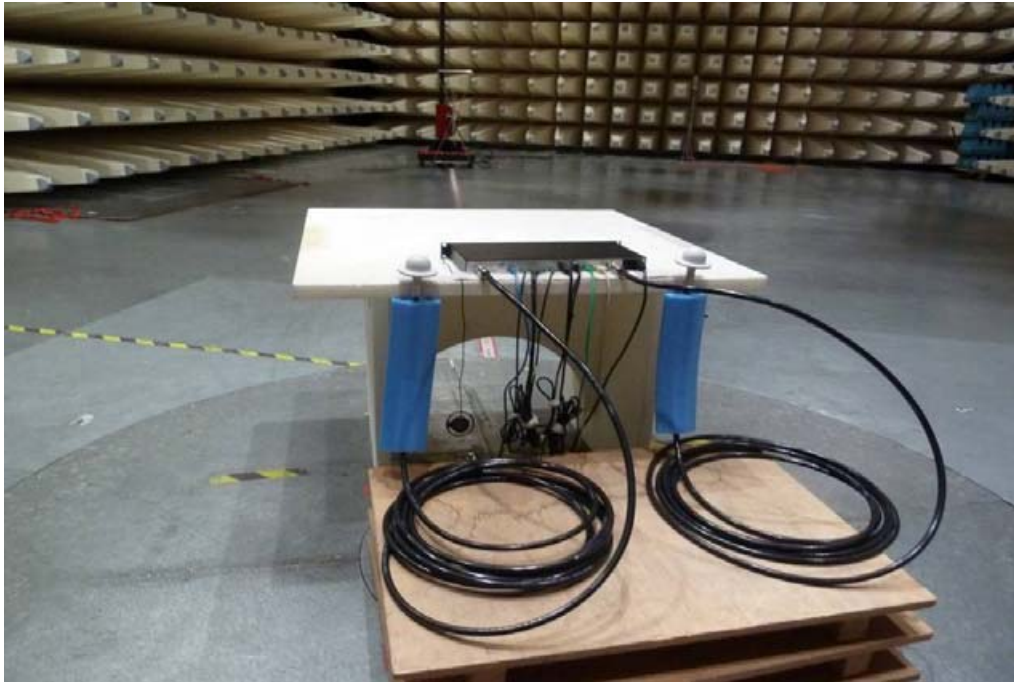

Photo 7:



Photo 8:

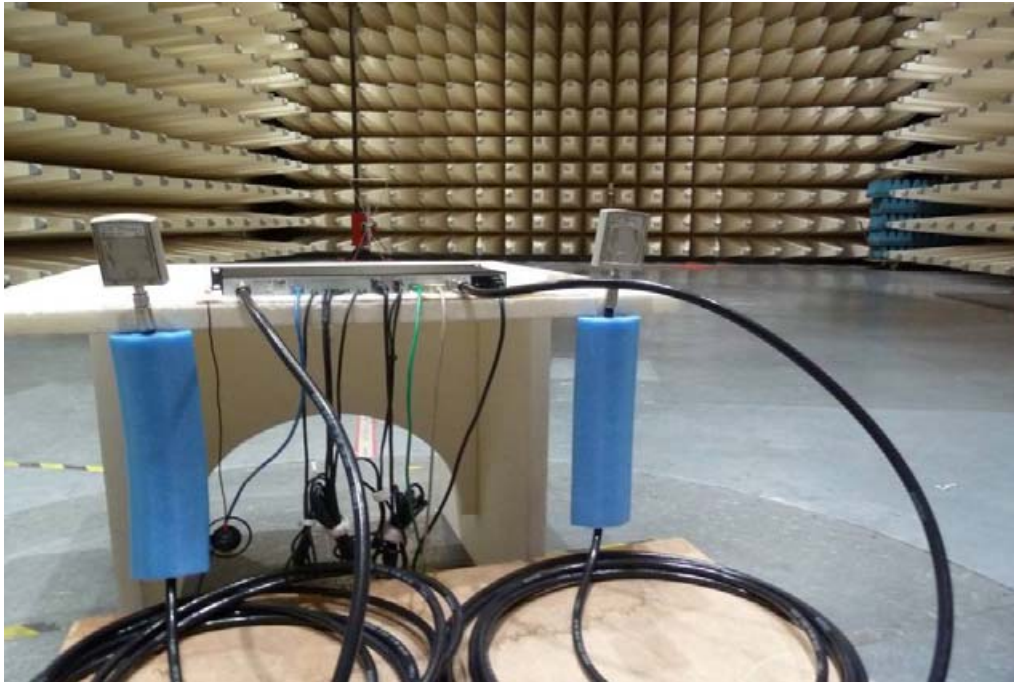
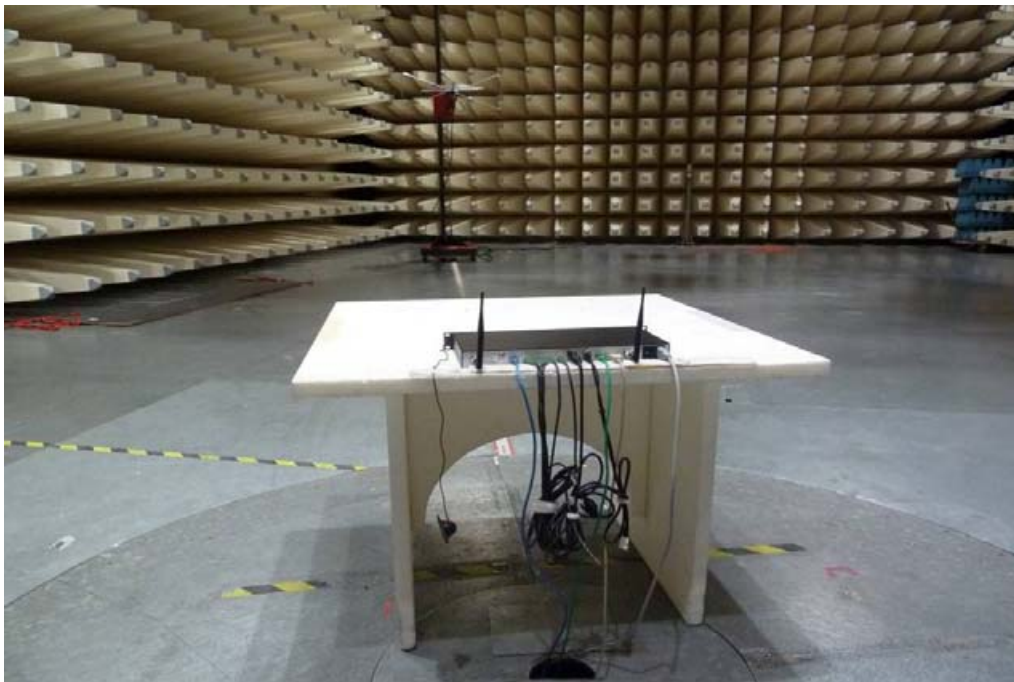

Photo 9:



Annex B External photographs of the EUT

Photo documentation

Photo 10:



Photo 11:



Photo 12:



Photo 13:



Photo 14:



Annex C Internal photographs of the EUT

Photo documentation

Photo 15:



Photo 16:

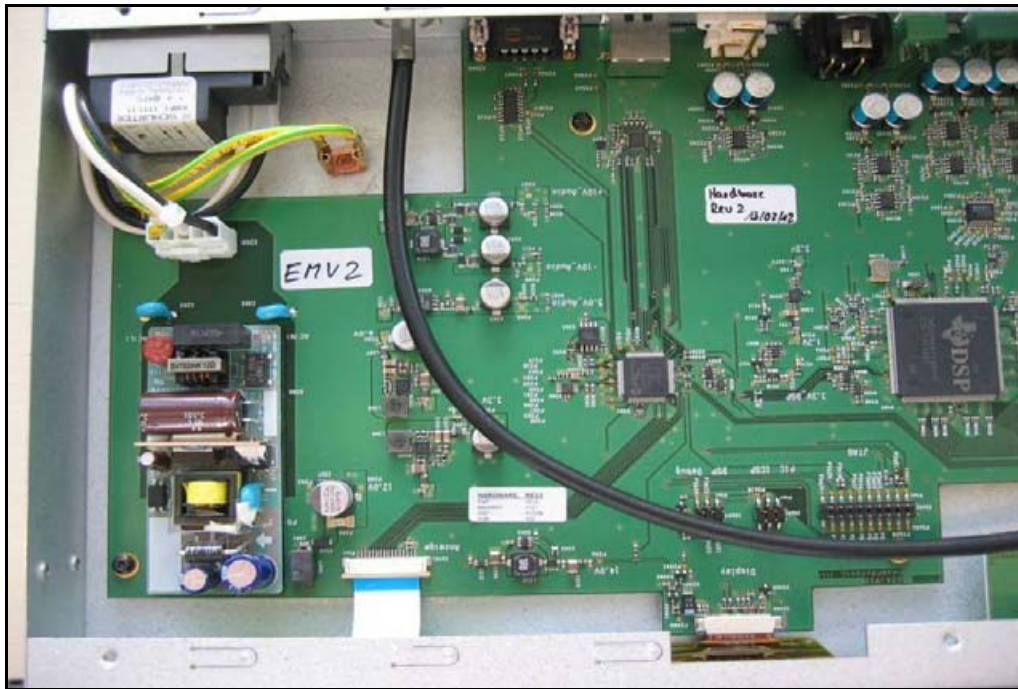

Photo 17:



Photo 18:

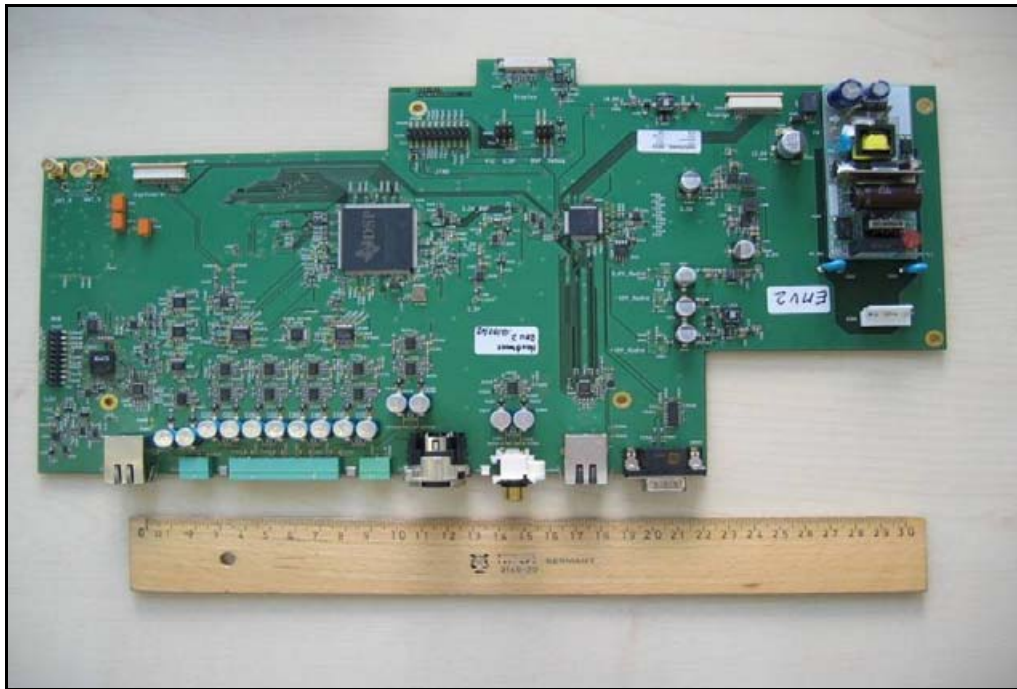

Photo 19:

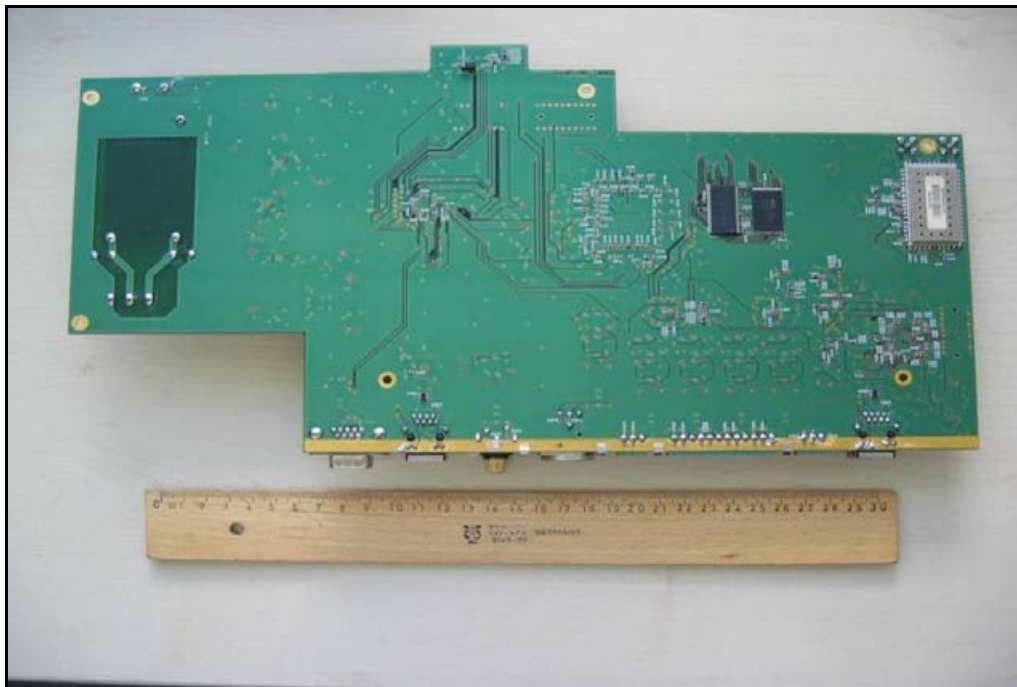

Photo 20:

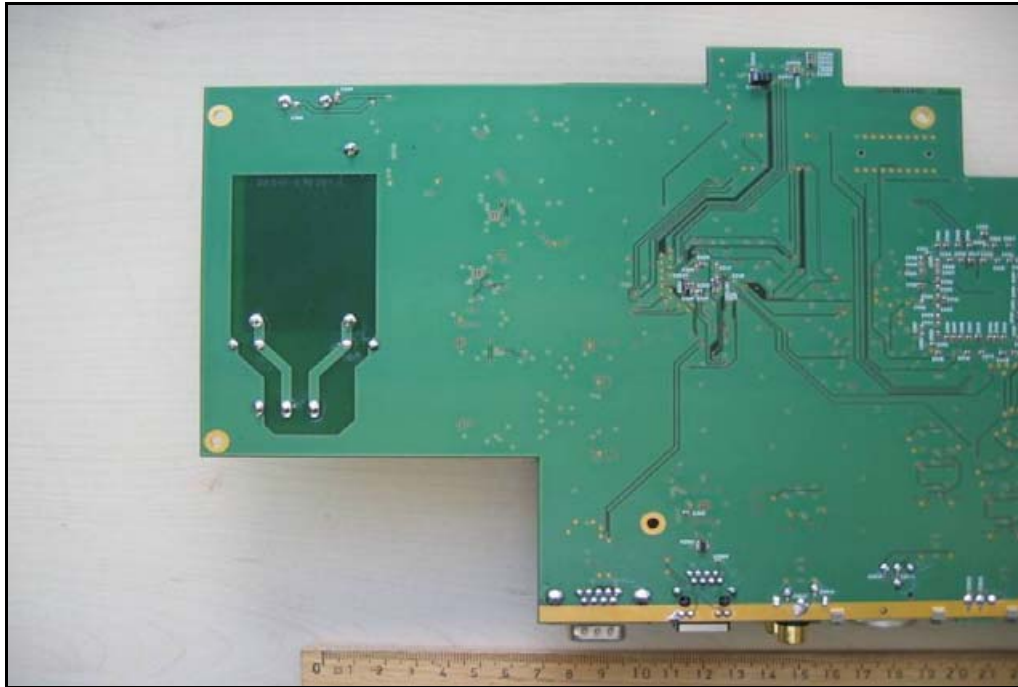

Photo 21:

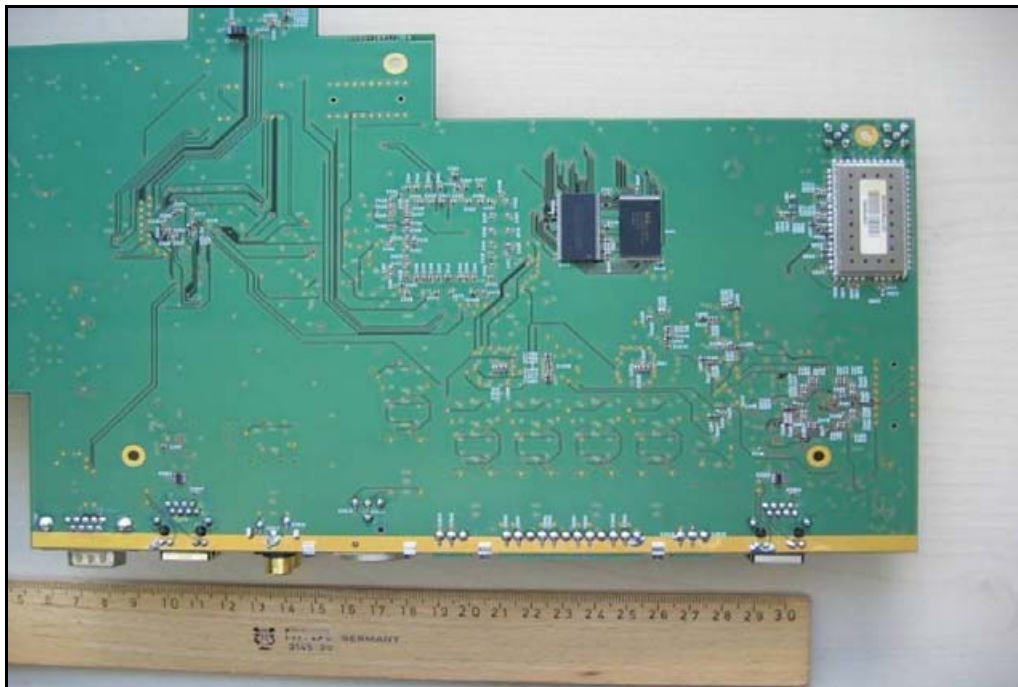

Photo 22:

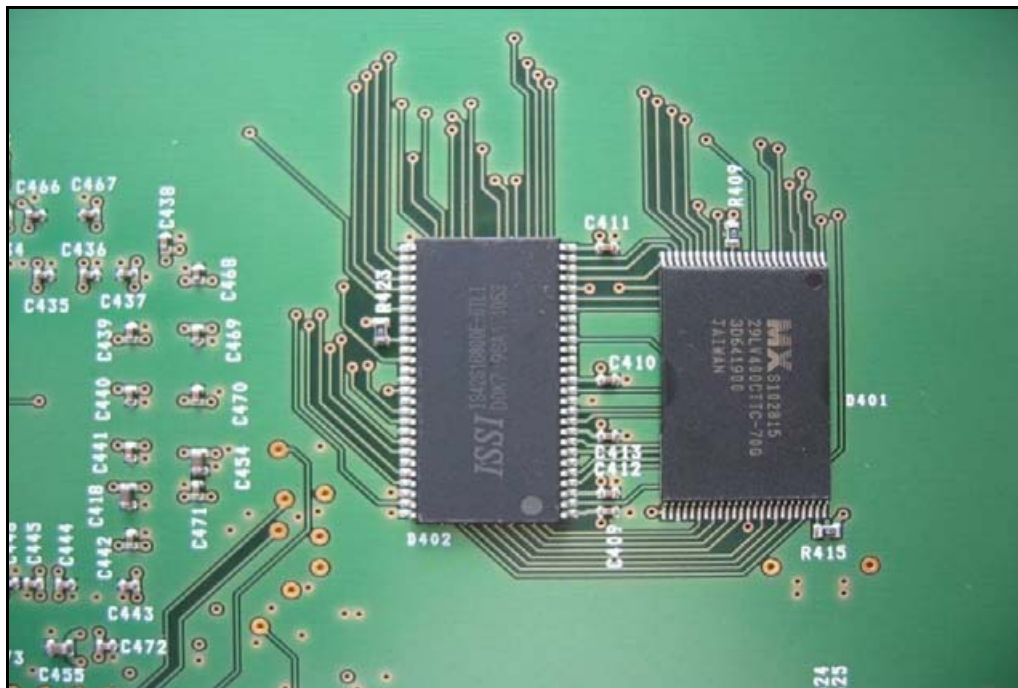

Photo 23:



Photo 24:

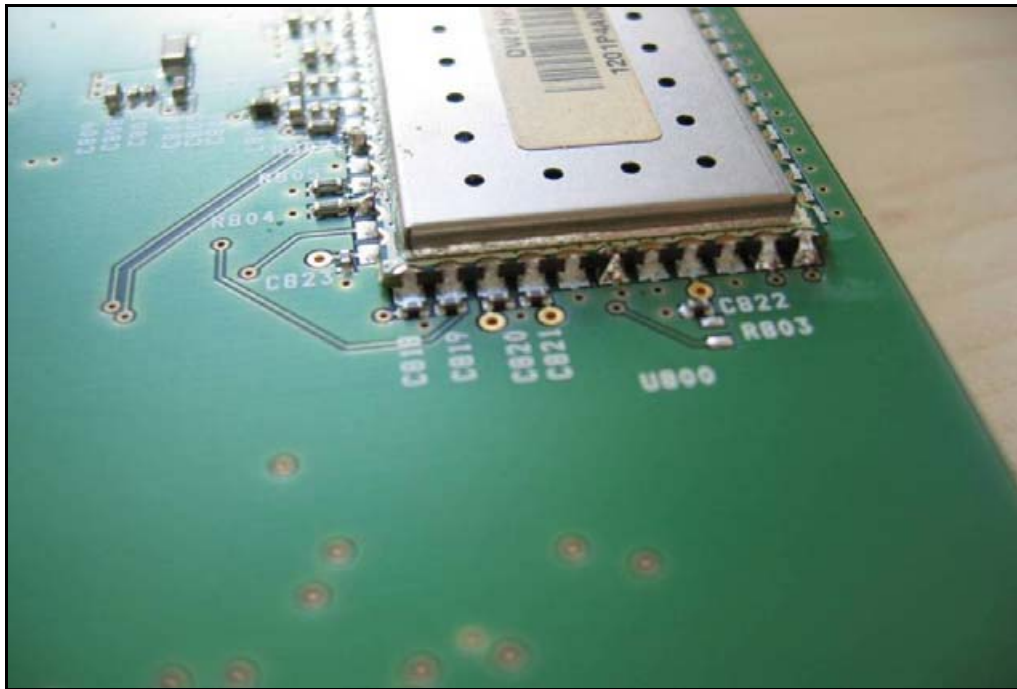

Photo 25:

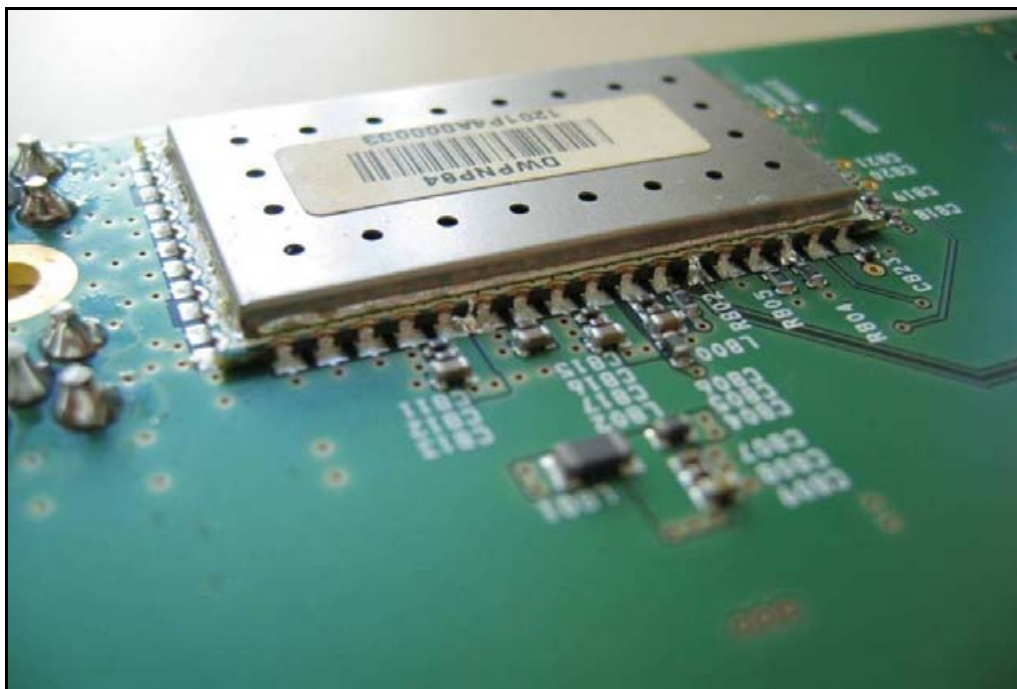

Photo 26:

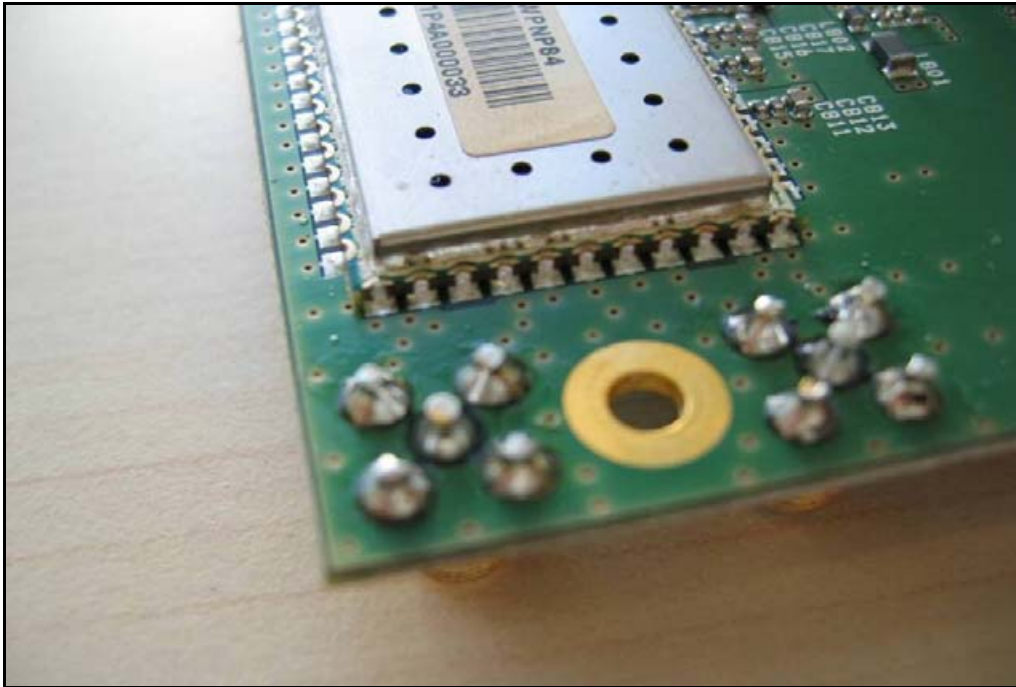

Photo 27:



Annex D Antennas & Cable

Photo documentation

Photo 28: Rod antenna (CA Q11)



Photo 29: Planar antenna (CA Q13)



Photo 30: Planar antenna (CA Q13)



Photo 31: Omnidirectional antenna (CA Q14)



Photo 32: Omnidirectional antenna (CA Q14)



Photo 33: 10m cable (Ecoflex 15Plus) (CA Q31)



Annex E Document history

Version	Applied changes	Date of release
1.0	Initial release	2012-04-30
-A	Remeasurement bandwidth with reduced signal output	2012-09-21
-B	Changed model name	2012-11-06

Annex F Further information

Glossary

AVG	-	Average
DUT	-	Device under test
EMC	-	Electromagnetic Compatibility
EN	-	European Standard
EUT	-	Equipment under test
ETSI	-	European Telecommunications Standard Institute
FCC	-	Federal Communication Commission
FCC ID	-	Company Identifier at FCC
HW	-	Hardware
IC	-	Industry Canada
Inv. No.	-	Inventory number
N/A	-	Not applicable
PP	-	Positive peak
QP	-	Quasi peak
S/N	-	Serial number
SW	-	Software

Annex G Accreditation Certificate



Front side of certificate



Back side of certificate

Note:

The current certificate including annex is published on our website (see link below) or may be received from CETECOM ICT Services on request.

http://www.cetecom.com/fileadmin/de/CETECOM_D_Saarbruecken/accreditations_Jan_2010/DAKKS_Akkredi_Urk_EN17025-En_incl_Annex.pdf