



FCC RADIO TEST REPORT

FCC ID: OS3OPU02

Product : OPU2

Trade Name : OPLINK

Model Name : OPU2120

Serial Model : N/A

Report No. : NTEK- 2013NT0323058F2

Prepared for

Zhuhai FTZ Oplink Communications, Inc.
#29, #30 Lianfeng Avenue, Free Trade Zone, Zhuhai City, Guangdong
Province, China 519030

Prepared by

Shenzhen NTEK Testing Technology Co., Ltd.
1/F, Building E, Fenda Science Park, Sanwei Community, Xixiang Street
Bao'an District, Shenzhen P.R. China
Tel.: +86-0755-61156588 Fax.: +86-0755-61156599
Website: www.ntek.org.cn

TEST RESULT CERTIFICATION

Applicant's name : Zhuhai FTZ Oplink Communications, Inc.
Address : #29, #30 Lianfeng Avenue, Free Trade Zone, Zhuhai City, Guangdong Province, China 519030

Manufacturer's Name..... : Prime Foundation Inc.
Address : No.19 Baoying Nan Road, Guangzhou Free Trade Zone , Guangzhou,P.R. China510730

Product description

Product name..... : OPU2
Model and/or type reference : OPU2120
Serial Model : N/A
Rating(s)..... : DC 5V

Standards : FCC Part15.231

Test procedure ANSI C63.4-2003

This device described above has been tested by NTEK, and the test results show that the equipment under test (EUT) is in compliance with the FCC requirements. And it is applicable only to the tested sample identified in the report.

This report shall not be reproduced except in full, without the written approval of NTEK, this document may be altered or revised by NTEK, personal only, and shall be noted in the revision of the document.

Date of Test :
Date (s) of performance of tests..... : 10 Mar. 2013 ~22 Mar. 2013
Date of Issue..... : 22 Mar. 2013
Test Result..... : **Pass**

Testing Engineer : Apple Huang
(Apple Huang)

Technical Manager : Tom Zhang
(Tom Zhang)

Authorized Signatory : Bovey Yang
(Bovey Yang)

Table of Contents	Page
1 . SUMMARY OF TEST RESULTS	4
1.1 TEST FACILITY	5
1.2 MEASUREMENT UNCERTAINTY	5
2 . GENERAL INFORMATION	6
2.1 GENERAL DESCRIPTION OF EUT	6
2.2 DESCRIPTION OF TEST MODES	7
2.3 BLOCK DIGRAM SHOWING THE CONFIGURATION OF SYSTEM TESTED	8
2.4 DESCRIPTION OF SUPPORT UNITS(CONDUCTED MODE)	9
2.5 EQUIPMENTS LIST FOR ALL TEST ITEMS	10
3 . ANTENNA REQUIREMENT	11
3.1 STANDARD REQUIREMENT	11
3.2 EUT ANTENNA	11
3.3 CONDUCTED EMISSION MEASUREMENT	12
3.3.1 POWER LINE CONDUCTED EMISSION LIMITS	12
3.3.2 TEST PROCEDURE	13
3.3.3 DEVIATION FROM TEST STANDARD	13
3.3.4 TEST SETUP	13
3.2.5 TEST RESULT	14
3.4 RADIATED EMISSION MEASUREMENT	16
3.4.1 RADIATED EMISSION LIMITS	16
3.4.2 TEST PROCEDURE	17
3.4.3 DEVIATION FROM TEST STANDARD	17
3.4.4 TEST SETUP	18
3.4.5 TEST RESULTS (BLOW 30MHZ)	20
3.4.6 TEST RESULTS (BETWEEN 30 – 1000 MHZ)	21
4 . BANDWIDTH TEST	24
4.1 TEST PROCEDURE	24
4.2 DEVIATION FROM STANDARD	24
4.3 TEST SETUP	24
4.4 TEST RESULTS	25
5 . TRANSMITTER TIMEOUT	26
5.1 REQUIREMENTS	26
6 . EUT TEST PHOTO	28
APPENDIX-PHOTOGRAPHS OF EUT CONSTRUCTIONAL DETAILS	

1. SUMMARY OF TEST RESULTS

Test procedures according to the technical standards:

FCC Part15, Subpart C (15.231)			
Standard Section	Test Item	Judgment	Remark
15.207	Conducted Emission	Pass	Note(1)
15.203	Antenna Requirement	Pass	
15.231	Radiated Spurious Emission	Pass	
15.231	Occupied Bandwidth	Pass	
15.231	Transmitter Timeout	Pass	

NOTE:

(1) " N/A" denotes test is not applicable in this Test Report.

1.1 TEST FACILITY

NTEK Testing Technology Co., Ltd

Add. : 1/F, Building E, Fenda Science Park, Sanwei Community, Xixiang Street, Bao'an District, Shenzhen P.R. China.

FCC Registration No.:238937; IC Registration No.:9270A-1

CNAS Registration No.:L5516

1.2 MEASUREMENT UNCERTAINTY

The reported uncertainty of measurement $y \pm U$, where expanded uncertainty U is based on a standard uncertainty multiplied by a coverage factor of $k=2$, providing a level of confidence of approximately **95 %**.

No.	Item	Uncertainty
1	Conducted Emission Test	$\pm 1.38\text{dB}$
2	RF power,conducted	$\pm 0.16\text{dB}$
3	Spurious emissions,conducted	$\pm 0.21\text{dB}$
4	All emissions,radiated(<1G)	$\pm 4.68\text{dB}$
5	All emissions,radiated(>1G)	$\pm 4.89\text{dB}$
6	Temperature	$\pm 0.5^{\circ}\text{C}$
7	Humidity	$\pm 2\%$

2. GENERAL INFORMATION

2.1 GENERAL DESCRIPTION OF EUT

Equipment	OPU2	
Trade Name	OPLINK	
Model Name	OPU2120	
Serial Model	N/A	
Model Difference	N/A	
Product Description	The EUT is a OPU2	
	Product Type	Low Power Communication Device Transmitter
	Operation Frequency:	433.92MHz
	Modulation Type:	ASK
	Number Of Channel	1CH.
	Antenna Designation:	External antenna
	Antenna Gain(Peak)	2dBi
	Output Power:	71.24 dBuV/m (AV Max.)
More details of EUT technical specification, please refer to the User's Manual.		
Channel List	N/A	
Adapter	Model: M-908 INPUT:100~240V, 50/60Hz OUTPUT:AC MODE 1.5A, BATTERY MODE 1.5A	
Battery	N/A	
Hard version	1.01&1.02	
Software version	N/A	

Note:

1. For a more detailed features description, please refer to the manufacturer's specifications or the User's Manual.

2.

Table for Filed Antenna

Ant	Brand	Model Name	Antenna Type	Connector	Gain (dBi)	NOTE
1	N/A	N/A	External Antenna	N/A	2	Antenna

2.2 DESCRIPTION OF TEST MODES

To investigate the maximum EMI emission characteristics generates from EUT, the test system was pre-scanning tested base on the consideration of following EUT operation mode or test configuration mode which possible have effect on EMI emission level. Each of these EUT operation mode(s) or test configuration mode(s) mentioned above was evaluated respectively.

Pretest Mode	Description
Mode 1	TX

For Conducted Emission	
Final Test Mode	Description
Mode 1	TX

For Radiated Emission	
Final Test Mode	Description
Mode 1	TX

Note:

- (1) The EUT use new battery.
- (2) The EUT is set to Continuous emission by short sensor.

2.3 BLOCK DIGRAM SHOWING THE CONFIGURATION OF SYSTEM TESTED

Conducted Emission Test:

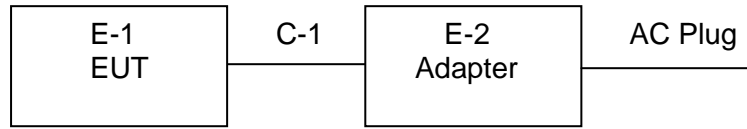

Radiated Spurious Emission Test:

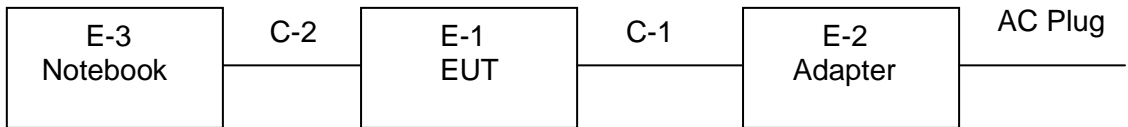

2.4 DESCRIPTION OF SUPPORT UNITS(CONDUCTED MODE)

The EUT has been tested as an independent unit together with other necessary accessories or support units. The following support units or accessories were used to form a representative test configuration during the tests.

Item	Equipment	Mfr/Brand	Model/Type No.	Series No.	Note
E-1	OPU2	OPLINK	OPU2120	N/A	EUT
E-2	Adapter	N/A	M-908		
E-3	Notebook	IBM	2366		

Item	Shielded Type	Ferrite Core	Length	Note
C-1	NO	NO	100cm	
C-2	NO	NO	100cm	

Note:

- (1) The support equipment was authorized by Declaration of Confirmation.
- (2) For detachable type I/O cable should be specified the length in cm in 『Length』 column.

2.5 EQUIPMENTS LIST FOR ALL TEST ITEMS

Radiation Test equipment

Item	Kind of Equipment	Manufacturer	Type No.	Serial No.	Last calibration	Calibrated until	Calibration period
1	Spectrum Analyzer	Agilent	E4407B	MY45108040	2012.07.06	2013.07.05	1 year
2	Test Receiver	R&S	ESPI	101318	2012.06.07	2013.06.06	1 year
3	Bilog Antenna	TESEQ	CBL6111D	31216	2012.07.06	2013.07.05	1 year
4	50Ω Coaxial Switch	Anritsu	MP59B	6200264416	2012.06.07	2013.06.06	1 year
5	Spectrum Analyzer	ADVANTEST	R3132	150900201	2012.06.07	2013.06.06	1 year
6	Horn Antenna	EM	EM-AH-10180	2011071402	2012.07.06	2013.07.05	1 year
7	Horn Ant	Schwarzbeck	BBHA 9170	9170-181	2012.07.06	2013.07.05	1 year
8	Amplifier	EM	EM-30180	060538	2011.12.22	2012.12.21	1 year
9	Loop Antenna	ARA	PLA-1030/B	1029	2012.06.08	2013.06.07	1 year
10	Power Meter	R&S	NRVS	100696	2012.07.06	2013.07.05	1 year
11	Power Sensor	R&S	URV5-Z4	0395.1619.05	2012.07.06	2013.07.05	1 year

Conduction Test equipment

Item	Kind of Equipment	Manufacturer	Type No.	Serial No.	Last calibration	Calibrated until	Calibration period
1	Test Receiver	R&S	ESCI	101160	2012.06.06	2013.06.05	1 year
2	LISN	R&S	ENV216	101313	2012.08.24	2013.08.23	1 year
3	LISN	EMCO	3816/2	00042990	2012.08.24	2013.08.23	1 year
4	50Ω Coaxial Switch	Anritsu	MP59B	6200264417	2012.06.07	2013.06.06	1 year
5	Passive Voltage Probe	R&S	ESH2-Z3	100196	2012.06.07	2013.06.06	1 year
6	Absorbing clamp	R&S	MOS-21	100423	2012.06.08	2013.06.07	1 year

3. ANTENNA REQUIREMENT

3.1 STANDARD REQUIREMENT

15.203 requirement: For intentional device, according to 15.203: an intentional radiator shall be designed to ensure that no antenna other than that furnished by the responsible party shall be used with the device.

3.2 EUT ANTENNA

The EUT antenna is external Antenna. It comply with the standard requirement.

3.3 CONDUCTED EMISSION MEASUREMENT

3.3.1 POWER LINE CONDUCTED EMISSION Limits (Frequency Range 150KHz-30MHz)

FREQUENCY (MHz)	Class A (dBuV)		Class B (dBuV)		Standard
	Quasi-peak	Average	Quasi-peak	Average	
0.15 -0.5			66 - 56 *	56 - 46 *	CISPR
0.50 -5.0			56.00	46.00	CISPR
5.0 -30.0			60.00	50.00	CISPR

0.15 -0.5			66 - 56 *	56 - 46 *	LP002.
0.50 -5.0			56.00	46.00	LP002.
5.0 -30.0			60.00	50.00	LP002.

Note:

- (1) The tighter limit applies at the band edges.
- (2) The limit of " * " marked band means the limitation decreases linearly with the logarithm of the frequency in the range.

The following table is the setting of the receiver

Receiver Parameters	Setting
Attenuation	10 dB
Start Frequency	0.15 MHz
Stop Frequency	30 MHz
IF Bandwidth	9 kHz

3.3.2 TEST PROCEDURE

- a. The EUT was placed 0.4 meters from the horizontal ground plane with EUT being connected to the power mains through a line impedance stabilization network (LISN). All other support equipments powered from additional LISN(s). The LISN provide 50 Ohm/ 50uH of coupling impedance for the measuring instrument.
- b. Interconnecting cables that hang closer than 40 cm to the ground plane shall be folded back and forth in the center forming a bundle 30 to 40 cm long.
- c. I/O cables that are not connected to a peripheral shall be bundled in the center. The end of the cable may be terminated, if required, using the correct terminating impedance. The overall length shall not exceed 1 m.
- d. LISN at least 80 cm from nearest part of EUT chassis.
- e. For the actual test configuration, please refer to the related Item –EUT Test Photos.

3.3.3 DEVIATION FROM TEST STANDARD

No deviation

3.3.4 TEST SETUP

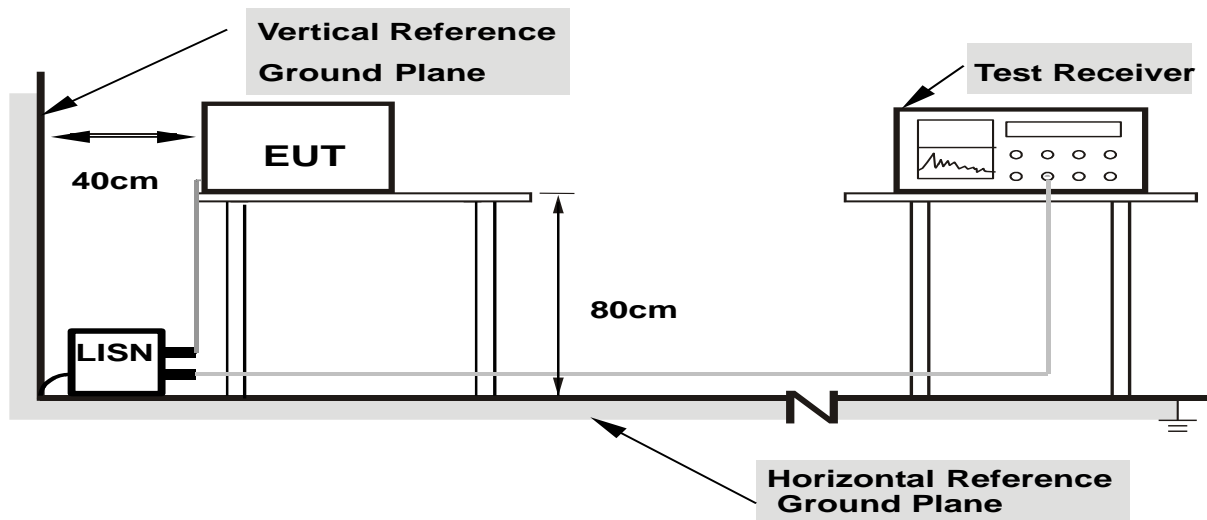

Note: 1. Support units were connected to second LISN.

2. Both of LISNs (AMN) are 80 cm from EUT and at least 80 cm from other units and other metal planes

3.2.5 TEST RESULT

3.3.5 TEST RESULTS

EUT :	OPU2	Model Name. :	OPU2120
Temperature :	26 °C	Relative Humidity :	54%
Pressure :	1010hPa	Phase :	L
Test Voltage :	DC 5.0V from adapter AC120V/60Hz	Test Mode :	Mode 1

Frequency (MHz)	Meter Reading (dBμV)	Factor (dB)	Emission Level (dBμV)	Limits (dBμV)	Margin (dB)	Detector Type
0.158	43.51	9.81	53.32	65.56	-12.24	QP
0.17	12.04	9.8	21.84	54.96	-33.12	AVG
2.2459	13.13	10.26	23.39	46	-22.61	AVG
2.406	27.73	10.26	37.99	56	-18.01	QP
6.8178	16.1	10.43	26.53	50	-23.47	AVG
7.2659	31.69	10.42	42.11	60	-17.89	QP

Remark:

1. All readings are Quasi-Peak and Average values.
2. Factor = Insertion Loss + Cable Loss.

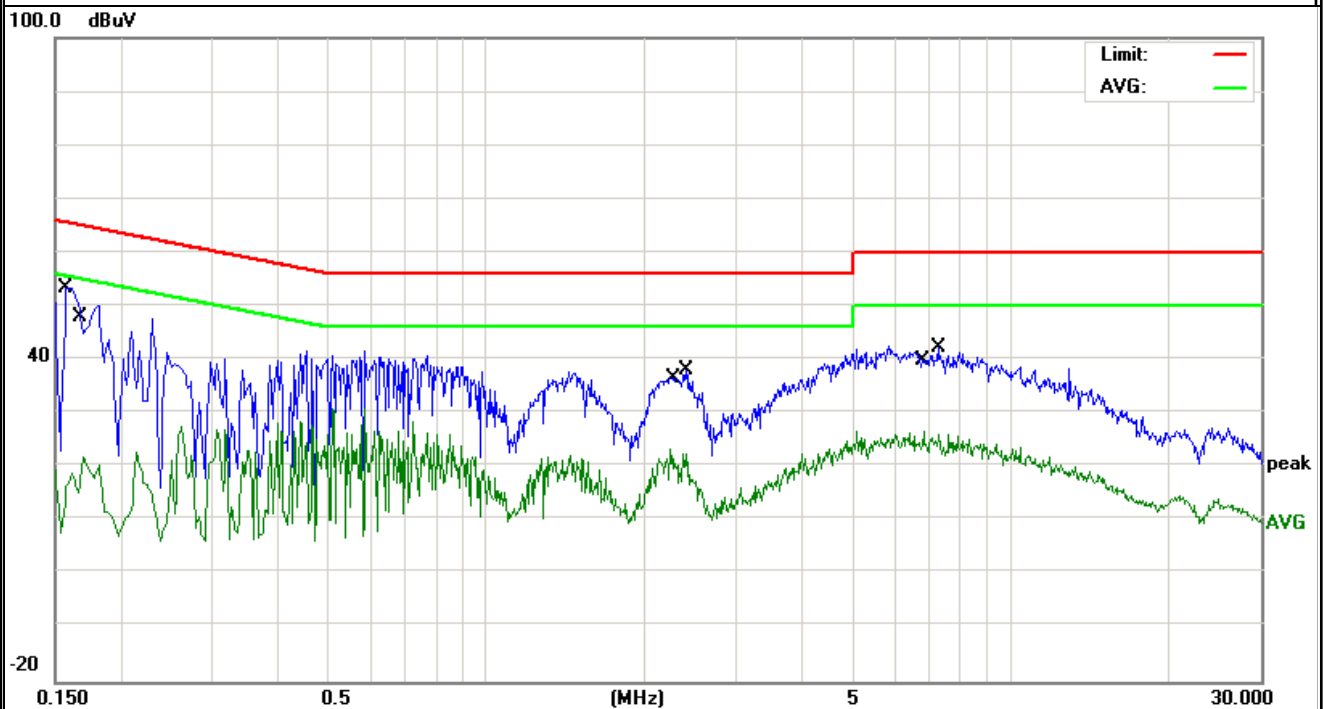

EUT :	OPU2	Model Name. :	OPU2120
Temperature :	26 °C	Relative Humidity :	54%
Pressure :	1010hPa	Phase :	N
Test Voltage :	DC 5.0V from adapter AC120V/60Hz	Test Mode :	Mode 1

Frequency (MHz)	Meter Reading (dBμV)	Factor (dB)	Emission Level (dBμV)	Limits (dBμV)	Margin (dB)	Detector Type
0.1539	44.98	9.82	54.8	65.78	-10.98	QP
0.173	9.45	9.8	19.25	54.81	-35.56	AVG
2.25	9.76	10.26	20.02	46	-25.98	AVG
2.338	26.6	10.26	36.86	56	-19.14	QP
6.8179	11.85	10.43	22.28	50	-27.72	AVG
7.2179	30.14	10.42	40.56	60	-19.44	QP

Remark:

1. All readings are Quasi-Peak and Average values.
2. Factor = Insertion Loss + Cable Loss.

100.0 dBμV

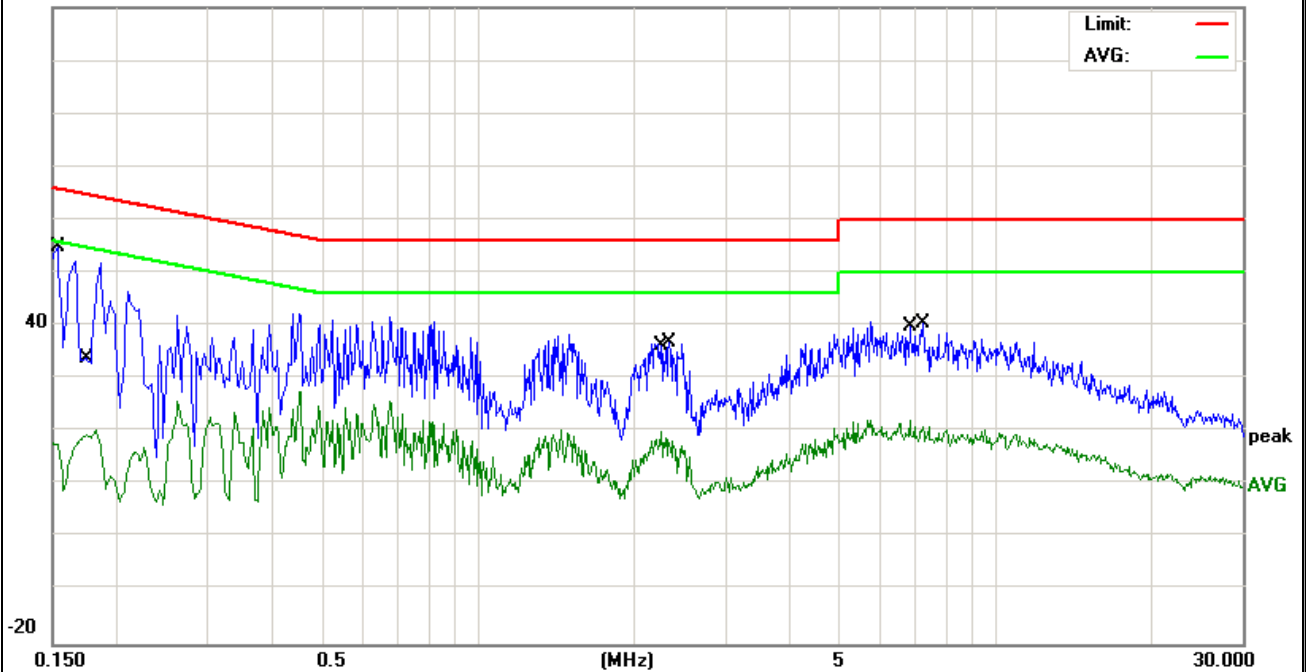

3.4 RADIATED EMISSION MEASUREMENT

3.4.1 Radiated Emission Limits (FCC 15.209)

Frequencies (MHz)	Field Strength (micorvolts/meter)	Measurement Distance (meters)
0.009~0.490	2400/F(KHz)	300
0.490~1.705	24000/F(KHz)	30
1.705~30.0	30	30
30~88	100	3
88~216	150	3
216~960	200	3
Above 960	500	3

Note:

- (1) The tighter limit applies at the band edges.
- (2) Emission level (dBuV/m)=20log Emission level (uV/m).

LIMITS OF RADIATED EMISSION MEASUREMENT (FCC 15.231)

Fundamental Frequency (MHz)	Field Strength of fundamental (microvolts/meter)	Field Strength of Unwanted Emissions (microvolts/meter)
40.66 - 40.70	2250.00	225.00
70 - 130	1250.00	125.00
130 - 174	1,250 to 3,750 **	125 to 375 **
174 - 260	3750.00	375.00
260 - 470	3,750 to 12,500 **	375 to 1,250 **
Above 470	12500.00	1250.00

Notes:

- (1) ** linear interpolations
 [Where F is the frequency in MHz, the formulas for calculating the maximum permitted fundamental field strengths are as follows: for the band 130-174 MHz, uV/m at 3 meters = 56.81818(F) - 6136.3636; for the band 260-470 MHz, uV/m at 3 meters = 41.6667(F) - 7083.3333. The maximum permitted unwanted emission level is 20 dB below the maximum permitted fundamental level.]
 The limits on the field strength of the spurious emissions in the above table are based on the fundamental frequency of the intentional radiator. Spurious emissions shall be attenuated to the average (or, alternatively, CISPR quasi-peak) limits shown in this table or to the general limits shown in 93 Section 15.209, whichever limit permits a higher field strength.

Spectrum Parameter	Setting
Attenuation	Auto
Start Frequency	1000 MHz
Stop Frequency	10th carrier harmonic
RB / VB (emission in restricted band)	1MHz / 1MHz for Peak

Receiver Parameter	Setting
Attenuation	Auto
Start ~ Stop Frequency	9kHz~150kHz / RB 200Hz for QP
Start ~ Stop Frequency	150kHz~30MHz / RB 9kHz for QP
Start ~ Stop Frequency	30MHz~1000MHz / RB 120kHz for QP

3.4.2 TEST PROCEDURE

- a. The measuring distance of at 3 m shall be used for measurements at frequency up to 1GHz. For frequencies above 1GHz, any suitable measuring distance may be used.
- b. The EUT was placed on the top of a rotating table 0.8 meters above the ground at a 3m meter open area test site. The table was rotated 360 degrees to determine the position of the highest radiation.
- c. The height of the equipment or of the substitution antenna shall be 0.8 m; the height of the test antenna shall vary between 1 m to 4 m.
- d. The initial step in collecting conducted emission data is a spectrum analyzer peak detector mode pre-scanning the measurement frequency range. Significant peaks are then marked and then Quasi Peak detector mode re-measured.
- e. If the Peak Mode measured value compliance with and lower than Quasi Peak Mode Limit, the EUT shall be deemed to meet QP Limits and then no additional QP Mode measurement performed.
- f. For the actual test configuration, please refer to the related Item –EUT Test Photos.

Note:

Both horizontal and vertical antenna polarities were tested and performed pretest to three orthogonal axis. The worst case emissions were reported

3.4.3 DEVIATION FROM TEST STANDARD

No deviation

3.4.4 TEST SETUP

(A) Radiated Emission Test-Up Frequency Below 30MHz

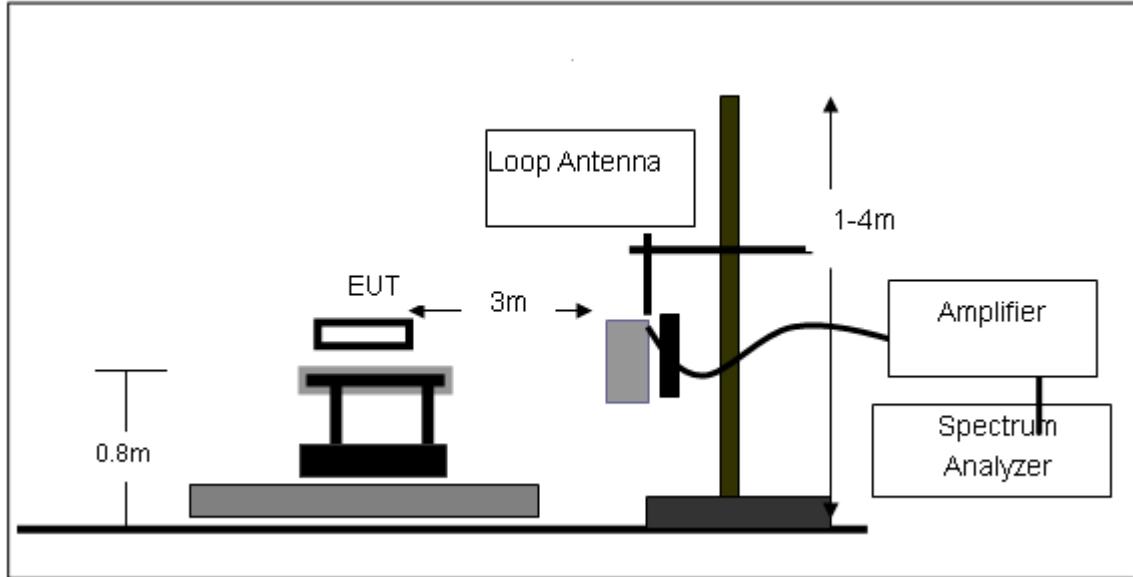

(B) Radiated Emission Test-Up Frequency 30MHz~1GHz

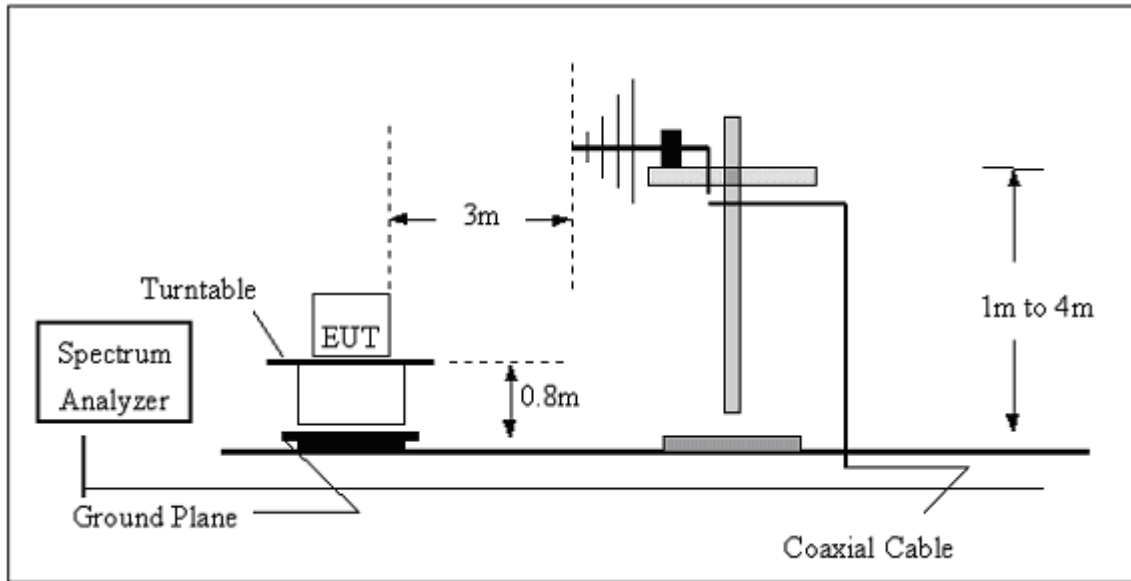

(C) Radiated Emission Test-Up Frequency Above 1GHz

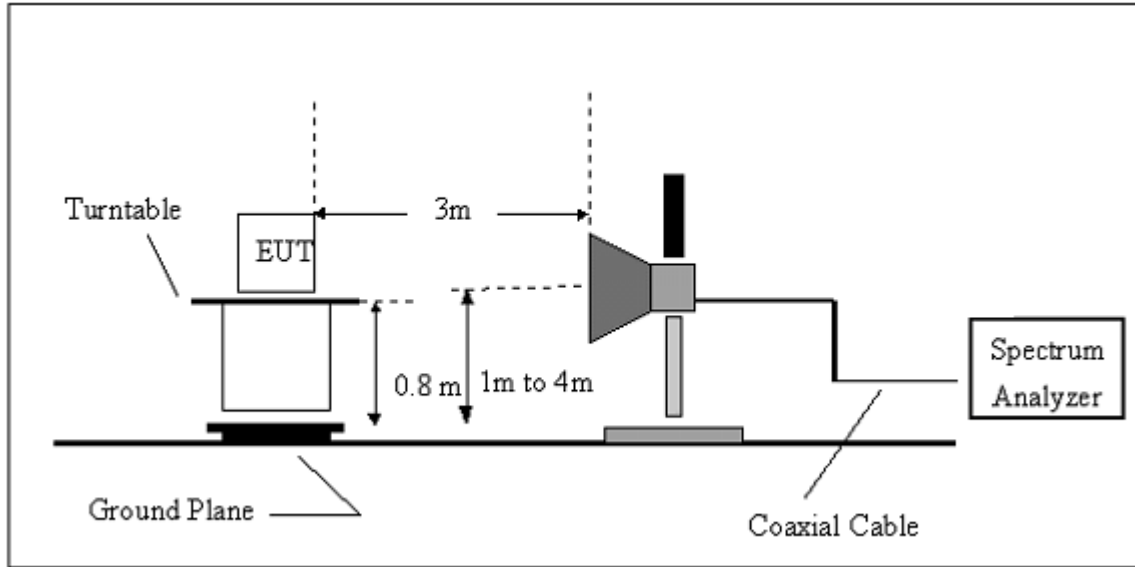

3.4.5 TEST RESULTS (BELOW 30MHz)

EUT :	OPU2	Model Name. :	OPU2120
Temperature :	20 °C	Relative Humidity :	48%
Pressure :	1010 hPa	Test Voltage :	DC 5V from adapter
Test Mode :	TX	Polarization :	--

Freq.	Reading	Limit	Margin	State
(MHz)	(dBuV/m)	(dBuV/m)	(dB)	P/F
--	--	--	--	PASS
--	--	--	--	PASS

NOTE:

The amplitude of spurious emissions which are attenuated by more than 20dB below the permissible value has no need to be reported.

Distance extrapolation factor = $40 \log(\text{specific distance}/\text{test distance})(\text{dB})$;

Limit line = specific limits(dBuv) + distance extrapolation factor.

3.4.6 TEST RESULTS (BETWEEN 30 – 1000 MHZ)

The duty cycle is simply the on time divided by the period:

The duration of one cycle = 76.25 ms

Effective period of the cycle = (29×0.95) + (8×0.3) ms= 29.95ms

DC = 29.95ms/76.25ms = 0.3928

Therefore, the average factor is found by $20\log 0.3928 = -8.12$

The duration of one cycle

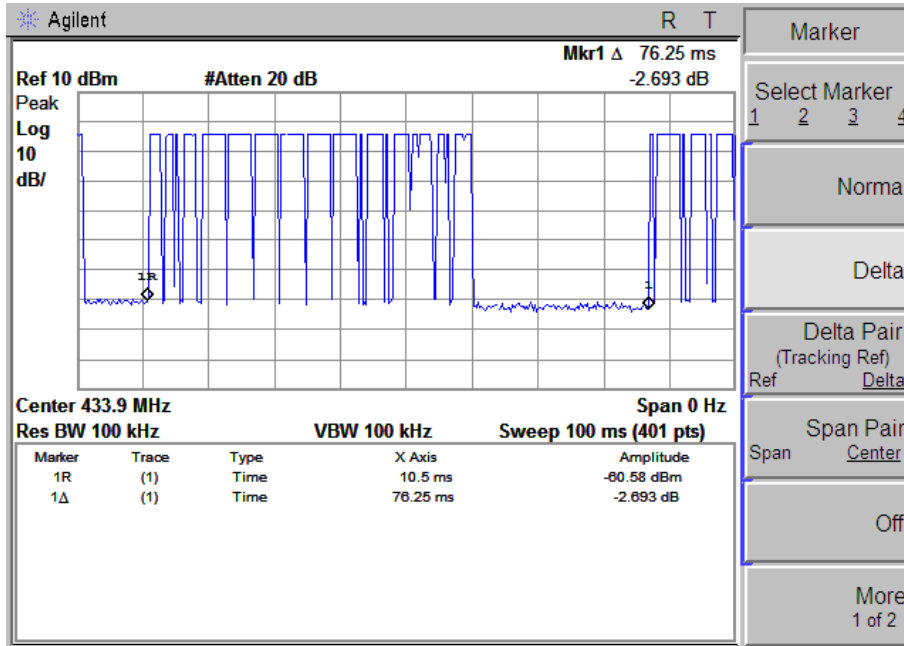

29 long 'on' signals and 8 short 'on' signals within 100ms

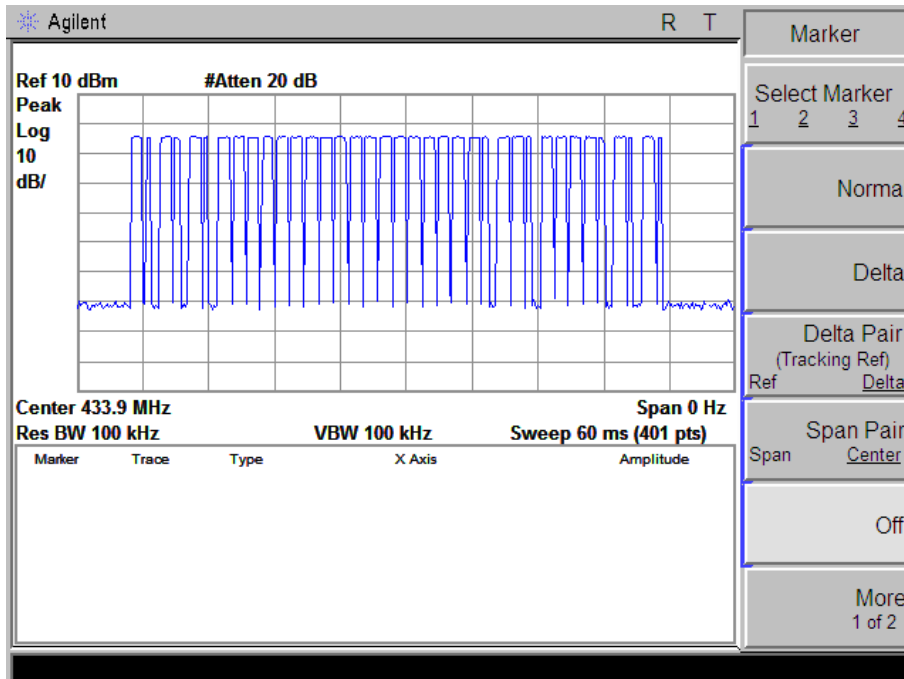

long signal and short signal time

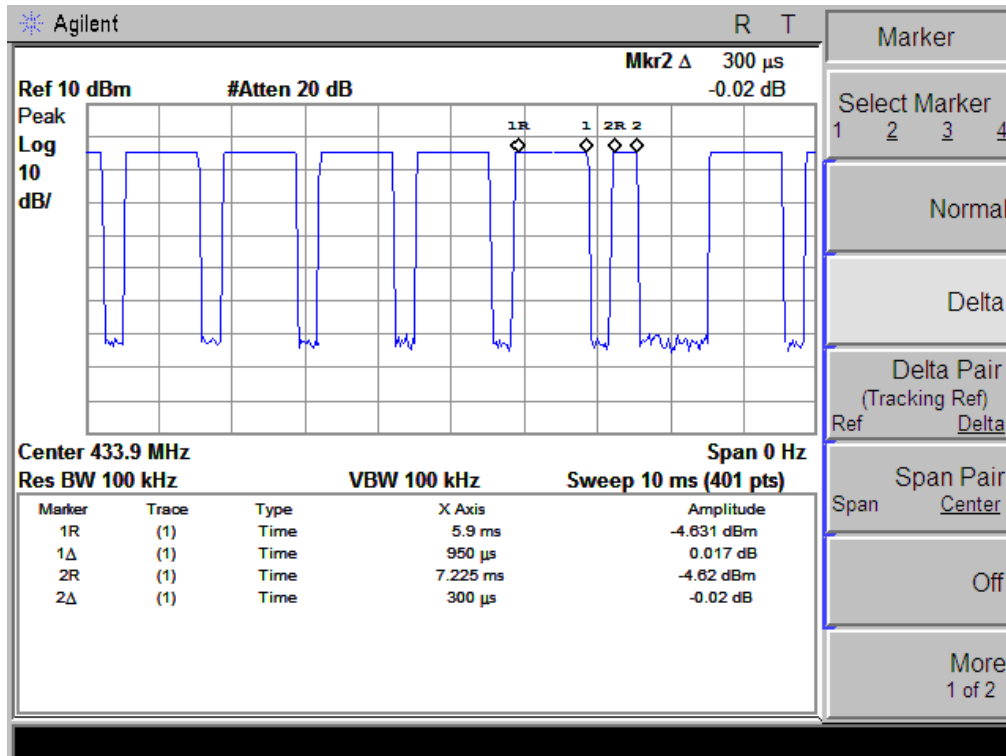

EUT :	OPU2	Model Name :	OPU2120
Temperature :	20 °C	Relative Humidity :	48%
Pressure :	1010 hPa	Test Voltage :	DC 5V from adapter
Test Mode :	TX	Polarization :	Horizontal

Frequency	Average Factor	Field Strength	Field Strength	Limit(PK)	Limit(AV)	State
MHz	dB	dBuV/m (PK)	dBuV/m (AV)	dBuV/m	dBuV/m	
433.9200	-8.12	79.36	71.24	100.8	80.8	pass
867.4325	-8.12	56.59	48.47	80.8	60.8	pass
1301.8960	-8.12	45.28	37.16	80.8	60.8	pass
--	--	--	--	74.00	54.00	pass
--	--	--	--	74.00	54.00	pass
--	--	--	--	74.00	54.00	pass

EUT :	OPU2	Model Name :	OPU2120
Temperature :	20 °C	Relative Humidity :	48%
Pressure :	1010 hPa	Test Voltage :	DC 5V from adapter
Test Mode :	TX	Polarization :	Vertical

Frequency	Average Factor	Field Strength	Field Strength	Limit(PK)	Limit(AV)	State
MHz	dB	dBuV/m (PK)	dBuV/m (AV)	dBuV/m	dBuV/m	
433.9200	-8.12	77.45	69.33	100.8	80.8	pass
867.7635	-8.12	54.30	46.18	80.8	60.8	pass
1301.6924	-8.12	40.26	32.14	80.8	60.8	pass
--	--	--	--	74.00	54.00	pass
--	--	--	--	74.00	54.00	pass
--	--	--	--	74.00	54.00	pass

NoTE:

1. Emissions attenuated more than 20 dB below the permissible value are not reported.
2. *: Denotes restricted band of operation.

Measurements were made using a peak detector. Any emission falling within the restricted bands of FCC Part 15 Section 15.205 were compliance with the emission limit of FCC Part 15 Section 15.209.

3. FCC Limit for Average Measurement = $41.6667(433.92)-7083.3333 = 6041.6772\mu\text{V/m}$
 $=80.8\text{dBuV/m}$

4: $1/\text{PW} = 1/0.3\text{ms} = 3.3 < \text{RBW}(120\text{KHz}), \text{PDCF}$ is not needed

4. BANDWIDTH TEST

4.1 TEST PROCEDURE

The bandwidth of the emission shall be no wider than 0.25% of the center frequency for devices operating above 70 MHz and below 900 MHz. For devices operating above 900 MHz, the emission shall be no wider than 0.5% of the center frequency. Bandwidth is determined at the points 20 dB down from the modulated carrier.

Limit: $433.92\text{MHz} \times 0.25\% = 1.0848\text{MHz}$

4.2 DEVIATION FROM STANDARD

No deviation.

4.3 TEST SETUP

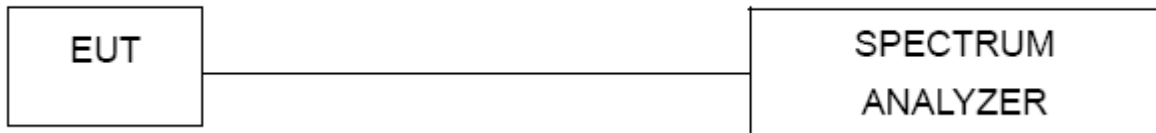

4.4 TEST RESULTS

EUT :	OPU2	Model Name :	OPU2120
Temperature :	26 °C	Relative Humidity :	53%
Pressure :	1020 hPa	Test Power :	DC 5V from adapter
Test Mode :	TX CH 1		

Test Channel	Frequency (MHz)	20 dBc Bandwidth (kHz)	Limit (MHz)
CH01	433.92	60.964	1.0848MHz

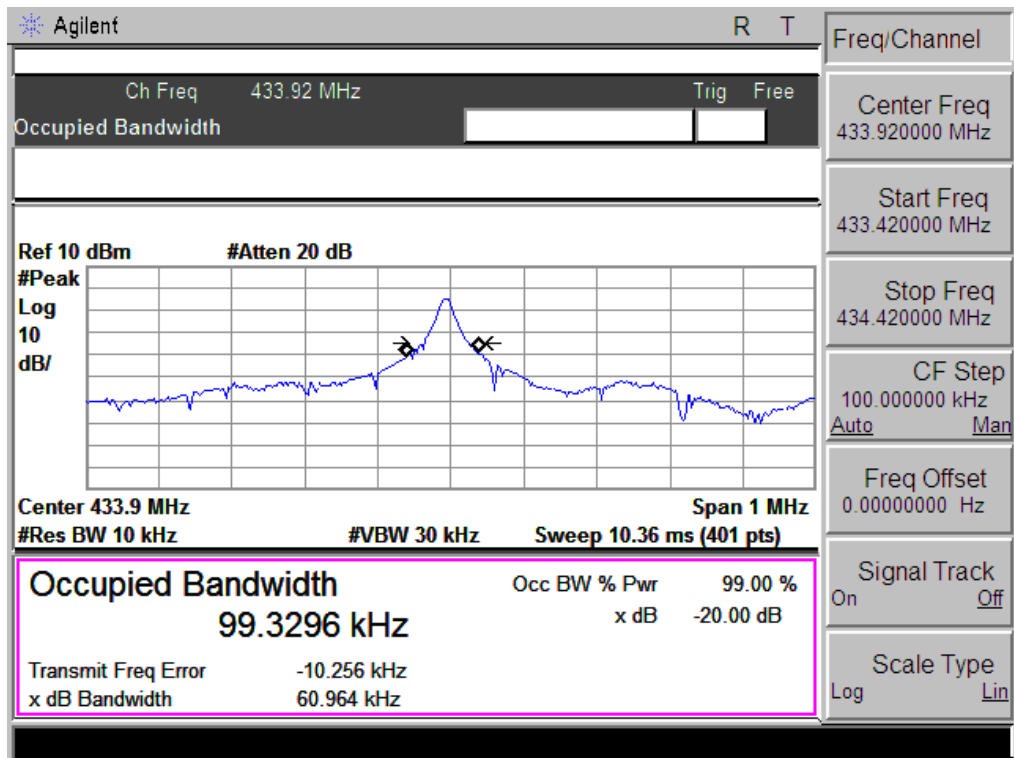

5. TRANSMITTER TIMEOUT

5.1 REQUIREMENTS

1 A manually operated transmitter shall employ a switch that will automatically deactivate the transmitter within not more than 5 seconds of being released.

Result: The EUT does not have a switch for activated transmitter

2 A transmitter activated automatically shall cease transmission within 5 seconds after activation.

Result: The EUT has a automatically activated transmitter, please refer to below detail data

3 Periodic transmissions at regular predetermined intervals are not permitted. However, polling or supervision transmissions, including data, to determine system integrity of transmitters used in security or safety applications are allowed if the total duration of transmissions does not exceed more than two seconds per hour for each transmitter. There is no limit on the number of individual transmissions, provided the total transmission time does not exceed two seconds per hour

Result:The EUT does not employ periodic transmission.

4 Intentional radiators which are employed for radio control purposes during emergencies involving fire, security, and safety of life, when activated to signal an alarm, may operate during the pendency of the alarm condition.

Result:The section is not applicable to EUT.

Test data

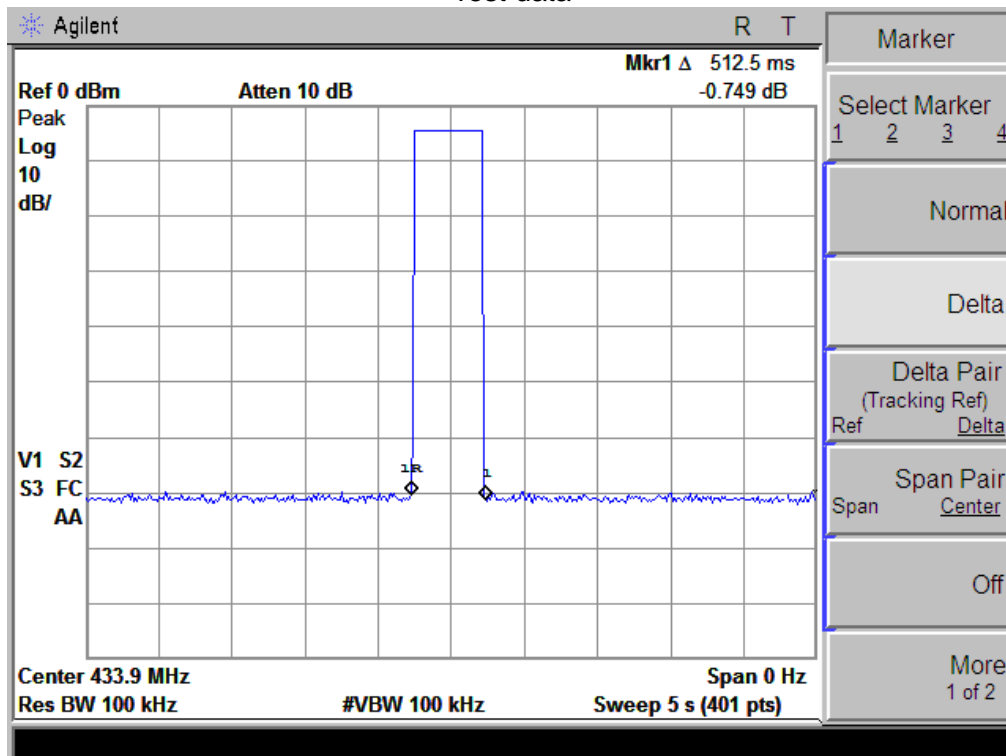

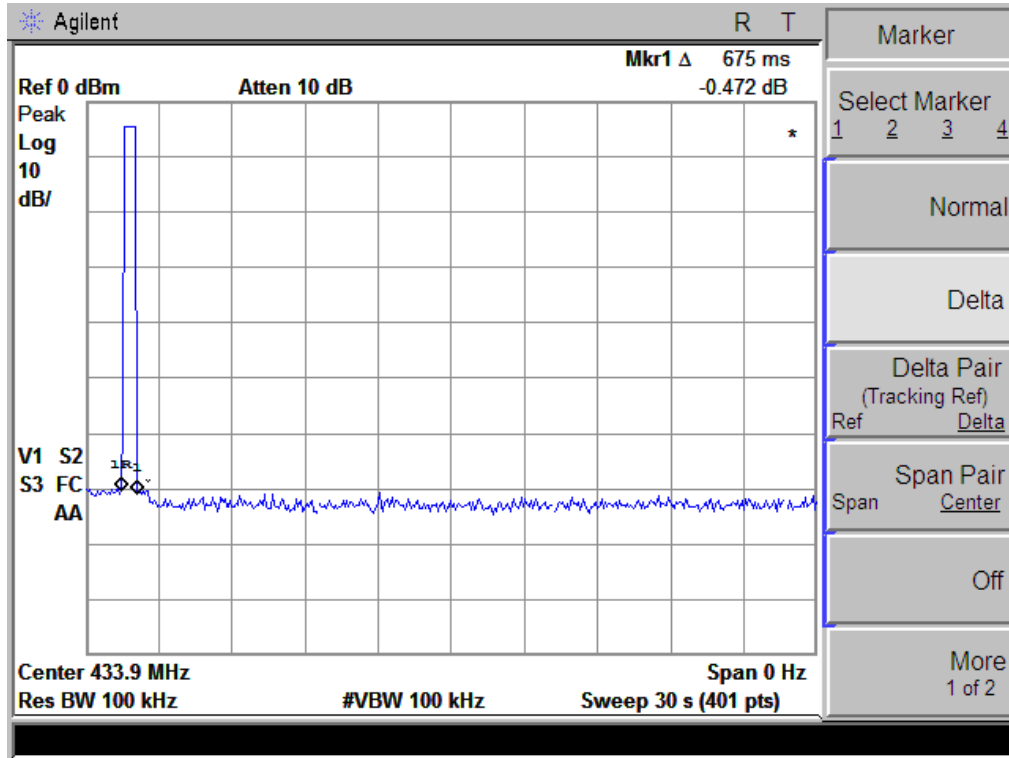

THE DURATION OF EACH TRANSMISSION	LIMIT	RESULT
0.5125s	<5s	PASS

6. EUT TEST PHOTO

Radiated Measurement Photos(worst case position)

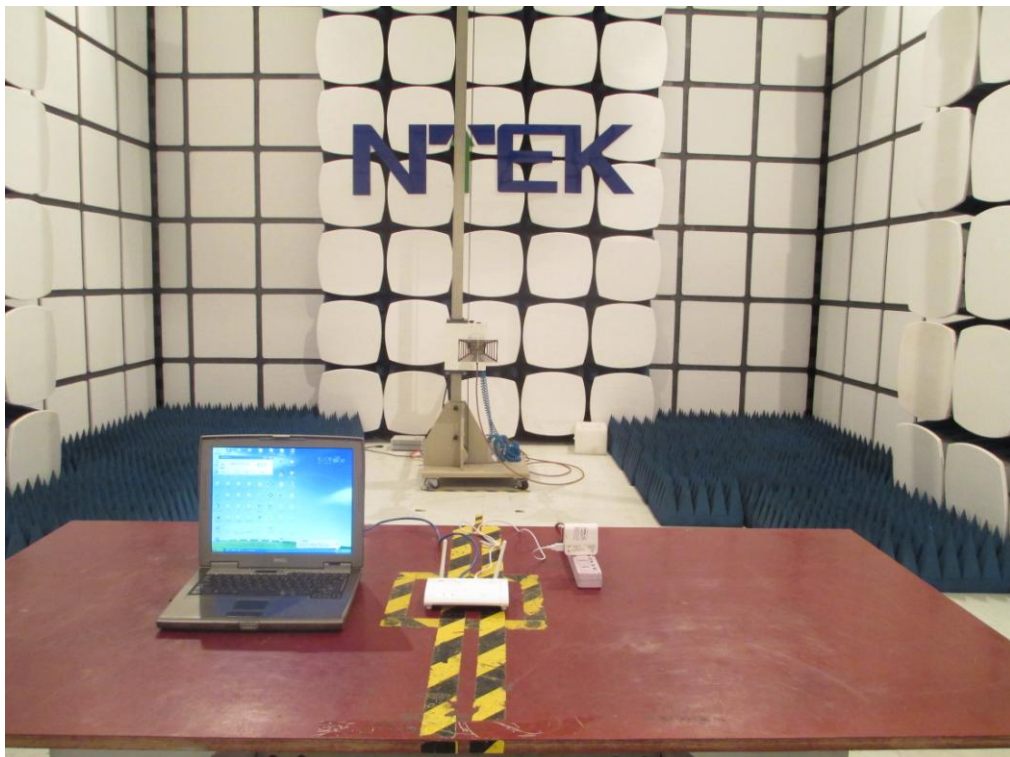
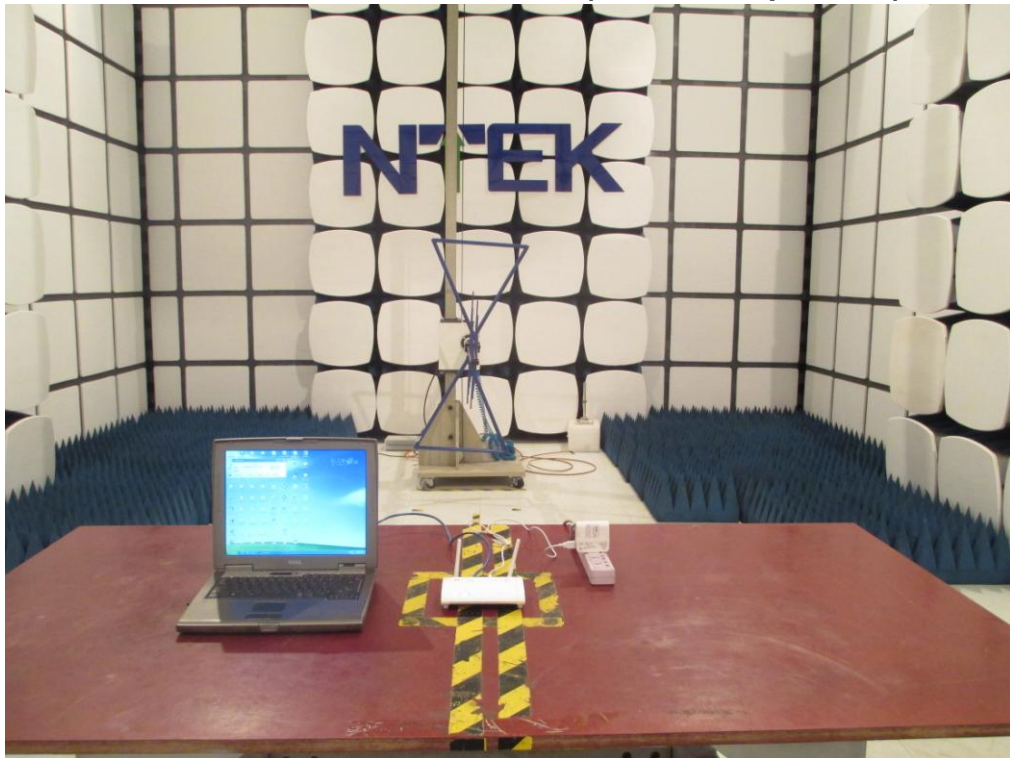

Conducted Measurement Photos

