



975

FMN

SMN



Classroom Audio System

User Manual





# Table of Contents

## OVERVIEW

- 3 Important Safety Instructions
- 4 **975: System Components and Unpacking**
- 5 Optional Speakers
- 6 Controls and Indicators
- 8 **Flexmike Controls and Connections**
- 9 Charging the Flexmike

## SET-UP & DAILY OPERATION

- 10 **Operating the Flexmike**
- 11 Using Flexmike as Wireless Audio Link
- 13 Output to Assistive Listening Device (ALD)
- 14 Audio Integration
- 15 Daily Operation Instructions

## OPTIONAL ACCESSORIES

- 16 **Sharemike Controls & Connections**
- 17 Sharemike Charging
- 18 Sharemike Initial Set-up
- 19 **PageFirst Sensor**

## MAINTENANCE & TROUBLESHOOTING

- 20 Battery Replacement for Flexmike
- 22 Troubleshooting
- 23 Tips for Optimal Audio Performance

## WARRANTY, SAFETY & SPECIFICATIONS

- 24 Warranty Statement
- 25 Safety Warnings and Certifications
- 31 System Specifications



# Important Safety Instructions

1. Do not use the apparatus near water.
2. Clean only with dry cloth.
3. Do not block any ventilation openings.
4. Do not install near any heat sources such as radiators, heat registers, stoves, or other apparatus (including amplifiers) that produce heat.
5. Do not defeat the safety purpose of the polarized or grounding-type plug. A polarized plug has two blades with one wider than the other. A grounding-type plug has two blades and a third grounding prong. The wide blade or the third prong is provided for your safety. If the provided plug does not fit into your outlet, consult an electrician for replacement of the outlet.
6. Protect the power cord from being walked on or pinched particularly at plugs, convenience receptacles, and the point where they exit from the apparatus.
7. Unplug this apparatus during lightning storms or when unused for long periods of time.
8. Refer all servicing to qualified service personnel. Servicing is required when the apparatus has been damaged in any way, such as power-supply cord or plug is damaged, liquid has been spilled or objects have fallen into the apparatus, the apparatus has been exposed to rain or moisture, does not operate normally, or has been dropped.
9. When the mains plug or appliance coupler is used as the disconnect device, it shall remain readily operable.
10. Please keep the unit in a good ventilation environment.
11. **WARNING:** To reduce the risk of fire or electric shock, do not expose this apparatus to rain or moisture.
12. Apparatus shall not be exposed to dripping or splashing and no objects filled with liquids, such as vases, shall be placed on the apparatus.
13. **WARNING:** Battery pack shall not be exposed to excessive heat such as sunshine, fire or the like.



# OVERVIEW

## System Components and Unpacking

The standard configuration of the 975 system includes:



**975**  
Classroom Audio System  
and Power Supply

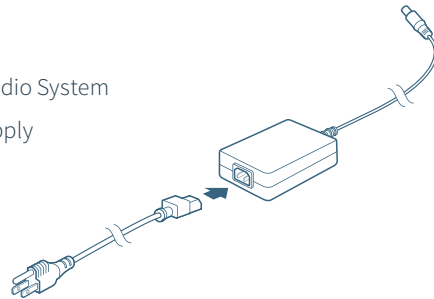

**FMN  
(Flexmike)**  
Teacher  
Microphone



**SMN  
(Sharemike)**  
Student Microphone  
*(Optional)*

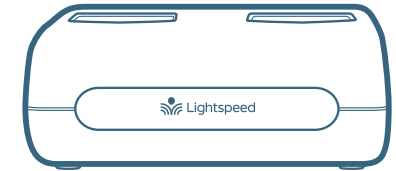

**Microphone Cradle Charger  
and Power Supply**

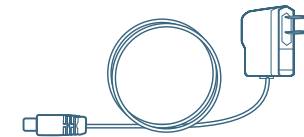

**TIP:** The 975 and wireless microphones are paired together at the factory. Please keep all components together as a system. Moving them from one system or room to another will result in the need to re-pair them to function.



# Optional Speakers

Systems can be configured with a variety of ceiling or wall-mounted speakers, including these Lightspeed models.

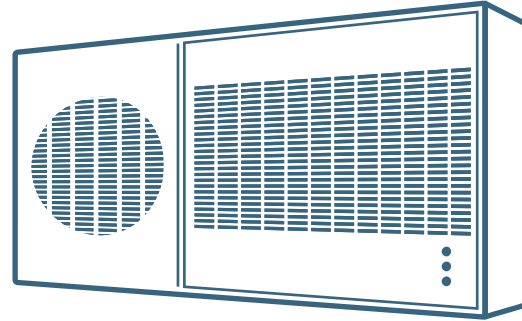

**TCQ** (x 1)  
Hybrid Ceiling Speaker

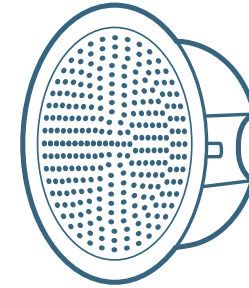

**DRQ** (x 4)  
Ceiling Speaker

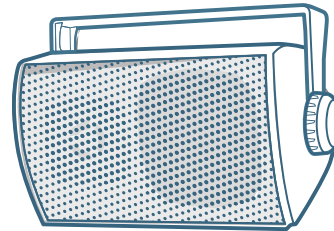

**WMQ** (x 4)  
Wall Speaker  
Available in U.S. and Canada only

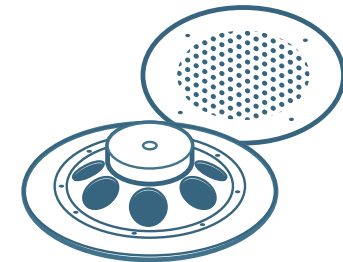

**4JCS** (4 per room)  
Plenum Ceiling Speaker  
Available in U.S. only



# 975 Front Panel Controls and Indicators

1. **POWER LIGHT**  
**White light:** Power on
2. **POWER BUTTON / VOLUME ADJUSTMENT:** Press this button to turn the system power on or off. This also functions as an adjustment knob for the volume and tone depending on the mode selected (see 5,6,7 below).
3. **STATUS LIGHT:** Microphone link and pair indicators.  
**Blue light:** Microphone(s) is paired to the system  
**Off:** Microphones are not paired to the system
4. **IR RECEIVER:** For pairing to microphone.
5. **AUDIO INPUT VOLUME SELECTOR:** Selects Volume as the mode for the adjustment knob (2) for the audio sources connected to the audio inputs on the back of the 975.
6. **AUDIO OUTPUT VOLUME SELECTOR:** Selects Volume as the mode for the adjustment knob (2) for the audio device connected to the audio output jack on the front of the 975.
7. **tone SELECTOR:** Selects Tone as the mode for the adjustment knob (2) for the microphone. This adjusts the bass or treble that is heard through the classroom speaker.
8. **AUDIO OUTPUT JACK:** 3.5mm stereo connector for connecting to an assisted listening device (ALD) or to a computer for recording.

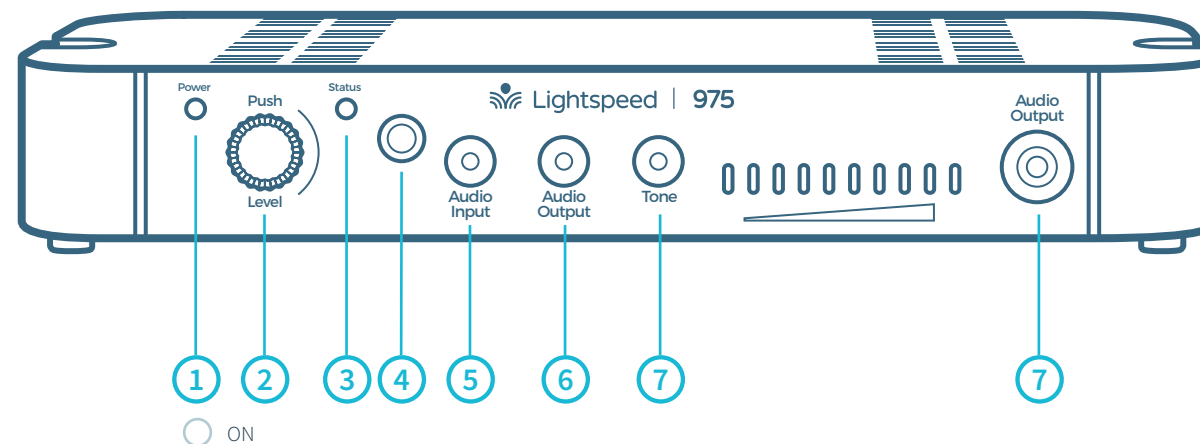



# 975 Back Panel Controls and Connections

1. **AUDIO INPUTS:** 3.5mm stereo connectors for connecting classroom audio sources to be played through audio system. One optical digital input and one input priority. Input priority mutes other audio to allow only input priority.
2. **PAGEFIRST ADJUST:** Use the Adjust control to adjust the sensitivity of PageFirst if needed.
3. **PAGEFIRST INPUT:** Connect the input from the optional PageFirst sensor here when interfacing with a building's paging system.
4. **RELAY INPUT:** Senses external relay closure to mute 975 audio when a signal from a fire alarm, IP paging system or other device is detected.
5. **CONTACT CLOSURE:** Internal relay contact closure to provide signal to notify external system based on user input.
6. **SPEAKER OUTPUTS:** This Euroblock connector is used to connect the 975 to the loudspeaker(s). Up to two 8-ohm speakers can be connected to each output.  
**Note:** *Wiring to these terminals should follow the Class 2 wiring methods as outlined in the National Electric Code.*
7. **DC POWER:** Plug the power supply (24V/2.5A) into this jack.

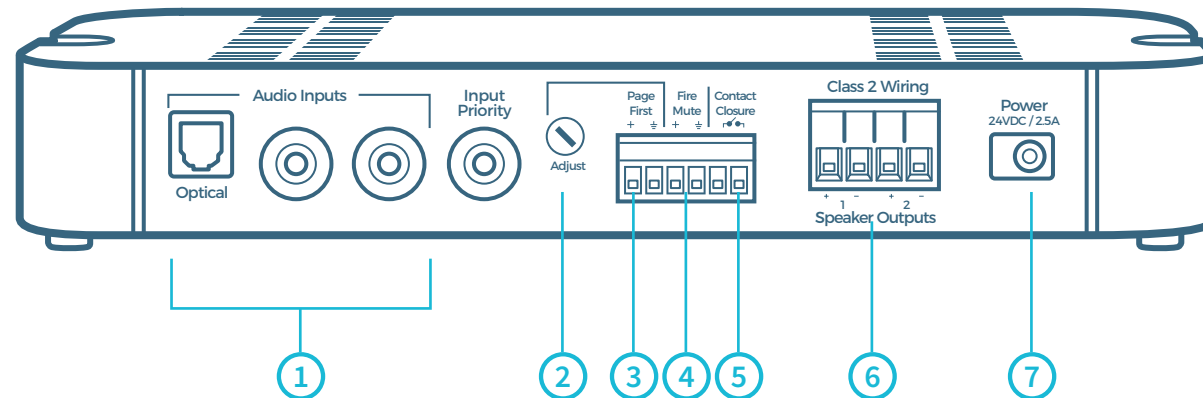



# Flexmike Controls and Connections

- POWER/MUTE SWITCH:** Press and hold to power on, press to mute, press and hold to power off.  
**Blue light:** Talk  
**White light:** Mute
- IR TRANSMITTER:** For pairing to base unit.
- MIC 1 STATUS:** lighted to indicate microphone is registered as MIC 1  
**White: solid** = Normal operation  
**White: flashing** = Linking in progress
- MIC 2 STATUS:** When using a second microphone, this LED is lighted to indicate microphone is registered as MIC 2  
**White: solid** = Normal operation  
**White: flashing** = Linking in progress
- MICROPHONE VOLUME UP/DOWN**
- POWER STATUS LIGHT**  
**Red light:** In operation, turns red to indicate low battery.  
**White light:** Normal operation  
  
When charging in Cradle Charger:  
**Red light:** Charging  
**Green light:** Charging complete
- EARBUD/MIC CONNECTION:** Connect the earbud for monitoring for use with Pods only, also for use with optional EMA (earset) and LMA (lapel) microphones.
- LANYARD INTERFACE:** Insert the lanyard into this hook to wear the Flexmike.
- BATTERY:** Remove the battery to replace the rechargeable battery pack.
- USB INPUT:** Connect audio source to send to 975. USB input can also be used for charging.

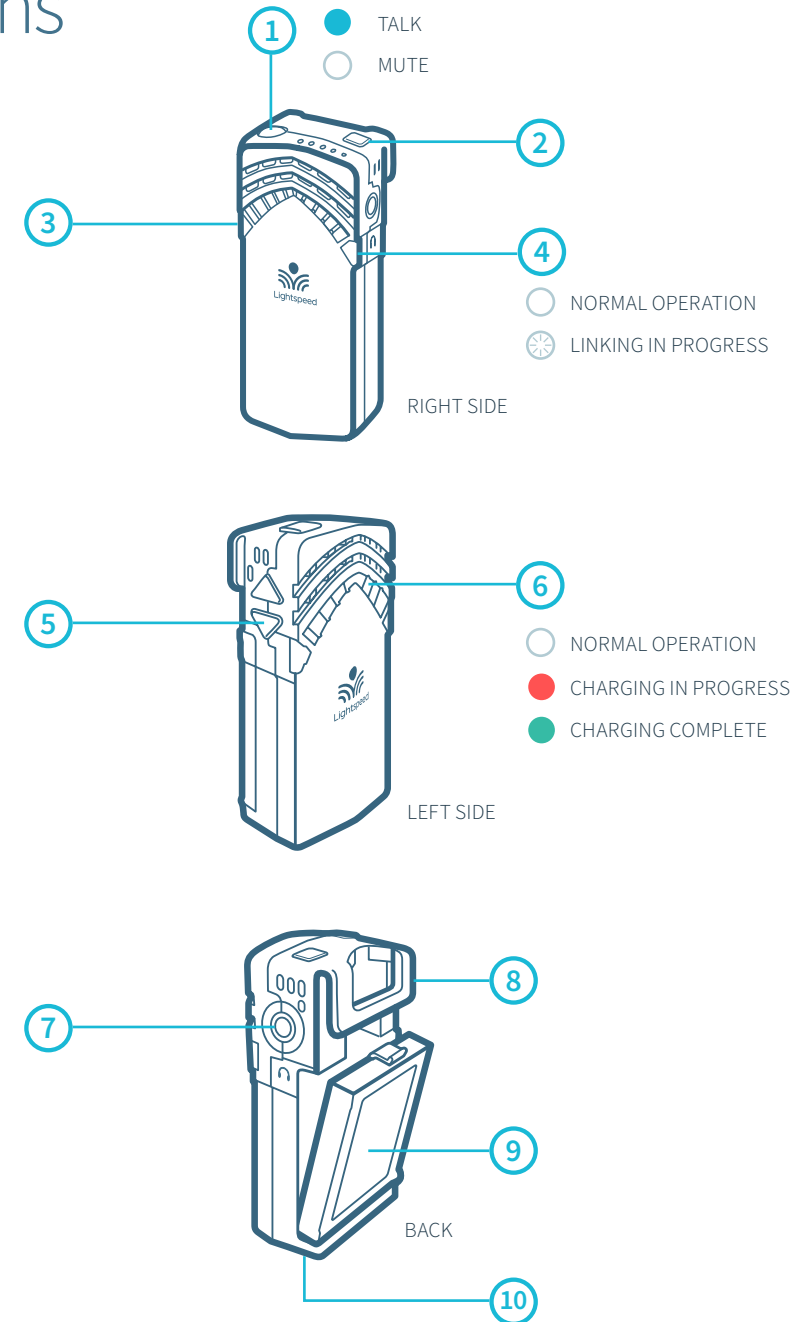





# Microphone Cradle Charger

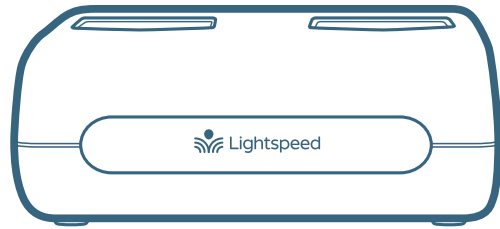

**DC POWER PORT:** Connect the 5V/1.0A DC power cord

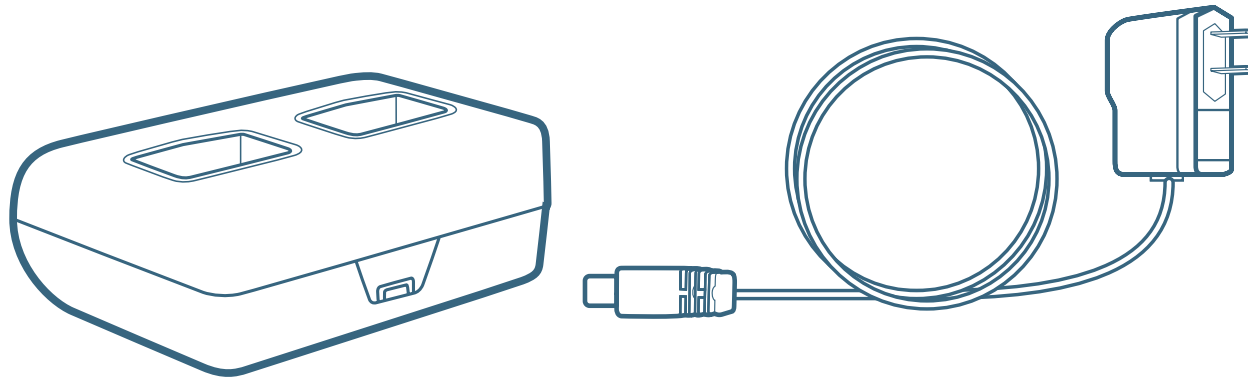



## SET-UP

# Set-Up & Daily Operation

### Operating the Flexmike

Once the Flexmike is charged, follow these steps for use.

1. Remove the Flexmike from the charger and put it on by connecting the magnetic clasps behind your neck. Adjust the lanyard so that the top of the Flexmike aligns with the collarbone.
2. The Flexmike will automatically power on and mute when it is removed from the charger.
3. The microphone volume on the Flexmike is set at the factory to the midpoint. It is adjusted by the up/ down buttons on the side of the mic.
4. While speaking in a normal voice, fine tune the microphone volume. Proper volume level should be as follows:
  - Your voice should be clearly heard by another person on the other side of the room.
  - You should barely be able to hear your own voice.
  - There should not be any audio “feedback” or squealing outside of 2-3 feet (if there is, turn the volume down slightly).

**REMEMBER:** This equipment supplements the user’s voice so they are able to speak in a conversational tone. Having the volume set too high will result in feedback and listener fatigue.

- Once initial volume level is set, walk around the room and listen for overall audio quality.
- If further fine tuning is required, you may need to adjust the Tone Control on the front of the 975.

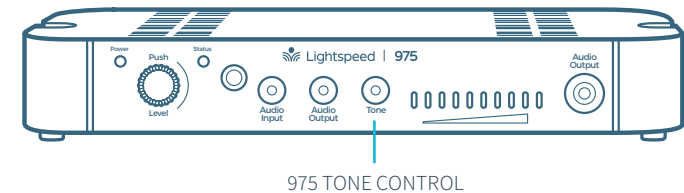
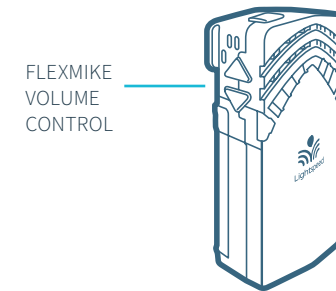
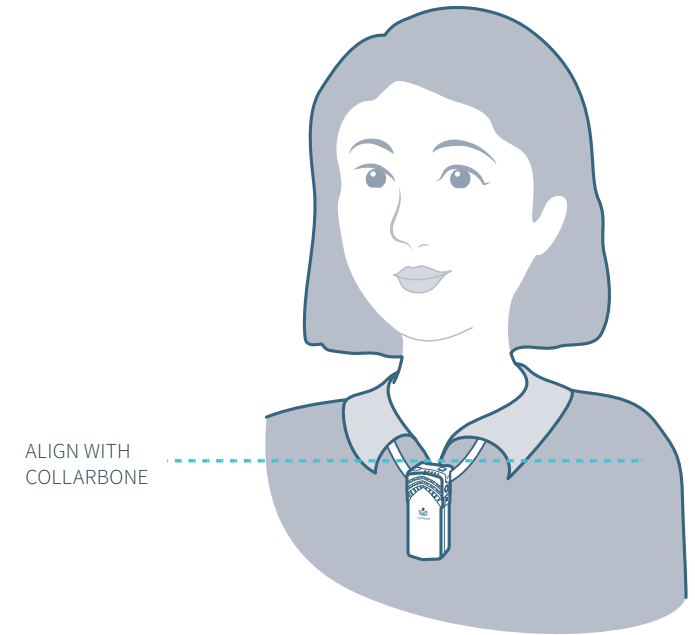



# Charging the Flexmike

## BEFORE USE, THE FLEXMIKE SHOULD BE CHARGED

It will take 5-6 hours for the Flexmike to obtain a full charge. A fully charged Flexmike will last for up to 8 hours of use. If microphones are used daily, they should be charged each night.

Replacement lithium polymer battery packs may only be purchased through Lightspeed Technologies (part # 77-L3.7V). Do not attempt to charge with other battery packs. They can overheat and expand creating a significant hazard and damaging the microphone (this is not covered by warranty).

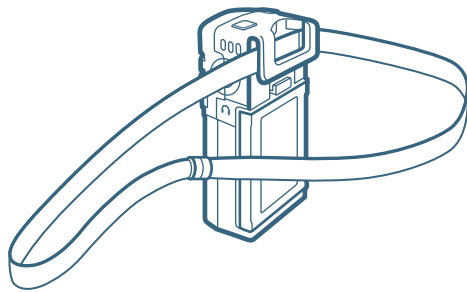

### ATTACH LANYARD

Hang the Flexmike on the lanyard opposite the magnetic clasp.

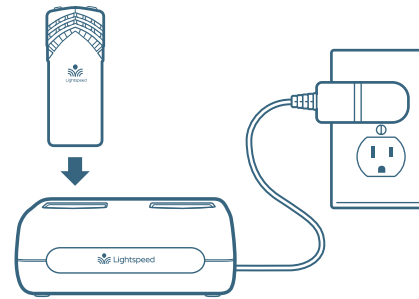

### CONNECT CRADLE CHARGER

Plug power cord into the cradle charger and then plug the AC end into an electrical outlet.

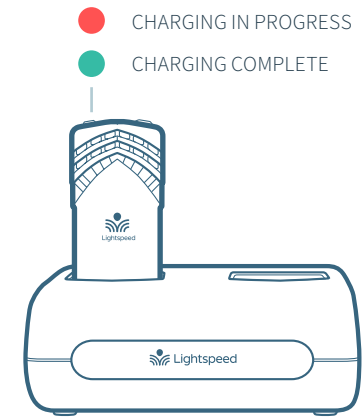

### CHARGE FLEXMIKE

Place the Flexmike into the cradle.

The LED on the Flexmike power light will glow red indicating charging has started.

It takes about 5.5 hours to fully charge the Flexmike battery. When charging is complete, the power status light will glow green.



# Using Flexmike as Wireless Audio Link

Connect your computer into the USB-C jack on the bottom of the Flexmike to enable 2-way audio transmission (NOTE: USB-C cable not included).

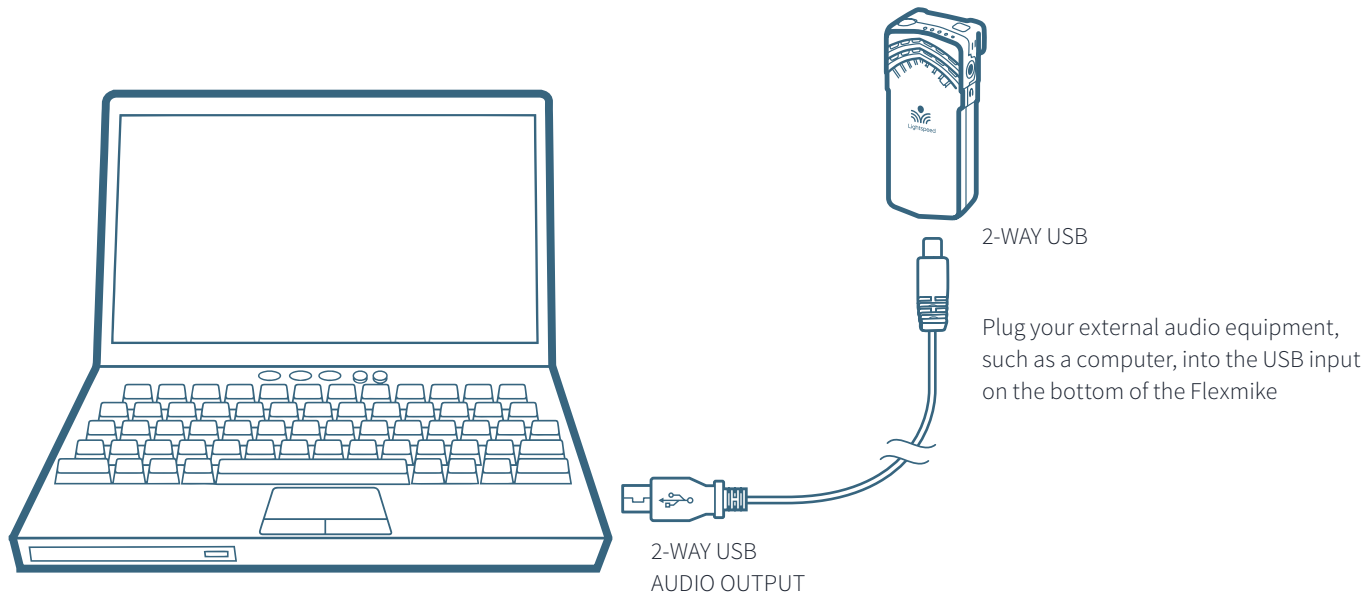

**TIP:** If your system includes two Flexmikes, you can use one mic for instruction and the second mic to transmit audio through the system.



# Output Audio to Personal Assistive Listening Device (ALD)

1. Press the Audio Output Selector first, then turn the **volume control** on the front panel all the way down (fully counterclockwise).
2. Determine the type of **audio input jack** on the ALD as manufacturers' products differ in connector size and shape. Many require a 3.5 mm to 3.5 mm patch cable (part# MSC3535, not included).
3. Connect a patch cable from the **ALD microphone** jack or AUX input to AUDIO OUT jack on the front of the 975.
4. With the 975 and ALD turned on, speak into the Flexmike and slowly adjust the corresponding volume control on the 975 until the appropriate **audio level** is obtained in the ALD.
5. It may be necessary to **adjust the volume on the ALD** to achieve appropriate volume level.

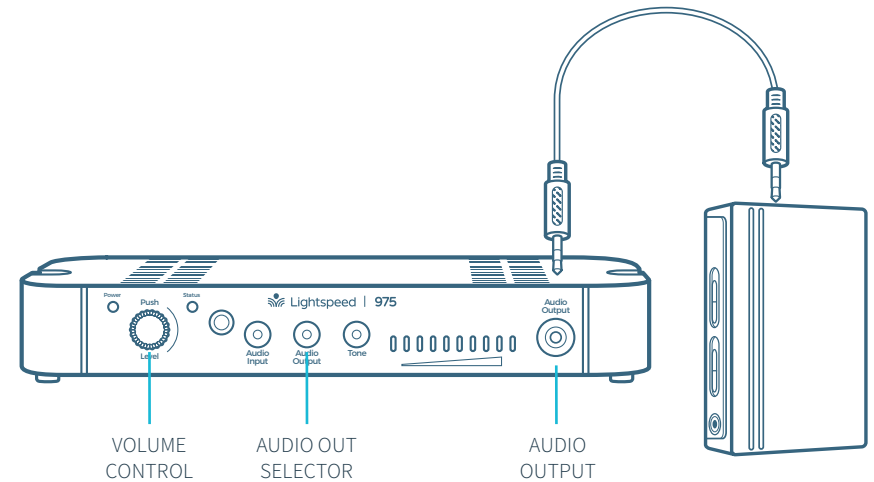



# Audio Integration

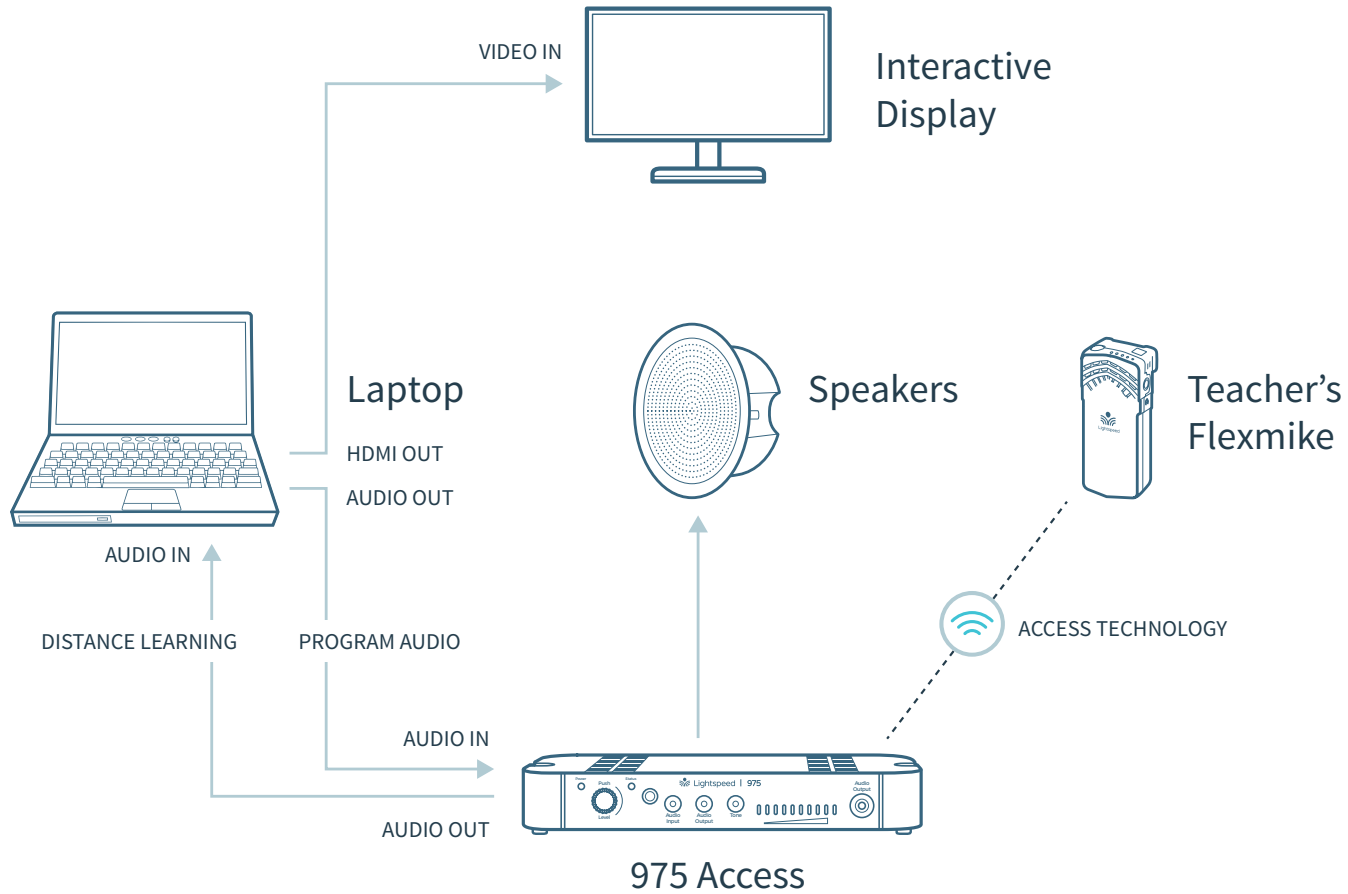



# Daily Operation Instructions

## 1. AT THE START OF THE DAY, REMOVE FLEMIKE FROM THE CHARGER

- The microphone will default to the Mute position, the status light will turn to white.
- Place the microphone around your neck.
- Press the power/mute button. The light will turn blue, indicating the microphone is active and ready to use.
- Adjust volume with the UP/DOWN buttons if necessary.
- If Flexmike needs to be powered down for some time, press and hold the power button. To power Flexmike again, press and hold the power button until the blue light begins to blink.

## 2. PRIVATE CONVERSATIONS

- Mute the Flexmike during private conversations by momentarily pressing the power button. When muted, the blue light turns white.
- When conversation is over, momentarily press the power button again to unmute the Flexmike.

## 3. END OF DAY

- Place the Flexmike into the cradle charger and make sure the Power Supply is plugged in to an electrical outlet.
- The Flexmike will stay powered on during charging, but will automatically be muted.
- It is not necessary to turn off the 975 at end of day, but you may do so by pressing the power button on the front panel.
- If you do want to power it down, when Flexmike is removed from charging the next day, it will automatically power the 975 on.

POWER / MUTE BUTTON  
& STATUS LIGHT



VOLUME CONTROL

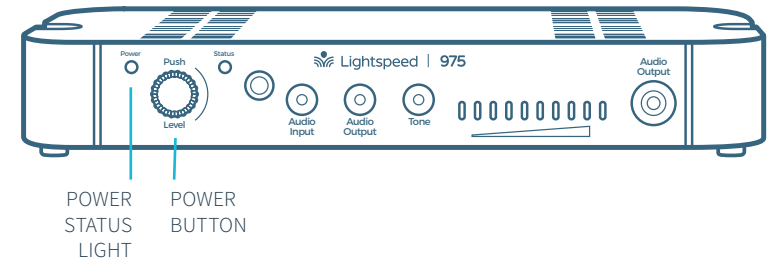
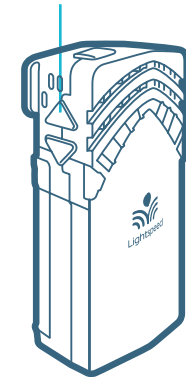



## OPTIONAL ACCESSORIES

# ShareMike Controls and Connections

- POWER BUTTON**
- POWER STATUS LIGHT**  
**Red light:** During operation, turns red to indicate low battery  
**White light:** Normal operation  
  
When charging in Cradle Charger:  
**Red light:** Charging  
**Green light:** Charging complete
- MIC 1 STATUS:** Lighted to indicate microphone is registered as MIC 1  
**White: solid** = Normal operation  
**White: flashing** = Linking in process
- MIC 2 STATUS:** Lighted to indicate microphone is registered as MIC 2  
**White: solid** = Normal operation  
**White: flashing** = Linking in process
- MUTE/TALK STATUS LIGHT**  
**Blue: solid** = Talk  
**White: solid** = Mute
- MICROPHONE VOLUME UP/DOWN**
- USB INPUT:** Connect audio source to send to 975. USB input can also be used for charging.
- IR TRANSMITTER:** For pairing to base unit
- AUDIO INPUT:** Plug a laptop or other audio device into this jack to wirelessly transmit the audio signal to be played through the system.
- VOLUME LOCK:** Disables volume controls.

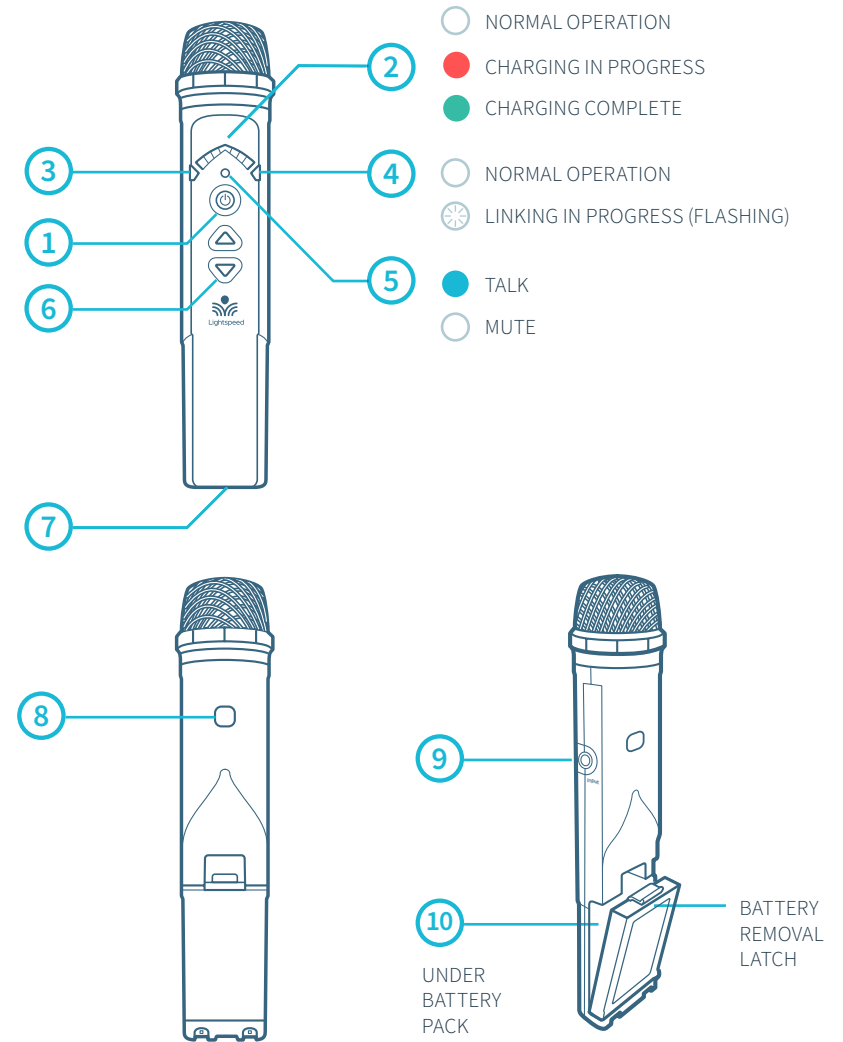





# ShareMike: Charging

1. Make sure the **charger** is plugged into a wall outlet.
2. The **power indicator** will glow red to indicate charging.
3. Leave the ShareMike in the charger **overnight** to obtain a full charge. It takes about 5-6 hours to fully charge the battery. The light will turn green when charging is complete.

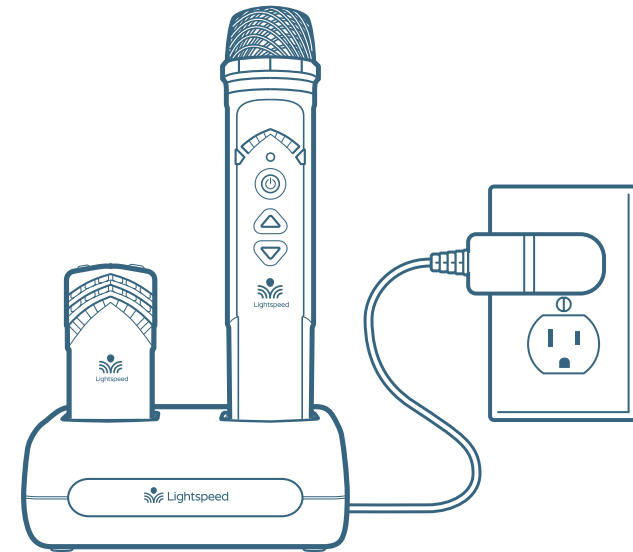
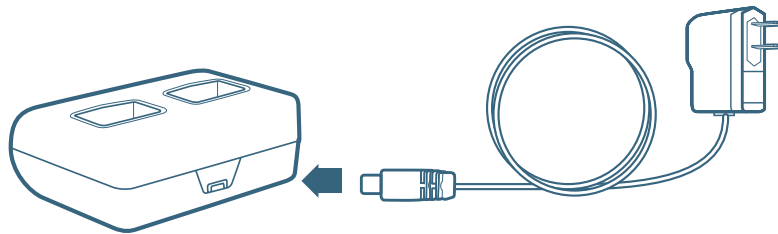

**PLEASE NOTE:** The 975 and microphone(s) are paired together at the factory and all components should be kept together as a system. Moving them from one system, or room, to another will result in the need to re-pair.



# Sharemike: Initial Set-Up

1. Ensure the 975 is on. The blue power light will glow.
2. Turn on the Sharemike by pressing and holding the power button until the LED lights.
3. Grip the barrel in the center section.
4. While speaking in a normal voice, increase the volume with the Sharemike until your voice is barely audible.

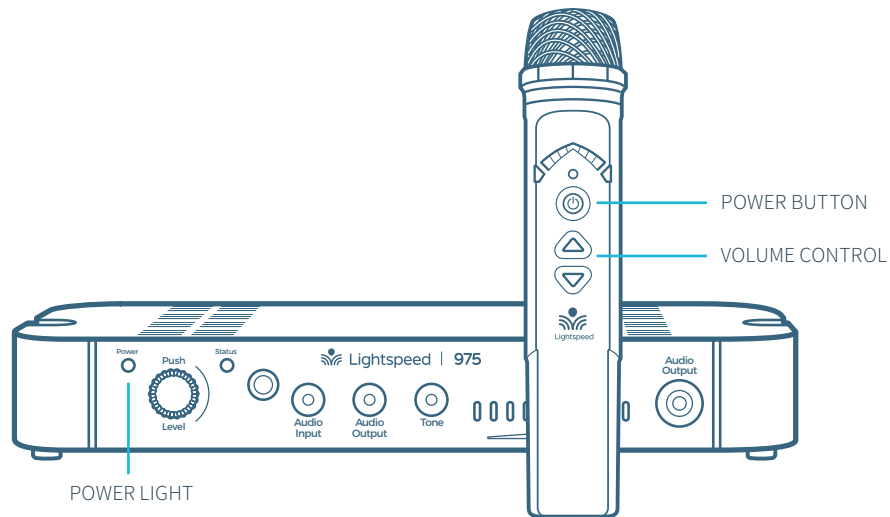

**PLEASE NOTE:** This equipment is designed to supplement and distribute the user's voice so they are able to speak in a conversational tone. Having the volume set too high will result in feedback and listener fatigue.



# Optional PageFirst Kit

This 975 feature interfaces with an independent classroom paging system. When a page is broadcast, all audio from the system is muted, ensuring important school-wide messages are not missed. Please note that PageFirst is not compatible with telephone or IP-based paging systems.

How it works:

1. PageFirst sensor clip is hung around a lead wire attached to the classroom paging speaker.
2. The clip is hard-wired to the amplifier.
3. As a page is broadcast, the sensor clip detects the audio signal through induction and immediately mutes the amplifier.
4. When the page is over, the audio from the amplifier returns to normal volume level.

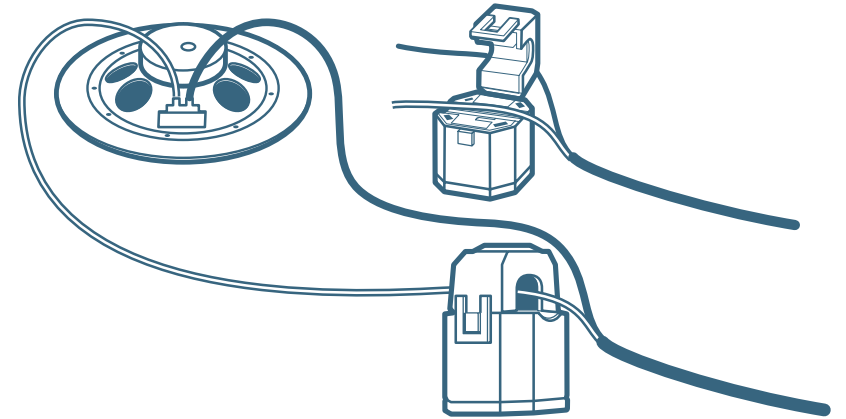



## MAINTENANCE & TROUBLESHOOTING

# Battery Replacement

### Flexmike (Battery part # 77-L3.7V)

1. Push down on the latch and carefully pull the battery pack away from the Flexmike.
2. Insert new battery pack as shown and make sure the latch is secure.
3. Place the Flexmike in a cradle charger to charge the battery pack.

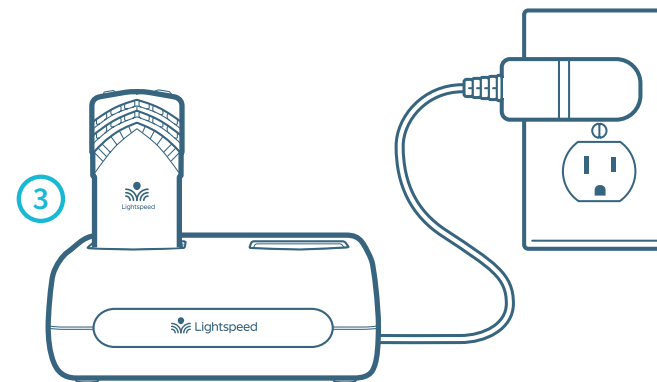
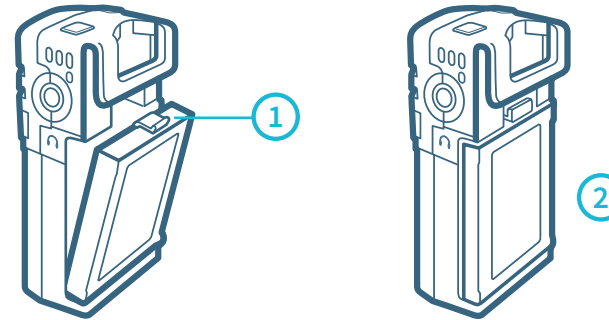



# Battery Replacement CONT'D

## Sharemike (Battery part # 77-L3.7V)

1. Push down on the latch and carefully pull the battery pack away from the Sharemike.
2. Insert new battery pack as shown and make sure the latch is secure.
3. Place the Flexmike in a cradle charger to charge the battery pack.

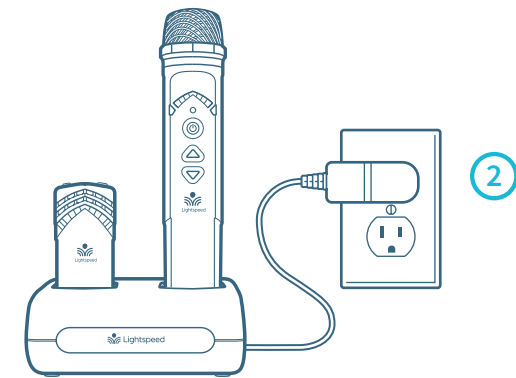
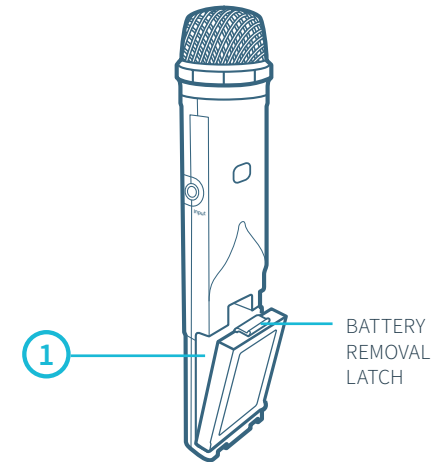

**Please dispose of all batteries properly.** Lightspeed provides battery recycling at no charge. Contact us at 800-732-8999 for details. Available in U.S. only. Customers outside the U.S. should contact their local reseller.



# Troubleshooting

**PROBLEM: Low battery indication:** Most problems are directly related to low battery power. Please run through the “Battery Check” items first. For remaining troubleshooting, use known good, fully-charged batteries.

**SOLUTION:** Battery Check

- Confirm batteries are charged each night. A solid red light on the battery status light indicates a low battery.
- Confirm proper batteries are used: Flexmike and Sharemike require the Lightspeed 77-L3.7V rechargeable battery pack.
- Make sure the microphones obtain a full charge. A full charge takes 5-6 hours.
- When charging the transmitter, the red charging light is solid. The green light will be solid when a full charge is reached.

**PROBLEM: Microphone doesn’t indicate a “Ready” signal (solid green light)**

**SOLUTION:** Follow these steps to ensure the system is ready to use.

- Ensure the power button on the microphone is turned on. Once turned on, the blue light should begin blinking.
- Power the microphone off, then on again after a few seconds. Wait for up to 30 seconds for the blue light to turn solid, indicating READY for operation.

**PROBLEM: Low volume or feedback**

**SOLUTION:** Follow these steps to eliminate low volume or feedback:

- If the volume is too high, feedback will occur. Adjust accordingly.
- Adjust the volume level on the Flexmike.

**PROBLEM: No sound from speaker and wireless components**

**SOLUTION:** Follow these steps to produce sound from 975:

- Confirm that the white POWER light located on the front panel of the 975 is on.
- Confirm the microphone is powered on and linked to the 975. The MIC 1 status light will be green on the 975 indicating the microphone is linked.
- Confirm that the microphone is turned on. There will be a solid blue light on the top of microphone to indicate it is powered on and ready.
- Confirm that microphone is not muted. A solid white light on the top of microphone will indicate it is muted.
- Check speaker connections on the 975. Make sure the cables are properly connected (see page 9 of this manual or the Installation Guide for more information).
- If an Activate Station or Media Connector is paired with the 975, make sure that the volume level of the Activate or the Media Connector is not turned down all the way.
- Slowly turn up the volume level while talking into the microphone.

**If you still have questions after reviewing these instructions, call Lightspeed Technical Services at 800.732.8999, 5am–5pm, PST.**

Customers outside the U.S. should contact their local reseller.



# Tips for Optimum Audio Performance

- **Speak in a natural voice.** A normal conversational speech level will provide an adequate signal. It is not necessary to increase the intensity of your voice—the audio system provides adequate amplification (approximately 5–10 dB) above ambient room noises.
- Avoid **wearing jewelry** that may rub or bump against the microphone.
- **Mute the Flexmike** during private conversations with a student, parent, or other classroom visitor. You can tell the mic is muted when the light turns white.
- **Recharge microphones each night.** When recharged nightly, operating time (actual usage) for the microphones will last through a typical school day.



## WARRANTY, SAFETY & SPECIFICATIONS

### Five-Year Limited Warranty

Lightspeed Classroom Audio Systems are guaranteed against malfunction due to defects in materials and workmanship for a period of five (5) years, beginning at the date of the purchase invoice. If such malfunction occurs, the product will be repaired or replaced (at Lightspeed's option) without charge during the warranty period.

Lightspeed's Warranty Exchange Program applies to all classroom audio systems within the five (5) year warranty period. If a classroom audio product or component has an issue that requires service, a refurbished replacement will immediately be sent to the customer to minimize downtime. Customers will receive the exchange product(s) or component(s) within 2-3 days. A prepaid return label will be included with exchanged products so original malfunctioned equipment can be returned to Lightspeed. Any exchanged equipment will remain covered under the original five-year warranty.

1. Warranty on transceivers is five (5) years.
2. Warranty on Lightspeed NiMH and Lithium Polymer rechargeable batteries is one (1) year.
3. A prepaid shipping label will be provided by Lightspeed for warranty repairs within the United States. Customers outside the U.S. should refer to the Lightspeed website ([www.lightspeed-tek.com](http://www.lightspeed-tek.com)) for warranty repair instructions.
4. Warranty does not extend to finish, appearance items, or malfunctions due to abuse or operation other than specified conditions, nor does it extend to incidental or consequential damages. Repair by other than Lightspeed or its authorized service agencies will void this warranty. Information on authorized service agencies is available from Lightspeed Technologies, Inc.

**Our Service Department (800.732.8999, 5am–5pm, PST) will handle your repair or replacement needs.**

Customers outside the U.S. should contact their local reseller.





# Safety Warnings and Certifications



**CAUTION**

**RISK OF ELECTRICAL SHOCK**

**DO NOT OPEN**



**THIS PRODUCT MUST BE INSTALLED IN ACCORDANCE WITH THE APPLICABLE INSTALLATION CODE BY A PERSON FAMILIAR WITH THE CONSTRUCTION AND OPERATION OF THE PRODUCT AND THE HAZARDS INVOLVED.**



The lightning flash with arrowhead symbol inside an equilateral triangle is intended to alert the user to the presence of non insulated “hazardous voltage” within the product’s enclosure, which may be of sufficient magnitude to induce a risk of electric shock to persons.



The exclamation mark inside an equilateral triangle is intended to alert the user to the presence of important operating and maintenance (servicing) instruction in the literature accompanying this product.



**USE A LIGHTSPEED SUPPLIED BATTERY ONLY**

## CERTIFICATIONS



This product is listed to UL standards and requirements for electrical safety by Underwriters Laboratories Inc.



This product conforms with the essential requirements of the following European Union Directives: 2004/108/EC Electromagnetic Compatibility (EMC) and 2006/95/EC Low Voltage Directive (LVD).



LightSpeed Technologies launched a formal product recycle program in Europe that complies with the European Union Directive 2002/96/EC on Waste Electrical and Electronic Equipment (“WEEE Directive”). Please visit [www.light-speed-tek.com](http://www.light-speed-tek.com) for more information.



This product is manufactured using lead-free processes and is free of other materials harmful to the environment. It conforms to the most stringent new European guidelines for consumer products (RoHS).



# Précautions de Sécurité et Certifications



**ATTENTION**  
**RISQUE D'ÉLECTROCUTION**  
**NE PAS OUVRIR**



CONFORMÉMENT AUX NORMES D'INSTALLATION APPLICABLES, CE PRODUIT DOIT ÊTRE INSTALLÉ PAR UNE PERSONNE FAMILIARISÉE AVEC LA CONCEPTION ET LE FONCTIONNEMENT DU PRODUIT ET CONSCIENTE DES RISQUE ENCOURUS.



L'éclair flèche dans un triangle équilatéral avertit l'utilisateur de la présence d'une "tension dangereuse" non isolée à l'intérieur de l'appareil, qui peut être d'une ampleur suffisante pour constituer un risque d'électrocution.



Le point d'exclamation contenu dans un triangle équilatéral avertit l'utilisateur de la présence d'importantes instructions d'exploitation et de maintenance dans la documentation qui accompagne ce produit.



**UTILISEZ UNIQUEMENT LA BATTERIE LIGHTSPEED FOURNIE**

## CERTIFICATIONS



Ce produit est certifié conforme aux normes et aux exigences UL en matière de sécurité électrique par Underwriters Laboratories Inc.



Ce produit est conforme aux principales exigences des directives de l'Union Européenne suivantes : 2004/108/EC Electromagnetic Compatibility (EMC) and 2006/95/EC Low Voltage Directive (LVD).



LightSpeed Technologies a lancé un programme de recyclage de produits en Europe conformément à la directive de l'Union Européenne 2002/96/CE relative aux déchets d'équipements électriques et électroniques (directive « DEEE »). Veuillez visiter notre page Web [www.Lightspeed-tek.com](http://www.Lightspeed-tek.com) pour plus de renseignements.



Ce produit est fabriqué en utilisant des processus sans plomb ni aucune autre matière nuisible à l'environnement. Il est conforme aux nouvelles règles européennes les plus strictes en matière de biens de consommation (RoHS).



#### FCC warning

##### Federal Communications Commission Statement

This device complies with FCC Rules Part 15. Operation is subject to the following two conditions:

- This device may not cause harmful interference.
- This device must accept any interference received, including interference that may cause undesired operation.

This equipment has been tested and found to comply with the limits for a class B digital device, pursuant to Part 15 of the Federal Communications Commission (FCC) rules. These limits are designed to provide reasonable protection against harmful interference in a residential installation. This equipment generates, uses, and can radiate radio frequency energy and, if not installed and used in accordance with the instructions, may cause harmful interference to radio communications. However, there is no guarantee that interference will not occur in a particular installation. If this equipment causes harmful interference to radio or television reception, which can be determined by turning the equipment off and on, the user is encouraged to try to correct the interference by doing one or more of the following measures:

- Reorient or relocate the receiving antenna.
- Increase the separation between the equipment and receiver.
- Connect the equipment into an outlet on a circuit different from that to which the receiver is connected.
- Consult the dealer or an experienced radio/TV technician for help.

#### FCC Caution

Any changes or modifications not expressly approved by the party responsible for compliance could void the user's authority to operate the equipment.

The antenna(s) used for this transmitter must not be co-located or operating in conjunction with any other antenna or transmitter.

#### Radiation Exposure Statement:

For the Device SM-DL and FM-DL

This equipment complies with FCC radiation exposure limits set forth for an uncontrolled environment. End users must follow the specific operating instructions for satisfying RF exposure compliance. To maintain compliance with FCC exposure compliance requirement, please follow operation instruction as documented in this manual.

For the Device 975-DL

This equipment must be installed and operated in accordance with provided instructions and the antenna(s) used for this transmitter must be installed to provide a separation distance of at least 20 cm from all persons and must not be co-located or operating in conjunction with any other antenna or transmitter.



## IC warning

Canada, Industry Canada (IC) Notices

This device complies with Industry Canada licenseexempt RSS standard(s).

This Class B digital apparatus complies with Canadian ICES-003 and CAN ICES-3(B)/NMB-3(B).

Operation is subject to the following two conditions:

This device may not cause interference, and (2) this device must accept any interference, including interference that may cause undesired operation of the device. The IC ID for these device as below:

FM-DL is IC: 1732B-LSFMN, SM-DL is IC: 1732B-LSSMN and 975-DL is IC ID: 1732B-LS975.

Canada, avis d'Industrie Canada (IC)

Cet appareil est conforme aux normes RSS exemptes de licence d'Industrie Canada.

Cet appareil numérique de classe B est conforme aux normes canadiennes ICES-003 et CAN ICES-3 (B) / NMB-3 (B). Son fonctionnement est soumis aux deux conditions suivantes:

Cet appareil ne doit pas causer d'interférences, et (2) cet appareil doit accepter toute interférence, y compris les interférences qui peuvent provoquer un fonctionnement indésirable de l'appareil. L'ID IC pour ces appareils comme ci-dessous:

FM-DL est IC: 1732B-LSFMN, SM-DL est IC: 1732B-LSSMN et 975-DL est IC ID: 1732B-LS975.

Radiation Exposure Statement:

Pour l'appareil SM-DL et FM-DL

Cet équipement est conforme aux limites d'exposition aux rayonnements FCC définies pour un environnement non contrôlé. Les utilisateurs finaux doivent suivre les instructions d'utilisation spécifiques pour se conformer à l'exposition RF. Pour maintenir la conformité avec les exigences de conformité d'exposition FCC, veuillez suivre les instructions de fonctionnement décrites dans ce manuel.

Pour l'appareil 975-DL

Cet équipement doit être installé et utilisé conformément aux instructions fournies et l'antenne (s) utilisée (s) pour cet émetteur doit être installée de manière à fournir une distance de séparation d'au moins 20 cm de toutes les personnes et ne doit pas être colocalisée ou fonctionner conjointement avec toute autre antenne ou émetteur.



# EU Declaration Of Conformity



## EU Declaration of Conformity According to EU Directives EMC 2014/30/EU, LVD 2014/35/EU, RED 2014/53/EU

**Manufacturer:** Lightspeed Technologies, Inc.

**Address:** 11509 SW Herman Rd,  
Tualatin, Oregon 97062

*We herewith declare that the following systems comply with the appropriate basic safety and health requirements of the Directive based on its design and type, as brought into circulation by us. In case of alteration of the system, not agreed upon by us, this declaration will lose its validity.*

**Products:** Redcat Access, Flexmike, Flexcat Pod, Flexcat Charging Station, Flexcat Handheld Remote Control, Media Connector Access, Sharemike, Topcat, Access Link, 955 Access, Activate Station, Activate Pod, TCQ2, DRQ, Mobile Connector

**Model Numbers:** LSRCA 1881, LSFM 1881, FCP 1881, FCCS, FCHRCB, LSMCA 1881, LSSM 1881, LSTCA 1881, LSAL 1881, LS955 1881, LSACT 1881, LSPOD 1881, TCQ2, DRQ, MCX

As applicable, products conform to the following EU/AS/NZ test standards listed below:

**Safety Standards:** IEC/EN 60065 and amendments

**EMC/RF Standards:** EN301 406 V2.1.1 (2009-07)  
EN 301489-1/-6  
EN 301489-1/-17  
EN 50371 (2002)  
EN 50385 (2002)  
EN 300 328  
EN 55022  
EN 55024  
AS/NZ CISPER 22  
AS/NZ 4268

The Technical Construction File is available to proper authorities and the product is CE marked.

Lightspeed Representative:

Michael Frost, Compliance Engineer

Date: December 12, 2018

P/N: 083-0013-07

LIGHTSPEED TECHNOLOGIES / 11509 SW HERMAN ROAD / TUALATIN, OR 97062 / 800.732.8999 / WWW.LIGHTSPEED-TEK.COM



# SYSTEM COMPONENTS

## STANDARD COMPONENTS

<b>975</b>	Wireless audio base station
<b>24V-2.5A-NA</b>	24V/2.5A power supply for 975
<b>FSCC</b>	Transceiver cradle charger, power supply
<b>5V1C</b>	5V power supply for FSCC
<b>FMN</b>	Flexmike classroom transceiver with battery pack and lanyard
<b>77-L3.7V</b>	Lithium Polymer rechargeable battery pack for Flexmike, one per Flexmike
<b>FL</b>	Flexmike lavalier cord
<b>SPEAKERS</b>	As ordered

## STANDARD COMPONENTS (outside U.S. and Canada)

<b>975-1881</b>	Wireless audio base station
<b>24V-2.5A</b>	24V/2.5A power supply for 975, specify country
<b>FSCC -INT</b>	Transceiver cradle charger, power supply
<b>5V1C -INT</b>	International 5V power supply for FSCC
<b>FMN -1881</b>	Flexmike classroom transceiver with battery pack and lanyard
<b>77-L3.7V</b>	Lithium Polymer rechargeable battery pack for Flexmike, one per Flexmike
<b>FL</b>	Flexmike lavalier cord
<b>SPEAKERS</b>	As ordered

## OPTIONAL ACCESSORIES

<b>SMN</b>	Sharemike handheld transceiver with battery pack
<b>77-L3.7V</b>	Lithium Polymer rechargeable battery pack for Sharemike
<b>USB C XX</b>	Charging cable for Sharemike
<b>EMA</b>	Earset microphone with TRRS connector for Flexmike
<b>LMA</b>	Lapel microphone with TRRS connector for Flexmike



# SYSTEM SPECIFICATIONS

## 975

<b>Description</b>	Wireless audio hub
<b>Frequency response</b>	60 Hz - 7 kHz
<b>DC power input</b>	24V/2.5A
<b>Power output</b>	40 Watts total (20 W/channel)
<b>Total harmonic distortion</b>	<1% @ 10W
<b>Wireless communication</b>	Access Technology (1.9 GHz)
<b>Tone control</b>	1 bass/treble control
<b>Audio inputs</b>	Three (3) 3.5mm stereo w/ volume control, one optical
<b>Audio output</b>	3.5mm stereo w/ volume control
<b>PageFirst input</b>	Euroblock
<b>Audio Link indicators</b>	2 indicators for Flexmike 1 and 2
<b>Device registration</b>	Push button for pod(s), Flexmike(s), Sharemike, Media Connector, and remote(s)
<b>Dimensions (W x H x D)</b>	7.6" x 5" x 1.13" (193 x 127 x 29mm)
<b>Weight</b>	9.6 oz. (272g)

## FMN

<b>Description</b>	Pendant-style transceiver
<b>Earbud lanyard</b>	Magnetic clasp with integrated earbud
<b>Wireless communication</b>	Access Technology (1.9 GHz)
<b>Audio distortion</b>	<1%
<b>Integrated microphone</b>	Uni-directional electric
<b>Earbud output</b>	3.5mm
<b>Audio input</b>	3.5mm
<b>Volume control</b>	+/- 6 dB
<b>Battery power</b>	LiPo battery pack
<b>Battery life</b>	8 hours (fully charged)
<b>Charging</b>	2 contacts for cradle charging
<b>USB connection</b>	Type C for charging and audio

<b>Power</b>	On/off switch
<b>Registration</b>	Push button for registration with 975
<b>Dimensions (L x W x H)</b>	2.9" x 1.1" x 1.0" (74 x 28 x 25mm)
<b>Weight</b>	1.8 oz (51g)

## SMN

<b>Description</b>	Handheld transceiver
<b>Wireless communication</b>	Access Technology (1.9 GHz)
<b>Audio distortion</b>	<1%
<b>Integrated microphone</b>	Uni-directional dynamic
<b>Audio input</b>	3.5mm
<b>Battery power</b>	LiPo battery pack
<b>Battery life</b>	8 hours (fully charged)
<b>Charging</b>	2 contacts for cradle charging
<b>Power</b>	On/off button
<b>Registration</b>	Push button for registration with 975
<b>Dimensions (L x W x H)</b>	2.25" x 2.25" x 8.75" (57.2 x 57.2 x 222.3mm)
<b>Weight</b>	7.36 oz (209g)

## MEDIA CONNECTOR

<b>Description</b>	Wireless audio transceiver
<b>USB Power</b>	5V type C USB connector
<b>Wireless communication</b>	Access Technology Access Technology (1.9 GHz)
<b>Tone control</b>	1 bass/treble control
<b>Audio input</b>	3.5mm stereo (x4) w/ master volume
<b>Audio output</b>	3.5mm stereo (X2) mixed w/ volume control
<b>Audio Link indicator</b>	1 LED on front panel
<b>Registration indicator</b>	1 LED on back panel
<b>Device registration</b>	Push button for 975
<b>Dimensions (W x H x D)</b>	7.6" x 5" x 1.13" (193 x 127 x 29mm)
<b>Weight</b>	9.6 oz. (272g)



## Dedicated to Access for All

We strive to make a remarkable difference for teachers and students by creating Access to powerful in-the-moment insights to the learning process. Our audio and video solutions improve student engagement, enable teachers to activate small groups, and encourage collaboration.

11509 SW Herman Road  
Tualatin, Oregon 97062  
Toll Free: 800.732.8999  
Phone: 503.684.5538  
Fax: 503.684.3197  
[lightspeed-tek.com](http://lightspeed-tek.com)